



EMC TEST REPORT

Applicant Xiaomi Communications Co., Ltd.
FCC ID 2AFZZC3KH
Product Mobile Phone
Brand Redmi
Model M1908C3KH
Report No. R1907A0380-E1
Issue Date August 20, 2019

TA Technology (Shanghai) Co., Ltd. tested the above equipment in accordance with the requirements in **FCC Code CFR47 Part15B (2018)/ ANSI C63.4 (2014)**. The test results show that the equipment tested is capable of demonstrating compliance with the requirements as documented in this report.

Wei Liu

Guangchang Fan

Performed by: Wei Liu/ Manager

Approved by: Guangchang Fan/ Director

TA Technology (Shanghai) Co., Ltd.

No.145, Jintang Rd, Tangzhen Industry Park, Pudong Shanghai, China

TEL: +86-021-50791141/2/3

FAX: +86-021-50791141/2/3-8000



Table of Contents

1	Test Laboratory.....	4
1.1	Notes of the Test Report.....	4
1.2	Test facility.....	4
1.3	Testing Location.....	5
2	General Description of Equipment under Test.....	6
2.1	Client Information.....	6
2.2	General information.....	6
2.3	Applied Standards.....	8
2.4	Test Mode.....	9
3	Test Case Results.....	10
3.1	Radiated Emission.....	10
3.2	Conducted Emission.....	16
4	Main Test Instrument.....	20



Summary of measurement results

Number	Test Case	Clause in FCC Rules	Conclusion
1	Radiated Emission	FCC Part15.109, ANSI C63.4-2014	PASS
2	Conducted Emission	FCC Part15.107, ANSI C63.4-2014	PASS
Test Date: July 22, 2019~ August 12, 2019			

1 Test Laboratory

1.1 Notes of the Test Report

This report shall not be reproduced in full or partial, without the written approval of **TA technology (shanghai) co., Ltd.** The results documented in this report apply only to the tested sample, under the conditions and modes of operation as described herein .Measurement Uncertainties were not taken into account and are published for informational purposes only. This report is written to support regulatory compliance of the applicable standards stated above.

1.2 Test facility

FCC (Designation number: CN1179, Test Firm Registration Number: 446626)

TA Technology (Shanghai) Co., Ltd. has been listed on the US Federal Communications Commission list of test facilities recognized to perform electromagnetic emissions measurements.

IC (recognition number is 8510A)

TA Technology (Shanghai) Co., Ltd. has been listed by industry Canada to perform electromagnetic emission measurement.

VCCI (recognition number is C-4595, T-2154, R-4113, G-10766)

TA Technology (Shanghai) Co., Ltd. has been listed by industry Japan to perform electromagnetic emission measurement.

A2LA (Certificate Number: 3857.01)

TA Technology (Shanghai) Co., Ltd. has been listed by American Association for Laboratory Accreditation to perform electromagnetic emission measurement.



1.3 Testing Location

Company: TA Technology (Shanghai) Co., Ltd.
Address: No.145, Jintang Rd, Tangzhen Industry Park, Pudong Shanghai, China
City: Shanghai
Post code: 201201
Country: P. R. China
Contact: Xu Kai
Telephone: +86-021-50791141/2/3
Fax: +86-021-50791141/2/3-8000
Website: <http://www.ta-shanghai.com>
E-mail: xukai@ta-shanghai.com

2 General Description of Equipment under Test

2.1 Client Information

Applicant	Xiaomi Communications Co., Ltd.
Applicant address	The Rainbow City of China Resources,NO.68,Qinghe Middle Street,Haidian District,Beijing,China
Manufacturer	Xiaomi Communications Co., Ltd.
Manufacturer address	The Rainbow City of China Resources,NO.68,Qinghe Middle Street,Haidian District,Beijing,China

2.2 General information

EUT Description			
Device Type:	Portable Device		
Model:	M1908C3KH		
IMEI:	IMEI 1:867195040008872 IMEI 2: 867195040008880		
HW Version:	P2		
SW Version:	MIUI 10		
Antenna Type:	PIFA Antenna		
Frequency:	Band	Tx (MHz)	Rx (MHz)
	GSM 850	824 ~ 849	869 ~ 894
	GSM 1900	1850 ~ 1910	1930 ~ 1990
	WCDMA Band II	1850 ~ 1910	1930 ~ 1990
	WCDMA Band IV	1710 ~ 1755	2110 ~ 2155
	WCDMA Band V	824 ~ 849	869 ~ 894
	LTE Band 2	1850 ~ 1910	1930 ~ 1990
	LTE Band 4	1710 ~ 1755	2110 ~ 2155
	LTE Band 5	824 ~ 849	869 ~ 894
	LTE Band 7	2500 ~ 2570	2620 ~ 2690
	LTE Band 38	2570 ~ 2620	2570 ~ 2620
	Bluetooth:	2402 ~ 2480	2402 ~ 2480
	WIFI 2.4G:	2412 ~ 2462	2412 ~ 2462
Modulation:	GSM: GMSK GPRS: GMSK EGPRS: GMSK/8PSK WCDMA RMC: QPSK		



	HSDPA: QPSK HSUPA: QPSK DC-HSDPA:64QAM LTE: QPSK / 16QAM/ 64QAM Bluetooth: GFSK, π /4-DQPSK, 8-DPSK Bluetooth v4.2 LE: GFSK WLAN 802.11b: DSSS WLAN 802.11g/n: OFDM
EUT Accessory	
Adapter	Manufacturer: Jiangsu Chenyang Electron Co., Ltd. Model: MDY-09-EQ
Battery	Manufacturer: Sunwoda Electronic Co.,LTD Model: BN51
USB Cable 1	Manufacturer: LUXSHARE Precision Industry Co., Ltd. Model: L23312 100cm Cable, Shielded
USB Cable 2	Manufacturer: SU ZHOU KELI SCIENCE&TECHNOLOGY DEVELOPMENT CO.,LTD Model: K23312 100cm Cable, Shielded
Auxiliary test equipment	
PC	PC Manufacturer: Microsoft Corporation Model: L20170076
Note: The information of the EUT is declared by the manufacturer.	

Item	Configure 1	Configure 2
Software	The same	The same
Hardware	The same	The same
Flash	2+16	2+32
Other	The same	The same
Note: Customer declaration, two configures is the same, except for flash. There are more than one Configure, each one should be applied throughout the compliance test respectively, however, only the worst case (Configure 2) will be recorded in this report.		



2.3 Applied Standards

According to the specifications of the manufacturer, it must comply with the requirements of the following standards:

Test standards

FCC Code CFR47 Part15B (2018)

ANSI C63.4 (2014)

2.4 Test Mode

Test Mode for RE	
Mode 1:	USB Copy(EUT with PC) + USB cable + earphone + rear camera On + MP3 +Idle
Mode 2:	USB Copy(EUT with PC) + USB cable + earphone +front camera On + MP3 +Idle
Mode 3:	Adapter +USB cable+ earphone + front camera On +Idle
Mode4:	Adapter +USB cable + earphone + rear camera On +Idle
Mode 5:	Adapter + USB cable+ earphone + Mp3 +Idle
Mode 6:	Adapter + USB cable+ earphone +play video+ Idle
Mode 7:	Adapter + USB cable + earphone + FM(98MHz)
Mode 8:	Front camera On +earphone + Idle
Mode 9:	Rear camera On + earphone + Idle
Mode 10:	Earphone+MP3+Idle
Mode 11:	Earphone +Play video+ Idle

During the test, the preliminary test was performed in all modes with all adapters, USB and batteries, mode 1 with USB cable 2 is selected as the worst condition. The test data of the worst-case condition was recorded in this report.

Test Mode for CE	
Mode 1:	USB Copy(EUT with PC) + USB cable + earphone + rear camera On + MP3 +Idle
Mode 2:	USB Copy(EUT with PC) + USB cable + earphone +front camera On + MP3 +Idle
Mode 3:	Adapter +USB cable+ earphone + front camera On +Idle
Mode4:	Adapter +USB cable + earphone + rear camera On +Idle
Mode 5:	Adapter + USB cable+ earphone + Mp3 +Idle
Mode 6:	Adapter + USB cable+ earphone +play video+ Idle
Mode 7:	Adapter + USB cable + earphone + FM(98MHz)

During the test, the preliminary test was performed in all modes with all adapters, USB and batteries, mode 1 with USB cable 2 is selected as the worst condition. The test data of the worst-case condition was recorded in this report.

3 Test Case Results

3.1 Radiated Emission

Ambient condition

Temperature	Relative humidity	Pressure
24°C~26°C	45%~50%	102.5kPa

Methods of Measurement

The EUT is placed on a non-metallic table 0.8m above the horizontal metal reference ground plane. The distance between EUT and receive antenna should be 3 meters. During the test, the EUT was operating in its typical mode. The test method is according to ANSI C63.4-2014. Sweep the whole frequency band through the range from 30MHz to the 5th harmonic of the carrier. During the test, the height of receive antenna shall be moved from 1 to 4 meters, and the antenna shall be performed under horizontal and vertical polarization. The turn table shall be rotated from 0 to 360 degrees for detecting the maximum of radiated signal level.

The data of cable loss and antenna factor has been calibrated in full testing frequency range before the testing. During the test, the EUT is worked at maximum output power.

Set the spectrum analyzer in the following:

Below 1GHz:

RBW=100 kHz / VBW=300 kHz / Sweep=AUTO

Above 1GHz:

(a) PEAK: RBW=1MHz / VBW=3MHz / Sweep=AUTO

(b) AVERAGE: RBW=1MHz / VBW=3MHz / Sweep=AUTO

The radiated emission was measured in the following position: EUT stand-up position (Z axis), lie-down position (X, Y axis). The worst emission was found in lie-down position (X axis) and the worst case was recorded.

During the test, EUT is connected to a laptop via a USB cable in the case of Transfer Data mode. The EUT is used as the peripheral equipment of the PC. The data is transferred from EUT to PC.

Test Setup

Below 1GHz

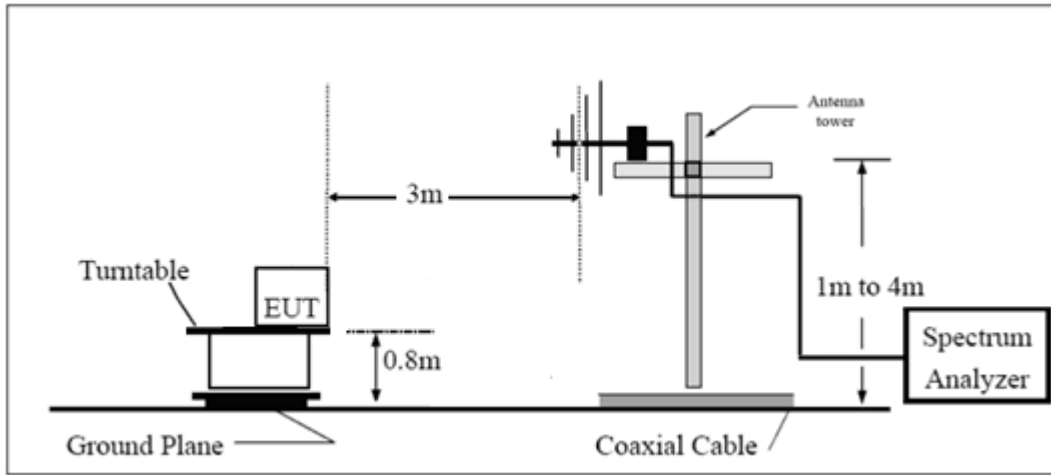

Above 1GHz

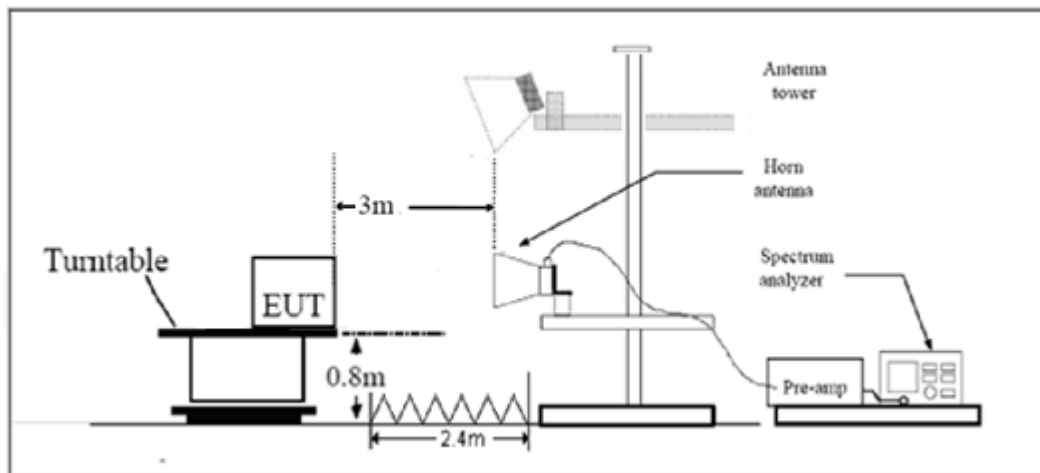

Note: Area side:2.4mX3.6m

Antenna Tower meets ANSI C63.4 requirements for measurements above 1 GHz by keeping the antenna aimed at the EUT during the antenna's ascent/ descent along the antenna mast.

Limits

Frequency (MHz)	Field Strength (dB μ V/m)	Detector
30 -88	40.0	Quasi-peak
88-216	43.5	Quasi-peak
216 – 960	46.0	Quasi-peak
960-1000	54.0	Quasi-peak
1000-5 th harmonic of the highest frequency or 40GHz, which is lower	54 74	Average Peak

Measurement Uncertainty

The assessed measurement uncertainty to ensure 95% confidence level for the normal distribution is with the coverage factor $k = 1.96$.

Frequency	Uncertainty
30MHz~200MHz	4.02 dB
200MHz~1000MHz	3.28 dB
1GHz~18GHz	3.70 dB
18GHz~26.5GHz	5.78 dB
26.5GHz~40GHz	5.82 dB

Test Results

Sweep the whole frequency band through the range from 30MHz to the 5th harmonic of the carrier, the Emissions in the frequency band 18GHz- 40GHz is more than 20dB below the limit are not reported.

The following graphs display the maximum values of horizontal and vertical by software. For above 1GHz, Blue trace uses the peak detection, Green trace uses the average detection.

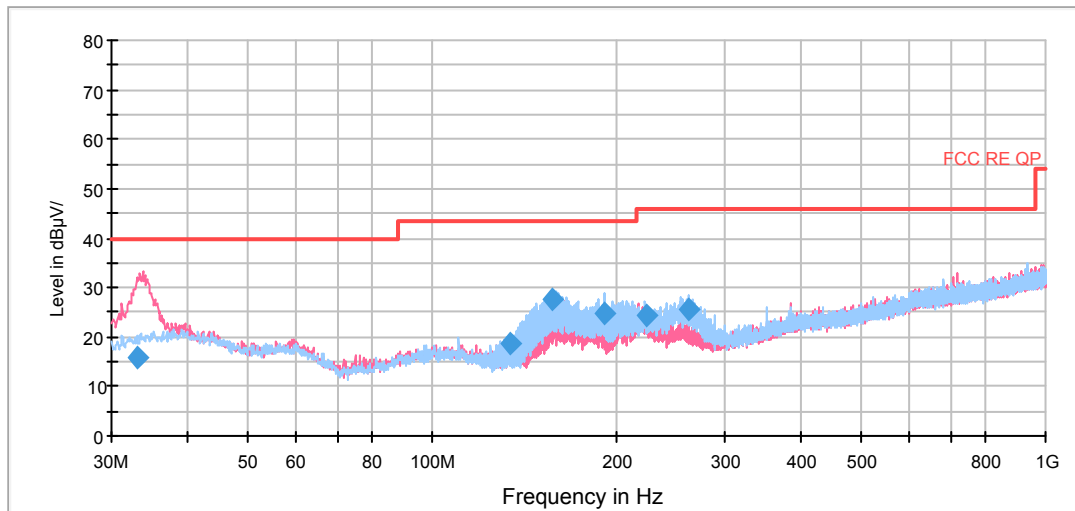

Radiated Emission from 30MHz to 1GHz

Frequency (MHz)	Quasi-Peak (dBuV/m)	Height (cm)	Polarization	Azimuth (deg)	Correct Factor (dB)	Margin (dB)	Limit (dBuV/m)
33.158750	15.8	100.0	V	306.0	15.6	24.2	40.0
134.557500	18.6	175.0	H	59.0	10.0	24.9	43.5
157.230000	27.6	189.0	H	250.0	10.0	15.9	43.5
190.453750	24.9	100.0	H	300.0	11.5	18.6	43.5
222.867500	24.4	114.0	H	289.0	12.9	21.6	46.0
261.790000	25.5	100.0	H	267.0	14.3	20.5	46.0

Remark: 1. Correction Factor = Antenna factor+ Insertion loss(cable loss+amplifier gain)

2. Margin = Limit – Quasi-Peak

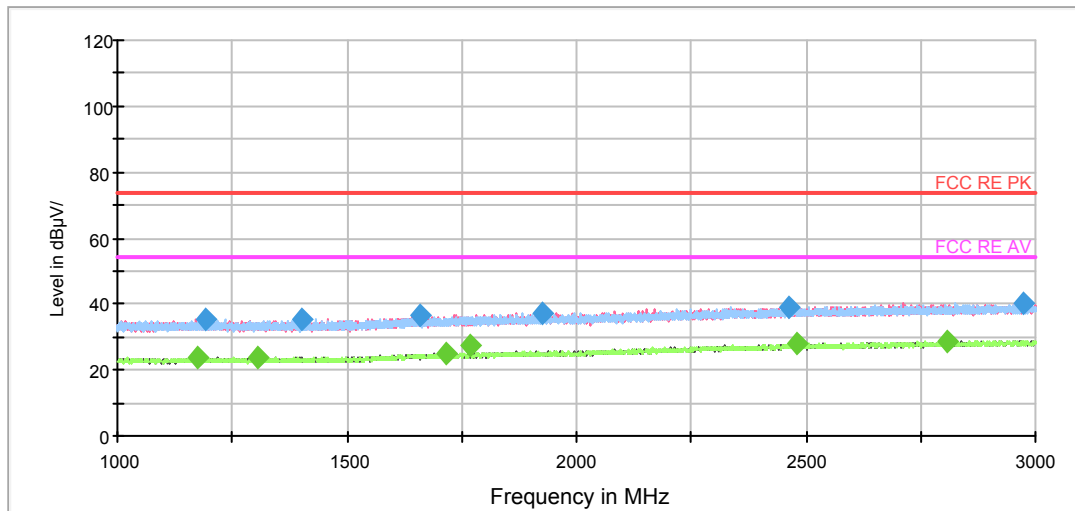

Radiated Emission from 1GHz to 3GHz

Frequency (MHz)	Peak (dBuV/m)	Height (cm)	Polarization	Azimuth (deg)	Correct Factor (dB)	Margin (dB)	Limit (dBuV/m)
1193.000000	35.1	200.0	H	181.0	-11.2	38.9	74.0
1403.500000	35.5	100.0	H	18.0	-10.7	38.5	74.0
1660.000000	36.6	100.0	V	197.0	-9.8	37.4	74.0
1924.750000	37.4	200.0	H	325.0	-9.0	36.6	74.0
2461.500000	39.0	200.0	H	283.0	-6.6	35.0	74.0
2973.250000	40.3	100.0	H	189.0	-5.3	33.7	74.0

Frequency (MHz)	Average (dBuV/m)	Height (cm)	Polarization	Azimuth (deg)	Correct Factor (dB)	Margin (dB)	Limit (dBuV/m)
1175.500000	23.6	200.0	V	98.0	-11.3	30.4	54.0
1304.250000	23.7	200.0	H	356.0	-11.0	30.3	54.0
1714.250000	24.7	200.0	V	145.0	-9.6	29.3	54.0
1766.500000	27.1	100.0	V	330.0	-9.5	26.9	54.0
2478.500000	27.7	200.0	H	0.0	-6.5	26.3	54.0
2807.000000	28.8	200.0	V	325.0	-5.7	25.2	54.0

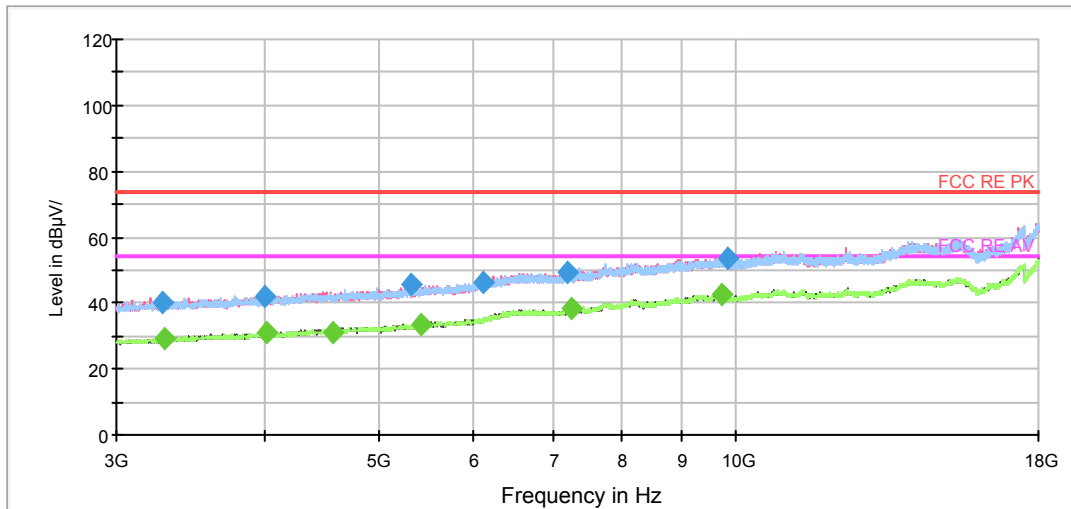

Radiated Emission from 3GHz to 18GHz

Frequency (MHz)	Peak (dBuV/m)	Height (cm)	Polarization	Azimuth (deg)	Correct Factor (dB)	Margin (dB)	Limit (dBuV/m)
3283.125000	39.9	200.0	H	358.0	-4.5	34.1	74.0
4005.000000	41.9	100.0	V	350.0	-2.7	32.1	74.0
5323.125000	45.7	200.0	V	108.0	0.6	28.3	74.0
6116.250000	46.4	100.0	V	358.0	2.6	27.6	74.0
7218.750000	49.4	200.0	H	168.0	5.6	24.6	74.0
9851.250000	53.6	200.0	V	19.0	12.0	20.4	74.0

Frequency (MHz)	Average (dBuV/m)	Height (cm)	Polarization	Azimuth (deg)	Correct Factor (dB)	Margin (dB)	Limit (dBuV/m)
3300.000000	29.1	100.0	V	281.0	-4.5	24.9	54.0
4023.750000	30.9	100.0	H	145.0	-2.6	23.1	54.0
4565.625000	31.2	100.0	V	0.0	-1.1	22.8	54.0
5413.125000	33.8	200.0	H	224.0	1.0	20.2	54.0
7275.000000	38.2	200.0	H	168.0	5.6	15.8	54.0
9735.000000	42.4	100.0	V	0.0	12.0	11.6	54.0

3.2 Conducted Emission

Ambient condition

Temperature	Relative humidity	Pressure
24°C ~26°C	50%~55%	102.5kPa

Methods of Measurement

The EUT is placed on a non-metallic table of 80cm height above the horizontal metal reference ground plane. During the test, the EUT was operating in its typical mode. The test method is according to ANSI C63.4-2014. Connect the AC power line of the EUT to the L.I.S.N. Use EMI receiver to detect the average and Quasi-peak value. RBW is set to 9 kHz, VBW is set to 30kHz. The measurement result should include both L line and N line.

During the test, EUT is connected to a laptop via a USB cable in the case of Transfer Data mode. The EUT is used as the peripheral equipment of the PC. The data is transferred from EUT to PC.

Test Setup

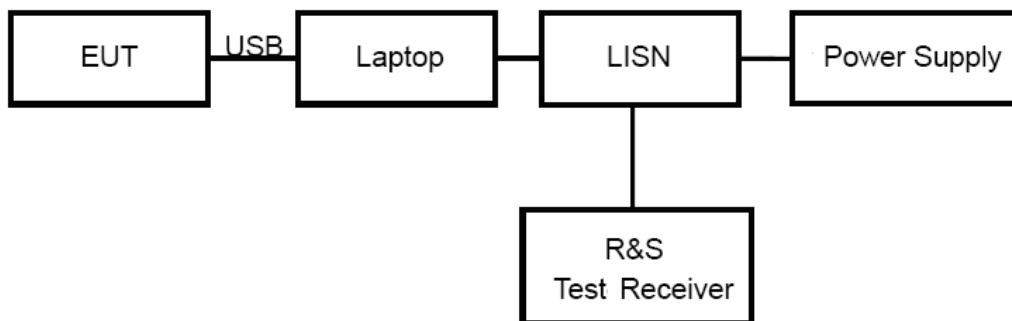

Note: Power Supply is AC Power source and it is used to change the voltage 120V/60Hz.

Limits

Frequency (MHz)	Conducted Limits(dBμV)	
	Quasi-peak	Average
0.15 - 0.5	66 to 56 *	56 to 46 *
0.5 - 5	56	46
5 - 30	60	50

*: Decreases with the logarithm of the frequency.

Measurement Uncertainty

The assessed measurement uncertainty to ensure 95% confidence level for the normal distribution is



with the coverage factor $k = 1.96$. $U = 2.57$ dB.

Test Results

Following plots, Blue trace uses the peak detection; Green trace uses the average detection.

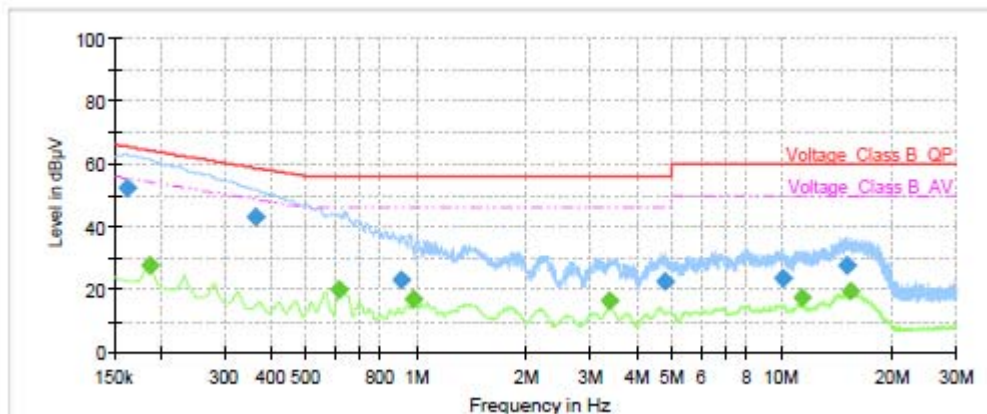

Frequency (MHz)	QuasiPeak (dBµV)	Average (dBµV)	Limit (dBµV)	Margin (dB)	Meas. Time (ms)	Bandwidth (kHz)	Line	Filter	Corr. (dB)
0.16	52.51	---	65.40	12.89	1000.0	9.000	L1	ON	19.13
0.19	---	27.81	54.21	26.40	1000.0	9.000	L1	ON	19.17
0.36	42.92	---	58.64	15.72	1000.0	9.000	L1	ON	19.19
0.62	---	19.81	46.00	26.19	1000.0	9.000	L1	ON	19.27
0.91	22.93	---	56.00	33.07	1000.0	9.000	L1	ON	19.24
0.98	---	16.89	46.00	29.11	1000.0	9.000	L1	ON	19.24
3.39	---	16.35	46.00	29.65	1000.0	9.000	L1	ON	19.05
4.79	22.67	---	56.00	33.33	1000.0	9.000	L1	ON	19.07
10.05	23.52	---	60.00	36.48	1000.0	9.000	L1	ON	19.41
11.35	---	17.43	50.00	32.57	1000.0	9.000	L1	ON	19.37
15.02	27.61	---	60.00	32.39	1000.0	9.000	L1	ON	19.51
15.44	---	19.43	50.00	30.57	1000.0	9.000	L1	ON	19.45

Remark: Correct factor=cable loss + LISN factor

L line

Conducted Emission from 150 KHz to 30 MHz

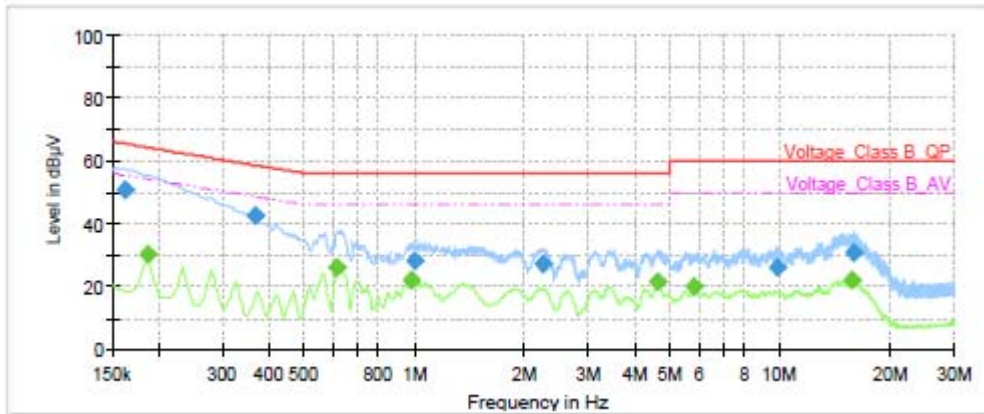

Frequency (MHz)	QuasiPeak (dBµV)	Average (dBµV)	Limit (dBµV)	Margin (dB)	Meas. Time (ms)	Bandwidth (kHz)	Line	Filter	Corr. (dB)
0.16	50.88	---	65.40	14.52	1000.0	9.000	N	ON	19.15
0.19	---	30.05	54.21	24.16	1000.0	9.000	N	ON	19.18
0.37	42.38	---	58.59	16.21	1000.0	9.000	N	ON	19.19
0.62	---	26.31	46.00	19.69	1000.0	9.000	N	ON	19.27
0.99	---	22.21	46.00	23.79	1000.0	9.000	N	ON	19.24
1.00	28.12	---	56.00	27.88	1000.0	9.000	N	ON	19.24
2.25	26.93	---	56.00	29.07	1000.0	9.000	N	ON	19.06
4.65	---	21.30	46.00	24.70	1000.0	9.000	N	ON	19.10
5.82	---	19.84	50.00	30.16	1000.0	9.000	N	ON	19.10
9.79	25.97	---	60.00	34.03	1000.0	9.000	N	ON	19.39
15.80	---	22.14	50.00	27.86	1000.0	9.000	N	ON	19.37
15.83	30.72	---	60.00	29.28	1000.0	9.000	N	ON	19.37

Remark: Correct factor=cable loss + LISN factor

N line

Conducted Emission from 150 KHz to 30 MHz

4 Main Test Instrument

Name	Manufacturer	Type	Serial Number	Calibration Date	Expiration Time
Spectrum Analyzer	R&S	FSV40	15195-01-00	2019-05-19	2020-05-18
EMI Test Receiver	R&S	ESCI	100948	2019-05-19	2020-05-18
Trilog Antenna	SCHWARZBECK	VULB 9163	9163-201	2017-11-18	2019-11-17
Horn Antenna	R&S	HF907	100126	2018-07-07	2020-07-06
Standard Gain Horn	ETS-Lindgren	3160-09	00102643	2018-06-20	2020-06-19
EMI Test Receiver	R&S	ESR	101667	2019-05-19	2020-05-18
LISN	R&S	ENV216	101171	2016-12-16	2019-12-15
Bore Sight Antenna mast	ETS	2171B	00058752	/	/
Test software	EMC32	R&S	9.26.0	/	/

*****END OF REPORT *****