



3158.625000	49.1	100.0	V	11.0	8.8	19.1	68.2
-------------	------	-------	---	------	-----	------	------

Remark: 1. Correction Factor = Antenna factor+ Insertion loss (cable loss + amplifier gain)

Frequency (MHz)	Average (dBuV/m)	Height (cm)	Polarization	Azimuth (deg)	Correct Factor (dB)	Margin (dB)	Limit (dBuV/m)
1362.250000	34.2	100.0	H	166.0	1.6	19.8	54.0
1528.500000	34.7	100.0	H	106.0	2.2	19.3	54.0
2229.375000	37.1	100.0	V	11.0	5.1	16.9	54.0
2784.125000	38.3	100.0	V	218.0	7.3	15.7	54.0
3992.500000	41.7	100.0	H	278.0	11.5	12.3	54.0
4976.875000	42.9	100.0	V	151.0	13.6	11.1	54.0

Remark: 1. Correction Factor = Antenna factor+ Insertion loss (cable loss + amplifier gain)



802.11n (HT40) CH134

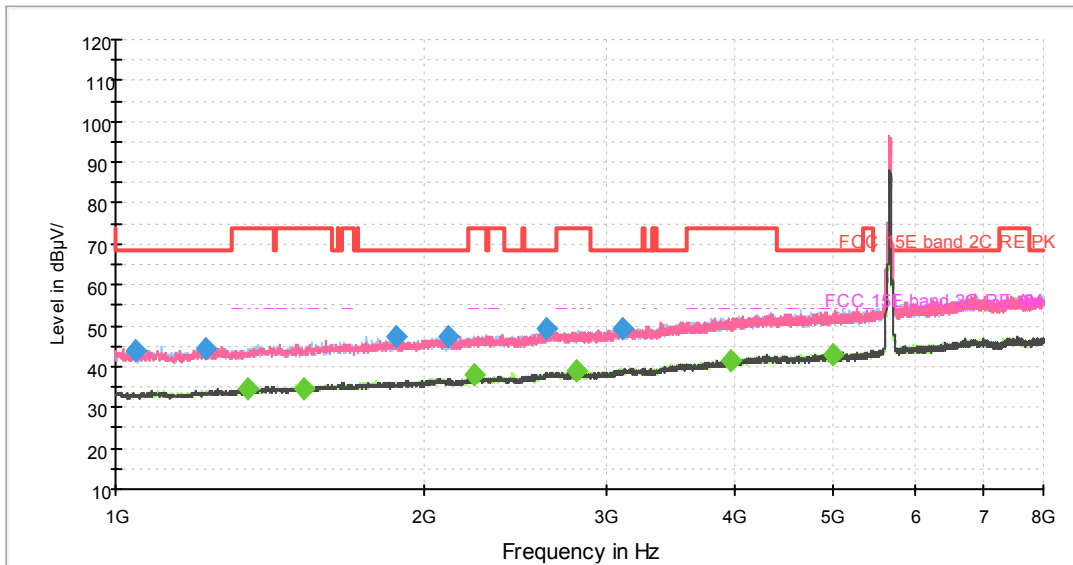

Note: The signal beyond the limit is carrier.
Radiates Emission from 1GHz to 8GHz

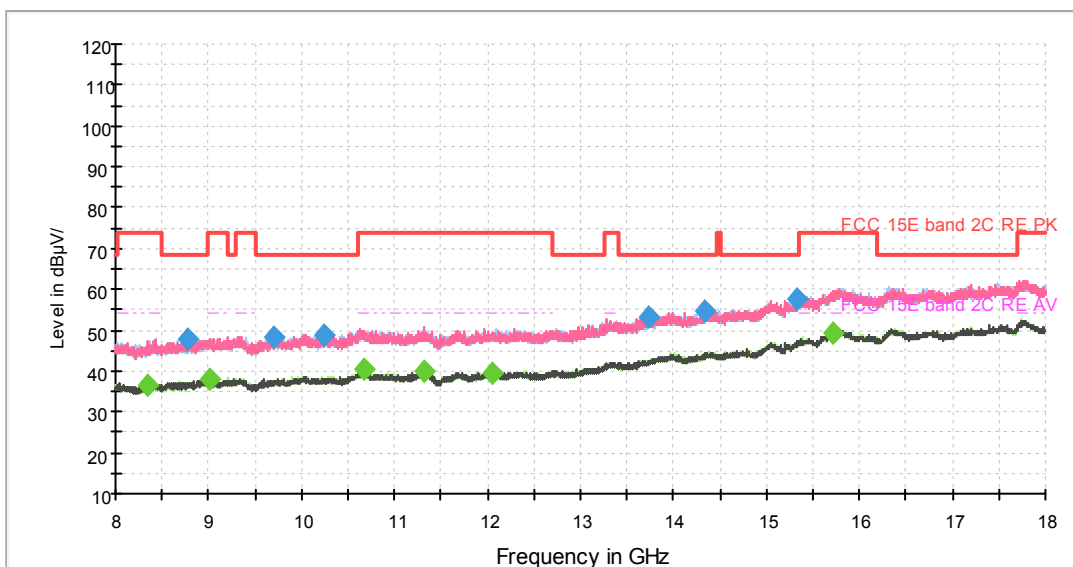

Radiates Emission from 8GHz to 18GHz

Frequency (MHz)	Peak (dBuV/m)	Height (cm)	Polarization	Azimuth (deg)	Correct Factor (dB)	Margin (dB)	Limit (dBuV/m)
1046.375000	44.1	100.0	V	225.0	-0.4	24.1	68.2
1224.000000	44.2	100.0	H	0.0	0.9	24.0	68.2
1877.625000	47.2	100.0	V	216.0	3.7	21.0	68.2
2106.875000	47.1	100.0	H	0.0	4.5	21.1	68.2
2631.000000	49.4	100.0	H	0.0	6.8	18.8	68.2



3118.375000	49.2	100.0	V	264.0	8.7	19.0	68.2
-------------	------	-------	---	-------	-----	------	------

Remark: 1. Correction Factor = Antenna factor+ Insertion loss (cable loss + amplifier gain)

Frequency (MHz)	Average (dBuV/m)	Height (cm)	Polarization	Azimuth (deg)	Correct Factor (dB)	Margin (dB)	Limit (dBuV/m)
1346.500000	34.4	100.0	V	53.0	1.4	19.6	54.0
1524.125000	34.8	100.0	H	0.0	2.2	19.2	54.0
2236.375000	37.8	100.0	H	44.0	5.1	16.2	54.0
2803.375000	38.9	100.0	V	6.0	7.4	15.1	54.0
3963.625000	41.4	100.0	H	269.0	11.4	12.6	54.0
4997.875000	42.9	100.0	H	299.0	13.6	11.1	54.0

Remark: 1. Correction Factor = Antenna factor+ Insertion loss (cable loss + amplifier gain)



802.11n (HT40) CH151

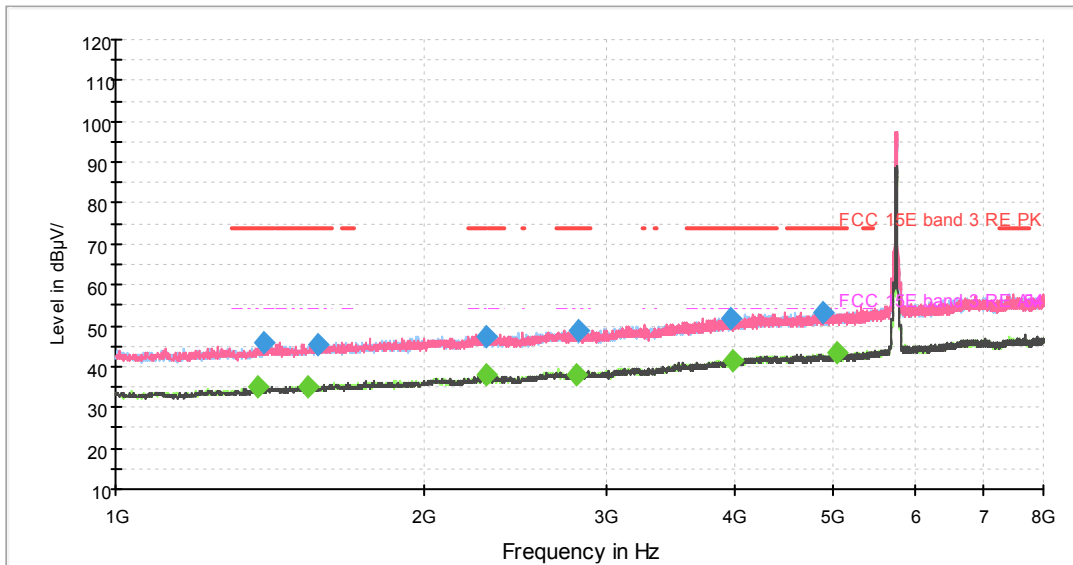

Note: The signal beyond the limit is carrier.
Radiates Emission from 1GHz to 8GHz

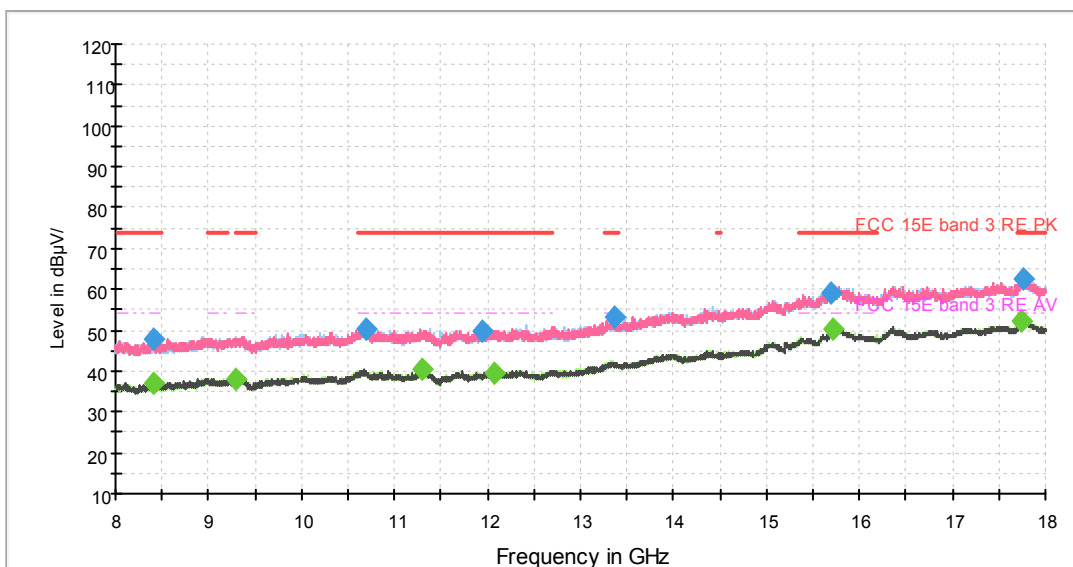

Radiates Emission from 8GHz to 18GHz

Frequency (MHz)	Peak (dBuV/m)	Height (cm)	Polarization	Azimuth (deg)	Correct Factor (dB)	Margin (dB)	Limit (dBuV/m)
1393.750000	45.6	100.0	H	289.0	1.8	28.4	74.0
1574.000000	45.5	100.0	V	212.0	2.4	28.5	74.0
2293.250000	47.4	100.0	H	0.0	5.4	26.6	74.0
2820.000000	49.0	100.0	V	10.0	7.5	25.0	74.0
3978.500000	51.9	100.0	H	338.0	11.5	22.1	74.0



4874.500000	53.3	100.0	H	0.0	13.4	20.7	74.0
-------------	------	-------	---	-----	------	------	------

Remark: 1. Correction Factor = Antenna factor+ Insertion loss (cable loss + amplifier gain)

Frequency (MHz)	Average (dBuV/m)	Height (cm)	Polarization	Azimuth (deg)	Correct Factor (dB)	Margin (dB)	Limit (dBuV/m)
1376.250000	34.8	100.0	V	316.0	1.7	19.2	54.0
1539.875000	35.3	100.0	V	131.0	2.2	18.7	54.0
2296.750000	37.8	100.0	V	0.0	5.4	16.2	54.0
2808.625000	38.1	100.0	H	227.0	7.4	15.9	54.0
3994.250000	41.6	100.0	H	255.0	11.5	12.4	54.0
5030.250000	43.4	100.0	V	322.0	13.7	10.6	54.0

Remark: 1. Correction Factor = Antenna factor+ Insertion loss (cable loss + amplifier gain)



802.11n (HT40) CH159

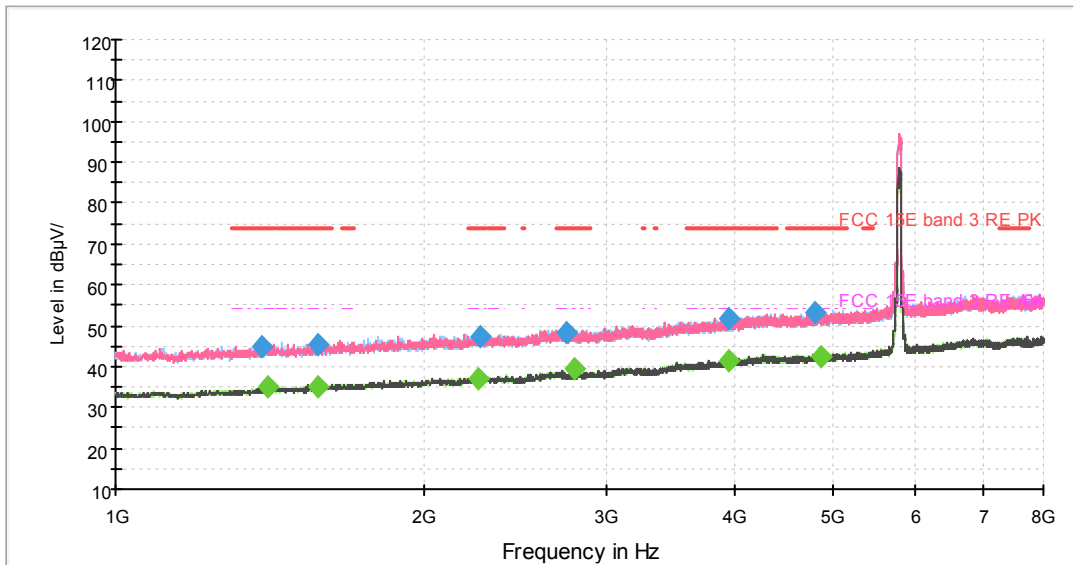

Note: The signal beyond the limit is carrier.
Radiates Emission from 1GHz to 8GHz

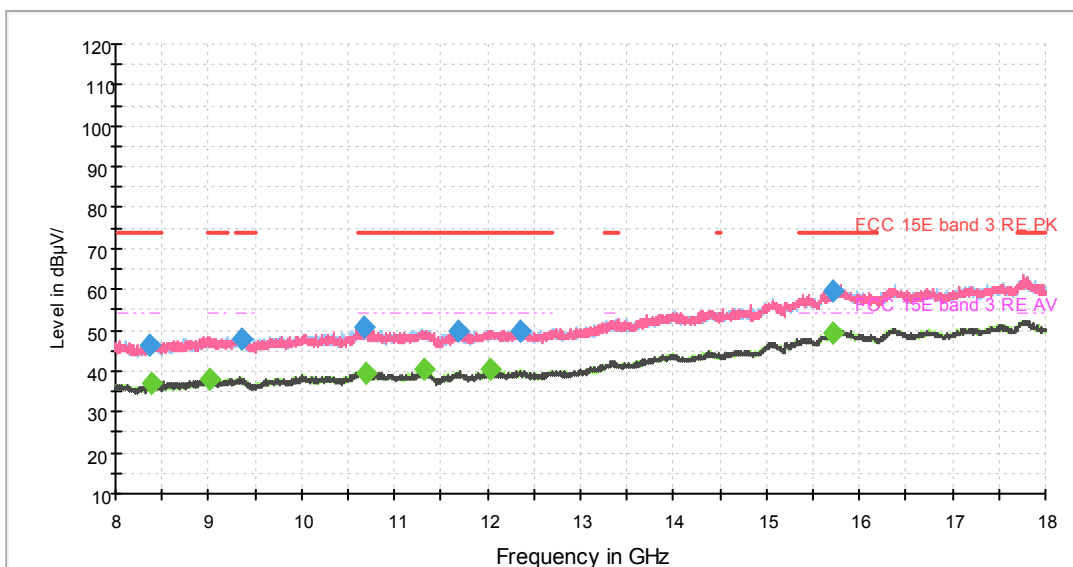

Radiates Emission from 8GHz to 18GHz

Frequency (MHz)	Peak (dBuV/m)	Height (cm)	Polarization	Azimuth (deg)	Correct Factor (dB)	Margin (dB)	Limit (dBuV/m)
1386.750000	44.8	100.0	V	101.0	1.7	29.2	74.0
1574.000000	45.1	100.0	H	186.0	2.4	28.9	74.0
2267.000000	47.4	100.0	H	224.0	5.3	26.6	74.0
2751.750000	48.2	100.0	H	169.0	7.2	25.8	74.0
3947.000000	51.7	100.0	V	336.0	11.4	22.3	74.0



4796.625000	53.4	100.0	V	0.0	12.3	20.6	74.0
-------------	------	-------	---	-----	------	------	------

Remark: 1. Correction Factor = Antenna factor+ Insertion loss (cable loss + amplifier gain)

Frequency (MHz)	Average (dBuV/m)	Height (cm)	Polarization	Azimuth (deg)	Correct Factor (dB)	Margin (dB)	Limit (dBuV/m)
1386.750000	44.8	100.0	V	101.0	1.7	29.2	74.0
1574.000000	45.1	100.0	H	186.0	2.4	28.9	74.0
2267.000000	47.4	100.0	H	224.0	5.3	26.6	74.0
2751.750000	48.2	100.0	H	169.0	7.2	25.8	74.0
3947.000000	51.7	100.0	V	336.0	11.4	22.3	74.0
4796.625000	53.4	100.0	V	0.0	12.3	20.6	74.0

Remark: 1. Correction Factor = Antenna factor+ Insertion loss (cable loss + amplifier gain)



802.11ac (HT80) CH42

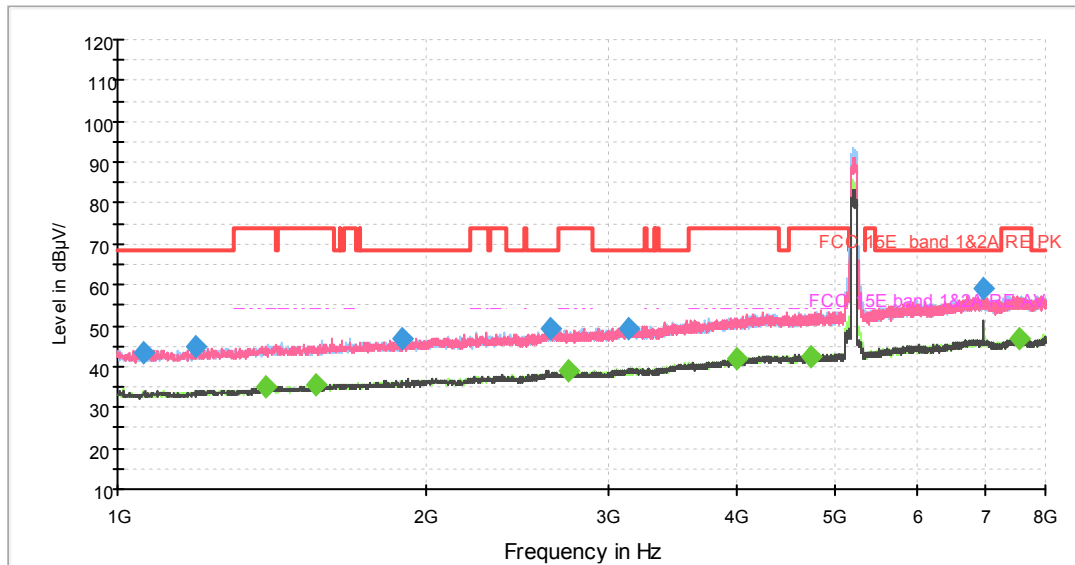

Note: The signal beyond the limit is carrier.
Radiates Emission from 1GHz to 8GHz

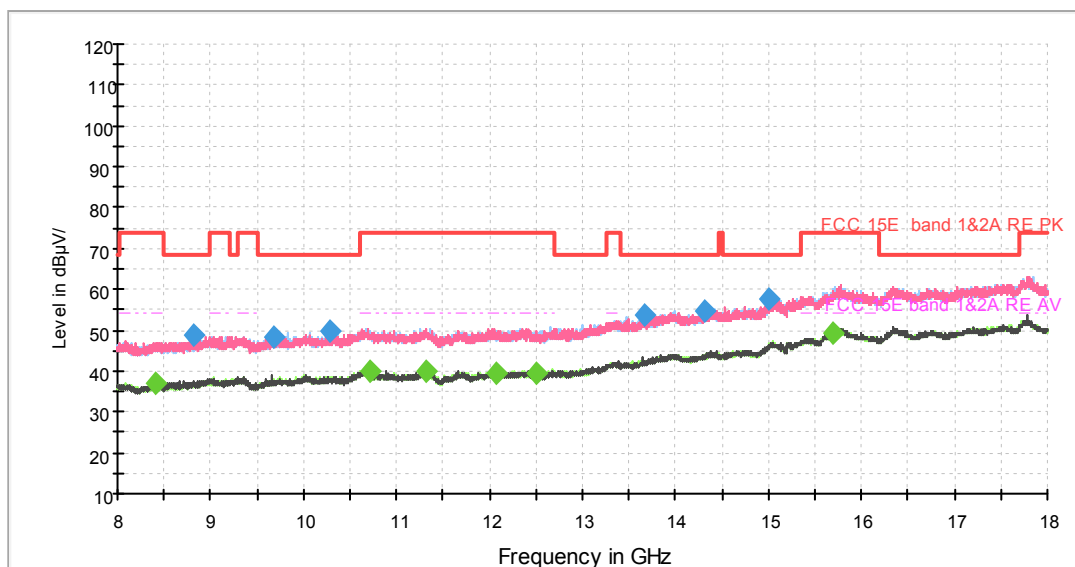

Radiates Emission from 8GHz to 18GHz

Frequency (MHz)	Peak (dBuV/m)	Height (cm)	Polarization	Azimuth (deg)	Correct Factor (dB)	Margin (dB)	Limit (dBuV/m)
1059.500000	43.2	100.0	H	272.0	-0.3	25.0	68.2
1189.875000	44.6	100.0	V	262.0	0.7	23.6	68.2
1888.125000	46.9	100.0	V	50.0	3.7	21.3	68.2
2632.750000	49.1	100.0	V	128.0	6.8	19.1	68.2
3146.375000	49.5	100.0	V	17.0	8.8	18.7	68.2



6946.500000	59.1	100.0	V	9.0	17.7	9.1	68.2
-------------	------	-------	---	-----	------	-----	------

Remark: 1. Correction Factor = Antenna factor+ Insertion loss (cable loss + amplifier gain)

Frequency (MHz)	Average (dBuV/m)	Height (cm)	Polarization	Azimuth (deg)	Correct Factor (dB)	Margin (dB)	Limit (dBuV/m)
1394.625000	35.0	100.0	V	50.0	1.8	19.0	54.0
1562.625000	35.3	100.0	V	59.0	2.3	18.7	54.0
2746.500000	39.0	100.0	H	263.0	7.2	15.0	54.0
3997.750000	41.8	100.0	H	263.0	11.6	12.2	54.0
4738.000000	42.6	100.0	H	239.0	13.2	11.4	54.0
7552.875000	47.0	100.0	V	237.0	18.7	7.0	54.0

Remark: 1. Correction Factor = Antenna factor+ Insertion loss (cable loss + amplifier gain)



802.11ac (HT80) CH58

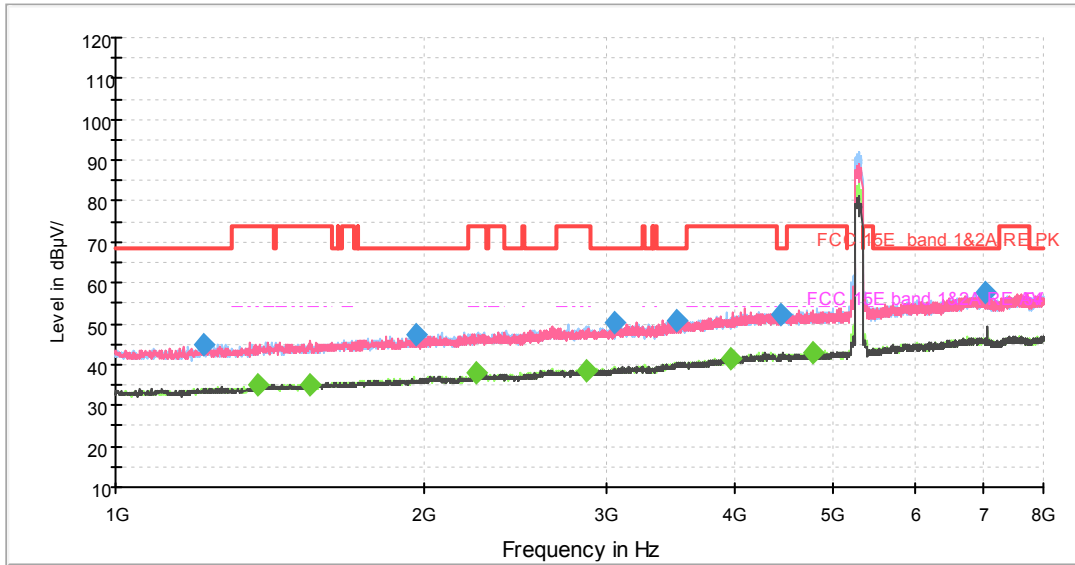

Note: The signal beyond the limit is carrier.
Radiates Emission from 1GHz to 8GHz

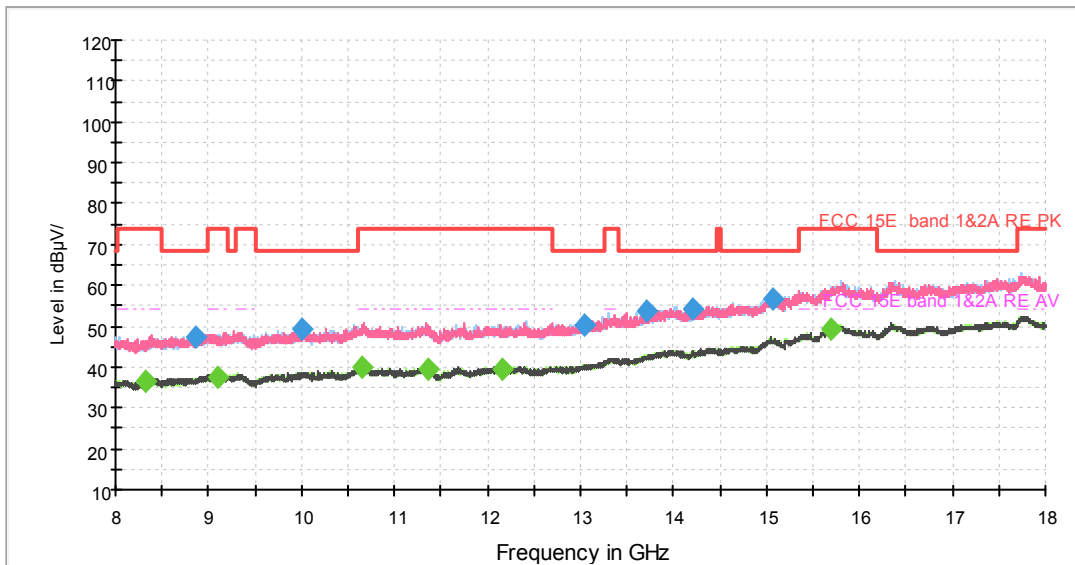

Radiates Emission from 8GHz to 18GHz

Frequency (MHz)	Peak (dBuV/m)	Height (cm)	Polarization	Azimuth (deg)	Correct Factor (dB)	Margin (dB)	Limit (dBuV/m)
1220.500000	44.9	100.0	V	25.0	0.9	23.3	68.2
1961.625000	47.2	100.0	V	55.0	4.1	21.0	68.2
3065.000000	50.1	100.0	H	241.0	8.5	18.1	68.2
3518.250000	50.5	100.0	H	0.0	10.1	17.7	68.2
4437.000000	52.2	100.0	V	55.0	12.5	16.0	68.2



7030.500000	57.7	100.0	H	299.0	17.8	10.5	68.2
-------------	------	-------	---	-------	------	------	------

Remark: 1. Correction Factor = Antenna factor+ Insertion loss (cable loss + amplifier gain)

Frequency (MHz)	Average (dBuV/m)	Height (cm)	Polarization	Azimuth (deg)	Correct Factor (dB)	Margin (dB)	Limit (dBuV/m)
1376.250000	35.0	100.0	V	131.0	1.7	19.0	54.0
1545.125000	35.2	100.0	V	314.0	2.3	18.8	54.0
2240.750000	37.9	100.0	V	180.0	5.1	16.1	54.0
2876.875000	38.7	100.0	H	178.0	7.7	15.3	54.0
3965.375000	41.7	100.0	V	89.0	11.4	12.3	54.0
4762.500000	42.8	100.0	V	294.0	13.3	11.2	54.0

Remark: 1. Correction Factor = Antenna factor+ Insertion loss (cable loss + amplifier gain)



802.11ac (HT80) CH106

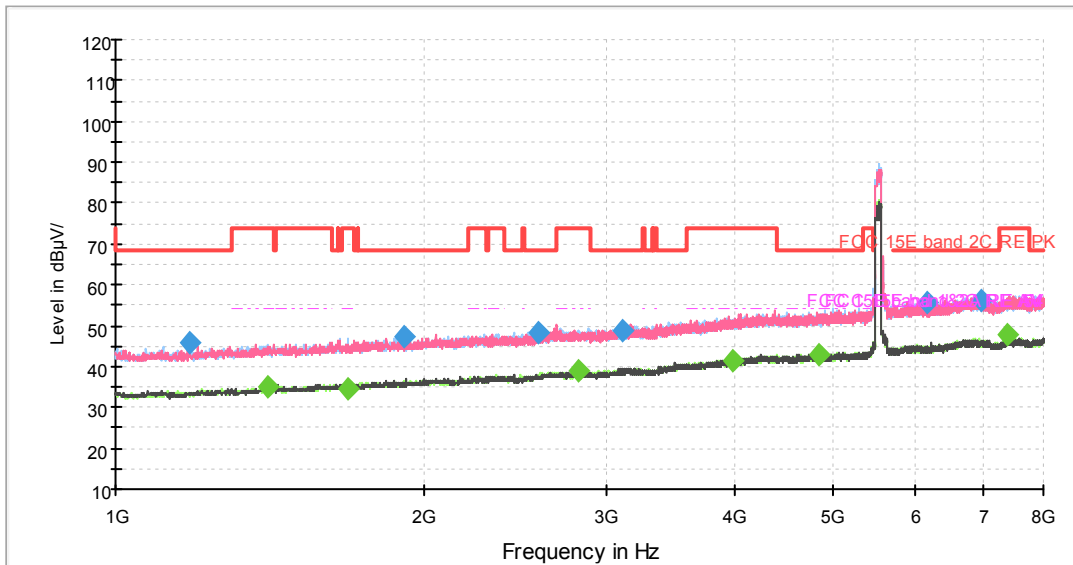

Note: The signal beyond the limit is carrier.
Radiates Emission from 1GHz to 8GHz

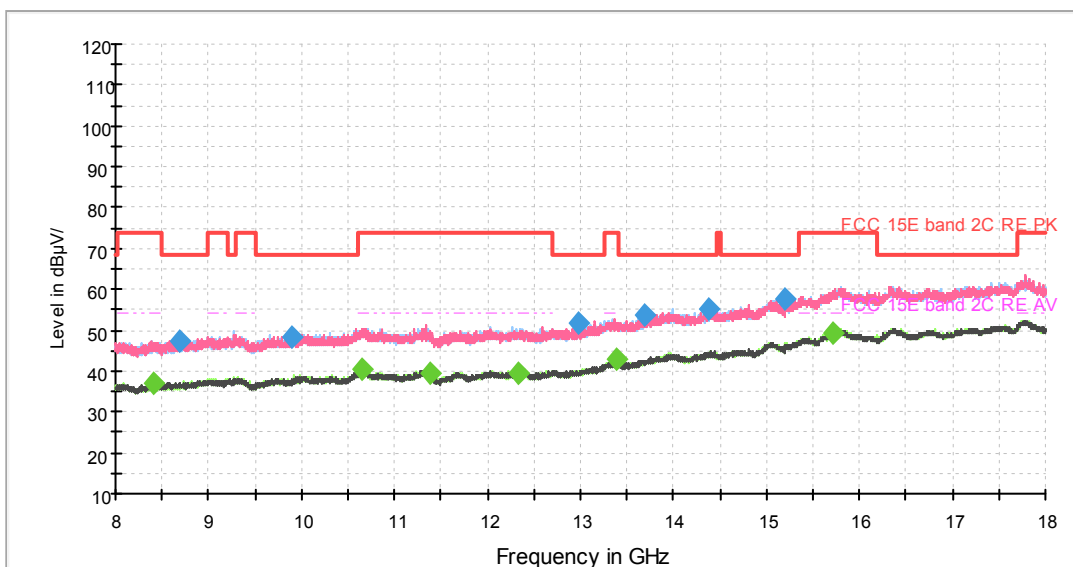

Radiates Emission from 8GHz to 18GHz

Frequency (MHz)	Peak (dBuV/m)	Height (cm)	Polarization	Azimuth (deg)	Correct Factor (dB)	Margin (dB)	Limit (dBuV/m)
1182.875000	45.9	100.0	H	285.0	0.6	22.3	68.2
1912.625000	47.1	100.0	V	0.0	3.8	21.1	68.2
2584.625000	48.2	100.0	H	285.0	6.5	20.0	68.2
3117.500000	48.7	100.0	H	310.0	8.7	19.5	68.2
6157.250000	55.5	100.0	V	153.0	16.2	12.7	68.2



6947.375000	56.1	100.0	V	0.0	17.7	12.1	68.2
-------------	------	-------	---	-----	------	------	------

Remark: 1. Correction Factor = Antenna factor+ Insertion loss (cable loss + amplifier gain)

Frequency (MHz)	Average (dBuV/m)	Height (cm)	Polarization	Azimuth (deg)	Correct Factor (dB)	Margin (dB)	Limit (dBuV/m)
1407.750000	35.1	100.0	H	243.0	1.9	18.9	54.0
1681.625000	34.8	100.0	H	0.0	2.9	19.2	54.0
2825.250000	38.8	100.0	H	211.0	7.5	15.2	54.0
3996.875000	41.6	100.0	H	219.0	11.6	12.4	54.0
4833.375000	43.0	100.0	H	126.0	13.4	11.0	54.0
7373.500000	48.0	100.0	V	0.0	18.1	6.0	54.0

Remark: 1. Correction Factor = Antenna factor+ Insertion loss (cable loss + amplifier gain)



802.11ac (HT80) CH122

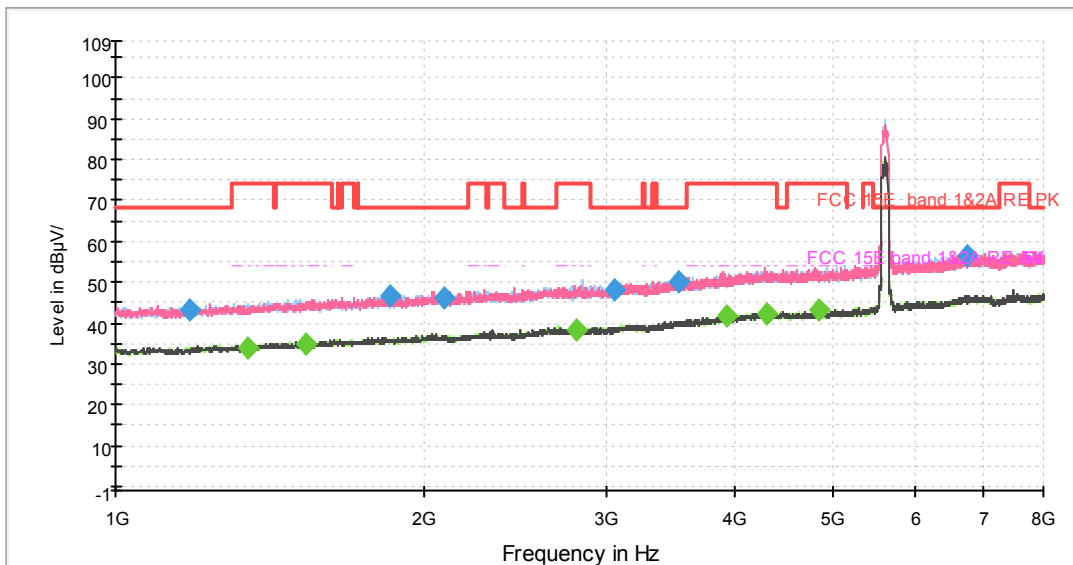

Note: The signal beyond the limit is carrier.
Radiates Emission from 1GHz to 8GHz

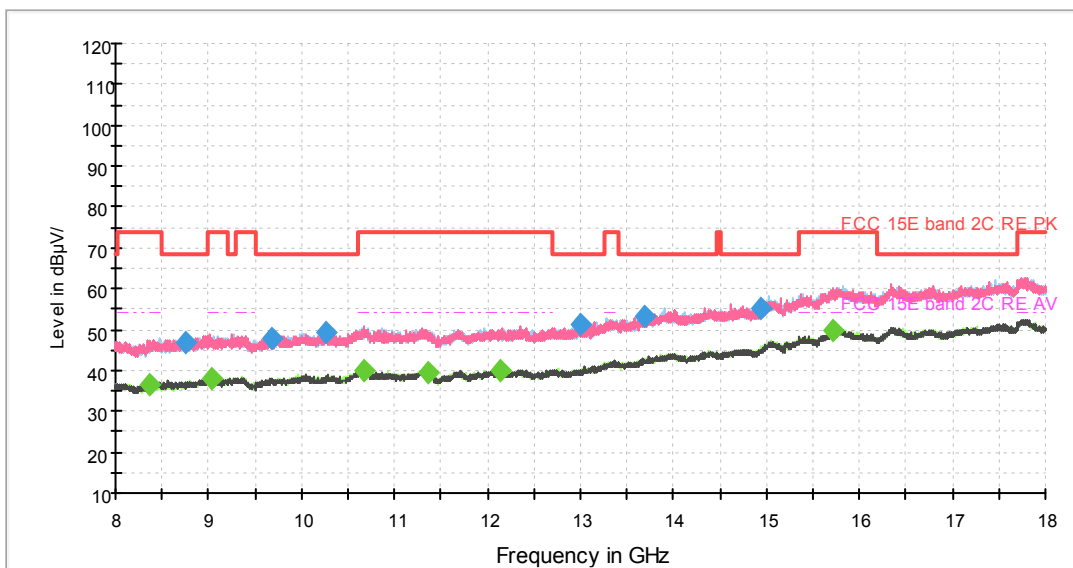

Radiates Emission from 8GHz to 18GHz

Frequency (MHz)	Peak (dBuV/m)	Height (cm)	Polarization	Azimuth (deg)	Correct Factor (dB)	Margin (dB)	Limit (dBuV/m)
1182.000000	43.4	100.0	V	266.0	0.6	24.8	68.2
1846.125000	46.7	100.0	V	25.0	3.6	21.5	68.2
2085.000000	46.3	100.0	H	265.0	4.4	21.9	68.2
3060.625000	48.2	100.0	H	130.0	8.4	20.0	68.2
3531.375000	50.2	100.0	H	86.0	10.2	18.0	68.2



6756.625000	56.4	100.0	V	85.0	17.7	11.8	68.2
-------------	------	-------	---	------	------	------	------

Remark: 1. Correction Factor = Antenna factor+ Insertion loss (cable loss + amplifier gain)

Frequency (MHz)	Average (dBuV/m)	Height (cm)	Polarization	Azimuth (deg)	Correct Factor (dB)	Margin (dB)	Limit (dBuV/m)
1342.125000	34.1	100.0	H	359.0	1.4	19.9	54.0
1534.625000	34.7	100.0	H	165.0	2.2	19.3	54.0
2813.875000	38.1	100.0	H	114.0	7.4	15.9	54.0
3933.875000	41.6	100.0	H	274.0	11.3	12.4	54.0
4308.375000	42.3	100.0	H	359.0	12.4	11.7	54.0
4832.500000	43.2	100.0	H	315.0	13.4	10.8	54.0

Remark: 1. Correction Factor = Antenna factor+ Insertion loss (cable loss + amplifier gain)



802.11ac (HT80) CH155

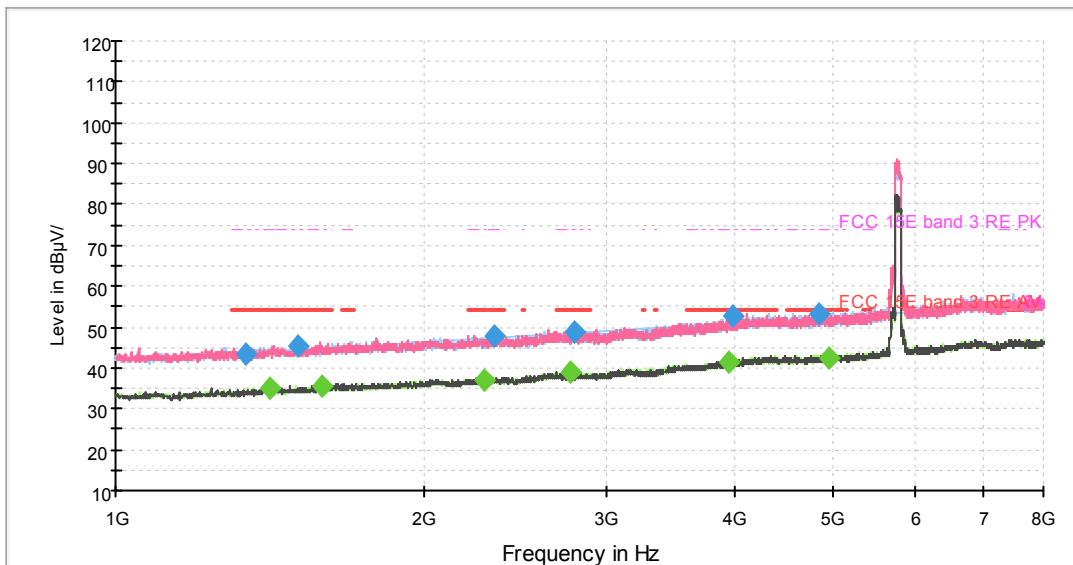

Note: The signal beyond the limit is carrier.
Radiates Emission from 1GHz to 8GHz

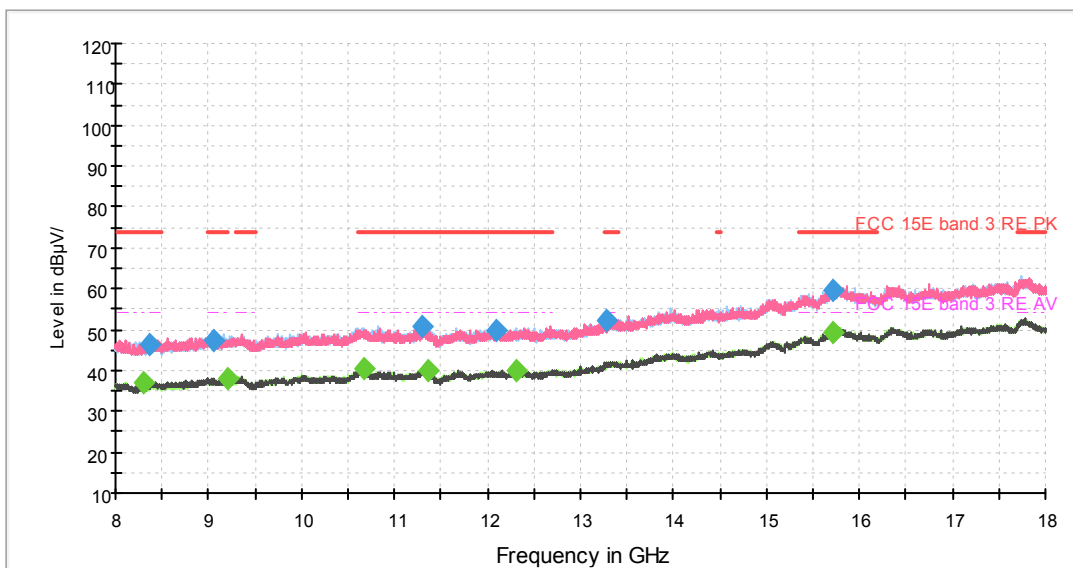

Radiates Emission from 8GHz to 18GHz

Frequency (MHz)	Peak (dBuV/m)	Height (cm)	Polarization	Azimuth (deg)	Correct Factor (dB)	Margin (dB)	Limit (dBuV/m)
1337.750000	43.6	100.0	H	302.0	1.4	30.4	74.0
1504.000000	45.1	100.0	V	104.0	2.2	28.9	74.0
2331.750000	47.9	100.0	H	248.0	5.5	26.1	74.0
2799.875000	49.0	100.0	V	56.0	7.4	25.0	74.0
3988.125000	52.7	100.0	V	178.0	11.5	21.3	74.0



4843.000000	53.0	100.0	H	207.0	13.4	21.0	74.0
-------------	------	-------	---	-------	------	------	------

Remark: 1. Correction Factor = Antenna factor+ Insertion loss (cable loss + amplifier gain)

Frequency (MHz)	Average (dBuV/m)	Height (cm)	Polarization	Azimuth (deg)	Correct Factor (dB)	Margin (dB)	Limit (dBuV/m)
1413.875000	35.0	100.0	H	335.0	1.9	19.0	54.0
1586.250000	35.6	100.0	H	81.0	2.5	18.4	54.0
2284.500000	36.8	100.0	H	302.0	5.4	17.2	54.0
2777.125000	38.8	100.0	V	247.0	7.3	15.2	54.0
3961.000000	41.5	100.0	V	0.0	11.4	12.5	54.0
4936.625000	42.6	100.0	V	40.0	13.5	11.4	54.0

Remark: 1. Correction Factor = Antenna factor+ Insertion loss (cable loss + amplifier gain)

5.6. Conducted Emission

Ambient condition

Temperature	Relative humidity	Pressure
23°C ~25°C	45%~50%	101.5kPa

Methods of Measurement

The EUT IS placed on a non-metallic table of 80cm height above the horizontal metal reference ground plane. During the test, the EUT was operating in its typical mode. The test method is according to ANSI C63.10-2013. Connect the AC power line of the EUT to the LISN Use EMI receiver to detect the average and Quasi-peak value. RBW is set to 9kHz, VBW is set to 30kHz The measurement result should include both L line and N line.

The test is in transmitting mode.

Test Setup

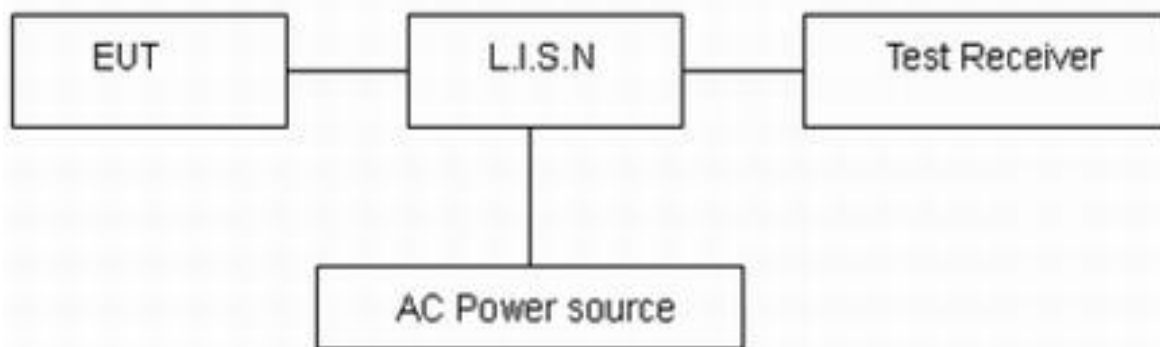

Note: AC Power source is used to change the voltage 110V/60Hz.

Limits

Frequency (MHz)	Conducted Limits(dBμV)	
	Quasi-peak	Average
0.15 - 0.5	66 to 56 *	56 to 46*
0.5 - 5	56	46
5 - 30	60	50

*: Decreases with the logarithm of the frequency.

Measurement Uncertainty

The assessed measurement uncertainty to ensure 95% confidence level for the normal distribution is with the coverage factor $k = 1.96$, $U = 2.69$ dB.



Test Results:

Following plots, Blue trace uses the peak detection and Green trace uses the average detection. During the test, the Conducted Emission was performed in all modes with all channels, 802.11ac (HT80) CH106 are selected as the worst condition. The test data of the worst-case condition was recorded in this report.

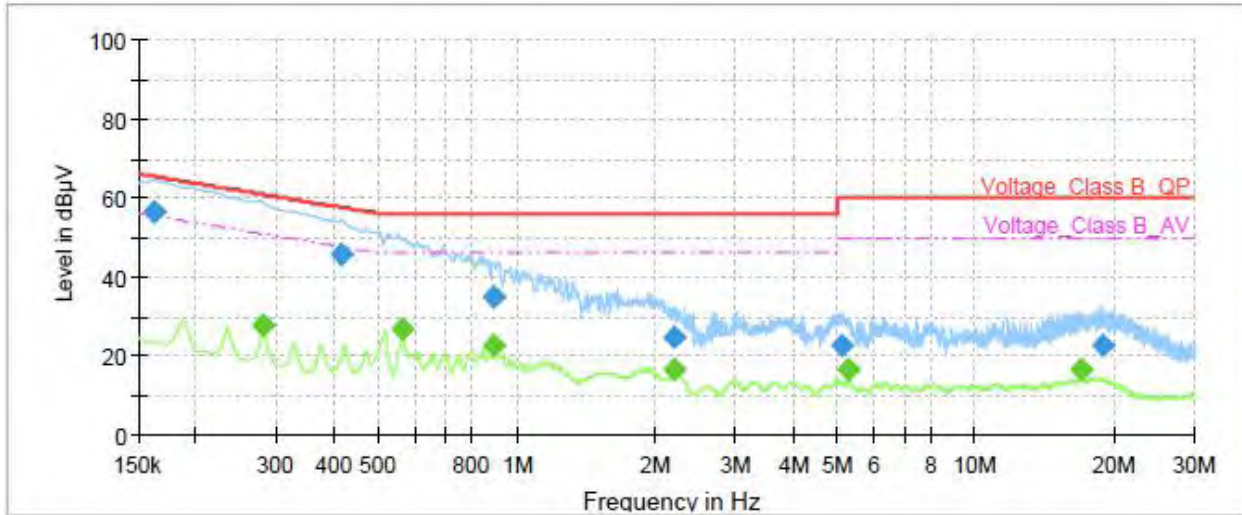

Frequency (MHz)	QuasiPeak (dBµV)	Average (dBµV)	Limit (dBµV)	Margin (dB)	Meas. Time (ms)	Bandwidth (kHz)	Line	Filter	Corr. (dB)
0.16	56.27	---	65.40	9.13	1000.0	9.000	L1	ON	19.13
0.28	---	27.77	50.80	23.03	1000.0	9.000	L1	ON	19.17
0.42	45.84	---	57.54	11.70	1000.0	9.000	L1	ON	19.23
0.56	---	26.65	46.00	19.35	1000.0	9.000	L1	ON	19.26
0.89	34.68	---	56.00	21.32	1000.0	9.000	L1	ON	19.24
0.89	---	22.31	46.00	23.69	1000.0	9.000	L1	ON	19.24
2.20	---	16.59	46.00	29.41	1000.0	9.000	L1	ON	19.07
2.22	24.83	---	56.00	31.17	1000.0	9.000	L1	ON	19.07
5.14	22.73	---	60.00	37.27	1000.0	9.000	L1	ON	19.09
5.30	---	16.26	50.00	33.74	1000.0	9.000	L1	ON	19.09
17.01	---	16.45	50.00	33.55	1000.0	9.000	L1	ON	19.57
18.97	22.56	---	60.00	37.44	1000.0	9.000	L1	ON	19.61

Remark: Correct factor=cable loss + LISN factor

L line Conducted Emission from 150 KHz to 30 MHz

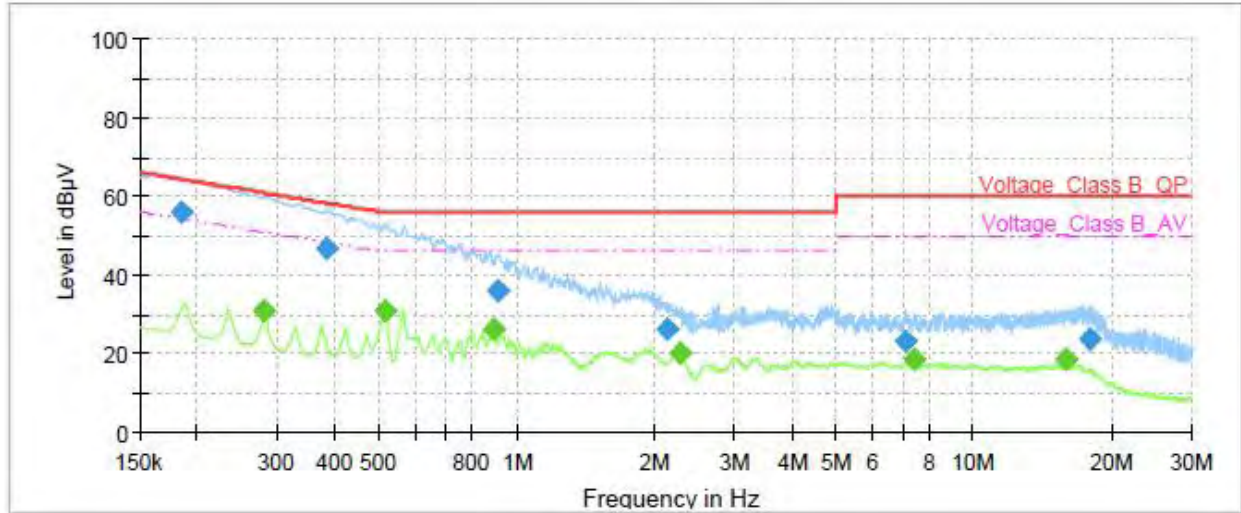

Frequency (MHz)	QuasiPeak (dBµV)	Average (dBµV)	Limit (dBµV)	Margin (dB)	Meas. Time (ms)	Bandwidth (kHz)	Line	Filter	Corr. (dB)
0.18	56.06	---	64.31	8.25	1000.0	9.000	N	ON	19.17
0.28	---	30.80	50.80	20.00	1000.0	9.000	N	ON	19.17
0.38	46.66	---	58.19	11.53	1000.0	9.000	N	ON	19.23
0.51	---	30.56	46.00	15.44	1000.0	9.000	N	ON	19.24
0.89	---	25.91	46.00	20.09	1000.0	9.000	N	ON	19.24
0.91	35.81	---	56.00	20.19	1000.0	9.000	N	ON	19.24
2.14	25.94	---	56.00	30.06	1000.0	9.000	N	ON	19.07
2.28	---	20.01	46.00	25.99	1000.0	9.000	N	ON	19.05
7.11	23.03	---	60.00	36.97	1000.0	9.000	N	ON	19.16
7.44	---	18.70	50.00	31.30	1000.0	9.000	N	ON	19.20
15.96	---	18.31	50.00	31.69	1000.0	9.000	N	ON	19.39
18.02	23.51	---	60.00	36.49	1000.0	9.000	N	ON	19.42

Remark: Correct factor=cable loss + LISN factor

N line Conducted Emission from 150 KHz to 30 MHz



6. Main Test Instruments

Name	Manufacturer	Type	Serial Number	Calibration Date	Expiration Date
Spectrum Analyzer	R&S	FSV40	15195-01-00	2019-05-19	2020-05-18
EMI Test Receiver	R&S	ESCI	100948	2019-05-19	2020-05-18
Loop Antenna	SCHWARZBECK	FMZB1519	1519-047	2017-09-26	2019-09-25
TRILOG Broadband Antenna	SCHWARZBECK	VULB 9163	9163-201	2017-11-18	2019-11-17
Double Ridged Waveguide Horn Antenna	R&S	HF907	100126	2018-07-07	2020-07-06
Standard Gain Horn	ETS-Lindgren	3160-09	00102643	2018-06-20	2020-06-19
Standard Gain Horn	STEATITE	QSH-SL-26-40 -K-15	16779	2017-07-20	2019-07-19
Broadband Horn Antenna	SCHWARZBECK	BBHA 9120D	430	2018-07-07	2020-07-06
EMI Test Receiver	R&S	ESR	101667	2019-05-19	2020-05-18
LISN	R&S	ENV216	101171	2016-12-16	2019-12-15
Spectrum Analyzer	KEYSIGHT	N9020A	MY54420163	2018-12-16	2019-12-15
RF Cable	Agilent	SMA 15cm	0001	2019-06-14	2019-09-13
TEMPERATURE CHAMBER	WEISS	VT4002	582261194500 10	2018-12-16	2019-12-15
WLAN AP	Cisco	Air-AP1262N- A-K9	LDK102073 (FCC ID)	/	/
AV Power Meter	R&S	NRP	104306	2019-05-19	2020-05-18
Power Probe	R&S	NRP-Z21	104799	2019-05-19	2020-05-18
DC Power Supply	GWINSTEK	GPS-3030D	GEP882653	2019-05-19	2020-05-18
Software	R&S	EMC32	9.26.0	/	/

*****END OF REPORT *****