



RF TEST REPORT

Applicant Xiaomi Communications Co., Ltd.
FCC ID 2AFZZC3IH
Product Mobile Phone
Brand Redmi
Model M1908C3IH
Report No. R1907A0375-R2
Issue Date August 17, 2019

TA Technology (Shanghai) Co., Ltd. tested the above equipment in accordance with the requirements in **FCC CFR47 Part 2 (2018)/ FCC CFR 47 Part 24E (2018)**. The test results show that the equipment tested is capable of demonstrating compliance with the requirements as documented in this report.

Performed by: Peng Tao

Approved by: Kai Xu

TA Technology (Shanghai) Co., Ltd.

No.145, Jintang Rd, Tangzhen Industry Park, Pudong Shanghai, China

TEL: +86-021-50791141/2/3

FAX: +86-021-50791141/2/3-8000



TABLE OF CONTENT

1. Test Laboratory	4
1.1. Notes of the test report.....	4
1.2. Test facility.....	4
1.3. Testing Location	5
2. General Description of Equipment under Test.....	6
3. Applied Standards.....	8
4. Test Configuration.....	9
5. Test Case Results.....	11
5.1. RF Power Output.....	11
5.2. Effective Isotropic Radiated Power	16
5.3. Occupied Bandwidth	21
5.4. Band Edge Compliance.....	36
5.5. Peak-to-Average Power Ratio (PAPR)	51
5.6. Frequency Stability.....	55
5.7. Spurious Emissions at Antenna Terminals	61
5.8. Radiates Spurious Emission	77
6. Main Test Instruments	83

Summary of measurement results

No.	Test Case	Clause in FCC rules	Verdict
1	RF power output	2.1046	PASS
2	Effective Isotropic Radiated power	24.232(c)	PASS
3	Occupied Bandwidth	2.1049	PASS
4	Band Edge Compliance	2.1051 /24.238(a)	PASS
5	Peak-to-Average Power Ratio	24.232/KDB 971168 D01(5.7)	PASS
6	Frequency Stability	2.1055 / 24.235	PASS
7	Spurious Emissions at Antenna Terminals	2.1051 / 24.238(a)	PASS
8	Radiates Spurious Emission	2.1053 / 24.238(a)	PASS
Note: PASS: The EUT complies with the essential requirements in the standard. FAIL: The EUT does not comply with the essential requirements in the standard.			
Date of Testing: July 22, 2019~ August 12, 2019			



1. Test Laboratory

1.1. Notes of the test report

This report shall not be reproduced in full or partial, without the written approval of **TA technology (shanghai) co., Ltd.** The results documented in this report apply only to the tested sample, under the conditions and modes of operation as described herein. Measurement Uncertainties were not taken into account and are published for informational purposes only. This report is written to support regulatory compliance of the applicable standards stated above.

1.2. Test facility

FCC (Designation number: CN1179, Test Firm Registration Number: 446626)

TA Technology (Shanghai) Co., Ltd. has been listed on the US Federal Communications Commission list of test facilities recognized to perform electromagnetic emissions measurements.

IC (recognition number is 8510A)

TA Technology (Shanghai) Co., Ltd. has been listed by industry Canada to perform electromagnetic emission measurement.

VCCI (recognition number is C-4595, T-2154, R-4113, G-10766)

TA Technology (Shanghai) Co., Ltd. has been listed by industry Japan to perform electromagnetic emission measurement.

A2LA (Certificate Number: 3857.01)

TA Technology (Shanghai) Co., Ltd. has been listed by American Association for Laboratory Accreditation to perform electromagnetic emission measurement.



1.3. Testing Location

Company: TA Technology (Shanghai) Co., Ltd.
Address: No.145, Jintang Rd, Tangzhen Industry Park, Pudong
City: Shanghai
Post code: 201201
Country: P. R. China
Contact: Xu Kai
Telephone: +86-021-50791141/2/3
Fax: +86-021-50791141/2/3-8000
Website: <http://www.ta-shanghai.com>
E-mail: xukai@ta-shanghai.com

2. General Description of Equipment under Test

Client Information

Applicant	Xiaomi Communications Co., Ltd.
Applicant address	The Rainbow City of China Resources,NO.68,Qinghe Middle Street,Haidian District,Beijing,China
Manufacturer	Xiaomi Communications Co., Ltd.
Manufacturer address	The Rainbow City of China Resources,NO.68,Qinghe Middle Street,Haidian District,Beijing,China

General information

EUT Description			
Model	M1908C3IH		
IMEI	IMEI 1:866648040031378 IMEI 2:866648040031386		
Hardware Version	P2		
Software Version	MIUI 10		
Power Supply	Battery/AC adapter		
Antenna Type	PIFA Antenna		
Antenna Gain	-1.24dBi		
Test Mode(s)	GSM1900; WCDMA Band II; LTE Band 2;		
Test Modulation	(GSM)GMSK,8PSK; (WCDMA) BPSK, QPSK,16QAM; (LTE)QPSK,16QAM		
GPRS Multislot Class	33		
EGPRS Multislot Class	33		
HSDPA UE Category	24		
HSUPA UE Category	6		
DC-HSDPA UE Category	24		
LTE Category	4		
Maximum E.I.R.P	GSM 1900:	31.47dBm	
	WCDMA Band II:	21.55dBm	
	LTE Band 2:	21.35dBm	
Rated Power Supply Voltage	3.85V		
Extreme Voltage	Minimum: 3.4V Maximum: 4.4V		
Extreme Temperature	Lowest: 0°C Highest: +40°C		
Operating Frequency Range(s)	Band	Tx (MHz)	Rx (MHz)
	GSM1900	1850 ~ 1910	1930 ~ 1990
	WCDMA Band II	1850 ~ 1910	1930 ~ 1990
	LTE Band 2	1850 ~ 1910	1930 ~ 1990
EUT Accessory			



Adapter	Manufacturer: Jiangsu Chenyang Electron Co., Ltd. Model: MDY-09-EQ
Battery	Manufacturer: Sunwoda Electronic Co.,LTD Model: BN51
USB Cable 1	Manufacturer: LUXSHARE Precision Industry Co., Ltd. Model: L23312 100cm Cable, Shielded
USB Cable 2	Manufacturer: SU ZHOU KELI SCIENCE&TECHNOLOGY DEVELOPMENT CO.,LTD Model: K23312 100cm Cable, Shielded
<p>Note: 1. The information of the EUT is declared by the manufacturer. 2. There is more than one SIM and USB cable, each one should be applied throughout the compliance test respectively, and however, only the worst case (SIM 1/ USB cable 1) will be recorded in this report.</p>	

3. Applied Standards

According to the specifications of the manufacturer, it must comply with the requirements of the following standards:

FCC CFR47 Part 2 (2018)

FCC CFR 47 Part 24E (2018)

ANSI C63.26 (2015)

KDB 971168 D01 Power Meas License Digital Systems v03r01

4. Test Configuration

There is more than one SIM card slot, each one should be applied throughout the compliance test respectively, and however, only the worst case (SIM 1) will be recorded in this report.

Radiated measurements are performed by rotating the EUT in three different orthogonal test planes. EUT stand-up position (Z axis), lie-down position (X, Y axis). Receiver antenna polarization (horizontal and vertical), the worst emission was found in position (X axis, horizontal polarization) and the worst case was recorded.

All mode and data rates and positions and RB size and modulations were investigated. Subsequently, only the worst case emissions are reported.

The following testing in GSM/WCDMA/LTE is set based on the maximum RF Output Power.

Test modes are chosen to be reported as the worst case configuration below:

Test items	Modes/Modulation	
	GSM 1900	WCDMA Band II
RF power output	GSM GPRS EGPRS	RMC HSDPA/HSUPA DC-HSDPA
Effective Isotropic Radiated power	GSM GPRS(1Tx slot) EGPRS(1Tx slot)	RMC
Occupied Bandwidth	GSM GPRS(1Tx slot) EGPRS(1Tx slot)	RMC
Band Edge Compliance	GSM GPRS(1Tx slot) EGPRS(1Tx slot)	RMC
Peak-to-Average Power Ratio	GSM GPRS(1Tx slot) EGPRS(1Tx slot)	RMC
Frequency Stability	GSM GPRS(1Tx slot) EGPRS(1Tx slot)	RMC
Spurious Emissions at Antenna Terminals	GSM	RMC
Radiates Spurious Emission	GSM	RMC

Test modes are chosen to be reported as the worst case configuration below for LTE Band 2:

Test items	Bandwidth (MHz)						Modulation		RB			Test Channel		
	1.4	3	5	10	15	20	QPSK	16QAM	1	50%	100%	L	M	H
RF power output	O	O	O	O	O	O	O	O	O	O	O	O	O	O
Effective Isotropic Radiated power	O	O	O	O	O	O	O	O	O	O	O	O	O	O
Occupied Bandwidth	O	O	O	O	O	O	O	O	-	-	O	O	O	O
Band Edge Compliance	O	O	O	O	O	O	O	O	O	-	O	O	-	O
Peak-to-Average Power Ratio	O	O	O	O	O	O	O	O	-	-	O	O	O	O
Frequency Stability	O	O	O	O	O	O	O	O	O	O	O	O	O	O
Conducted Spurious Emissions	O	O	O	O	O	O	O	-	O	-	-	O	O	O
Radiates Spurious Emission	O	-	O	-	-	O	O	-	O	-	-	O	O	O
Note	1. The mark "O" means that this configuration is chosen for testing. 2. The mark "-" means that this configuration is not testing.													

5. Test Case Results

5.1. RF Power Output

Ambient condition

Temperature	Relative humidity	Pressure
23°C ~25°C	45%~50%	101.5kPa

Methods of Measurement

During the process of the testing, The EUT is controlled by the Base Station Simulator to ensure max power transmission and proper modulation.

Test Setup

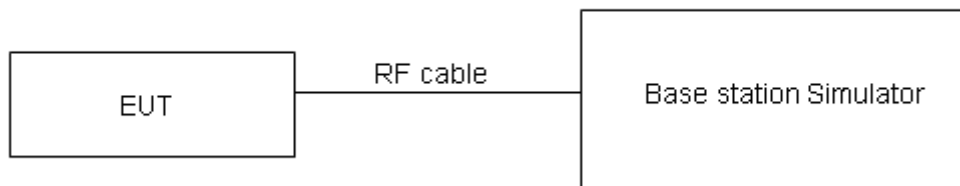

The loss between RF output port of the EUT and the input port of the tester has been taken into consideration.

Limits

No specific RF power output requirements in part 2.1046.

Measurement Uncertainty

The assessed measurement uncertainty to ensure 95% confidence level for the normal distribution is with the coverage factor $k = 2$, $U = 0.4$ dB.

Test Results

GSM 1900		Conducted Power(dBm)		
		Channel 512	Channel 661	Channel 810
		1850.2(MHz)	1880(MHz)	1909.8(MHz)
GSM	Results	29.81	29.61	29.43
GPRS (GMSK)	1TXslot	29.79	29.55	29.39
	2TXslots	27.38	27.32	27.06
	3TXslots	25.74	25.79	25.51
	4TXslots	24.64	24.71	24.38
EGPRS (8PSK)	1TXslot	25.56	25.46	25.38
	2TXslots	23.02	22.82	22.69
	3TXslots	21.23	21.21	21.07
	4TXslots	20.01	19.89	19.71

WCDMA Band II		Conducted Power(dBm)		
		Channel 9262	Channel 9400	Channel 9538
		1852.4(MHz)	1880(MHz)	1907.6(MHz)
RMC		22.62	22.69	22.64
HSDPA	Sub - Test 1	22.04	22.11	22.06
	Sub - Test 2	22.03	22.10	22.05
	Sub - Test 3	21.52	21.59	21.54
	Sub - Test 4	21.51	21.58	21.53
HSUPA	Sub - Test 1	22.00	22.07	22.02
	Sub - Test 2	20.99	21.06	21.01
	Sub - Test 3	21.47	21.55	21.50
	Sub - Test 4	20.96	21.04	20.99
	Sub - Test 5	21.95	22.03	21.98
DC-HSDPA	Sub - Test 1	21.96	22.05	21.98
	Sub - Test 2	21.95	22.04	21.97
	Sub - Test 3	21.53	21.53	21.48
	Sub - Test 4	21.52	21.52	21.47

LTE FDD Band 2				Conducted Power(dBm)		
Bandwidth	Modulation	RB size	RB offset	Channel/Frequency (MHz)		
				18607/1850.7	18900/1880	19193/1909.3
1.4MHz	QPSK	1	0	23.19	23.21	22.92
		1	2	23.37	23.39	23.28
		1	5	22.89	23.17	22.82
		3	0	23.30	23.14	23.21
		3	2	23.24	23.13	23.19
		3	3	23.22	23.31	23.36
		6	0	22.21	22.25	22.21
	16QAM	1	0	22.14	22.13	21.68
		1	2	22.24	22.04	22.21
		1	5	22.10	21.75	21.98
		3	0	22.28	22.13	22.25
		3	2	22.27	22.10	22.18
		3	3	22.19	22.20	22.35
		6	0	21.24	21.06	21.32
Bandwidth	Modulation	RB size	RB offset	Channel/Frequency (MHz)		
				18615/1851.5	18900/1880	19185/1908.5
3MHz	QPSK	1	0	23.17	23.19	22.99
		1	7	23.45	23.32	23.20
		1	14	22.92	23.06	22.89
		8	0	22.29	22.14	22.17
		8	4	22.29	22.16	22.20
		8	7	22.21	22.31	22.45
		15	0	22.28	22.33	22.22
	16QAM	1	0	22.19	22.13	21.80
		1	7	22.13	21.94	22.12
		1	14	21.96	21.92	21.97
		8	0	21.15	20.98	21.36
		8	4	21.30	21.03	21.32
		8	7	21.28	21.20	21.33
		15	0	21.17	21.11	21.26
Bandwidth	Modulation	RB size	RB offset	Channel/Frequency (MHz)		
				18625/1852.5	18900/1880	19175/1907.5
5MHz	QPSK	1	0	23.23	23.22	23.01
		1	13	23.30	23.38	23.21
		1	24	22.99	23.14	22.94
		12	0	22.24	22.23	22.13
		12	6	22.16	22.14	22.34
		12	13	22.33	22.33	22.44
		25	0	22.29	22.28	22.35



	16QAM	1	0	22.28	22.06	21.63
		1	13	22.29	22.11	22.14
		1	24	22.00	21.86	21.89
		12	0	21.16	21.10	21.32
		12	6	21.17	21.18	21.34
		12	13	21.15	21.28	21.46
		25	0	21.15	21.23	21.35
Bandwidth	Modulation	RB size	RB offset	Channel/Frequency (MHz)		
				18650/1855	18900/1880	19150/1905
10MHz	QPSK	1	0	23.29	23.10	22.99
		1	25	23.41	23.49	23.29
		1	49	22.91	23.18	22.89
		25	0	22.28	22.24	22.29
		25	13	22.29	22.13	22.26
		25	25	22.19	22.17	22.31
		50	0	22.28	22.26	22.34
	16QAM	1	0	22.29	22.10	21.80
		1	25	22.20	21.92	22.09
		1	49	22.10	21.86	21.87
		25	0	21.16	20.97	21.35
		25	13	21.16	21.02	21.29
		25	25	21.20	21.22	21.30
		50	0	21.21	21.09	21.23
Bandwidth	Modulation	RB size	RB offset	Channel/Frequency (MHz)		
				18675/1857.5	18900/1880	19125/1902.5
15MHz	QPSK	1	0	23.31	23.08	23.01
		1	38	23.27	23.45	23.12
		1	74	22.98	23.09	22.91
		36	0	22.30	22.21	22.18
		36	18	22.28	22.14	22.32
		36	39	22.29	22.29	22.41
		75	0	22.25	22.24	22.23
	16QAM	1	0	22.24	22.08	21.72
		1	38	22.28	22.11	22.15
		1	74	22.07	21.81	22.00
		36	0	21.11	21.10	21.33
		36	18	21.29	21.13	21.28
		36	39	21.26	21.24	21.45
		75	0	21.10	21.16	21.22
Bandwidth	Modulation	RB size	RB offset	Channel/Frequency (MHz)		
				18700/1860	18900/1880	19100/1900
20MHz	QPSK	1	0	23.34	23.22	23.06
		1	50	23.47	23.50	23.31



		1	99	23.05	23.24	22.98
		50	0	22.34	22.29	22.31
		50	25	22.34	22.30	22.38
		50	50	22.36	22.34	22.46
		100	0	22.35	22.35	22.39
	16QAM	1	0	22.31	22.17	21.82
		1	50	22.29	22.12	22.27
		1	99	22.15	21.95	22.06
		50	0	21.29	21.15	21.41
		50	25	21.31	21.22	21.35
		50	50	21.30	21.31	21.47
		100	0	21.26	21.24	21.36

5.2. Effective Isotropic Radiated Power

Ambient condition

Temperature	Relative humidity	Pressure
23°C ~25°C	45%~50%	101.5kPa

Methods of Measurement

The testing follows FCC KDB 971168 v03r01 Section 5.8 and ANSI C63.26 (2015).

- a) Connect the equipment as illustrated. Mount the equipment with the manufacturer specified antenna in a vertical orientation on a manufacturer specified mounting surface located on a non-conducting rotating platform of a RF anechoic chamber (preferred) or a standard radiation site.
- b) Key the transmitter, then rotate the EUT 360° azimuthally and record spectrum analyzer power level (LVL) measurements at angular increments that are sufficiently small to permit resolution of all peaks. If a standard radiation test site is used, raise and lower the test antenna to obtain a maximum reading at each angular increment. (Note: several batteries may be needed to offset the effect of battery voltage droop, which should not exceed 5% of the manufactured specified battery voltage during transmission).
- c) Replace the transmitter under test with a vertically polarized half-wave dipole (or an antenna whose gain is known relative to an ideal half-wave dipole). The center of the antenna should be at the same location as the center of the antenna under test.
- d) Connect the antenna to a signal generator with a known output power and record the path loss (in dB) as LOSS. If a standard radiation test site is used, raise and lower the test antenna to obtain a maximum reading. $LOSS = \text{Generator Output Power (dBm)} - \text{Analyzer reading (dBm)}$
- e) Determine the effective radiated output power at each angular position from the readings in steps b) and d) using the following equation: $ERP \text{ (dBm)} = \text{LVL (dBm)} + \text{LOSS (dB)}$
- f) The maximum ERP is the maximum value determined in the preceding step.
- g) When calculating ERP, in addition to knowing the antenna radiation and matching characteristics, it is necessary to know the loss values of all elements (e.g. transmission line attenuation, mismatches, filters, combiners) interposed between the point where transmitter output power is measured, and the point where power is applied to the antenna. ERP can then be calculated as follows:
 $EIRP \text{ (dBm)} = \text{Output Power (dBm)} - \text{Losses (dB)} + \text{Antenna Gain (dBi)}$
where: dBd refers to gain relative to an ideal dipole.
 $EIRP \text{ (dBm)} = \text{ERP (dBm)} + 2.15 \text{ (dB.)}$

The RB allocation refers to section 5.1, using the maximum output power configuration.

Test setup

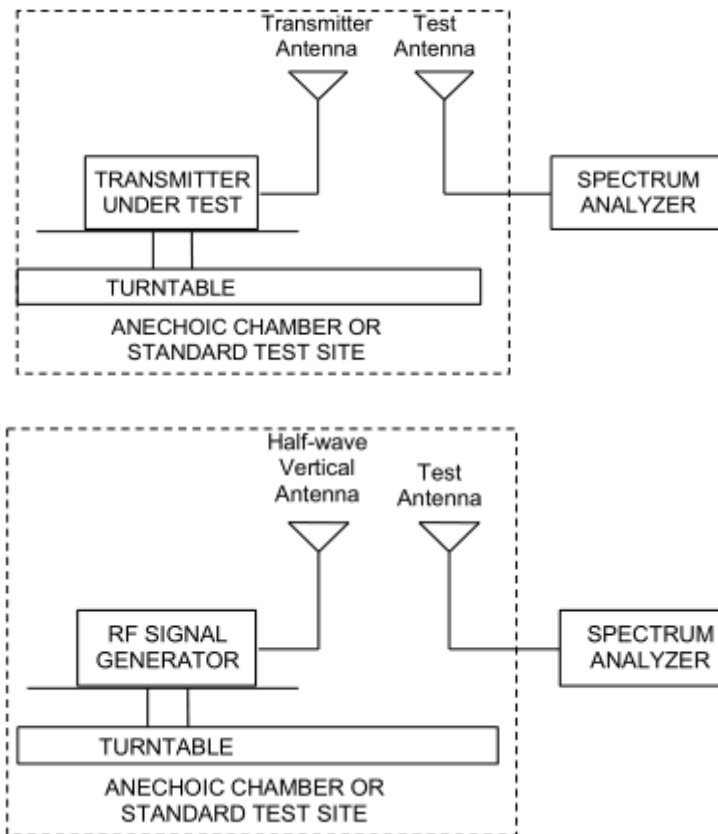

Limits

Rule Part 24.232(c) Mobile and portable stations are limited to 2 watts EIRP.

Rule Part 24.232(e) Peak transmit power must be measured over any interval of continuous transmission using instrumentation calibrated in terms of an rms-equivalent voltage.

Limit	$\leq 2 \text{ W}$ (33 dBm)
-------	-----------------------------

Measurement Uncertainty

The assessed measurement uncertainty to ensure 95% confidence level for the normal distribution is with the coverage factor $k = 2$, $U = 1.19 \text{ dB}$

Test Results:

The measurement is performed for both of horizontal and vertical antenna Polarization, and only the data of worst mode is recorded in this report.

Mode	Channel	Frequency (MHz)	Polarization	EIRP (dBm)	Limit (dBm)	Conclusion
GSM 1900	Low	1850.2	Horizontal	31.47	33	Pass
	Mid	1880	Horizontal	30.59	33	Pass
	High	1909.8	Horizontal	29.30	33	Pass
GPRS 1900	Low	1850.2	Horizontal	27.40	33	Pass
	Mid	1880	Horizontal	26.88	33	Pass
	High	1909.8	Horizontal	26.12	33	Pass
EGPRS 1900	Low	1850.2	Horizontal	26.42	33	Pass
	Mid	1880	Horizontal	25.84	33	Pass
	High	1909.8	Horizontal	24.56	33	Pass
WCDMA Band II	Low	1852.4	Horizontal	21.55	33	Pass
	Mid	1880	Horizontal	21.41	33	Pass
	High	1907.6	Horizontal	21.38	33	Pass

LTE Band 2						
bandwidth	Channel	Frequency (MHz)	Polarization	EIRP (dBm)	Limit (dBm)	Conclusion
1.4 MHz (QPSK)	Low	1850.7	Horizontal	20.95	33	Pass
	Mid	1880	Horizontal	20.91	33	Pass
	High	1909.3	Horizontal	20.76	33	Pass
3 MHz (QPSK)	Low	1851.5	Horizontal	20.96	33	Pass
	Mid	1880	Horizontal	21.26	33	Pass
	High	1908.5	Horizontal	20.97	33	Pass
5 MHz (QPSK)	Low	1852.5	Horizontal	20.87	33	Pass
	Mid	1880	Horizontal	21.15	33	Pass
	High	1907.5	Horizontal	20.88	33	Pass
10 MHz (QPSK)	Low	1855	Horizontal	21.35	33	Pass
	Mid	1880	Horizontal	21.14	33	Pass
	High	1905	Horizontal	20.99	33	Pass
15 MHz (QPSK)	Low	1857.5	Horizontal	20.79	33	Pass
	Mid	1880	Horizontal	20.83	33	Pass
	High	1902.5	Horizontal	21.14	33	Pass
20 MHz (QPSK)	Low	1860	Horizontal	21.34	33	Pass
	Mid	1880	Horizontal	20.86	33	Pass
	High	1900	Horizontal	20.63	33	Pass
1.4 MHz (16QAM)	Low	1850.7	Horizontal	20.42	33	Pass
	Mid	1880	Horizontal	20.37	33	Pass
	High	1909.3	Horizontal	20.19	33	Pass
3 MHz (16QAM)	Low	1851.5	Horizontal	20.44	33	Pass
	Mid	1880	Horizontal	20.75	33	Pass
	High	1908.5	Horizontal	20.44	33	Pass
5 MHz (16QAM)	Low	1852.5	Horizontal	20.30	33	Pass
	Mid	1880	Horizontal	20.59	33	Pass
	High	1907.5	Horizontal	20.37	33	Pass
10 MHz (16QAM)	Low	1855	Horizontal	20.80	33	Pass
	Mid	1880	Horizontal	20.56	33	Pass
	High	1905	Horizontal	20.39	33	Pass
15 MHz (16QAM)	Low	1857.5	Horizontal	20.26	33	Pass
	Mid	1880	Horizontal	20.32	33	Pass
	High	1902.5	Horizontal	20.57	33	Pass
20 MHz (16QAM)	Low	1860	Horizontal	20.78	33	Pass
	Mid	1880	Horizontal	20.32	33	Pass
	High	1900	Horizontal	20.11	33	Pass
1.4 MHz (64QAM)	Low	1850.7	Horizontal	19.89	33	Pass
	Mid	1880	Horizontal	19.80	33	Pass
	High	1909.3	Horizontal	19.63	33	Pass



LTE Band 2						
bandwidth	Channel	Frequency (MHz)	Polarization	EIRP (dBm)	Limit (dBm)	Conclusion
3 MHz (64QAM)	Low	1851.5	Horizontal	19.93	33	Pass
	Mid	1880	Horizontal	20.20	33	Pass
	High	1908.5	Horizontal	19.86	33	Pass
5 MHz (64QAM)	Low	1852.5	Horizontal	19.70	33	Pass
	Mid	1880	Horizontal	20.06	33	Pass
	High	1907.5	Horizontal	19.86	33	Pass
10 MHz (64QAM)	Low	1855	Horizontal	20.23	33	Pass
	Mid	1880	Horizontal	20.00	33	Pass
	High	1905	Horizontal	19.85	33	Pass
15 MHz (64QAM)	Low	1857.5	Horizontal	19.74	33	Pass
	Mid	1880	Horizontal	19.81	33	Pass
	High	1902.5	Horizontal	20.04	33	Pass
20 MHz (64QAM)	Low	1860	Horizontal	20.24	33	Pass
	Mid	1880	Horizontal	19.75	33	Pass
	High	1900	Horizontal	19.59	33	Pass

5.3.Occupied Bandwidth

Ambient condition

Temperature	Relative humidity	Pressure
23°C ~25°C	45%~50%	101.5kPa

Method of Measurement

The EUT was connected to Spectrum Analyzer and Base Station Simulator via power Splitter. The occupied bandwidth is measured using spectrum analyzer.

RBW is set to 3kHz, VBW is set to 10kHz for GSM 1900,

RBW is set to 51kHz, VBW is set to 160kHz for WCDMA Band II,

RBW is set to 51kHz, VBW is set to 160kHz for LTE Band 2 (1.4MHz),

RBW is set to 100kHz,VBW is set to 300kHz for LTE Band 2 (3MHz/5MHz),

RBW is set to 300kHz,VBW is set to 1MHz for LTE Band 2 (10MHz/15MHz/20MHz).

99% power and -26dBc occupied bandwidths are recorded. Spectrum analyzer plots are included on the following pages.

Test Setup

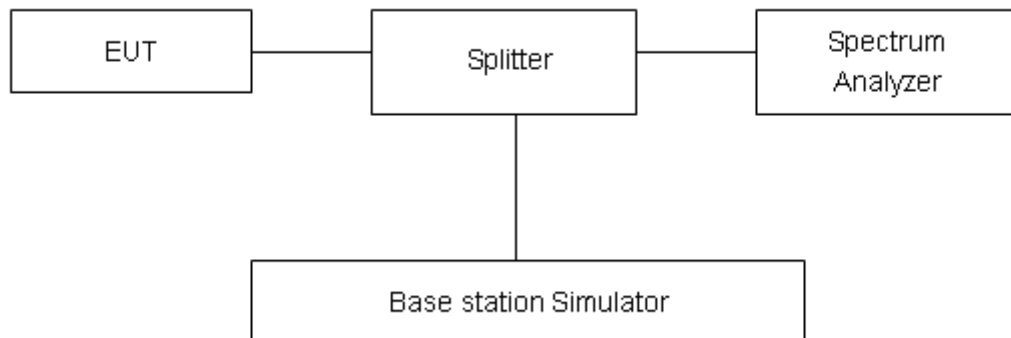

Limits

No specific occupied bandwidth requirements in part 2.1049.

Measurement Uncertainty

The assessed measurement uncertainty to ensure 95% confidence level for the normal distribution is with the coverage factor $k = 2$, $U = 624\text{Hz}$.

Test Result

Mode	Channel	Frequency (MHz)	99% Power Bandwidth (MHz)	-26dBc Bandwidth(MHz)
GSM 1900 (GSM)	512	1850.2	0.24637	0.3094
	661	1880.0	0.24443	0.3083
	810	1909.8	0.24495	0.3061
GPRS 1900 (GMSK)	512	1850.2	0.24626	0.3132
	661	1880.0	0.24462	0.3069
	810	1909.8	0.24575	0.3192
EGPRS 1900 (8-PSK)	512	1850.2	0.24332	0.3083
	661	1880.0	0.24903	0.3088
	810	1909.8	0.24471	0.3257
WCDMA Band II (RMC)	9262	1852.4	4.1168	4.673
	9400	1880	4.1246	4.706
	9538	1907.6	4.1200	4.669

LTE Band 2					
Modulation	Bandwidth (MHz)	Channel	Frequency (MHz)	99% Power Bandwidth(MHz)	-26dBc Bandwidth(MHz)
QPSK	1.4	18607	1850.7	1.1293	1.381
		18900	1880.0	1.1358	1.353
		19193	1909.3	1.1285	1.367
	3	18615	1851.5	2.7443	3.068
		18900	1880	2.7424	3.052
		19185	1908.5	2.7415	3.068
	5	18625	1852.5	4.5157	5.015
		18900	1880	4.5094	5.001
		19175	1907.5	4.5255	5.014
	10	18650	1855	9.0421	10.170
		18900	1880	9.0137	10.040
		19150	1905	9.0505	10.040
	15	18675	1857.5	13.4080	14.670



		18900	1880	13.4430	14.800	
		19125	1902.5	13.4650	14.870	
		20	18700	1860	17.8700	19.110
			18900	1880	17.8820	19.210
			19100	1900	17.9170	19.360
16QAM	1.4	18607	1850.7	1.1224	1.325	
		18900	1880.0	1.1212	1.361	
		19193	1909.3	1.1254	1.353	
	3	18615	1851.5	2.7376	3.049	
		18900	1880	2.7304	3.057	
		19185	1908.5	2.7379	3.025	
	5	18625	1852.5	4.5410	5.023	
		18900	1880	4.5325	5.018	
		19175	1907.5	4.5109	5.022	
	10	18650	1855	9.0168	9.981	
		18900	1880	9.0128	10.050	
		19150	1905	9.0174	10.040	
	15	18675	1857.5	13.4520	14.700	
		18900	1880	13.4800	14.800	
		19125	1902.5	13.4710	14.630	
	20	18700	1860	17.9200	19.330	
		18900	1880	17.8940	19.400	
		19100	1900	17.8760	19.320	
	64QAM	1.4	18607	1850.7	1.1215	1.324
			18900	1880.0	1.1192	1.357
			19193	1909.3	1.1271	1.340
3		18615	1851.5	2.7522	3.074	
		18900	1880	2.7403	3.073	
		19185	1908.5	2.7399	3.047	
5		18625	1852.5	4.5141	5.020	
		18900	1880	4.5372	5.039	
		19175	1907.5	4.5094	5.020	
10		18650	1855	9.0125	9.999	
		18900	1880	9.0287	10.030	



		19150	1905	9.0181	9.978
	15	18675	1857.5	13.4530	14.730
		18900	1880	13.4590	14.700
		19125	1902.5	13.4740	14.770
	20	18700	1860	17.8680	19.300
		18900	1880	17.8790	19.410
		19100	1900	17.9370	19.350

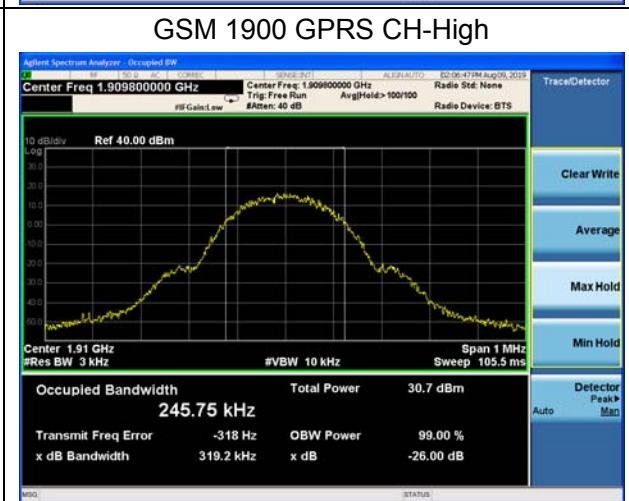
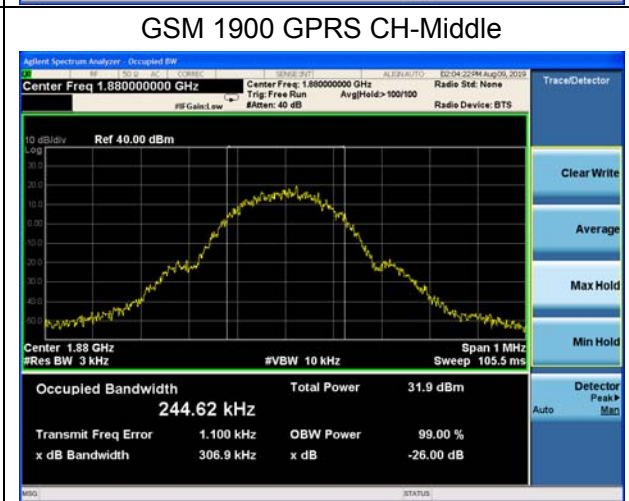
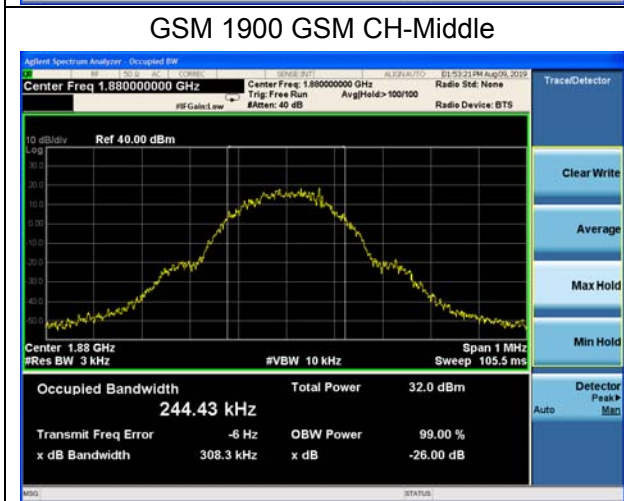
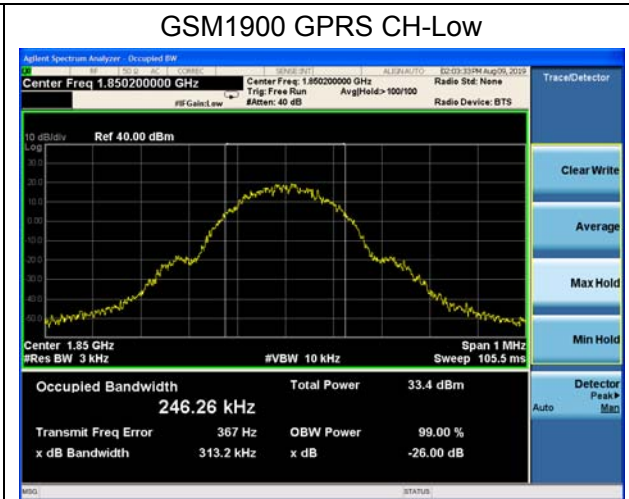

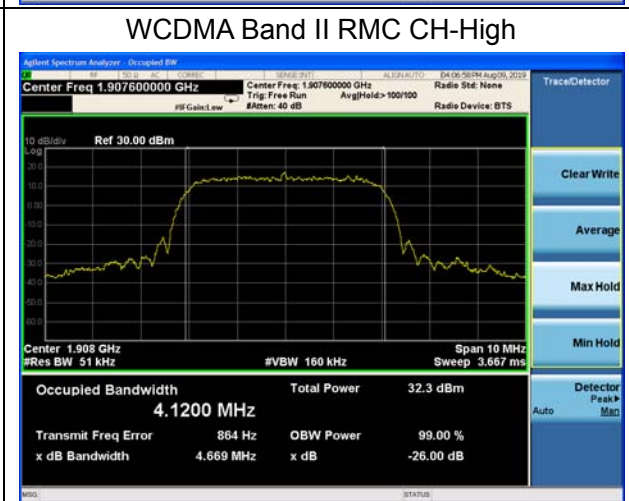
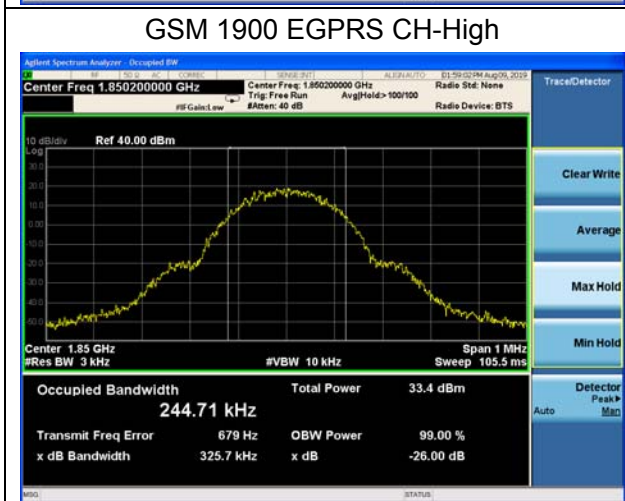
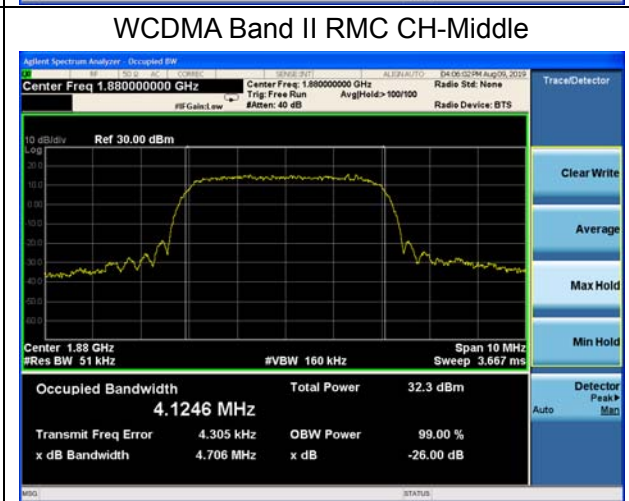
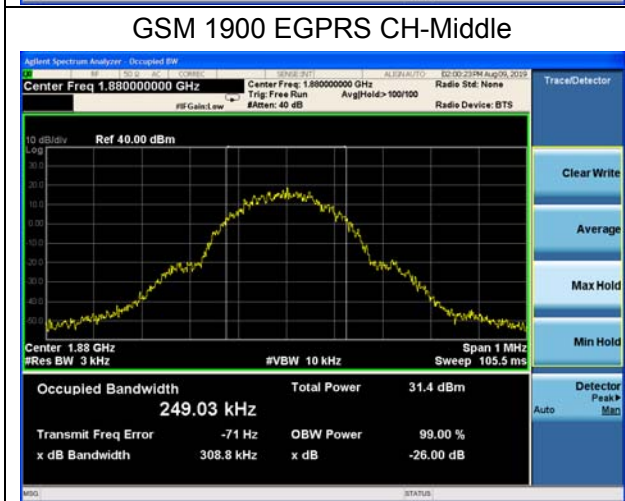
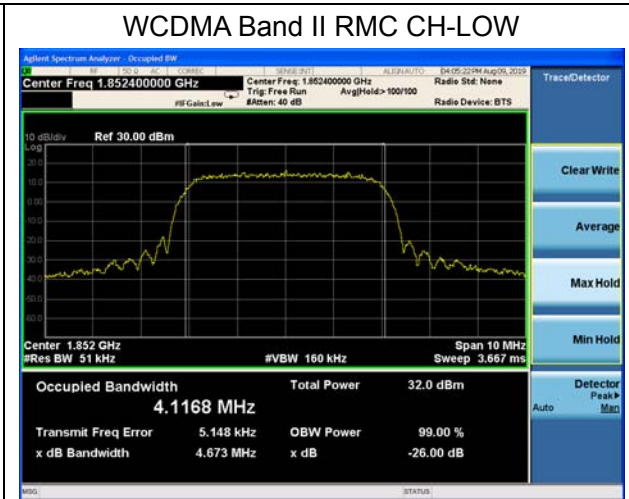
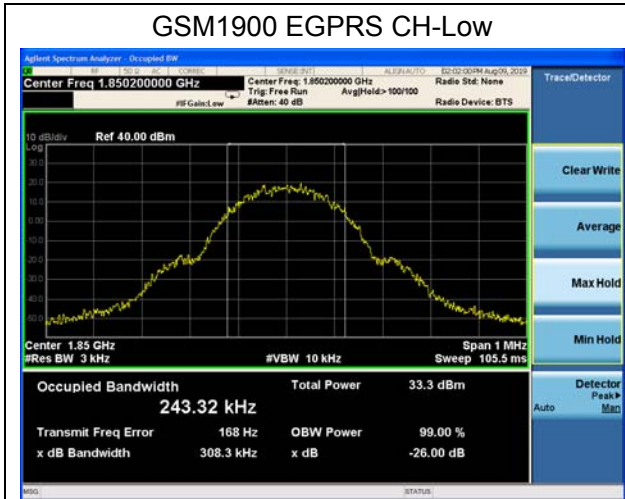

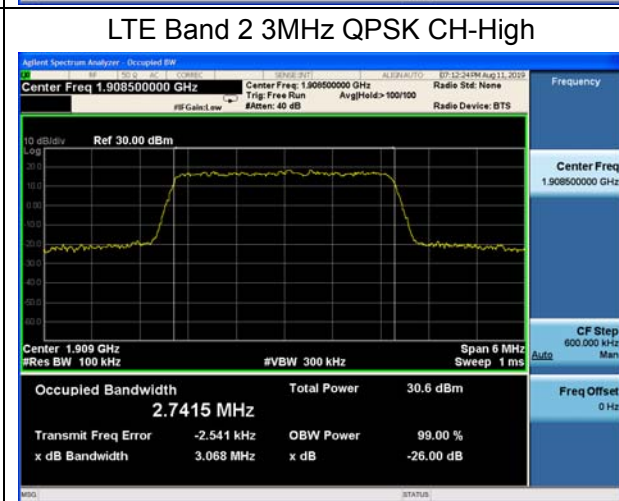
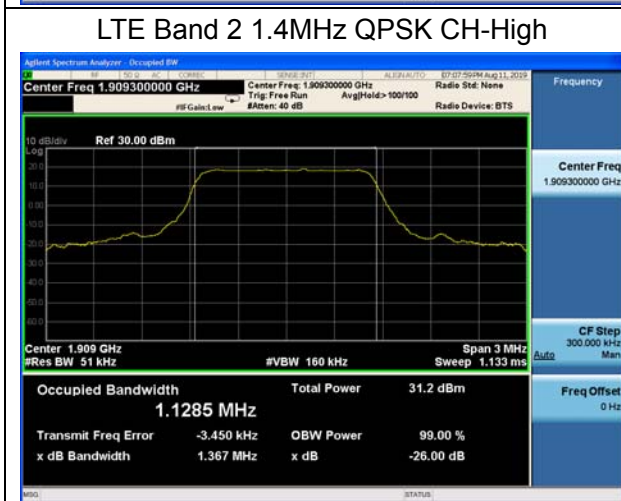
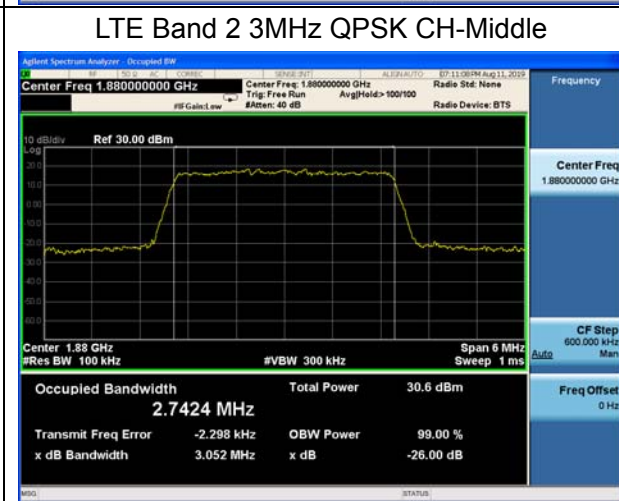
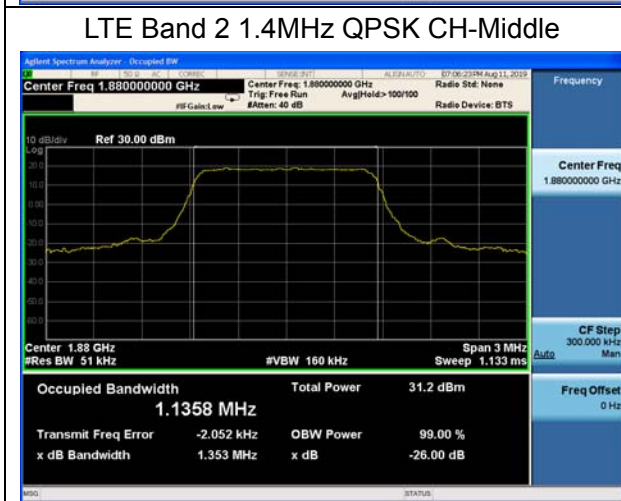
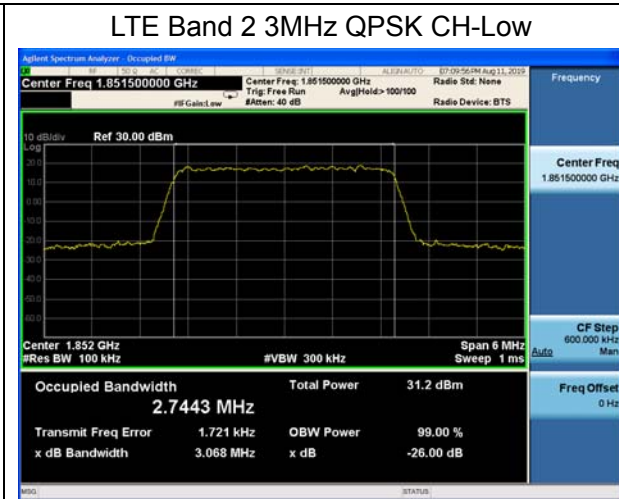
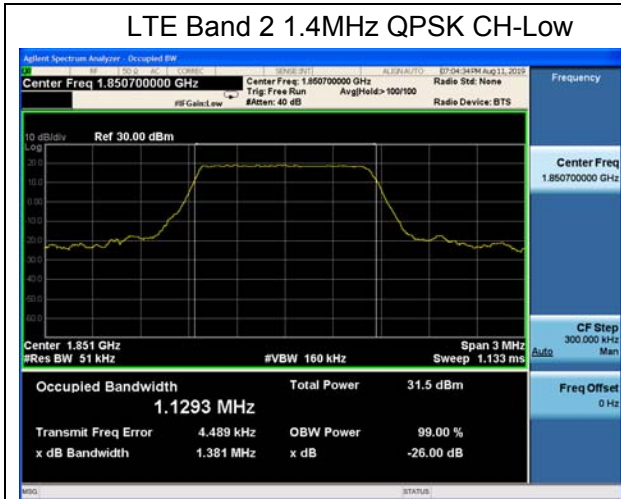

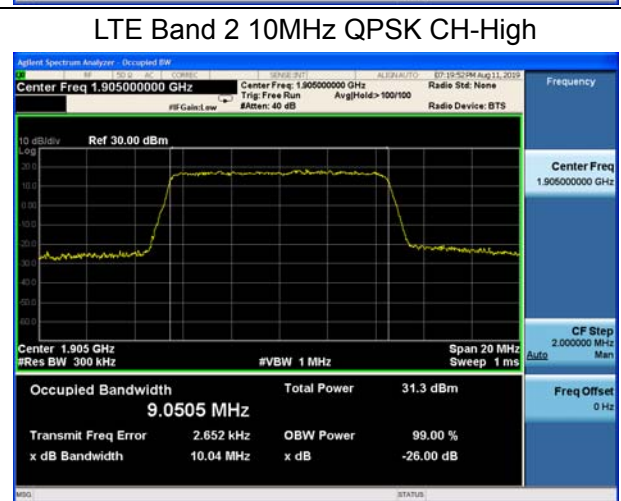
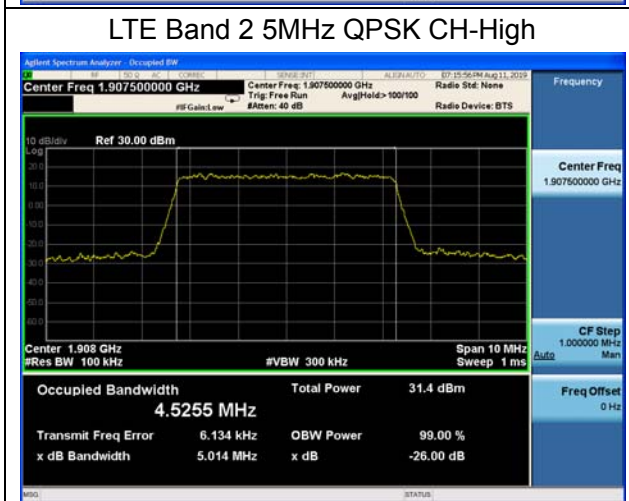
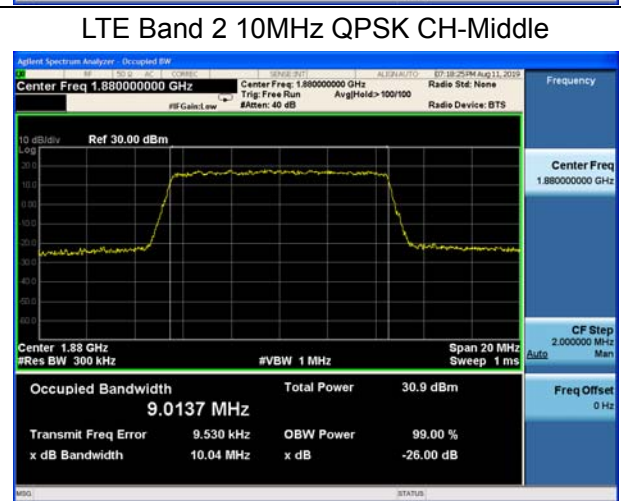
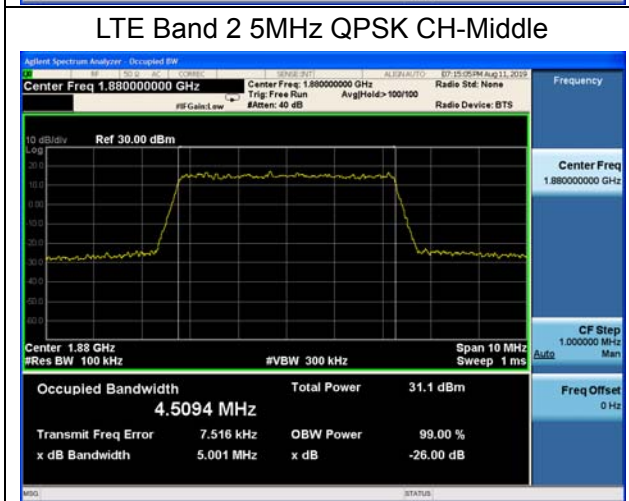
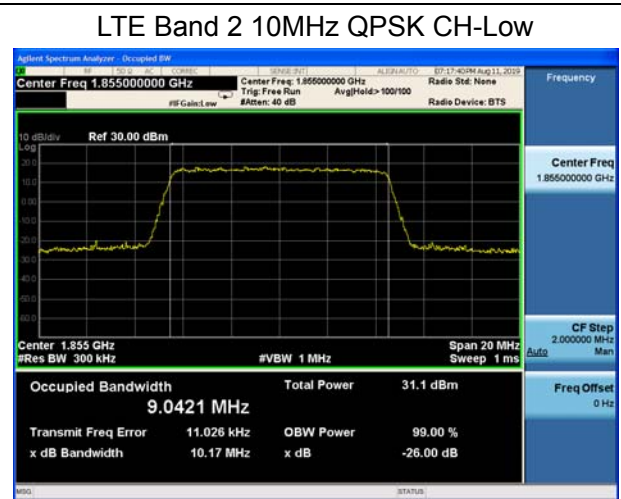
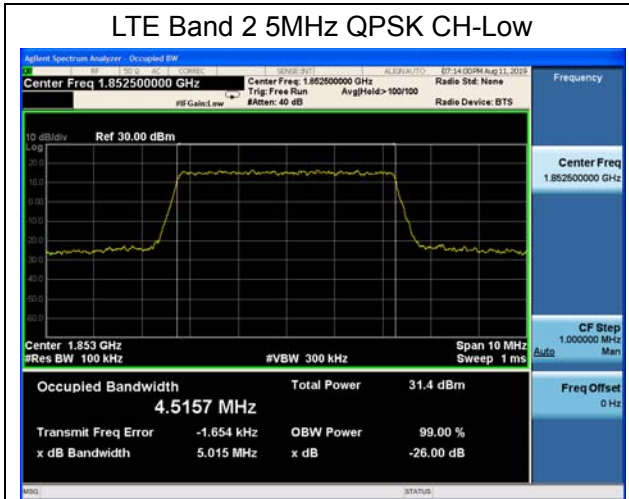

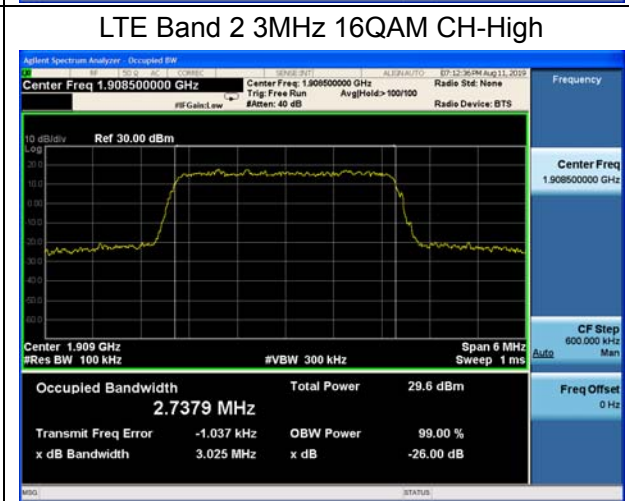
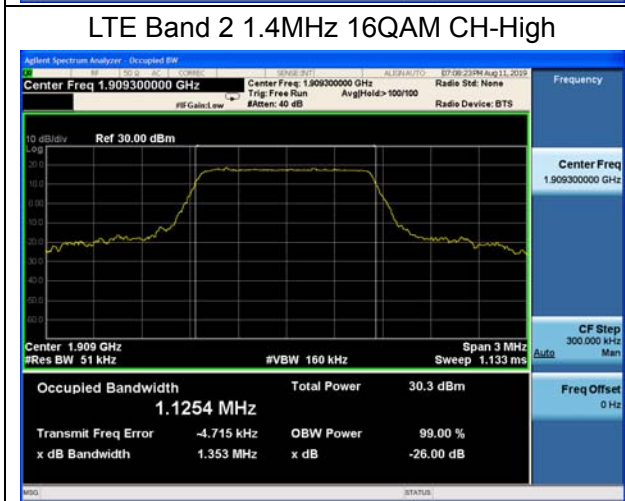
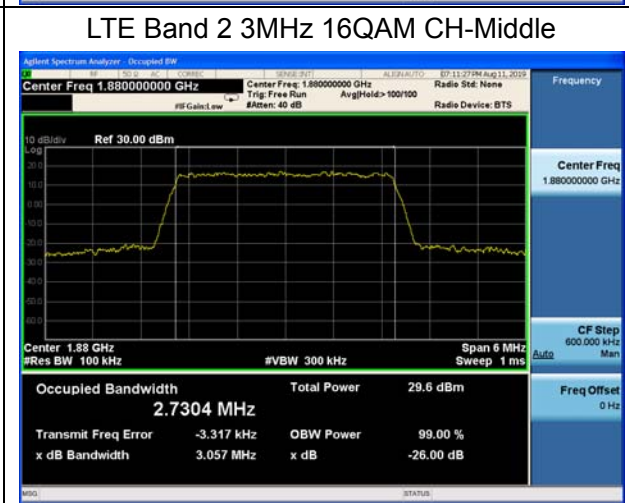
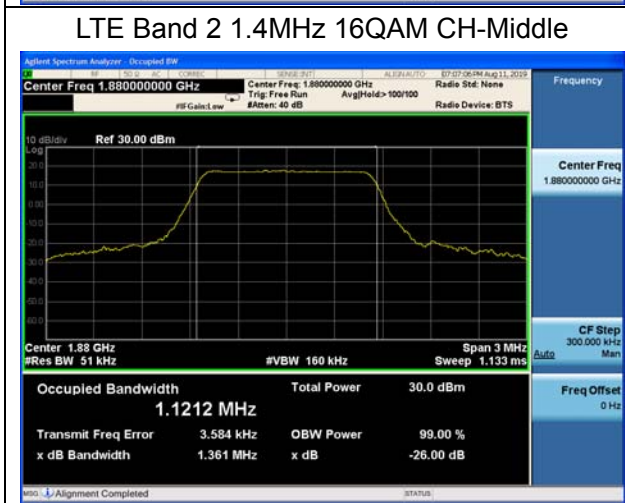
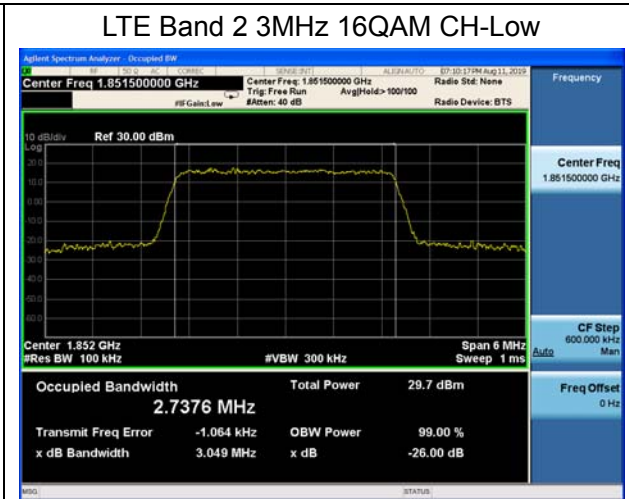
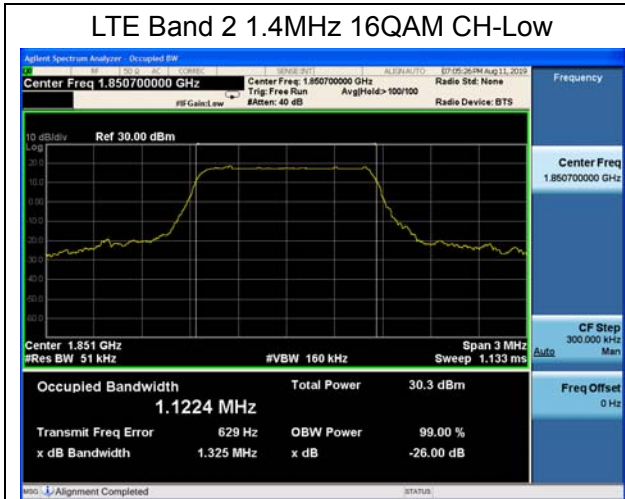

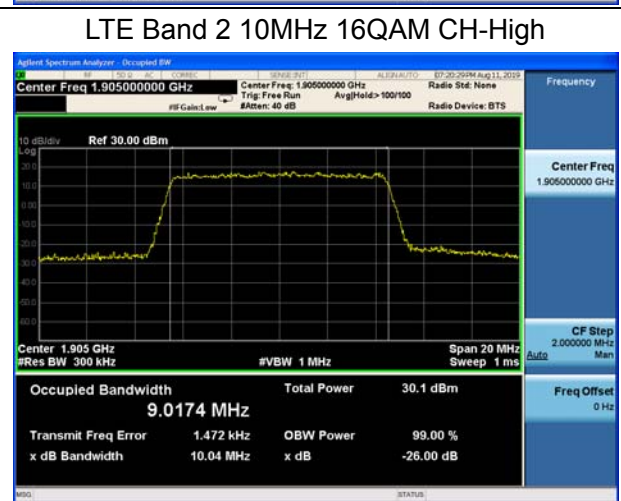
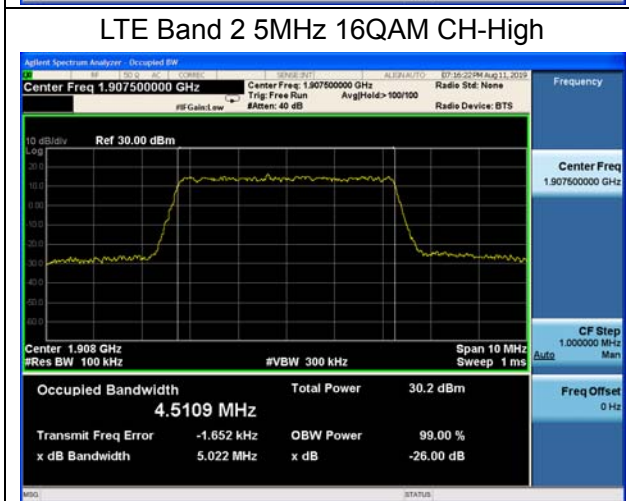
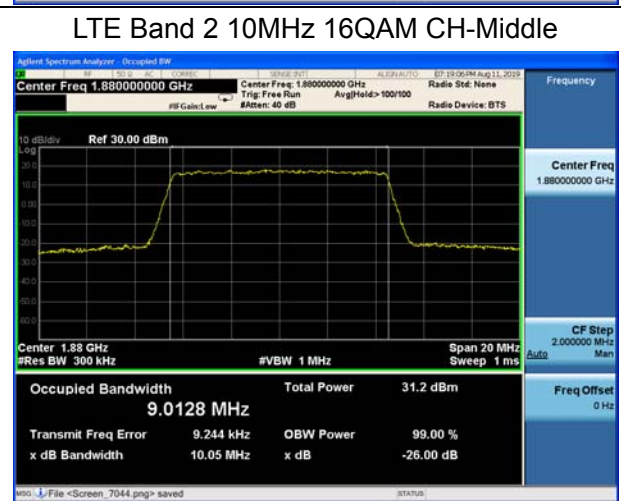
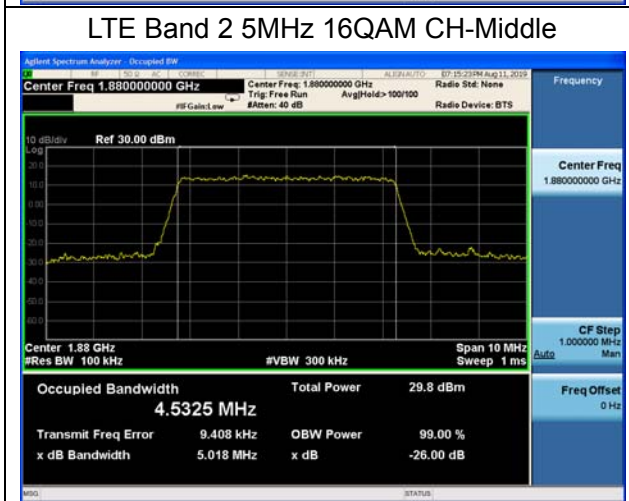
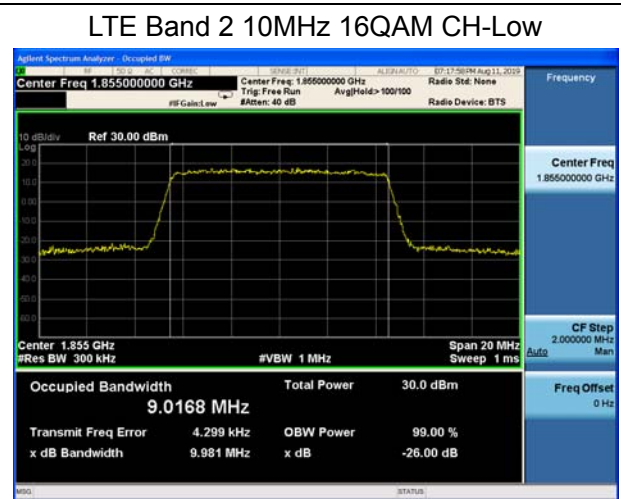
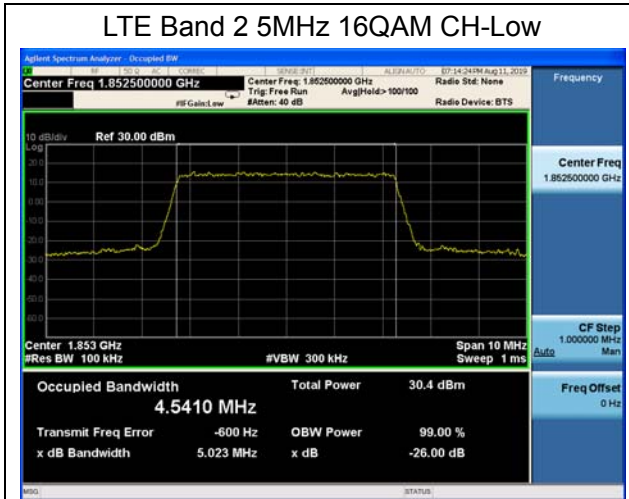



LTE Band 2 15MHz 16QAM CH-Low

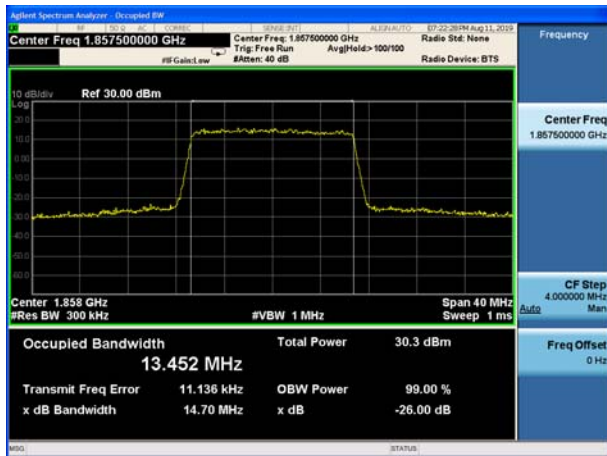

LTE Band 2 20MHz 16QAM CH-Low

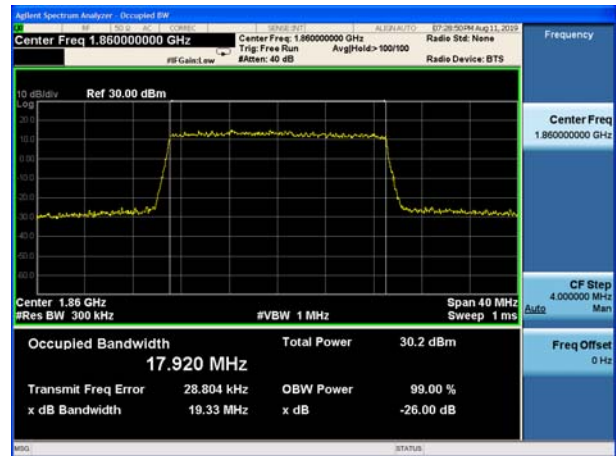

LTE Band 2 15MHz 16QAM CH-Middle

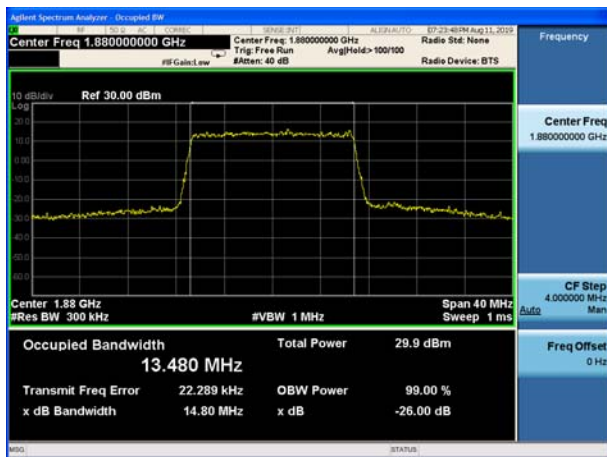

LTE Band 2 20MHz 16QAM CH-Middle



LTE Band 2 15MHz 16QAM CH-High

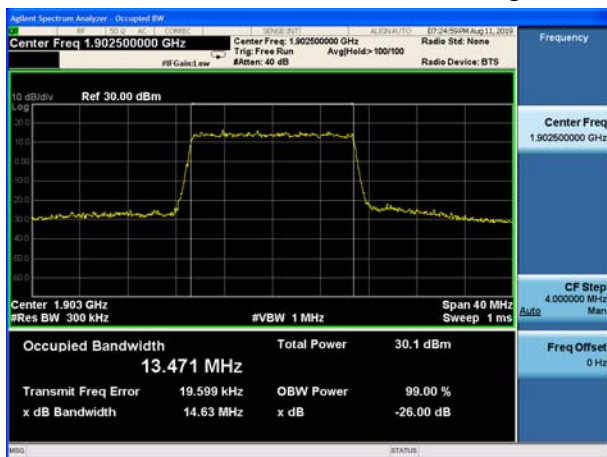

LTE Band 2 20MHz 16QAM CH-High

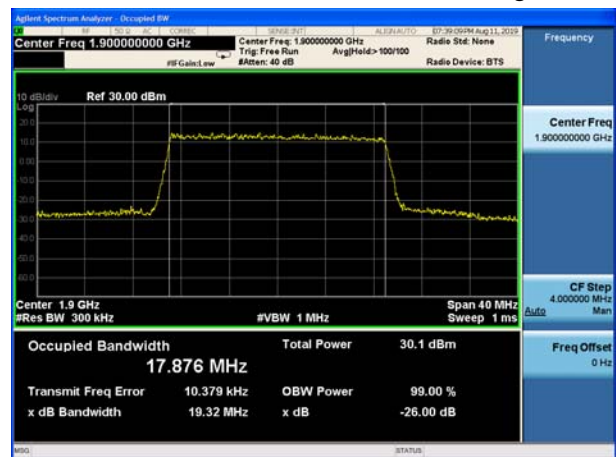

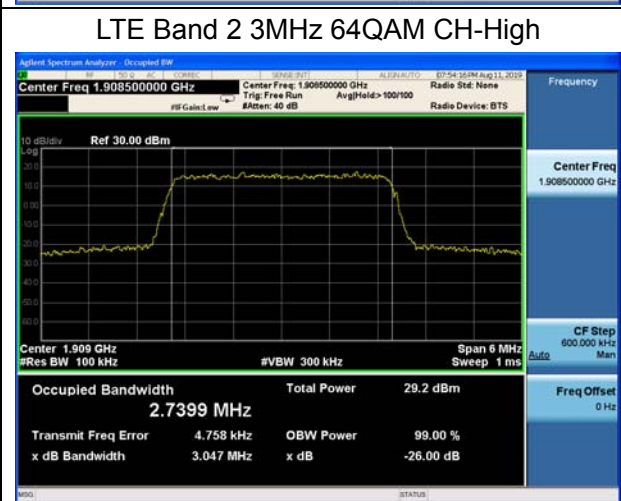
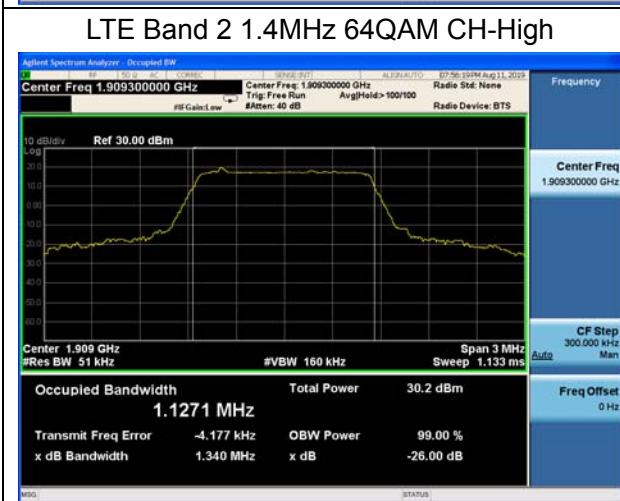
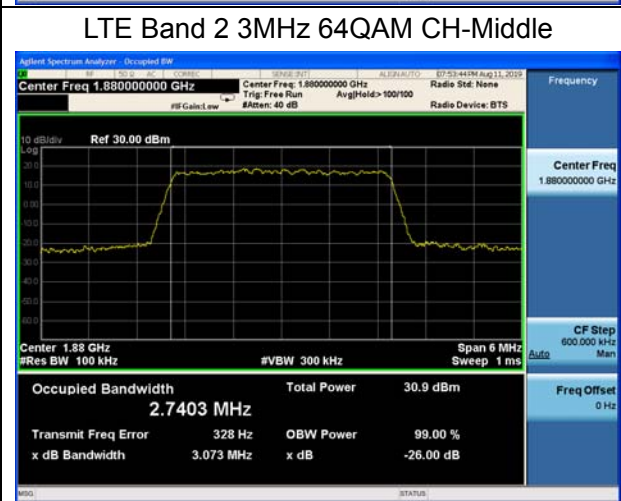
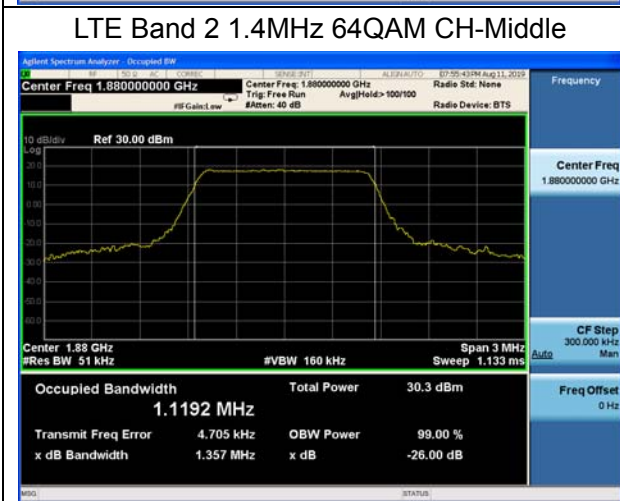
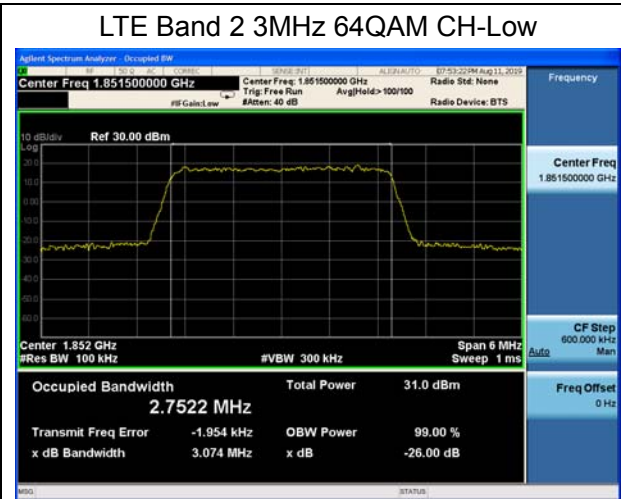
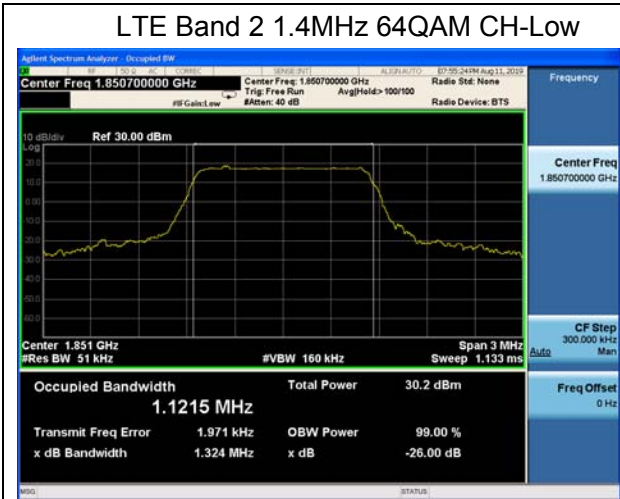

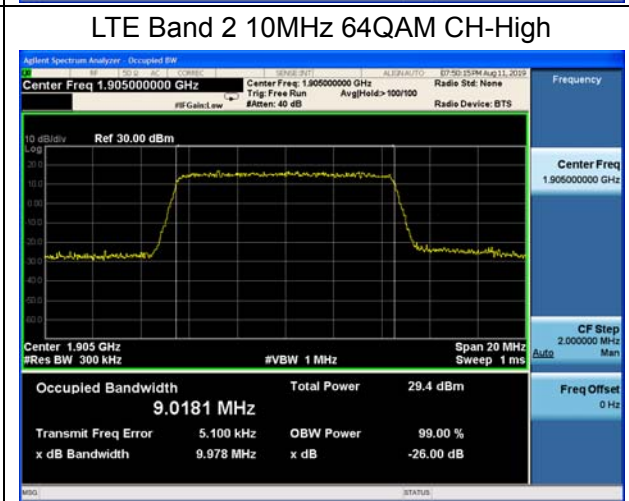
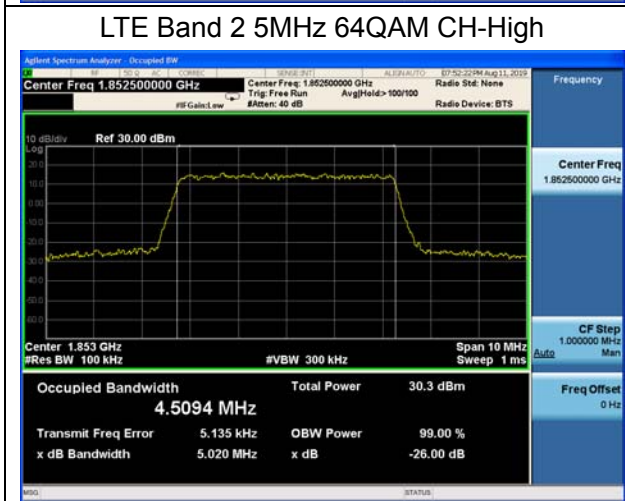
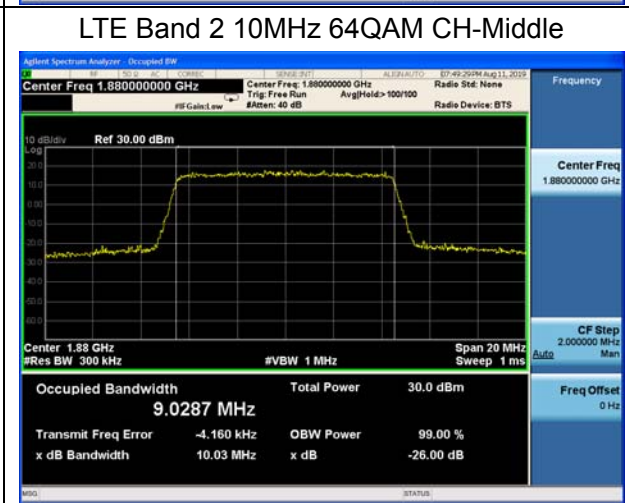
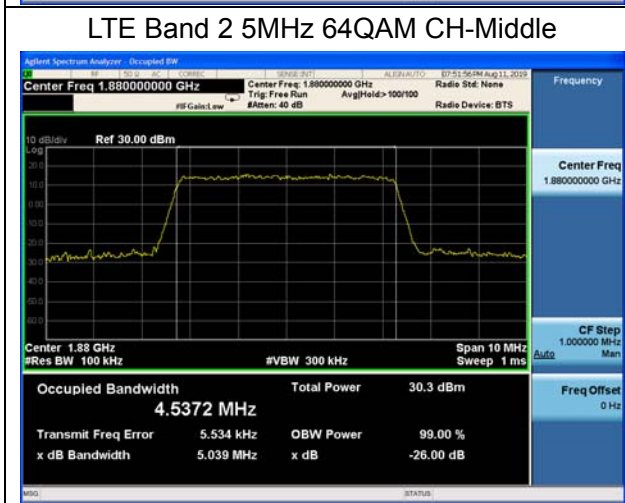
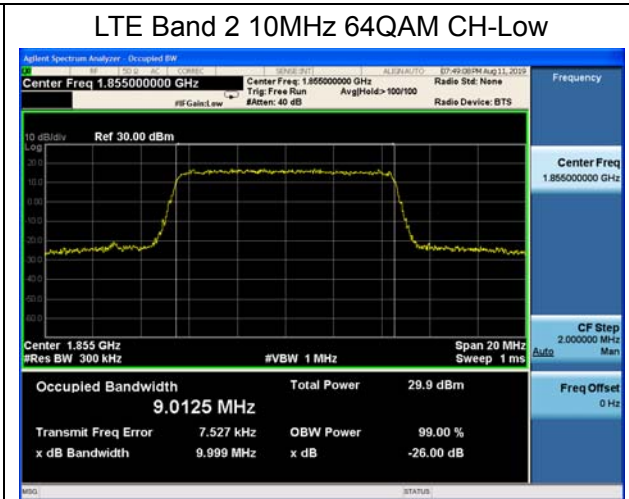
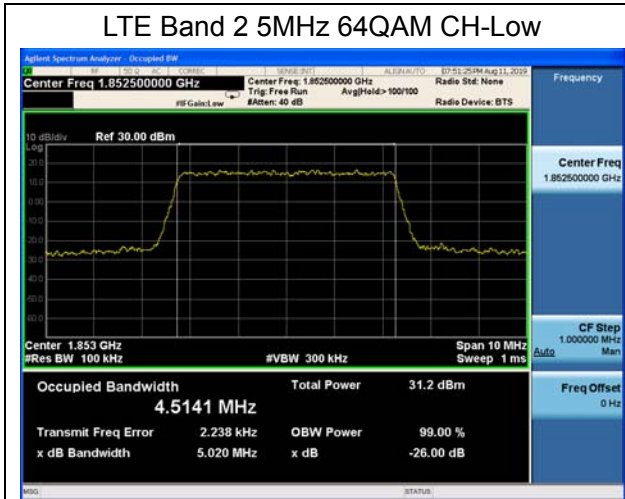



LTE Band 2 15MHz 64QAM CH-Low

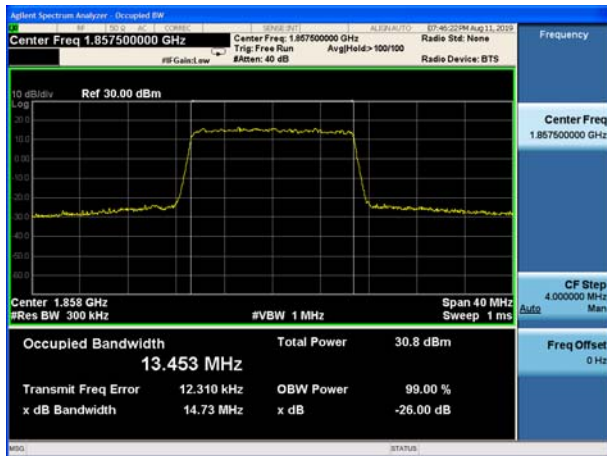

LTE Band 2 20MHz 64QAM CH-Low

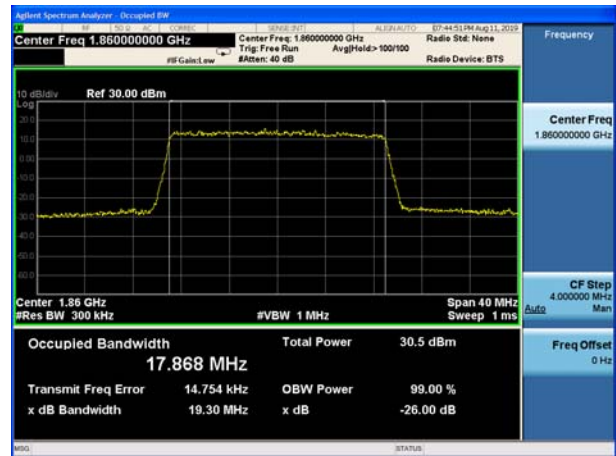

LTE Band 2 15MHz 64QAM CH-Middle

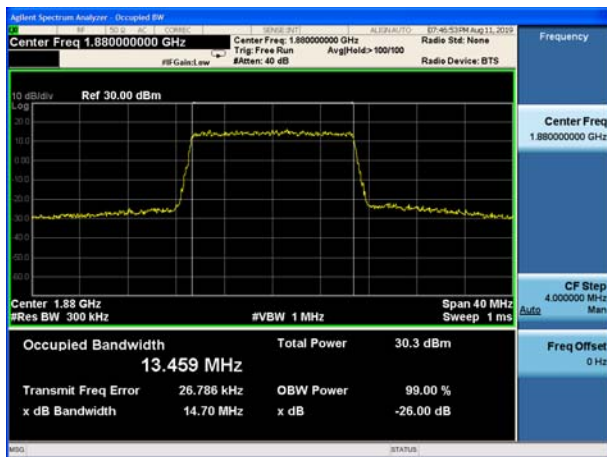

LTE Band 2 20MHz 64QAM CH-Middle



LTE Band 2 15MHz 64QAM CH-High

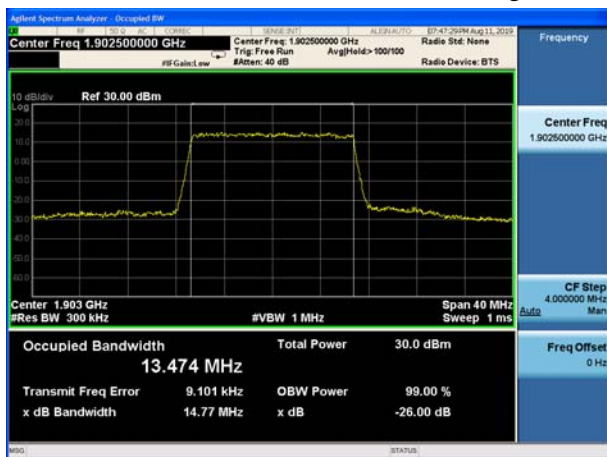

LTE Band 2 20MHz 64QAM CH-High

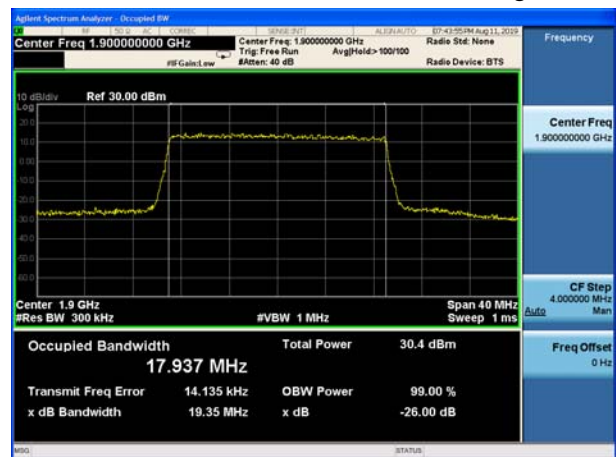

5.4. Band Edge Compliance

Ambient condition

Temperature	Relative humidity	Pressure
23°C ~25°C	45%~50%	101.5kPa

Method of Measurement

The EUT was connected to Spectrum Analyzer and Base Station Simulator via power Splitter. The band edge of the lowest and highest channels were measured. The Average detector is used and RBW is set to 3kHz, VBW is set to 10kHz for GSM 1900, RBW is set to 51kHz, VBW is set to 160kHz for WCDMA Band II, RBW is set to 15kHz, VBW is set to 51kHz for LTE Band 2 (1.4MHz), RBW is set to 30kHz, VBW is set to 100kHz for LTE Band 2 (3MHz), RBW is set to 51kHz, VBW is set to 160kHz for LTE Band 2 (5MHz), RBW is set to 100kHz, VBW is set to 300kHz for LTE Band 2 (10MHz), RBW is set to 150kHz, VBW is set to 510kHz for LTE Band 2 (15MHz), RBW is set to 200kHz, VBW is set to 620kHz for LTE Band 2 (20MHz). Spectrum analyzer plots are included on the following pages.

Test Setup

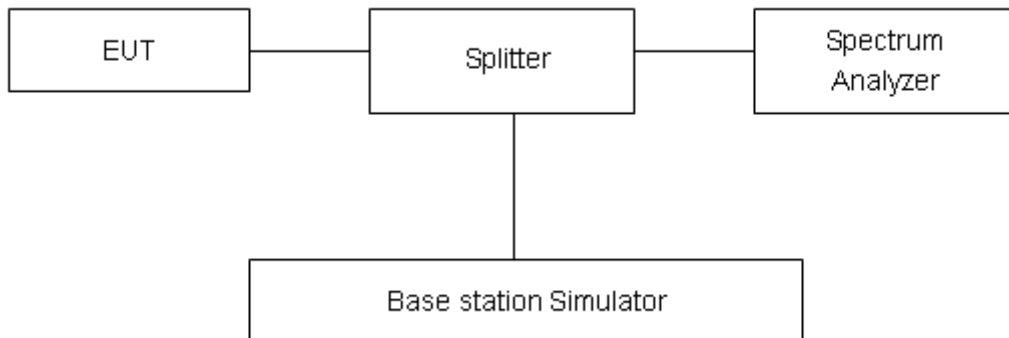

Limits

Rule Part 24.238(a) specifies that “on any frequency outside a licensee's frequency block, the power of any emission shall be attenuated below the transmitter power (P) by at least 43 + 10 log10 (P) dB.”

Limit	-13 dBm
-------	---------

Measurement Uncertainty

The assessed measurement uncertainty to ensure 95% confidence level for the normal distribution is with the coverage factor $k = 1.96$, $U=0.684\text{dB}$.



Test Result:

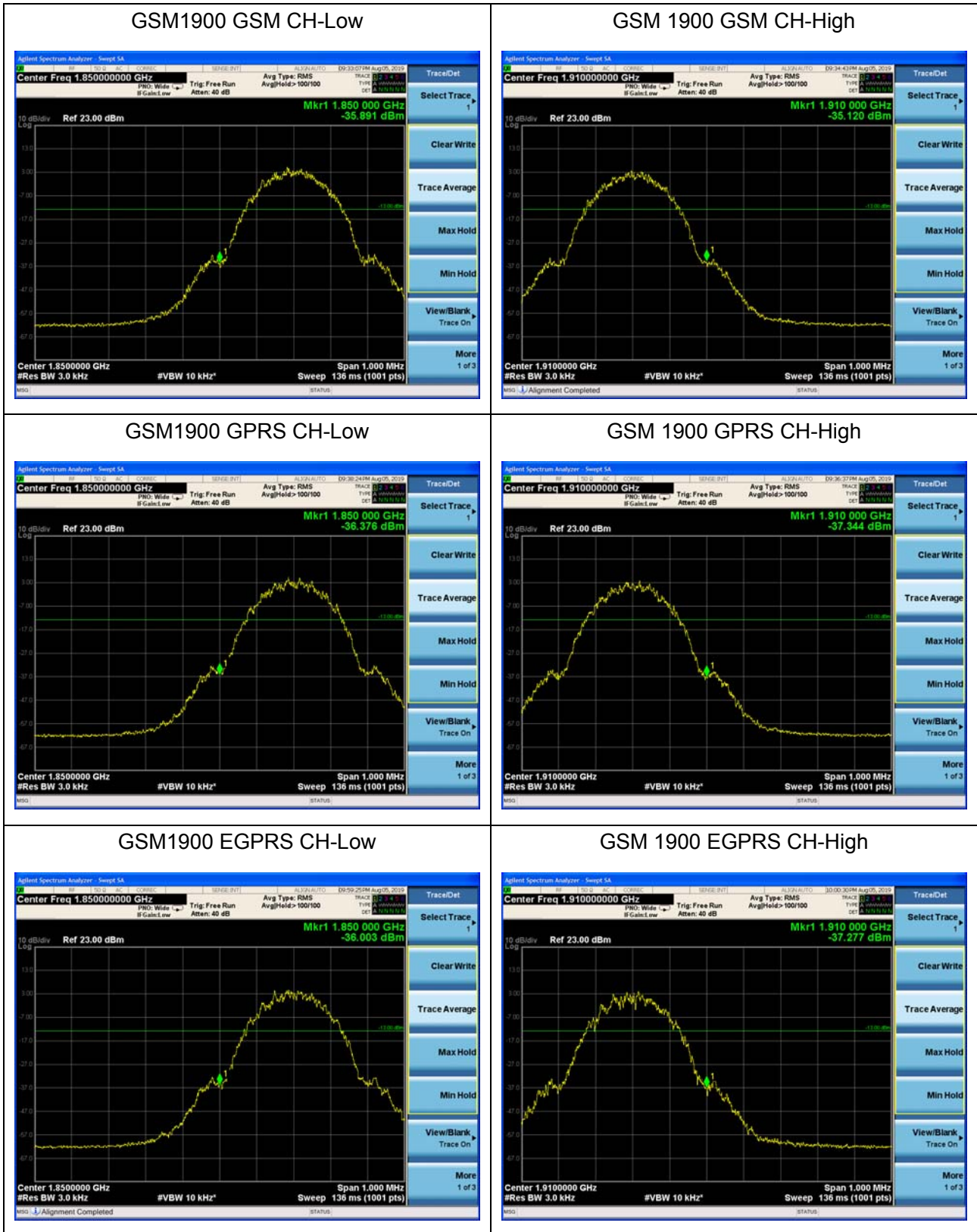



WCDMA Band II RMC CH-Low



WCDMA Band II RMC CH-High



LTE Band 2 1.4MHz QPSK 1RB CH-Low

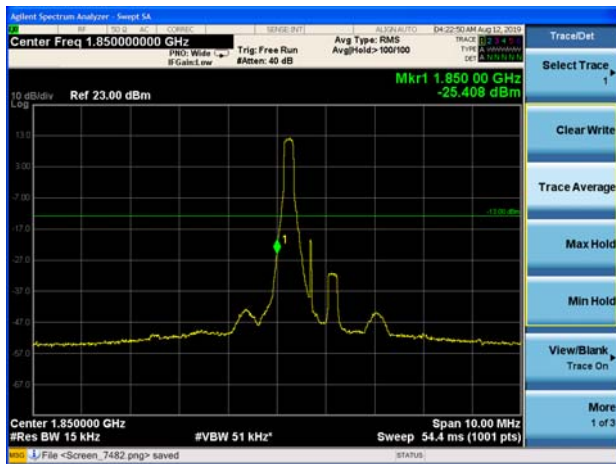

LTE Band 2 1.4MHz QPSK 1RB CH-High



LTE Band 2 1.4MHz QPSK 100%RB CH-Low

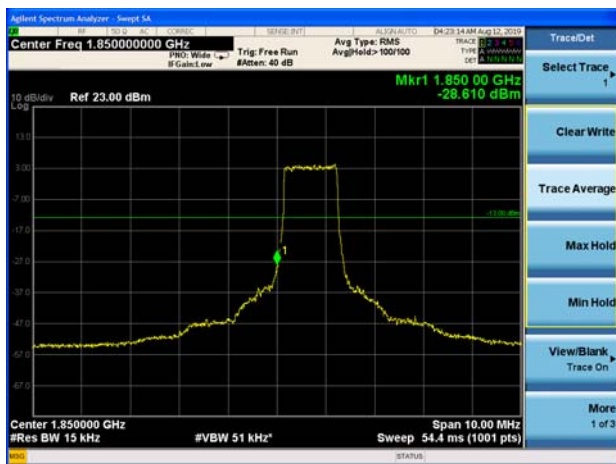

LTE Band 2 1.4MHz QPSK 100%RB CH-High

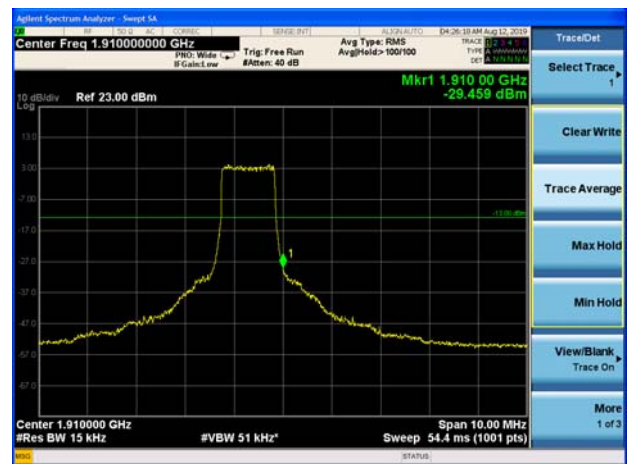



LTE Band 2 3MHz QPSK 1RB CH-Low

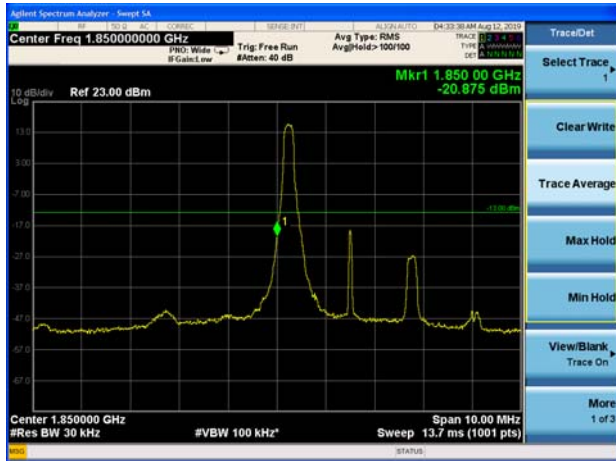

LTE Band 2 3MHz QPSK 1RB CH-High

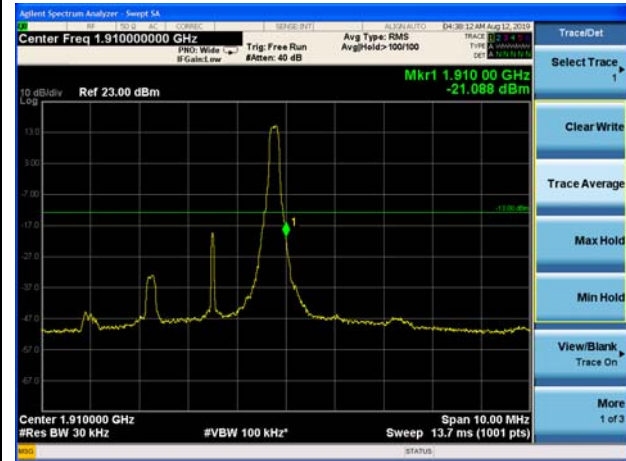

LTE Band 2 3MHz QPSK 100%RB CH-Low



LTE Band 2 3MHz QPSK 100%RB CH-High



LTE Band 2 5MHz QPSK 1RB CH-Low

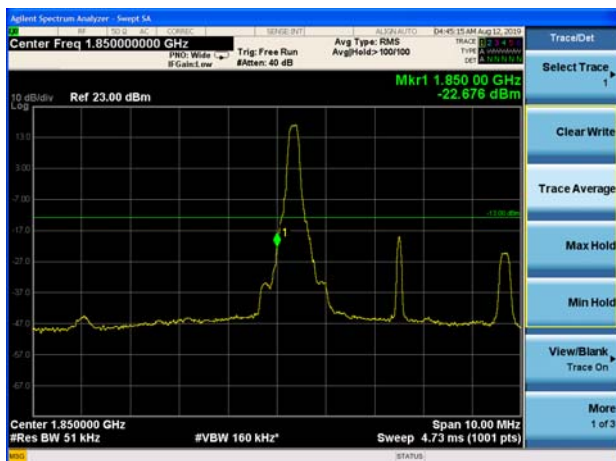

LTE Band 2 5MHz QPSK 1RB CH-High

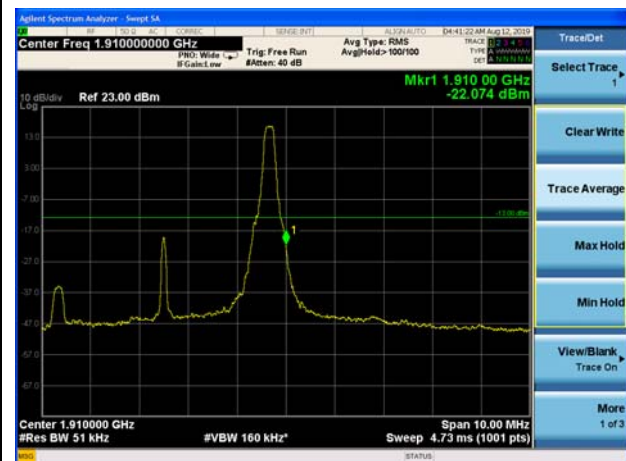



LTE Band 2 5MHz QPSK 100%RB CH-Low



LTE Band 2 5MHz QPSK 100%RB CH-High



LTE Band 2 10MHz QPSK 1RB CH-Low

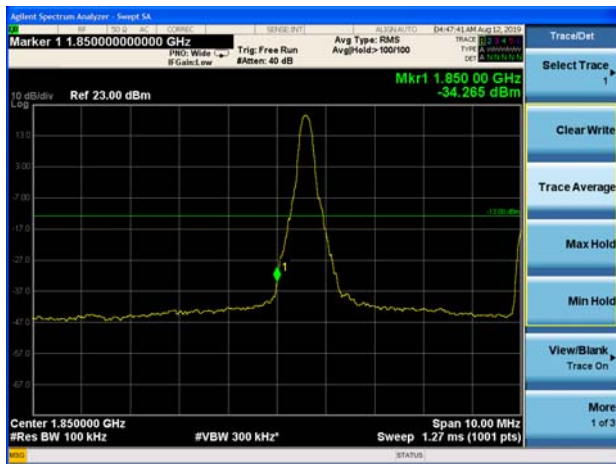

LTE Band 2 10MHz QPSK 1RB CH-High

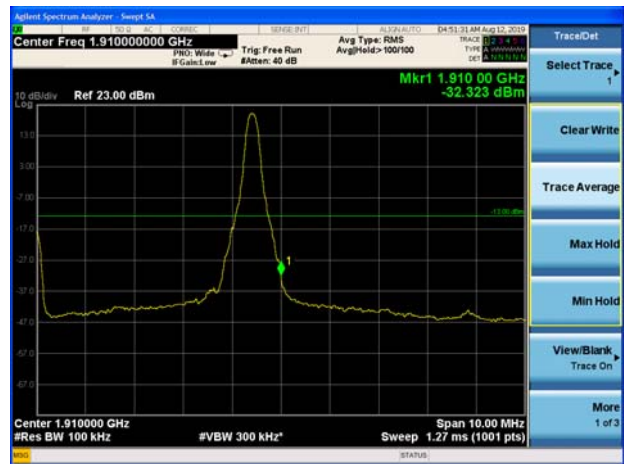

LTE Band 2 10MHz QPSK 100%RB CH-Low

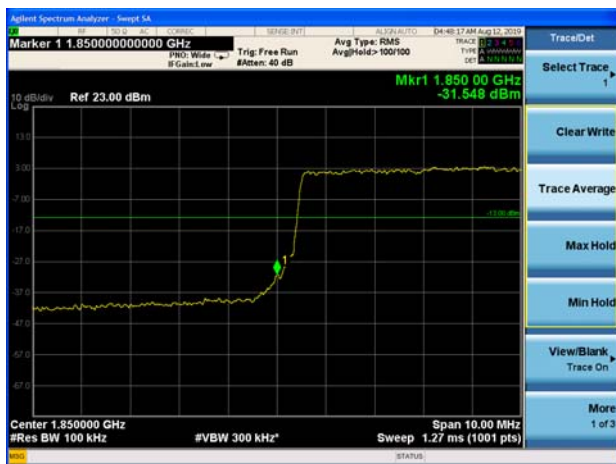

LTE Band 2 10MHz QPSK 100%RB CH-High

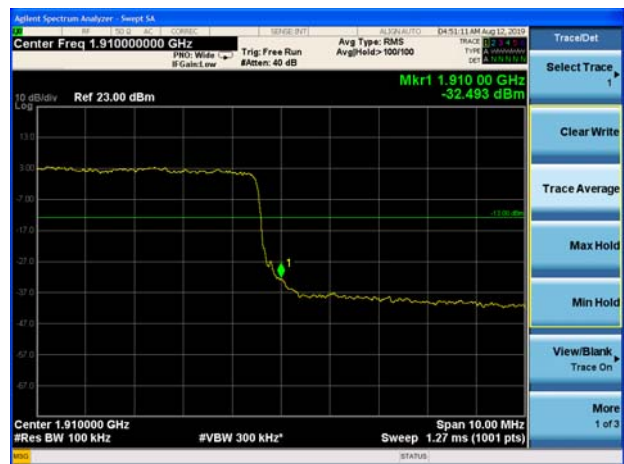



LTE Band 2 15MHz QPSK 1RB CH-Low

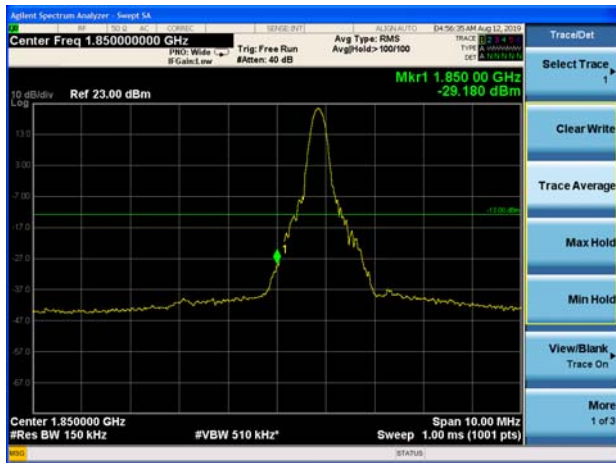

LTE Band 2 15MHz QPSK 1RB CH-High

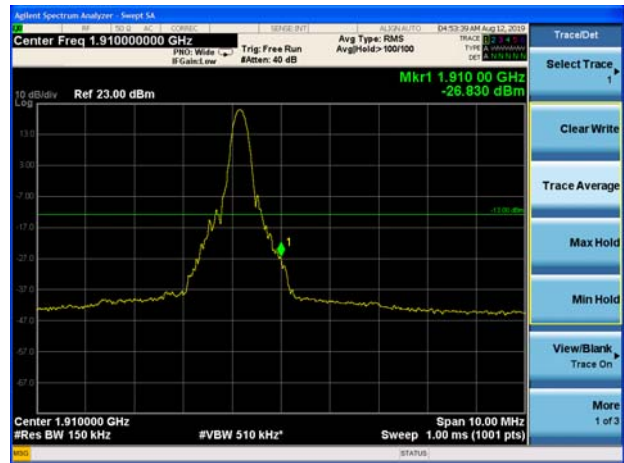

LTE Band 2 15MHz QPSK 100%RB CH-Low

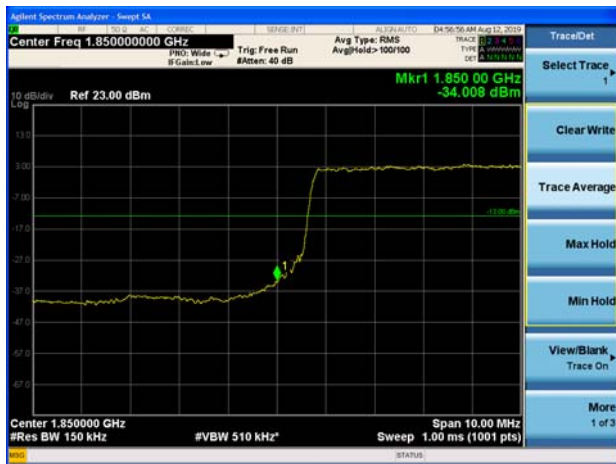

LTE Band 2 15MHz QPSK 100%RB CH-High



LTE Band 2 20MHz QPSK 1RB CH-Low

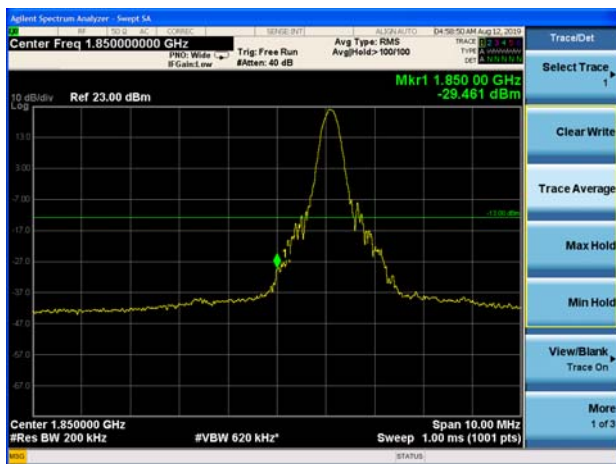

LTE Band 2 20MHz QPSK 1RB CH-High

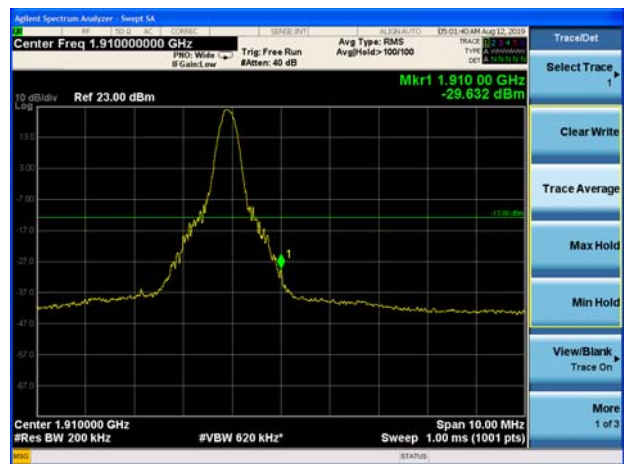



LTE Band 2 20MHz QPSK 100%RB CH-Low

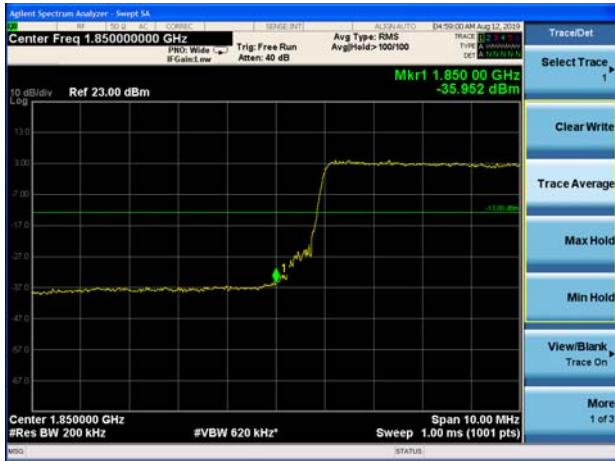

LTE Band 2 20MHz QPSK 100%RB CH-High



LTE Band 2 1.4MHz 16QAM 1RB CH-Low

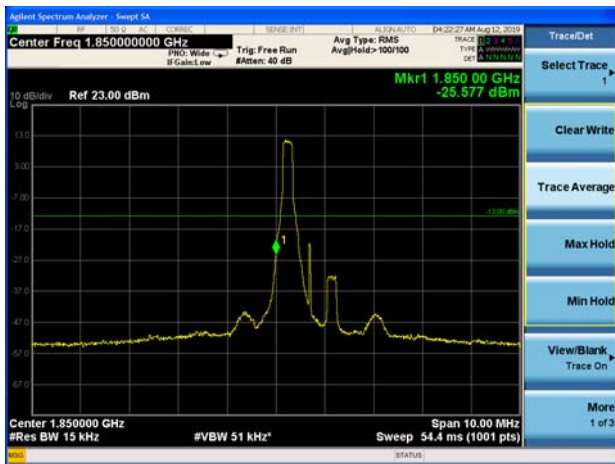

LTE Band 2 1.4MHz 16QAM 1RB CH-High

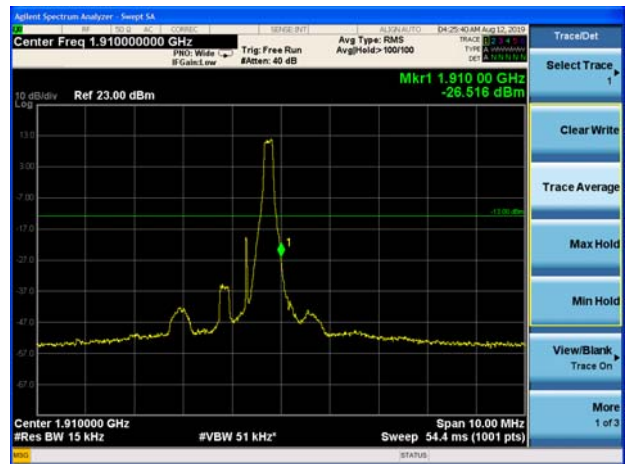

LTE Band 2 1.4MHz 16QAM 100%RB CH-Low

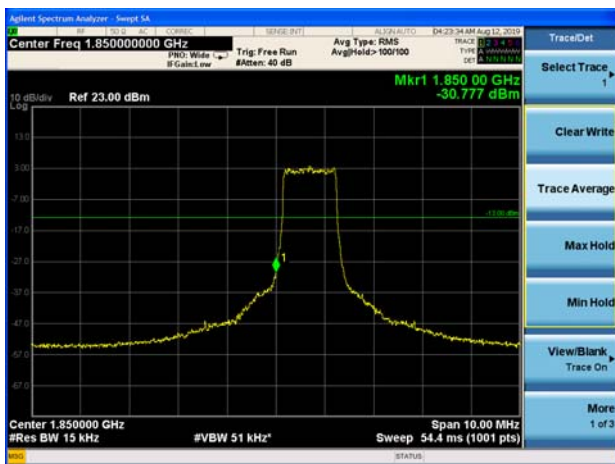

LTE Band 2 1.4MHz 16QAM 100%RB CH-High

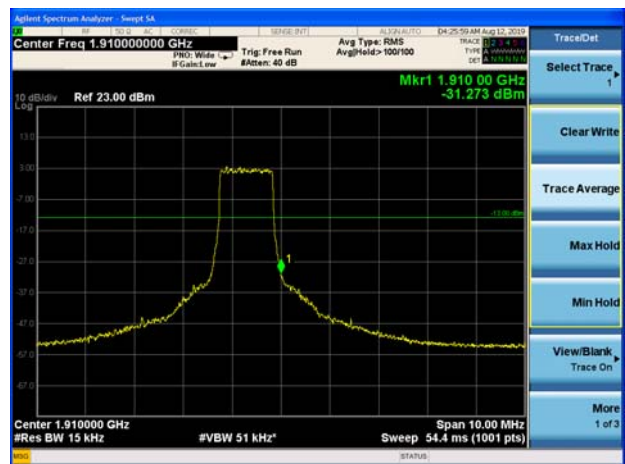



LTE Band 2 3MHz 16QAM 1RB CH-Low

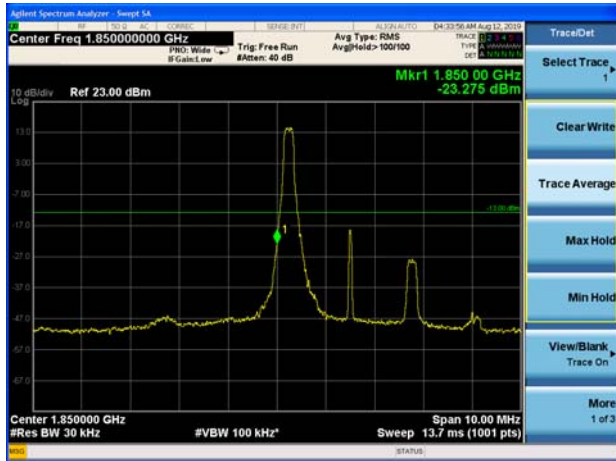

LTE Band 2 3MHz 16QAM 1RB CH-High

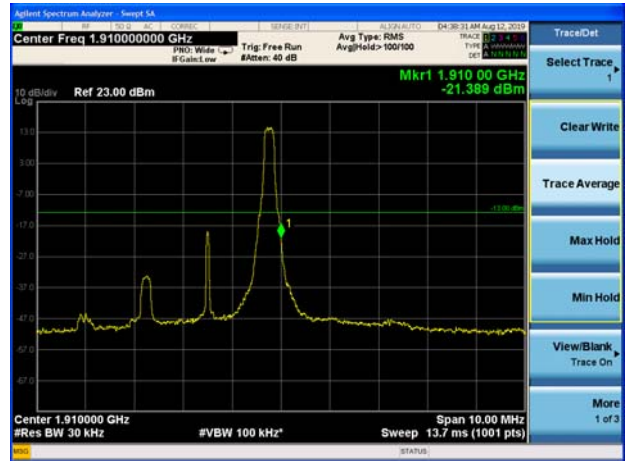

LTE Band 2 3MHz 16QAM 100%RB CH-Low

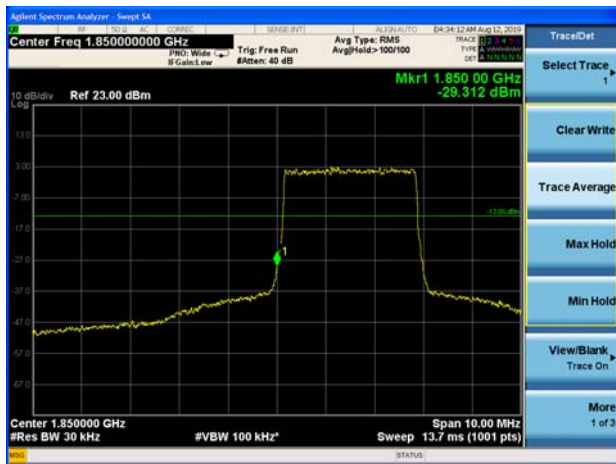

LTE Band 2 3MHz 16QAM 100%RB CH-High



LTE Band 2 5MHz 16QAM 1RB CH-Low

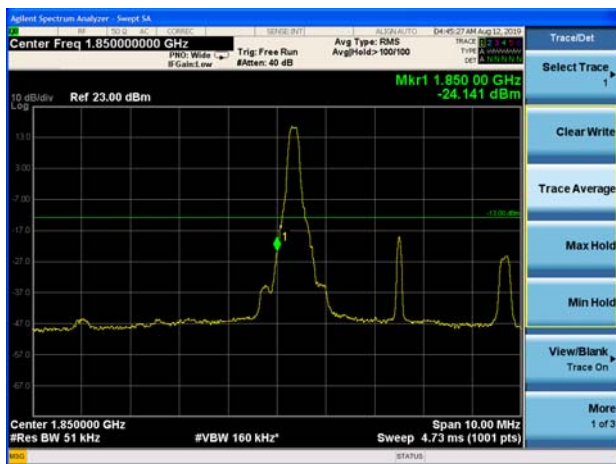

LTE Band 2 5MHz 16QAM 1RB CH-High

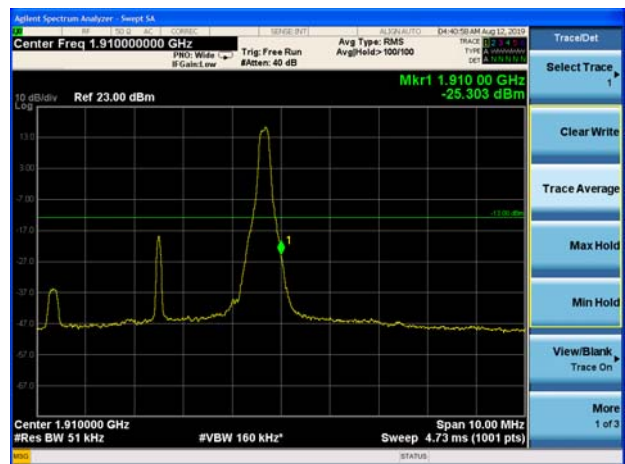



LTE Band 2 5MHz 16QAM 100%RB CH-Low



LTE Band 2 5MHz 16QAM 100%RB CH-High



LTE Band 2 10MHz 16QAM 1RB CH-Low

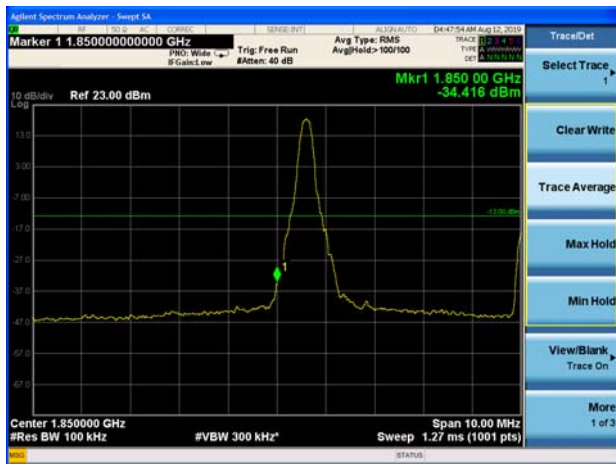

LTE Band 2 10MHz 16QAM 1RB CH-High

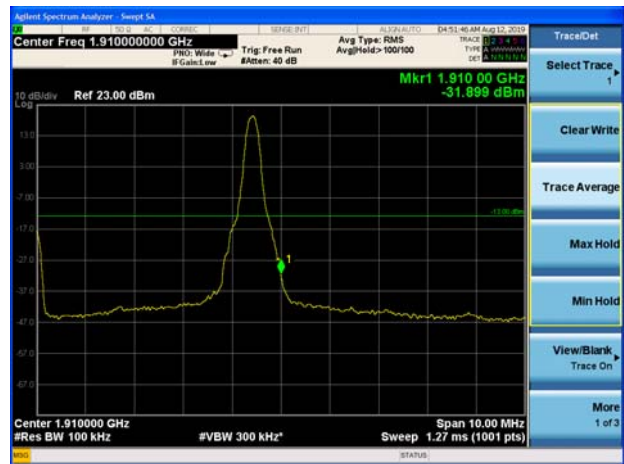

LTE Band 2 10MHz 16QAM 100%RB CH-Low

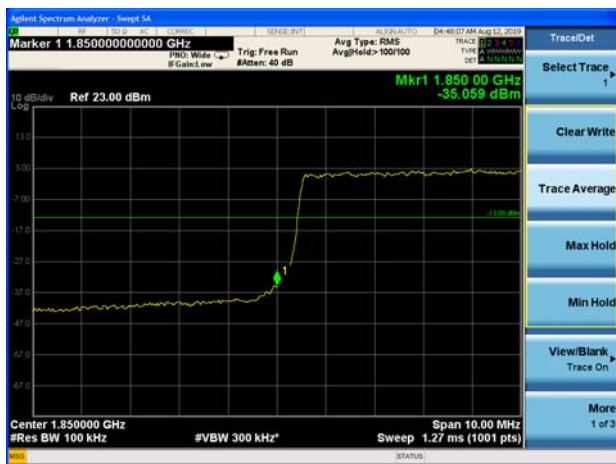

LTE Band 2 10MHz 16QAM 100%RB CH-High

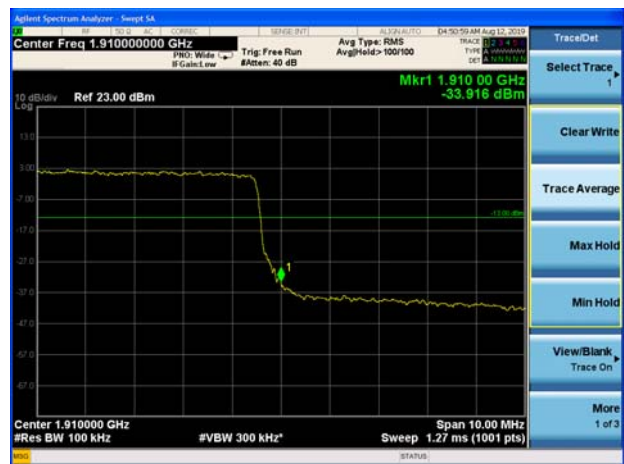



LTE Band 2 15MHz 16QAM 1RB CH-Low

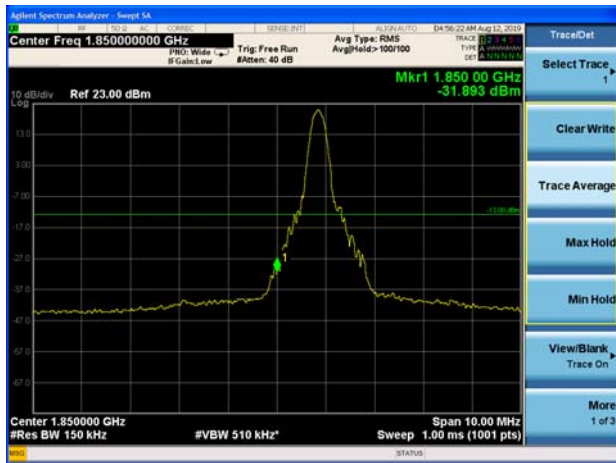

LTE Band 2 15MHz 16QAM 1RB CH-High



LTE Band 2 15MHz 16QAM 100%RB CH-Low



LTE Band 2 15MHz 16QAM 100%RB CH-High



LTE Band 2 20MHz 16QAM 1RB CH-Low

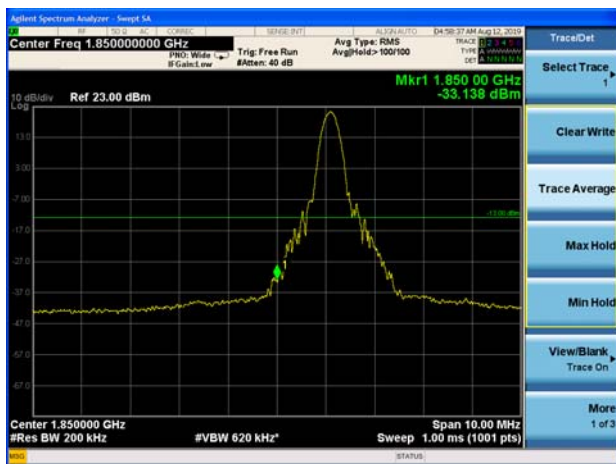

LTE Band 2 20MHz 16QAM 1RB CH-High

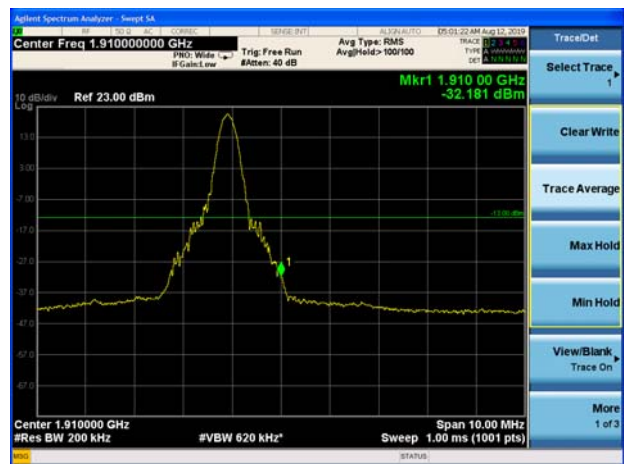



LTE Band 2 20MHz 16QAM 100%RB CH-Low



LTE Band 2 20MHz 16QAM 100%RB CH-High



LTE Band 2 1.4MHz 64QAM 1RB CH-Low

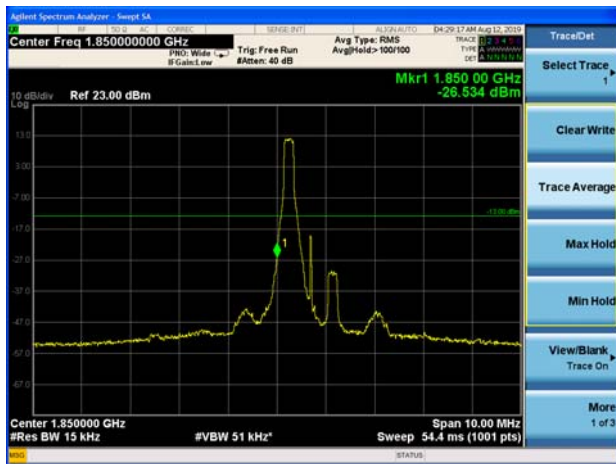

LTE Band 2 1.4MHz 64QAM 1RB CH-High



LTE Band 2 1.4MHz 64QAM 100%RB CH-Low

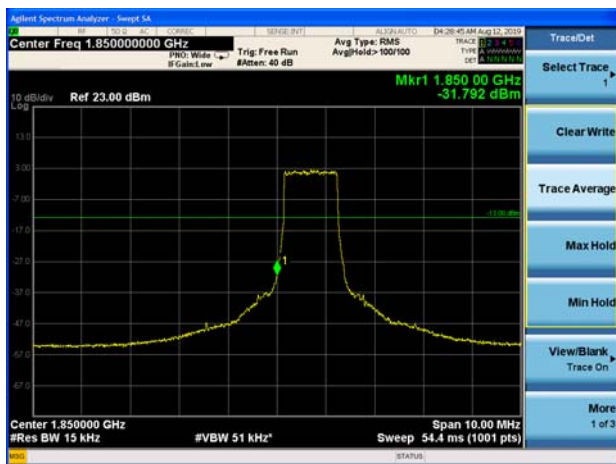

LTE Band 2 1.4MHz 64QAM 100%RB CH-High

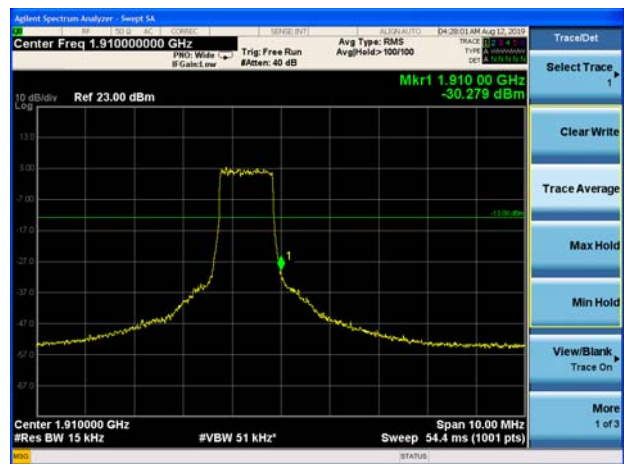



LTE Band 2 3MHz 64QAM 1RB CH-Low

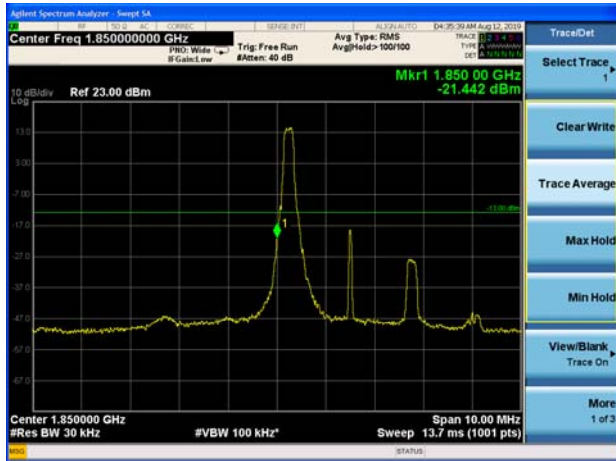

LTE Band 2 3MHz 64QAM 1RB CH-High

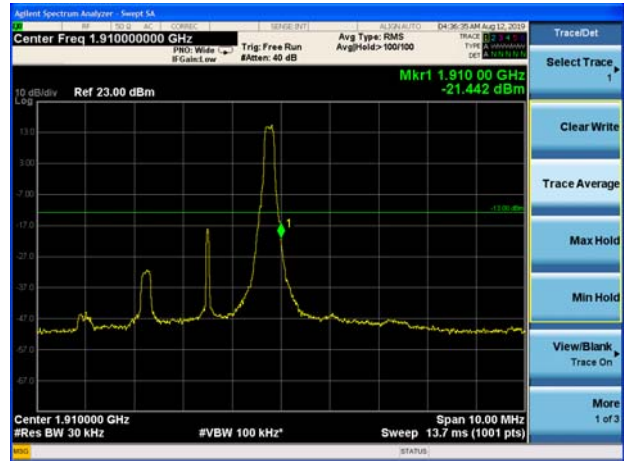

LTE Band 2 3MHz 64QAM 100%RB CH-Low

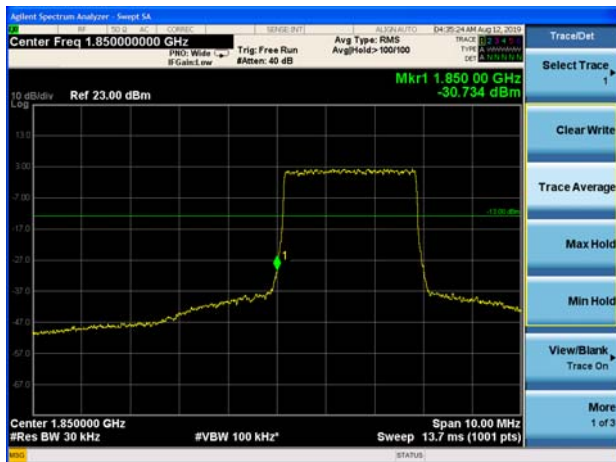

LTE Band 2 3MHz 64QAM 100%RB CH-High



LTE Band 2 5MHz 64QAM 1RB CH-Low

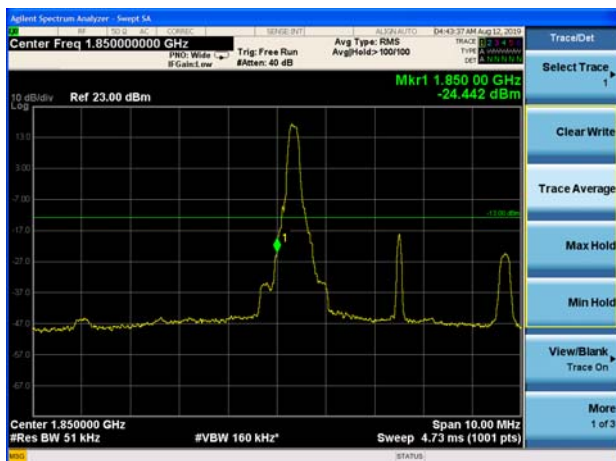

LTE Band 2 5MHz 64QAM 1RB CH-High

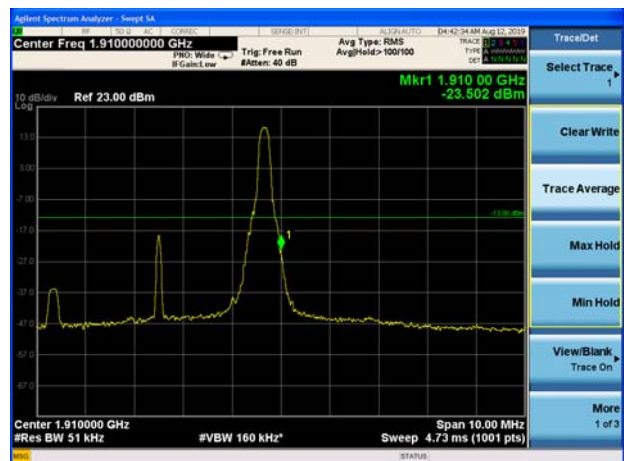



LTE Band 2 5MHz 64QAM 100%RB CH-Low



LTE Band 2 5MHz 64QAM 100%RB CH-High



LTE Band 2 10MHz 64QAM 1RB CH-Low

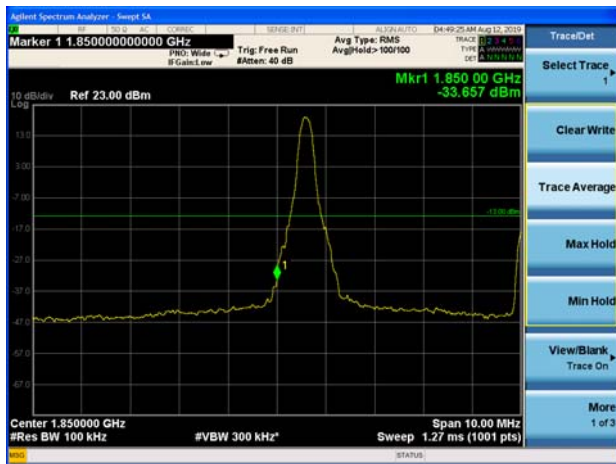

LTE Band 2 10MHz 64QAM 1RB CH-High

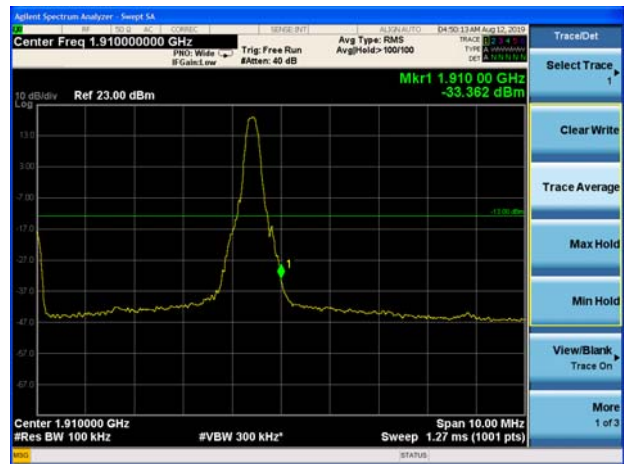

LTE Band 2 10MHz 64QAM 100%RB CH-Low

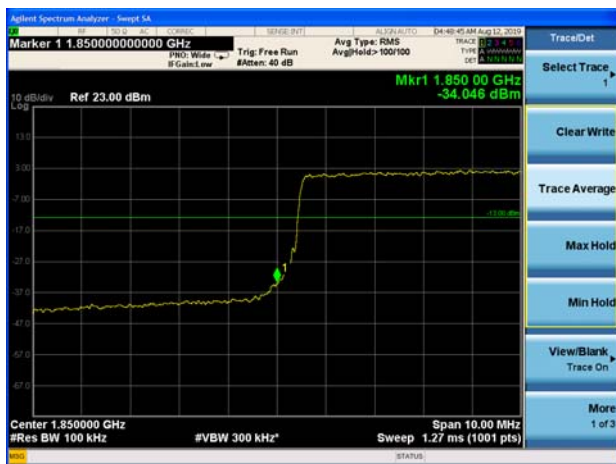

LTE Band 2 10MHz 64QAM 100%RB CH-High





LTE Band 2 15MHz 64QAM 1RB CH-Low

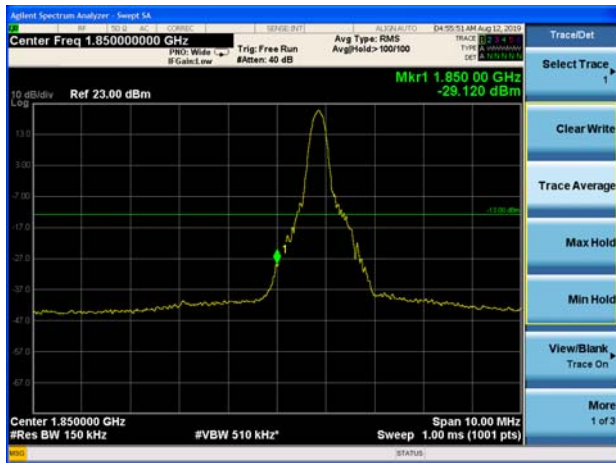

LTE Band 2 15MHz 64QAM 1RB CH-High

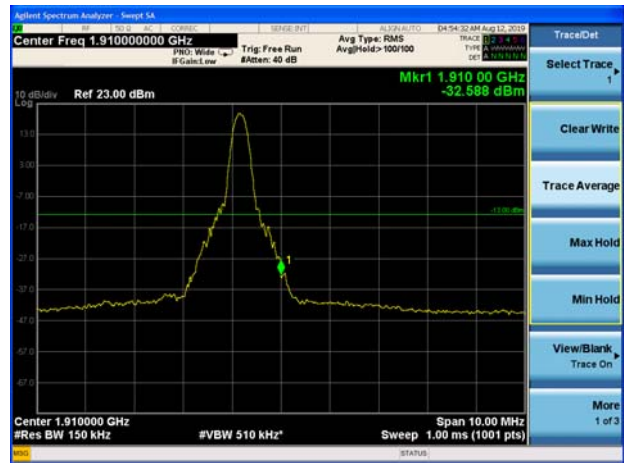

LTE Band 2 15MHz 64QAM 100%RB CH-Low

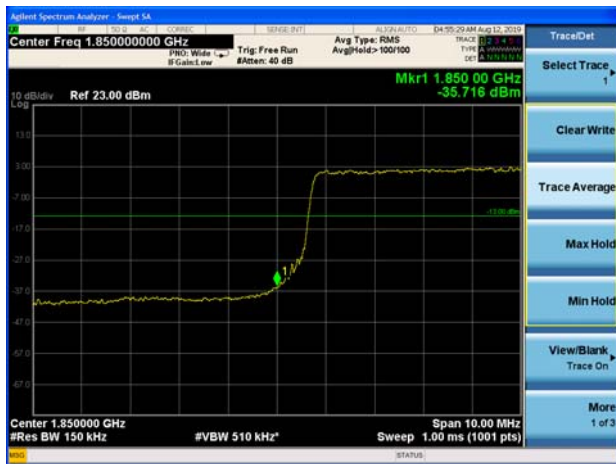

LTE Band 2 15MHz 64QAM 100%RB CH-High



LTE Band 2 20MHz 64QAM 1RB CH-Low

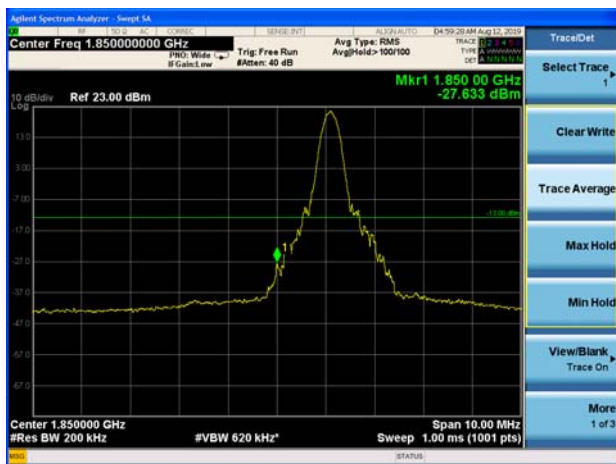

LTE Band 2 20MHz 64QAM 1RB CH-High

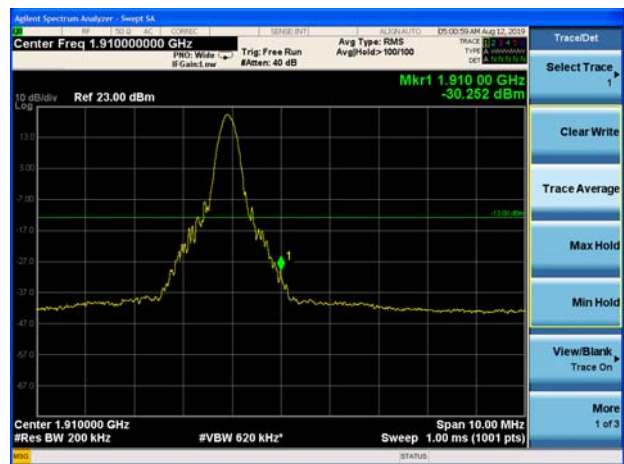



LTE Band 2 20MHz 64QAM 100%RB CH-Low



LTE Band 2 20MHz 64QAM 100%RB CH-High



5.5. Peak-to-Average Power Ratio (PAPR)

Ambient condition

Temperature	Relative humidity	Pressure
23°C ~25°C	45%~50%	101.5kPa

Methods of Measurement

Measure the total peak power and record as PPk. And measure the total average power and record as PAvg. Both the peak and average power levels must be expressed in the same logarithmic units (e.g., dBm). Determine the PAPR from:

$$PAPR (dB) = PPk (dBm) - PAvg (dBm).$$

Test Setup

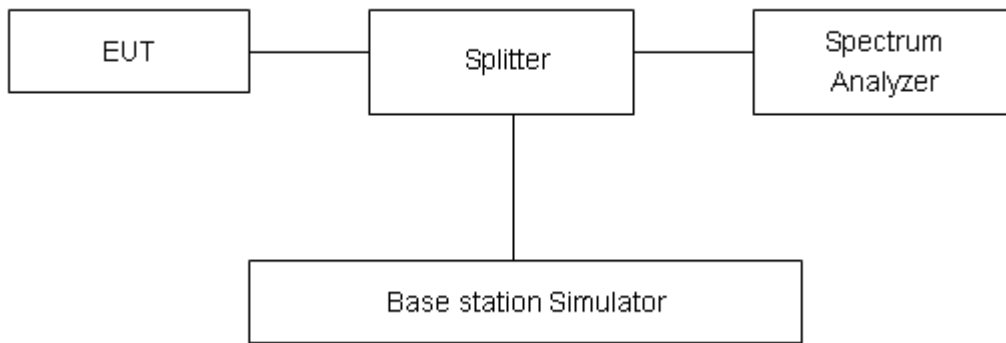

Limits

In measuring transmissions in this band using an average power technique, the peak-to-average ratio (PAR) of the transmission may not exceed 13 dB in 24.232(d).

Measurement Uncertainty

The assessed measurement uncertainty to ensure 95% confidence level for the normal distribution is with the coverage factor $k = 2$, $U = 0.4$ dB.

**Test Results**

Mode	Channel	Frequency (MHz)	Peak(dBm)	Avg(dBm)	PAPR(dB)	Limit(dB)	Conclusion
GSM 1900 (GSM)	512	1850.2	31.93	29.81	2.12	≤13	PASS
	661	1880	31.83	29.61	2.22	≤13	PASS
	810	1909.8	31.53	29.43	2.10	≤13	PASS
GPRS 1900 (GMSK)	512	1850.2	31.85	29.79	2.06	≤13	PASS
	661	1880	31.64	29.55	2.09	≤13	PASS
	810	1909.8	31.50	29.39	2.11	≤13	PASS
EGPRS 1900 (8-PSK)	512	1850.2	29.08	25.56	3.52	≤13	PASS
	661	1880	28.87	25.46	3.41	≤13	PASS
	810	1909.8	28.83	25.38	3.45	≤13	PASS
WCDMA Band II (RMC)	9262	1852.4	23.13	3.04	23.13	≤13	PASS
	9400	1880	23.19	3.07	23.19	≤13	PASS
	9538	1907.6	22.96	3.16	22.96	≤13	PASS



LTE Band 2								
Modulation	Bandwidth (MHz)	Channel	Frequency (MHz)	Peak (dBm)	Avg (dBm)	PAPR (dB)	Limit (dB)	Conclusion
QPSK	1.4	18607	1850.7	26.97	22.16	4.81	≤13	PASS
		18900	1880.0	26.69	21.85	4.84	≤13	PASS
		19193	1909.3	26.65	22.07	4.58	≤13	PASS
	3	18615	1851.5	27.09	22.16	4.93	≤13	PASS
		18900	1880	26.91	22.00	4.91	≤13	PASS
		19185	1908.5	26.90	22.05	4.85	≤13	PASS
	5	18625	1852.5	26.99	22.09	4.90	≤13	PASS
		18900	1880	26.78	21.84	4.94	≤13	PASS
		19175	1907.5	26.81	21.88	4.93	≤13	PASS
	10	18650	1855	26.86	21.97	4.89	≤13	PASS
		18900	1880	26.58	21.67	4.91	≤13	PASS
		19150	1905	27.06	22.07	4.99	≤13	PASS
	15	18675	1857.5	27.24	22.23	5.01	≤13	PASS
		18900	1880	26.90	21.93	4.97	≤13	PASS
		19125	1902.5	27.13	22.07	5.06	≤13	PASS
	20	18700	1860	27.09	22.11	4.98	≤13	PASS
		18900	1880	27.38	21.97	5.41	≤13	PASS
		19100	1900	27.06	22.10	4.96	≤13	PASS
16QAM	1.4	18607	1850.7	26.73	21.09	5.64	≤13	PASS
		18900	1880.0	26.54	20.85	5.69	≤13	PASS
		19193	1909.3	26.52	21.12	5.40	≤13	PASS
	3	18615	1851.5	26.81	21.06	5.75	≤13	PASS
		18900	1880	26.57	20.78	5.79	≤13	PASS
		19185	1908.5	26.72	21.06	5.66	≤13	PASS
	5	18625	1852.5	26.87	21.21	5.66	≤13	PASS
		18900	1880	26.66	20.95	5.71	≤13	PASS
		19175	1907.5	26.61	20.88	5.73	≤13	PASS
	10	18650	1855	26.55	20.86	5.69	≤13	PASS
		18900	1880	26.53	20.84	5.69	≤13	PASS
		19150	1905	26.81	20.97	5.84	≤13	PASS
	15	18675	1857.5	26.99	21.21	5.78	≤13	PASS
		18900	1880	26.80	21.45	5.35	≤13	PASS
		19125	1902.5	26.90	21.07	5.83	≤13	PASS
	20	18700	1860	27.07	21.29	5.78	≤13	PASS
		18900	1880	26.80	21.29	5.51	≤13	PASS
		19100	1900	26.90	21.28	5.62	≤13	PASS
64QAM	1.4	18607	1850.7	26.72	21.09	5.63	≤13	PASS
		18900	1880.0	26.72	21.00	5.72	≤13	PASS
		19193	1909.3	25.92	20.32	5.60	≤13	PASS



	3	18615	1851.5	26.87	21.13	5.74	≤13	PASS
		18900	1880	26.81	20.99	5.82	≤13	PASS
		19185	1908.5	26.41	20.69	5.72	≤13	PASS
	5	18625	1852.5	26.77	21.08	5.69	≤13	PASS
		18900	1880	26.88	21.12	5.76	≤13	PASS
		19175	1907.5	26.51	20.73	5.78	≤13	PASS
	10	18650	1855	26.61	20.86	5.75	≤13	PASS
		18900	1880	26.89	21.15	5.74	≤13	PASS
		19150	1905	26.68	20.79	5.89	≤13	PASS
	15	18675	1857.5	26.86	21.05	5.81	≤13	PASS
		18900	1880	26.89	21.13	5.76	≤13	PASS
		19125	1902.5	26.75	20.90	5.85	≤13	PASS
	20	18700	1860	26.89	21.06	5.83	≤13	PASS
		18900	1880	26.85	21.10	5.75	≤13	PASS
		19100	1900	27.29	20.95	6.34	≤13	PASS

5.6. Frequency Stability

Ambient condition

Temperature	Relative humidity	Pressure
23°C ~25°C	45%~50%	101.5kPa

Method of Measurement

Frequency Stability (Temperature Variation)

The temperature inside the climate chamber is varied from -30°C to +55°C in 10°C step size,

(1) With all power removed, the temperature was decreased to 0°C and permitted to stabilize for three hours.

(2) Measure the carrier frequency with the test equipment in a “call mode”. These measurements should be made within 1 minute of powering up the mobile station, to prevent significant self warming.

(3) Repeat the above measurements at 10°C increments from -30°C to +55°C. Allow at least 1.5 hours at each temperature, un-powered, before making measurements.

Frequency Stability (Voltage Variation)

The frequency stability shall be measured with variation of primary supply voltage as follows:

(1) Vary primary supply voltage from 85 to 115 percent of the nominal value for other than hand carried battery equipment.

(2) For hand carried, battery powered equipment, reduce primary supply voltage to the battery-operating end point which shall be specified by the manufacturer.

This transceiver is specified to operate with an input voltage of between 3.4 V and 4.4 V, with a nominal voltage of 3.85V.

Test setup

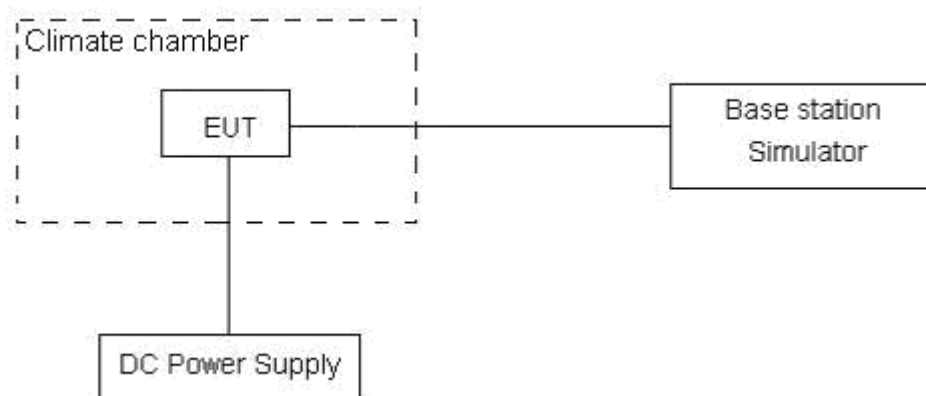

**Limits**

The frequency stability shall be sufficient to ensure that the fundamental emission stays within the authorized frequency block

Measurement Uncertainty

The assessed measurement uncertainty to ensure 99.75% confidence level for the normal distribution is with the coverage factor $k = 3$, $U = 0.01\text{ppm}$.

Test Result

GSM1900						
Condition		Freq.Error (Hz)	Freq.Error (Hz)	Frequency Stability (ppm)	Frequency Stability (ppm)	Verdict
Temperature	Voltage	GMSK	8PSK	GMSK	8PSK	
Normal (25°C)	Normal	10.70	14.14	0.00569	0.00752	PASS
Extreme (55°C)		3.43	9.46	0.00182	0.00503	PASS
Extreme (50°C)		17.46	13.52	0.00929	0.00719	PASS
Extreme (40°C)		4.22	6.45	0.00224	0.00343	PASS
Extreme (30°C)		11.83	5.77	0.00629	0.00307	PASS
Extreme (20°C)		13.47	5.87	0.00716	0.00312	PASS
Extreme (10°C)		1.88	8.01	0.00100	0.00426	PASS
Extreme (0°C)		15.73	13.26	0.00837	0.00705	PASS
Extreme (-10°C)		16.13	12.89	0.00858	0.00686	PASS
Extreme (-20°C)		1.06	15.51	0.00056	0.00825	PASS
Extreme (-30°C)		5.91	4.23	0.00314	0.00225	PASS
25°C		LV	5.56	12.91	0.00296	0.00687
	HV	13.18	10.34	0.00701	0.00550	PASS

WCDMA Band II						
Condition		Freq.Error (Hz)	Freq.Error (Hz)	Frequency Stability (ppm)	Frequency Stability (ppm)	Verdict
Temperature	Voltage	QPSK	BPSK	QPSK	BPSK	
Normal (25°C)	Normal	17.58	6.77	0.00935	0.00360	PASS
Extreme (55°C)		9.01	7.30	0.00479	0.00388	PASS
Extreme (50°C)		6.81	2.50	0.00362	0.00133	PASS
Extreme (40°C)		15.49	16.25	0.00824	0.00864	PASS
Extreme (30°C)		9.57	5.14	0.00509	0.00273	PASS
Extreme (20°C)		16.83	5.89	0.00895	0.00313	PASS
Extreme (10°C)		10.19	9.98	0.00542	0.00531	PASS
Extreme (0°C)		10.51	6.77	0.00559	0.00360	PASS
Extreme (-10°C)		1.96	15.53	0.00104	0.00826	PASS
Extreme (-20°C)		6.78	7.73	0.00361	0.00411	PASS
Extreme (-30°C)		16.75	13.14	0.00891	0.00699	PASS
25°C		LV	4.51	8.71	0.00240	0.00463
	HV	17.39	17.33	0.00925	0.00922	PASS



LTE Band 2								
Condition		Freq.Error (Hz)	Freq.Error (Hz)	Freq.Error (Hz)	Frequency Stability (ppm)	Frequency Stability (ppm)	Frequency Stability (ppm)	Verdict
BANDWIDTH	1.4MHz							
Temperature	Voltage	64QAM	16QAM	QPSK	64QAM	16QAM	QPSK	
Normal (25°C)	Normal	17.26	4.26	3.48	0.00918	0.00226	0.00185	PASS
Extreme (55°C)		15.88	15.88	4.82	0.00845	0.00845	0.00257	PASS
Extreme (50°C)		5.49	15.49	2.51	0.00292	0.00824	0.00134	PASS
Extreme (40°C)		4.14	4.14	14.98	0.00220	0.00220	0.00797	PASS
Extreme (30°C)		1.19	5.19	14.87	0.00064	0.00276	0.00791	PASS
Extreme (20°C)		9.04	16.04	5.29	0.00481	0.00853	0.00281	PASS
Extreme (10°C)		2.31	15.31	7.47	0.00123	0.00814	0.00398	PASS
Extreme (0°C)		3.13	13.13	12.42	0.00166	0.00698	0.00661	PASS
Extreme (-10°C)		3.88	5.88	9.67	0.00206	0.00313	0.00514	PASS
Extreme (-20°C)		5.92	17.92	15.08	0.00315	0.00953	0.00802	PASS
Extreme (-30°C)		13.07	8.07	3.95	0.00695	0.00429	0.00210	PASS
25°C	LV	7.92	8.92	11.16	0.00421	0.00474	0.00594	PASS
	HV	14.31	6.31	10.11	0.00761	0.00336	0.00538	PASS
Condition		Freq.Error (Hz)	Freq.Error (Hz)	Freq.Error (Hz)	Frequency Stability (ppm)	Frequency Stability (ppm)	Frequency Stability (ppm)	Verdict
BANDWIDTH	3MHz							
Temperature	Voltage	64QAM	16QAM	QPSK	64QAM	16QAM	QPSK	
Normal (25°C)	Normal	9.63	6.63	16.42	0.00512	0.00353	0.00874	PASS
Extreme (55°C)		1.65	2.65	5.83	0.00088	0.00141	0.00310	PASS
Extreme (50°C)		1.86	3.86	8.60	0.00099	0.00205	0.00457	PASS
Extreme (40°C)		12.79	2.79	2.82	0.00680	0.00148	0.00150	PASS
Extreme (30°C)		7.37	16.37	7.11	0.00392	0.00871	0.00378	PASS
Extreme (20°C)		8.65	15.65	16.72	0.00460	0.00833	0.00889	PASS
Extreme (10°C)		7.89	11.89	5.51	0.00420	0.00633	0.00293	PASS
Extreme (0°C)		11.56	2.56	15.30	0.00615	0.00136	0.00814	PASS
Extreme (-10°C)		2.64	12.64	10.79	0.00141	0.00673	0.00574	PASS
Extreme (-20°C)		16.11	3.11	15.02	0.00857	0.00166	0.00799	PASS
Extreme (-30°C)		10.29	13.29	4.32	0.00548	0.00707	0.00230	PASS
25°C	LV	9.31	7.31	10.02	0.00495	0.00389	0.00533	PASS
	HV	12.36	15.36	11.23	0.00657	0.00817	0.00597	PASS
Condition		Freq.Error (Hz)	Freq.Error (Hz)	Freq.Error (Hz)	Frequency Stability (ppm)	Frequency Stability (ppm)	Frequency Stability (ppm)	Verdict
BANDWIDTH	5MHz							
Temperature	Voltage	64QAM	16QAM	QPSK	64QAM	16QAM	QPSK	
Normal (25°C)	Normal	16.41	2.41	5.69	0.00873	0.00128	0.00303	PASS
Extreme (55°C)		8.62	9.62	8.63	0.00458	0.00512	0.00459	PASS



Extreme (50°C)		10.94	8.94	15.18	0.00582	0.00475	0.00807	PASS
Extreme (40°C)		11.65	7.65	11.68	0.00620	0.00407	0.00621	PASS
Extreme (30°C)		14.11	3.11	1.60	0.00751	0.00165	0.00085	PASS
Extreme (20°C)		14.50	11.50	2.28	0.00771	0.00612	0.00121	PASS
Extreme (10°C)		3.21	14.21	8.33	0.00171	0.00756	0.00443	PASS
Extreme (0°C)		15.65	5.65	15.90	0.00832	0.00300	0.00846	PASS
Extreme (-10°C)		4.78	7.78	1.21	0.00254	0.00414	0.00065	PASS
Extreme (-20°C)		5.55	17.55	17.32	0.00295	0.00934	0.00922	PASS
Extreme (-30°C)		4.20	11.20	4.94	0.00224	0.00596	0.00263	PASS
25°C	LV	15.08	11.08	13.59	0.00802	0.00589	0.00723	PASS
	HV	11.69	11.69	6.04	0.00622	0.00622	0.00321	PASS
Condition		Freq.Error	Freq.Error	Freq.Error	Frequency	Frequency	Frequency	Verdict
BANDWIDTH	10MHz	(Hz)	(Hz)	(Hz)	Stability	Stability	Stability	
Temperature	Voltage	64QAM	16QAM	QPSK	(ppm)	(ppm)	(ppm)	
Normal (25°C)	Normal	16.68	7.68	7.60	0.00887	0.00409	0.00404	PASS
Extreme (55°C)		10.28	13.28	3.78	0.00547	0.00706	0.00201	PASS
Extreme (50°C)		17.09	1.09	8.13	0.00909	0.00058	0.00432	PASS
Extreme (40°C)		6.47	3.47	9.14	0.00344	0.00184	0.00486	PASS
Extreme (30°C)		3.96	16.96	8.95	0.00210	0.00902	0.00476	PASS
Extreme (20°C)		12.81	14.81	10.39	0.00681	0.00788	0.00553	PASS
Extreme (10°C)		1.37	1.37	11.58	0.00073	0.00073	0.00616	PASS
Extreme (0°C)		5.89	11.89	13.01	0.00314	0.00633	0.00692	PASS
Extreme (-10°C)		14.69	2.69	14.08	0.00781	0.00143	0.00749	PASS
Extreme (-20°C)		16.93	11.93	15.19	0.00900	0.00634	0.00808	PASS
Extreme (-30°C)		11.75	6.75	2.67	0.00625	0.00359	0.00142	PASS
25°C		LV	12.86	4.86	9.86	0.00684	0.00259	0.00525
	HV	3.91	5.91	11.25	0.00208	0.00315	0.00598	PASS
Condition		Freq.Error	Freq.Error	Freq.Error	Frequency	Frequency	Frequency	Verdict
BANDWIDTH	15MHz	(Hz)	(Hz)	(Hz)	Stability	Stability	Stability	
Temperature	Voltage	64QAM	16QAM	QPSK	(ppm)	(ppm)	(ppm)	
Normal (25°C)	Normal	10.05	5.05	17.61	0.00534	0.00268	0.00937	PASS
Extreme (55°C)		14.05	5.05	4.03	0.00748	0.00269	0.00214	PASS
Extreme (50°C)		6.95	10.95	5.28	0.00369	0.00582	0.00281	PASS
Extreme (40°C)		3.54	3.54	1.84	0.00188	0.00188	0.00098	PASS
Extreme (30°C)		14.16	10.16	17.81	0.00753	0.00540	0.00947	PASS
Extreme (20°C)		8.79	8.79	9.69	0.00467	0.00467	0.00515	PASS
Extreme (10°C)		6.74	14.74	6.72	0.00359	0.00784	0.00357	PASS
Extreme (0°C)		4.15	12.15	5.64	0.00221	0.00646	0.00300	PASS
Extreme (-10°C)		1.20	5.20	4.14	0.00064	0.00277	0.00220	PASS
Extreme (-20°C)		11.93	17.93	8.69	0.00635	0.00954	0.00462	PASS



Extreme (-30°C)		17.92	6.92	6.84	0.00953	0.00368	0.00364	PASS
25°C	LV	16.30	15.30	2.14	0.00867	0.00814	0.00114	PASS
	HV	5.16	14.16	16.24	0.00275	0.00753	0.00864	PASS
Condition		Freq.Error	Freq.Error	Freq.Error	Frequency	Frequency	Frequency	Verdict
BANDWIDTH	20MHz	(Hz)	(Hz)	(Hz)	Stability	Stability	Stability	
Temperature	Voltage	(ppm)	(ppm)	(ppm)	(ppm)	(ppm)	(ppm)	
		64QAM	16QAM	QPSK	64QAM	16QAM	QPSK	
Normal (25°C)	Normal	9.09	1.09	7.22	0.00484	0.00058	0.00384	PASS
Extreme (55°C)		5.20	4.20	16.69	0.00277	0.00223	0.00888	PASS
Extreme (50°C)		9.65	9.65	17.25	0.00513	0.00513	0.00917	PASS
Extreme (40°C)		5.63	5.63	17.40	0.00300	0.00300	0.00926	PASS
Extreme (30°C)		16.85	1.85	8.20	0.00896	0.00098	0.00436	PASS
Extreme (20°C)		2.80	3.80	7.70	0.00149	0.00202	0.00410	PASS
Extreme (10°C)		11.06	10.06	13.46	0.00588	0.00535	0.00716	PASS
Extreme (0°C)		5.59	16.59	17.37	0.00297	0.00882	0.00924	PASS
Extreme (-10°C)		3.20	2.20	12.82	0.00170	0.00117	0.00682	PASS
Extreme (-20°C)		15.40	8.40	10.78	0.00819	0.00447	0.00573	PASS
Extreme (-30°C)		7.82	14.82	17.66	0.00416	0.00788	0.00939	PASS
25°C	LV	16.30	14.30	4.54	0.00867	0.00760	0.00242	PASS
	HV	4.27	12.27	11.75	0.00227	0.00653	0.00625	PASS

5.7.Spurious Emissions at Antenna Terminals

Ambient condition

Temperature	Relative humidity	Pressure
23°C ~25°C	45%~50%	101.5kPa

Method of Measurement

The EUT was connected to Spectrum Analyzer and Base Station Simulator via power Splitter. The measurement is carried out using a spectrum analyzer. The spectrum analyzer scans from 9kHz to the 10th harmonic of the carrier. The peak detector is used.

RBW is set to 100kHz, VBW is set to 300kHz for 30MHz~1GHz

RBW is set to 1MHz, VBW is set to 3MHz for above 1GHz, Sweep is set to ATUO.

The modulation mode and RB allocation refer to section 5.1, using the maximum output power configuration.

Test setup

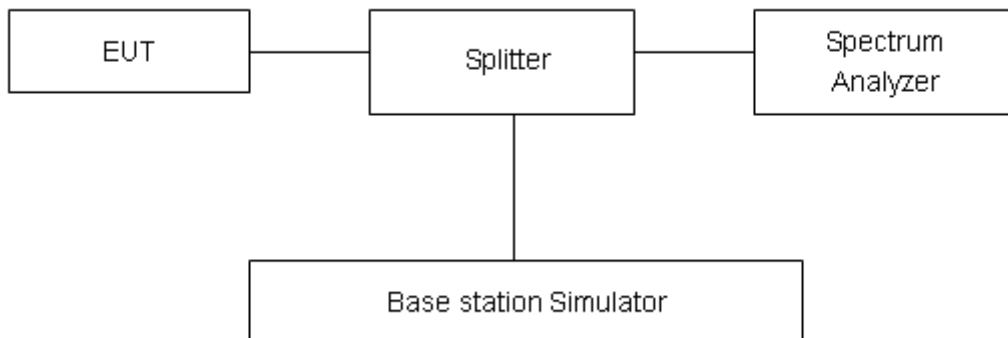

Limits

Rule Part 24.238(a) specifies that “on any frequency outside a licensee's frequency block, the power of any emission shall be attenuated below the transmitter power (P) by at least 43 + 10 log₁₀ (P) dB.”

Limit	-13 dBm
-------	---------

Measurement Uncertainty

The assessed measurement uncertainty to ensure 99.75% confidence level for the normal distribution is with the coverage factor $k = 1.96$.

Frequency	Uncertainty
9kHz-1GHz	0.684 dB
1GHz-20GHz	1.407 dB



Test Result

Sweep the whole frequency band through the range from 9kHz to the 10th harmonic of the carrier, the emissions more than 20 dB below the limit are not reported.

The signal beyond the limit is carrier.

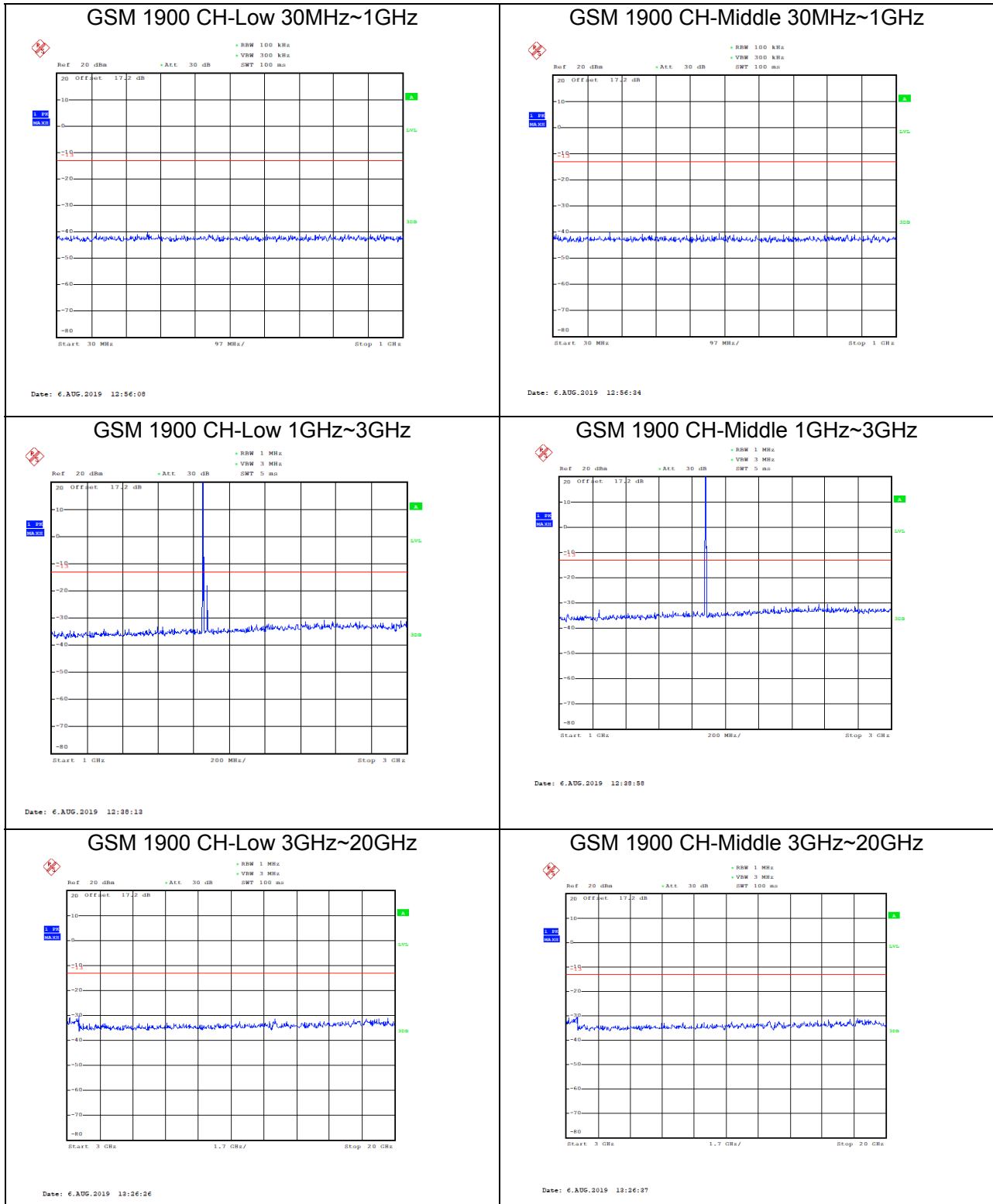



GSM 1900 CH-High 30MHz~1GHz

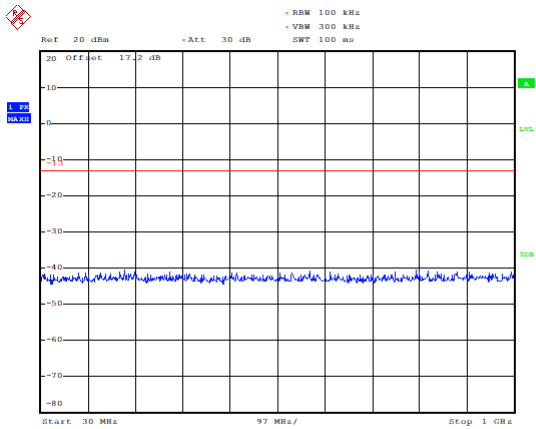

Date: 6.AUG.2019 12:57:06

GPRS 1900 CH-Low 30MHz~1GHz

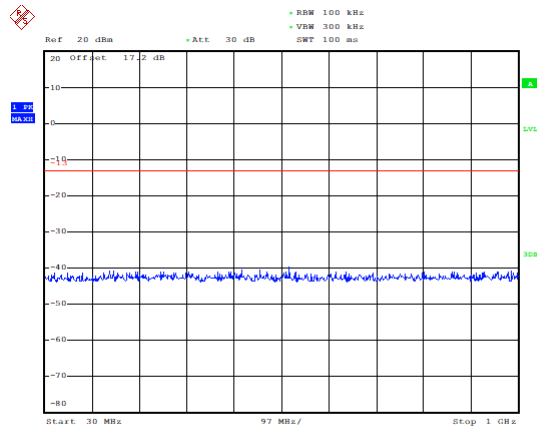

Date: 6.AUG.2019 12:02:34

GSM 1900 CH-High 1GHz~3GHz

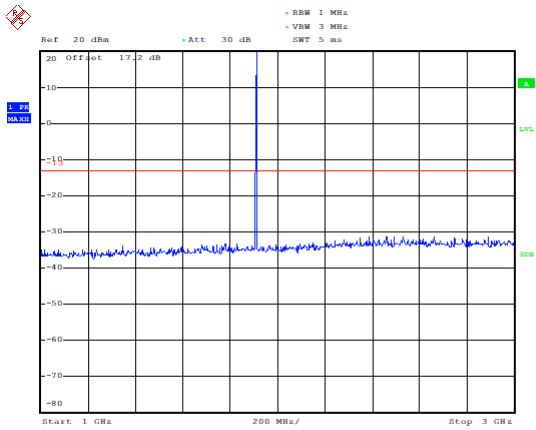

Date: 6.AUG.2019 12:09:38

GPRS 1900 CH-Low 1GHz~3GHz

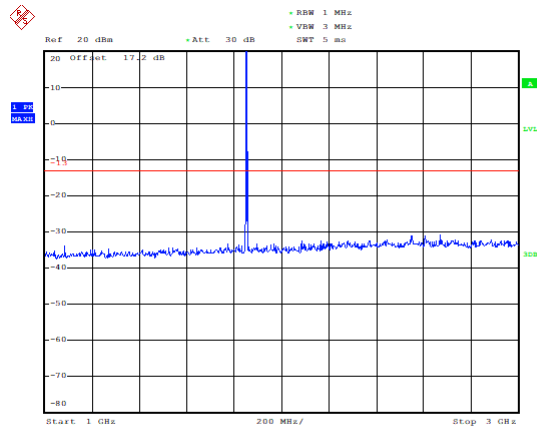

Date: 6.AUG.2019 12:46:24

GSM 1900 CH-High 3GHz~20GHz

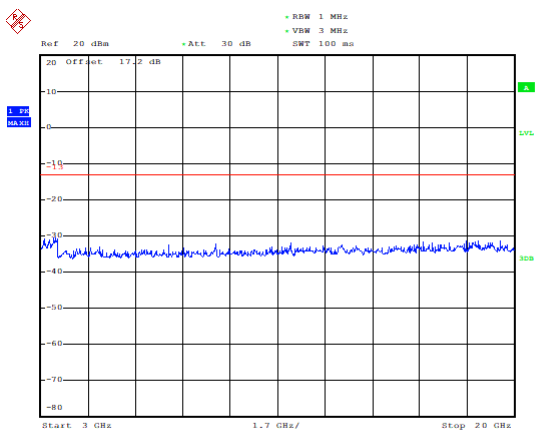

Date: 6.AUG.2019 13:26:47

GPRS 1900 CH-Low 3GHz~20GHz

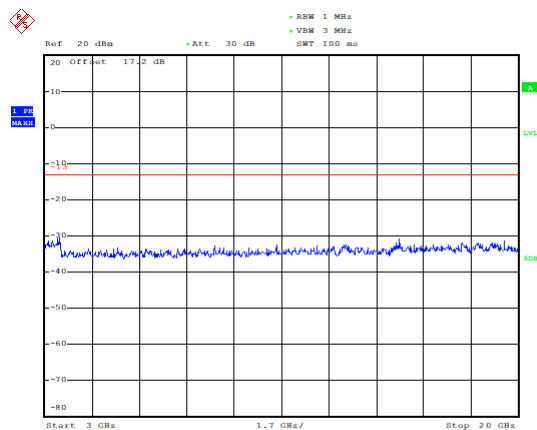

Date: 6.AUG.2019 13:25:48



GPRS 1900 CH-Middle 30MHz~1GHz

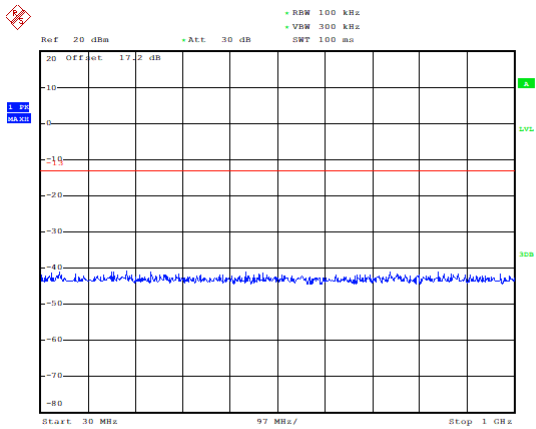

Date: 6.AUG.2019 13:03:49

GPRS 1900 CH-High 30MHz~1GHz

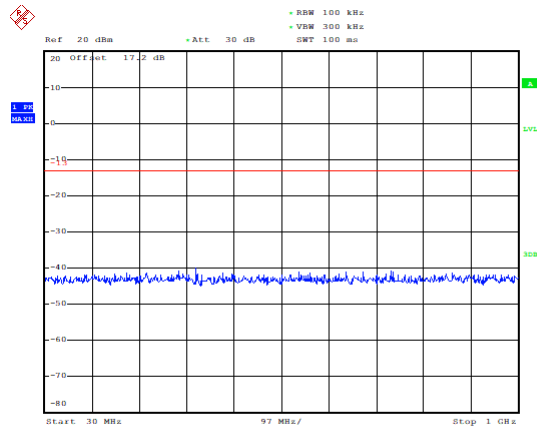

Date: 6.AUG.2019 13:04:04

GPRS 1900 CH-Middle 1GHz~3GHz

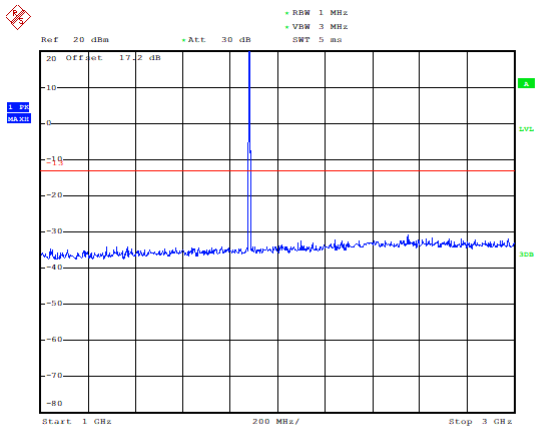

Date: 6.AUG.2019 12:46:57

GPRS 1900 CH-High 1GHz~3GHz

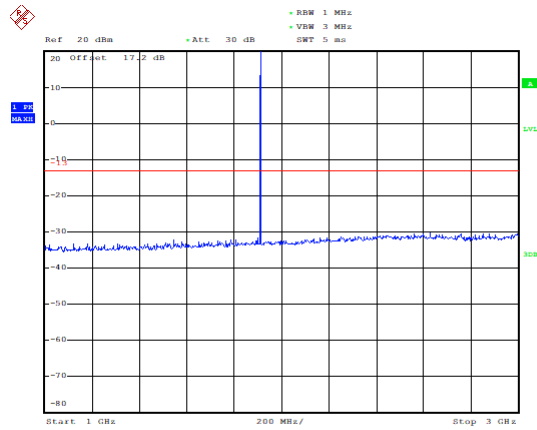

Date: 6.AUG.2019 12:46:05

GPRS 1900 CH-Middle 3GHz~20GHz

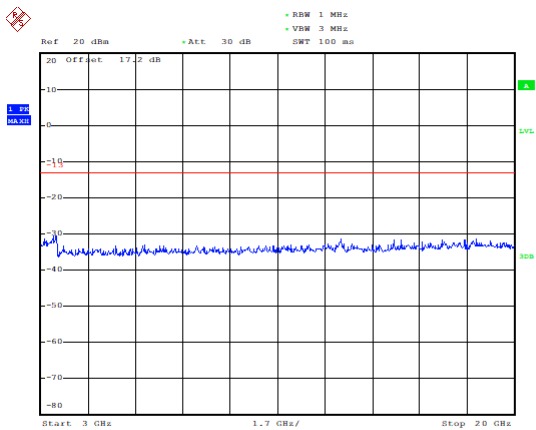

Date: 6.AUG.2019 13:25:59

GPRS 1900 CH-High 3GHz~20GHz

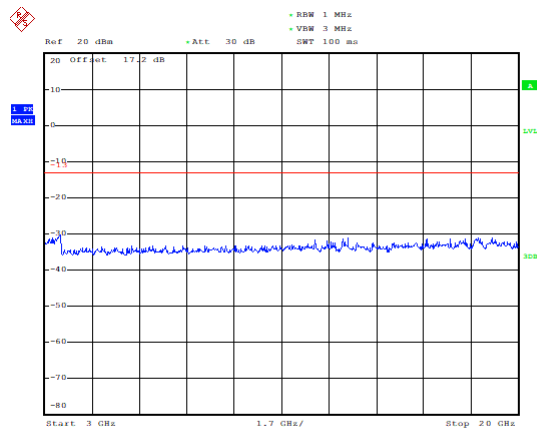

Date: 6.AUG.2019 13:26:10



EGPRS 1900 CH-Low 30MHz~1GHz

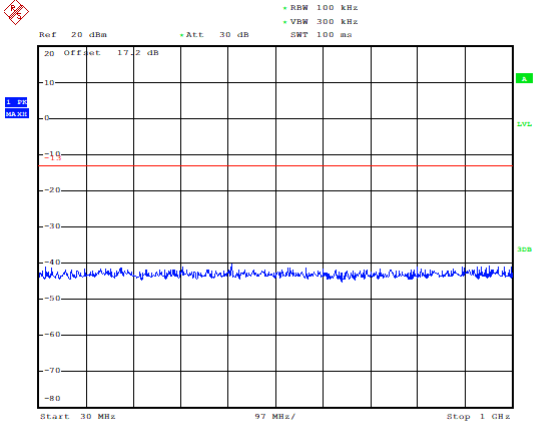

Date: 6.AUG.2019 13:11:46

EGPRS 1900 CH-Middle 30MHz~1GHz

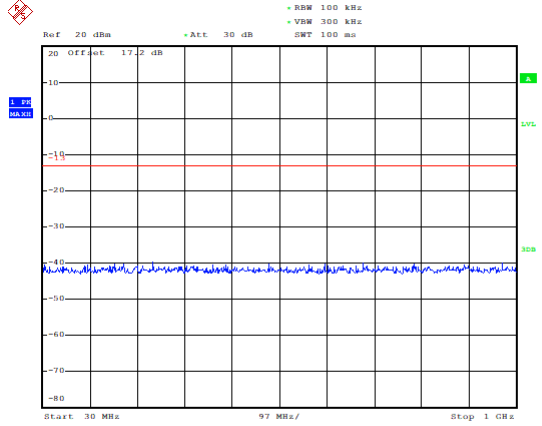

Date: 6.AUG.2019 13:13:06

EGPRS 1900 CH-Low 1GHz~3GHz

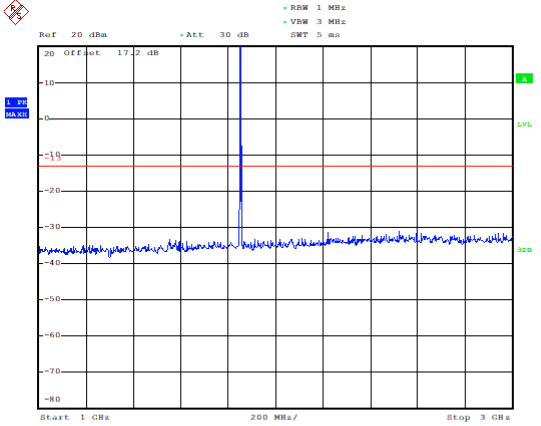

Date: 6.AUG.2019 12:48:47

EGPRS 1900 CH-Middle 1GHz~3GHz

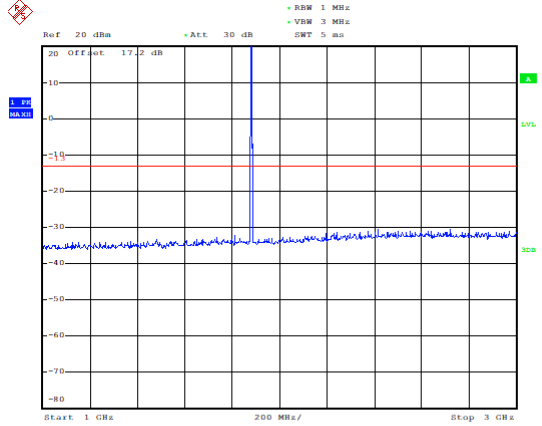

Date: 6.AUG.2019 12:51:09

EGPRS 1900 CH-Low 3GHz~20GHz

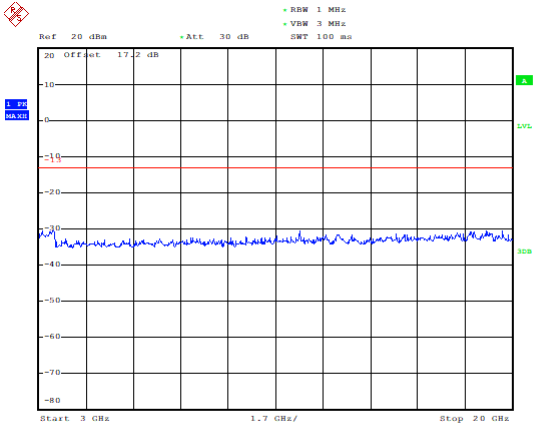

Date: 6.AUG.2019 13:19:05

EGPRS 1900 CH-Middle 3GHz~20GHz

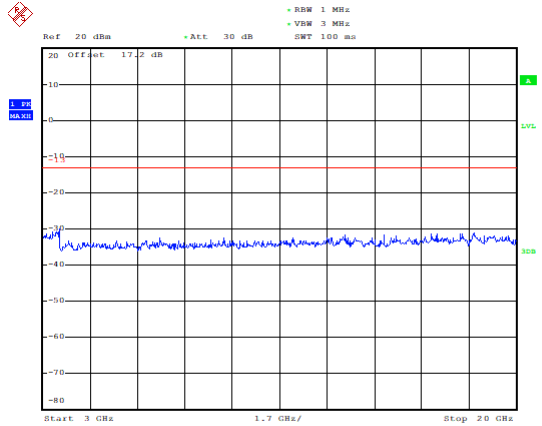

Date: 6.AUG.2019 13:19:27



EGPRS 1900 CH-High 30MHz~1GHz

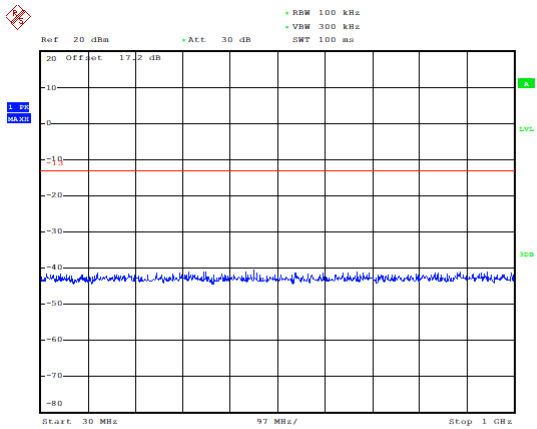

Date: 6.AUG.2019 13:13:20

WCDMA Band II CH-Low 30MHz~1GHz

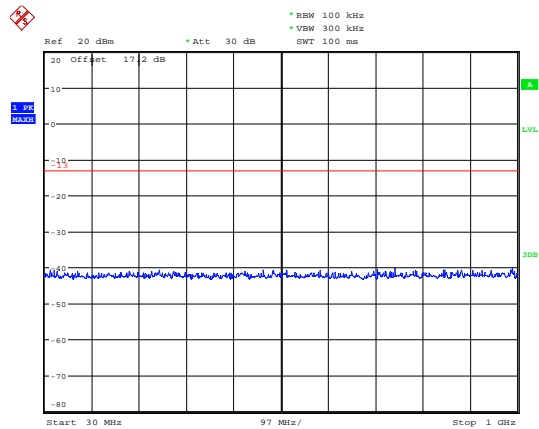

Date: 6.AUG.2019 16:05:10

EGPRS 1900 CH-High 1GHz~3GHz

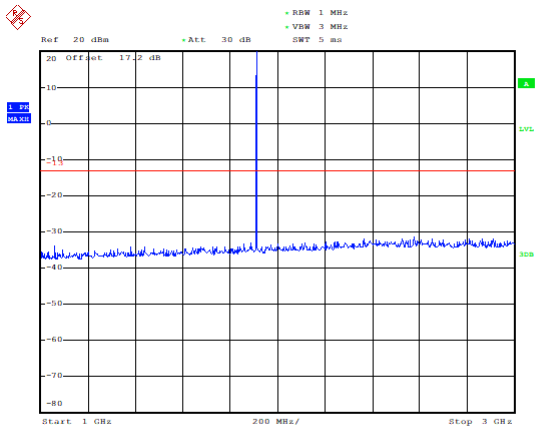

Date: 6.AUG.2019 12:51:39

WCDMA BAND II CH-Low 1GHz~3GHz

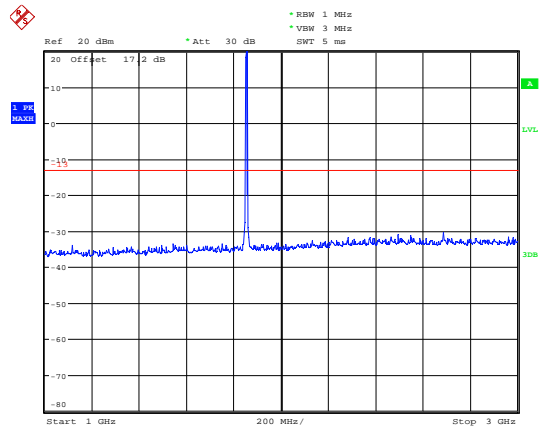

Date: 6.AUG.2019 16:25:55

EGPRS 1900 CH-High 3GHz~20GHz

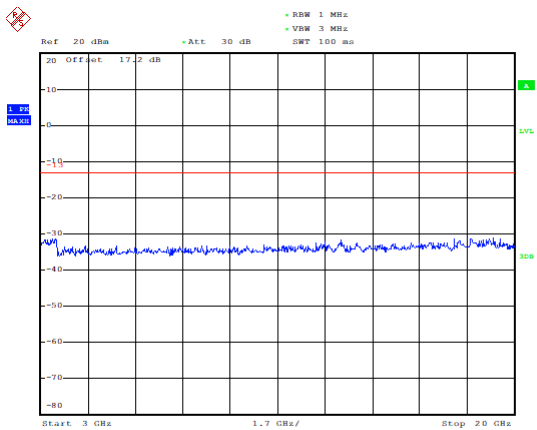

Date: 6.AUG.2019 13:19:49

WCDMA BAND II CH-Low 3GHz~20GHz

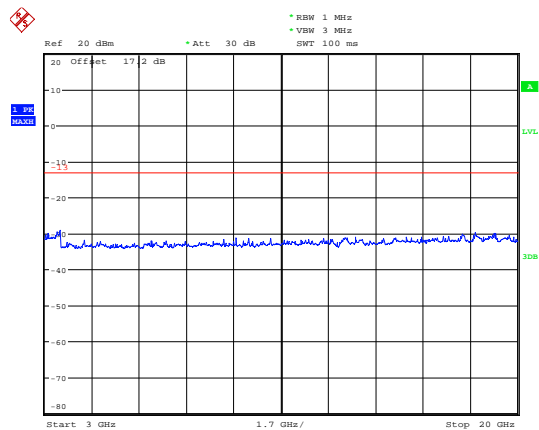

Date: 6.AUG.2019 16:54:53



WCDMA Band II CH- Middle 30MHz~1GHz

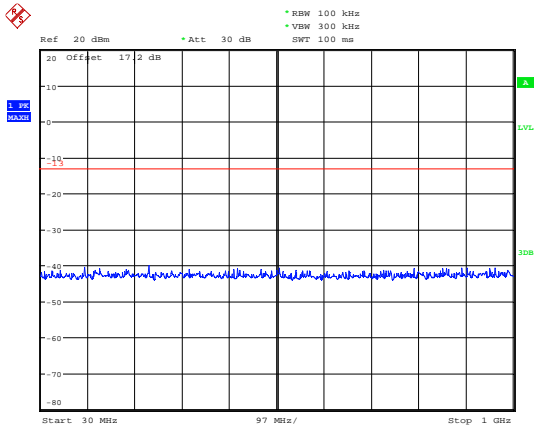

Date: 6.AUG.2019 16:05:55

WCDMA Band II CH- High 30MHz~1GHz

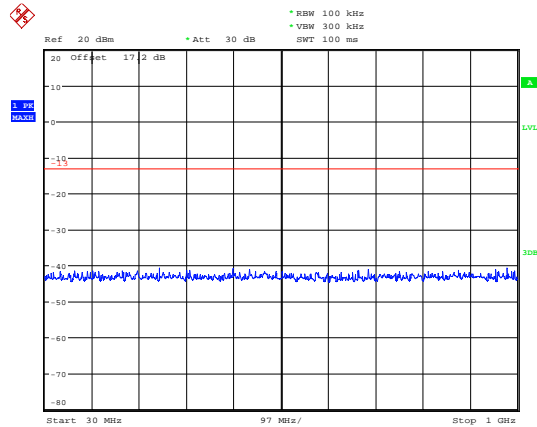

Date: 6.AUG.2019 16:06:19

WCDMA BAND II CH-Middle 1GHz~3GHz

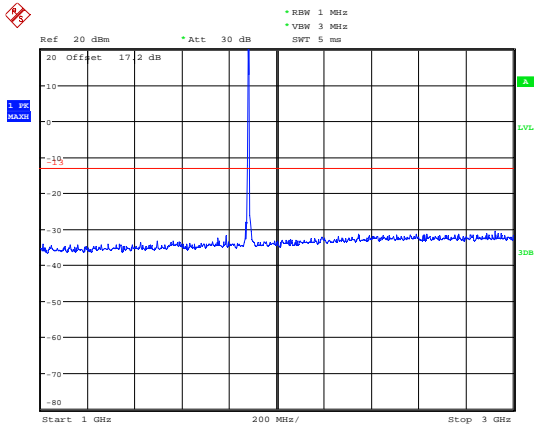

Date: 6.AUG.2019 16:27:08

WCDMA BAND II CH-High 1GHz~3GHz

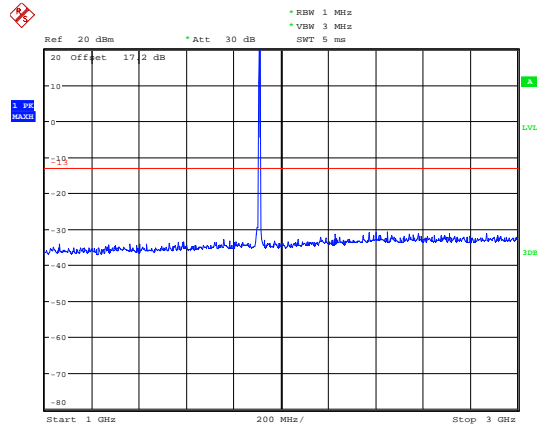

Date: 6.AUG.2019 16:31:03

WCDMA BAND II CH-Middle 3GHz~20GHz

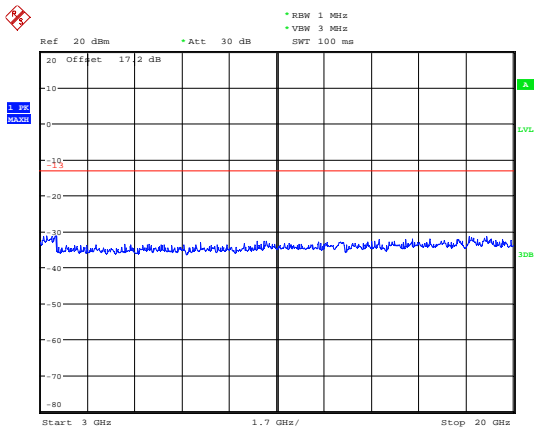

Date: 6.AUG.2019 16:55:05

WCDMA BAND II CH-High 3GHz~20GHz

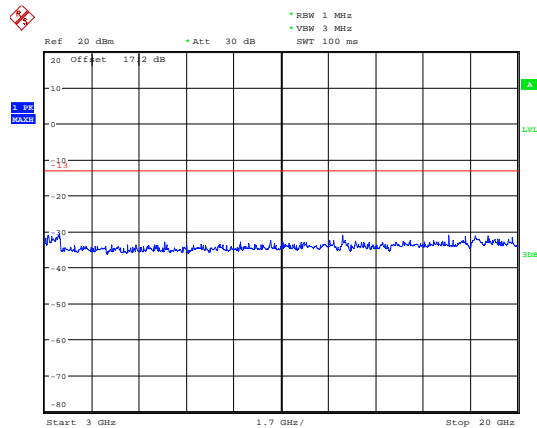

Date: 6.AUG.2019 16:58:35



LTE Band 2 1.4MHz CH-Low 30MHz~1GHz

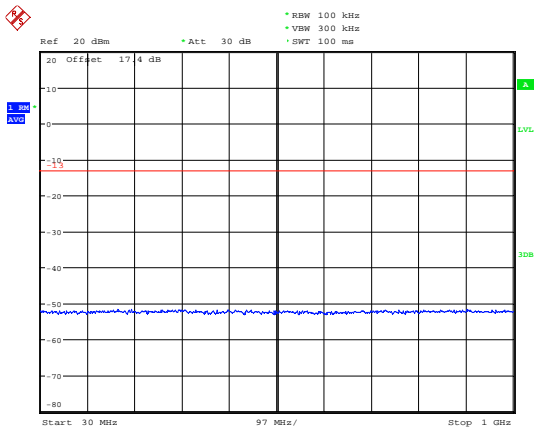

Date: 7.AUG.2019 20:14:47

LTE Band 2 1.4MHz CH-Middle 30MHz~1GHz

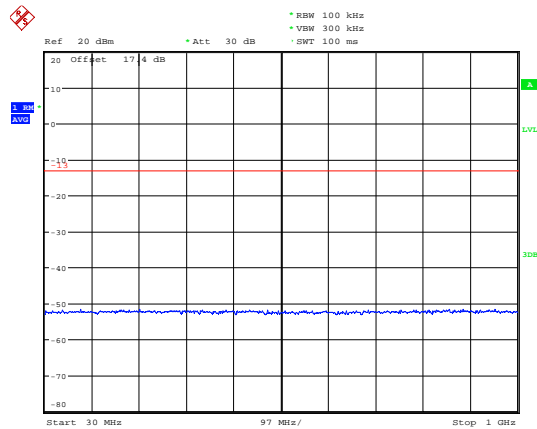

Date: 7.AUG.2019 20:15:11

LTE Band 2 1.4MHz CH-Low 1GHz~3GHz

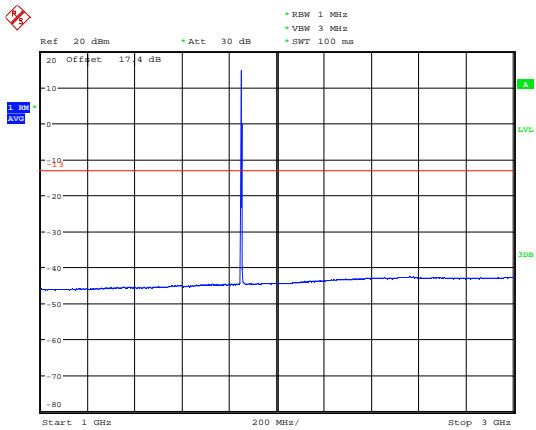

Date: 7.AUG.2019 20:34:11

LTE Band 2 1.4MHz CH-Middle 1GHz~3GHz

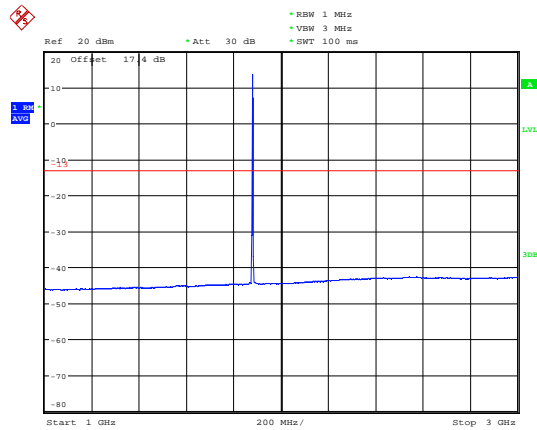

Date: 7.AUG.2019 20:34:46

LTE Band 2 1.4MHz CH-Low 3GHz~20GHz

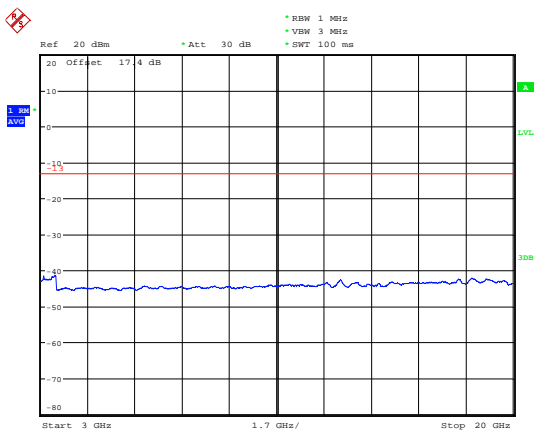

Date: 7.AUG.2019 20:54:28

LTE Band 2 1.4MHz CH-Middle 3GHz~20GHz

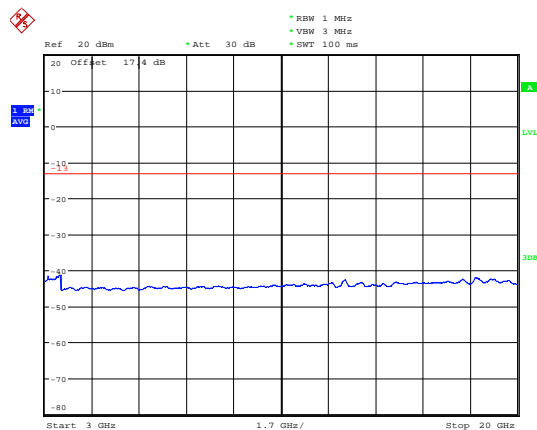

Date: 7.AUG.2019 20:54:45



LTE Band 2 1.4MHz CH-High 30MHz~1GHz

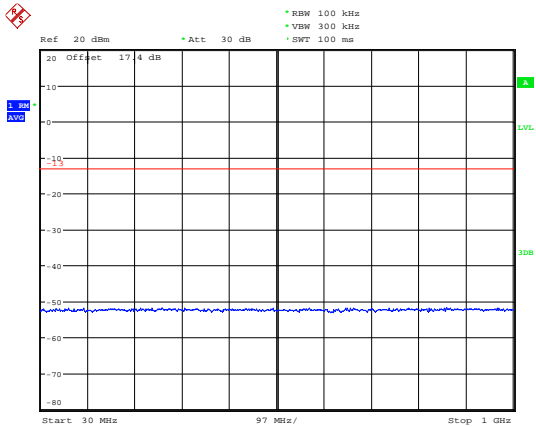

Date: 7.AUG.2019 20:15:31

LTE Band 2 3MHz CH-Low 30MHz~1GHz

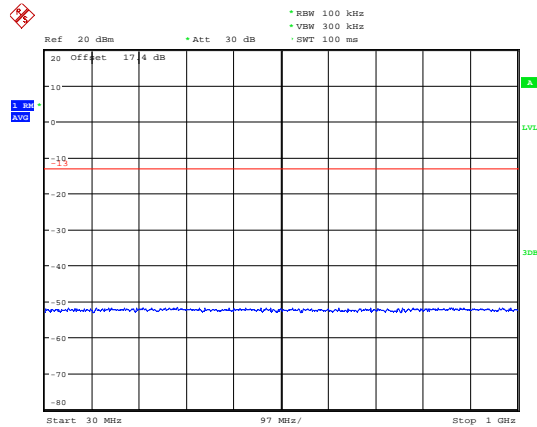

Date: 7.AUG.2019 20:15:58

LTE Band 2 1.4MHz CH-High 1GHz~3GHz

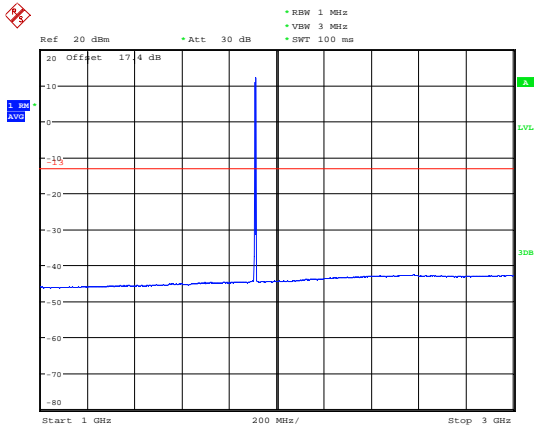

Date: 7.AUG.2019 20:35:48

LTE Band 2 3MHz CH-Low 1GHz~3GHz

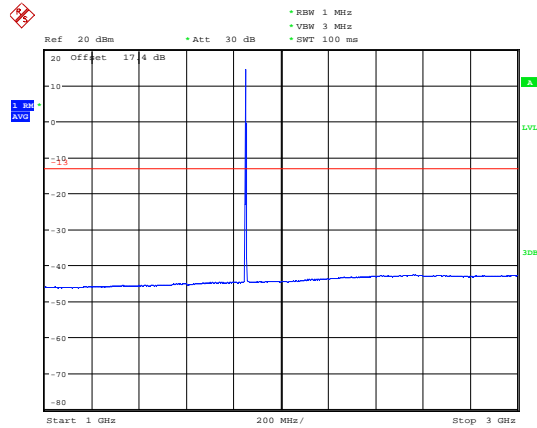

Date: 7.AUG.2019 20:39:23

LTE Band 2 1.4MHz CH-High 3GHz~20GHz

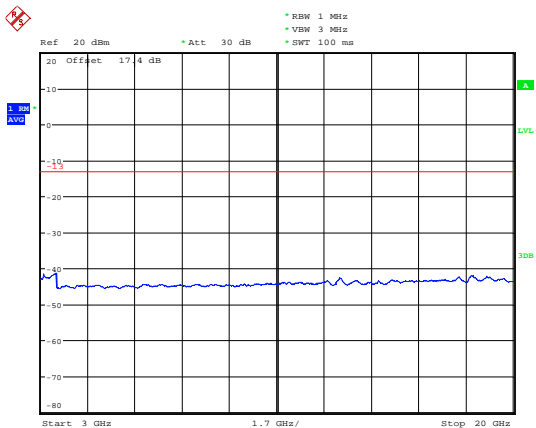

Date: 7.AUG.2019 20:54:57

LTE Band 2 3MHz CH-Low 3GHz~20GHz

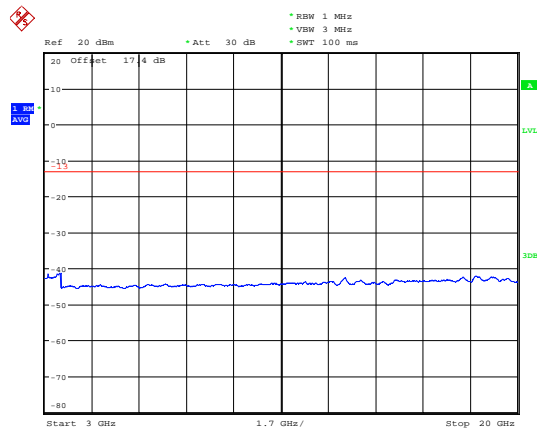

Date: 7.AUG.2019 20:55:51



LTE Band 2 3MHz CH-Middle 30MHz~1GHz

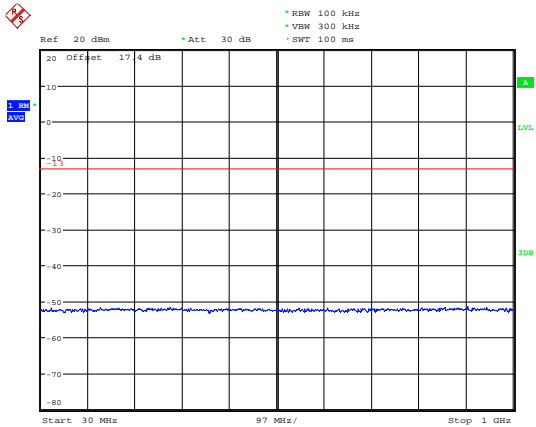

Date: 7.AUG.2019 20:16:39

LTE Band 2 3MHz CH-High 30MHz~1GHz

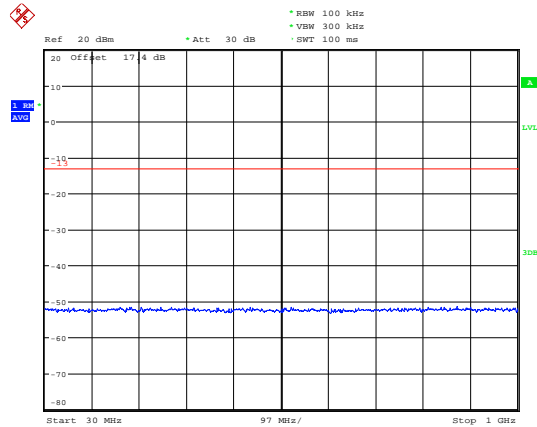

Date: 7.AUG.2019 20:16:58

LTE Band 2 3MHz CH-Middle 1GHz~3GHz

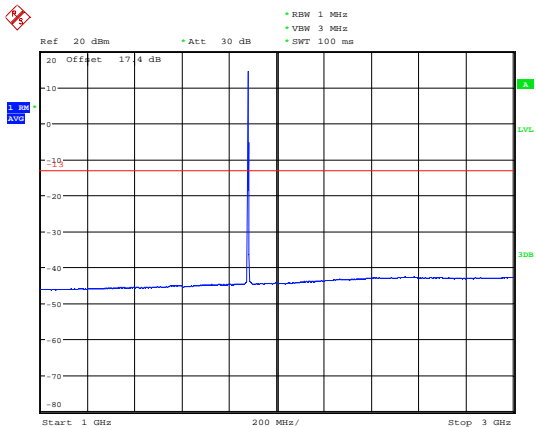

Date: 7.AUG.2019 20:40:08

LTE Band 2 3MHz CH-High 1GHz~3GHz

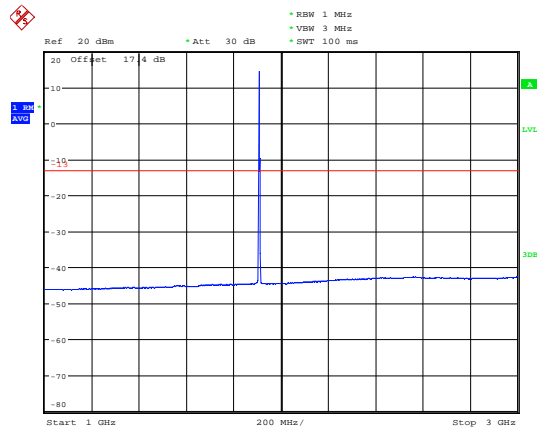

Date: 7.AUG.2019 20:40:44

LTE Band 2 3MHz CH-Middle 3GHz~20GHz

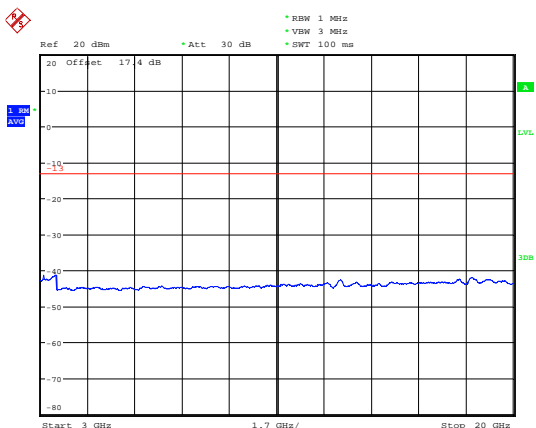

Date: 7.AUG.2019 20:56:02

LTE Band 2 3MHz CH-High 3GHz~20GHz

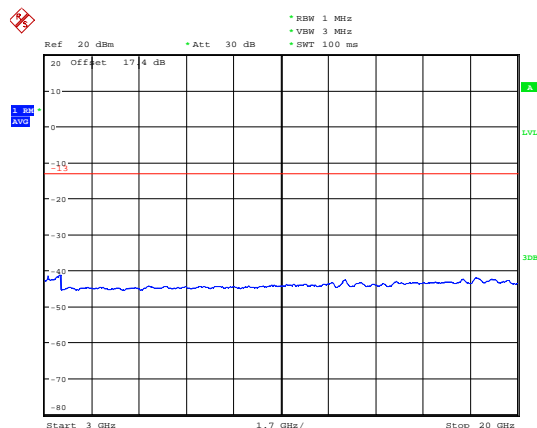

Date: 7.AUG.2019 20:56:32



LTE Band 2 5MHz CH-Low 30MHz~1GHz

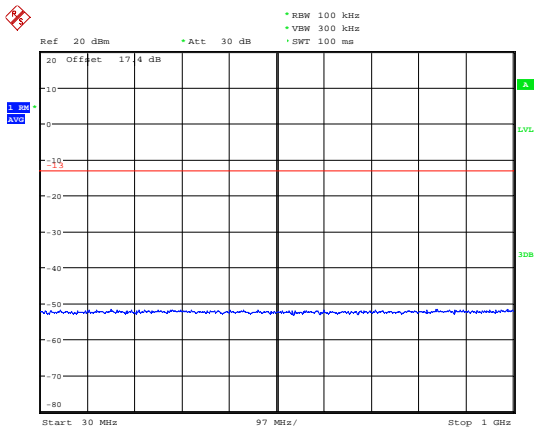

Date: 7.AUG.2019 20:17:36

LTE Band 2 5MHz CH-Middle 30MHz~1GHz

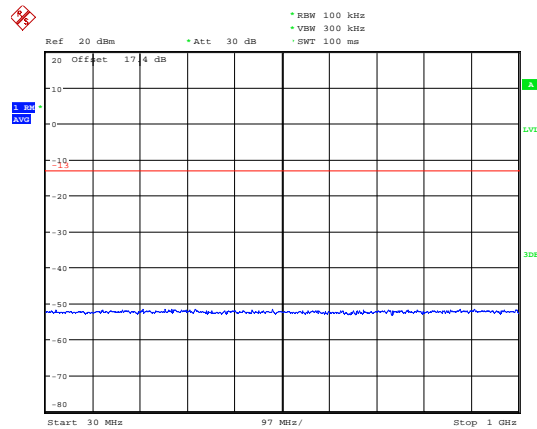

Date: 7.AUG.2019 20:17:54

LTE Band 2 5MHz CH-Low 1GHz~3GHz

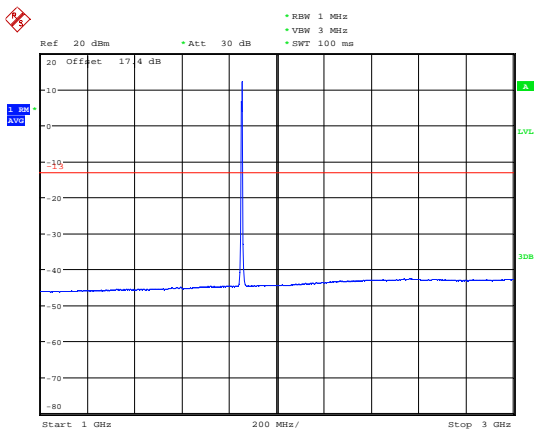

Date: 7.AUG.2019 20:42:21

LTE Band 2 5MHz CH-Middle 1GHz~3GHz

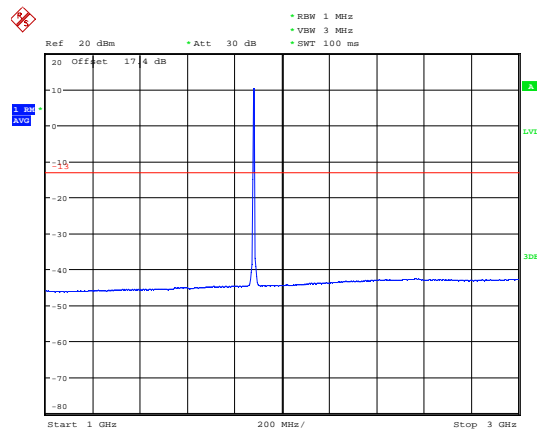

Date: 7.AUG.2019 20:42:44

LTE Band 2 5MHz CH-Low 3GHz~20GHz

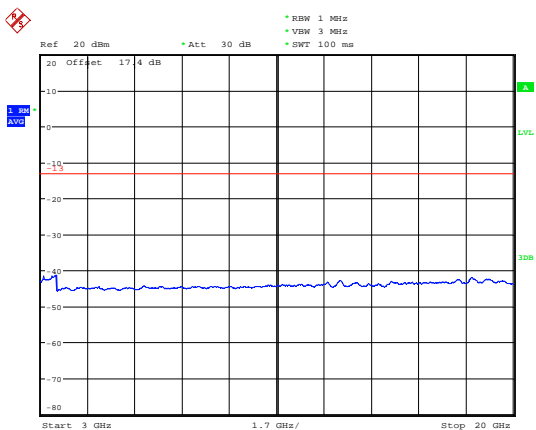

Date: 7.AUG.2019 20:57:04

LTE Band 2 5MHz CH-Middle 3GHz~20GHz

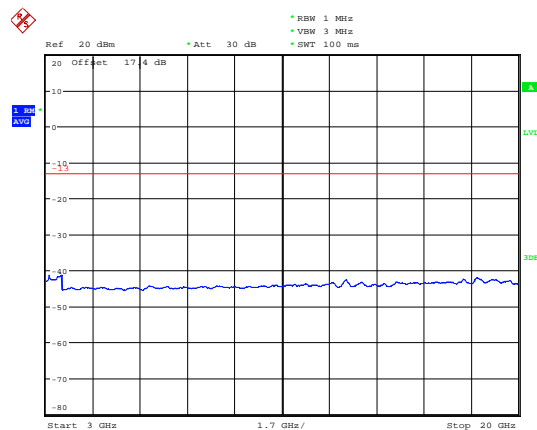

Date: 7.AUG.2019 20:58:09



LTE Band 2 5MHz CH-High 30MHz~1GHz

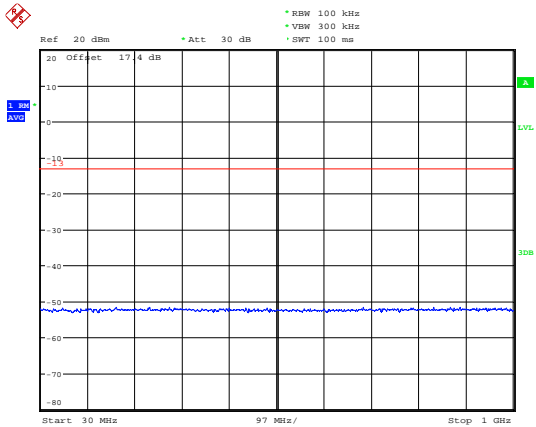

Date: 7.AUG.2019 20:18:13

LTE Band 2 10MHz CH-Low 30MHz~1GHz

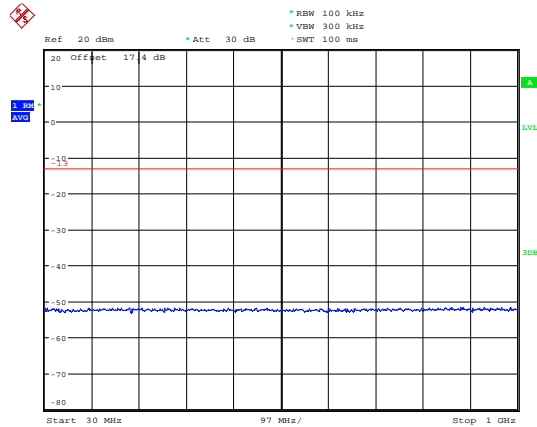

Date: 7.AUG.2019 20:19:26

LTE Band 2 5MHz CH-High 1GHz~3GHz

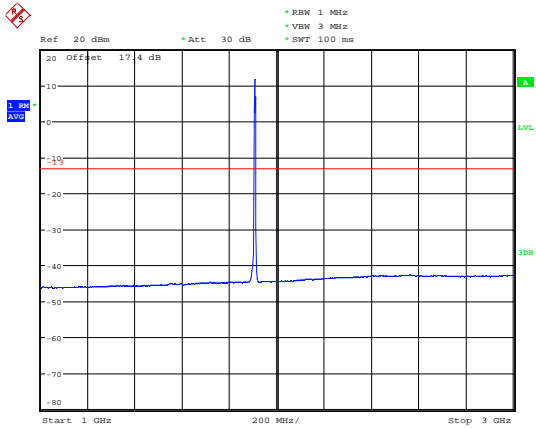

Date: 7.AUG.2019 20:43:39

LTE Band 2 10MHz CH-Low 1GHz~3GHz

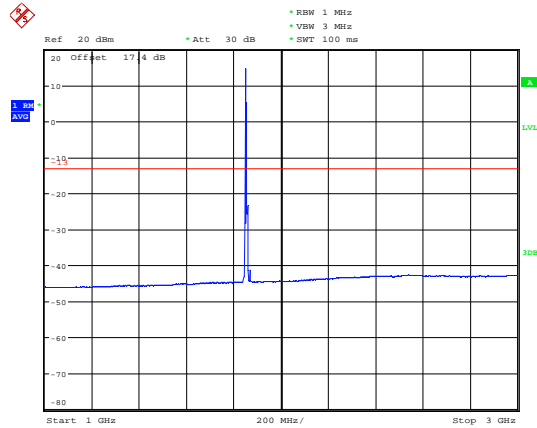

Date: 7.AUG.2019 20:49:09

LTE Band 2 5MHz CH-High 3GHz~20GHz

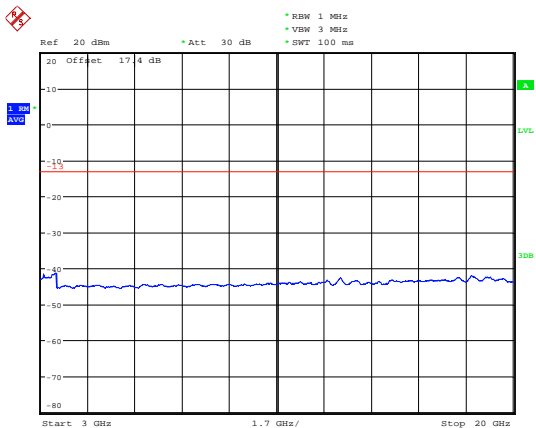

Date: 7.AUG.2019 20:58:28

LTE Band 2 10MHz CH-Low 3GHz~20GHz

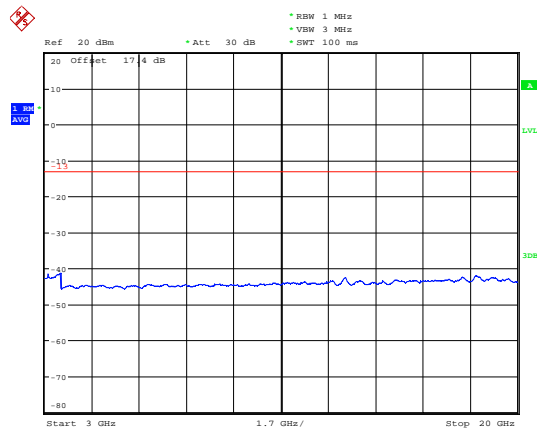

Date: 7.AUG.2019 20:58:47



LTE Band 2 10MHz CH-Middle 30MHz~1GHz

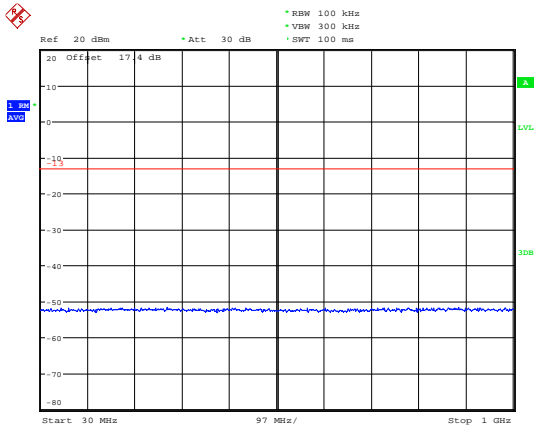

Date: 7.AUG.2019 20:20:11

LTE Band 2 10MHz CH-High 30MHz~1GHz

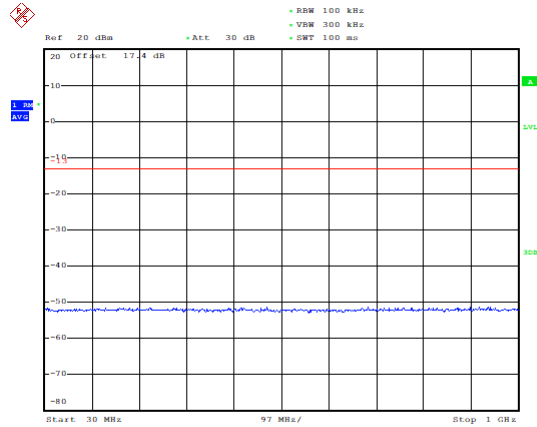

Date: 7.AUG.2019 20:20:23

LTE Band 2 10MHz CH-Middle 1GHz~3GHz

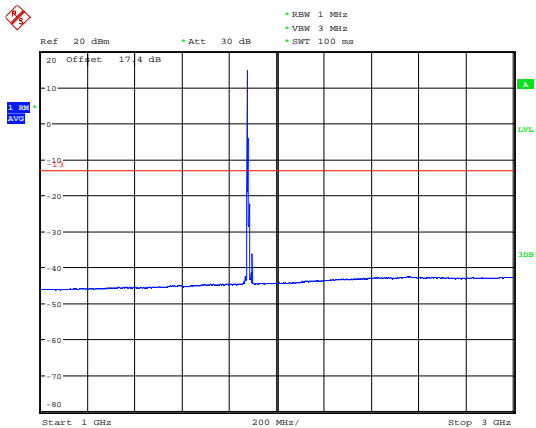

Date: 7.AUG.2019 20:49:47

LTE Band 2 10MHz CH-High 1GHz~3GHz

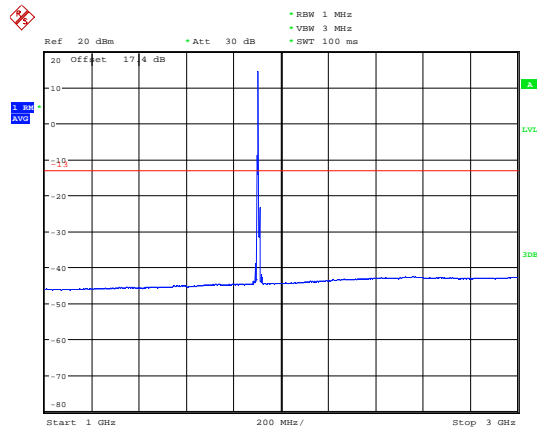

Date: 7.AUG.2019 20:48:31

LTE Band 2 10MHz CH-Middle 3GHz~20GHz

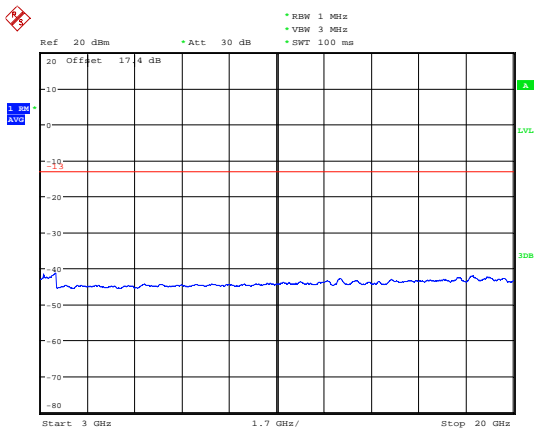

Date: 7.AUG.2019 20:58:59

LTE Band 2 10MHz CH-High 3GHz~20GHz

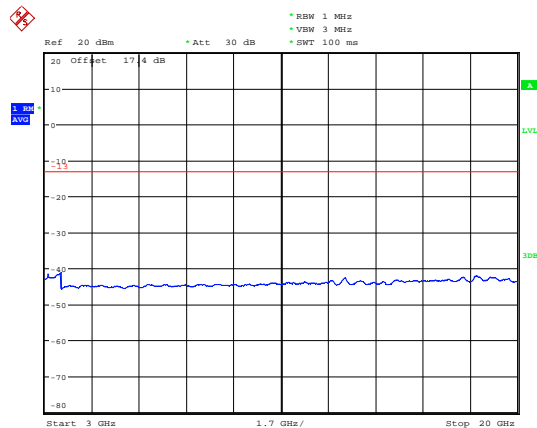

Date: 7.AUG.2019 20:59:26



LTE Band 2 15MHz CH-Low 30MHz~1GHz

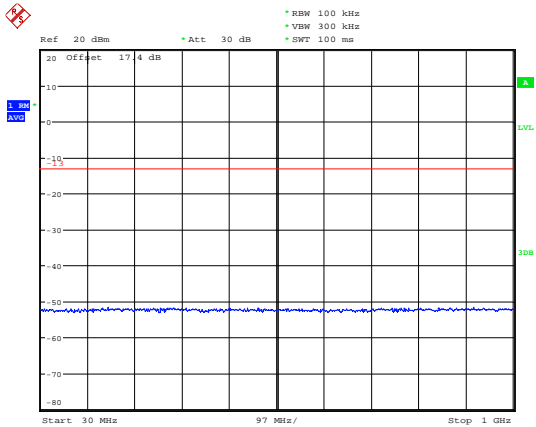

Date: 7.AUG.2019 20:21:37

LTE Band 2 15MHz CH-Middle 30MHz~1GHz

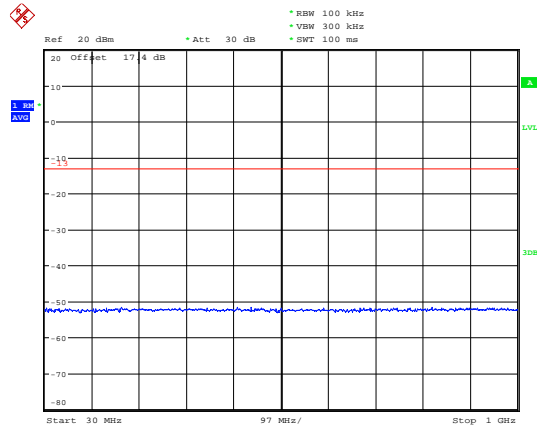

Date: 7.AUG.2019 20:26:29

LTE Band 2 15MHz CH-Low 1GHz~3GHz

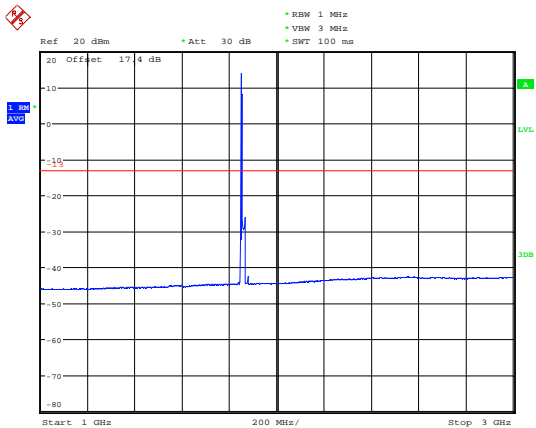

Date: 7.AUG.2019 20:51:52

LTE Band 2 15MHz CH-Middle 1GHz~3GHz

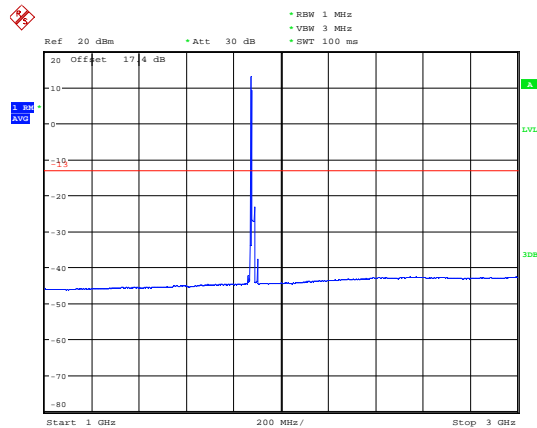

Date: 7.AUG.2019 20:52:12

LTE Band 2 15MHz CH-Low 3GHz~20GHz

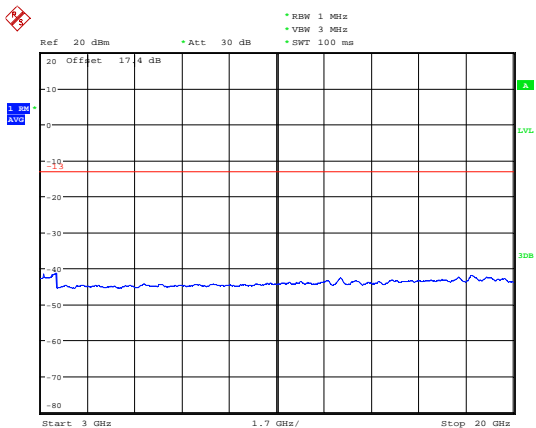

Date: 7.AUG.2019 21:00:06

LTE Band 2 15MHz CH-Middle 3GHz~20GHz

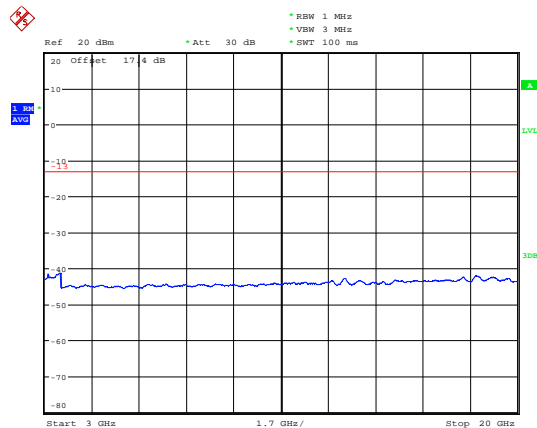

Date: 7.AUG.2019 21:00:25



LTE Band 2 15MHz CH-High 30MHz~1GHz

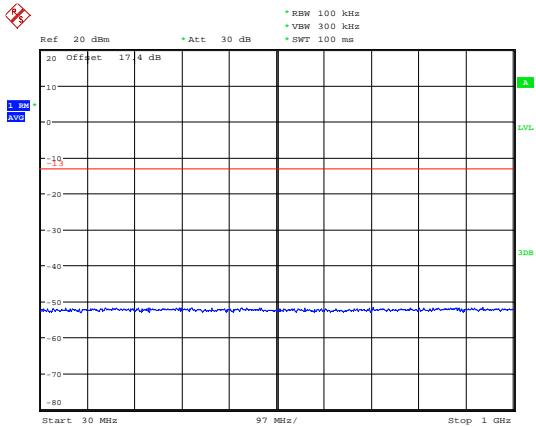

Date: 7.AUG.2019 20:26:56

LTE Band 2 20MHz CH-Low 30MHz~1GHz

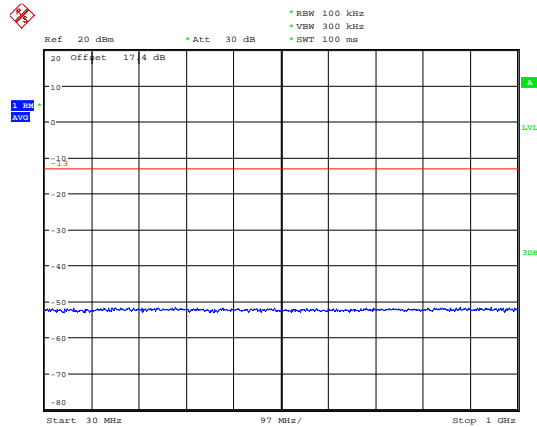

Date: 7.AUG.2019 20:28:42

LTE Band 2 15MHz CH-High 1GHz~3GHz

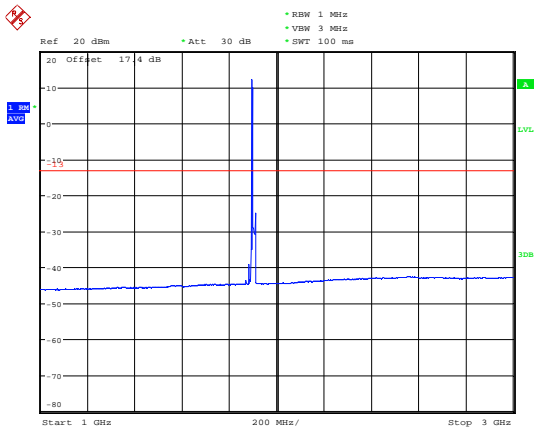

Date: 7.AUG.2019 20:52:24

LTE Band 2 20MHz CH-Low 1GHz~3GHz

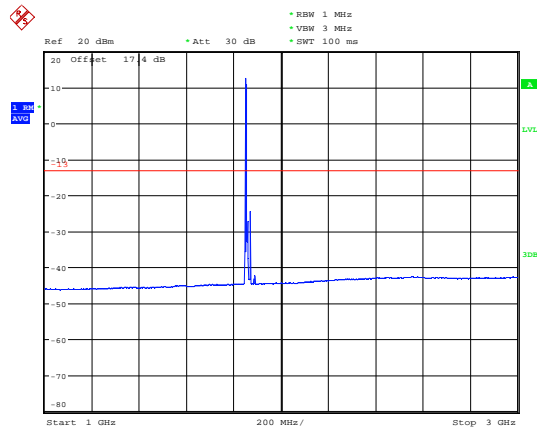

Date: 7.AUG.2019 20:52:44

LTE Band 2 15MHz CH-High 3GHz~20GHz

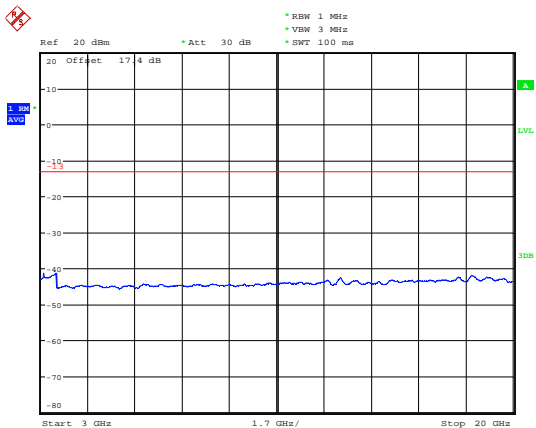

Date: 7.AUG.2019 21:01:02

LTE Band 2 20MHz CH-Low 3GHz~20GHz

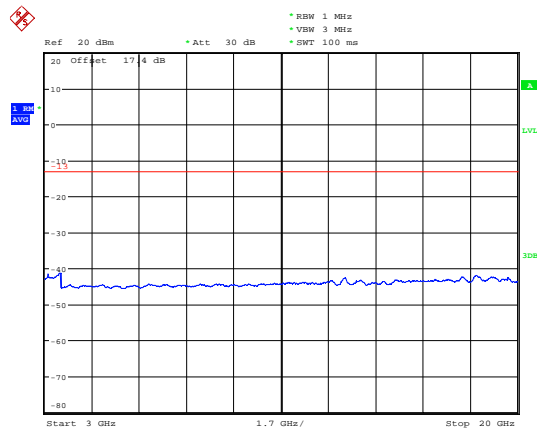

Date: 7.AUG.2019 21:01:24



LTE Band 2 20MHz CH-Middle 30MHz~1GHz

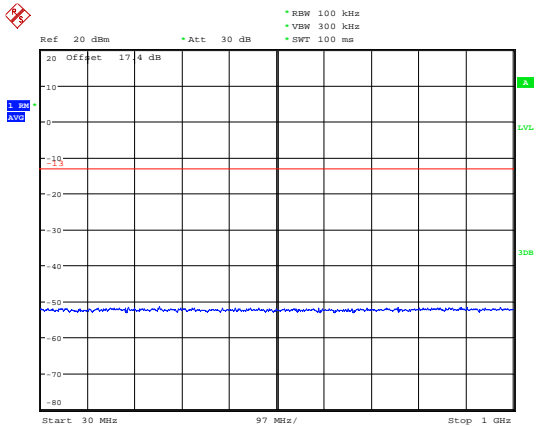

Date: 7.AUG.2019 20:28:54

LTE Band 2 20MHz CH-High 30MHz~1GHz

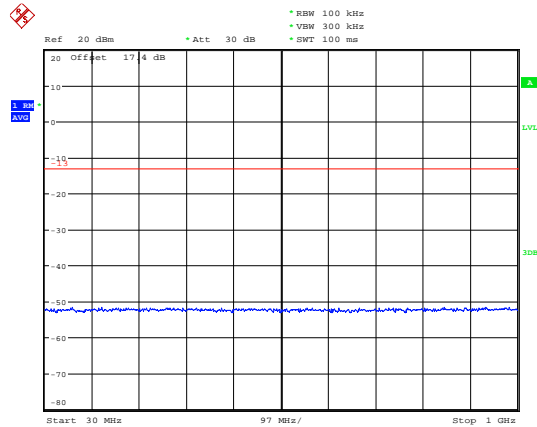

Date: 7.AUG.2019 20:29:04

LTE Band 2 20MHz CH-Middle 1GHz~3GHz

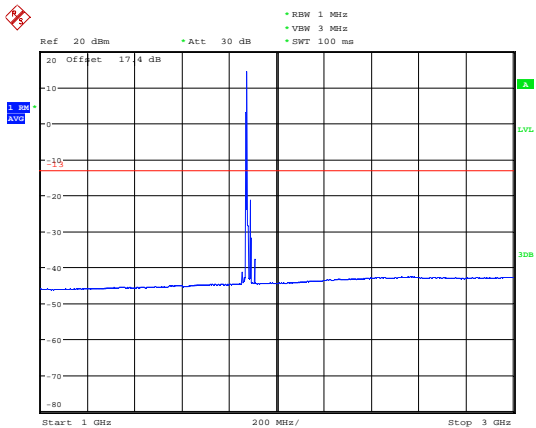

Date: 7.AUG.2019 20:53:01

LTE Band 2 20MHz CH-High 1GHz~3GHz

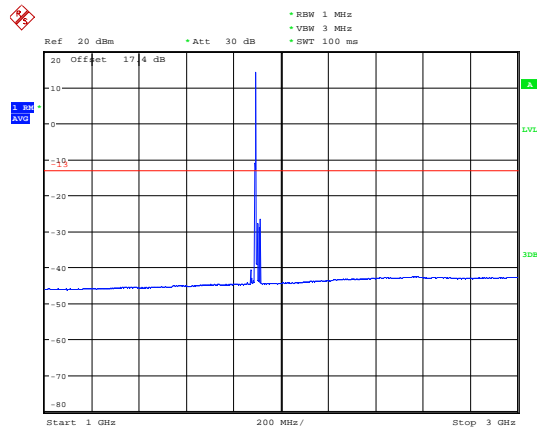

Date: 7.AUG.2019 20:53:25

LTE Band 2 20MHz CH-Middle 3GHz~20GHz

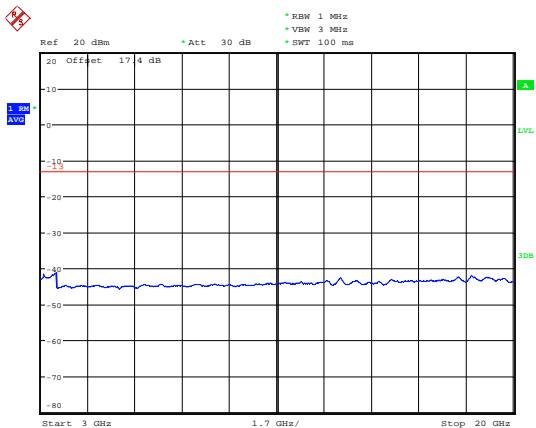

Date: 7.AUG.2019 21:02:03

LTE Band 2 20MHz CH-High 3GHz~20GHz

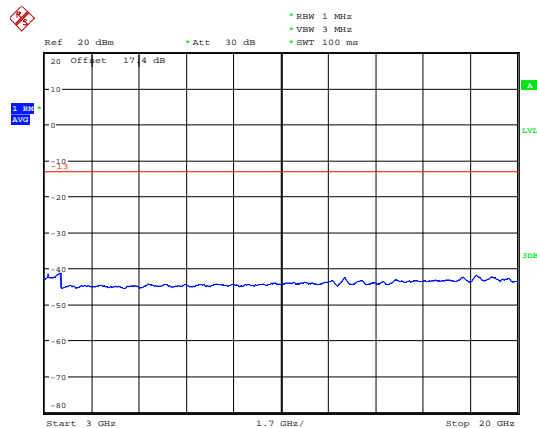

Date: 7.AUG.2019 21:02:27

5.8. Radiates Spurious Emission

Ambient condition

Temperature	Relative humidity	Pressure
23°C ~25°C	45%~50%	101.5kPa

Method of Measurement

- The testing follows FCC KDB 971168 v03r01 Section 5.8 and ANSI C63.26 (2015).
- Below 1GHz: The EUT is placed on a turntable 0.8 meters above the ground in the chamber, 3 meter away from the antenna. The maximal emission value is acquired by adjusting the antenna height, polarisation and turntable azimuth. Normally, the height range of antenna is 1 m to 4 m, the azimuth range of turntable is 0° to 360°, and the receive antenna has two polarizations Vertical (V) and Horizontal (H). Above 1GHz: (Note: the FCC's permission to use 1.5m as an alternative per TCBC Conf call of Dec. 2, 2014.) The EUT is placed on a turntable 1.5 meters above the ground in the chamber, 3 meter away from the antenna. The maximal emission value is acquired by adjusting the antenna height, polarisation and turntable azimuth. Normally, the height range of antenna is 1 m to 4 m, the azimuth range of turntable is 0° to 360°, and the receive antenna has two polarizations Vertical (V) and Horizontal (H).
- A loop antenna, A log-periodic antenna or horn antenna shall be substituted in place of the EUT. The log-periodic antenna will be driven by a signal generator and the level will be adjusted till the same power value on the spectrum analyzer or receiver. The level of the spurious emissions can be calculated through the level of the signal generator, cable loss, the gain of the substitution antenna and the reading of the spectrum analyzer or receiver.
- The EUT is then put into continuously transmitting mode at its maximum power level during the test. Set Test Receiver or Spectrum RBW=200Hz,VBW=600Hz for 9kHz150kHz , RBW=10kHz, VBW=30kHz 150kHz-30MHz , RBW=100kHz,VBW=300kHz for 30MHz to 1GHz and RBW=1MHz, VBW=3MHz for above 1GHz, And the maximum value of the receiver should be recorded as (Pr).
- The EUT shall be replaced by a substitution antenna. In the chamber, an substitution antenna for the frequency band of interest is placed at the reference point of the chamber. An RF Signal source for the frequency band of interest is connected to the substitution antenna with a cable that has been constructed to not interfere with the radiation pattern of the antenna. A power (PMea) is applied to the input of the substitution antenna, and adjust the level of the signal generator output until the value of the receiver reach the previously recorded (Pr). The power of signal source (PMea) is recorded. The test should be performed by rotating the test item and adjusting the receiving antenna polarization.
- A amplifier should be connected to the Signal Source output port. And the cable should be connect between the Amplifier and the Substitution Antenna. The cable loss (Pcl) ,the Substitution Antenna Gain (Ga) and the Amplifier Gain (PAg) should be recorded after test.
- The measurement results are obtained as described below:
 $Power(EIRP)=PMea- PAg - Pcl + Ga$
 The measurement results are amend as described below:
 $Power(EIRP)=PMea- Pcl + Ga$
- This value is EIRP since the measurement is calibrated using an antenna of known gain (2.15 dBi)

and known input power. ERP can be calculated from EIRP by subtracting the gain of the dipole, $ERP = EIRP - 2.15\text{dBi}$.

The modulation mode and RB allocation refer to section 5.1, using the maximum output power configuration.

Test setup

9KHz ~ 30MHz

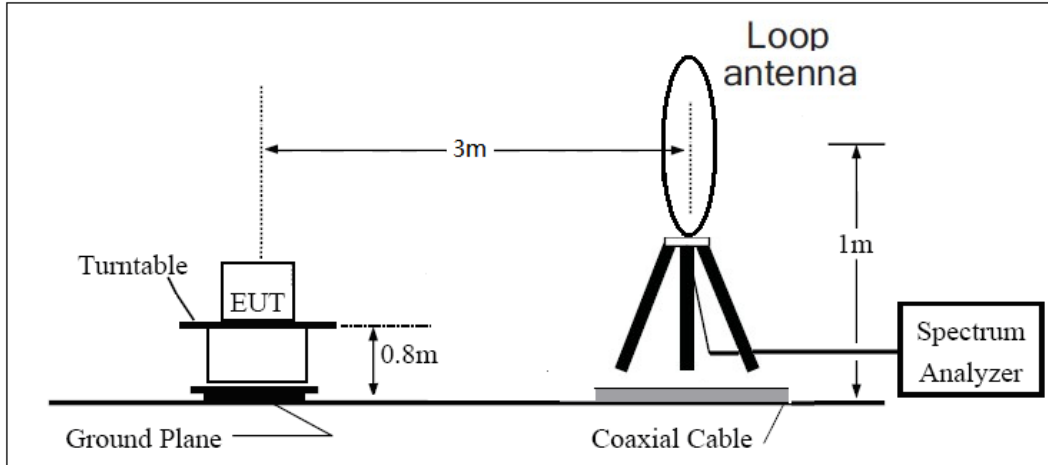

30MHz ~ 1GHz

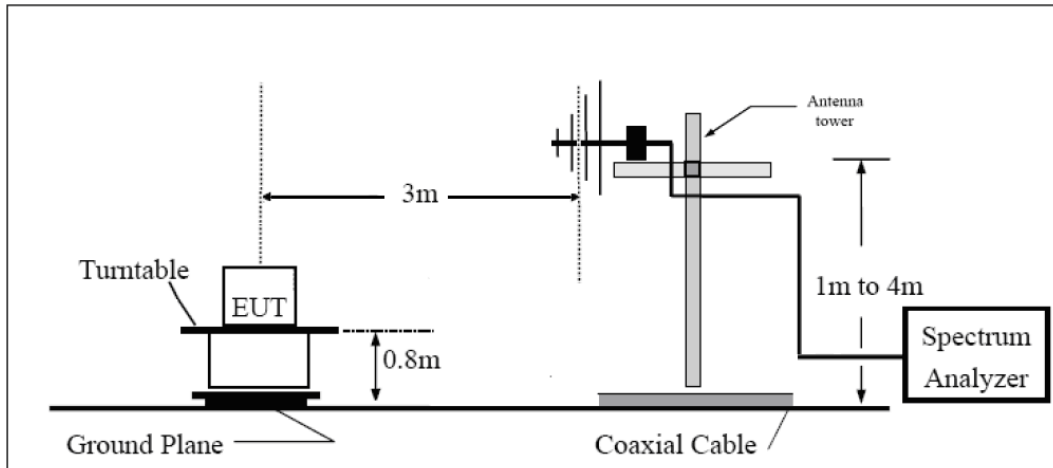

Above 1GHz

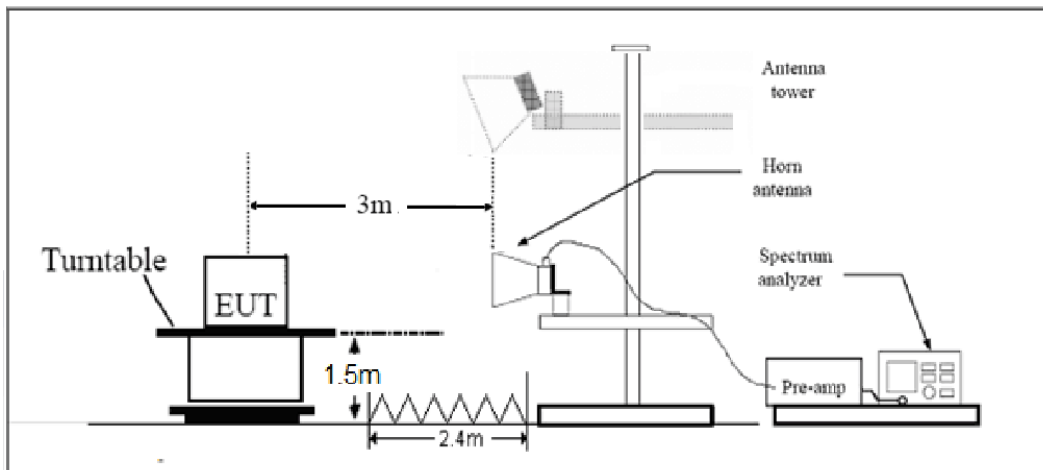



Note: Area side: 2.4mX3.6m

Limits

Rule Part 24.238(a) specifies that “on any frequency outside a licensee's frequency block, the power of any emission shall be attenuated below the transmitter power (P) by at least $43 + 10 \log_{10}(P)$ dB.”

Limit	-13 dBm
-------	---------

Measurement Uncertainty

The assessed measurement uncertainty to ensure 95% confidence level for the normal distribution is with the coverage factor $k = 1.96$, $U = 3.55$ dB.

Test Result

Sweep the whole frequency band through the range from 9kHz to the 10th harmonic of the carrier, the emissions below the noise floor will not be recorded in the report.

GSM 1900 CH-Middle

Harmonic	Frequency (MHz)	SG (dBm)	Cable Loss (dB)	Gain (dBi)	Antenna Polarization	EIRP Level (dBm)	Limit (dBm)	Margin (dB)	Azimuth (deg)
2	3760.00	-56.25	5.10	11.05	Horizontal	-50.30	-13.00	37.30	0
3	5640.00	-57.83	5.42	12.65	Horizontal	-50.60	-13.00	37.60	45
4	7520.00	-58.55	6.70	13.85	Horizontal	-51.40	-13.00	38.40	225
5	9400.00	-55.84	7.01	14.75	Horizontal	-48.10	-13.00	35.10	270
6	11280.00	-57.47	7.48	15.95	Horizontal	-49.00	-13.00	36.00	45
7	13160.00	-54.24	7.51	16.55	Horizontal	-45.20	-13.00	32.20	135
8	15040.00	-52.81	8.24	15.35	Horizontal	-45.70	-13.00	32.70	90
9	16920.00	-50.54	8.41	14.95	Horizontal	-44.00	-13.00	31.00	315
10	18800.00	-	-	-	-	-	-	-	-

Note: 1. The other Spurious RF Radiated emissions level is no more than noise floor.
 2. The worst emission was found in the antenna is Horizontal position.

WCDMA Band II CH-Middle

Harmonic	Frequency (MHz)	SG (dBm)	Cable Loss (dB)	Gain (dBi)	Antenna Polarization	EIRP Level (dBm)	Limit (dBm)	Margin (dB)	Azimuth (deg)
2	3760.00	-64.12	5.10	11.05	Horizontal	-58.17	-13.00	45.17	45
3	5640.00	-63.69	5.42	12.65	Horizontal	-56.46	-13.00	43.46	180
4	7520.00	-58.63	6.70	13.85	Horizontal	-51.48	-13.00	38.48	45
5	9400.00	-57.08	7.01	14.75	Horizontal	-49.34	-13.00	36.34	0
6	11280.00	-56.20	7.48	15.95	Horizontal	-47.73	-13.00	34.73	270
7	13160.00	-55.25	7.51	16.55	Horizontal	-46.21	-13.00	33.21	315
8	15040.00	-53.07	8.24	15.35	Horizontal	-45.96	-13.00	32.96	45
9	16920.00	-49.77	8.41	14.95	Horizontal	-43.23	-13.00	30.23	90
10	18800.00	-	-	-	-	-	-	-	-

Note: 1. The other Spurious RF Radiated emissions level is no more than noise floor.
 2. The worst emission was found in the antenna is Horizontal position.



LTE Band 2 1.4MHz CH-Middle

Harmonic	Frequency (MHz)	SG (dBm)	Cable Loss (dB)	Gain (dBi)	Antenna Polarization	EIRP Level (dBm)	Limit (dBm)	Margin (dB)	Azimuth (deg)
2	3759.00	-59.87	5.10	11.05	Horizontal	-53.92	-13.00	40.92	135
3	5638.88	-62.17	5.42	12.65	Horizontal	-54.94	-13.00	41.94	90
4	7520.00	-58.29	6.70	13.85	Horizontal	-51.14	-13.00	38.14	225
5	9400.00	-55.68	7.01	14.75	Horizontal	-47.94	-13.00	34.94	180
6	11280.00	-56.27	7.48	15.95	Horizontal	-47.80	-13.00	34.80	45
7	13160.00	-55.49	7.51	16.55	Horizontal	-46.45	-13.00	33.45	0
8	15040.00	-52.38	8.24	15.35	Horizontal	-45.27	-13.00	32.27	90
9	16920.00	-50.14	8.41	14.95	Horizontal	-43.60	-13.00	30.60	225
10	18800.00	-	-	-	-	-	-	-	-

Note: 1. The other Spurious RF Radiated emissions level is no more than noise floor.

2. The worst emission was found in the antenna is Horizontal position.

LTE Band 2 5MHz CH-Middle

Harmonic	Frequency (MHz)	SG (dBm)	Cable Loss (dB)	Gain (dBi)	Antenna Polarization	EIRP Level (dBm)	Limit (dBm)	Margin (dB)	Azimuth (deg)
2	3755.63	-59.61	5.10	11.05	Horizontal	-53.66	-13.00	40.66	90
3	5633.63	-61.71	5.42	12.65	Horizontal	-54.48	-13.00	41.48	135
4	7520.00	-57.75	6.70	13.85	Horizontal	-50.60	-13.00	37.60	315
5	9400.00	-55.34	7.01	14.75	Horizontal	-47.60	-13.00	34.60	270
6	11280.00	-54.77	7.48	15.95	Horizontal	-46.30	-13.00	33.30	225
7	13160.00	-54.34	7.51	16.55	Horizontal	-45.30	-13.00	32.30	90
8	15040.00	-52.21	8.24	15.35	Horizontal	-45.10	-13.00	32.10	45
9	16920.00	-49.24	8.41	14.95	Horizontal	-42.70	-13.00	29.70	0
10	18800.00	-	-	-	-	-	-	-	-

Note: 1. The other Spurious RF Radiated emissions level is no more than noise floor.

2. The worst emission was found in the antenna is Horizontal position.



LTE Band 2 20MHz CH-Middle

Harmonic	Frequency (MHz)	SG (dBm)	Cable Loss (dB)	Gain (dBi)	Antenna Polarization	EIRP Level (dBm)	Limit (dBm)	Margin (dB)	Azimuth (deg)
2	3742.13	-60.64	5.10	11.05	Horizontal	-54.69	-13.00	41.69	315
3	5613.38	-62.21	5.42	12.65	Horizontal	-54.98	-13.00	41.98	45
4	7484.63	-57.95	6.70	13.85	Horizontal	-50.80	-13.00	37.80	90
5	9400.00	-55.54	7.01	14.75	Horizontal	-47.80	-13.00	34.80	180
6	11280.00	-53.87	7.48	15.95	Horizontal	-45.40	-13.00	32.40	270
7	13160.00	-54.24	7.51	16.55	Horizontal	-45.20	-13.00	32.20	225
8	15040.00	-52.11	8.24	15.35	Horizontal	-45.00	-13.00	32.00	135
9	16920.00	-49.94	8.41	14.95	Horizontal	-43.40	-13.00	30.40	90
10	18800.00	-	-	-	-	-	-	-	-

Note: 1. The other Spurious RF Radiated emissions level is no more than noise floor.

2. The worst emission was found in the antenna is Horizontal position.

6. Main Test Instruments

Name	Manufacturer	Type	Serial Number	Calibration Date	Expiration Date
Base Station Simulator	R&S	CMU200	118133	2019-05-19	2020-05-18
Base Station Simulator	R&S	CMW500	113824	2019-05-19	2020-05-18
Power Splitter	Hua Xiang	SHX-GF2-2-13	10120101	/	/
Spectrum Analyzer	Key sight	N9010A	MY50210259	2019-05-19	2020-05-18
Universal Radio Communication Tester	Key sight	E5515C	MY48367192	2019-05-19	2020-05-18
Signal Analyzer	R&S	FSV30	100815	2018-12-16	2019-12-15
Loop Antenna	SCHWARZBECK	FMZB1519	1519-047	2017-09-26	2019-09-25
Trilog Antenna	SCHWARZBECK	VUBL 9163	9163-201	2017-11-18	2019-11-17
Horn Antenna	R&S	HF907	100126	2018-07-07	2020-07-06
Horn Antenna	ETS-Lindgren	3160-09	00102643	2018-06-20	2020-06-19
Signal generator	R&S	SMB 100A	102594	2019-05-19	2020-05-18
Climatic Chamber	ESPEC	SU-242	93000506	2017-12-17	2020-12-16
Preamplifier	R&S	SCU18	102327	2019-05-19	2020-05-18
MOB COMMS DC SUPPLY	Keysight	66319D	MY43004105	2019-05-19	2020-05-18
RF Cable	Agilent	SMA 15cm	0001	2019-06-14	2019-09-13
Software	R&S	EMC32	9.26.0	/	/

*****END OF REPORT *****