



RF TEST REPORT

Applicant Xiaomi Communications Co., Ltd.
FCC ID 2AFZZ3QNY
Product Mobile Phone
Brand Redmi
Model 220333QNY
Report No. R2111A1060-R2
Issue Date January 26, 2022

TA Technology (Shanghai) Co., Ltd. tested the above equipment in accordance with the requirements in **FCC CFR47 Part 2 (2020)/ FCC CFR 47 Part 24E (2020)**. The test results show that the equipment tested is capable of demonstrating compliance with the requirements as documented in this report.

Prepared by: Peng Tao

Approved by: Kai Xu

TA Technology (Shanghai) Co., Ltd.

No.145, Jintang Rd, Tangzhen Industry Park, Pudong Shanghai, China

TEL: +86-021-50791141/2/3

FAX: +86-021-50791141/2/3-8000



TABLE OF CONTENT

1. Test Laboratory	4
1.1. Notes of the test report	4
1.2. Test facility	4
1.3. Testing Location	4
2. General Description of Equipment under Test	5
2.1. Applicant and Manufacturer Information	5
2.2. General information	5
3. Applied Standards	7
4. Test Configuration	8
5. Test Case Results	10
5.1. RF Power Output and Effective Isotropic Radiated Power	10
5.2. Occupied Bandwidth	16
5.3. Band Edge Compliance	30
5.4. Peak-to-Average Power Ratio (PAPR)	45
5.5. Frequency Stability	48
5.6. Spurious Emissions at Antenna Terminals	54
5.7. Radiates Spurious Emission	60
6. Main Test Instruments	69
ANNEX A: The EUT Appearance	70
ANNEX B: Test Setup Photos	71

Summary of measurement results

No.	Test Case	Clause in FCC rules	Verdict
1	RF Power Output and Effective Isotropic Radiated Power	2.1046 24.232(c)	PASS
2	Occupied Bandwidth	2.1049	PASS
3	Band Edge Compliance	2.1051 /24.238(a)	PASS
4	Peak-to-Average Power Ratio	24.232/KDB 971168 D01(5.7)	PASS
5	Frequency Stability	2.1055 / 24.235	PASS
6	Spurious Emissions at Antenna Terminals	2.1051 / 24.238(a)	PASS
7	Radiates Spurious Emission	2.1053 / 24.238(a)	PASS

Date of Testing: December 28, 2021~January 24, 2022
Date of Sample Received: December 27, 2021

Note: PASS: The EUT complies with the essential requirements in the standard.
FAIL: The EUT does not comply with the essential requirements in the standard.

All indications of Pass/Fail in this report are opinions expressed by TA Technology (Shanghai) Co., Ltd. based on interpretations and/or observations of test results. Measurement Uncertainties were not taken into account and are published for informational purposes only.



1. Test Laboratory

1.1. Notes of the test report

This report shall not be reproduced in full or partial, without the written approval of **TA technology (shanghai) co., Ltd.** The results documented in this report apply only to the tested sample, under the conditions and modes of operation as described herein. Measurement Uncertainties were not taken into account and are published for informational purposes only. This report is written to support regulatory compliance of the applicable standards stated above.

1.2. Test facility

FCC (Designation number: CN1179, Test Firm Registration Number: 446626)

TA Technology (Shanghai) Co., Ltd. has been listed on the US Federal Communications Commission list of test facilities recognized to perform measurements.

A2LA (Certificate Number: 3857.01)

TA Technology (Shanghai) Co., Ltd. has been listed by American Association for Laboratory Accreditation to perform measurement.

1.3. Testing Location

Company: TA Technology (Shanghai) Co., Ltd.
Address: No.145, Jintang Rd, Tangzhen Industry Park, Pudong
City: Shanghai
Post code: 201201
Country: P. R. China
Contact: Xu Kai
Telephone: +86-021-50791141/2/3
Fax: +86-021-50791141/2/3-8000
Website: <http://www.ta-shanghai.com>
E-mail: xukai@ta-shanghai.com

2. General Description of Equipment under Test

2.1. Applicant and Manufacturer Information

Applicant	Xiaomi Communications Co., Ltd.
Applicant address	#019, 9th Floor, Building 6, 33 Xi'erqi Middle Road, Haidian District, Beijing, China, 100085
Manufacturer	Xiaomi Communications Co., Ltd.
Manufacturer address	#019, 9th Floor, Building 6, 33 Xi'erqi Middle Road, Haidian District, Beijing, China, 100085

2.2. General information

EUT Description			
Model	220333QNY		
IMEI	IMEI 1: 862390060019009 IMEI 2: 862390060019017		
Hardware Version	P1.1		
Software Version	MIUI13		
Antenna Type	PIFA Antenna		
Antenna Gain	Band	Low Antenna	Upper Antenna
	GSM1900	-0.35 dBi	-0.30 dBi
	WCDMA Band II	-0.35 dBi	-0.30 dBi
	LTE Band 2	-0.40 dBi	-0.24 dBi
Test Mode(s)	GSM1900; WCDMA Band II; LTE Band 2;		
Test Modulation	(GSM/GPRS)GMSK, (EGPRS) GMSK/ 8PSK; (WCDMA) BPSK, QPSK; (LTE)QPSK,16QAM, 64QAM		
GPRS Multislot Class	33		
EGPRS Multislot Class	33		
HSDPA UE Category	24		
HSUPA UE Category	6		
LTE Category	5		
Maximum E.I.R.P	GSM 1900	28.99dBm	
	WCDMA Band II	24.05dBm	
	LTE Band 2	24.20dBm	
Rated Power Supply Voltage	3.87V		
Operating Voltage	Minimum: 3.6V Maximum: 4.2V		
Operating Temperature	Lowest: 0°C Highest: +40°C		
Testing Temperature	Lowest: -30°C Highest: +50°C		
Operating Frequency Range(s)	Band	Tx (MHz)	Rx (MHz)



	GSM1900	1850 ~ 1910	1930 ~ 1990
	WCDMA Band II	1850 ~ 1910	1930 ~ 1990
	LTE Band 2	1850 ~ 1910	1930 ~ 1990

Note: 1. The EUT is sent from the applicant to TA and the information of the EUT is declared by the applicant.



3. Applied Standards

According to the specifications of the manufacturer, it must comply with the requirements of the following standards:

Test standards:

FCC CFR 47 Part 24E (2020)

FCC CFR47 Part 2 (2020)

Reference standard:

ANSI C63.26 (2015)

KDB 971168 D01 Power Meas License Digital Systems v03r01

4. Test Configuration

There is more than one SIM card slot, each one should be applied throughout the compliance test respectively, and however, only the worst case (SIM 1) will be recorded in this report.

Radiated measurements are performed by rotating the EUT in three different orthogonal test planes. EUT stand-up position (Z axis), lie-down position (X, Y axis). Receiver antenna polarization (horizontal and vertical), the worst emission was found in position (X axis, horizontal polarization for GSM/WCDMA; Z axis, horizontal polarization for LTE) and the worst case was recorded.

All mode and data rates and positions and RB size and modulations were investigated.

Subsequently, only the worst case emissions are reported.

The following testing in GSM/WCDMA/LTE is set based on the maximum RF Output Power.

Test modes are chosen to be reported as the worst case configuration below:

Test items	Modes/Modulation	
	GSM 1900	WCDMA Band II
RF Power Output and Effective Isotropic Radiated Power	GSM GPRS EGPRS	RMC/AMR HSDPA/HSUPA DC-HSDPA
Occupied Bandwidth	GSM GPRS(1Tx slot) EGPRS(1Tx slot)	RMC
Band Edge Compliance	GSM GPRS(1Tx slot) EGPRS(1Tx slot)	RMC
Peak-to-Average Power Ratio	GSM GPRS(1Tx slot) EGPRS(1Tx slot)	RMC
Frequency Stability	GSM GPRS(1Tx slot) EGPRS(1Tx slot)	RMC
Spurious Emissions at Antenna Terminals	GSM	RMC
Radiates Spurious Emission	GSM	RMC

Test modes are chosen to be reported as the worst case configuration below for LTE Band 2

Test items	Bandwidth (MHz)						Modulation		RB			Test Channel		
	1.4	3	5	10	15	20	QPSK	16QAM/ 64QAM	1	50%	100%	L	M	H
RF Power Output and Effective Isotropic Radiated Power	○	○	○	○	○	○	○	○	○	○	○	○	○	○
Occupied Bandwidth	○	○	○	○	○	○	○	○	-	-	○	○	○	○
Band Edge Compliance	○	○	○	○	○	○	○	○	○	-	○	○	-	○
Peak-to-Average Power Ratio	○	○	○	○	○	○	○	○	-	-	○	○	○	○
Frequency Stability	○	○	○	○	○	○	○	○	○	-	-	-	○	-
Spurious Emissions at Antenna Terminals	○	○	○	○	○	○	○	-	○	-	-	○	○	○
Radiates Spurious Emission	○	-	○	-	-	○	○	-	○	-	-	-	○	-
Note	1. The mark "○" means that this configuration is chosen for testing. 2. The mark "-" means that this configuration is not testing.													

5. Test Case Results

5.1.RF Power Output and Effective Isotropic Radiated Power

Ambient condition

Temperature	Relative humidity	Pressure
23°C ~25°C	45%~50%	101.5kPa

Methods of Measurement

During the process of the testing, The EUT was connected to the Base Station Simulator with a known loss. The EUT is controlled by the Base Station Simulator test set to ensure max power transmission with proper modulation.

ERP can then be calculated as follows:

$$EIRP \text{ (dBm)} = \text{Output Power (dBm)} - \text{Losses (dB)} + \text{Antenna Gain (dBi)}$$

where:dBd refers to gain relative to an ideal dipole.

$$EIRP \text{ (dBm)} = ERP \text{ (dBm)} + 2.15 \text{ (dB.)}$$

Test Setup

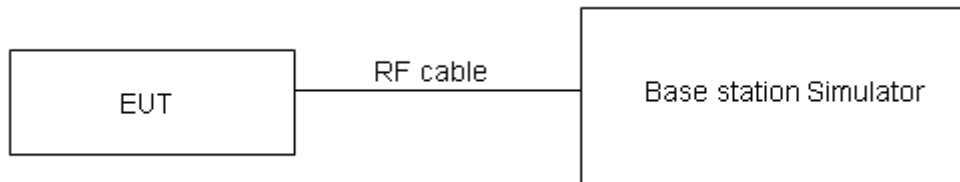

Limits

No specific RF power output requirements in part 2.1046.

Rule Part 24.232(c) Mobile and portable stations are limited to 2 watts EIRP.

Rule Part 24.232(e) Peak transmit power must be measured over any interval of continuous transmission using instrumentation calibrated in terms of an rms-equivalent voltage.

Limit	$\leq 2 \text{ W}$ (33 dBm)
-------	-----------------------------

Measurement Uncertainty

The assessed measurement uncertainty to ensure 95% confidence level for the normal distribution is with the coverage factor $k = 2$, $U = 0.4 \text{ dB}$ for RF power output, $k = 2$, $U = 1.19 \text{ dB}$ for EIRP.

Test Results

GSM 1900		Maximum Output Power (dBm)			Low Antenna EIRP (dBm)			Upper Antenna EIRP (dBm)		
		Channel 512	Channel 661	Channel 810	Channel 512	Channel 661	Channel 810	Channel 512	Channel 661	Channel 810
		1850.2 (MHz)	1880 (MHz)	1909.8 (MHz)	1850.2 (MHz)	1880 (MHz)	1909.8 (MHz)	1850.2 (MHz)	1880 (MHz)	1909.8 (MHz)
GSM(GMSK)	Results	29.26	29.29	29.25	28.91	28.94	28.90	28.96	28.99	28.95
GPRS (GMSK)	1TXslot	29.12	29.28	29.25	28.77	28.93	28.90	28.82	28.98	28.95
	2TXslots	27.41	27.60	27.62	27.06	27.25	27.27	27.11	27.30	27.32
	3TXslots	25.25	25.38	25.43	24.90	25.03	25.08	24.95	25.08	25.13
	4TXslots	23.16	23.22	23.25	22.81	22.87	22.90	22.86	22.92	22.95
EGPRS (8PSK)	1TXslot	25.48	25.60	25.55	25.13	25.25	25.20	25.18	25.30	25.25
	2TXslots	24.06	24.38	24.30	23.71	24.03	23.95	23.76	24.08	24.00
	3TXslots	22.11	22.82	22.35	21.76	22.47	22.00	21.81	22.52	22.05
	4TXslots	21.01	21.08	21.44	20.66	20.73	21.09	20.71	20.78	21.14

WCDMA Band II		Maximum Output Power (dBm)			Low Antenna EIRP (dBm)			Upper Antenna EIRP (dBm)		
		Channel 9262	Channel 9400	Channel 9538	Channel 9262	Channel 9400	Channel 9538	Channel 9262	Channel 9400	Channel 9538
		1852.4 (MHz)	1880 (MHz)	1907.6 (MHz)	1852.4 (MHz)	1880 (MHz)	1907.6 (MHz)	1852.4 (MHz)	1880 (MHz)	1907.6 (MHz)
RMC		24.35	24.22	24.31	24.00	23.87	23.96	24.05	23.92	24.01
AMR		23.92	23.94	23.85	23.57	23.59	23.5	23.62	23.64	23.55
HSDPA	Sub - Test 1	23.18	22.94	22.89	22.83	22.59	22.54	22.88	22.64	22.59
	Sub - Test 2	23.04	22.88	22.99	22.69	22.53	22.64	22.74	22.58	22.69
	Sub - Test 3	22.54	22.38	22.61	22.19	22.03	22.26	22.24	22.08	22.31
	Sub - Test 4	22.68	22.18	22.59	22.33	21.83	22.24	22.38	21.88	22.29
HSUPA	Sub - Test 1	23.08	22.96	22.93	22.73	22.61	22.58	22.78	22.66	22.63
	Sub - Test 2	20.88	20.84	20.89	20.53	20.49	20.54	20.58	20.54	20.59
	Sub - Test 3	21.98	21.94	21.85	21.63	21.59	21.5	21.68	21.64	21.55
	Sub - Test 4	20.88	20.78	21.03	20.53	20.43	20.68	20.58	20.48	20.73
	Sub - Test 5	22.86	22.94	22.95	22.51	22.59	22.6	22.56	22.64	22.65
DC-HSDPA	Sub - Test 1	23.02	22.72	22.81	22.67	22.37	22.46	22.72	22.42	22.51
	Sub - Test 2	22.92	22.84	23.13	22.57	22.49	22.78	22.62	22.54	22.83
	Sub - Test 3	22.40	22.26	22.61	22.05	21.91	22.26	22.1	21.96	22.31
	Sub - Test 4	22.36	22.22	22.35	22.01	21.87	22	22.06	21.92	22.05



LTE Band 2				Maximum Output Power(dBm)			Low Antenna EIRP (dBm)			Upper Antenna EIRP (dBm)		
BW	Modulation	RB size	RB offset	Channel/Frequency(MHz)								
				18607/1850.7	18900/1880	19193/1909.3	18607/1850.7	18900/1880	19193/1909.3	18607/1850.7	18900/1880	19193/1909.3
1.4MHz	QPSK	1	0	24.28	24.25	24.03	23.88	23.85	23.63	24.04	24.01	23.79
		1	2	24.44	24.29	24.08	24.04	23.89	23.68	24.20	24.05	23.84
		1	5	24.19	24.01	24.11	23.79	23.61	23.71	23.95	23.77	23.87
		3	0	23.95	23.81	23.77	23.55	23.41	23.37	23.71	23.57	23.53
		3	2	23.73	23.73	23.59	23.33	23.33	23.19	23.49	23.49	23.35
		3	3	23.51	23.63	23.40	23.11	23.23	23.00	23.27	23.39	23.16
		6	0	22.64	22.69	22.59	22.24	22.29	22.19	22.40	22.45	22.35
	16QAM	1	0	22.74	22.63	22.72	22.34	22.23	22.32	22.50	22.39	22.48
		1	2	22.72	22.76	22.78	22.32	22.36	22.38	22.48	22.52	22.54
		1	5	22.51	22.81	22.41	22.11	22.41	22.01	22.27	22.57	22.17
		3	0	22.76	22.66	22.70	22.36	22.26	22.30	22.52	22.42	22.46
		3	2	22.73	22.80	22.56	22.33	22.40	22.16	22.49	22.56	22.32
		3	3	22.46	22.74	22.43	22.06	22.34	22.03	22.22	22.50	22.19
		6	0	21.56	21.73	21.72	21.16	21.33	21.32	21.32	21.49	21.48
	64QAM	1	0	22.85	22.81	22.86	22.45	22.41	22.46	22.61	22.57	22.62
		1	2	22.72	22.67	22.66	22.32	22.27	22.26	22.48	22.43	22.42
		1	5	22.56	22.77	22.44	22.16	22.37	22.04	22.32	22.53	22.20
		3	0	22.71	22.54	22.74	22.31	22.14	22.34	22.47	22.30	22.50
		3	2	22.69	22.71	22.89	22.29	22.31	22.49	22.45	22.47	22.65
		3	3	22.48	22.56	22.47	22.08	22.16	22.07	22.24	22.32	22.23
		6	0	21.70	21.64	21.74	21.30	21.24	21.34	21.46	21.40	21.50
BW	Modulation	RB size	RB offset	Channel/Frequency(MHz)								
				18615/1851.5	18900/1880	19185/1908.5	18615/1851.5	18900/1880	19185/1908.5	18615/1851.5	18900/1880	19185/1908.5
3MHz	QPSK	1	0	24.30	24.29	24.06	23.90	23.89	23.66	24.06	24.05	23.82
		1	7	24.42	24.32	24.12	24.02	23.92	23.72	24.18	24.08	23.88
		1	14	24.22	24.06	24.15	23.82	23.66	23.75	23.98	23.82	23.91
		8	0	23.05	22.93	22.90	22.65	22.53	22.50	22.81	22.69	22.66
		8	4	22.85	22.83	22.71	22.45	22.43	22.31	22.61	22.59	22.47
		8	7	22.61	22.74	22.50	22.21	22.34	22.10	22.37	22.50	22.26
		15	0	22.64	22.73	22.62	22.24	22.33	22.22	22.40	22.49	22.38
	16QAM	1	0	22.77	22.65	22.75	22.37	22.25	22.35	22.53	22.41	22.51



		1	7	22.75	22.76	22.82	22.35	22.36	22.42	22.51	22.52	22.58
		1	14	22.53	22.85	22.44	22.13	22.45	22.04	22.29	22.61	22.20
		8	0	21.87	21.79	21.82	21.47	21.39	21.42	21.63	21.55	21.58
		8	4	21.84	21.93	21.68	21.44	21.53	21.28	21.60	21.69	21.44
		8	7	21.56	21.86	21.56	21.16	21.46	21.16	21.32	21.62	21.32
		15	0	21.59	21.77	21.75	21.19	21.37	21.35	21.35	21.53	21.51
	64QAM	1	0	22.88	22.83	22.89	22.48	22.43	22.49	22.64	22.59	22.65
		1	7	22.75	22.67	22.68	22.35	22.27	22.28	22.51	22.43	22.44
		1	14	22.58	22.76	22.47	22.18	22.36	22.07	22.34	22.52	22.23
		8	0	21.82	21.67	21.86	21.42	21.27	21.46	21.58	21.43	21.62
		8	4	21.80	21.84	21.89	21.40	21.44	21.49	21.56	21.60	21.65
		8	7	21.58	21.68	21.60	21.18	21.28	21.20	21.34	21.44	21.36
		15	0	21.73	21.68	21.77	21.33	21.28	21.37	21.49	21.44	21.53
	BW	Modulation	RB size	RB offset	Channel/Frequency(MHz)							
18625/1852.5					18900/1880	19175/1907.5	18625/1852.5	18900/1880	19175/1907.5	18625/1852.5	18900/1880	19175/1907.5
5MHz	QPSK	1	0	24.27	24.27	24.02	23.87	23.87	23.62	24.03	24.03	23.78
		1	13	24.40	24.28	24.09	24.00	23.88	23.69	24.16	24.04	23.85
		1	24	24.19	24.01	24.11	23.79	23.61	23.71	23.95	23.77	23.87
		12	0	23.02	22.88	22.86	22.62	22.48	22.46	22.78	22.64	22.62
		12	6	22.83	22.79	22.66	22.43	22.39	22.26	22.59	22.55	22.42
		12	13	22.59	22.72	22.46	22.19	22.32	22.06	22.35	22.48	22.22
		25	0	22.64	22.72	22.60	22.24	22.32	22.20	22.40	22.48	22.36
	16QAM	1	0	22.74	22.61	22.72	22.34	22.21	22.32	22.50	22.37	22.48
		1	13	22.72	22.74	22.79	22.32	22.34	22.39	22.48	22.50	22.55
		1	24	22.50	22.83	22.40	22.10	22.43	22.00	22.26	22.59	22.16
		12	0	21.85	21.75	21.79	21.45	21.35	21.39	21.61	21.51	21.55
		12	6	21.81	21.88	21.64	21.41	21.48	21.24	21.57	21.64	21.40
		12	13	21.53	21.81	21.52	21.13	21.41	21.12	21.29	21.57	21.28
		25	0	21.57	21.73	21.70	21.17	21.33	21.30	21.33	21.49	21.46
	64QAM	1	0	22.85	22.83	22.86	22.45	22.43	22.46	22.61	22.59	22.62
		1	13	22.72	22.69	22.65	22.32	22.29	22.25	22.48	22.45	22.41
		1	24	22.59	22.74	22.43	22.19	22.34	22.03	22.35	22.50	22.19
		12	0	21.80	21.63	21.87	21.40	21.23	21.47	21.56	21.39	21.63
		12	6	21.77	21.79	21.86	21.37	21.39	21.46	21.53	21.55	21.62
		12	13	21.55	21.63	21.56	21.15	21.23	21.16	21.31	21.39	21.32
		25	0	21.71	21.64	21.72	21.31	21.24	21.32	21.47	21.40	21.48



BW	Modulation	RB size	RB offset	Channel/Frequency(MHz)								
				18650/1855	18900/1880	19150/1905	18650/1855	18900/1880	19150/1905	18650/1855	18900/1880	19150/1905
10MHz	QPSK	1	0	24.29	24.28	24.05	23.89	23.88	23.65	24.05	24.04	23.81
		1	25	24.43	24.33	24.13	24.03	23.93	23.73	24.19	24.09	23.89
		1	49	24.21	24.05	24.14	23.81	23.65	23.74	23.97	23.81	23.90
		25	0	23.05	22.93	22.90	22.65	22.53	22.50	22.81	22.69	22.66
		25	13	22.86	22.84	22.70	22.46	22.44	22.30	22.62	22.60	22.46
		25	25	22.61	22.76	22.51	22.21	22.36	22.11	22.37	22.52	22.27
		50	0	22.68	22.74	22.64	22.28	22.34	22.24	22.44	22.50	22.40
	16QAM	1	0	22.76	22.64	22.74	22.36	22.24	22.34	22.52	22.40	22.50
		1	25	22.75	22.78	22.82	22.35	22.38	22.42	22.51	22.54	22.58
		1	49	22.53	22.85	22.43	22.13	22.45	22.03	22.29	22.61	22.19
		25	0	21.88	21.80	21.83	21.48	21.40	21.43	21.64	21.56	21.59
		25	13	21.83	21.92	21.67	21.43	21.52	21.27	21.59	21.68	21.43
		25	25	21.56	21.86	21.56	21.16	21.46	21.16	21.32	21.62	21.32
		50	0	21.60	21.78	21.74	21.20	21.38	21.34	21.36	21.54	21.50
	64QAM	1	0	22.87	22.82	22.88	22.47	22.42	22.48	22.63	22.58	22.64
		1	25	22.75	22.69	22.68	22.35	22.29	22.28	22.51	22.45	22.44
		1	49	22.58	22.76	22.46	22.18	22.36	22.06	22.34	22.52	22.22
		25	0	21.83	21.68	21.87	21.43	21.28	21.47	21.59	21.44	21.63
		25	13	21.79	21.83	21.80	21.39	21.43	21.40	21.55	21.59	21.56
		25	25	21.58	21.68	21.60	21.18	21.28	21.20	21.34	21.44	21.36
		50	0	21.74	21.69	21.76	21.34	21.29	21.36	21.50	21.45	21.52
BW	Modulation	RB size	RB offset	Channel/Frequency(MHz)								
				18675/1857.5	18900/1880	19125/1902.5	18675/1857.5	18900/1880	19125/1902.5	18675/1857.5	18900/1880	19125/1902.5
15MHz	QPSK	1	0	24.28	24.24	24.03	23.88	23.84	23.63	24.04	24.00	23.79
		1	38	24.41	24.32	24.10	24.01	23.92	23.70	24.17	24.08	23.86
		1	74	24.18	24.00	24.10	23.78	23.60	23.70	23.94	23.76	23.86
		36	0	23.03	22.89	22.87	22.63	22.49	22.47	22.79	22.65	22.63
		36	18	22.83	22.79	22.66	22.43	22.39	22.26	22.59	22.55	22.42
		36	39	22.58	22.73	22.47	22.18	22.33	22.07	22.34	22.49	22.23
		75	0	22.66	22.70	22.59	22.26	22.30	22.19	22.42	22.46	22.35
	16QAM	1	0	22.71	22.62	22.72	22.31	22.22	22.32	22.47	22.38	22.48
		1	38	22.73	22.75	22.80	22.33	22.35	22.40	22.49	22.51	22.56
		1	74	22.50	22.81	22.40	22.10	22.41	22.00	22.26	22.57	22.16



		36	0	21.85	21.78	21.80	21.45	21.38	21.40	21.61	21.54	21.56	
		36	18	21.80	21.87	21.63	21.40	21.47	21.23	21.56	21.63	21.39	
		36	39	21.54	21.82	21.53	21.14	21.42	21.13	21.30	21.58	21.29	
		75	0	21.57	21.73	21.70	21.17	21.33	21.30	21.33	21.49	21.46	
	64QAM	1	0	22.82	22.80	22.86	22.42	22.40	22.46	22.58	22.56	22.62	
		1	38	22.73	22.66	22.66	22.33	22.26	22.26	22.49	22.42	22.42	
		1	74	22.59	22.75	22.47	22.19	22.35	22.07	22.35	22.51	22.23	
		36	0	21.82	21.70	21.88	21.42	21.30	21.48	21.58	21.46	21.64	
		36	18	21.77	21.80	21.85	21.37	21.40	21.45	21.53	21.56	21.61	
		36	39	21.56	21.64	21.57	21.16	21.24	21.17	21.32	21.40	21.33	
		75	0	21.71	21.64	21.72	21.31	21.24	21.32	21.47	21.40	21.48	
	BW	Modulation	RB size	RB offset	Channel/Frequency(MHz)								
					18700/1860	18900/1880	19100/1900	18700/1860	18900/1880	19100/1900	18700/1860	18900/1880	19100/1900
20MHz	QPSK	1	0	24.25	24.20	24.00	23.85	23.80	23.60	24.01	23.96	23.76	
		1	50	24.40	24.28	24.08	24.00	23.88	23.68	24.16	24.04	23.84	
		1	99	24.16	23.99	24.07	23.76	23.59	23.67	23.92	23.75	23.83	
		50	0	23.00	22.84	22.83	22.60	22.44	22.43	22.76	22.60	22.59	
		50	25	22.81	22.75	22.63	22.41	22.35	22.23	22.57	22.51	22.39	
		50	50	22.55	22.68	22.43	22.15	22.28	22.03	22.31	22.44	22.19	
		100	0	22.63	22.65	22.55	22.23	22.25	22.15	22.39	22.41	22.31	
	16QAM	1	0	22.70	22.58	22.67	22.30	22.18	22.27	22.46	22.34	22.43	
		1	50	22.69	22.73	22.76	22.29	22.33	22.36	22.45	22.49	22.52	
		1	99	22.48	22.78	22.38	22.08	22.38	21.98	22.24	22.54	22.14	
		50	0	21.82	21.74	21.77	21.42	21.34	21.37	21.58	21.50	21.53	
		50	25	21.77	21.85	21.60	21.37	21.45	21.20	21.53	21.61	21.36	
		50	50	21.51	21.77	21.49	21.11	21.37	21.09	21.27	21.53	21.25	
		100	0	21.55	21.69	21.67	21.15	21.29	21.27	21.31	21.45	21.43	
	64QAM	1	0	22.80	22.76	22.81	22.40	22.36	22.41	22.56	22.52	22.57	
		1	50	22.69	22.64	22.62	22.29	22.24	22.22	22.45	22.40	22.38	
		1	99	22.53	22.69	22.41	22.13	22.29	22.01	22.29	22.45	22.17	
		50	0	21.77	21.62	21.81	21.37	21.22	21.41	21.53	21.38	21.57	
		50	25	21.73	21.76	21.90	21.33	21.36	21.50	21.49	21.52	21.66	
		50	50	21.53	21.59	21.53	21.13	21.19	21.13	21.29	21.35	21.29	
		100	0	21.69	21.60	21.69	21.29	21.20	21.29	21.45	21.36	21.45	

5.2.Occupied Bandwidth

Ambient condition

Temperature	Relative humidity	Pressure
23°C ~25°C	45%~50%	101.5kPa

Method of Measurement

The EUT was connected to Spectrum Analyzer and Base Station Simulator via power Splitter. The occupied bandwidth is measured using spectrum analyzer.

RBW is set to $\geq 1\%EBW$, VBW is set to 3x RBW.

99% power and -26dBc occupied bandwidths are recorded. Spectrum analyzer plots are included on the following pages.

Test Setup

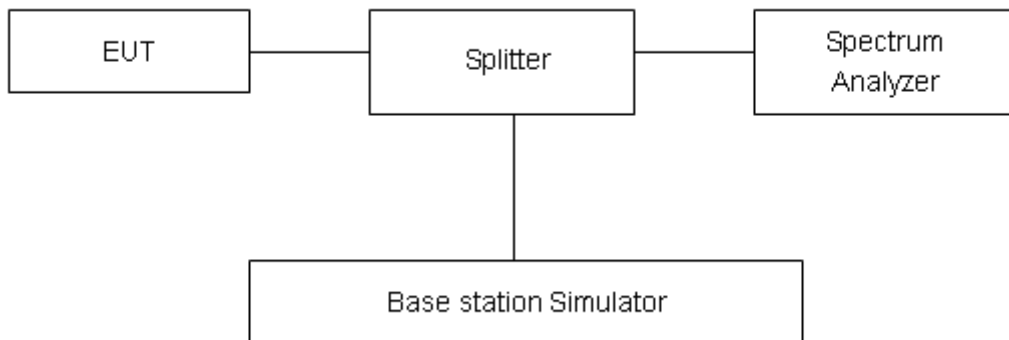

Limits

No specific occupied bandwidth requirements in part 2.1049.

Measurement Uncertainty

The assessed measurement uncertainty to ensure 95% confidence level for the normal distribution is with the coverage factor $k = 2$, $U = 624\text{Hz}$.



Test Result

Mode	Channel	Frequency (MHz)	99% Power Bandwidth (MHz)	-26dBc Bandwidth(MHz)
GSM 1900 (GMSK)	512	1850.2	0.243	0.309
	661	1880.0	0.243	0.307
	810	1909.8	0.242	0.308
GPRS 1900 (GMSK)	512	1850.2	0.245	0.314
	661	1880.0	0.243	0.310
	810	1909.8	0.246	0.310
EGPRS 1900 (8PSK)	512	1850.2	0.244	0.317
	661	1880.0	0.242	0.309
	810	1909.8	0.240	0.306
WCDMA Band II (RMC)	9262	1852.4	4.110	4.676
	9400	1880	4.109	4.678
	9538	1907.6	4.111	4.664

LTE Band 2						
RB	Modulation	Bandwidth (MHz)	Channel	Frequency (MHz)	99% Power Bandwidth(MHz)	-26dBc Bandwidth(MHz)
100%	QPSK	1.4	18607	1850.7	1.099	1.282
			18900	1880.0	1.098	1.282
			19193	1909.3	1.096	1.299
		3	18615	1851.5	2.701	2.980
			18900	1880	2.693	2.987
			19185	1908.5	2.705	2.977
		5	18625	1852.5	4.495	4.959
			18900	1880	4.504	4.954
			19175	1907.5	4.499	4.981
		10	18650	1855	8.968	9.850
			18900	1880	8.932	9.786
			19150	1905	8.946	9.682
		15	18675	1857.5	13.446	14.532
			18900	1880	13.390	14.582
			19125	1902.5	13.397	14.578
		20	18700	1860	17.917	19.346
18900	1880		17.818	19.208		



	16QAM	1.4	19100	1900	17.881	19.430
			18607	1850.7	1.096	1.299
			18900	1880.0	1.100	1.300
		19193	1909.3	1.091	1.279	
		3	18615	1851.5	2.692	2.955
			18900	1880	2.702	2.968
			19185	1908.5	2.696	2.998
		5	18625	1852.5	4.494	4.956
			18900	1880	4.526	4.894
			19175	1907.5	4.510	4.955
		10	18650	1855	8.958	9.835
			18900	1880	8.972	9.772
			19150	1905	8.936	9.852
		15	18675	1857.5	13.399	14.621
			18900	1880	13.347	14.654
			19125	1902.5	13.380	14.451
		20	18700	1860	17.965	19.184
			18900	1880	17.847	19.303
	19100		1900	17.894	19.169	
	64QAM	1.4	18607	1850.7	1.103	1.304
			18900	1880.0	1.101	1.300
			19193	1909.3	1.103	1.283
		3	18615	1851.5	2.710	2.953
			18900	1880	2.707	2.966
			19185	1908.5	2.698	2.970
		5	18625	1852.5	4.513	4.989
			18900	1880	4.506	4.953
			19175	1907.5	4.520	4.941
		10	18650	1855	8.955	9.755
			18900	1880	8.960	9.719
19150			1905	8.946	9.702	
15		18675	1857.5	13.394	14.496	
		18900	1880	13.404	14.504	
		19125	1902.5	13.379	14.463	
20		18700	1860	17.957	19.218	
		18900	1880	17.868	19.241	
		19100	1900	17.889	19.211	

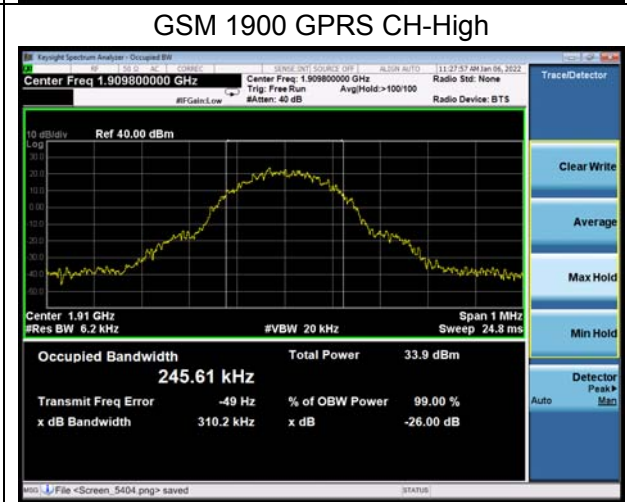
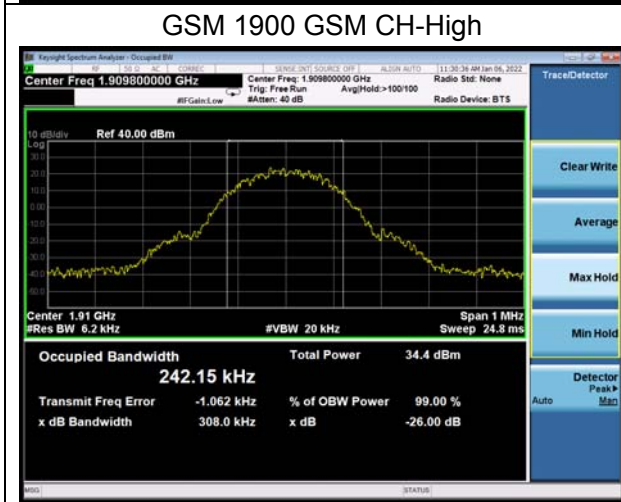
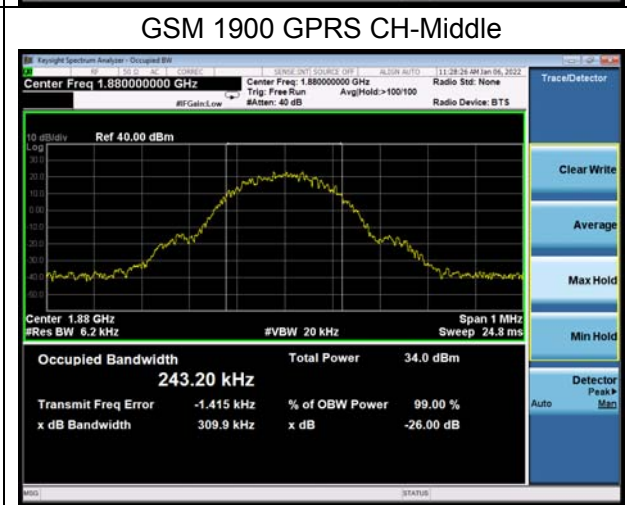
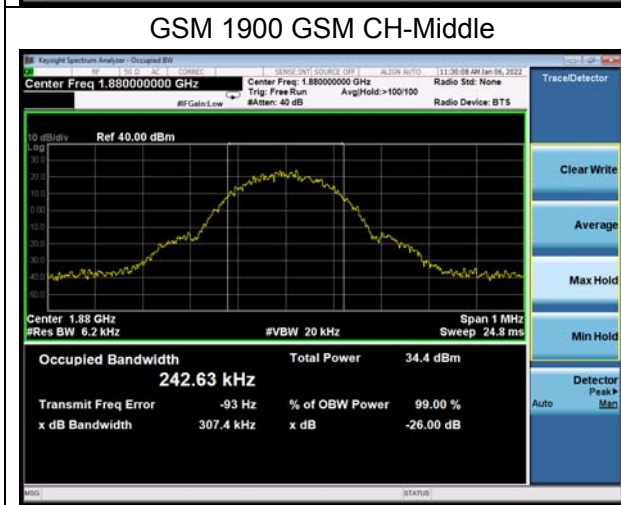
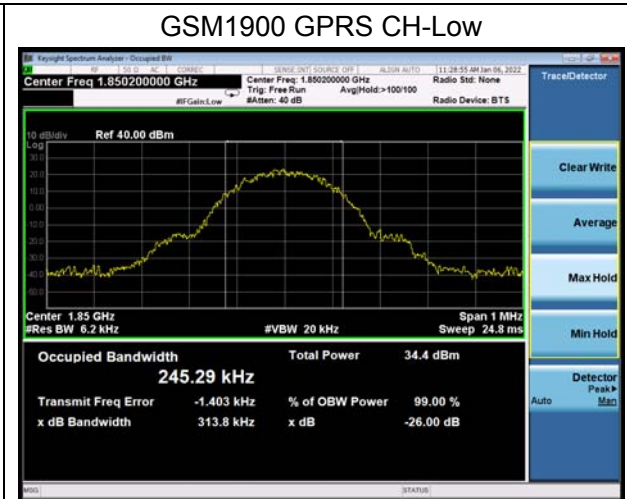
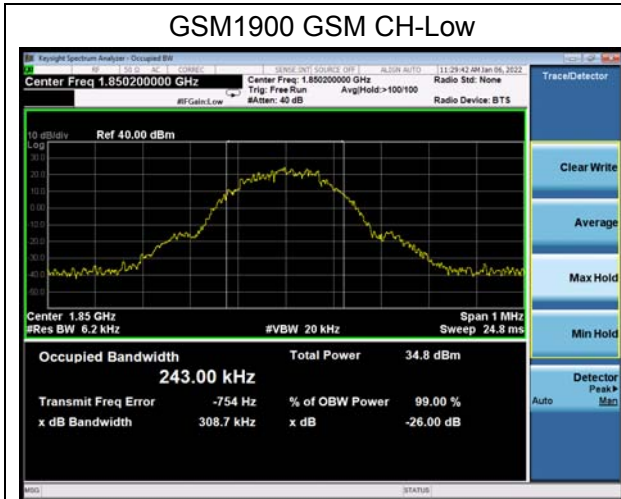

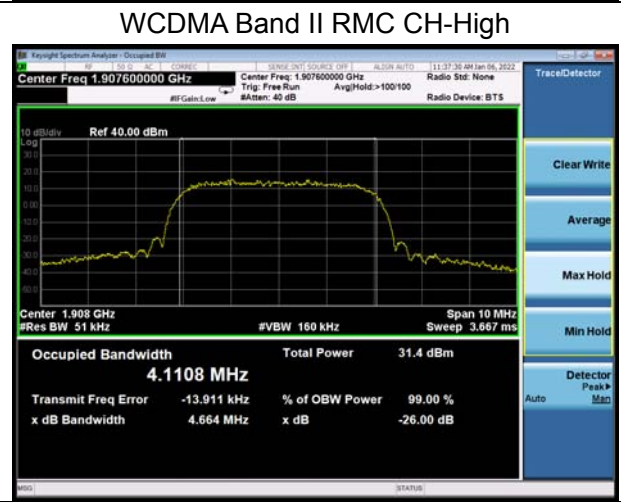
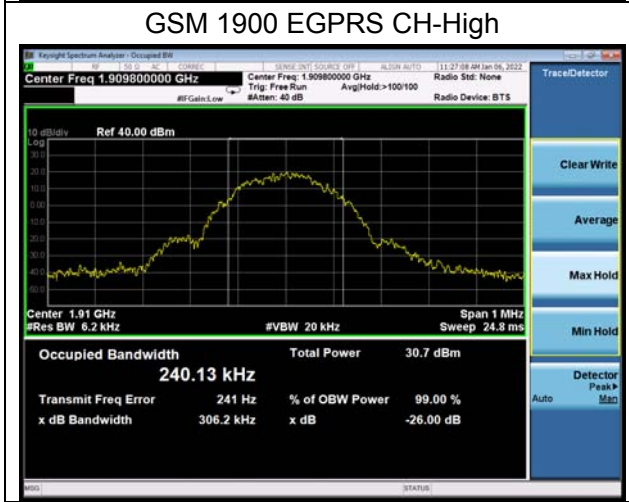
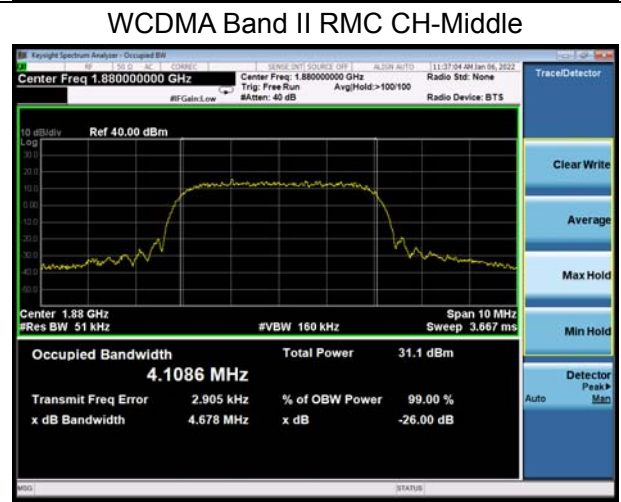
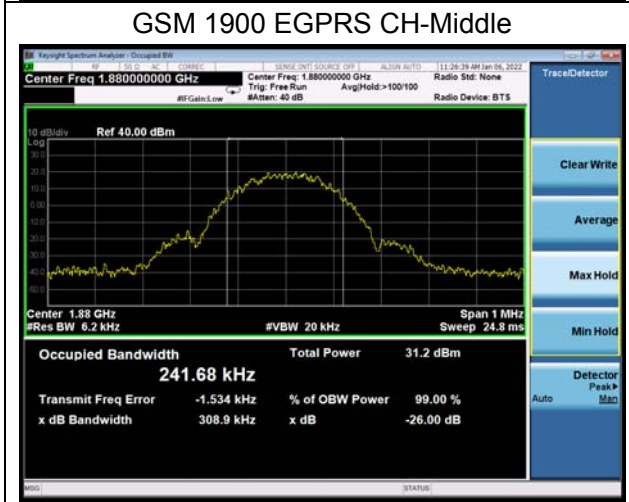
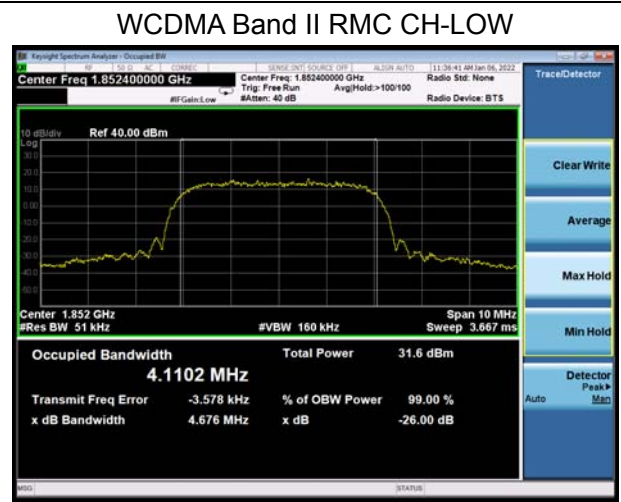
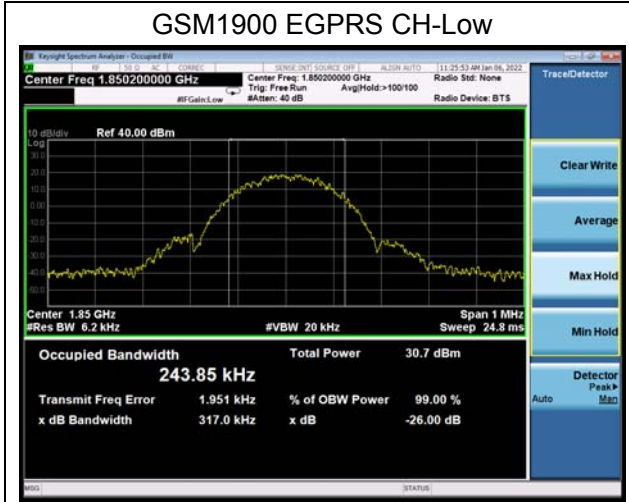



LTE Band 2 1.4MHz QPSK CH-Low

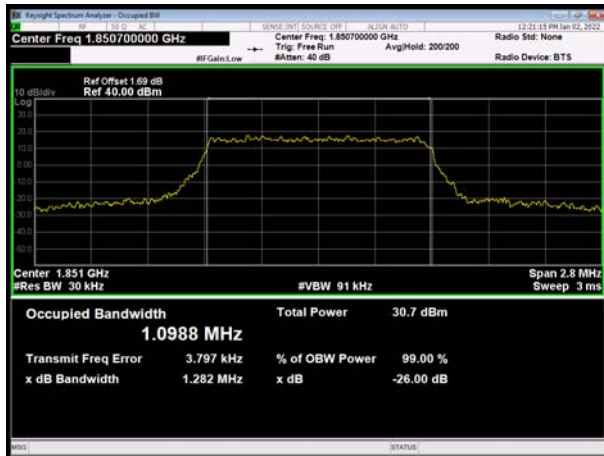

LTE Band 2 3MHz QPSK CH-Low

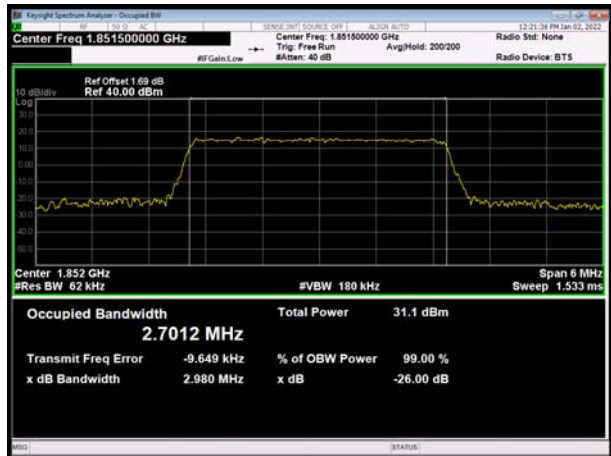

LTE Band 2 1.4MHz QPSK CH-Middle

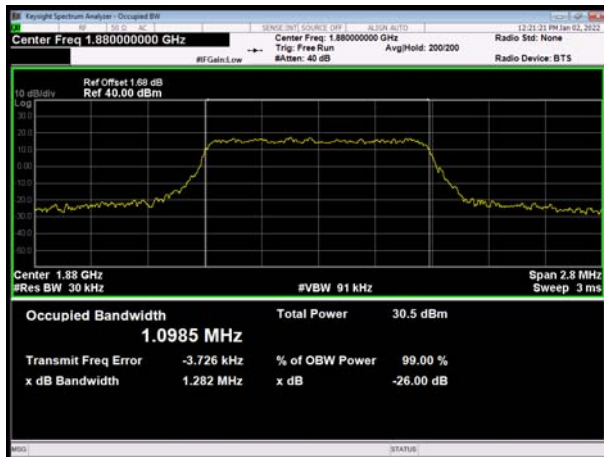

LTE Band 2 3MHz QPSK CH-Middle

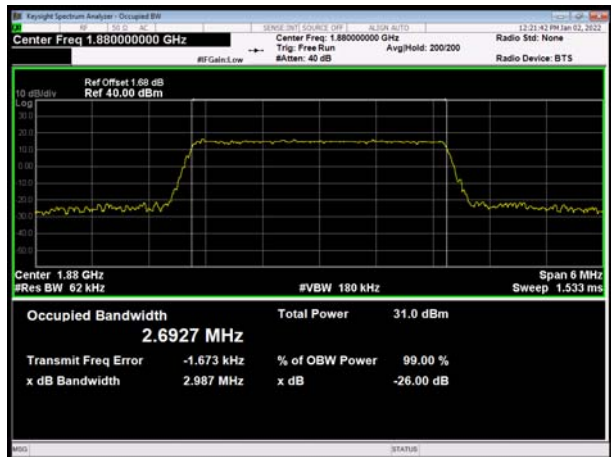

LTE Band 2 1.4MHz QPSK CH-High



LTE Band 2 3MHz QPSK CH-High

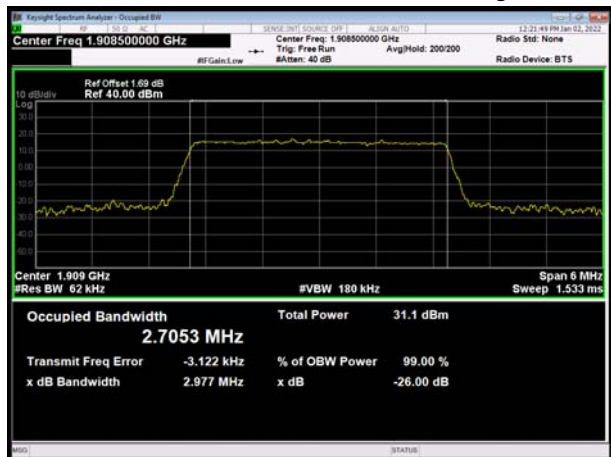

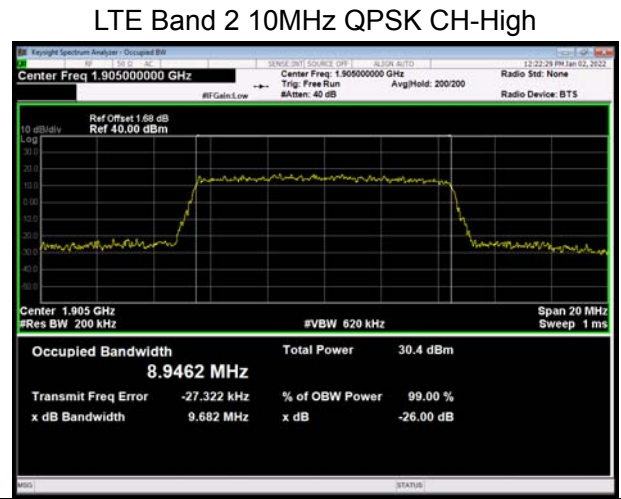
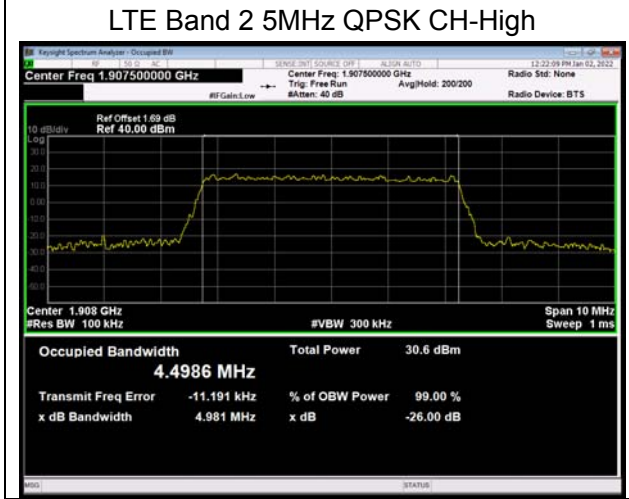
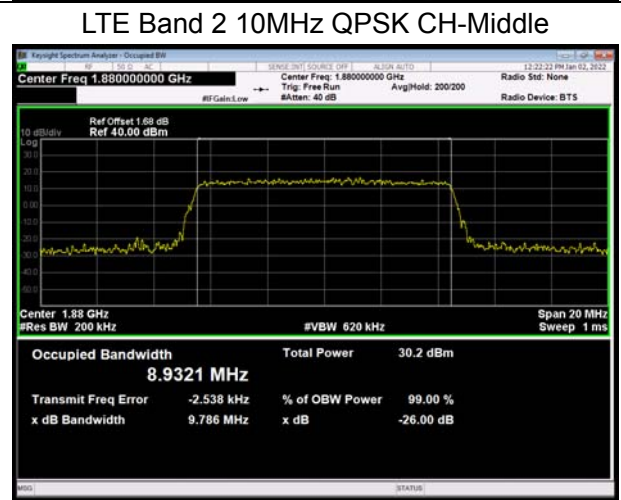
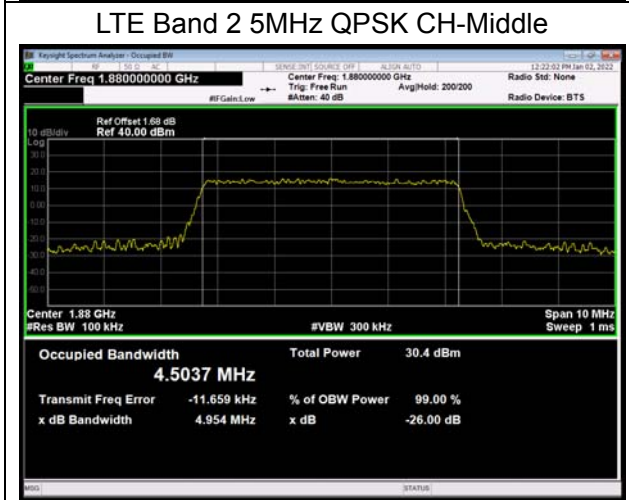
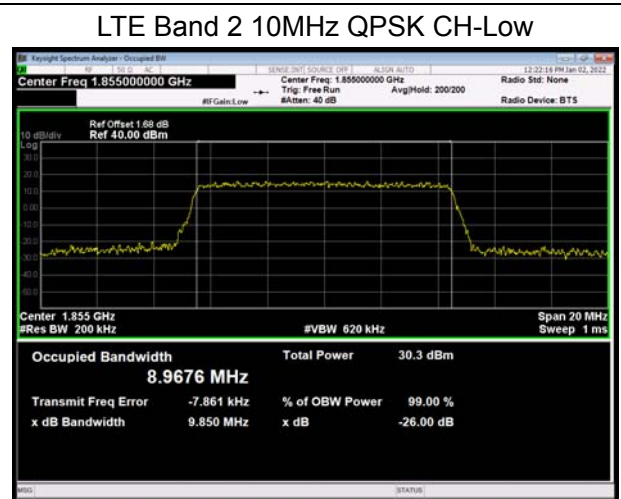
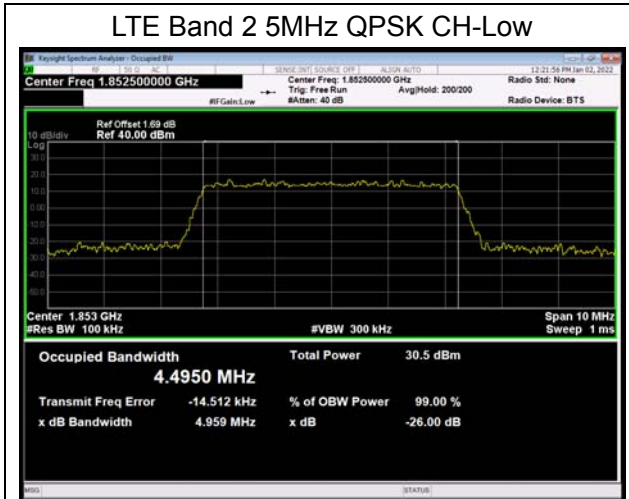

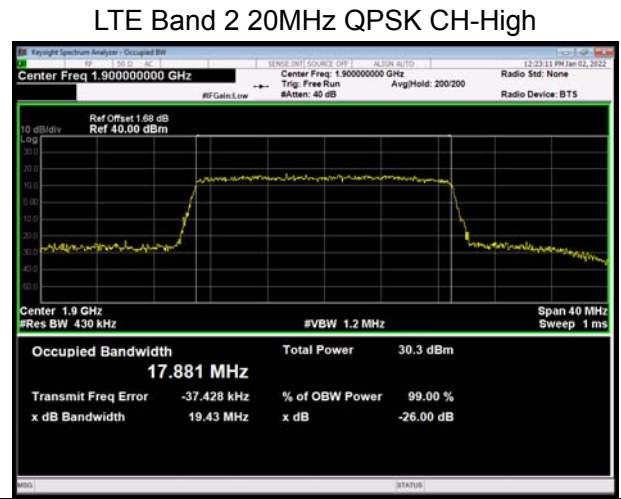
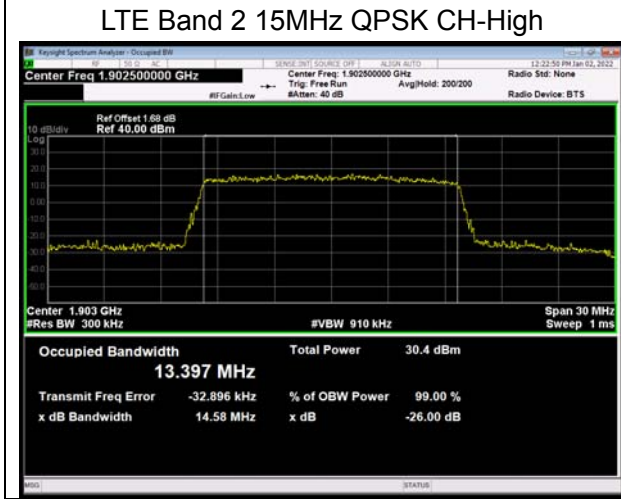
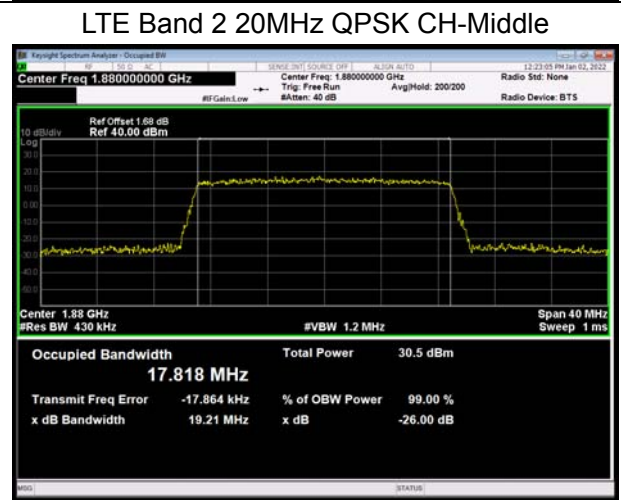
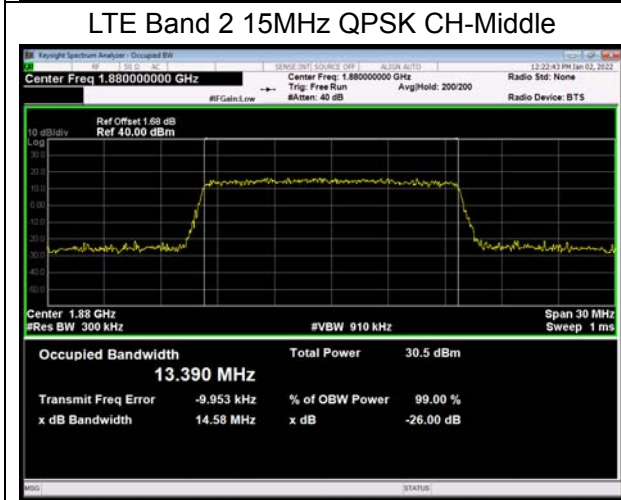
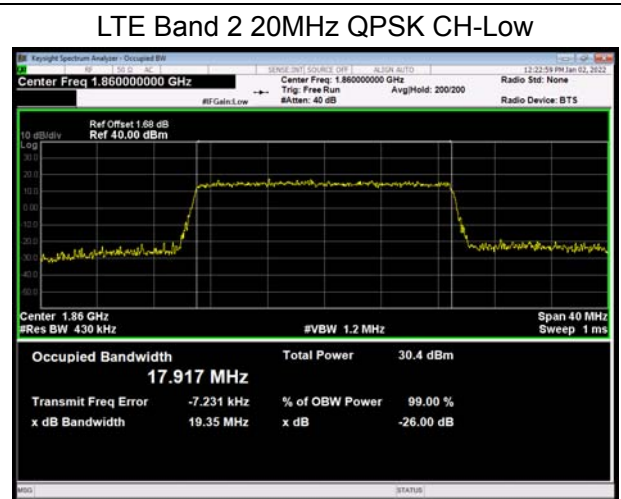
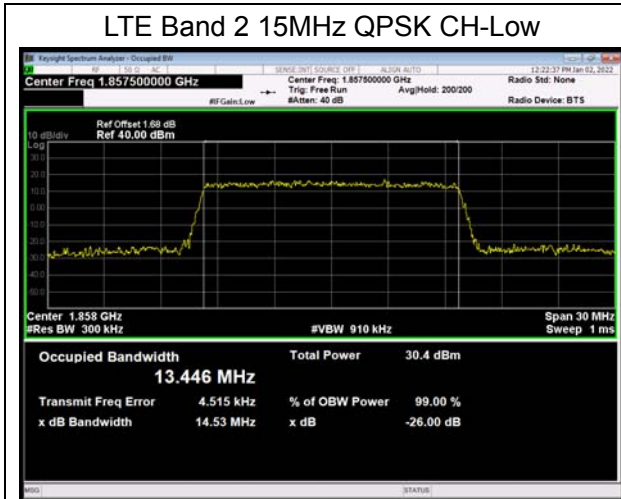

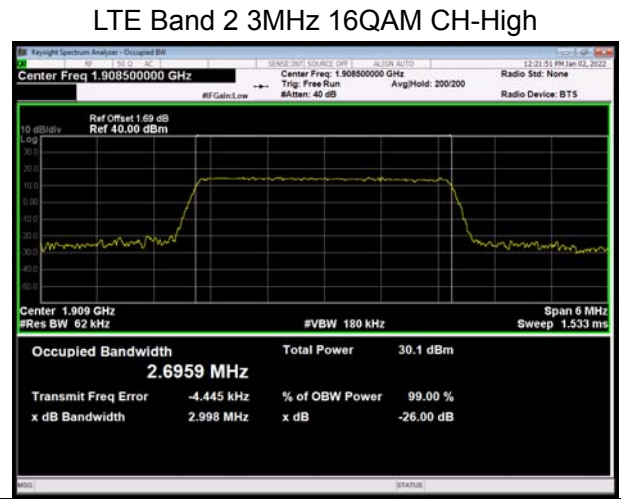
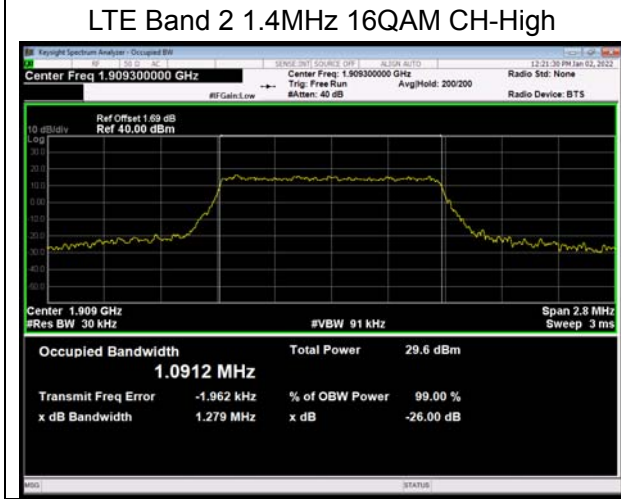
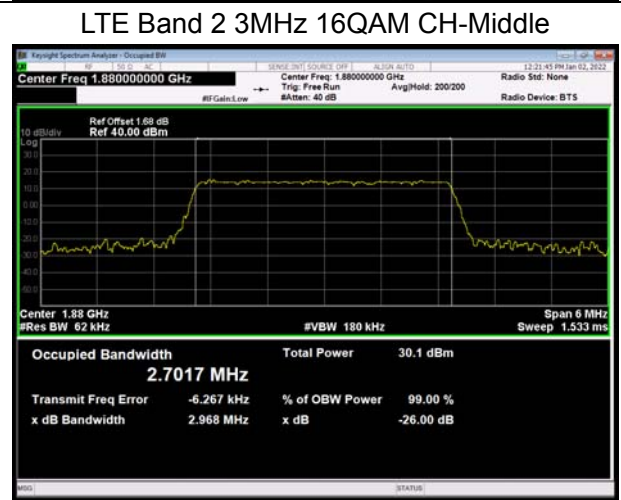
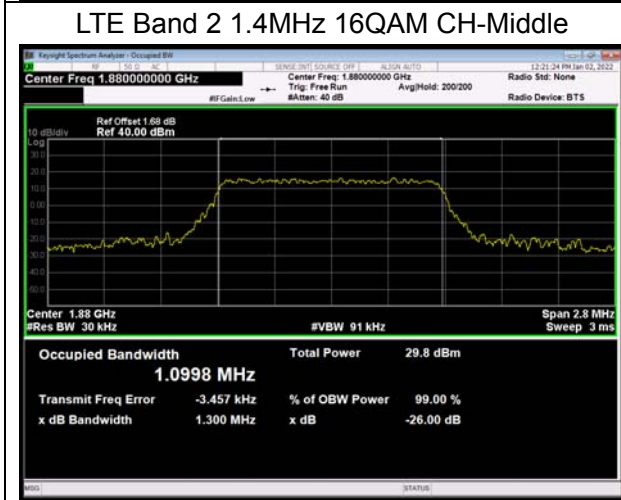
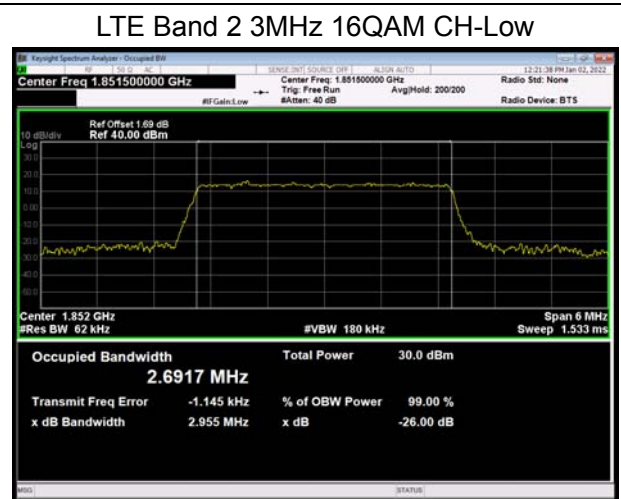
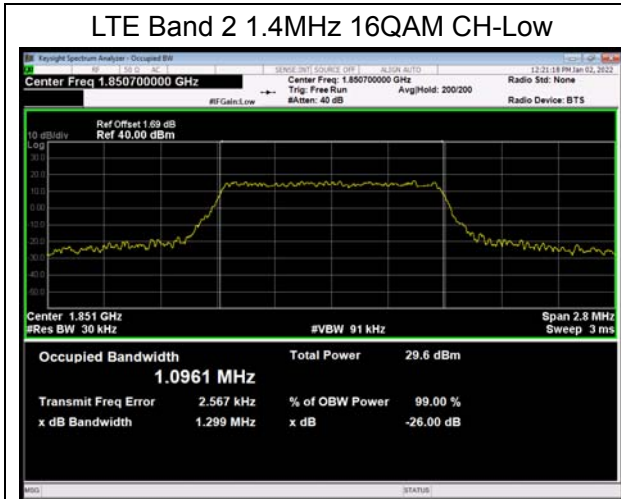

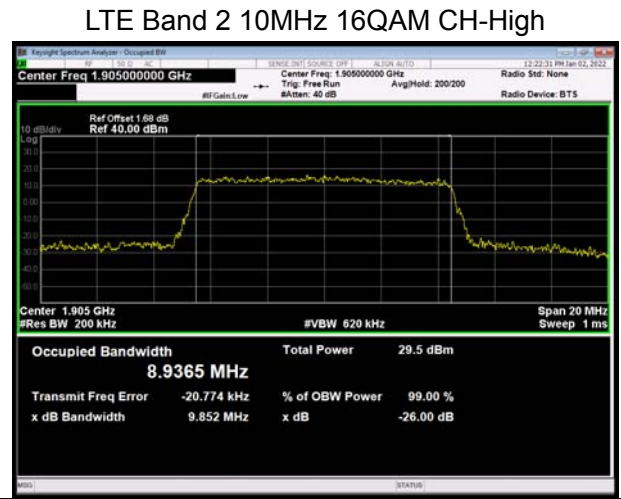
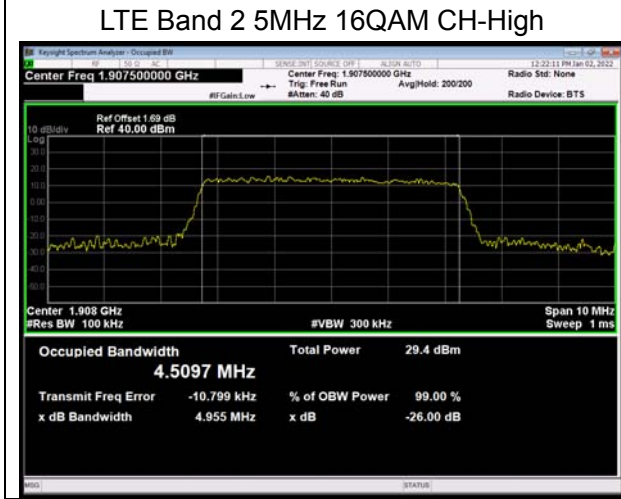
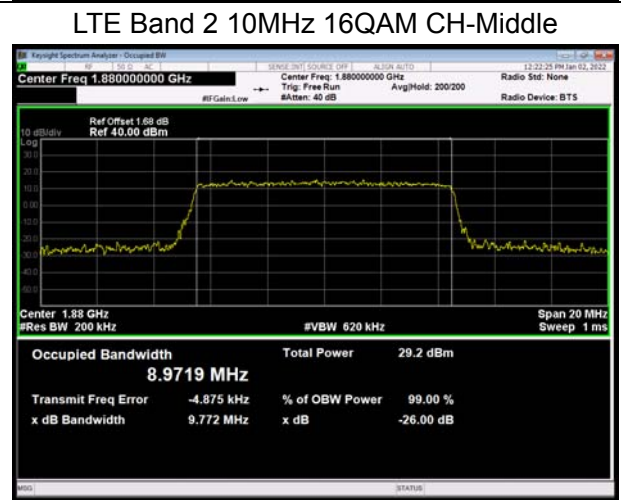
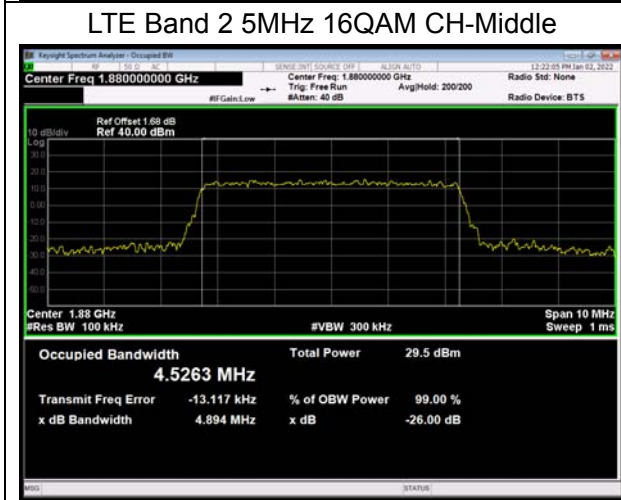
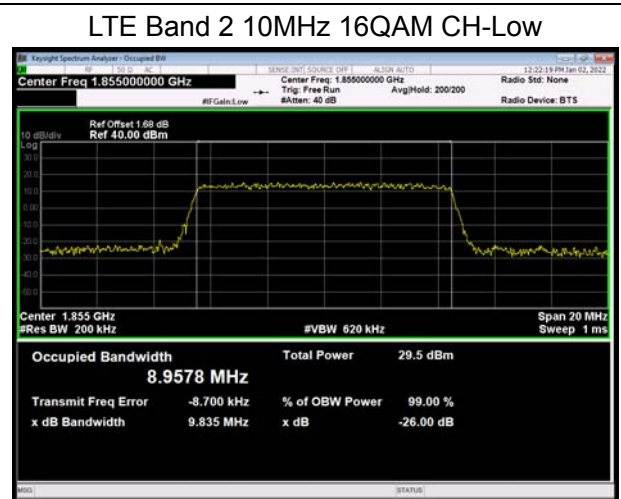
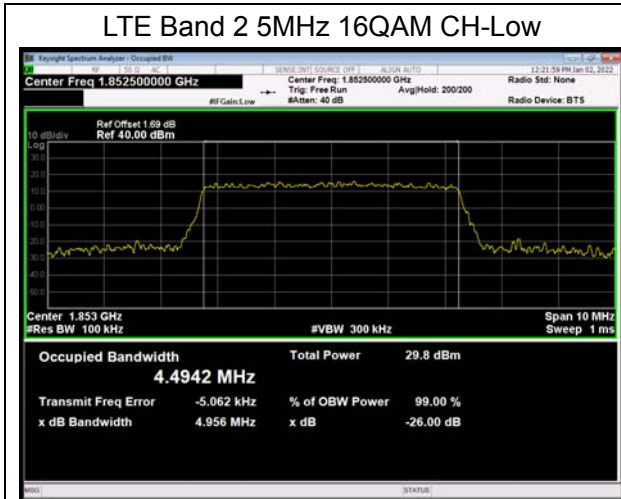



LTE Band 2 15MHz 16QAM CH-Low

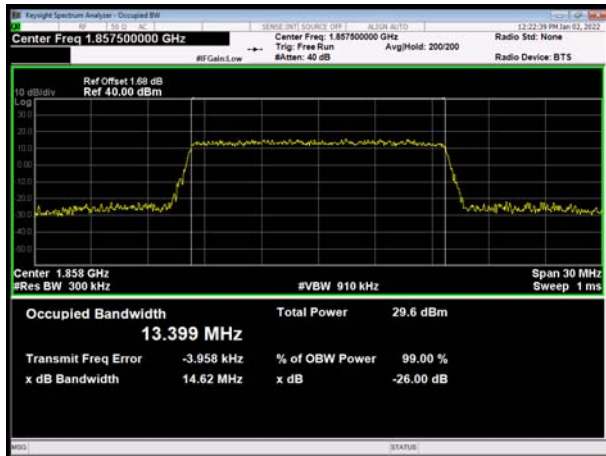

LTE Band 2 20MHz 16QAM CH-Low

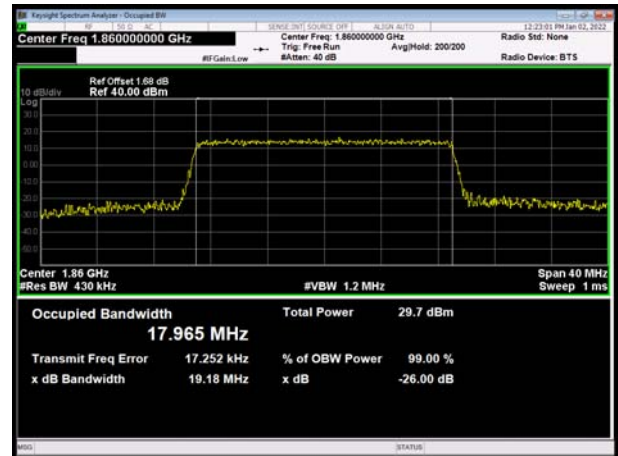

LTE Band 2 15MHz 16QAM CH-Middle

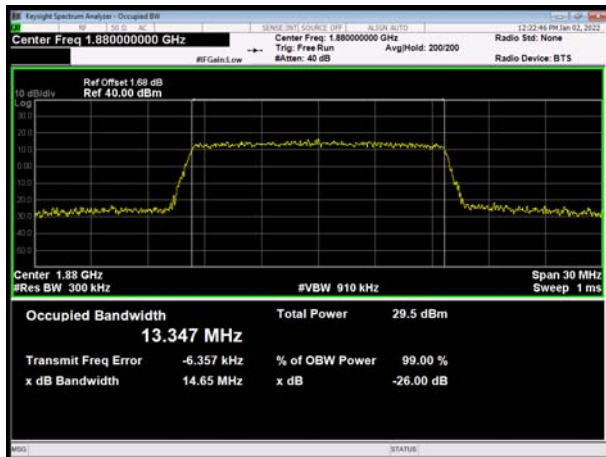

LTE Band 2 20MHz 16QAM CH-Middle



LTE Band 2 15MHz 16QAM CH-High

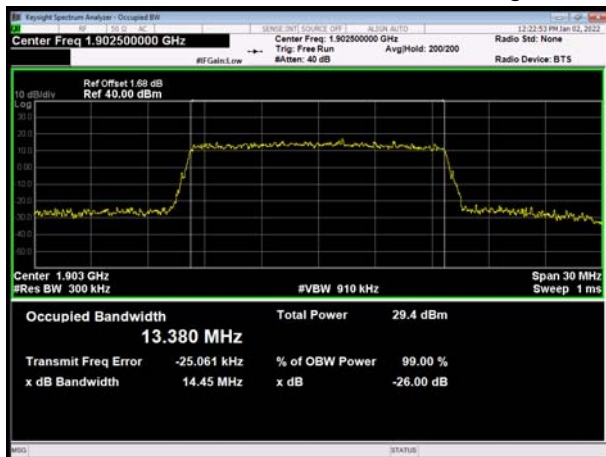

LTE Band 2 20MHz 16QAM CH-High

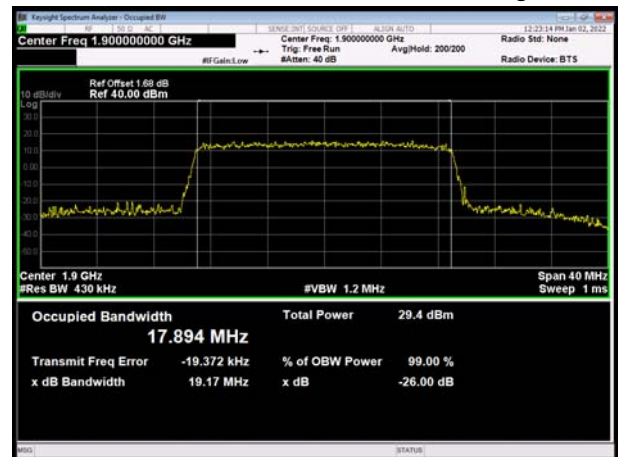

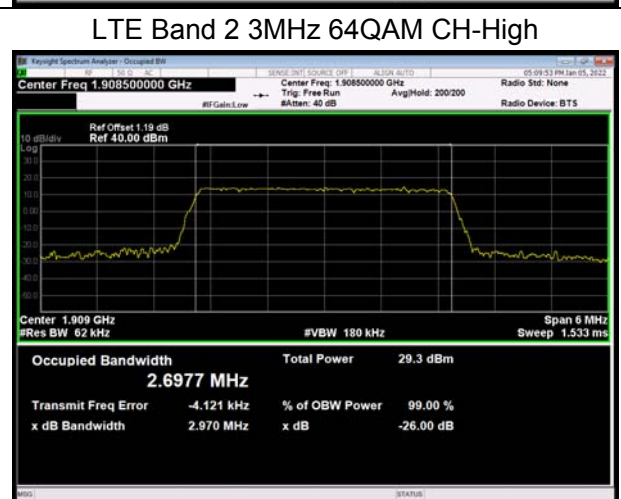
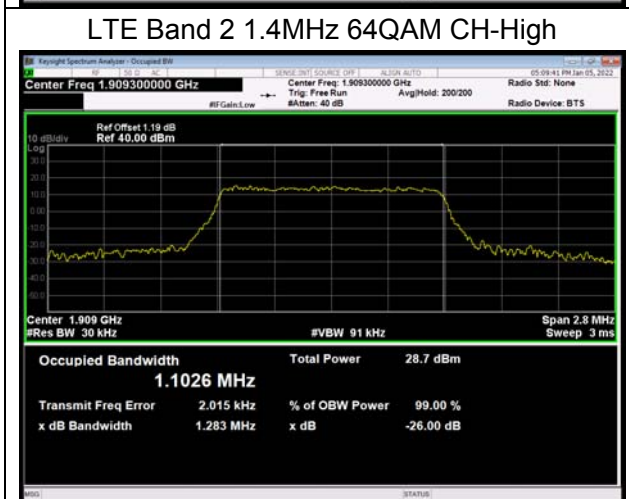
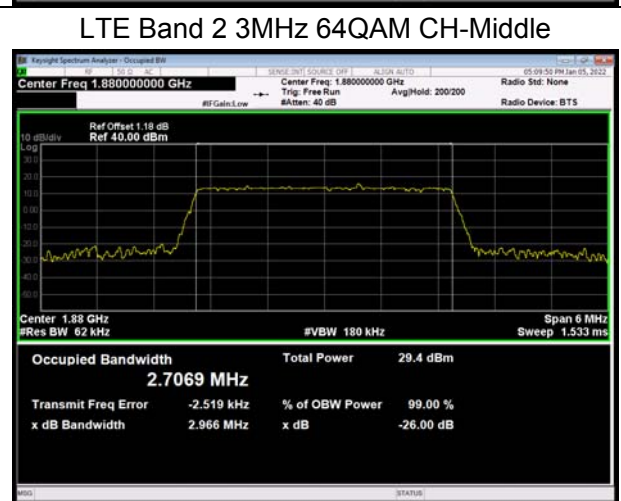
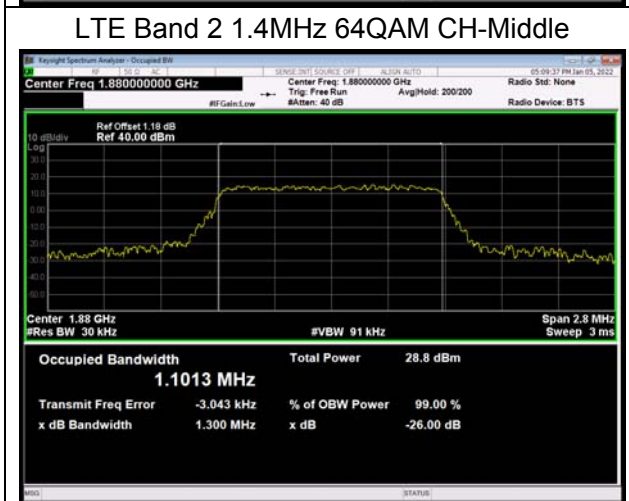
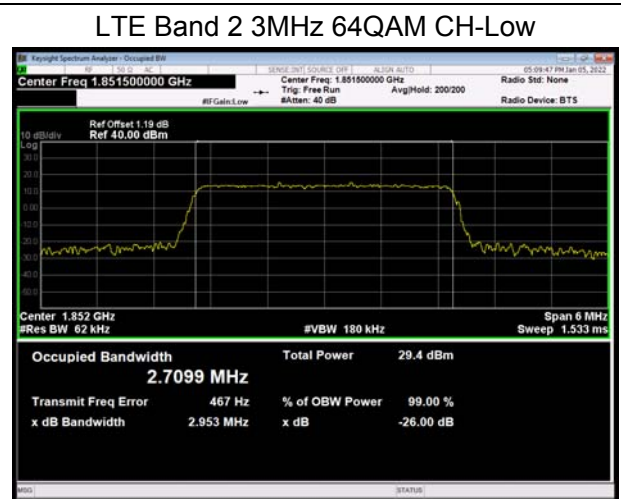
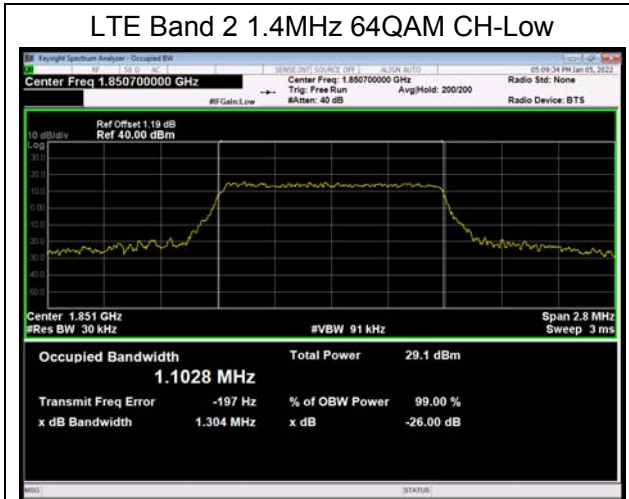

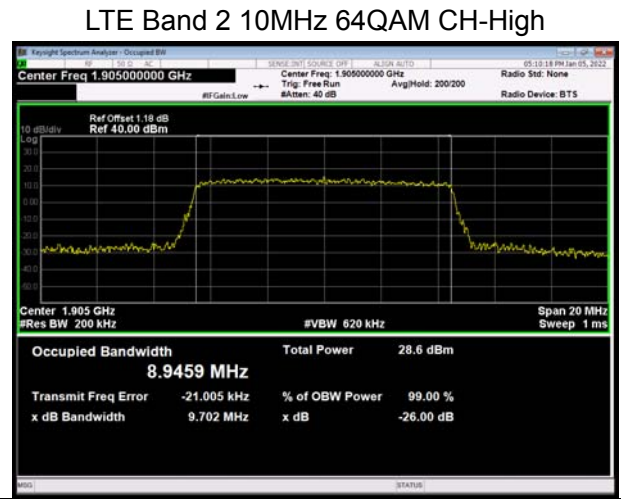
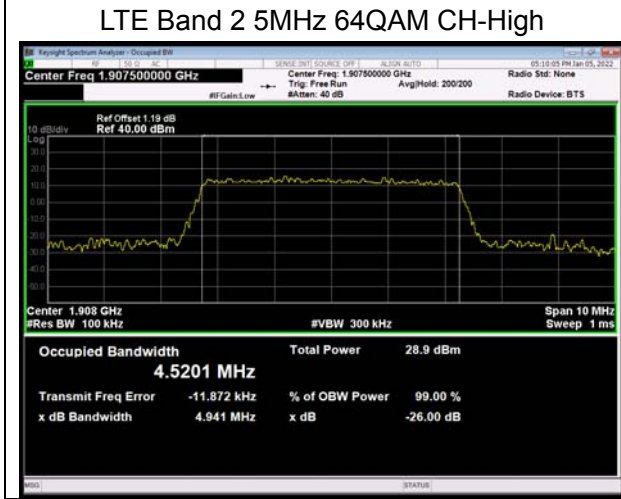
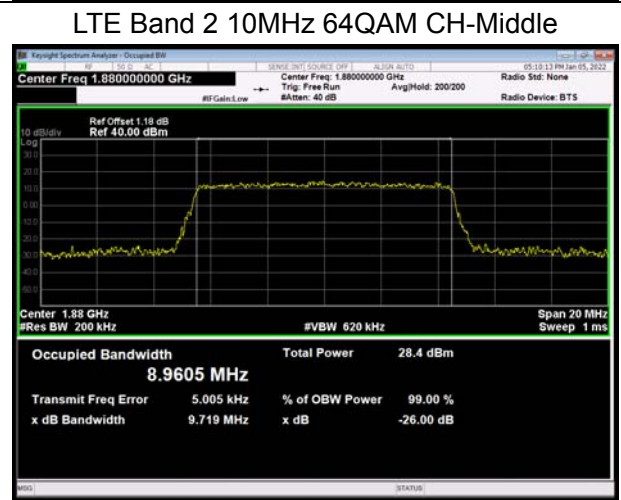
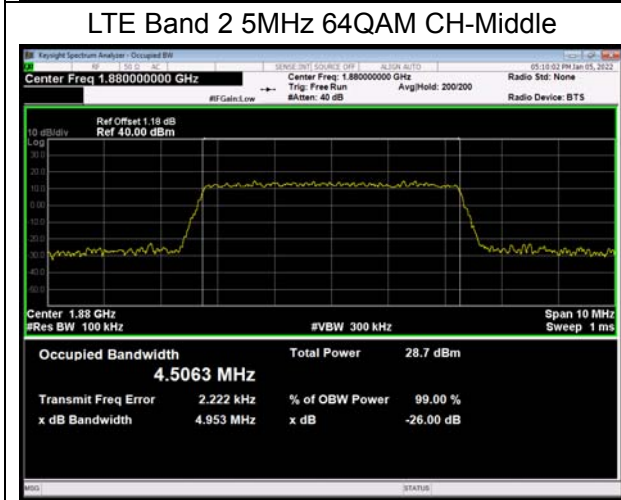
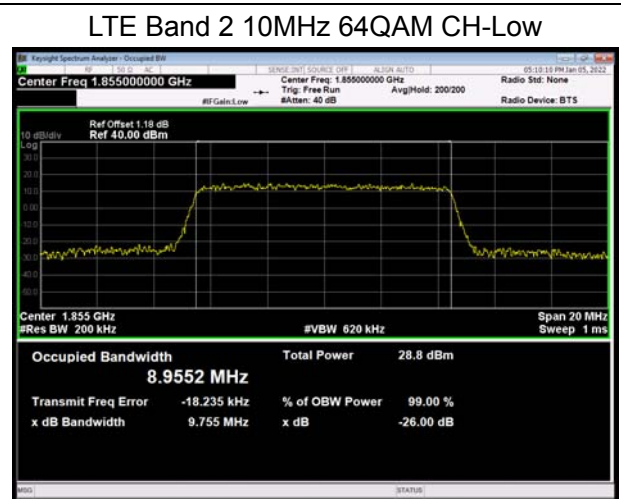
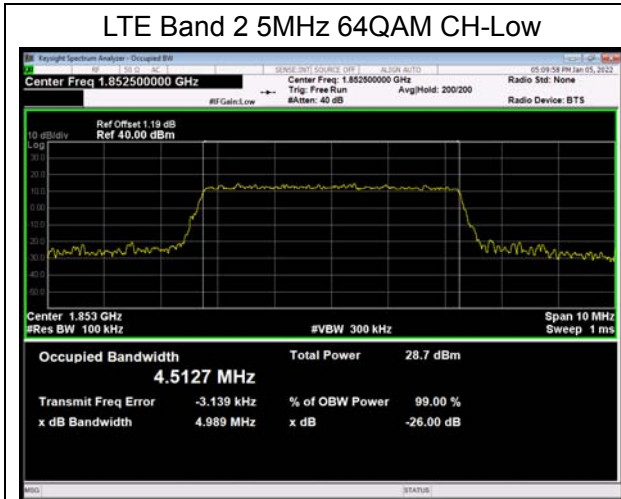



LTE Band 2 15MHz 64QAM CH-Low

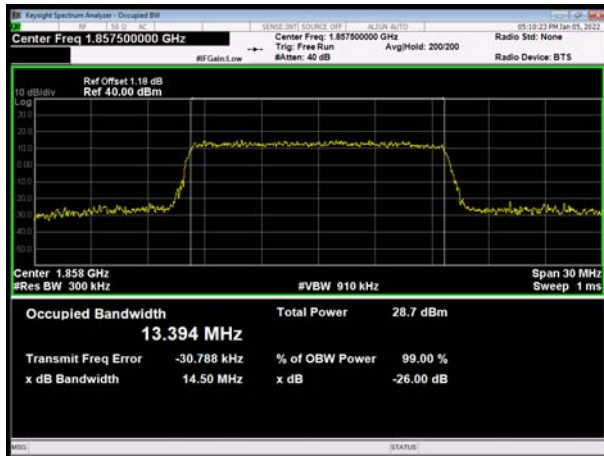

LTE Band 2 20MHz 64QAM CH-Low

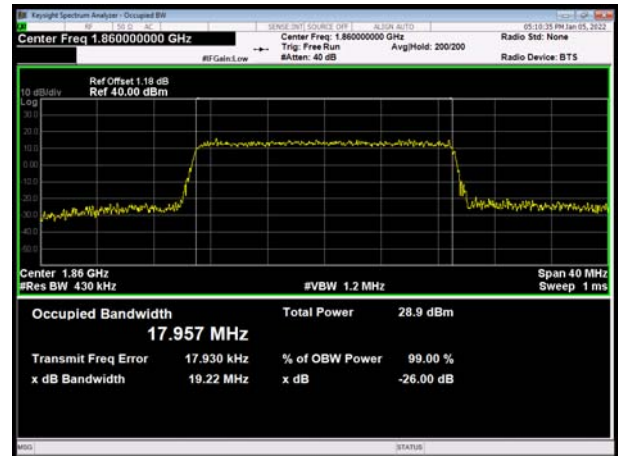

LTE Band 2 15MHz 64QAM CH-Middle



LTE Band 2 20MHz 64QAM CH-Middle



LTE Band 2 15MHz 64QAM CH-High

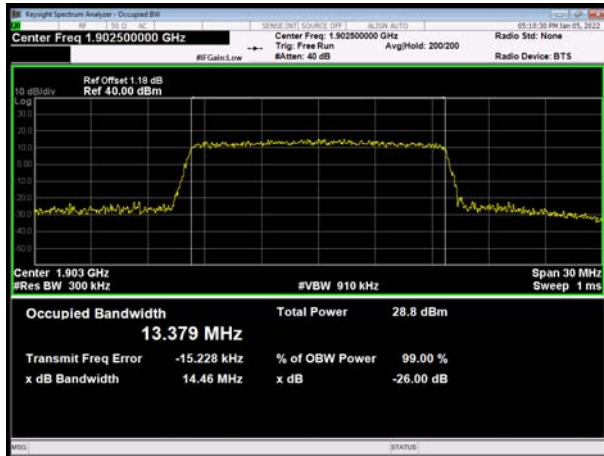

LTE Band 2 20MHz 64QAM CH-High

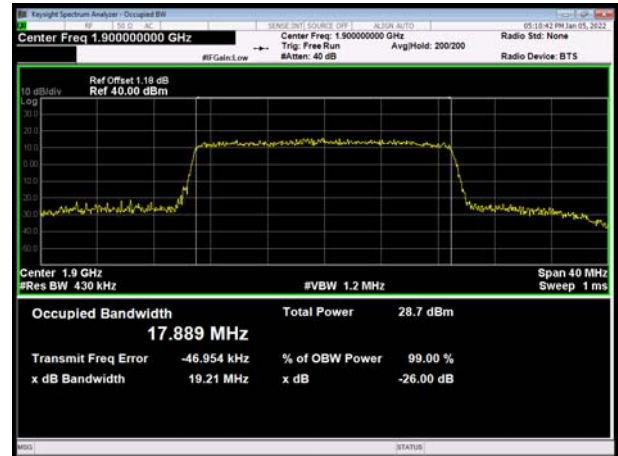

5.3. Band Edge Compliance

Ambient condition

Temperature	Relative humidity	Pressure
23°C ~25°C	45%~50%	101.5kPa

Method of Measurement

The EUT was connected to Spectrum Analyzer and Base Station Simulator via power Splitter. The band edge of the lowest and highest channels were measured. The Average detector is used and RBW is set to $\geq 1\%EBW$, VBW is set to 3x RBW.

Spectrum analyzer plots are included on the following pages.

Test Setup

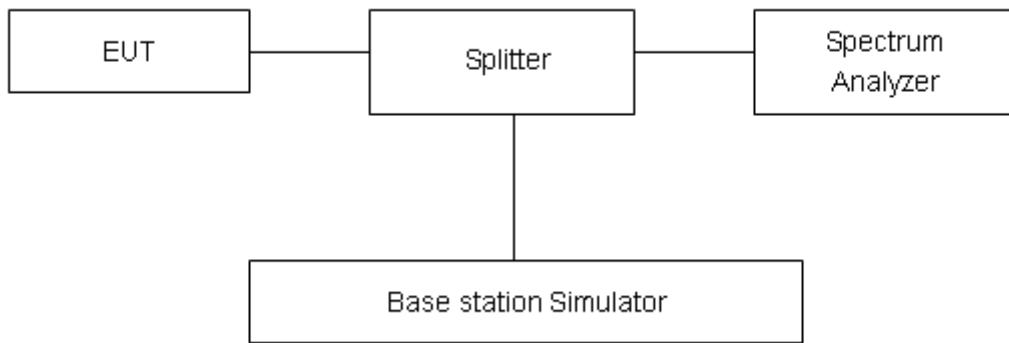

Limits

Rule Part 24.238(a) specifies that “on any frequency outside a licensee's frequency block, the power of any emission shall be attenuated below the transmitter power (P) by at least $43 + 10 \log_{10} (P)$ dB.”

Limit	-13 dBm
-------	---------

Measurement Uncertainty

The assessed measurement uncertainty to ensure 95% confidence level for the normal distribution is with the coverage factor $k = 1.96$, $U=0.684dB$.



Test Result:

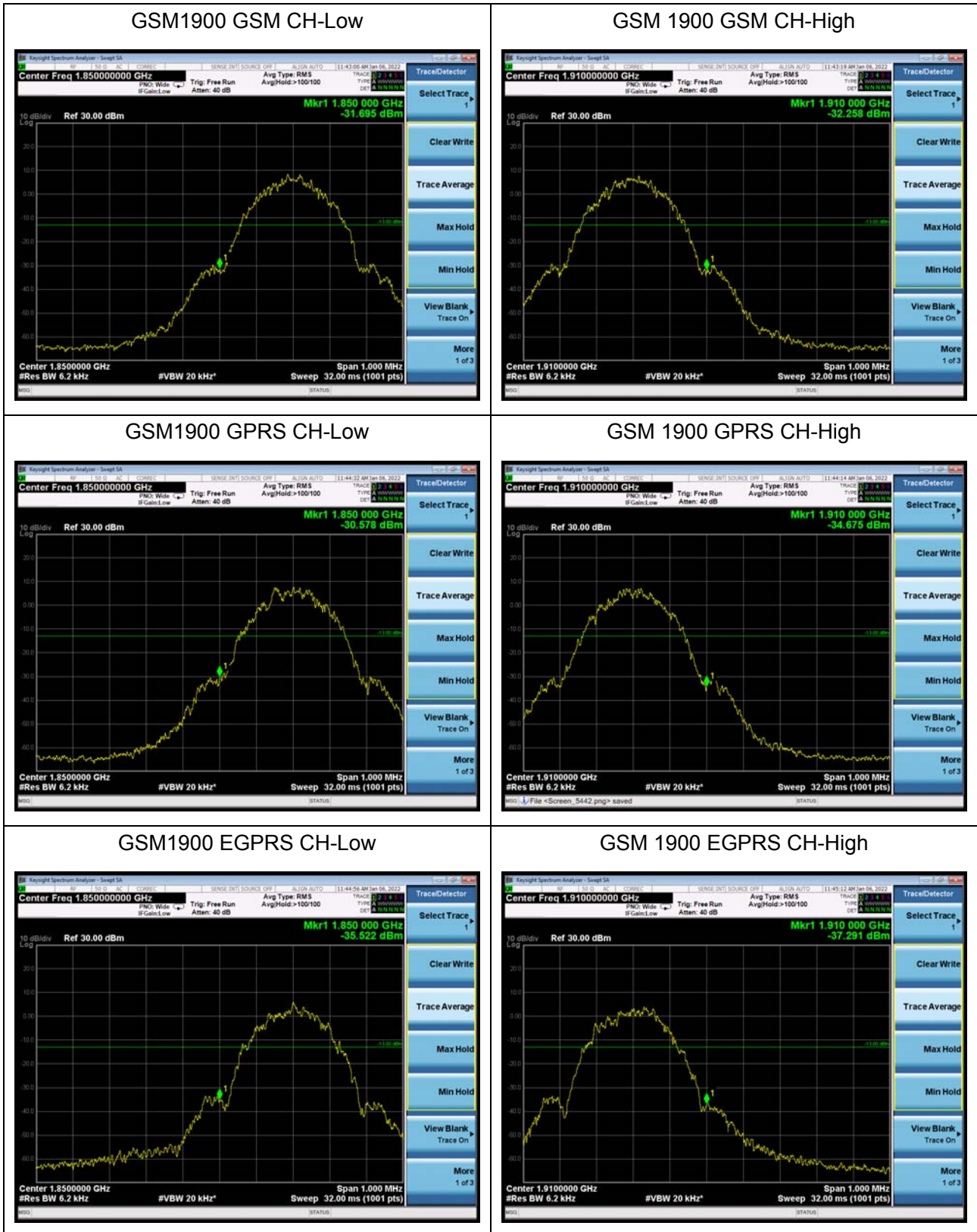



WCDMA Band II RMC CH-Low



WCDMA Band II RMC CH-High





LTE Band 2 1.4MHz QPSK 1RB CH-Low

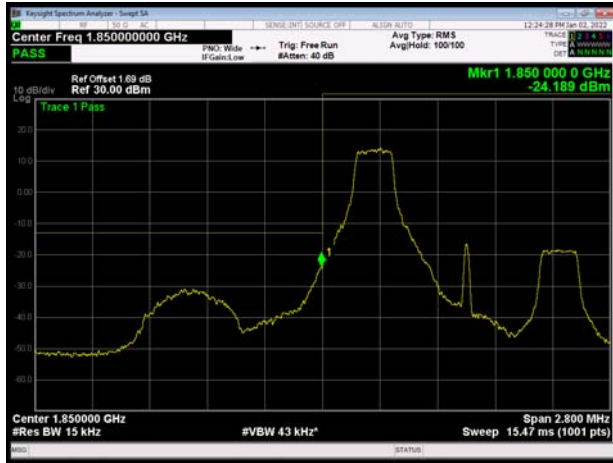

LTE Band 2 1.4MHz QPSK 1RB CH-High

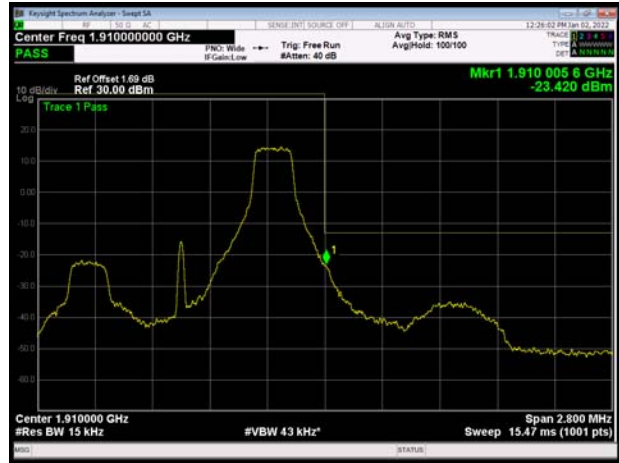

LTE Band 2 1.4MHz QPSK 100%RB CH-Low

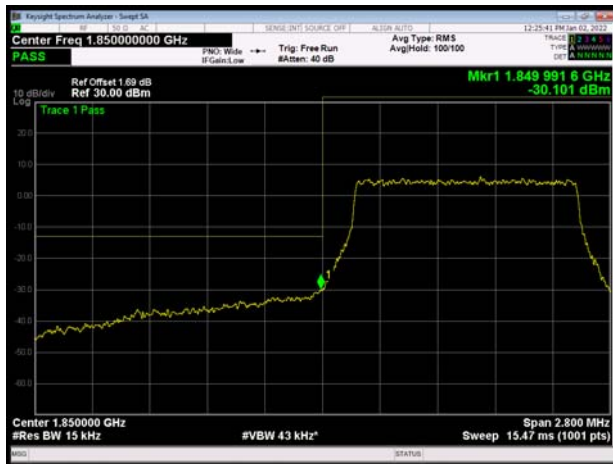

LTE Band 2 1.4MHz QPSK 100%RB CH-High



LTE Band 2 3MHz QPSK 1RB CH-Low

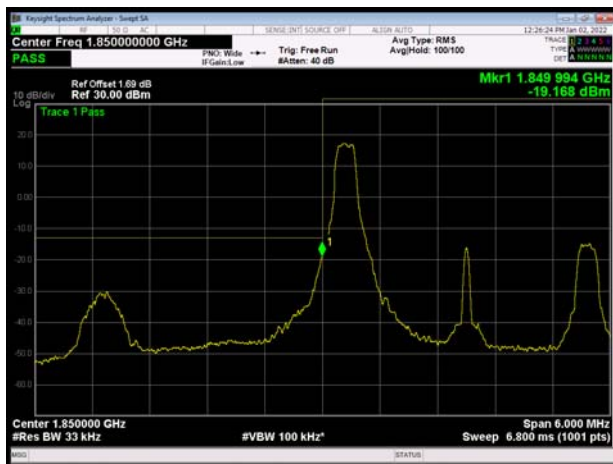

LTE Band 2 3MHz QPSK 1RB CH-High

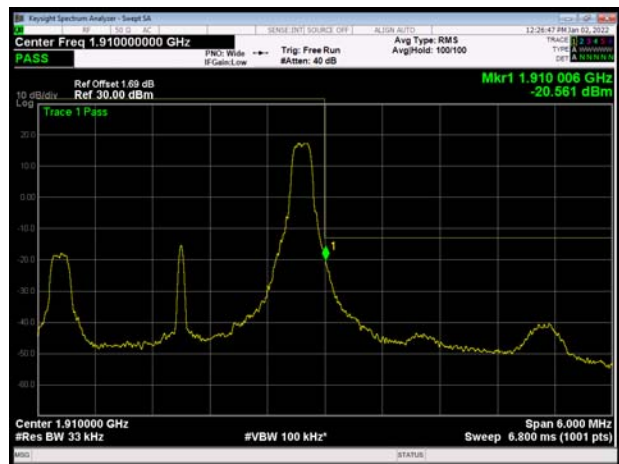



LTE Band 2 3MHz QPSK 100%RB CH-Low

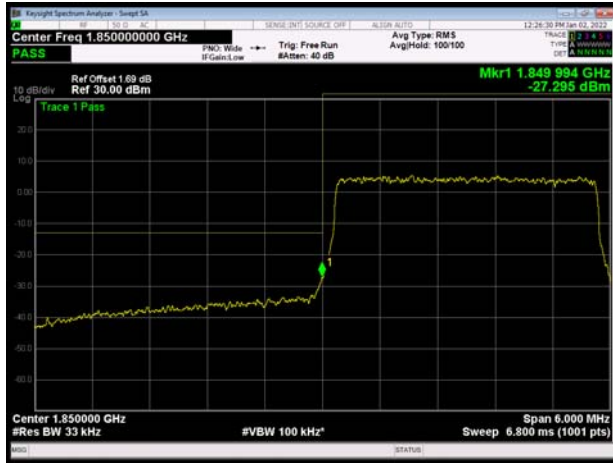

LTE Band 2 3MHz QPSK 100%RB CH-High

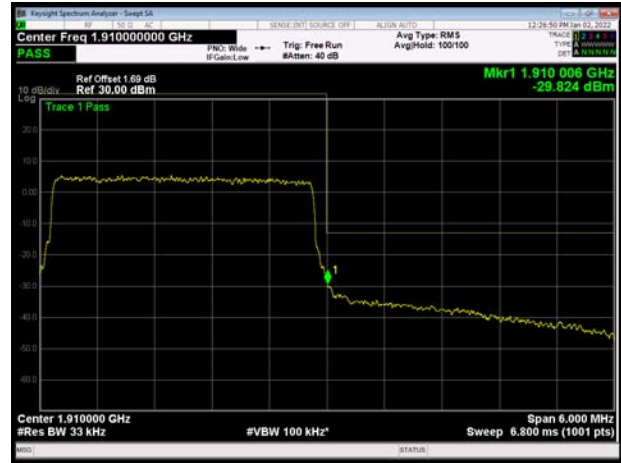

LTE Band 2 5MHz QPSK 1RB CH-Low

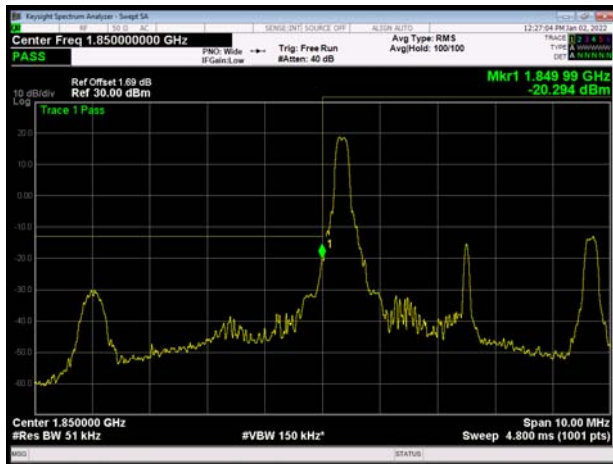

LTE Band 2 5MHz QPSK 1RB CH-High

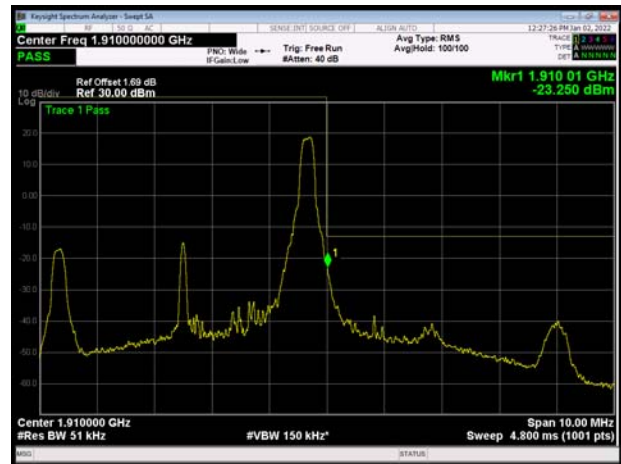

LTE Band 2 5MHz QPSK 100%RB CH-Low

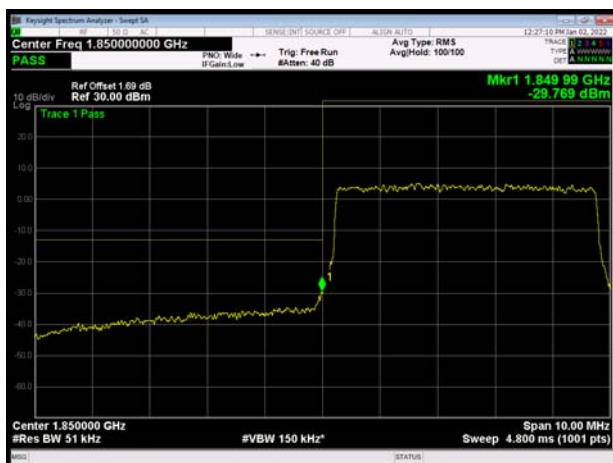

LTE Band 2 5MHz QPSK 100%RB CH-High

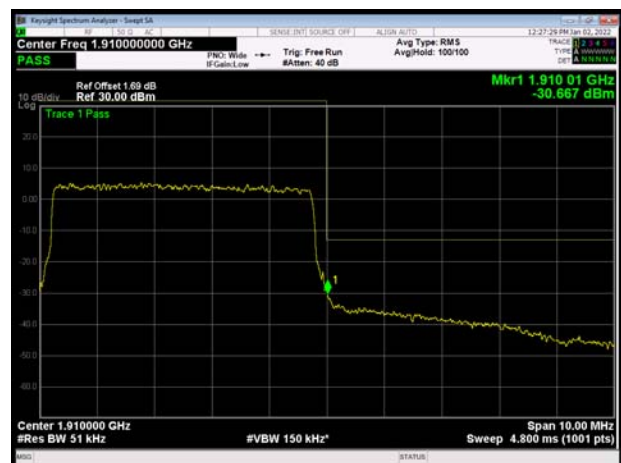



LTE Band 2 10MHz QPSK 1RB CH-Low

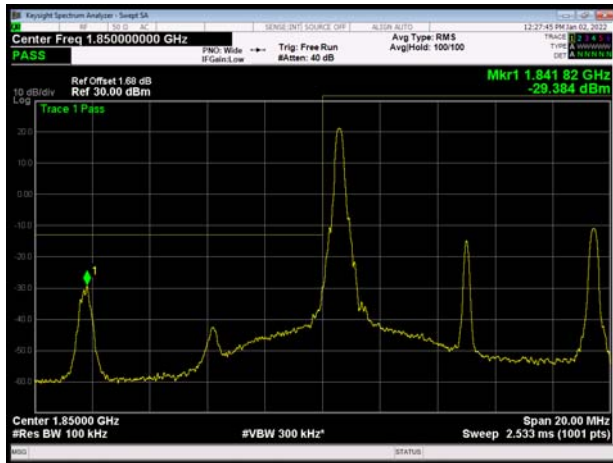

LTE Band 2 10MHz QPSK 1RB CH-High

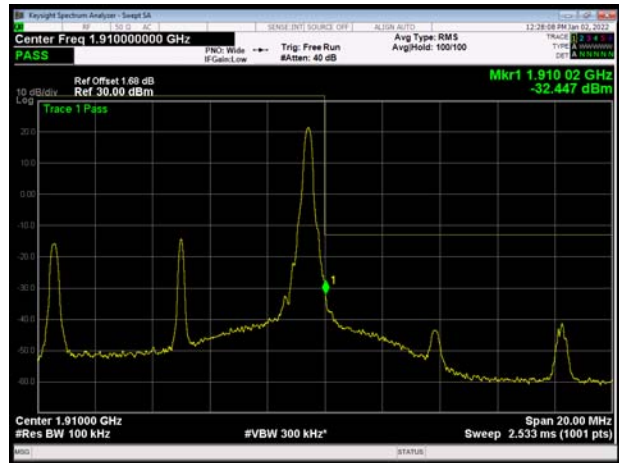

LTE Band 2 10MHz QPSK 100%RB CH-Low

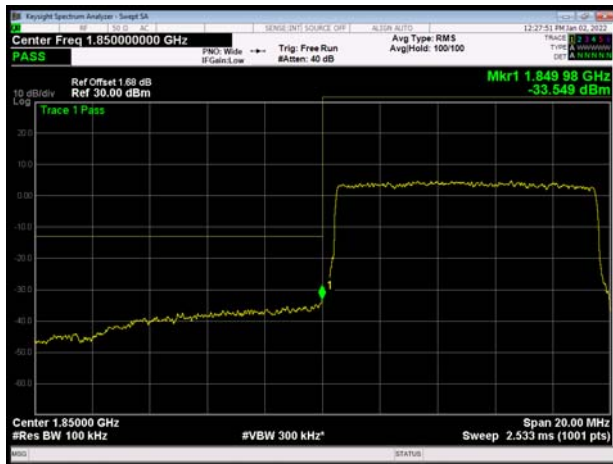

LTE Band 2 10MHz QPSK 100%RB CH-High



LTE Band 2 15MHz QPSK 1RB CH-Low

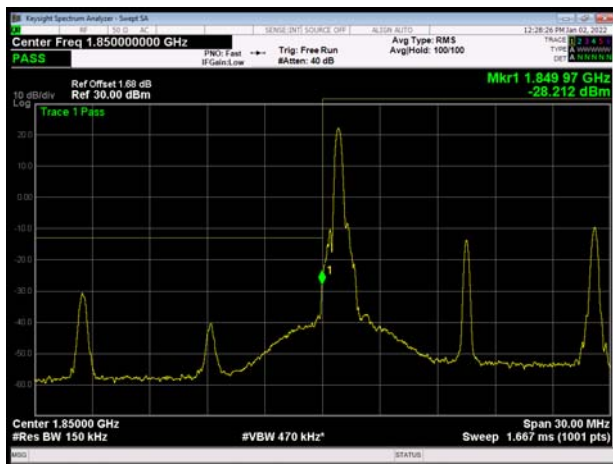

LTE Band 2 15MHz QPSK 1RB CH-High

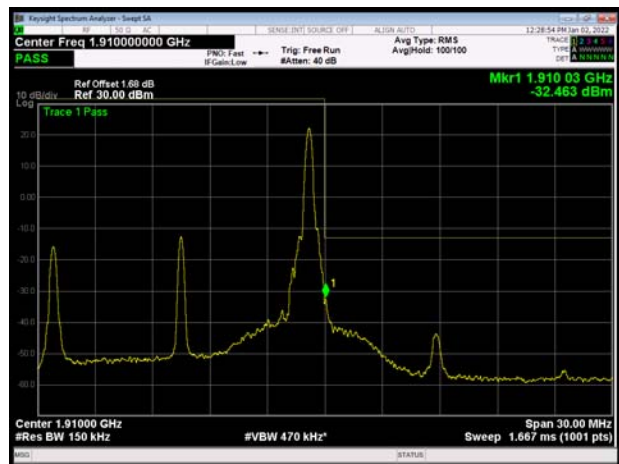



LTE Band 2 15MHz QPSK 100%RB CH-Low

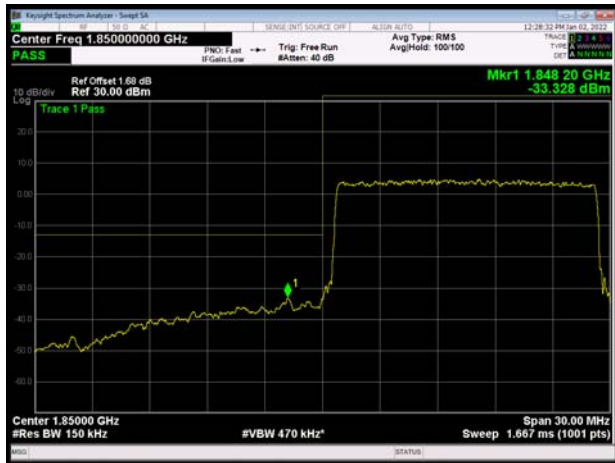

LTE Band 2 15MHz QPSK 100%RB CH-High



LTE Band 2 20MHz QPSK 1RB CH-Low

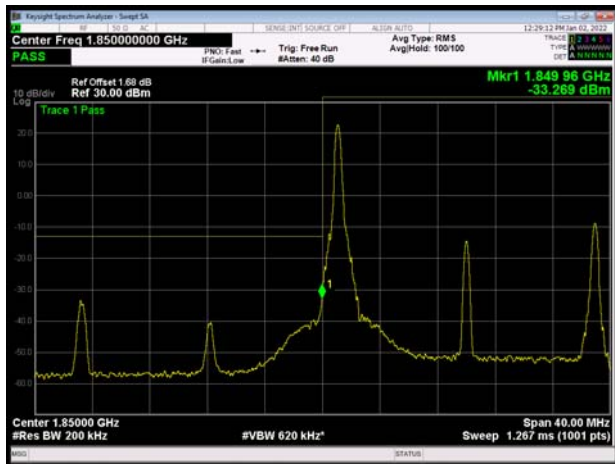

LTE Band 2 20MHz QPSK 1RB CH-High

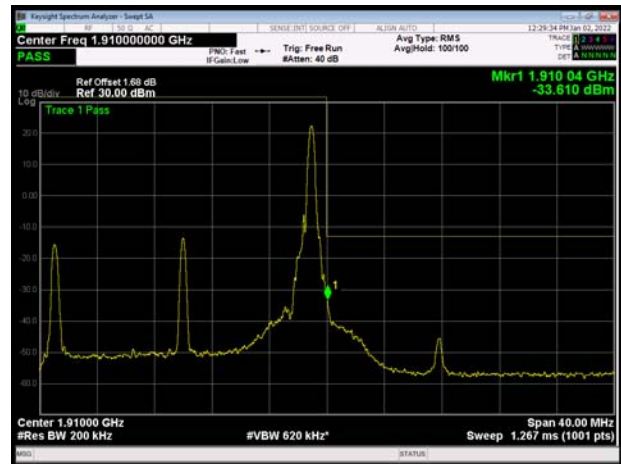

LTE Band 2 20MHz QPSK 100%RB CH-Low

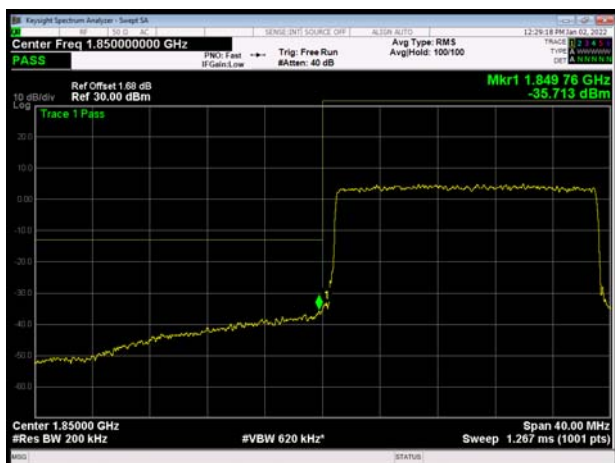

LTE Band 2 20MHz QPSK 100%RB CH-High

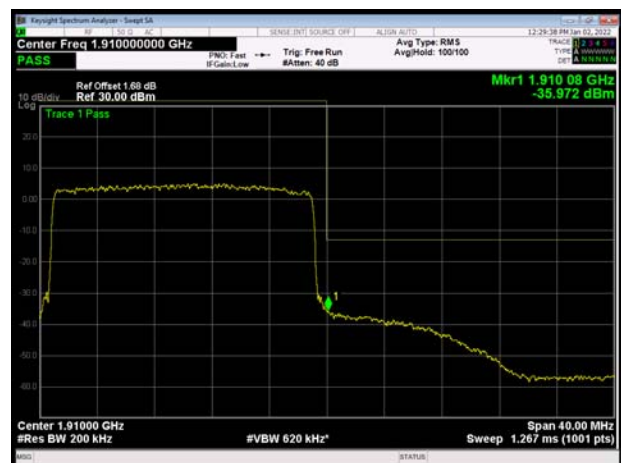



LTE Band 2 1.4MHz 16QAM 1RB CH-Low



LTE Band 2 1.4MHz 16QAM 1RB CH-High



LTE Band 2 1.4MHz 16QAM 100%RB CH-Low



LTE Band 2 1.4MHz 16QAM 100%RB CH-High



LTE Band 2 3MHz 16QAM 1RB CH-Low

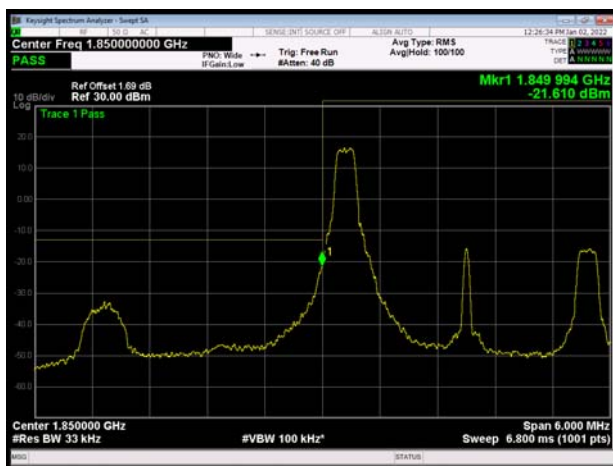

LTE Band 2 3MHz 16QAM 1RB CH-High

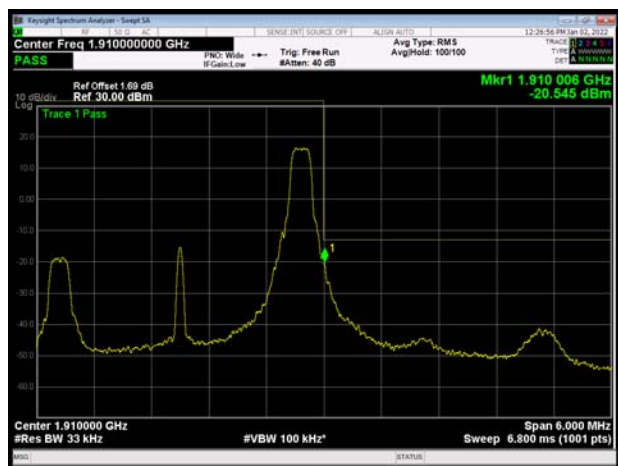



LTE Band 2 3MHz 16QAM 100%RB CH-Low

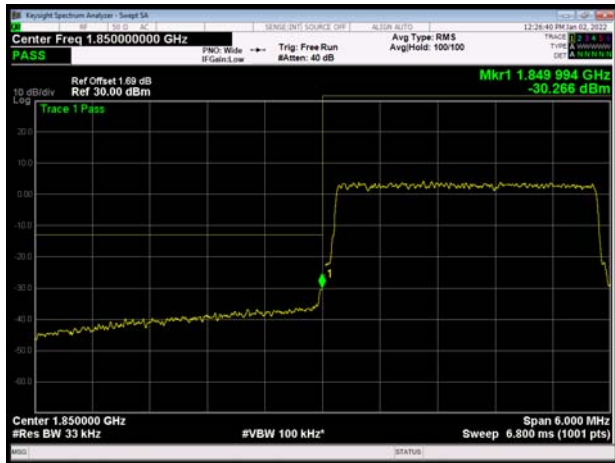

LTE Band 2 3MHz 16QAM 100%RB CH-High



LTE Band 2 5MHz 16QAM 1RB CH-Low

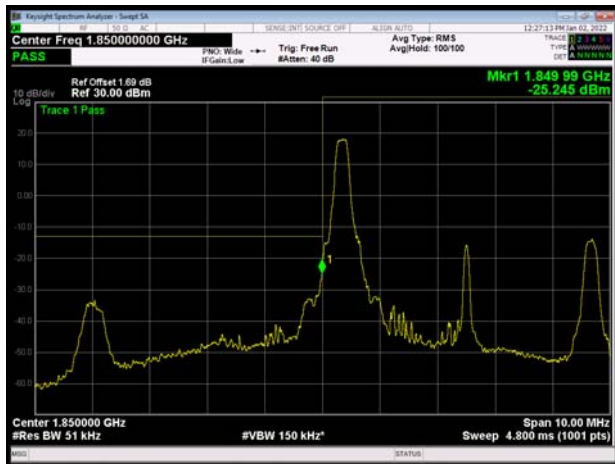

LTE Band 2 5MHz 16QAM 1RB CH-High

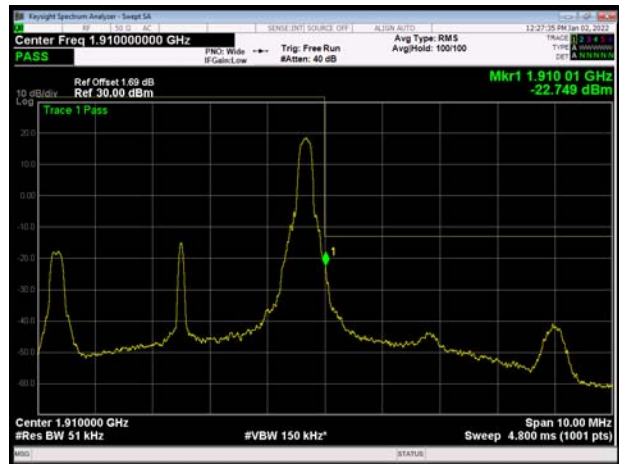

LTE Band 2 5MHz 16QAM 100%RB CH-Low

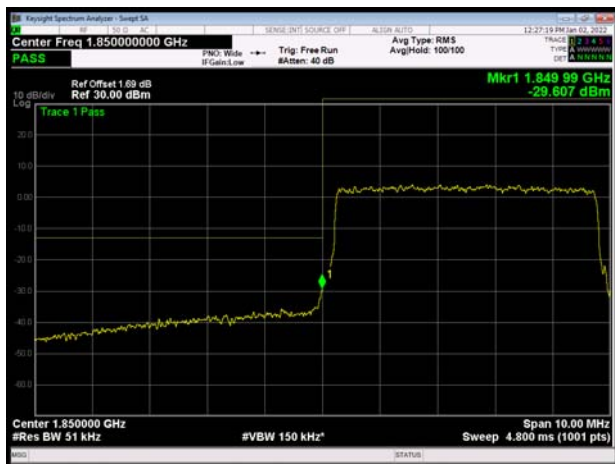

LTE Band 2 5MHz 16QAM 100%RB CH-High





LTE Band 2 10MHz 16QAM 1RB CH-Low

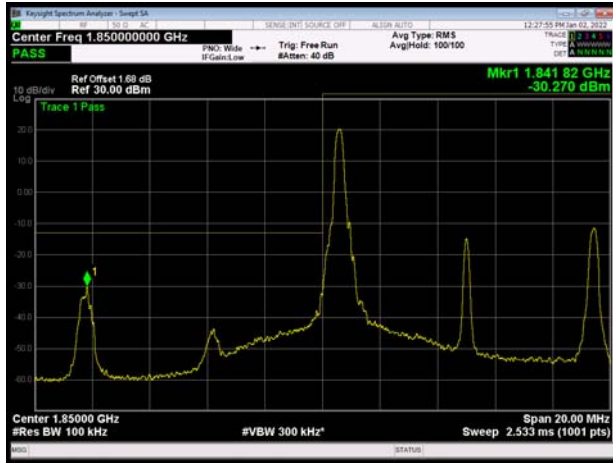

LTE Band 2 10MHz 16QAM 1RB CH-High

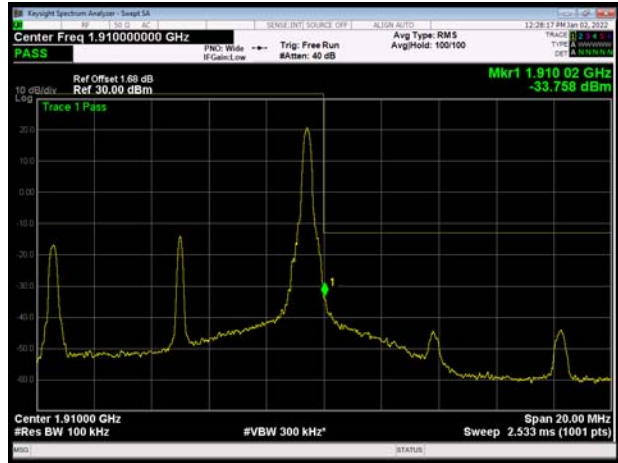

LTE Band 2 10MHz 16QAM 100%RB CH-Low

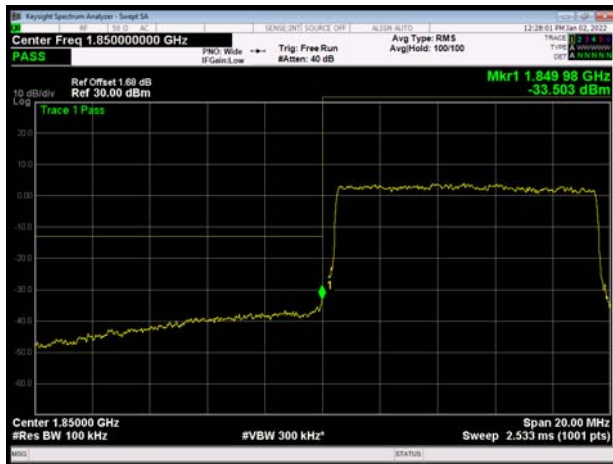

LTE Band 2 10MHz 16QAM 100%RB CH-High



LTE Band 2 15MHz 16QAM 1RB CH-Low

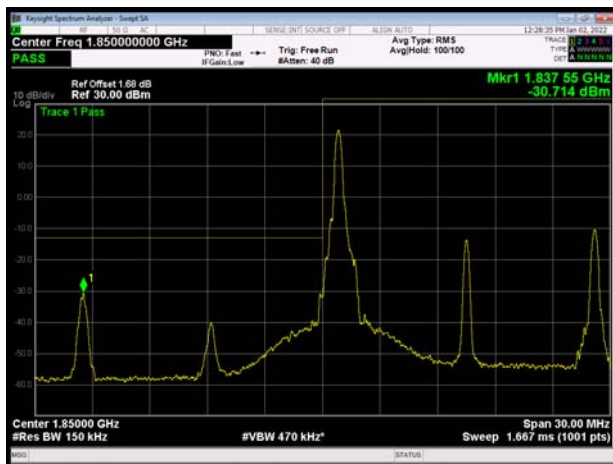

LTE Band 2 15MHz 16QAM 1RB CH-High

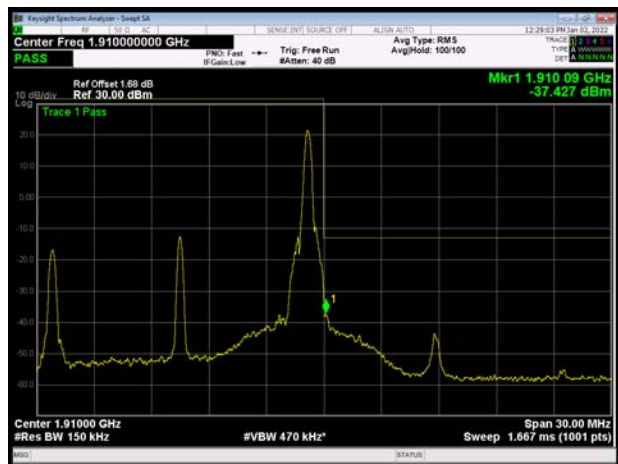



LTE Band 2 15MHz 16QAM 100%RB CH-Low

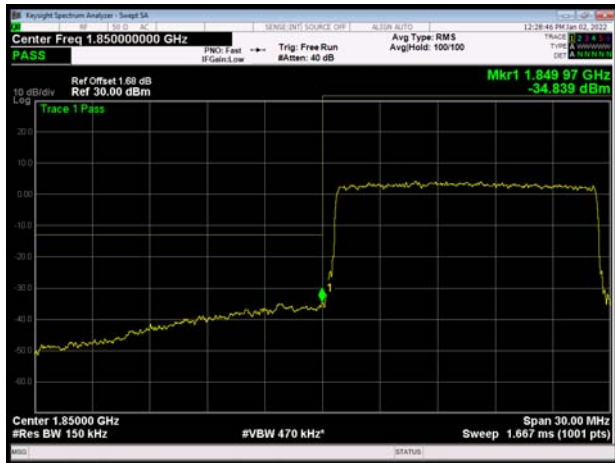

LTE Band 2 15MHz 16QAM 100%RB CH-High



LTE Band 2 20MHz 16QAM 1RB CH-Low

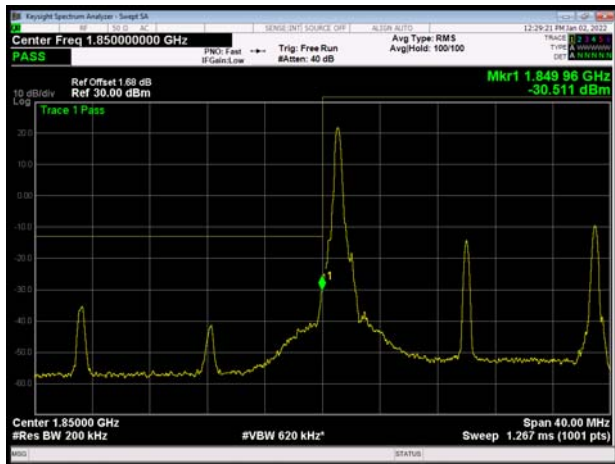

LTE Band 2 20MHz 16QAM 1RB CH-High

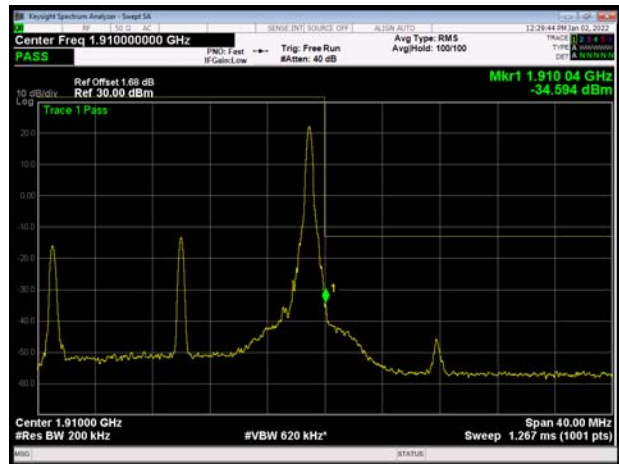

LTE Band 2 20MHz 16QAM 100%RB CH-Low

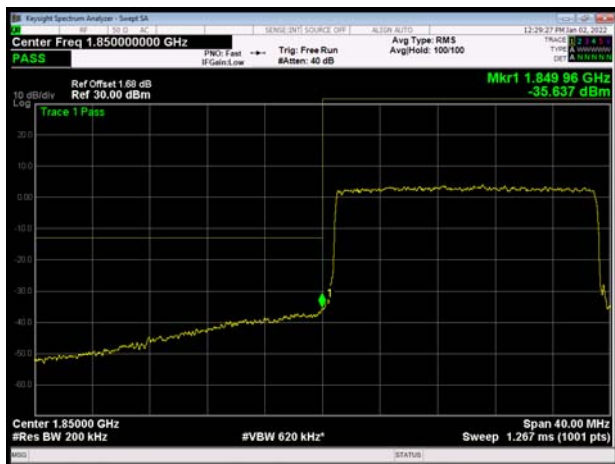

LTE Band 2 20MHz 16QAM 100%RB CH-High

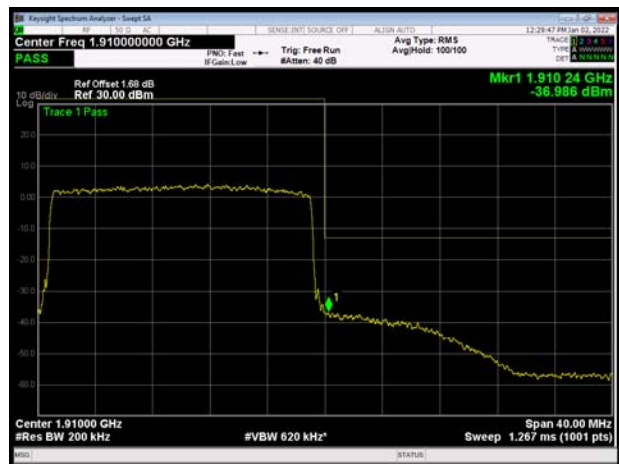



LTE Band 2 1.4MHz 64QAM 1RB CH-Low

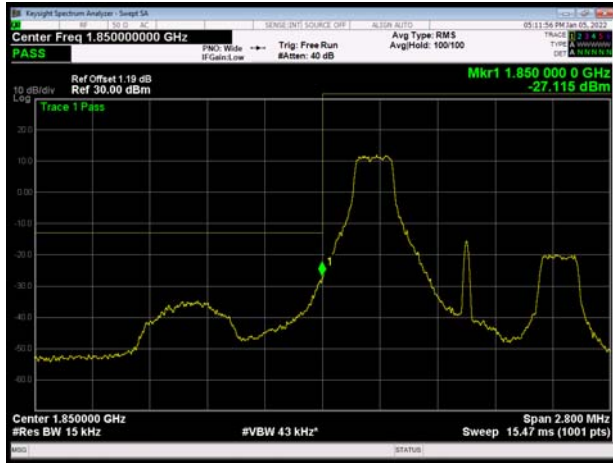

LTE Band 2 1.4MHz 64QAM 1RB CH-High

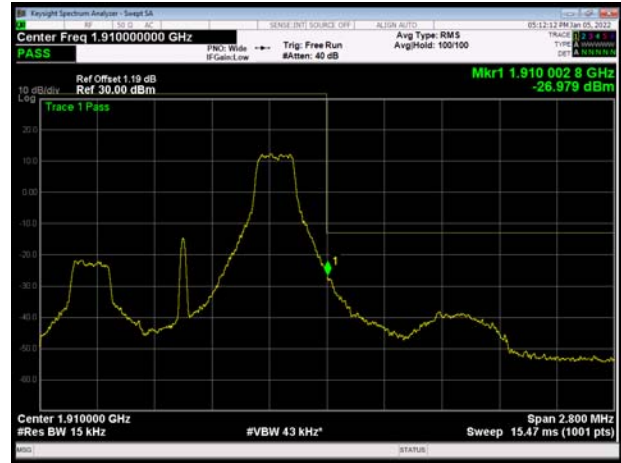

LTE Band 2 1.4MHz 64QAM 100%RB CH-Low

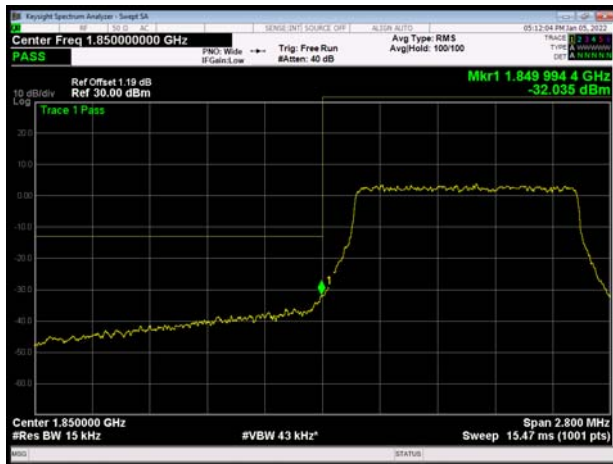

LTE Band 2 1.4MHz 64QAM 100%RB CH-High



LTE Band 2 3MHz 64QAM 1RB CH-Low

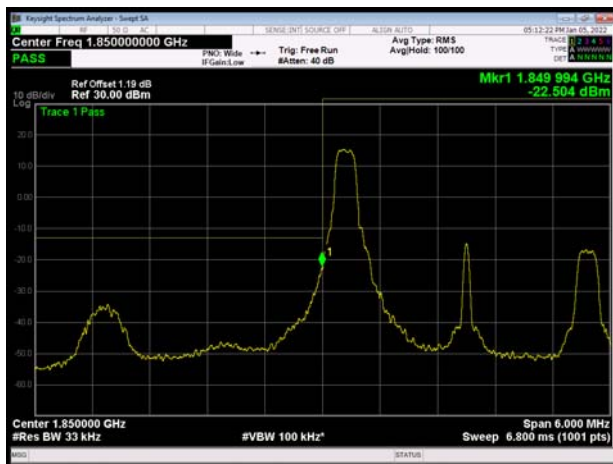

LTE Band 2 3MHz 64QAM 1RB CH-High

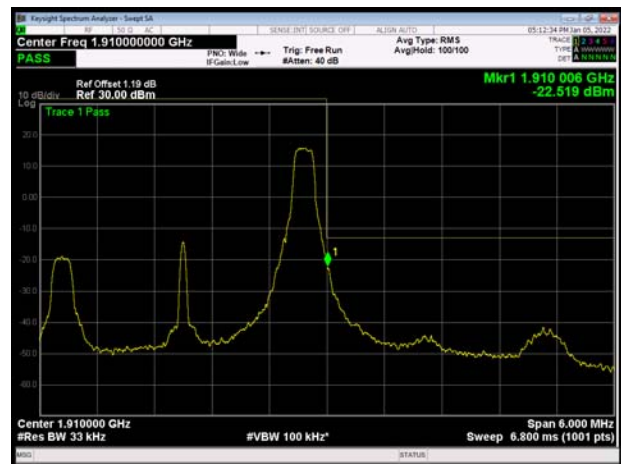



LTE Band 2 3MHz 64QAM 100%RB CH-Low

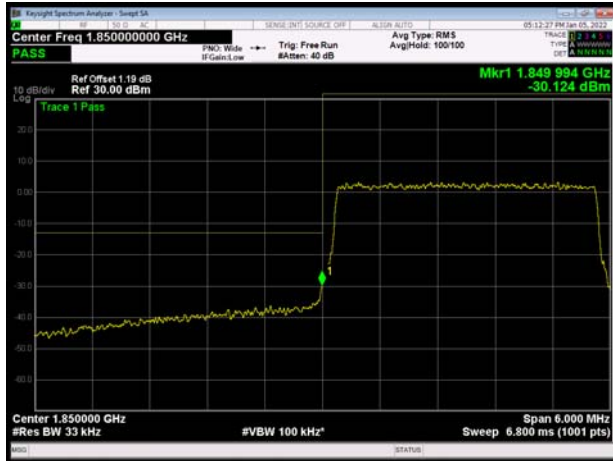

LTE Band 2 3MHz 64QAM 100%RB CH-High



LTE Band 2 5MHz 64QAM 1RB CH-Low

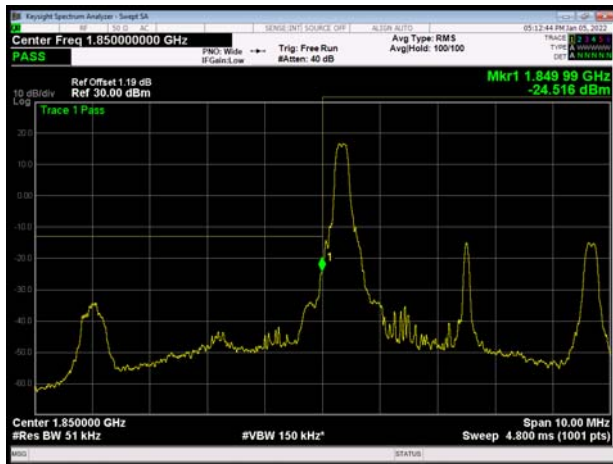

LTE Band 2 5MHz 64QAM 1RB CH-High

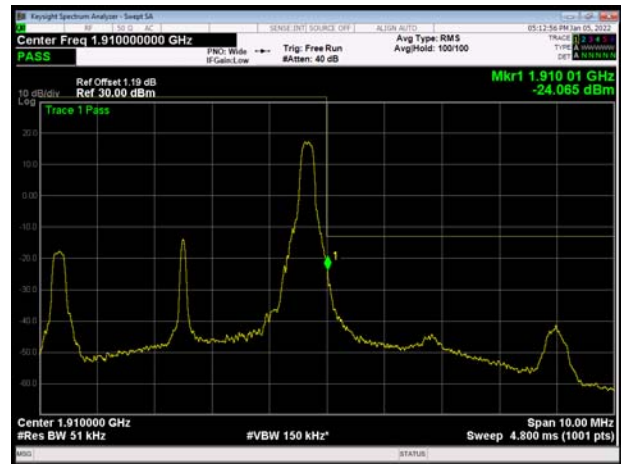

LTE Band 2 5MHz 64QAM 100%RB CH-Low

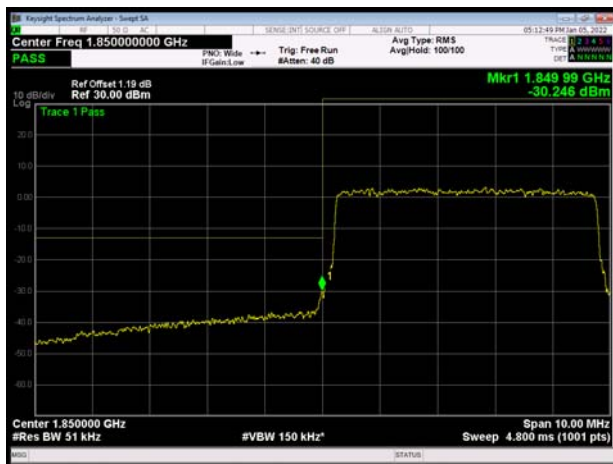

LTE Band 2 5MHz 64QAM 100%RB CH-High

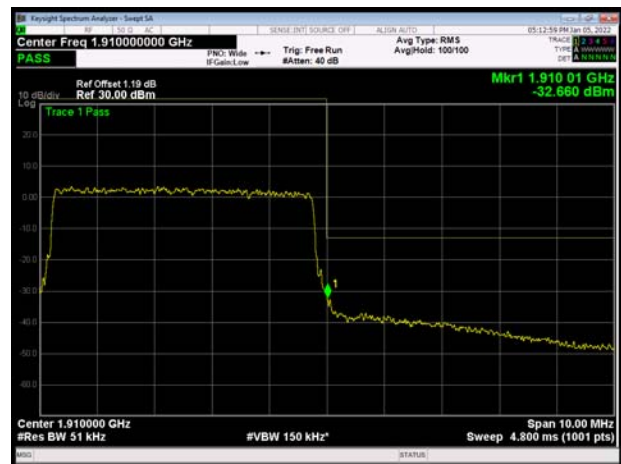



LTE Band 2 10MHz 64QAM 1RB CH-Low

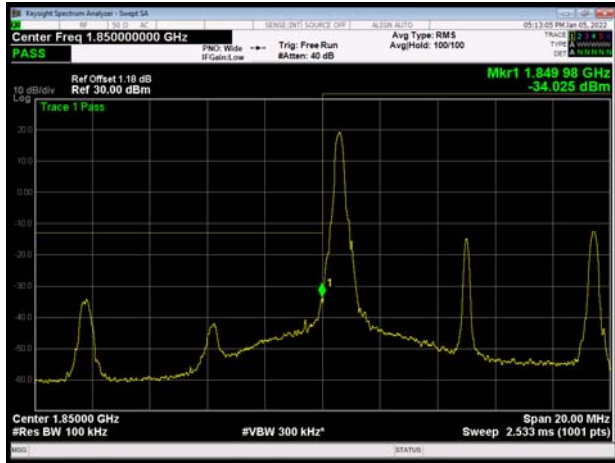

LTE Band 2 10MHz 64QAM 1RB CH-High

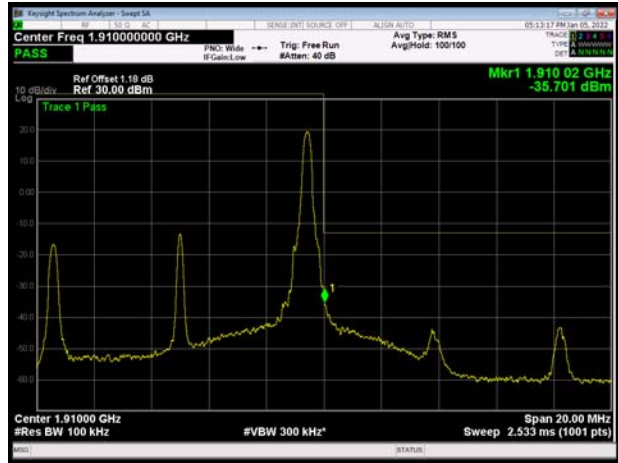

LTE Band 2 10MHz 64QAM 100%RB CH-Low

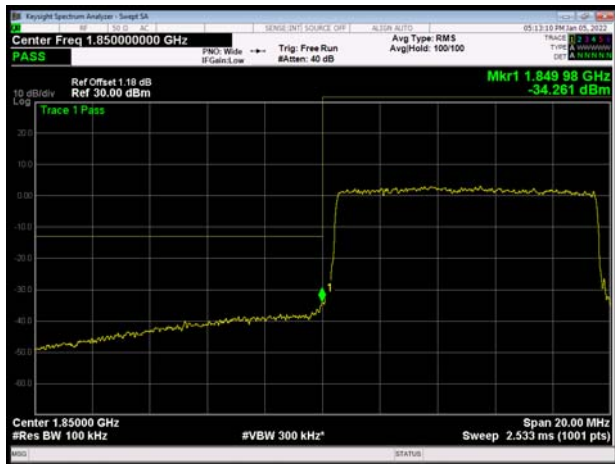

LTE Band 2 10MHz 64QAM 100%RB CH-High



LTE Band 2 15MHz 64QAM 1RB CH-Low

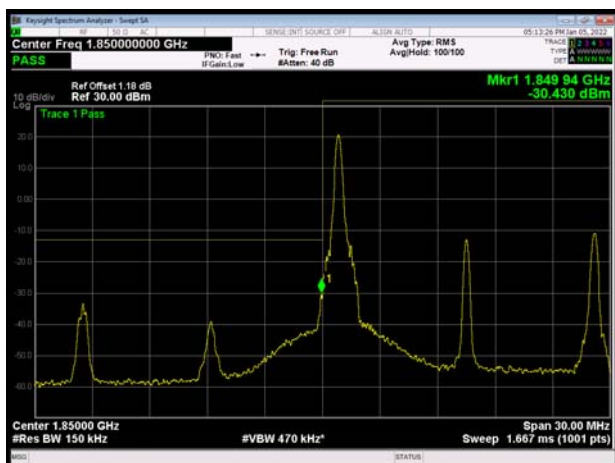

LTE Band 2 15MHz 64QAM 1RB CH-High

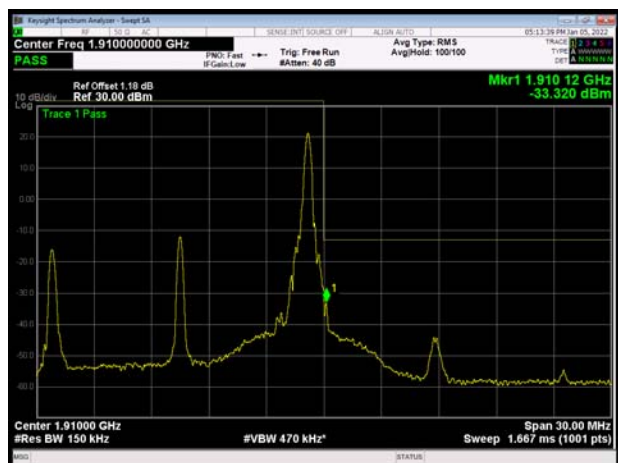



LTE Band 2 15MHz 64QAM 100%RB CH-Low

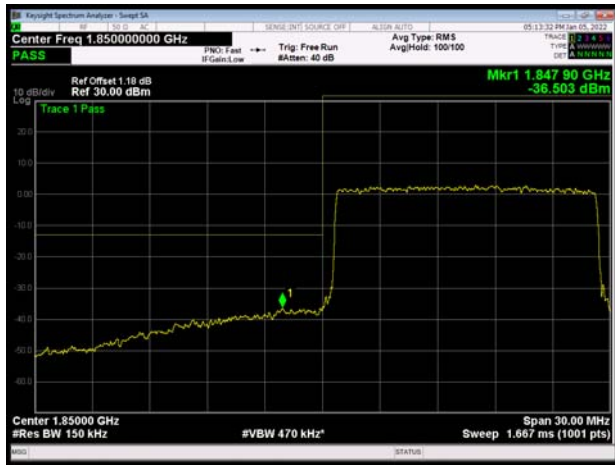

LTE Band 2 15MHz 64QAM 100%RB CH-High



LTE Band 2 20MHz 64QAM 1RB CH-Low

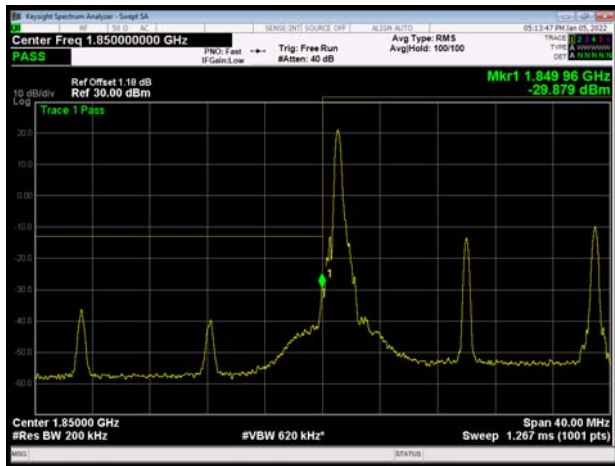

LTE Band 2 20MHz 64QAM 1RB CH-High

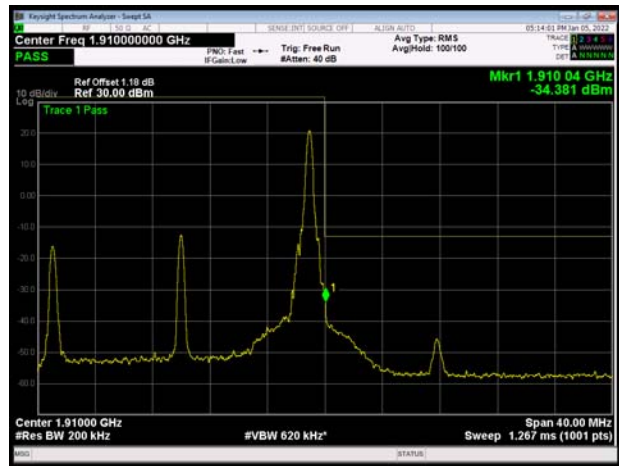

LTE Band 2 20MHz 64QAM 100%RB CH-Low

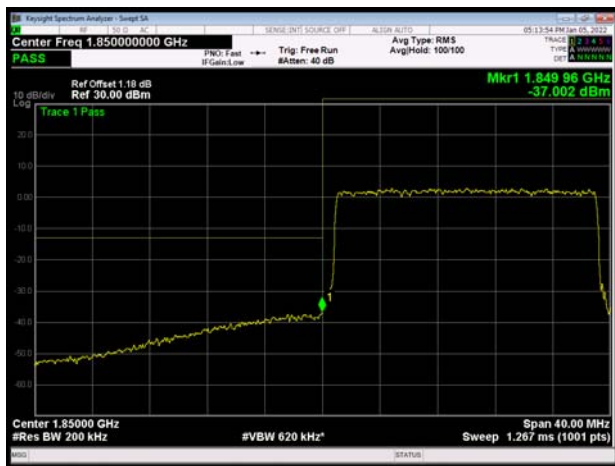

LTE Band 2 20MHz 64QAM 100%RB CH-High

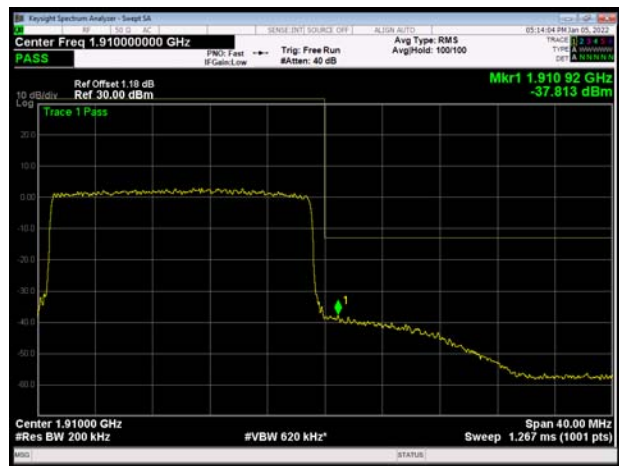

5.4. Peak-to-Average Power Ratio (PAPR)

Ambient condition

Temperature	Relative humidity	Pressure
23°C ~25°C	45%~50%	101.5kPa

Methods of Measurement

Measure the total peak power and record as PPk. And measure the total average power and record as PAvg. Both the peak and average power levels must be expressed in the same logarithmic units (e.g., dBm). Determine the PAPR from:

$$PAPR (dB) = PPk (dBm) - PAvg (dBm).$$

Test Setup

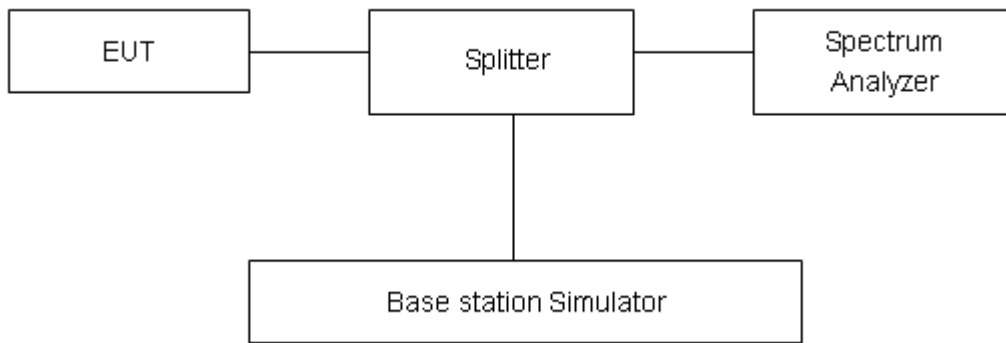

Limits

In measuring transmissions in this band using an average power technique, the peak-to-average ratio (PAR) of the transmission may not exceed 13 dB in 24.232(d).

Measurement Uncertainty

The assessed measurement uncertainty to ensure 95% confidence level for the normal distribution is with the coverage factor $k = 2$, $U = 0.4$ dB.



Test Results

Mode	Channel	Frequency (MHz)	Peak(dBm)	Avg(dBm)	PAPR(dB)	Limit(dB)	Conclusion
GSM 1900 (GMSK)	512	1850.2	28.55	25.89	2.66	≤13	PASS
	661	1880	28.29	25.63	2.66	≤13	PASS
	810	1909.8	28.22	25.53	2.69	≤13	PASS
GPRS 1900 (GMSK)	512	1850.2	28.58	25.92	2.66	≤13	PASS
	661	1880	28.34	25.68	2.66	≤13	PASS
	810	1909.8	28.30	25.64	2.66	≤13	PASS
EGPRS 1900 (8PSK)	512	1850.2	28.29	22.51	5.78	≤13	PASS
	661	1880	28.00	22.22	5.78	≤13	PASS
	810	1909.8	27.83	22.03	5.80	≤13	PASS
WCDMA Band II (RMC)	9262	1852.4	25.68	22.74	2.94	≤13	PASS
	9400	1880	25.46	22.48	2.98	≤13	PASS
	9538	1907.6	25.43	22.30	3.13	≤13	PASS

LTE Band 2									
Modulation	Bandwidth (MHz)	Channel	Frequency (MHz)	Peak (dBm)	Avg (dBm)	PAPR (dB)	Limit (dB)	Conclusion	
QPSK	1.4	18607	1850.7	27.28	22.59	4.69	≤13	PASS	
		18900	1880.0	27.41	22.44	4.97	≤13	PASS	
		19193	1909.3	27.70	22.56	5.14	≤13	PASS	
	3	18615	1851.5	27.36	22.54	4.82	≤13	PASS	
		18900	1880	27.46	22.48	4.98	≤13	PASS	
		19185	1908.5	27.76	22.58	5.18	≤13	PASS	
	5	18625	1852.5	27.43	22.50	4.93	≤13	PASS	
		18900	1880	27.50	22.52	4.98	≤13	PASS	
		19175	1907.5	27.67	22.57	5.10	≤13	PASS	
	10	18650	1855	27.60	22.55	5.05	≤13	PASS	
		18900	1880	27.50	22.52	4.98	≤13	PASS	
		19150	1905	27.53	22.48	5.05	≤13	PASS	
	15	18675	1857.5	28.02	22.46	5.56	≤13	PASS	
		18900	1880	27.84	22.48	5.36	≤13	PASS	
		19125	1902.5	27.93	22.49	5.44	≤13	PASS	
	20	18700	1860	27.94	22.52	5.42	≤13	PASS	
		18900	1880	27.72	22.52	5.20	≤13	PASS	
		19100	1900	27.72	22.37	5.35	≤13	PASS	
	16QAM	1.4	18607	1850.7	27.15	21.62	5.53	≤13	PASS
			18900	1880.0	27.15	21.40	5.75	≤13	PASS



	3	19193	1909.3	27.67	21.54	6.13	≤13	PASS	
		18615	1851.5	27.20	21.48	5.72	≤13	PASS	
		18900	1880	27.36	21.49	5.87	≤13	PASS	
	5	19185	1908.5	27.66	21.61	6.05	≤13	PASS	
		18625	1852.5	27.16	21.38	5.78	≤13	PASS	
		18900	1880	27.45	21.73	5.72	≤13	PASS	
	10	19175	1907.5	27.52	21.55	5.97	≤13	PASS	
		18650	1855	27.47	21.57	5.90	≤13	PASS	
		18900	1880	27.36	21.53	5.83	≤13	PASS	
	15	19150	1905	27.46	21.56	5.90	≤13	PASS	
		18675	1857.5	27.73	21.55	6.18	≤13	PASS	
		18900	1880	27.59	21.63	5.96	≤13	PASS	
	20	19125	1902.5	27.57	21.53	6.04	≤13	PASS	
		18700	1860	27.80	21.58	6.22	≤13	PASS	
		18900	1880	27.55	21.52	6.03	≤13	PASS	
	64QAM	1.4	19100	1900	27.68	21.55	6.13	≤13	PASS
			18607	1850.7	26.44	20.70	5.74	≤13	PASS
			18900	1880.0	26.70	20.88	5.82	≤13	PASS
		3	19193	1909.3	27.07	20.97	6.10	≤13	PASS
			18615	1851.5	26.61	20.77	5.84	≤13	PASS
			18900	1880	26.57	20.75	5.82	≤13	PASS
		5	19185	1908.5	26.88	20.79	6.09	≤13	PASS
			18625	1852.5	26.62	20.96	5.66	≤13	PASS
			18900	1880	26.67	20.87	5.80	≤13	PASS
10		19175	1907.5	26.90	20.97	5.93	≤13	PASS	
		18650	1855	26.82	20.86	5.96	≤13	PASS	
		18900	1880	26.59	20.60	5.99	≤13	PASS	
15		19150	1905	26.80	20.85	5.95	≤13	PASS	
		18675	1857.5	26.99	20.80	6.19	≤13	PASS	
		18900	1880	26.79	20.77	6.02	≤13	PASS	
20		19125	1902.5	26.87	20.78	6.09	≤13	PASS	
		18700	1860	27.04	20.76	6.28	≤13	PASS	
		18900	1880	26.72	20.68	6.04	≤13	PASS	
			19100	1900	26.89	20.70	6.19	≤13	PASS

5.5.Frequency Stability

Ambient condition

Temperature	Relative humidity	Pressure
23°C ~25°C	45%~50%	101.5kPa

Method of Measurement

Frequency Stability (Temperature Variation)

The temperature inside the climate chamber is varied from -30°C to +50°C in 10°C step size,

(1) With all power removed, the temperature was decreased to 0°C and permitted to stabilize for three hours.

(2) Measure the carrier frequency with the test equipment in a “call mode”. These measurements should be made within 1 minute of powering up the mobile station, to prevent significant self warming.

(3) Repeat the above measurements at 10°C increments from -30°C to +50°C. Allow at least 1.5 hours at each temperature, un-powered, before making measurements.

Frequency Stability (Voltage Variation)

The frequency stability shall be measured with variation of primary supply voltage as follows:

Primary Supply Voltage: The primary supply voltage is varied from 85% to 115% of the nominal value for non hand-carried battery and AC powered equipment. For hand-carried, battery-powered equipment, primary supply voltage is reduced to the battery operating end point which shall be specified by the manufacturer.

This transceiver is specified to operate with an input voltage of between 3.6 V and 4.2 V, with a nominal voltage of 3.87V.

Test setup

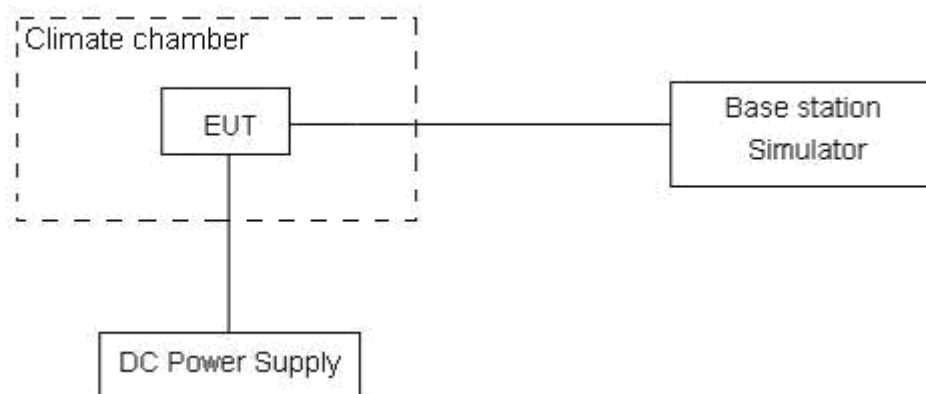

**Limits**

The frequency stability shall be sufficient to ensure that the fundamental emission stays within the authorized frequency block

Measurement Uncertainty

The assessed measurement uncertainty to ensure 99.75% confidence level for the normal distribution is with the coverage factor $k = 3$, $U = 0.01\text{ppm}$.

Test Result

GSM1900						
Condition		Freq.Error (Hz)	Freq.Error (Hz)	Frequency Stability (ppm)	Frequency Stability (ppm)	Verdict
Temperature	Voltage	GMSK	8PSK	GMSK	8PSK	
Normal (25°C)	Normal	13.02	13.67	0.00692	0.00727	PASS
Extreme (50°C)		9.83	2.20	0.00523	0.00117	PASS
Extreme (40°C)		2.30	2.99	0.00122	0.00159	PASS
Extreme (30°C)		17.34	7.44	0.00922	0.00396	PASS
Extreme (20°C)		6.76	17.81	0.00360	0.00947	PASS
Extreme (10°C)		17.49	17.83	0.00930	0.00949	PASS
Extreme (0°C)		5.20	10.31	0.00277	0.00549	PASS
Extreme (-10°C)		4.86	13.51	0.00259	0.00719	PASS
Extreme (-20°C)		4.98	3.05	0.00265	0.00162	PASS
Extreme (-30°C)		17.13	1.57	0.00911	0.00083	PASS
25°C	LV	15.97	15.14	0.00849	0.00805	PASS
	HV	6.81	1.09	0.00362	0.00058	PASS

WCDMA Band II						
Condition		Freq.Error (Hz)	Freq.Error (Hz)	Frequency Stability (ppm)	Frequency Stability (ppm)	Verdict
Temperature	Voltage	BPSK	QPSK	BPSK	QPSK	
Normal (25°C)	Normal	14.70	8.71	0.00782	0.00463	PASS
Extreme (50°C)		5.44	13.13	0.00289	0.00698	PASS
Extreme (40°C)		13.36	9.25	0.00711	0.00492	PASS
Extreme (30°C)		5.93	6.45	0.00315	0.00343	PASS
Extreme (20°C)		14.05	11.41	0.00748	0.00607	PASS
Extreme (10°C)		12.19	12.93	0.00648	0.00688	PASS
Extreme (0°C)		12.51	15.84	0.00665	0.00842	PASS
Extreme (-10°C)		3.35	2.04	0.00178	0.00109	PASS
Extreme (-20°C)		6.06	13.43	0.00323	0.00715	PASS
Extreme (-30°C)		3.18	7.81	0.00169	0.00415	PASS
25°C	LV	9.85	7.66	0.00524	0.00407	PASS
	HV	7.15	10.10	0.00381	0.00537	PASS



LTE Band 2								
Condition		Freq.Error (Hz)	Freq.Error (Hz)	Freq.Error (Hz)	Frequency Stability (ppm)	Frequency Stability (ppm)	Frequency Stability (ppm)	Verdict
BANDWIDTH	1.4MHz							
Temperature	Voltage	64QAM	16QAM	QPSK	64QAM	16QAM	QPSK	
Normal (25°C)	Normal	6.15	15.56	10.55	0.00327	0.00828	0.00561	PASS
Extreme (50°C)		15.39	16.12	12.62	0.00819	0.00857	0.00671	PASS
Extreme (40°C)		6.35	13.20	5.50	0.00338	0.00702	0.00293	PASS
Extreme (30°C)		8.34	12.99	16.55	0.00444	0.00691	0.00880	PASS
Extreme (20°C)		15.37	11.13	3.47	0.00818	0.00592	0.00184	PASS
Extreme (10°C)		16.10	10.19	8.49	0.00856	0.00542	0.00451	PASS
Extreme (0°C)		2.54	4.85	6.48	0.00135	0.00258	0.00345	PASS
Extreme (-10°C)		9.68	5.24	2.27	0.00515	0.00279	0.00121	PASS
Extreme (-20°C)		1.13	9.50	10.01	0.00060	0.00505	0.00532	PASS
Extreme (-30°C)		12.30	10.81	6.22	0.00654	0.00575	0.00331	PASS
25°C		LV	2.85	8.42	17.39	0.00152	0.00448	0.00925
	HV	7.31	14.51	13.27	0.00389	0.00772	0.00706	PASS
Condition		Freq.Error (Hz)	Freq.Error (Hz)	Freq.Error (Hz)	Frequency Stability (ppm)	Frequency Stability (ppm)	Frequency Stability (ppm)	Verdict
BANDWIDTH	3MHz							
Temperature	Voltage	64QAM	16QAM	QPSK	64QAM	16QAM	QPSK	
Normal (25°C)	Normal	11.90	11.28	11.56	0.00633	0.00600	0.00615	PASS
Extreme (50°C)		1.47	7.91	6.48	0.00078	0.00421	0.00345	PASS
Extreme (40°C)		10.30	14.60	2.70	0.00548	0.00777	0.00144	PASS
Extreme (30°C)		4.32	1.02	13.09	0.00230	0.00054	0.00696	PASS
Extreme (20°C)		11.62	6.71	5.61	0.00618	0.00357	0.00298	PASS
Extreme (10°C)		9.02	8.80	15.03	0.00480	0.00468	0.00800	PASS
Extreme (0°C)		12.95	9.09	7.96	0.00689	0.00484	0.00424	PASS
Extreme (-10°C)		9.11	10.58	4.06	0.00485	0.00563	0.00216	PASS
Extreme (-20°C)		10.60	7.40	16.33	0.00564	0.00393	0.00869	PASS
Extreme (-30°C)		9.77	17.20	2.02	0.00520	0.00915	0.00107	PASS
25°C		LV	6.56	2.39	14.32	0.00349	0.00127	0.00762
	HV	14.71	14.87	6.59	0.00783	0.00791	0.00351	PASS
Condition		Freq.Error (Hz)	Freq.Error (Hz)	Freq.Error (Hz)	Frequency Stability (ppm)	Frequency Stability (ppm)	Frequency Stability (ppm)	Verdict
BANDWIDTH	5MHz							
Temperature	Voltage	64QAM	16QAM	QPSK	64QAM	16QAM	QPSK	
Normal (25°C)	Normal	13.27	8.71	5.40	0.00706	0.00463	0.00287	PASS
Extreme (50°C)		11.23	2.48	3.40	0.00597	0.00132	0.00181	PASS



Extreme (40°C)		6.52	7.13	11.07	0.00347	0.00379	0.00589	PASS
Extreme (30°C)		17.23	11.23	10.29	0.00917	0.00597	0.00547	PASS
Extreme (20°C)		8.53	10.02	11.17	0.00454	0.00533	0.00594	PASS
Extreme (10°C)		17.23	7.54	16.77	0.00916	0.00401	0.00892	PASS
Extreme (0°C)		13.38	4.90	1.04	0.00711	0.00260	0.00055	PASS
Extreme (-10°C)		16.39	15.12	13.37	0.00872	0.00804	0.00711	PASS
Extreme (-20°C)		6.50	17.33	4.12	0.00346	0.00922	0.00219	PASS
Extreme (-30°C)		12.14	4.99	3.67	0.00646	0.00266	0.00195	PASS
25°C	LV	2.90	13.42	9.08	0.00154	0.00714	0.00483	PASS
	HV	17.74	12.27	17.01	0.00944	0.00653	0.00905	PASS
Condition		Freq.Error (Hz)	Freq.Error (Hz)	Freq.Error (Hz)	Frequency Stability (ppm)	Frequency Stability (ppm)	Frequency Stability (ppm)	Verdict
BANDWIDTH	10MHz							
Temperature	Voltage	64QAM	16QAM	QPSK	64QAM	16QAM	QPSK	
Normal (25°C)	Normal	3.83	6.92	2.51	0.00204	0.00368	0.00133	PASS
Extreme (50°C)		4.63	12.26	17.85	0.00246	0.00652	0.00949	PASS
Extreme (40°C)		14.57	6.80	9.08	0.00775	0.00362	0.00483	PASS
Extreme (30°C)		13.33	6.06	7.26	0.00709	0.00322	0.00386	PASS
Extreme (20°C)		1.51	7.61	15.89	0.00080	0.00405	0.00845	PASS
Extreme (10°C)		5.57	11.01	17.41	0.00296	0.00586	0.00926	PASS
Extreme (0°C)		1.95	5.29	3.50	0.00103	0.00281	0.00186	PASS
Extreme (-10°C)		3.55	11.40	13.06	0.00189	0.00607	0.00695	PASS
Extreme (-20°C)		17.10	4.02	14.14	0.00910	0.00214	0.00752	PASS
Extreme (-30°C)		13.35	13.41	8.34	0.00710	0.00714	0.00443	PASS
25°C	LV	5.10	7.99	14.58	0.00271	0.00425	0.00776	PASS
	HV	1.36	4.33	2.09	0.00073	0.00230	0.00111	PASS
Condition		Freq.Error (Hz)	Freq.Error (Hz)	Freq.Error (Hz)	Frequency Stability (ppm)	Frequency Stability (ppm)	Frequency Stability (ppm)	Verdict
BANDWIDTH	15MHz							
Temperature	Voltage	64QAM	16QAM	QPSK	64QAM	16QAM	QPSK	
Normal (25°C)	Normal	6.08	9.43	7.42	0.00323	0.00502	0.00395	PASS
Extreme (50°C)		4.06	7.18	6.46	0.00216	0.00382	0.00344	PASS
Extreme (40°C)		3.88	9.03	2.69	0.00206	0.00481	0.00143	PASS
Extreme (30°C)		15.80	11.76	14.07	0.00840	0.00626	0.00748	PASS
Extreme (20°C)		8.35	3.30	6.91	0.00444	0.00176	0.00368	PASS
Extreme (10°C)		16.19	5.77	5.20	0.00861	0.00307	0.00276	PASS
Extreme (0°C)		8.48	12.58	1.39	0.00451	0.00669	0.00074	PASS
Extreme (-10°C)		15.68	13.81	2.87	0.00834	0.00734	0.00153	PASS
Extreme (-20°C)		11.37	8.44	1.20	0.00605	0.00449	0.00064	PASS
Extreme (-30°C)		3.46	13.61	2.05	0.00184	0.00724	0.00109	PASS
25°C	LV	11.09	17.68	10.57	0.00590	0.00940	0.00562	PASS



	HV	14.85	13.97	8.26	0.00790	0.00743	0.00439	PASS
Condition		Freq.Error (Hz)	Freq.Error (Hz)	Freq.Error (Hz)	Frequency Stability (ppm)	Frequency Stability (ppm)	Frequency Stability (ppm)	Verdict
BANDWIDTH	20MHz							
Temperature	Voltage	64QAM	16QAM	QPSK	64QAM	16QAM	QPSK	
Normal (25°C)	Normal	3.98	2.67	7.02	0.00212	0.00142	0.00373	PASS
Extreme (50°C)		7.93	7.23	16.07	0.00422	0.00385	0.00855	PASS
Extreme (40°C)		7.23	5.49	7.98	0.00385	0.00292	0.00425	PASS
Extreme (30°C)		4.67	11.88	6.57	0.00248	0.00632	0.00349	PASS
Extreme (20°C)		2.65	11.24	13.83	0.00141	0.00598	0.00736	PASS
Extreme (10°C)		12.64	16.46	7.83	0.00673	0.00875	0.00416	PASS
Extreme (0°C)		3.69	8.01	8.60	0.00197	0.00426	0.00458	PASS
Extreme (-10°C)		10.09	16.84	5.60	0.00537	0.00896	0.00298	PASS
Extreme (-20°C)		16.66	8.12	4.41	0.00886	0.00432	0.00235	PASS
Extreme (-30°C)		11.74	3.66	16.12	0.00624	0.00195	0.00857	PASS
25°C	LV	17.77	15.93	14.56	0.00945	0.00847	0.00775	PASS
	HV	13.25	12.73	17.58	0.00705	0.00677	0.00935	PASS

5.6. Spurious Emissions at Antenna Terminals

Ambient condition

Temperature	Relative humidity	Pressure
23°C ~25°C	45%~50%	101.5kPa

Method of Measurement

The EUT was connected to Spectrum Analyzer and Base Station Simulator via power Splitter. The measurement is carried out using a spectrum analyzer. The spectrum analyzer scans from 9kHz to the 10th harmonic of the carrier. The peak detector is used.

RBW is set to 100kHz, VBW is set to 300kHz for 30MHz~1GHz

RBW is set to 1MHz, VBW is set to 3MHz for above 1GHz, Sweep is set to ATUO.

RBW is set to 1 kHz (0.009MHz~ 0.15 MHz),

RBW is set to 10 kHz (0.15 MHz~ 30 MHz)

RBW is set to 100 kHz (30MHz~1000 MHz)

RBW is set to 1000 kHz (above 1000MHz)

The modulation mode and RB allocation refer to section 5.1, using the maximum output power configuration.

Test setup

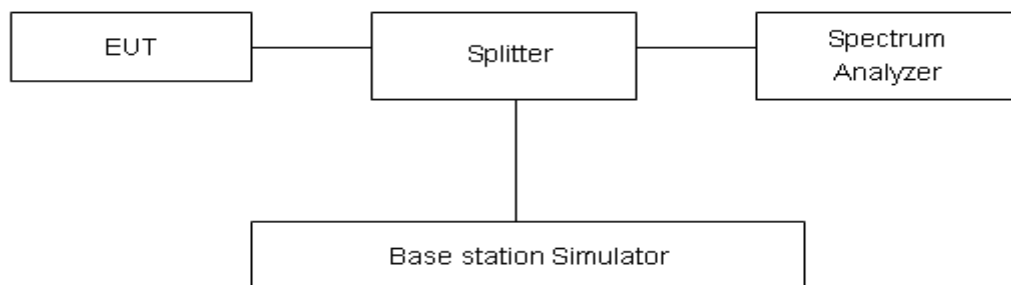

Limits

Rule Part 24.238(a) specifies that “on any frequency outside a licensee’s frequency block, the power of any emission shall be attenuated below the transmitter power (P) by at least 43 + 10 log₁₀ (P) dB.”

Limit	-13 dBm
-------	---------

Measurement Uncertainty

The assessed measurement uncertainty to ensure 99.75% confidence level for the normal distribution is with the coverage factor $k = 1.96$.

Frequency	Uncertainty
9kHz-1GHz	0.684 dB
1GHz-20GHz	1.407 dB



Test Result

Sweep the whole frequency band through the range from 9kHz to the 10th harmonic of the carrier, the emissions more than 20 dB below the limit are not reported.

The signal beyond the limit is carrier.

GSM 1900 CH-Low 9kHz ~ 20GHz

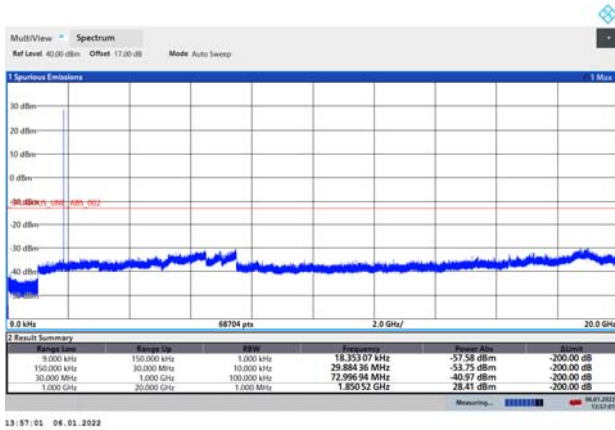

GPRS 1900 CH-Low 9kHz ~ 20GHz

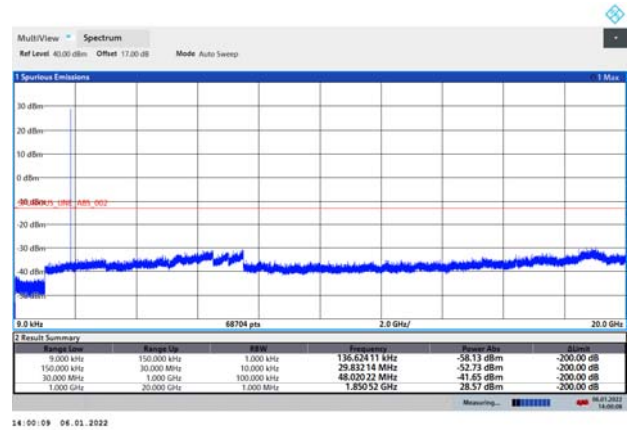

GSM 1900 CH- Middle 9kHz ~ 20GHz

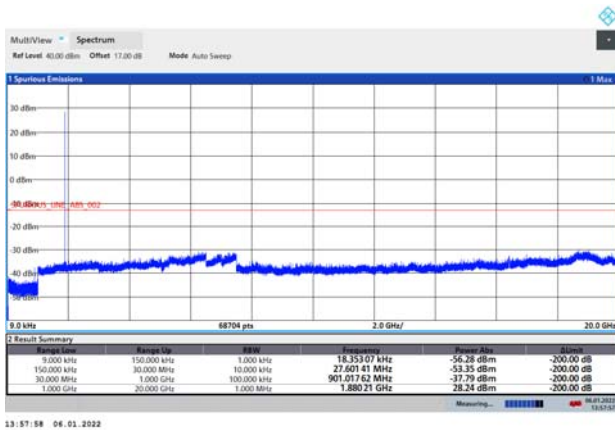

GPRS 1900 CH- Middle 9kHz ~ 20GHz

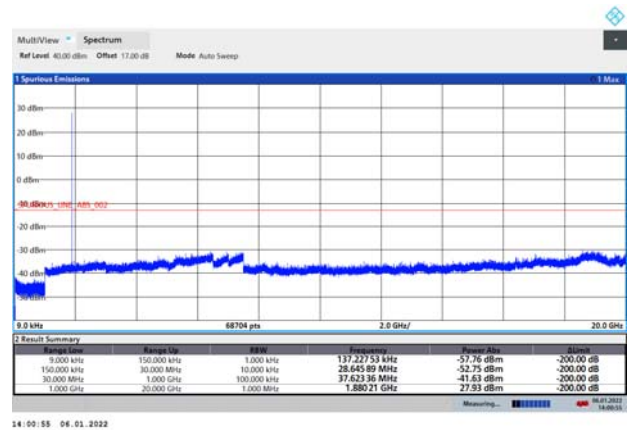

GSM 1900 CH-High 9kHz ~ 20GHz

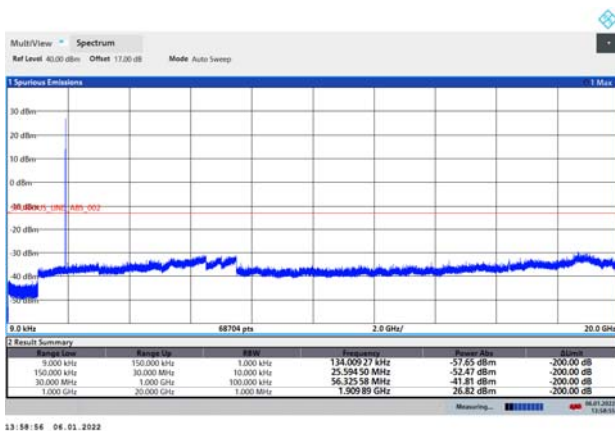

GPRS 1900 CH-High 9kHz ~ 20GHz

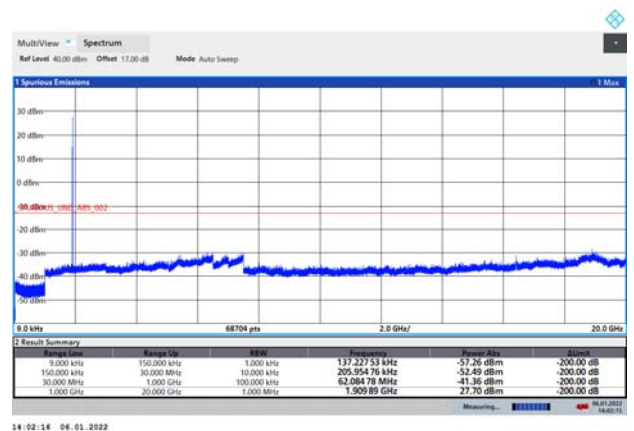



EGPRS 1900 CH-Low 9kHz ~ 20GHz

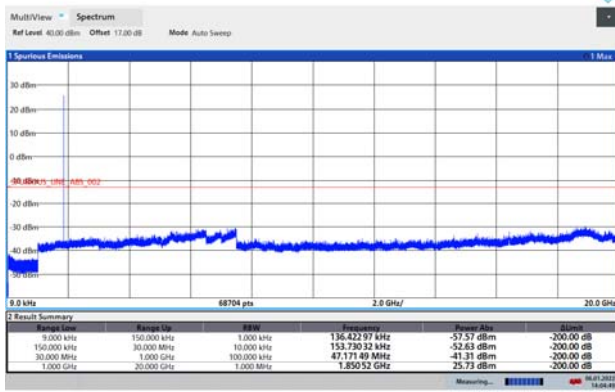

14:04:49 06.01.2022

WCDMA BAND II CH-Low 9kHz ~ 20GHz

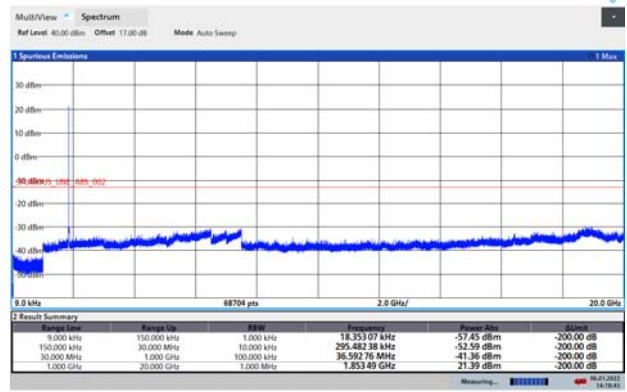

14:18:44 06.01.2022

EGPRS 1900 CH- Middle 9kHz ~ 20GHz

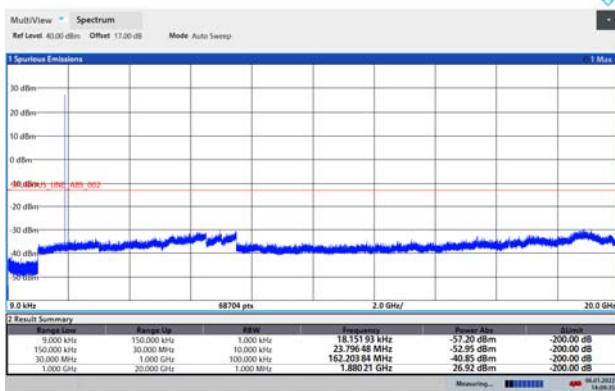

14:09:35 06.01.2022

WCDMA BAND II CH- Middle 9kHz ~ 20GHz

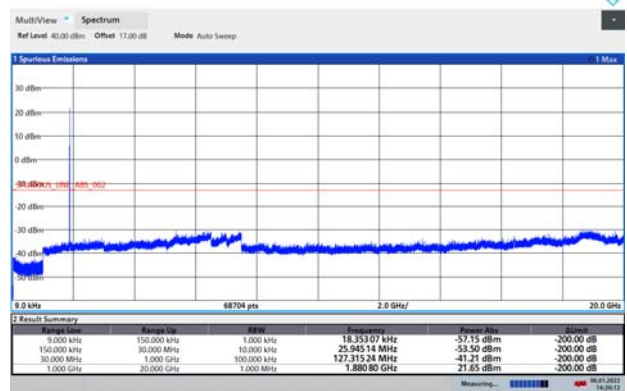

14:20:13 06.01.2022

EGPRS 1900 CH-High 9kHz ~ 20GHz

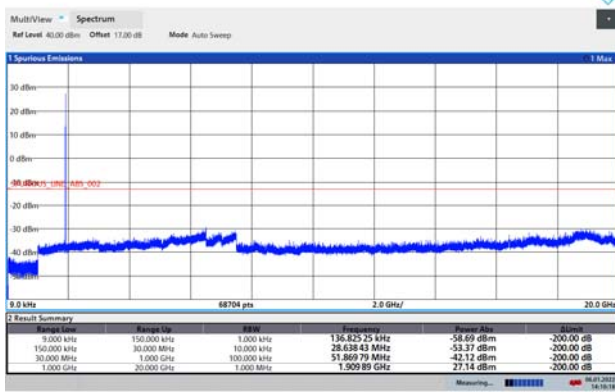

14:10:19 06.01.2022

WCDMA BAND II CH-High 9kHz ~ 20GHz

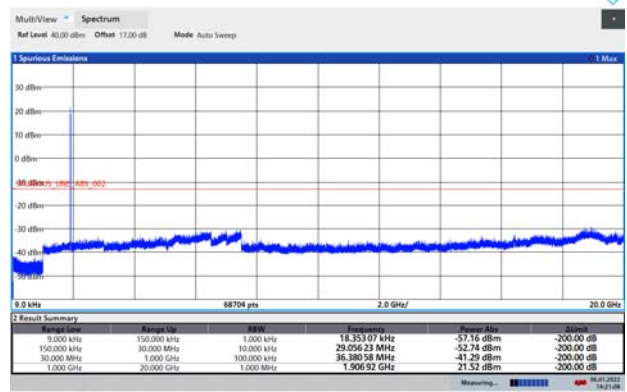

14:21:08 06.01.2022

LTE Band 2 1.4MHz CH-Low 9kHz~20GHz

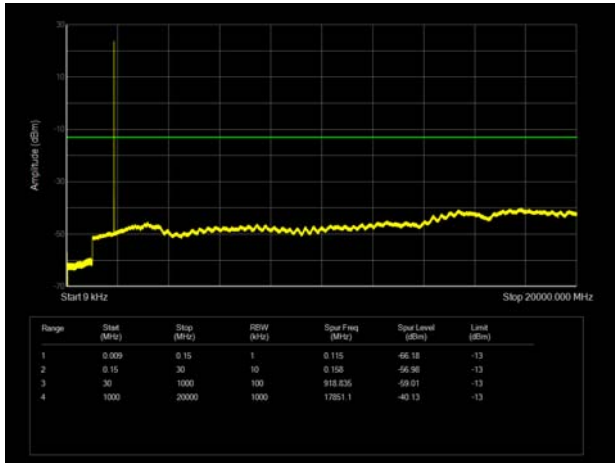

LTE Band 2 3MHz CH-Low 9kHz~20GHz

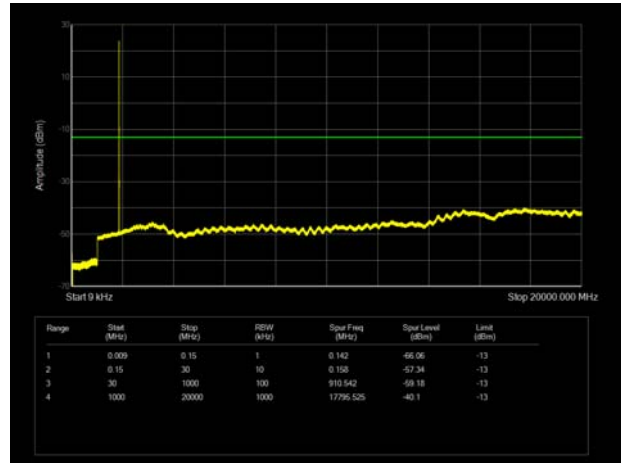

LTE Band 2 1.4MHz CH-Middle 9kHz~20GHz

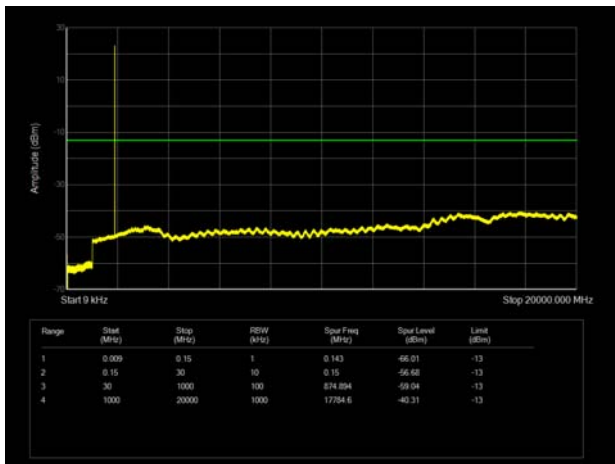

LTE Band 2 3MHz CH-Middle 9kHz~20GHz

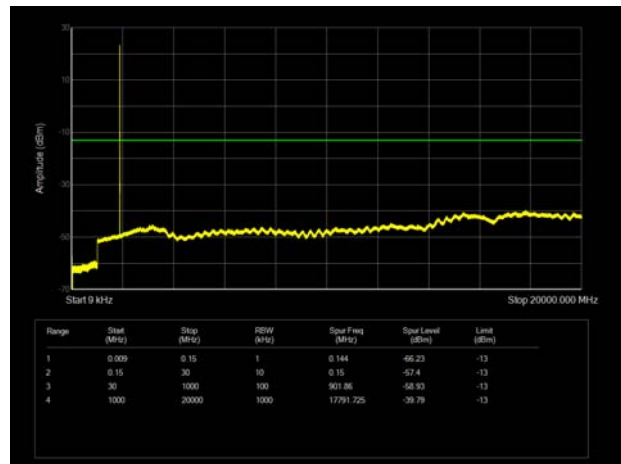

LTE Band 2 1.4MHz CH-High 9kHz~20GHz

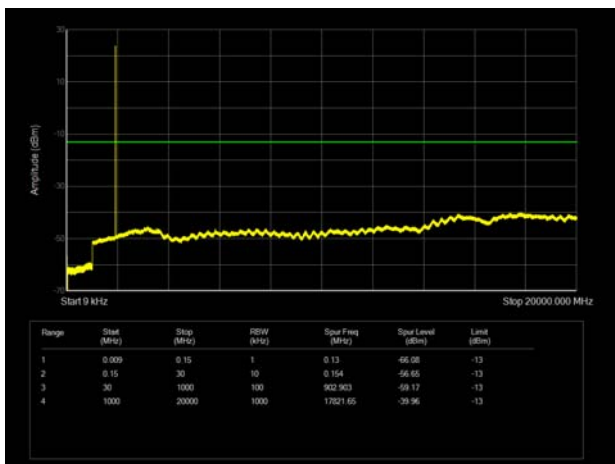

LTE Band 2 3MHz CH-High 9kHz~20GHz

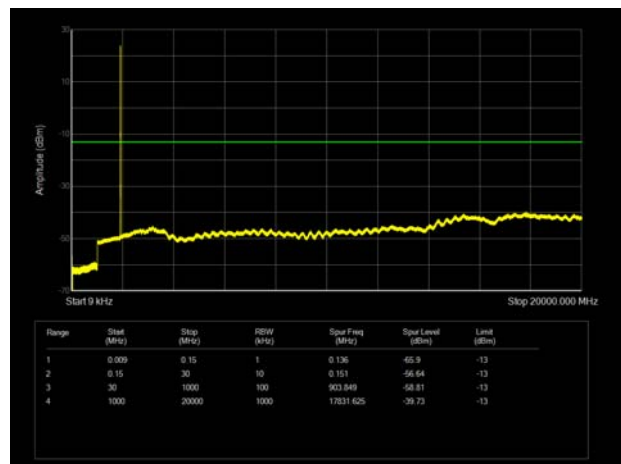

LTE Band 2 5MHz CH-Low 9kHz~20GHz

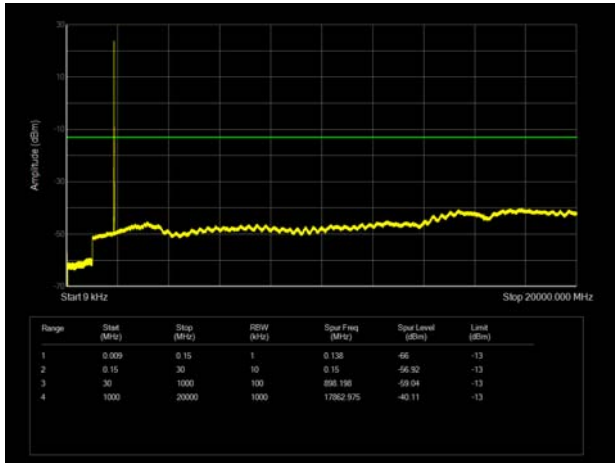

LTE Band 2 10MHz CH-Low 9kHz~20GHz

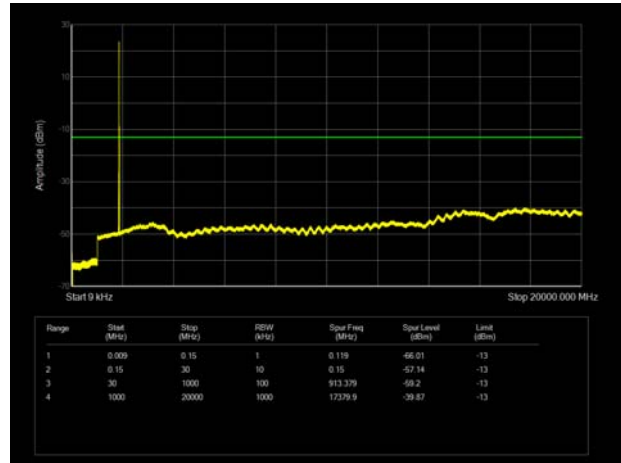

LTE Band 2 5MHz CH-Middle 9kHz~20GHz

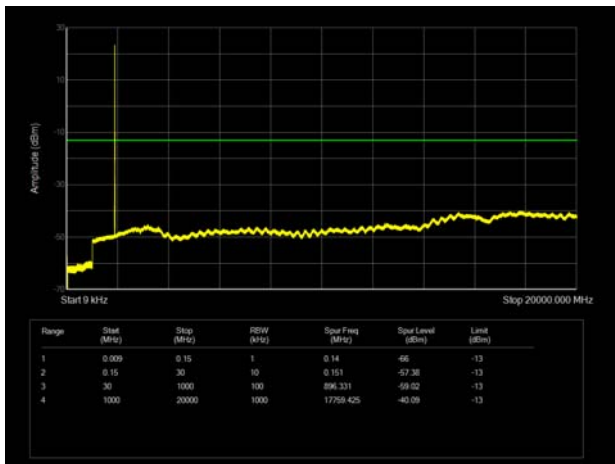

LTE Band 2 10MHz CH-Middle 9kHz~20GHz

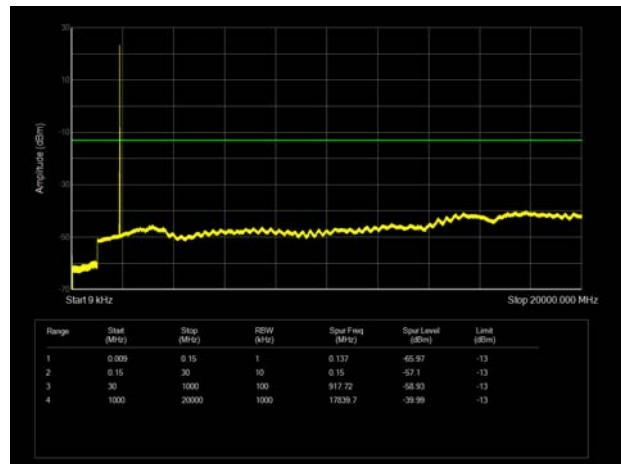

LTE Band 2 5MHz CH-High 9kHz~20GHz

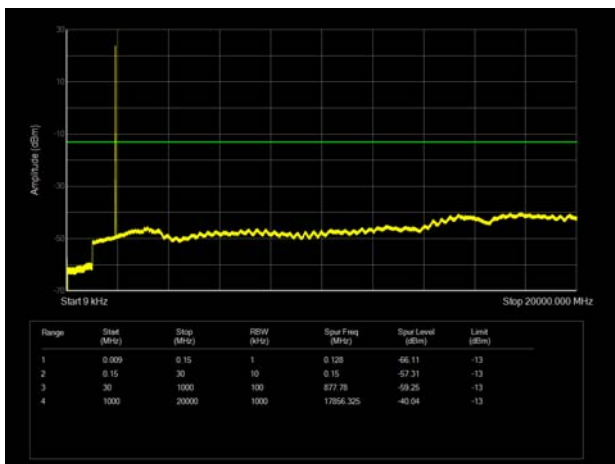

LTE Band 2 10MHz CH-High 9kHz~20GHz

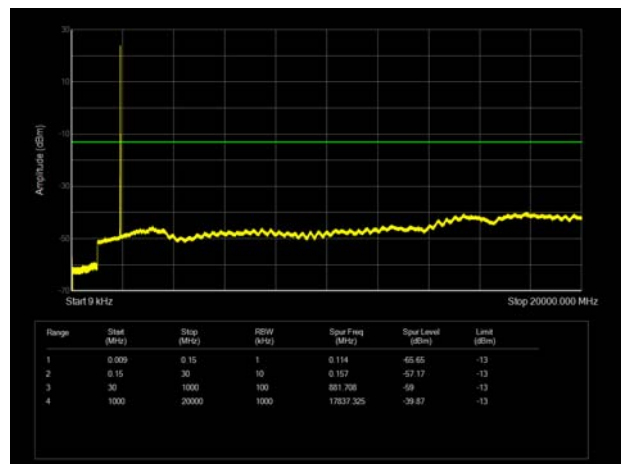



LTE Band 2 15MHz CH-Low 9kHz~20GHz

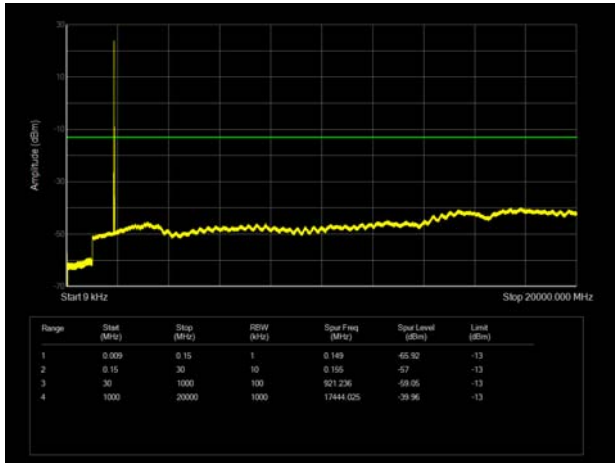

LTE Band 2 20MHz CH-Low 9kHz~20GHz

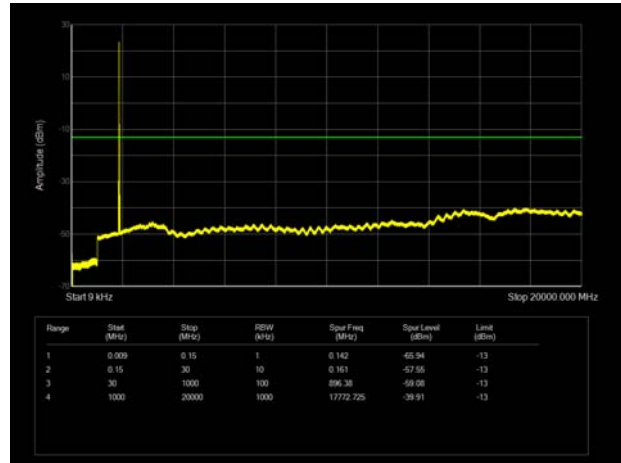

LTE Band 2 15MHz CH-Middle 9kHz~20GHz

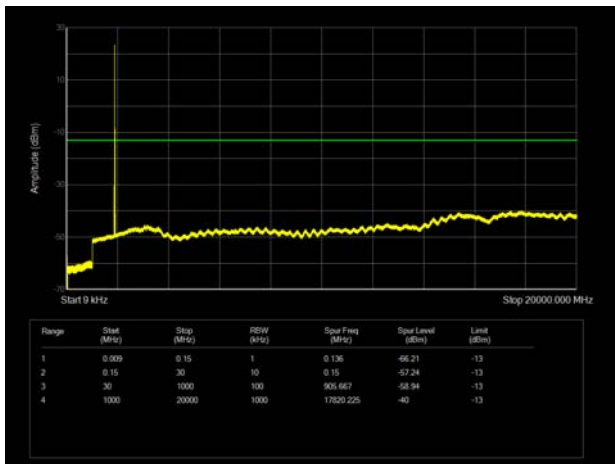

LTE Band 2 20MHz CH-Middle 9kHz~20GHz

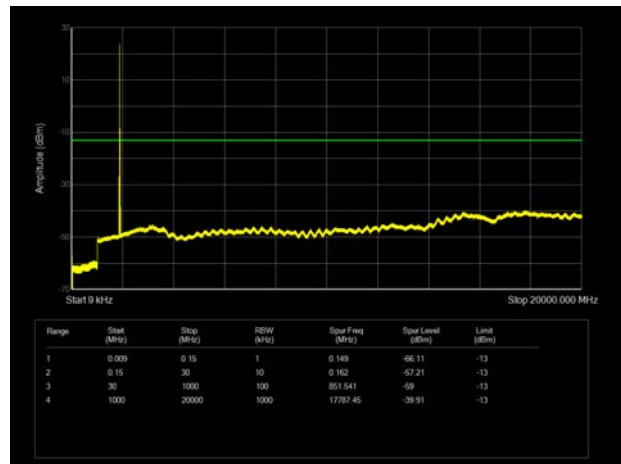

LTE Band 2 15MHz CH-High 9kHz~20GHz

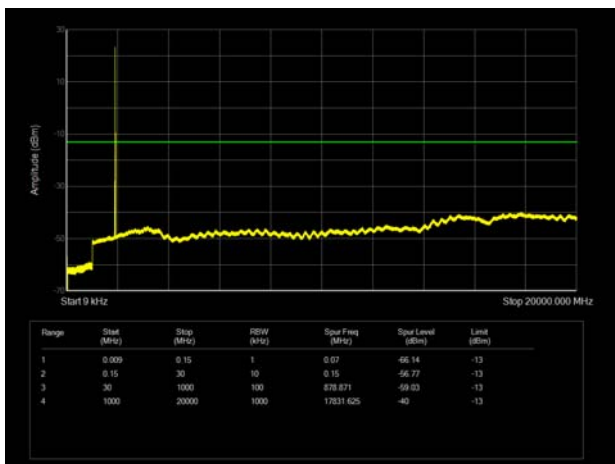

LTE Band 2 20MHz CH-High 9kHz~20GHz

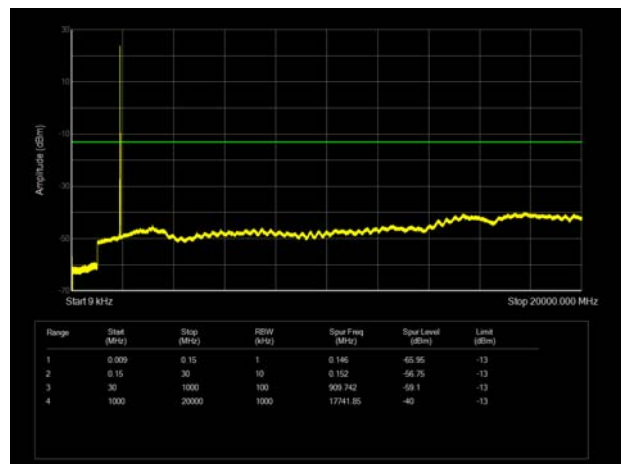

5.7. Radiates Spurious Emission

Ambient condition

Temperature	Relative humidity	Pressure
23°C ~25°C	45%~50%	101.5kPa

Method of Measurement

1. The testing follows FCC KDB 971168 v03r01 Section 5.8 and ANSI C63.26 (2015).
2. Below 1GHz: The EUT is placed on a turntable 0.8 meters above the ground in the chamber, 3 meter away from the antenna. The maximal emission value is acquired by adjusting the antenna height, polarisation and turntable azimuth. Normally, the height range of antenna is 1 m to 4 m, the azimuth range of turntable is 0° to 360°, and the receive antenna has two polarizations Vertical (V) and Horizontal (H). Above 1GHz: (Note: the FCC's permission to use 1.5m as an alternative per TCBC Conf call of Dec. 2, 2014.) The EUT is placed on a turntable 1.5 meters above the ground in the chamber, 3 meter away from the antenna. The maximal emission value is acquired by adjusting the antenna height, polarisation and turntable azimuth. Normally, the height range of antenna is 1 m to 4 m, the azimuth range of turntable is 0° to 360°, and the receive antenna has two polarizations Vertical (V) and Horizontal (H).
3. A loop antenna, A log-periodic antenna or horn antenna shall be substituted in place of the EUT. The log-periodic antenna will be driven by a signal generator and the level will be adjusted till the same power value on the spectrum analyzer or receiver. The level of the spurious emissions can be calculated through the level of the signal generator, cable loss, the gain of the substitution antenna and the reading of the spectrum analyzer or receiver.
4. The EUT is then put into continuously transmitting mode at its maximum power level during the test. Set Test Receiver or Spectrum RBW=1MHz, VBW=3MHz, and the maximum value of the receiver should be recorded as (Pr).
5. The EUT shall be replaced by a substitution antenna. In the chamber, an substitution antenna for the frequency band of interest is placed at the reference point of the chamber. An RF Signal source for the frequency band of interest is connected to the substitution antenna with a cable that has been constructed to not interfere with the radiation pattern of the antenna. A power (PMea) is applied to the input of the substitution antenna, and adjust the level of the signal generator output until the value of the receiver reach the previously recorded (Pr). The power of signal source (PMea) is recorded. The test should be performed by rotating the test item and adjusting the receiving antenna polarization.
6. A amplifier should be connected to the Signal Source output port. And the cable should be connect between the Amplifier and the Substitution Antenna. The cable loss (Pcl) ,the Substitution Antenna Gain (Ga) and the Amplifier Gain (PAg) should be recorded after test.
7. The measurement results are obtained as described below:
Power(EIRP)=PMea- PAg - Pcl + Ga
The measurement results are amend as described below:
Power(EIRP)=PMea- Pcl + Ga
8. This value is EIRP since the measurement is calibrated using an antenna of known gain (2.15 dB) and known input power. ERP can be calculated from EIRP by subtracting the gain of the dipole, ERP

= EIRP-2.15dB.

The modulation mode and RB allocation refer to section 5.1, using the maximum output power configuration.

Test setup

9KHz ~ 30MHz

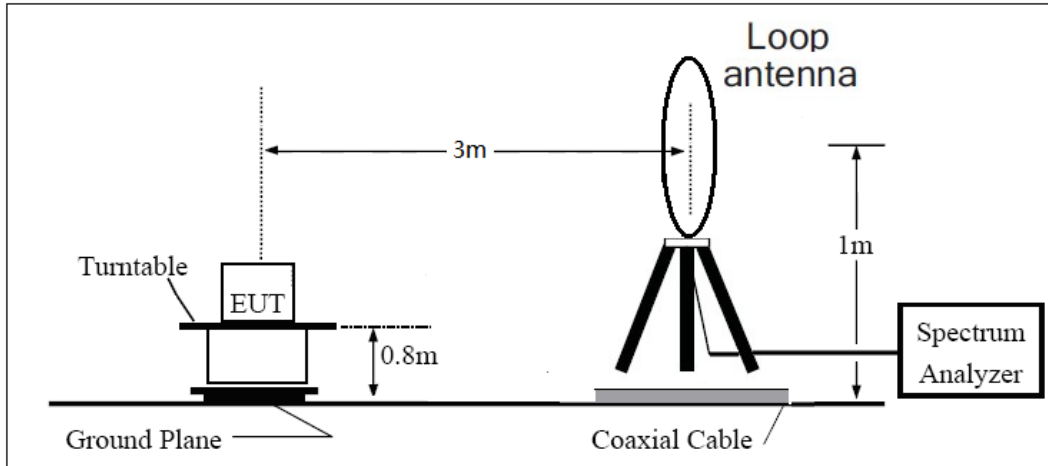

30MHz ~ 1GHz

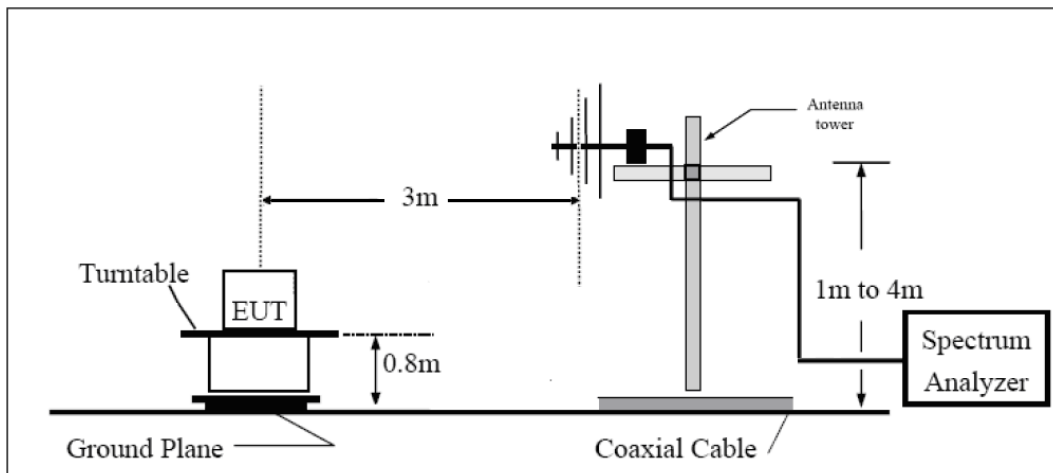

Above 1GHz

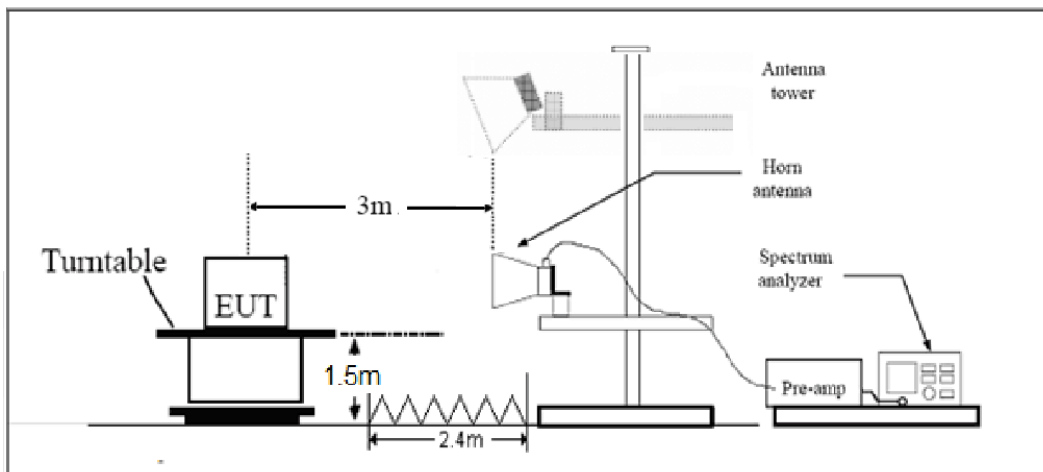

Note: Area side: 2.4mX3.6m

**Limits**

Rule Part 24.238(a) specifies that “on any frequency outside a licensee's frequency block, the power of any emission shall be attenuated below the transmitter power (P) by at least $43 + 10 \log_{10} (P)$ dB.”

Limit	-13 dBm
-------	---------

Measurement Uncertainty

The assessed measurement uncertainty to ensure 95% confidence level for the normal distribution is with the coverage factor $k = 1.96$, $U = 3.55$ dB.

Test Result

Sweep the whole frequency band through the range from 9kHz to the 10th harmonic of the carrier, the emissions below the noise floor will not be recorded in the report.

Low Antenna

GSM 1900 CH-Middle

Harmonic	Frequency (MHz)	SG (dBm)	Cable Loss (dB)	Gain (dBi)	Antenna Polarization	EIRP Level (dBm)	Limit (dBm)	Margin (dB)	Azimuth (deg)
2	3760.00	-59.73	2.60	12.50	Horizontal	-49.83	-13.00	36.83	45
3	5640.00	-55.36	3.30	12.50	Horizontal	-46.16	-13.00	33.16	315
4	7520.00	-56.27	4.20	12.20	Horizontal	-48.27	-13.00	35.27	225
5	9400.00	-53.05	4.30	11.10	Horizontal	-46.25	-13.00	33.25	270
6	11280.00	-50.50	5.90	11.90	Horizontal	-44.50	-13.00	31.50	180
7	13160.00	-51.57	5.70	14.00	Horizontal	-43.27	-13.00	30.27	225
8	15040.00	-47.00	5.80	13.10	Horizontal	-39.70	-13.00	26.70	0
9	16920.00	-49.01	6.10	14.60	Horizontal	-40.51	-13.00	27.51	90
10	18800.00	--	--	--	--	--	--	--	--

Note: 1.The other Spurious RF Radiated emissions level is no more than noise floor.
 2. The worst emission was found in the antenna is Horizontal position.

WCDMA Band II CH-Middle

Harmonic	Frequency (MHz)	SG (dBm)	Cable Loss (dB)	Gain (dBi)	Antenna Polarization	EIRP Level (dBm)	Limit (dBm)	Margin (dB)	Azimuth (deg)
2	3702.00	-61.13	2.60	12.50	Horizontal	-51.23	-13.00	38.23	180
3	5556.00	-50.92	3.30	12.50	Horizontal	-41.72	-13.00	28.72	135
4	7408.00	-57.80	4.20	12.20	Horizontal	-49.80	-13.00	36.80	180
5	9260.00	-53.57	4.30	11.10	Horizontal	-46.77	-13.00	33.77	315
6	11112.00	-55.04	5.90	11.90	Horizontal	-49.04	-13.00	36.04	180
7	12964.00	-52.59	5.70	14.00	Horizontal	-44.29	-13.00	31.29	180
8	14816.00	-47.46	5.80	13.10	Horizontal	-40.16	-13.00	27.16	90
9	16668.00	-51.08	6.10	14.60	Horizontal	-42.58	-13.00	29.58	0
10	18520.00	--	--	--	--	--	--	--	--

Note: 1.The other Spurious RF Radiated emissions level is no more than noise floor.
 2. The worst emission was found in the antenna is Horizontal position.

LTE Band 2 1.4MHz CH-Middle

Harmonic	Frequency (MHz)	SG (dBm)	Cable Loss (dB)	Gain (dBi)	Antenna Polarization	EIRP Level (dBm)	Limit (dBm)	Margin (dB)	Azimuth (deg)
2	3759.00	-65.86	2.60	12.50	Horizontal	-55.96	-13.00	42.96	225
3	5638.88	-61.54	3.30	12.50	Horizontal	-52.34	-13.00	39.34	180
4	7520.00	-56.46	4.20	12.20	Horizontal	-48.46	-13.00	35.46	45
5	9400.00	-54.31	4.30	11.10	Horizontal	-47.51	-13.00	34.51	135
6	11280.00	-53.05	5.90	11.90	Horizontal	-47.05	-13.00	34.05	315
7	13160.00	-53.73	5.70	14.00	Horizontal	-45.43	-13.00	32.43	90
8	15040.00	-48.68	5.80	13.10	Horizontal	-41.38	-13.00	28.38	180
9	16920.00	-51.85	6.10	14.60	Horizontal	-43.35	-13.00	30.35	315
10	18800.00	--	--	--	--	--	--	--	--

Note: 1.The other Spurious RF Radiated emissions level is no more than noise floor.
2. The worst emission was found in the antenna is Horizontal position.

LTE Band 2 5MHz CH-Middle

Harmonic	Frequency (MHz)	SG (dBm)	Cable Loss (dB)	Gain (dBi)	Antenna Polarization	EIRP Level (dBm)	Limit (dBm)	Margin (dB)	Azimuth (deg)
2	3755.00	-66.03	2.60	12.50	Horizontal	-56.13	-13.00	43.13	45
3	5632.50	-62.05	3.30	12.50	Horizontal	-52.85	-13.00	39.85	135
4	7510.00	-56.61	4.20	12.20	Horizontal	-48.61	-13.00	35.61	225
5	9387.50	-54.26	4.30	11.10	Horizontal	-47.46	-13.00	34.46	90
6	11265.00	-52.95	5.90	11.90	Horizontal	-46.95	-13.00	33.95	180
7	13142.50	-53.23	5.70	14.00	Horizontal	-44.93	-13.00	31.93	315
8	15020.00	-48.06	5.80	13.10	Horizontal	-40.76	-13.00	27.76	0
9	16897.50	-52.15	6.10	14.60	Horizontal	-43.65	-13.00	30.65	225
10	18800.00	--	--	--	--	--	--	--	--

Note: 1.The other Spurious RF Radiated emissions level is no more than noise floor.
2. The worst emission was found in the antenna is Horizontal position.



LTE Band 2 20MHz CH-Middle

Harmonic	Frequency (MHz)	SG (dBm)	Cable Loss (dB)	Gain (dBi)	Antenna Polarization	EIRP Level (dBm)	Limit (dBm)	Margin (dB)	Azimuth (deg)
2	3740.00	-63.17	2.60	12.50	Horizontal	-53.27	-13.00	40.27	315
3	5610.00	-60.45	3.30	12.50	Horizontal	-51.25	-13.00	38.25	135
4	7480.00	-57.33	4.20	12.20	Horizontal	-49.33	-13.00	36.33	0
5	9350.00	-53.80	4.30	11.10	Horizontal	-47.00	-13.00	34.00	45
6	11220.00	-51.35	5.90	11.90	Horizontal	-45.35	-13.00	32.35	135
7	13090.00	-54.60	5.70	14.00	Horizontal	-46.30	-13.00	33.30	225
8	14960.00	-47.45	5.80	13.10	Horizontal	-40.15	-13.00	27.15	90
9	16830.00	-50.19	6.10	14.60	Horizontal	-41.69	-13.00	28.69	270
10	18800.00	--	--	--	--	--	--	--	--

Note: 1. The other Spurious RF Radiated emissions level is no more than noise floor.

2. The worst emission was found in the antenna is Horizontal position.

**Upper Antenna**

GSM 1900 CH-Middle

Harmonic	Frequency (MHz)	SG (dBm)	Cable Loss (dB)	Gain (dBi)	Antenna Polarization	EIRP Level (dBm)	Limit (dBm)	Margin (dB)	Azimuth (deg)
2	3760.00	-62.79	2.60	12.50	Horizontal	-52.89	-13.00	39.89	45
3	5640.00	-51.68	3.30	12.50	Horizontal	-42.48	-13.00	29.48	315
4	7520.00	-56.38	4.20	12.20	Horizontal	-48.38	-13.00	35.38	225
5	9400.00	-52.10	4.30	11.10	Horizontal	-45.30	-13.00	32.30	270
6	11280.00	-49.52	5.90	11.90	Horizontal	-43.52	-13.00	30.52	180
7	13160.00	-52.13	5.70	14.00	Horizontal	-43.83	-13.00	30.83	225
8	15040.00	-46.68	5.80	13.10	Horizontal	-39.38	-13.00	26.38	0
9	16920.00	-47.80	6.10	14.60	Horizontal	-39.30	-13.00	26.30	90
10	18800.00	--	--	--	--	--	--	--	--

Note: 1. The other Spurious RF Radiated emissions level is no more than noise floor.
2. The worst emission was found in the antenna is Horizontal position.

WCDMA Band II CH-Middle

Harmonic	Frequency (MHz)	SG (dBm)	Cable Loss (dB)	Gain (dBi)	Antenna Polarization	EIRP Level (dBm)	Limit (dBm)	Margin (dB)	Azimuth (deg)
2	3760.00	-65.91	2.60	12.50	Horizontal	-56.01	-13.00	43.01	180
3	5640.00	-61.87	3.30	12.50	Horizontal	-52.67	-13.00	39.67	135
4	7520.00	-56.66	4.20	12.20	Horizontal	-48.66	-13.00	35.66	180
5	9400.00	-53.14	4.30	11.10	Horizontal	-46.34	-13.00	33.34	315
6	11280.00	-50.31	5.90	11.90	Horizontal	-44.31	-13.00	31.31	180
7	13160.00	-52.12	5.70	14.00	Horizontal	-43.82	-13.00	30.82	180
8	15040.00	-46.93	5.80	13.10	Horizontal	-39.63	-13.00	26.63	90
9	16920.00	-49.44	6.10	14.60	Horizontal	-40.94	-13.00	27.94	0
10	18800.00	--	--	--	--	--	--	--	--

Note: 1. The other Spurious RF Radiated emissions level is no more than noise floor.
2. The worst emission was found in the antenna is Horizontal position.

LTE Band 2 1.4MHz CH-Middle

Harmonic	Frequency (MHz)	SG (dBm)	Cable Loss (dB)	Gain (dBi)	Antenna Polarization	EIRP Level (dBm)	Limit (dBm)	Margin (dB)	Azimuth (deg)
2	3759.00	-65.95	2.60	12.50	Horizontal	-56.05	-13.00	43.05	225
3	5638.88	-54.30	3.30	12.50	Horizontal	-45.10	-13.00	32.10	180
4	7520.00	-58.38	4.20	12.20	Horizontal	-50.38	-13.00	37.38	45
5	9400.00	-54.47	4.30	11.10	Horizontal	-47.67	-13.00	34.67	135
6	11280.00	-51.97	5.90	11.90	Horizontal	-45.97	-13.00	32.97	315
7	13160.00	-54.13	5.70	14.00	Horizontal	-45.83	-13.00	32.83	90
8	15040.00	-54.50	5.80	13.10	Horizontal	-47.20	-13.00	34.20	180
9	16920.00	-53.13	6.10	14.60	Horizontal	-44.63	-13.00	31.63	315
10	18800.00	--	--	--	--	--	--	--	--

Note: 1.The other Spurious RF Radiated emissions level is no more than noise floor.
2. The worst emission was found in the antenna is Horizontal position.

LTE Band 2 5MHz CH-Middle

Harmonic	Frequency (MHz)	SG (dBm)	Cable Loss (dB)	Gain (dBi)	Antenna Polarization	EIRP Level (dBm)	Limit (dBm)	Margin (dB)	Azimuth (deg)
2	3755.00	-65.04	2.60	12.50	Horizontal	-55.14	-13.00	42.14	45
3	5632.50	-64.26	3.30	12.50	Horizontal	-55.06	-13.00	42.06	135
4	7510.00	-58.43	4.20	12.20	Horizontal	-50.43	-13.00	37.43	225
5	9387.50	-53.18	4.30	11.10	Horizontal	-46.38	-13.00	33.38	90
6	11265.00	-50.78	5.90	11.90	Horizontal	-44.78	-13.00	31.78	180
7	13142.50	-53.43	5.70	14.00	Horizontal	-45.13	-13.00	32.13	315
8	15020.00	-54.74	5.80	13.10	Horizontal	-47.44	-13.00	34.44	0
9	16897.50	-53.27	6.10	14.60	Horizontal	-44.77	-13.00	31.77	225
10	18800.00	--	--	--	--	--	--	--	--

Note: 1.The other Spurious RF Radiated emissions level is no more than noise floor.
2. The worst emission was found in the antenna is Horizontal position.



LTE Band 2 20MHz CH-Middle

Harmonic	Frequency (MHz)	SG (dBm)	Cable Loss (dB)	Gain (dBi)	Antenna Polarization	EIRP Level (dBm)	Limit (dBm)	Margin (dB)	Azimuth (deg)
2	3740.00	-64.80	2.60	12.50	Horizontal	-54.90	-13.00	41.90	315
3	5610.00	-59.82	3.30	12.50	Horizontal	-50.62	-13.00	37.62	135
4	7480.00	-57.77	4.20	12.20	Horizontal	-49.77	-13.00	36.77	0
5	9350.00	-55.86	4.30	11.10	Horizontal	-49.06	-13.00	36.06	45
6	11220.00	-51.97	5.90	11.90	Horizontal	-45.97	-13.00	32.97	135
7	13090.00	-53.17	5.70	14.00	Horizontal	-44.87	-13.00	31.87	225
8	14960.00	-53.90	5.80	13.10	Horizontal	-46.60	-13.00	33.60	90
9	16830.00	-52.69	6.10	14.60	Horizontal	-44.19	-13.00	31.19	270
10	18800.00	--	--	--	--	--	--	--	--

Note: 1. The other Spurious RF Radiated emissions level is no more than noise floor.

2. The worst emission was found in the antenna is Horizontal position.

6. Main Test Instruments

Name	Manufacturer	Type	Serial Number	Calibration Date	Expiration Date
Base Station Simulator	R&S	CMW500	113645	2021-05-15	2022-05-14
Climate Chamber	Weiss	VT4002	58226119450 010	2021-05-15	2022-05-14
Spectrum Analyzer	Keysight	N9020A	MY52330084	2021-05-15	2022-05-14
Universal Radio Communication Tester	Key sight	E5515C	GB44400275	2021-05-15	2022-05-14
Signal Analyzer	R&S	FSV3030	101411	2021-12-12	2022-12-12
Signal Analyzer	R&S	FSV30	100815	2021-12-12	2022-12-11
TRILOG Broadband Antenna	Schwarzbeck	VULB 9163	01439	2021-06-30	2024-06-29
Horn Antenna	Schwarzbeck	BBHA 9120D	01799	2019-09-21	2022-09-20
Software	R&S	EMC32	9.26.0	/	/

*****END OF REPORT *****



ANNEX A: The EUT Appearance

The EUT Appearance are submitted separately.



ANNEX B: Test Setup Photos

The Test Setup Photos are submitted separately.