



RF TEST REPORT

Applicant Xiaomi Communications Co., Ltd.
FCC ID 2AFZZ3QNY
Product Mobile Phone
Brand Redmi
Model 220333QNY
Report No. R2111A1060-R1
Issue Date January 25, 2022

TA Technology (Shanghai) Co., Ltd. tested the above equipment in accordance with the requirements in **FCC CFR47 Part 2 (2020)/ FCC CFR 47 Part 22H (2020)**. The test results show that the equipment tested is capable of demonstrating compliance with the requirements as documented in this report.

Prepared by: Peng Tao

Approved by: Kai Xu

TA Technology (Shanghai) Co., Ltd.

No.145, Jintang Rd, Tangzhen Industry Park, Pudong Shanghai, China

TEL: +86-021-50791141/2/3

FAX: +86-021-50791141/2/3-8000



TABLE OF CONTENT

1. Test Laboratory	4
1.1. Notes of the Test Report	4
1.2. Test facility	4
1.3. Testing Location	4
2. General Description of Equipment under Test.....	5
2.1. Applicant and Manufacturer Information	5
2.2. General Information.....	5
3. Applied Standards	7
4. Test Configuration.....	8
5. Test Case Results.....	10
5.1. RF Power Output and Effective Radiated Power	10
5.2. Occupied Bandwidth	15
5.3. Band Edge Compliance.....	26
5.4. Peak-to-Average Power Ratio (PAPR)	37
5.5. Frequency Stability.....	40
5.6. Spurious Emissions at Antenna Terminals	44
5.7. Radiates Spurious Emission	49
6. Main Test Instruments	57
ANNEX A: The EUT Appearance	58
ANNEX B: Test Setup Photos	59



Summary of measurement results

No.	Test Case	Clause in FCC rules	Verdict
1	RF Power Output and Effective Radiated Power	2.1046 22.913(a)(5)	PASS
2	Occupied Bandwidth	2.1049	PASS
3	Band Edge Compliance	2.1051 / 22.917(a)	PASS
4	Peak-to-Average Power Ratio	22.913(d)/ KDB 971168 D01(5.7)	PASS
5	Frequency Stability	2.1055 / 22.355	PASS
6	Spurious Emissions at Antenna Terminals	2.1051 / 22.917(a)	PASS
7	Radiates Spurious Emission	2.1053 / 22.917 (a)	PASS

Date of Testing: December 28, 2021~January 24, 2022

Date of Sample Received: December 27, 2021

Note: PASS: The EUT complies with the essential requirements in the standard.

FAIL: The EUT does not comply with the essential requirements in the standard.

All indications of Pass/Fail in this report are opinions expressed by TA Technology (Shanghai) Co., Ltd. based on interpretations and/or observations of test results. Measurement Uncertainties were not taken into account and are published for informational purposes only.



1. Test Laboratory

1.1. Notes of the Test Report

This report shall not be reproduced in full or partial, without the written approval of **TA technology (shanghai) co., Ltd.** The results documented in this report apply only to the tested sample, under the conditions and modes of operation as described herein. Measurement Uncertainties were not taken into account and are published for informational purposes only. This report is written to support regulatory compliance of the applicable standards stated above.

1.2. Test facility

FCC (Designation number: CN1179, Test Firm Registration Number: 446626)

TA Technology (Shanghai) Co., Ltd. has been listed on the US Federal Communications Commission list of test facilities recognized to perform measurements.

A2LA (Certificate Number: 3857.01)

TA Technology (Shanghai) Co., Ltd. has been listed by American Association for Laboratory Accreditation to perform measurement.

1.3. Testing Location

Company: TA Technology (Shanghai) Co., Ltd.
Address: No.145, Jintang Rd, Tangzhen Industry Park, Pudong
City: Shanghai
Post code: 201201
Country: P. R. China
Contact: Xu Kai
Telephone: +86-021-50791141/2/3
Fax: +86-021-50791141/2/3-8000
Website: <http://www.ta-shanghai.com>
E-mail: xukai@ta-shanghai.com

2. General Description of Equipment under Test

2.1. Applicant and Manufacturer Information

Applicant	Xiaomi Communications Co., Ltd.
Applicant address	#019, 9th Floor, Building 6, 33 Xi'erqi Middle Road, Haidian District, Beijing, China, 100085
Manufacturer	Xiaomi Communications Co., Ltd.
Manufacturer address	#019, 9th Floor, Building 6, 33 Xi'erqi Middle Road, Haidian District, Beijing, China, 100085

2.2. General Information

EUT Description			
Model	220333QNY		
IMEI	IMEI 1: 862390060019009 IMEI 2: 862390060019017		
Hardware Version	P1.1		
Software Version	MIUI13		
Antenna Type	PIFA Antenna		
Antenna Gain	Band	Low Antenna	Upper Antenna
	GSM850	-3.40 dBi	-1.10dBi
	WCDMA Band V	-3.40 dBi	-1.10dBi
	LTE Band 5	-2.90 dBi	-0.89dBi
Test Mode(s)	GSM 850; WCDMA Band V; LTE Band 5;		
Test Modulation	(GSM/GPRS)GMSK, (EGPRS) GMSK/ 8PSK; (WCDMA) BPSK, QPSK; (LTE)QPSK,16QAM, 64QAM		
GPRS Multislot Class	33		
EGPRS Multislot Class	33		
HSDPA UE Category	24		
HSUPA UE Category	6		
LTE Category	5		
Maximum E.R.P.	GSM 850:	29.49dBm	
	WCDMA Band V:	21.30dBm	
	LTE Band 5:	21.45dBm	
Rated Power Supply Voltage	3.87V		
Operating Voltage	Minimum: 3.6V Maximum: 4.2V		
Operating Temperature	Lowest: 0°C Highest: +40°C		
Testing Temperature	Lowest: -30°C Highest: +50°C		
Operating Frequency Range(s)	Band	Tx (MHz)	Rx (MHz)



	GSM850	824 ~ 849	869 ~ 894
	WCDMA Band V	824 ~ 849	869 ~ 894
	LTE Band 5	824 ~ 849	869 ~ 894

Note: 1. The EUT is sent from the applicant to TA and the information of the EUT is declared by the applicant.



3. Applied Standards

According to the specifications of the manufacturer, it must comply with the requirements of the following standards:

Test standards:

FCC CFR 47 Part 22H (2020)

FCC CFR47 Part 2 (2020)

Reference standard:

ANSI C63.26 (2015)

KDB 971168 D01 Power Meas License Digital Systems v03r01

4. Test Configuration

There is more than one SIM card slot, each one should be applied throughout the compliance test respectively, and however, only the worst case (SIM 1) will be recorded in this report.

Radiated measurements are performed by rotating the EUT in three different orthogonal test planes. EUT stand-up position (Z axis), lie-down position (X, Y axis). Receiver antenna polarization (horizontal and vertical), the worst emission was found in position (X axis, horizontal polarization for GSM/WCDMA; Z axis, horizontal polarization for LTE) and the worst case was recorded.

All mode and data rates and positions and RB size and modulations were investigated. Subsequently, only the worst case emissions are reported.

The following testing in GSM/WCDMA/LTE is set based on the maximum RF Output Power.

Test modes are chosen to be reported as the worst case configuration below:

Test items	Modes/Modulation	
	GSM 850	WCDMA Band V
RF Power Output and Effective Radiated power	GSM GPRS EGPRS	RMC/AMR HSDPA/HSUPA DC-HSDPA
Occupied Bandwidth	GSM GPRS(1Tx slot) EGPRS(1Tx slot)	RMC
Band Edge Compliance	GSM GPRS(1Tx slot) EGPRS(1Tx slot)	RMC
Peak-to-Average Power Ratio	GSM GPRS(1Tx slot) EGPRS(1Tx slot)	RMC
Frequency Stability	GSM GPRS(1Tx slot) EGPRS(1Tx slot)	RMC
Spurious Emissions at Antenna Terminals	GSM	RMC
Radiates Spurious Emission	GSM	RMC

Test modes are chosen as the worst case configuration below for LTE Band 5.

Test items	Bandwidth (MHz)				Modulation		RB			Test Channel		
	1.4	3	5	10	QPSK	16QAM/ 64QAM	1	50%	100%	L	M	H
RF power output and Effective Radiated power	O	O	O	O	O	O	O	O	O	O	O	O
Occupied Bandwidth	O	O	O	O	O	O	-	-	O	O	O	O
Band Edge Compliance	O	O	O	O	O	O	O	-	O	O	-	O
Peak-to-Average Power Ratio	O	O	O	O	O	O	-	-	O	O	O	O
Frequency Stability	O	O	O	O	O	O	O	-	-	-	O	-
Spurious Emissions at Antenna Terminals	O	O	O	O	O	-	O	-	-	O	O	O
Radiates Spurious Emission	O	-	O	O	O	-	O	-	-	-	O	-
Note	1. The mark "O" means that this configuration is chosen for testing. 2. The mark "-" means that this configuration is not testing.											

5. Test Case Results

5.1. RF Power Output and Effective Radiated Power

Ambient condition

Temperature	Relative humidity	Pressure
23°C ~25°C	45%~50%	101.5kPa

Methods of Measurement

During the process of the testing, The EUT was connected to the Base Station Simulator with a known loss. The EUT is controlled by the Base Station Simulator test set to ensure max power transmission with proper modulation.

ERP can then be calculated as follows:

$$\text{EIRP (dBm)} = \text{Output Power (dBm)} - \text{Losses (dB)} + \text{Antenna Gain (dBi)}$$

where:dBd refers to gain relative to an ideal dipole.

$$\text{EIRP (dBm)} = \text{ERP (dBm)} + 2.15 \text{ (dB)}.$$

Test Setup

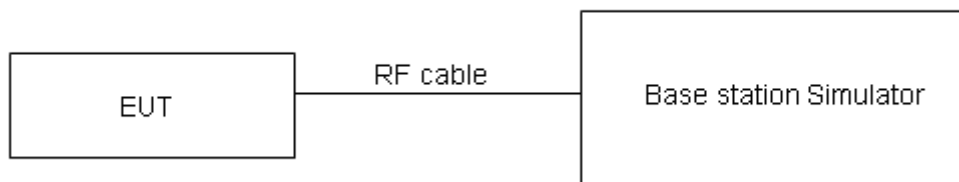

Limits

No specific RF power output requirements in part 2.1046.

Rule Part 22.913(a)(5) specifies that "Mobile/portable stations are limited to 7 watts ERP".

Limit	≤ 7 W (38.45 dBm)
-------	-------------------

Measurement Uncertainty

The assessed measurement uncertainty to ensure 95% confidence level for the normal distribution is with the coverage factor $k = 2$, $U = 0.4$ dB for RF power output, $k = 2$, $U = 1.19$ dB for ERP.

Test Results

GSM 850		Maximum Output Power (dBm)			Low Antenna ERP (dBm)			Upper Antenna ERP (dBm)		
		Channel 128	Channel 190	Channel 251	Channel 128	Channel 190	Channel 251	Channel 128	Channel 190	Channel 251
		824.2 (MHz)	836.6 (MHz)	848.8 (MHz)	824.2 (MHz)	836.6 (MHz)	848.8 (MHz)	824.2 (MHz)	836.6 (MHz)	848.8 (MHz)
GSM(GMSK)	Results	32.40	32.60	32.57	26.85	27.05	27.02	29.15	29.35	29.32
GPRS (GMSK)	1TXslot	32.09	32.74	32.40	26.54	27.19	26.85	28.84	29.49	29.15
	2TXslots	30.15	30.60	30.71	24.60	25.05	25.16	26.90	27.35	27.46
	3TXslots	27.77	28.10	28.13	22.22	22.55	22.58	24.52	24.85	24.88
	4TXslots	25.56	25.81	25.95	20.01	20.26	20.40	22.31	22.56	22.70
EGPRS (8PSK)	1TXslot	26.52	26.51	26.71	20.97	20.96	21.16	23.27	23.26	23.46
	2TXslots	24.89	25.32	25.40	19.34	19.77	19.85	21.64	22.07	22.15
	3TXslots	22.76	23.21	23.20	17.21	17.66	17.65	19.51	19.96	19.95
	4TXslots	21.72	22.19	22.19	16.17	16.64	16.64	18.47	18.94	18.94

WCDMA Band V		Maximum Output Power (dBm)			Low Antenna ERP (dBm)			Upper Antenna ERP (dBm)		
		Channel 4132	Channel 4183	Channel 4233	Channel 4132	Channel 4183	Channel 4233	Channel 4132	Channel 4183	Channel 4233
		826.4 (MHz)	836.6 (MHz)	846.6 (MHz)	826.4 (MHz)	836.6 (MHz)	846.6 (MHz)	826.4 (MHz)	836.6 (MHz)	846.6 (MHz)
RMC		24.55	24.50	24.49	19.00	18.95	18.94	21.30	21.25	21.24
AMR		24.45	24.40	24.53	18.90	18.85	18.98	21.20	21.15	21.28
HSDPA	Sub - Test 1	23.59	23.40	23.51	18.04	17.85	17.96	20.34	20.15	20.26
	Sub - Test 2	23.55	23.52	23.49	18.00	17.97	17.94	20.30	20.27	20.24
	Sub - Test 3	23.13	23.16	23.07	17.58	17.61	17.52	19.88	19.91	19.82
	Sub - Test 4	23.13	22.88	22.85	17.58	17.33	17.30	19.88	19.63	19.60
HSUPA	Sub - Test 1	23.43	23.52	23.65	17.88	17.97	18.10	20.18	20.27	20.40
	Sub - Test 2	21.49	21.66	21.51	15.94	16.11	15.96	18.24	18.41	18.26
	Sub - Test 3	22.63	22.56	22.45	17.08	17.01	16.90	19.38	19.31	19.20
	Sub - Test 4	21.41	21.38	21.49	15.86	15.83	15.94	18.16	18.13	18.24
	Sub - Test 5	23.71	23.56	23.47	18.16	18.01	17.92	20.46	20.31	20.22
DC-HSDPA	Sub - Test 1	23.63	23.50	23.55	18.08	17.95	18.00	20.38	20.25	20.30
	Sub - Test 2	23.51	23.56	23.35	17.96	18.01	17.80	20.26	20.31	20.10
	Sub - Test 3	22.99	22.98	22.91	17.44	17.43	17.36	19.74	19.73	19.66
	Sub - Test 4	23.09	22.96	22.83	17.54	17.41	17.28	19.84	19.71	19.58



LTE Band 5				Maximum Output Power(dBm)			Low Antenna ERP (dBm)			Upper Antenna ERP (dBm)		
BW	Modulation	RB size	RB offset	Channel/Frequency(MHz)								
				20407 /824.7	20525 /836.5	20643 /848.3	20407 /824.7	20525 /836.5	20643 /848.3	20407 /824.7	20525 /836.5	20643 /848.3
1.4MHz	QPSK	1	0	24.15	24.24	24.04	19.10	19.19	18.99	21.11	21.20	21.00
		1	2	24.49	24.19	24.08	19.44	19.14	19.03	21.45	21.15	21.04
		1	5	23.99	24.11	24.21	18.94	19.06	19.16	20.95	21.07	21.17
		3	0	24.08	23.99	23.88	19.03	18.94	18.83	21.04	20.95	20.84
		3	2	23.95	24.22	23.88	18.90	19.17	18.83	20.91	21.18	20.84
		3	3	23.84	23.94	23.75	18.79	18.89	18.70	20.80	20.90	20.71
		6	0	23.03	23.03	22.84	17.98	17.98	17.79	19.99	19.99	19.80
	16QAM	1	0	23.25	22.64	23.08	18.20	17.59	18.03	20.21	19.60	20.04
		1	2	23.23	23.28	22.95	18.18	18.23	17.90	20.19	20.24	19.91
		1	5	22.95	22.71	22.85	17.90	17.66	17.80	19.91	19.67	19.81
		3	0	23.18	23.01	22.80	18.13	17.96	17.75	20.14	19.97	19.76
		3	2	23.31	23.21	23.09	18.26	18.16	18.04	20.27	20.17	20.05
		3	3	23.03	23.10	22.96	17.98	18.05	17.91	19.99	20.06	19.92
		6	0	21.98	22.16	21.84	16.93	17.11	16.79	18.94	19.12	18.80
	64QAM	1	0	21.99	21.74	22.08	16.94	16.69	17.03	18.95	18.70	19.04
		1	2	22.47	22.29	22.10	17.42	17.24	17.05	19.43	19.25	19.06
		1	5	22.13	22.11	22.04	17.08	17.06	16.99	19.09	19.07	19.00
		3	0	22.02	22.04	21.81	16.97	16.99	16.76	18.98	19.00	18.77
		3	2	22.05	21.92	22.01	17.00	16.87	16.96	19.01	18.88	18.97
		3	3	21.75	21.80	21.87	16.70	16.75	16.82	18.71	18.76	18.83
		6	0	20.94	20.93	20.94	15.89	15.88	15.89	17.90	17.89	17.90
BW	Modulation	RB size	RB offset	Channel/Frequency(MHz)								
				20415 /825.5	20525 /836.5	20635 /847.5	20415 /825.5	20525 /836.5	20635 /847.5	20415 /825.5	20525 /836.5	20635 /847.5
3MHz	QPSK	1	0	24.16	24.27	24.06	19.11	19.22	19.01	21.12	21.23	21.02
		1	7	24.48	24.23	24.13	19.43	19.18	19.08	21.44	21.19	21.09
		1	14	24.01	24.15	24.24	18.96	19.10	19.19	20.97	21.11	21.20
		8	0	23.18	23.11	23.01	18.13	18.06	17.96	20.14	20.07	19.97
		8	4	23.08	23.33	22.99	18.03	18.28	17.94	20.04	20.29	19.95
		8	7	22.94	23.07	22.86	17.89	18.02	17.81	19.90	20.03	19.82
		15	0	23.07	23.08	22.89	18.02	18.03	17.84	20.03	20.04	19.85
	16QAM	1	0	23.27	22.65	23.10	18.22	17.60	18.05	20.23	19.61	20.06



		1	7	23.26	23.30	22.99	18.21	18.25	17.94	20.22	20.26	19.95
		1	14	22.97	22.75	22.87	17.92	17.70	17.82	19.93	19.71	19.83
		8	0	22.30	22.15	21.93	17.25	17.10	16.88	19.26	19.11	18.89
		8	4	22.41	22.33	22.20	17.36	17.28	17.15	19.37	19.29	19.16
		8	7	22.13	22.22	22.09	17.08	17.17	17.04	19.09	19.18	19.05
		15	0	22.02	22.21	21.86	16.97	17.16	16.81	18.98	19.17	18.82
	64QAM	1	0	22.01	21.75	22.10	16.96	16.70	17.05	18.97	18.71	19.06
		1	7	22.50	22.31	22.12	17.45	17.26	17.07	19.46	19.27	19.08
		1	14	22.15	22.10	22.06	17.10	17.05	17.01	19.11	19.06	19.02
		8	0	21.14	21.18	20.94	16.09	16.13	15.89	18.10	18.14	17.90
		8	4	21.15	21.04	21.12	16.10	15.99	16.07	18.11	18.00	18.08
		8	7	20.85	20.92	21.00	15.80	15.87	15.95	17.81	17.88	17.96
		15	0	20.98	20.98	20.96	15.93	15.93	15.91	17.94	17.94	17.92
BW	Modulation	RB size	RB offset	Channel/Frequency(MHz)								
				20425 /826.5	20525 /836.5	20625 /846.5	20425 /826.5	20525 /836.5	20625 /846.5	20425 /826.5	20525 /836.5	20625 /846.5
5MHz	QPSK	1	0	24.15	24.23	24.04	19.10	19.18	18.99	21.11	21.19	21.00
		1	13	24.46	24.22	24.10	19.41	19.17	19.05	21.42	21.18	21.06
		1	24	23.98	24.10	24.20	18.93	19.05	19.15	20.94	21.06	21.16
		12	0	23.16	23.07	22.98	18.11	18.02	17.93	20.12	20.03	19.94
		12	6	23.05	23.28	22.95	18.00	18.23	17.90	20.01	20.24	19.91
		12	13	22.91	23.04	22.82	17.86	17.99	17.77	19.87	20.00	19.78
		25	0	23.05	23.04	22.84	18.00	17.99	17.79	20.01	20.00	19.80
	16QAM	1	0	23.22	22.63	23.08	18.17	17.58	18.03	20.18	19.59	20.04
		1	13	23.24	23.27	22.97	18.19	18.22	17.92	20.20	20.23	19.93
		1	24	22.94	22.71	22.84	17.89	17.66	17.79	19.90	19.67	19.80
		12	0	22.27	22.13	21.90	17.22	17.08	16.85	19.23	19.09	18.86
		12	6	22.38	22.28	22.16	17.33	17.23	17.11	19.34	19.24	19.12
		12	13	22.11	22.18	22.06	17.06	17.13	17.01	19.07	19.14	19.02
		25	0	21.99	22.16	21.82	16.94	17.11	16.77	18.95	19.12	18.78
	64QAM	1	0	21.96	21.73	22.08	16.91	16.68	17.03	18.92	18.69	19.04
		1	13	22.48	22.28	22.10	17.43	17.23	17.05	19.44	19.24	19.06
		1	24	22.16	22.09	22.07	17.11	17.04	17.02	19.12	19.05	19.03
		12	0	21.13	21.20	20.95	16.08	16.15	15.90	18.09	18.16	17.91
		12	6	21.13	21.01	21.11	16.08	15.96	16.06	18.09	17.97	18.07
		12	13	20.83	20.88	20.97	15.78	15.83	15.92	17.79	17.84	17.93
		25	0	20.95	20.93	20.92	15.90	15.88	15.87	17.91	17.89	17.88



BW	Modulation	RB size	RB offset	Channel/Frequency(MHz)								
				20450 /829	20525 /836.5	20600 /844	20450 /829	20525 /836.5	20600 /844	20450 /829	20525 /836.5	20600 /844
10MHz	QPSK	1	0	24.12	24.19	24.01	19.07	19.14	18.96	21.08	21.15	20.97
		1	25	24.45	24.18	24.08	19.40	19.13	19.03	21.41	21.14	21.04
		1	49	23.96	24.09	24.17	18.91	19.04	19.12	20.92	21.05	21.13
		25	0	23.13	23.02	22.94	18.08	17.97	17.89	20.09	19.98	19.90
		25	13	23.03	23.24	22.92	17.98	18.19	17.87	19.99	20.20	19.88
		25	25	22.88	22.99	22.78	17.83	17.94	17.73	19.84	19.95	19.74
		50	0	23.02	22.99	22.80	17.97	17.94	17.75	19.98	19.95	19.76
	16QAM	1	0	23.06	22.59	23.03	18.01	17.54	17.98	20.02	19.55	19.99
		1	25	23.20	23.25	22.93	18.15	18.20	17.88	20.16	20.21	19.89
		1	49	22.92	22.68	22.82	17.87	17.63	17.77	19.88	19.64	19.78
		25	0	22.24	22.09	21.87	17.19	17.04	16.82	19.20	19.05	18.83
		25	13	22.35	22.26	22.13	17.30	17.21	17.08	19.31	19.22	19.09
		25	25	22.08	22.13	22.02	17.03	17.08	16.97	19.04	19.09	18.98
		50	0	21.97	22.12	21.79	16.92	17.07	16.74	18.93	19.08	18.75
	64QAM	1	0	21.94	21.69	22.03	16.89	16.64	16.98	18.90	18.65	18.99
		1	25	22.44	22.26	22.06	17.39	17.21	17.01	19.40	19.22	19.02
		1	49	22.10	22.03	22.01	17.05	16.98	16.96	19.06	18.99	18.97
		25	0	21.08	21.12	20.88	16.03	16.07	15.83	18.04	18.08	17.84
		25	13	21.09	20.97	21.05	16.04	15.92	16.00	18.05	17.93	18.01
		25	25	20.80	20.83	20.93	15.75	15.78	15.88	17.76	17.79	17.89
		50	0	20.93	20.89	20.89	15.88	15.84	15.84	17.89	17.85	17.85

5.2. Occupied Bandwidth

Ambient condition

Temperature	Relative humidity	Pressure
23°C ~25°C	45%~50%	101.5kPa

Method of Measurement

The EUT was connected to Spectrum Analyzer and Base Station Simulator via power Splitter. The occupied bandwidth is measured using spectrum analyzer.

RBW is set to $\geq 1\%EBW$, VBW is set to 3x RBW.

99% power and -26dBc occupied bandwidths are recorded. Spectrum analyzer plots are included on the following pages.

Test Setup

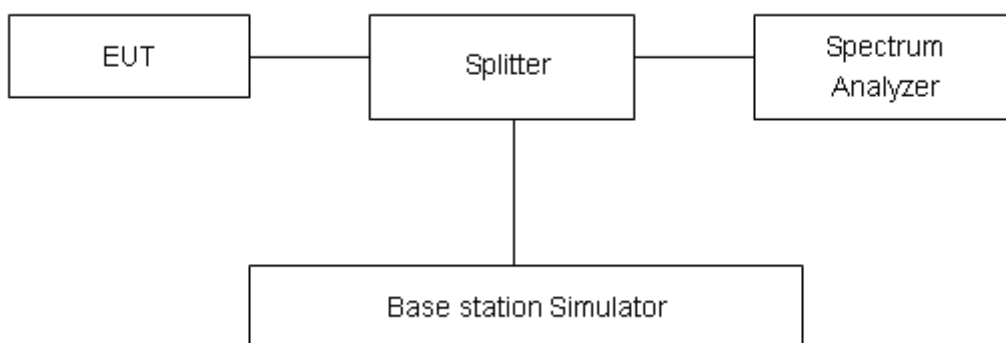

Limits

No specific occupied bandwidth requirements in part 2.1049.

Measurement Uncertainty

The assessed measurement uncertainty to ensure 95% confidence level for the normal distribution is with the coverage factor $k = 2$, $U = 624\text{Hz}$.

Test Result

Mode	Channel	Frequency (MHz)	99% Power Bandwidth (MHz)	-26dBc Bandwidth(MHz)
GSM 850 (GMSK)	128	824.2	0.241	0.309
	190	836.6	0.243	0.311
	251	848.8	0.243	0.313
GPRS 850 (GMSK)	128	824.2	0.245	0.307
	190	836.6	0.246	0.321
	251	848.8	0.248	0.316
EGPRS 850 (8PSK)	128	824.2	0.246	0.311
	190	836.6	0.242	0.312
	251	848.8	0.244	0.306
WCDMA Band V (RMC)	4132	826.4	4.118	4.700
	4183	836.6	4.119	4.689
	4233	846.6	4.124	4.672

LTE Band 5						
RB	Modulation	Bandwidth (MHz)	Channel	Frequency (MHz)	99% Power Bandwidth(MHz)	-26dBc Bandwidth(MHz)
100%	QPSK	1.4	20407	824.7	1.097	1.273
			20525	836.5	1.092	1.299
			20643	848.3	1.096	1.297
		3	20415	825.5	2.695	2.993
			20525	836.5	2.701	2.964
			20635	847.5	2.696	2.986
		5	20425	826.5	4.523	5.030
			20525	836.5	4.518	4.949
			20625	846.5	4.506	4.914
		10	20450	829	8.994	9.951
			20525	836.5	8.951	9.751
			20600	844	9.000	9.849
	16QAM	1.4	20407	824.7	1.098	1.301
			20525	836.5	1.095	1.299
			20643	848.3	1.093	1.264



		3	20415	825.5	2.712	2.927
			20525	836.5	2.699	3.006
			20635	847.5	2.698	2.978
		5	20425	826.5	4.515	5.000
			20525	836.5	4.493	4.995
			20625	846.5	4.516	4.972
		10	20450	829	8.979	9.861
			20525	836.5	8.977	9.810
			20600	844	8.951	9.754
	64QAM	1.4	20407	824.7	1.098	1.289
			20525	836.5	1.100	1.284
			20643	848.3	1.089	1.269
		3	20415	825.5	2.715	2.971
			20525	836.5	2.697	2.980
			20635	847.5	2.695	2.987
		5	20425	826.5	4.496	4.979
			20525	836.5	4.506	5.005
			20625	846.5	4.515	5.010
10	20450	829	9.001	9.786		
	20525	836.5	8.971	9.790		
	20600	844	8.980	9.761		

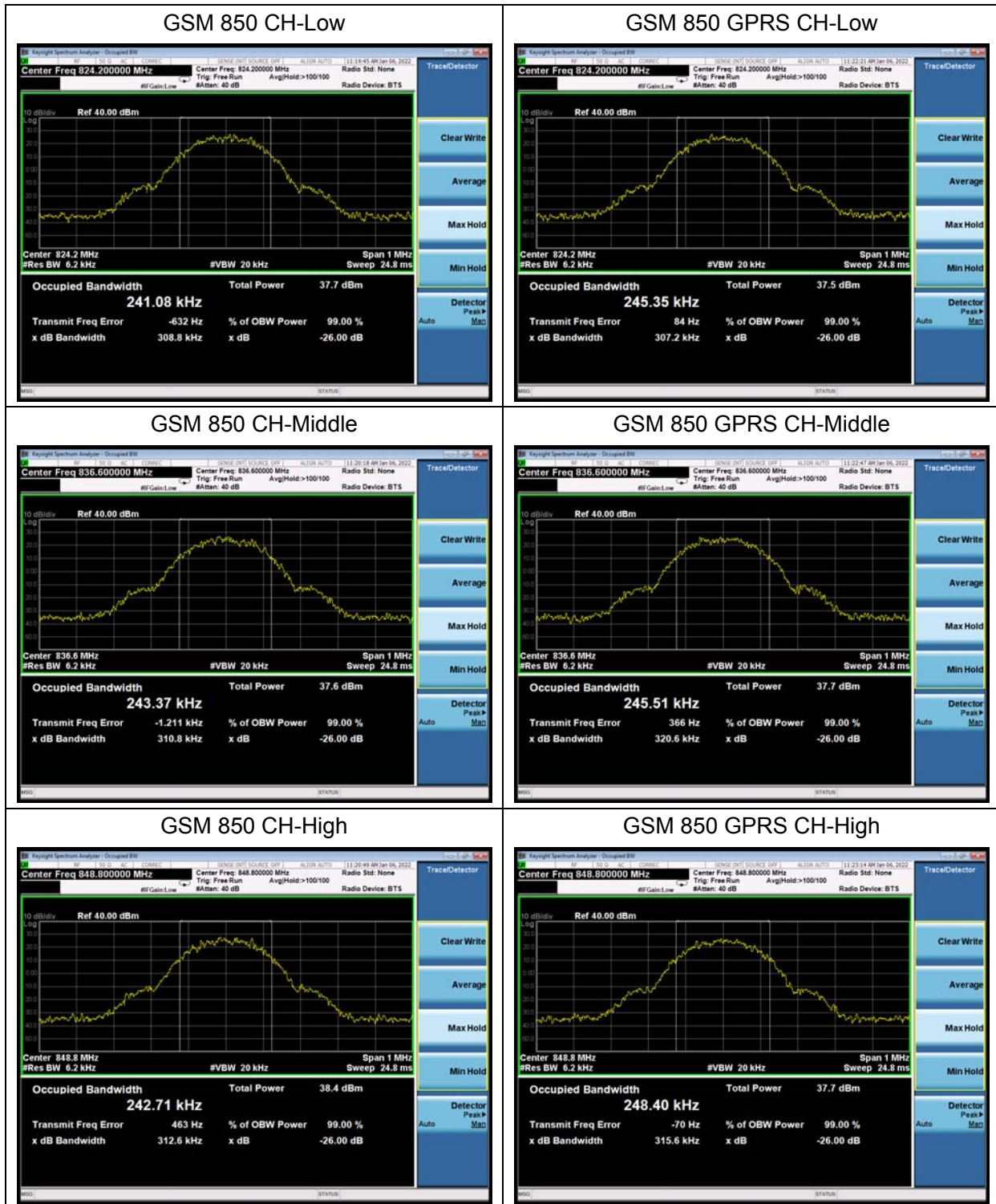

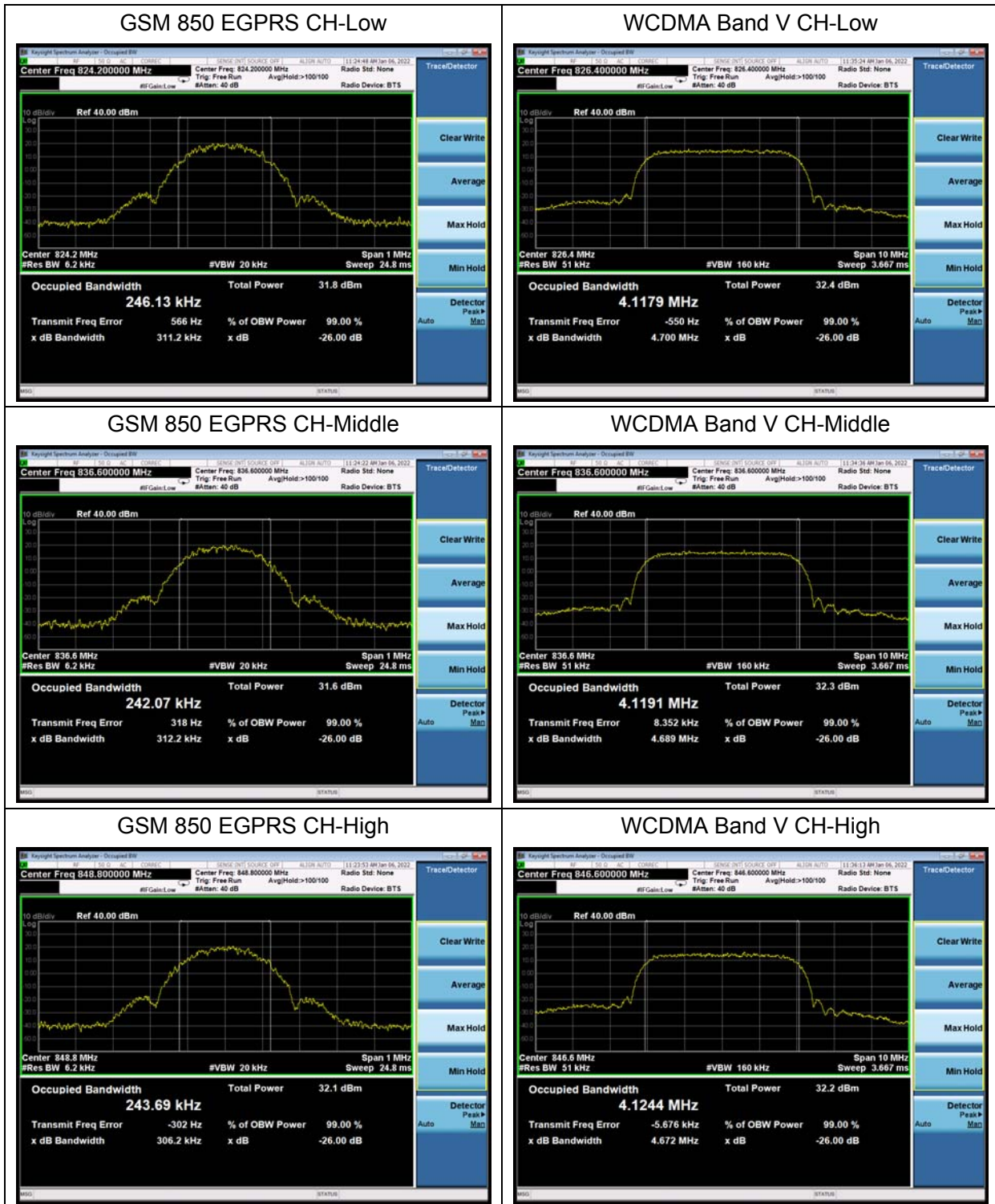

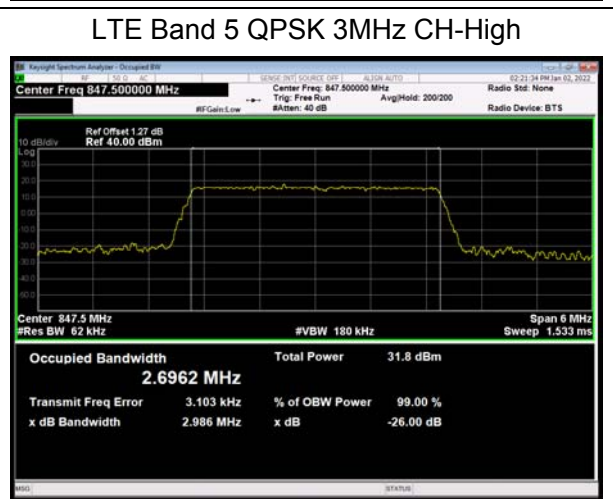
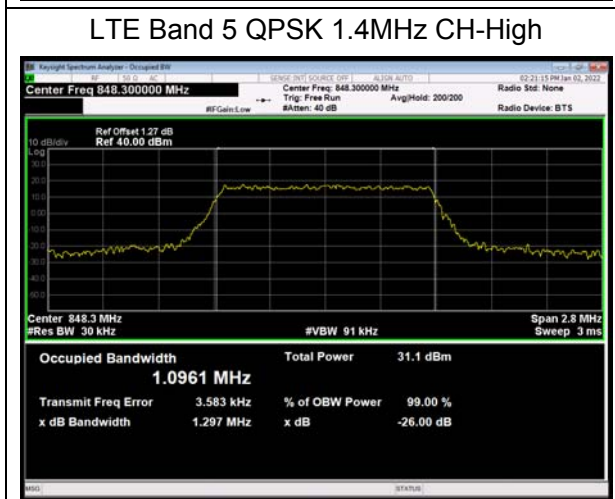
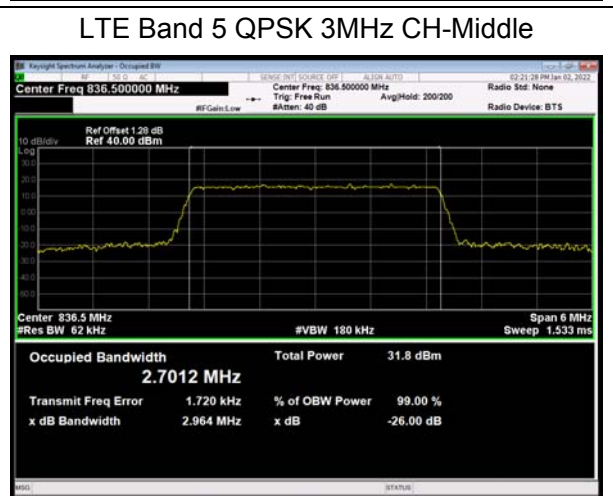
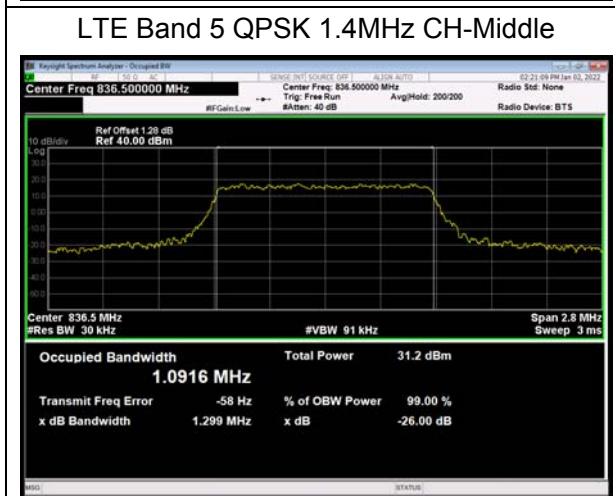
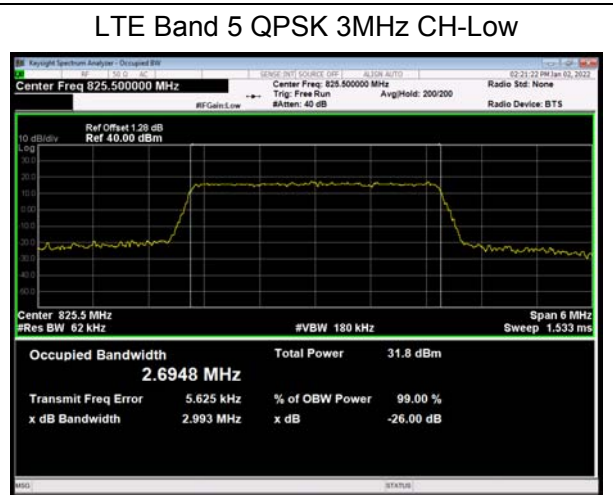
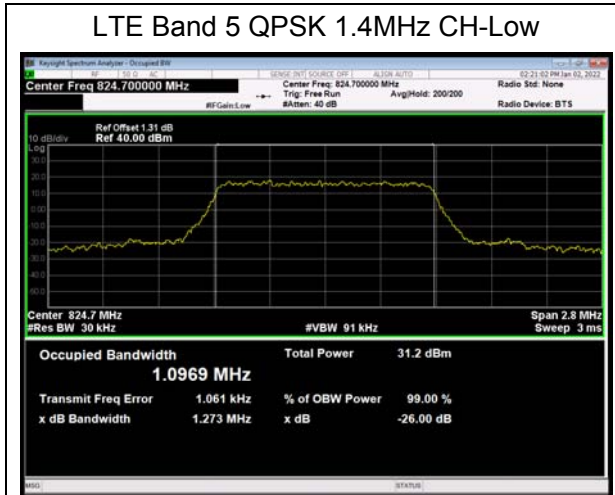

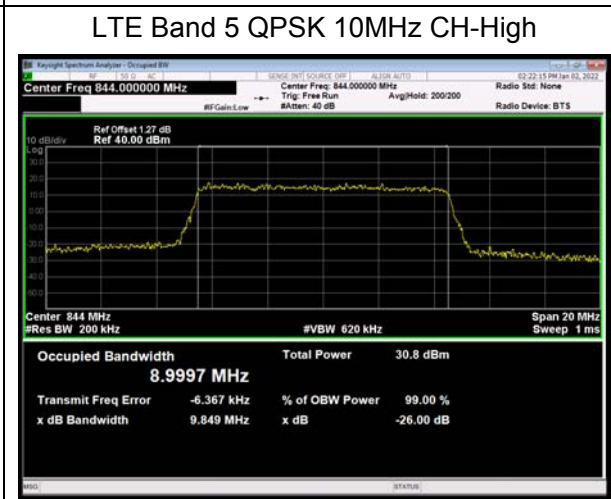
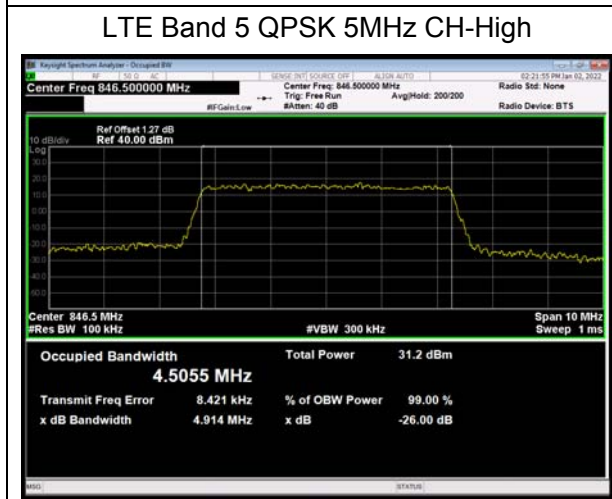
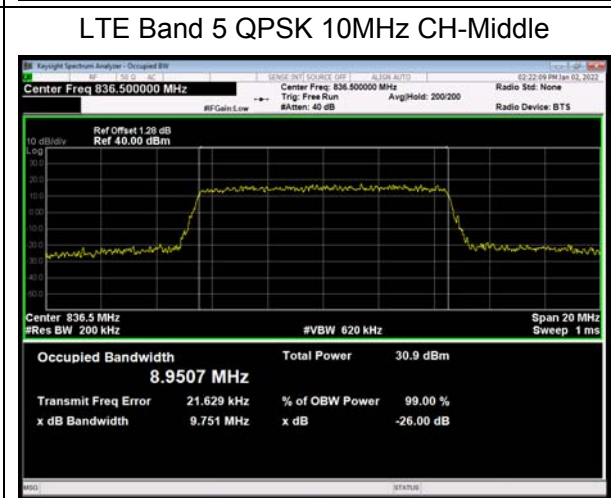
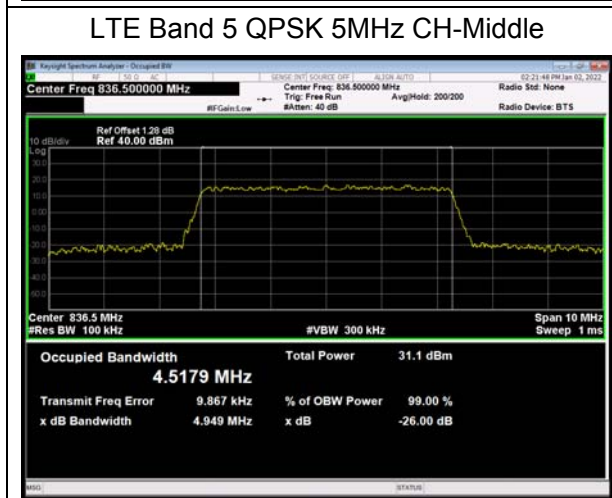
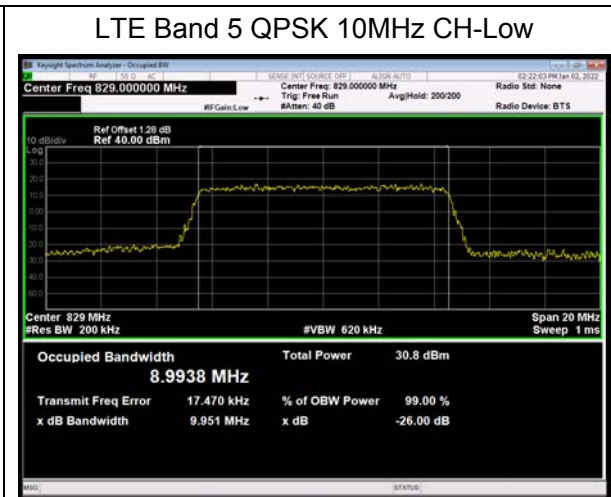
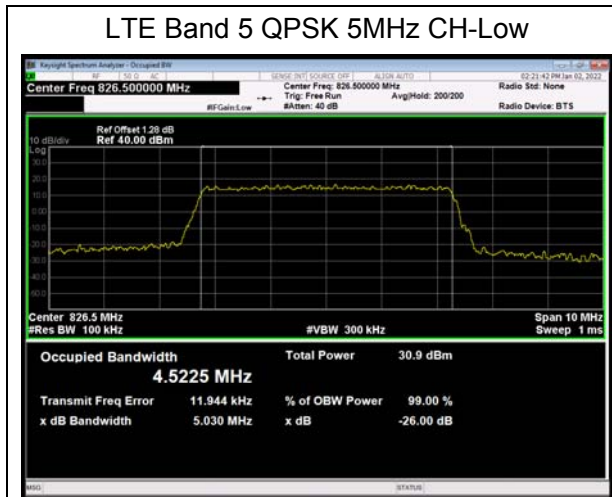

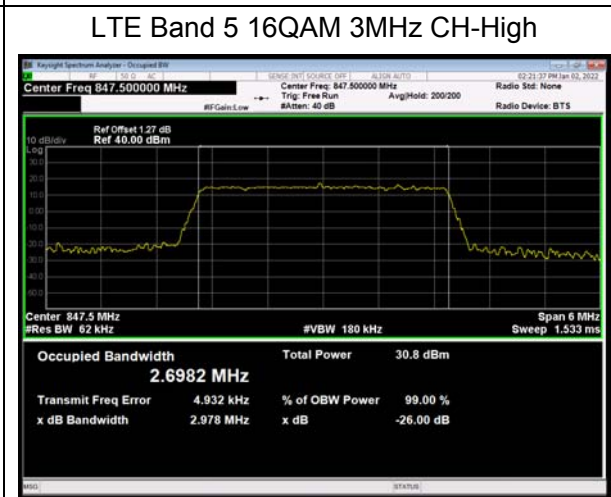
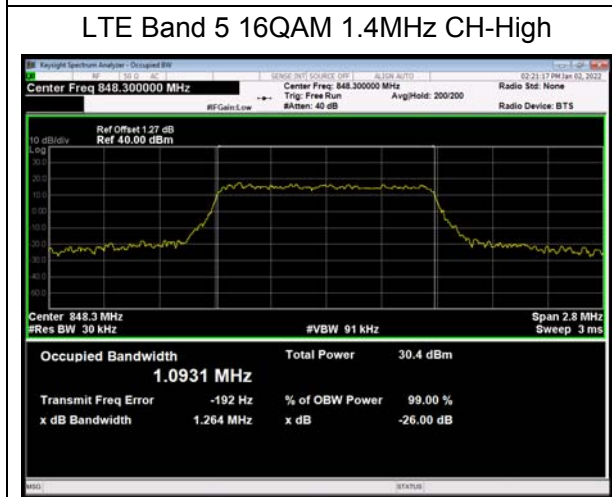
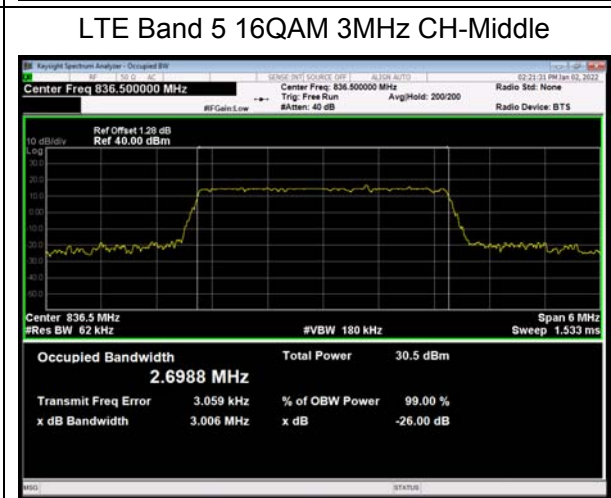
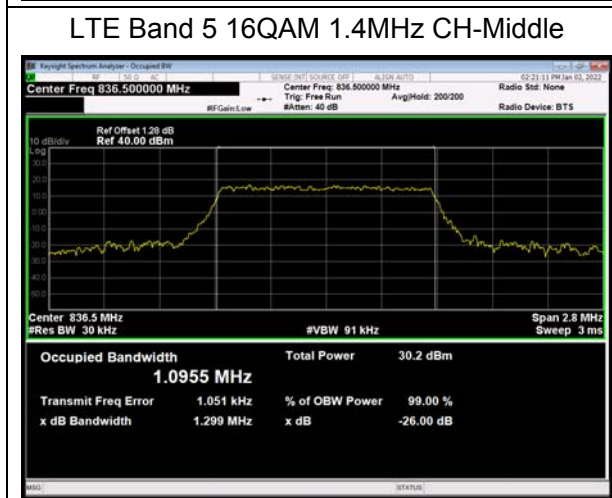
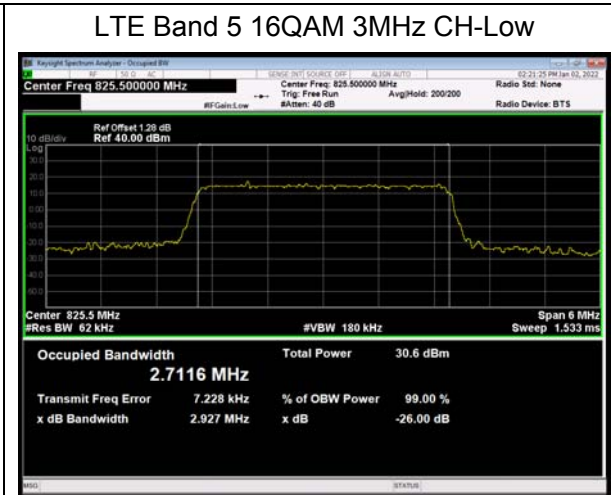
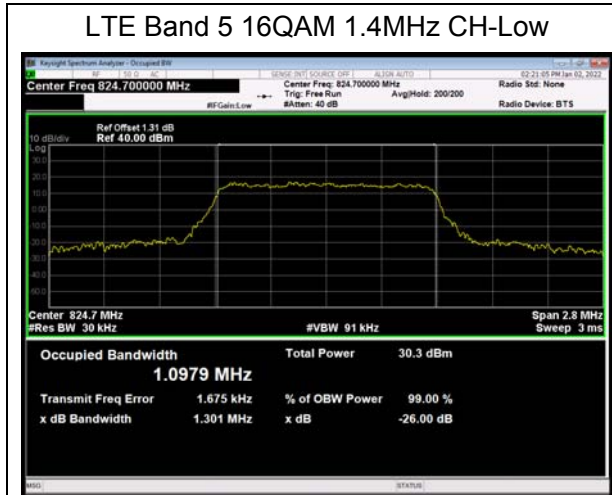

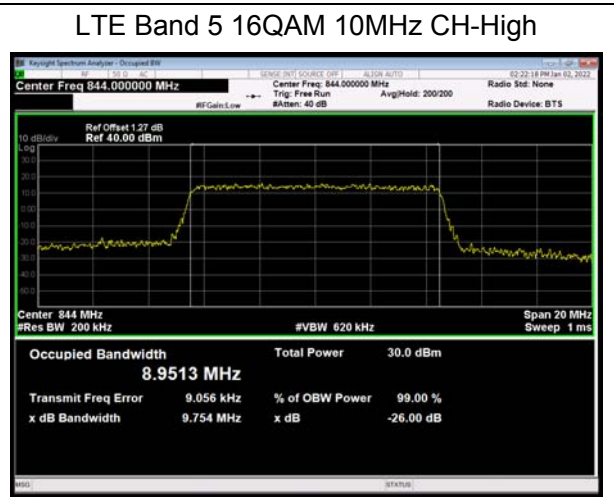
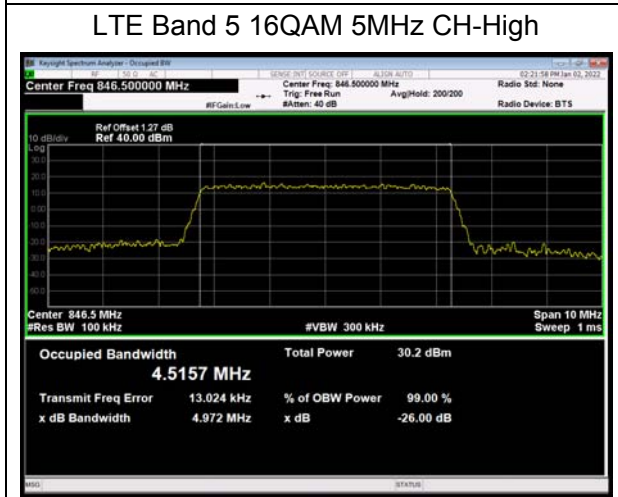
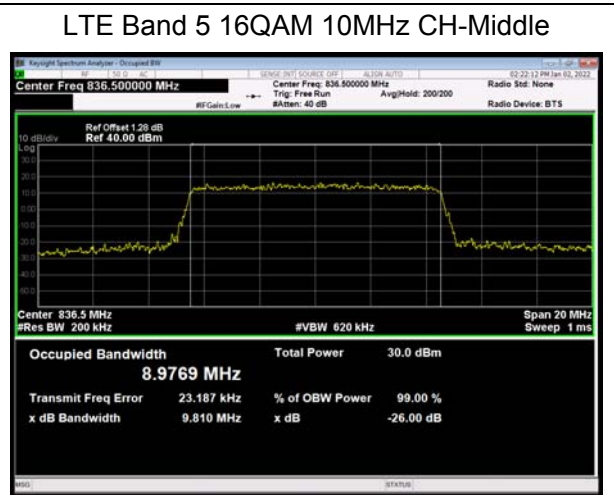
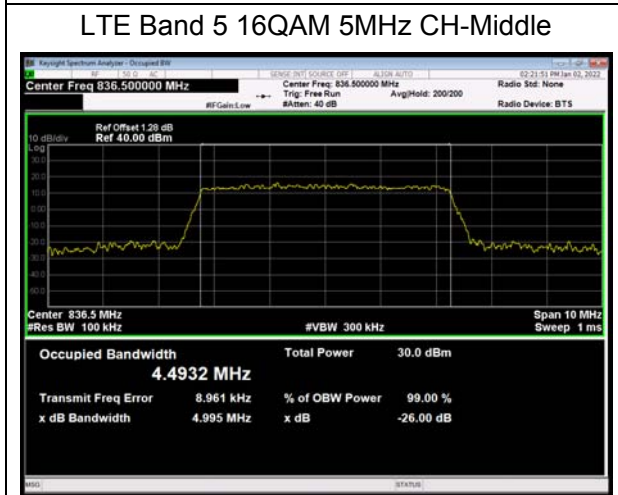
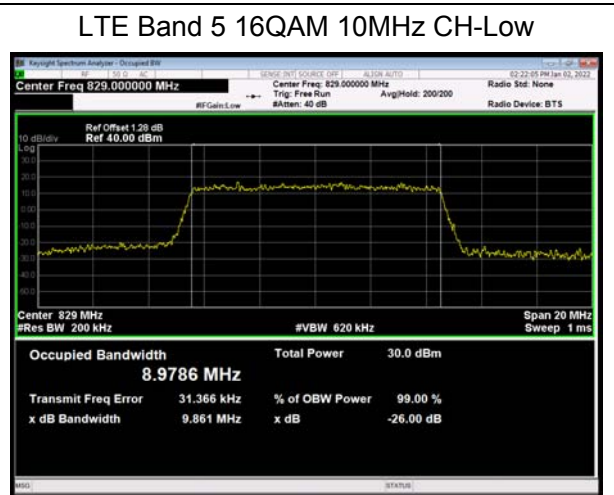
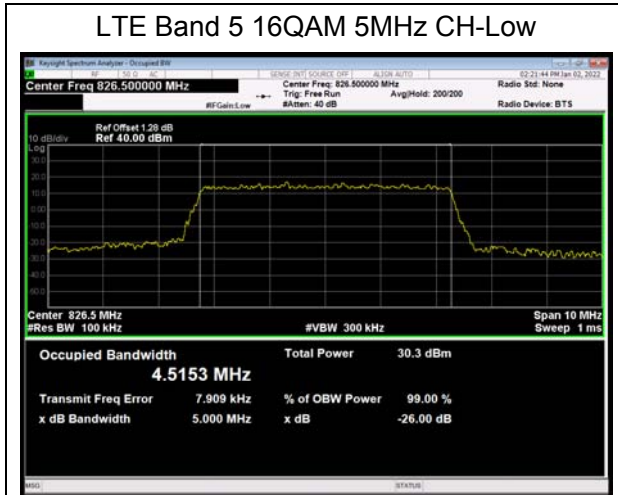

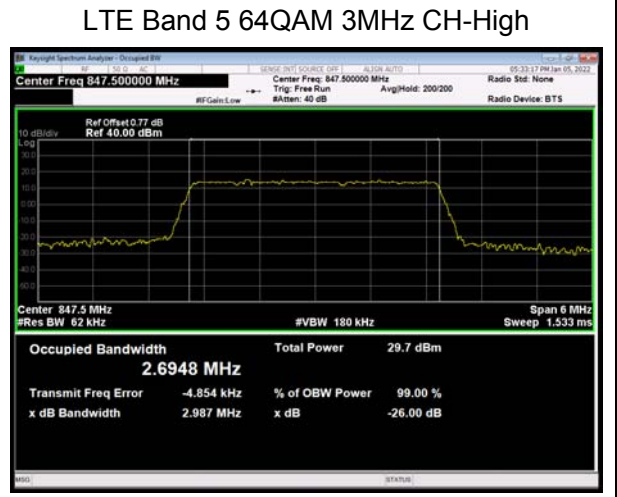
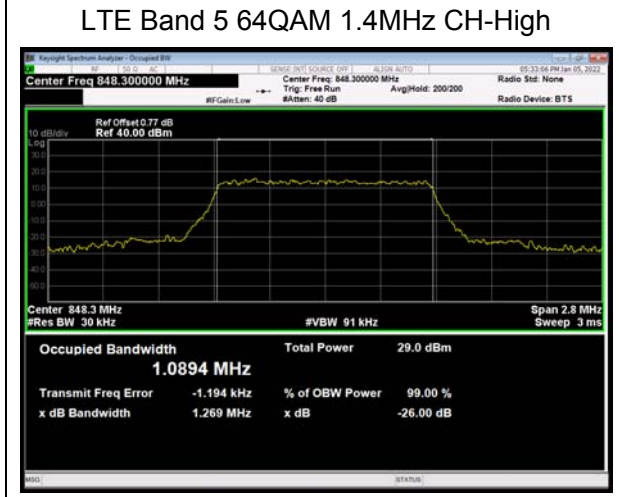
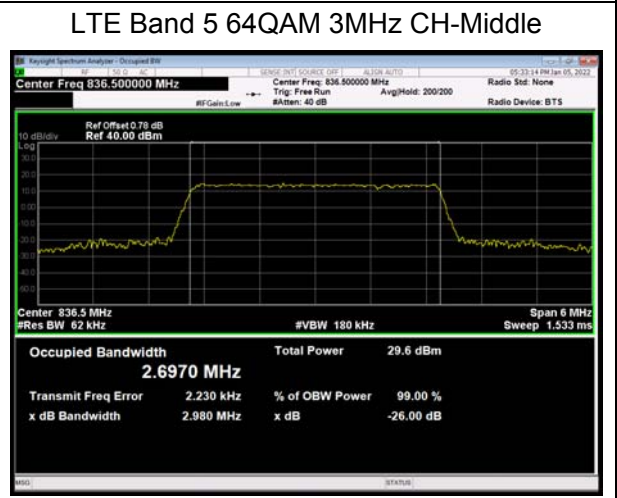
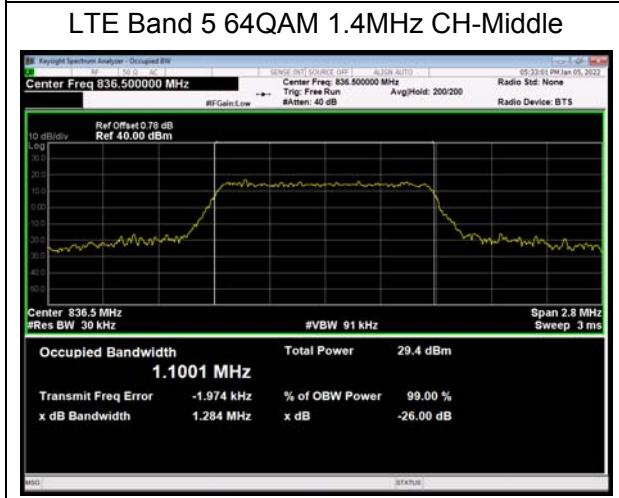
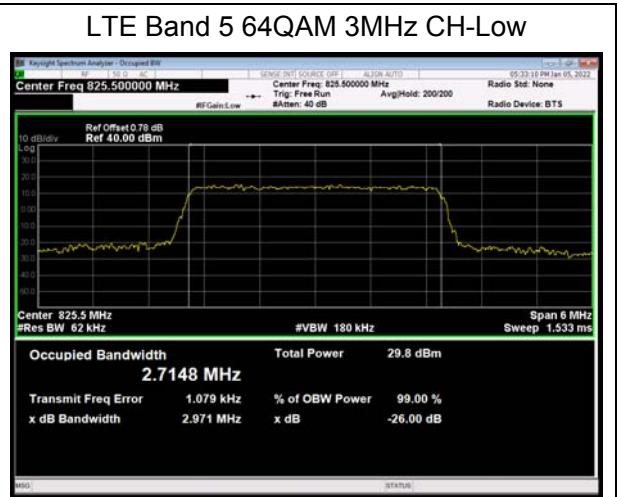
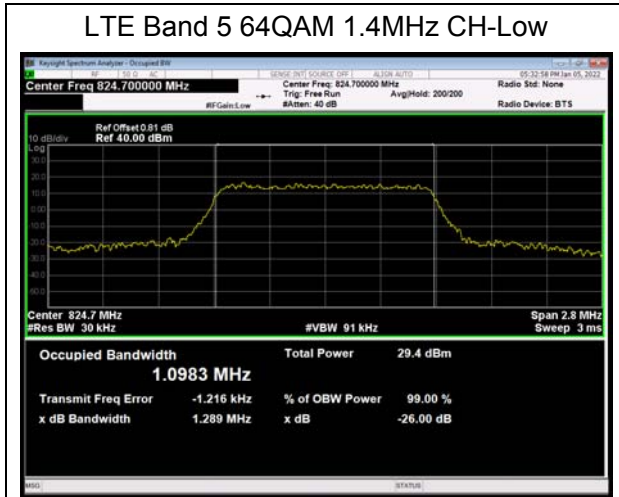

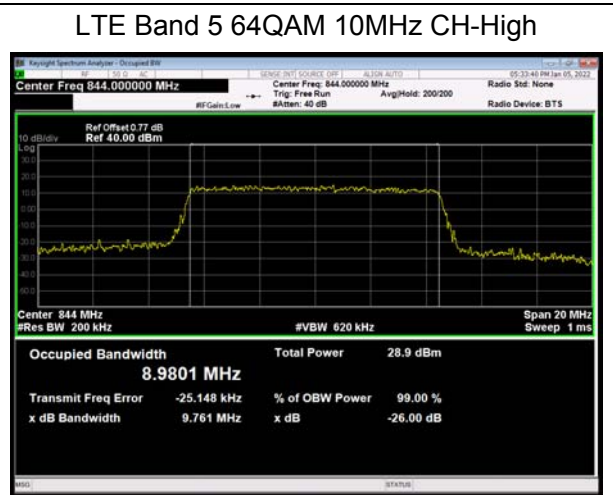
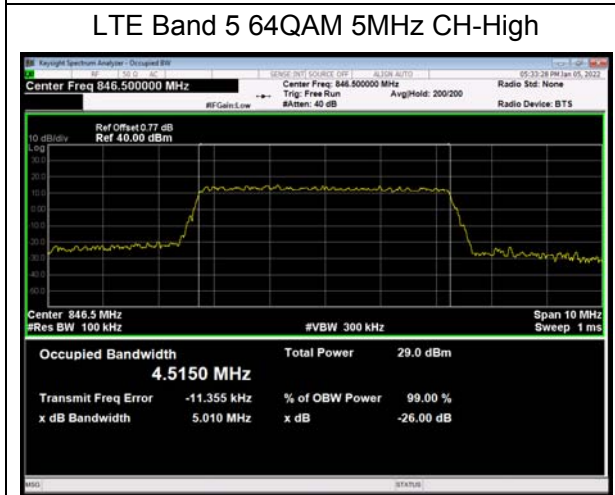
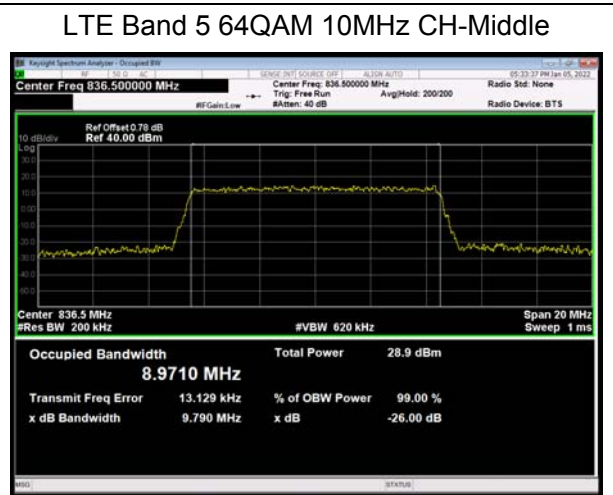
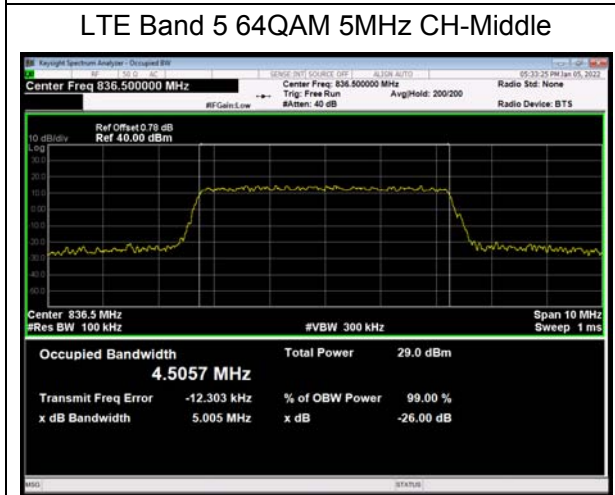
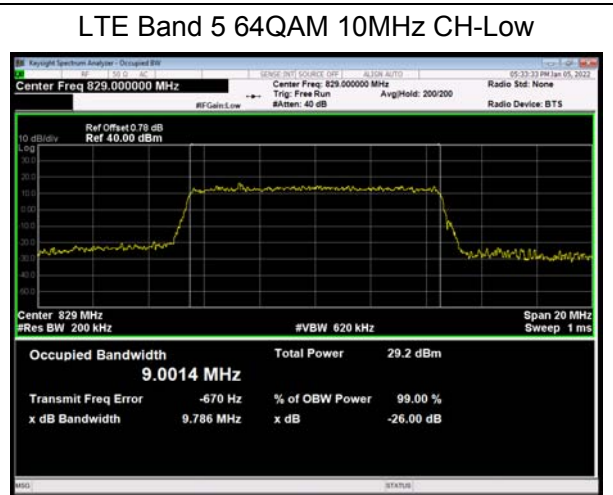
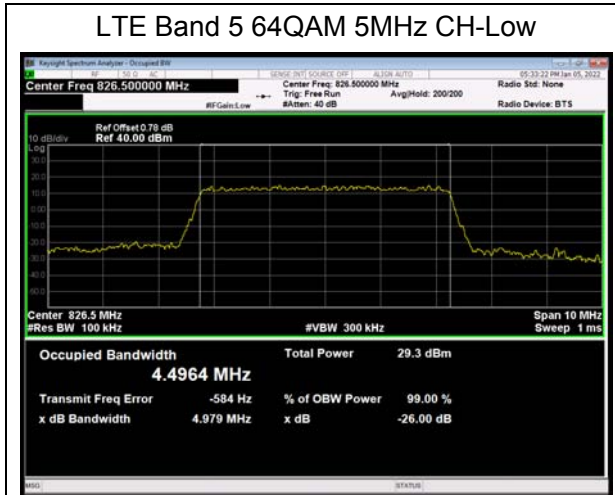

5.3. Band Edge Compliance

Ambient condition

Temperature	Relative humidity	Pressure
23°C ~25°C	45%~50%	101.5kPa

Method of Measurement

The EUT was connected to Spectrum Analyzer and Base Station Simulator via power Splitter. The band edge of the lowest and highest channels were measured. The average detector is used. RBW is set to $\geq 1\%EBW$, VBW is set to 3x RBW.

Spectrum analyzer plots are included on the following pages.

Test Setup

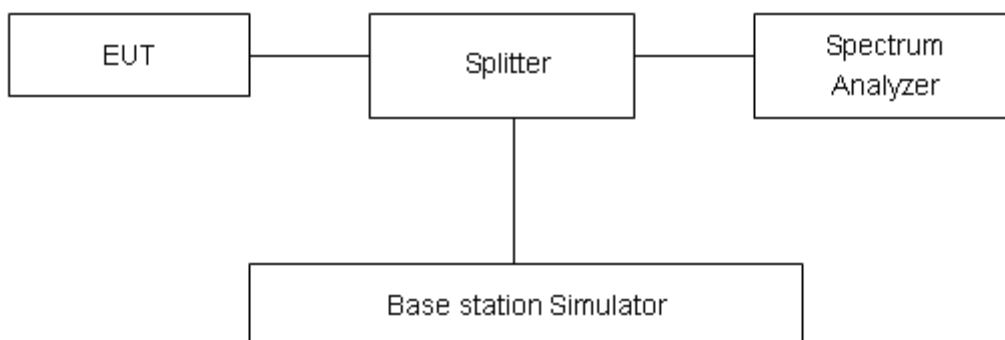

Limits

Rule Part 22.917(a) specifies that “The power of any emission outside of the authorized operating frequency ranges must be attenuated below the transmitting power (P) by a factor of at least 43 + 10 log(P) dB.”

Limit	-13 dBm
-------	---------

Measurement Uncertainty

The assessed measurement uncertainty to ensure 95% confidence level for the normal distribution is with the coverage factor $k = 1.96$, $U=0.684dB$.

Test Result:

GSM 850 CH-Low



GSM 850 CH-High



GSM 850 GPRS CH-Low

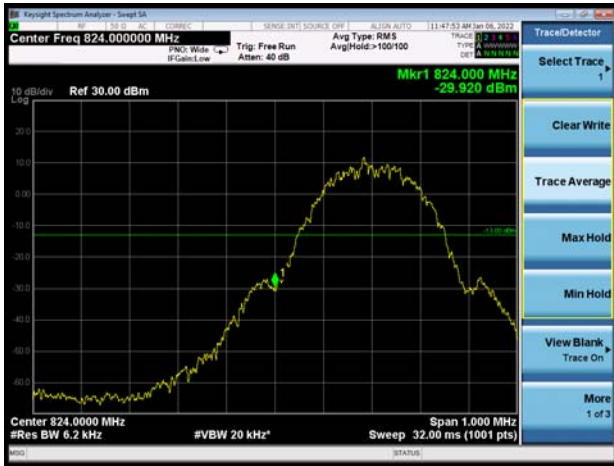

GSM 850 GPRS CH-High

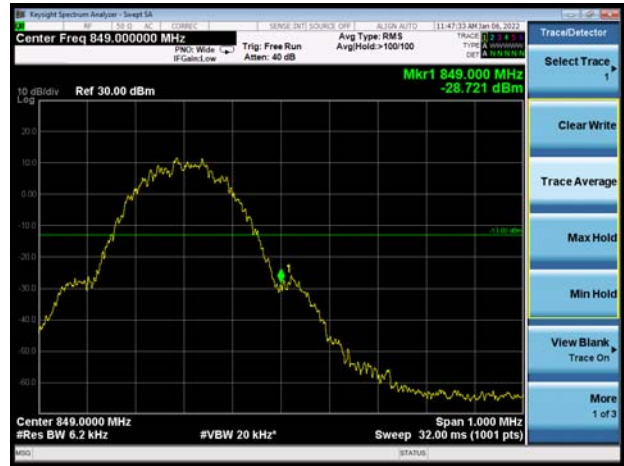

GSM 850 EGPRS CH-Low



GSM 850 EGPRS CH-High





WCDMA Band V CH-Low

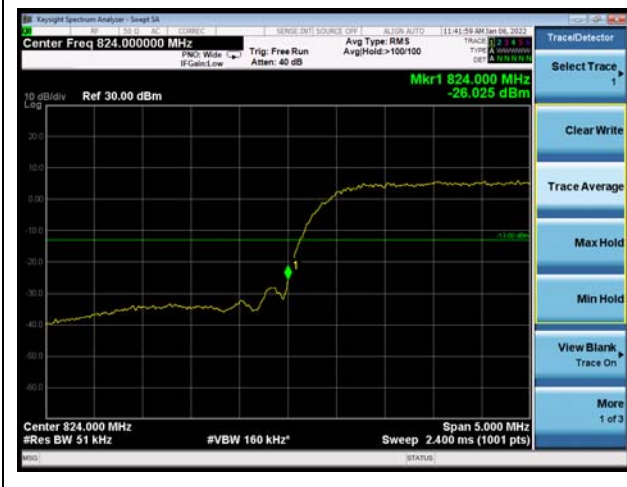

WCDMA Band V CH-High





LTE Band 5 QPSK 1.4MHz CH-Low 1RB

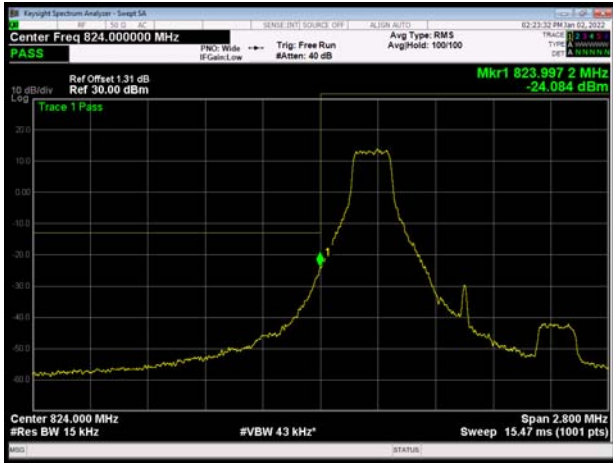

LTE Band 5 QPSK 1.4MHz CH-High 1RB

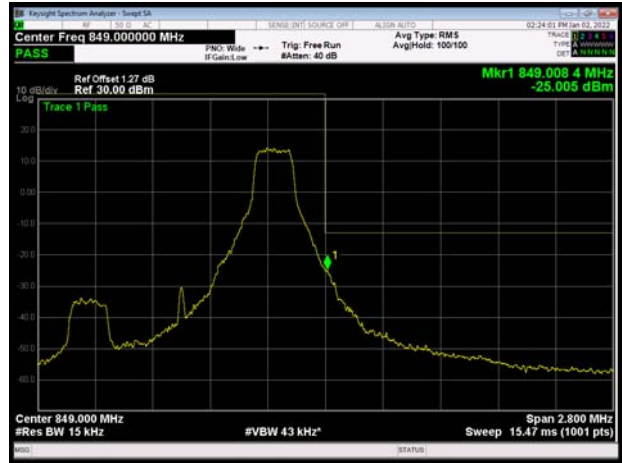

LTE Band 5 QPSK 1.4MHz CH-Low 100%RB

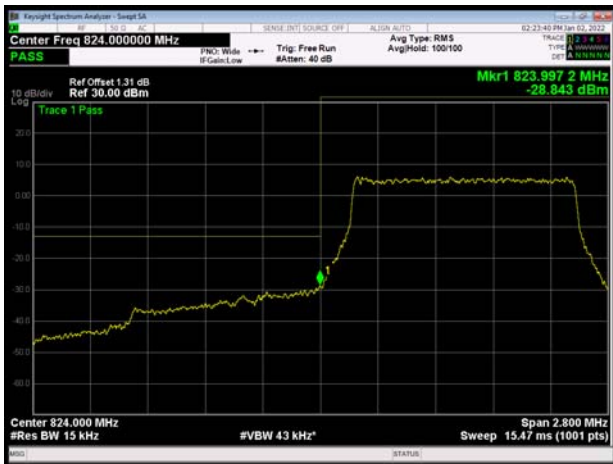

LTE Band 5 QPSK 1.4MHz CH-High 100%RB



LTE Band 5 QPSK 3MHz CH-Low 1RB

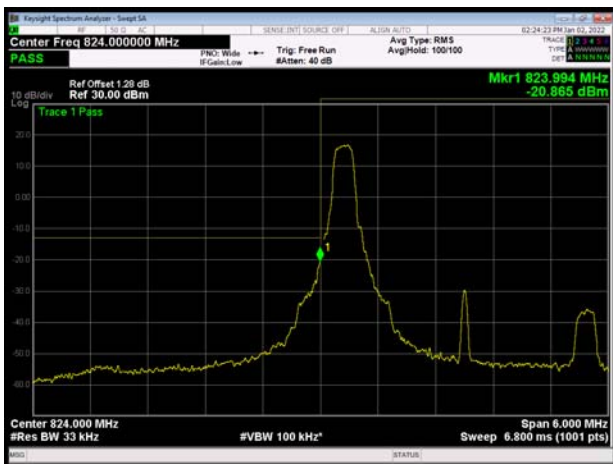

LTE Band 5 QPSK 3MHz CH-High 1RB

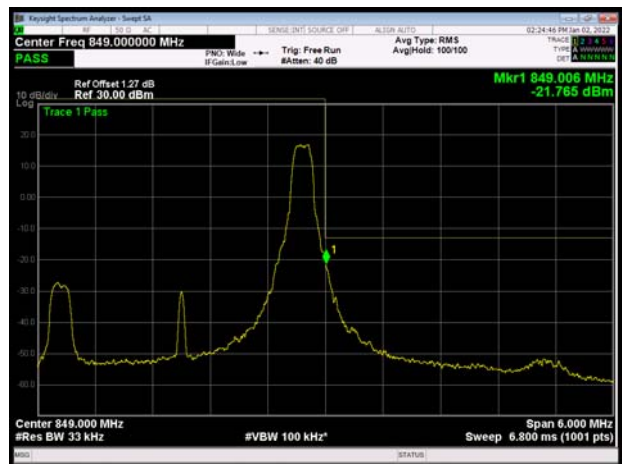

LTE Band 5 QPSK 3MHz CH-Low 100%RB

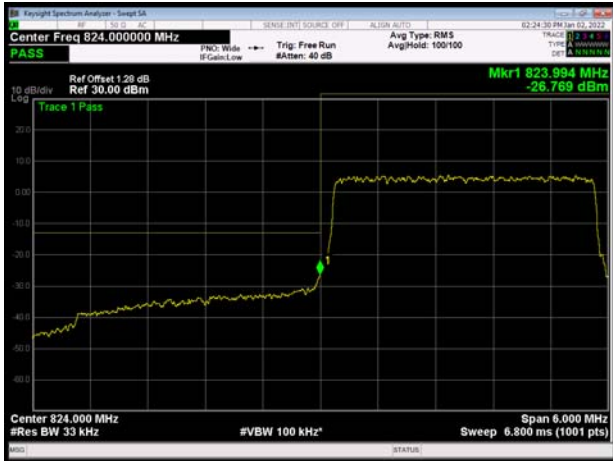

LTE Band 5 QPSK 3MHz CH-High 100%RB

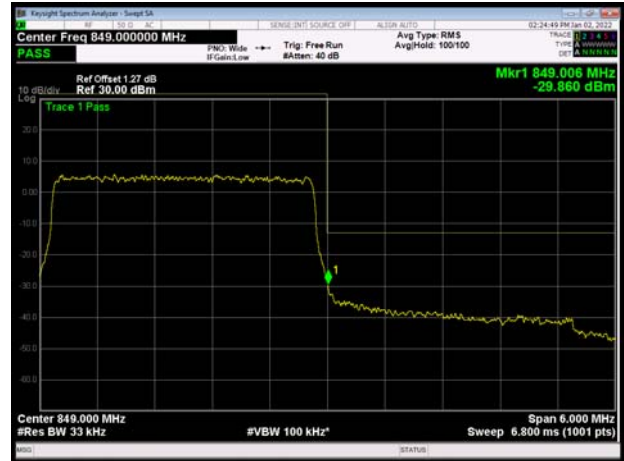

LTE Band 5 QPSK 5MHz CH-Low 1RB

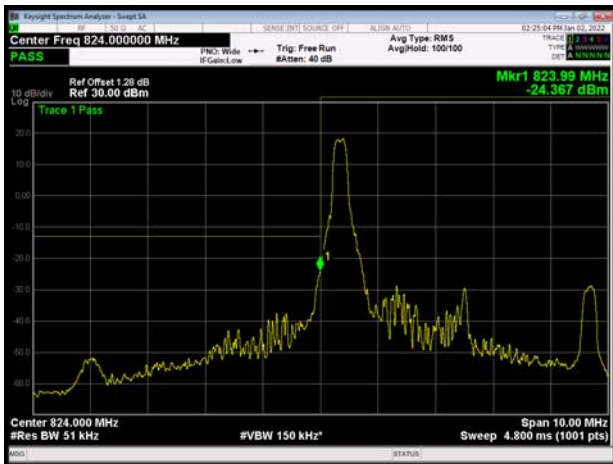

LTE Band 5 QPSK 5MHz CH-High 1RB

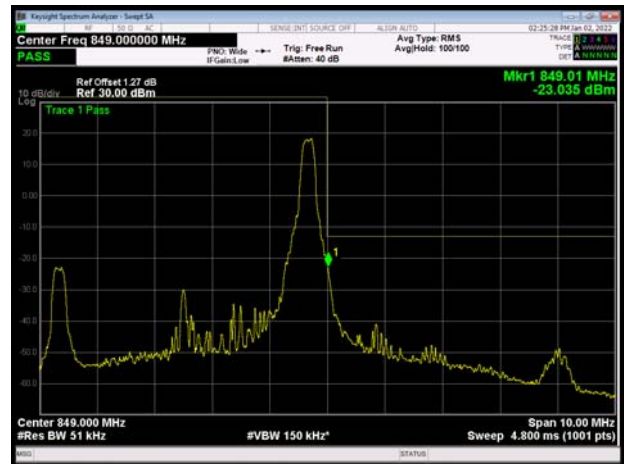

LTE Band 5 QPSK 5MHz CH-Low 100%RB

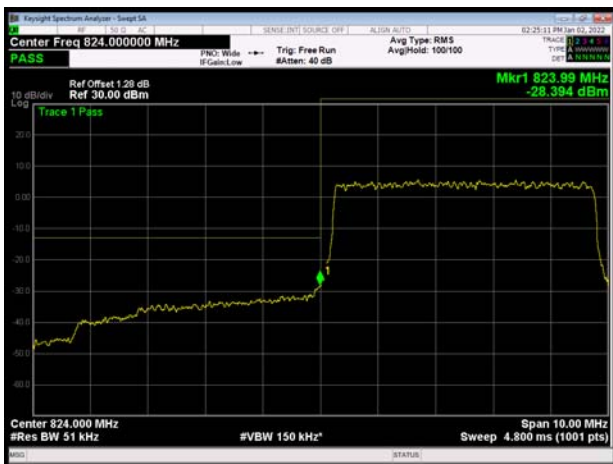

LTE Band 5 QPSK 5MHz CH-High 100%RB

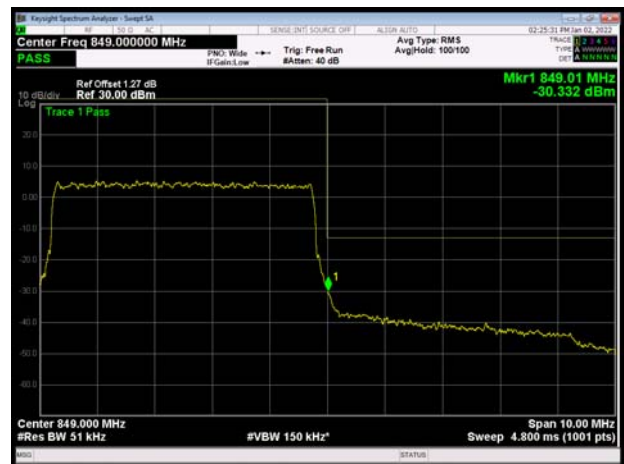

LTE Band 5 QPSK 10MHz CH-Low 1RB

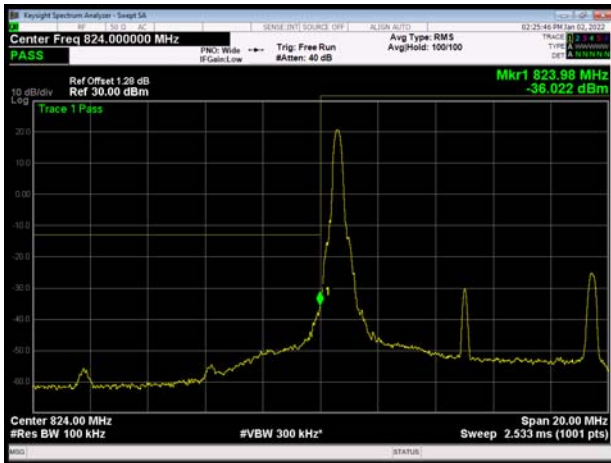

LTE Band 5 QPSK 10MHz CH-High 1RB

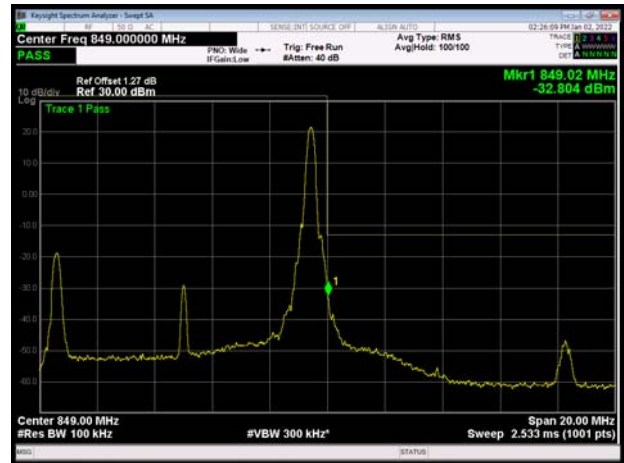

LTE Band 5 QPSK 10MHz CH-Low 100%RB

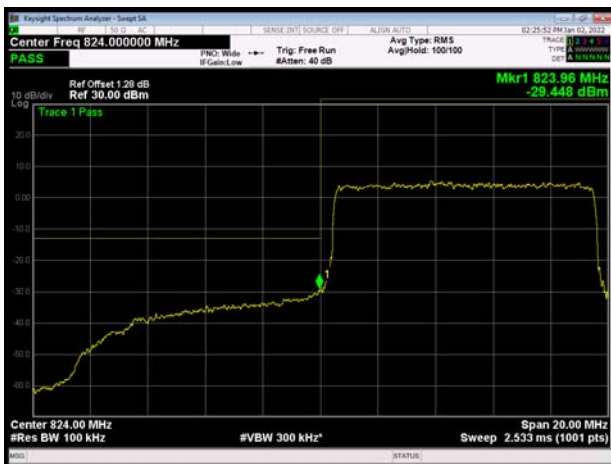

LTE Band 5 QPSK 10MHz CH-High 100%RB

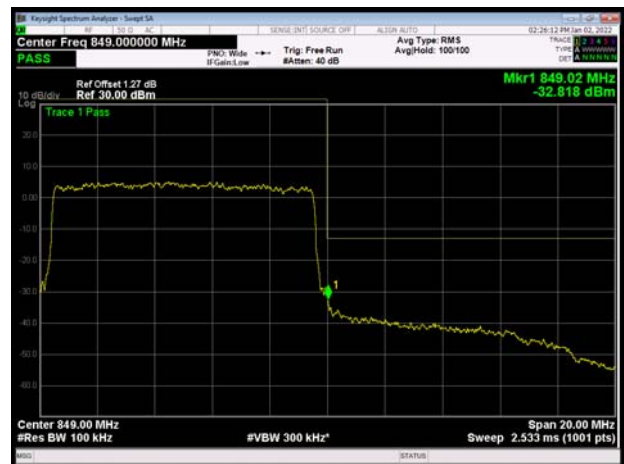

LTE Band 5 16QAM 1.4MHz CH-Low 1RB

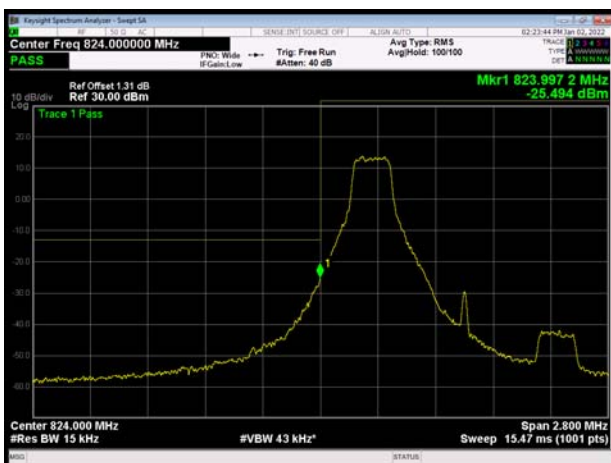

LTE Band 5 16QAM 1.4MHz CH-High 1RB

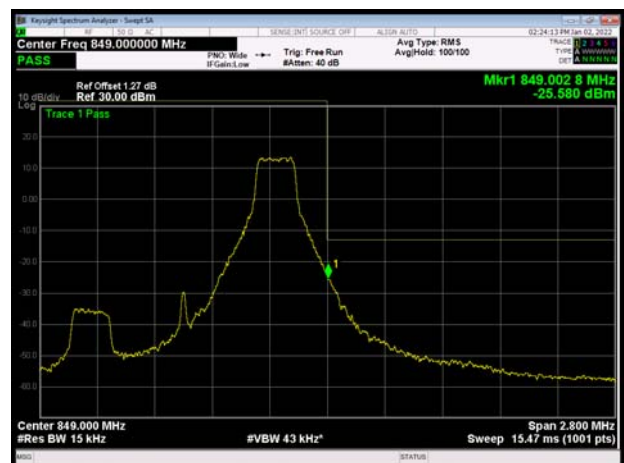



LTE Band 5 16QAM 1.4MHz CH-Low 100%RB

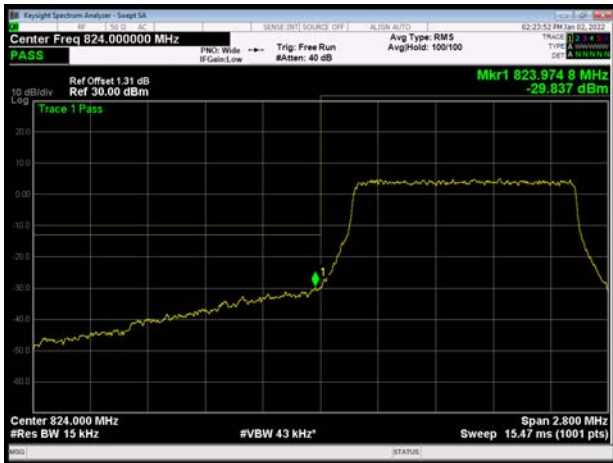

LTE Band 5 16QAM 1.4MHz CH-High 100%RB



LTE Band 5 16QAM 3MHz CH-Low 1RB

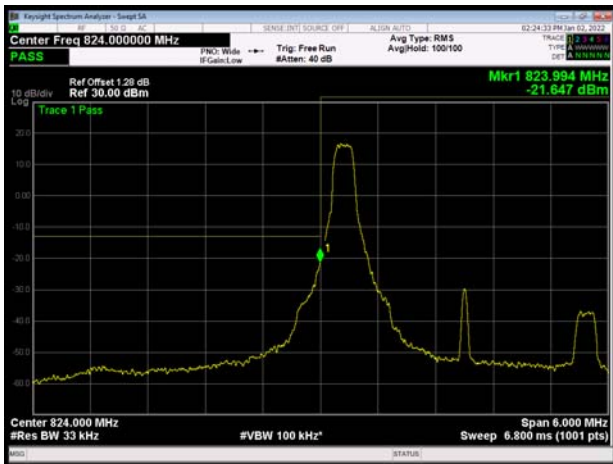

LTE Band 5 16QAM 3MHz CH-High 1RB

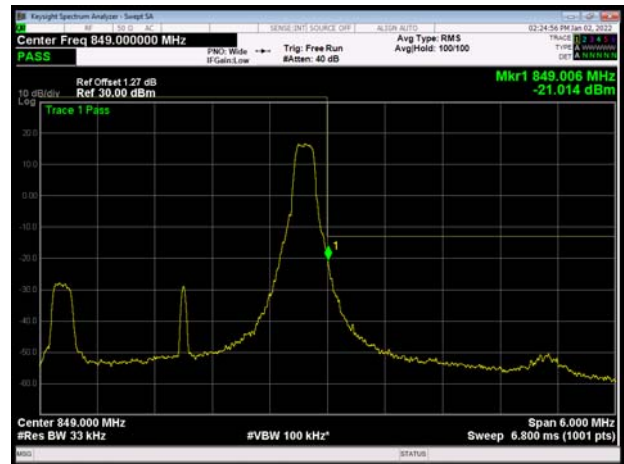

LTE Band 5 16QAM 3MHz CH-Low 100%RB



LTE Band 5 16QAM 3MHz CH-High 100%RB

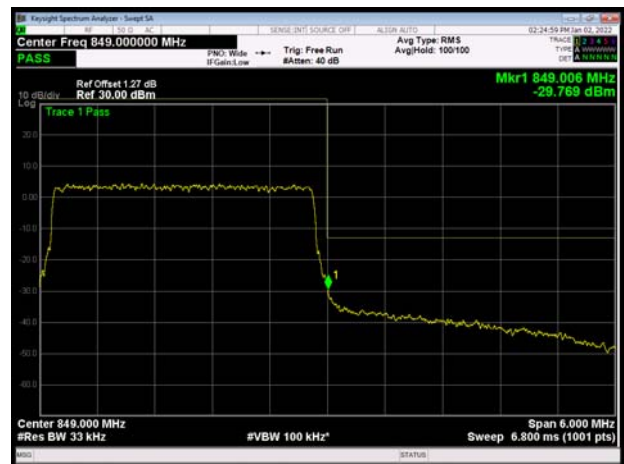

LTE Band 5 16QAM 5MHz CH-Low 1RB

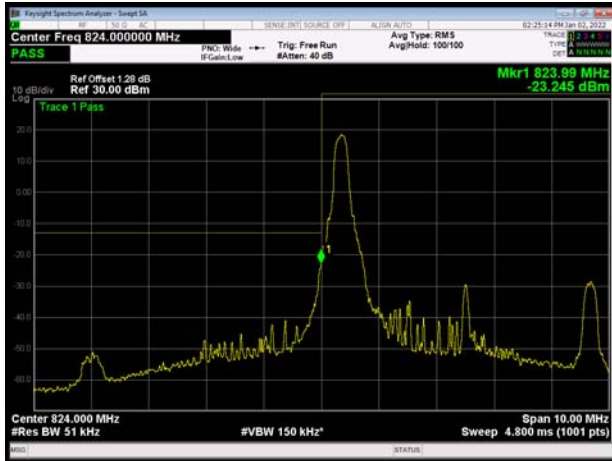

LTE Band 5 16QAM 5MHz CH-High 1RB

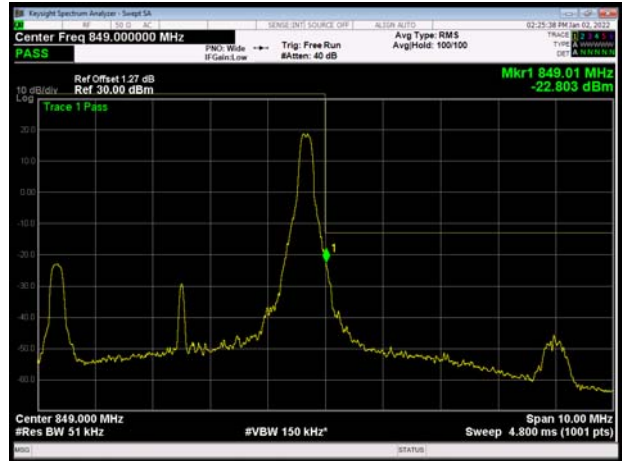

LTE Band 5 16QAM 5MHz CH-Low 100%RB

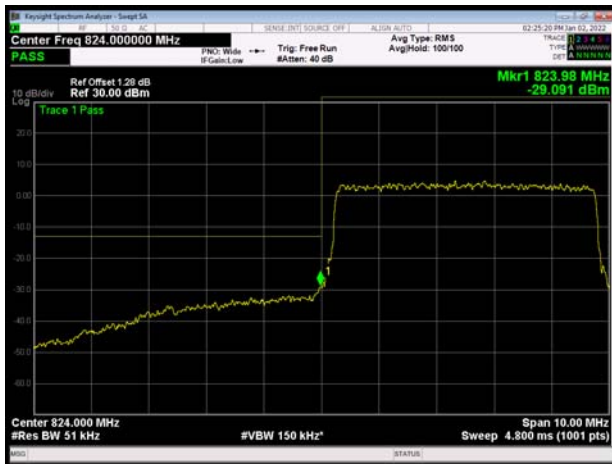

LTE Band 5 16QAM 5MHz CH-High 100%RB

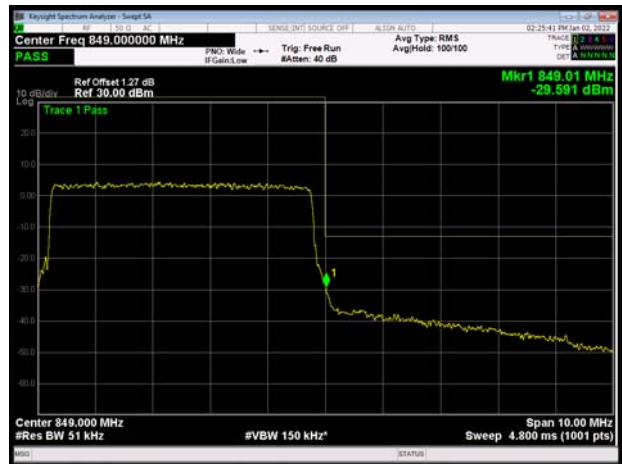

LTE Band 5 16QAM 10MHz CH-Low 1RB

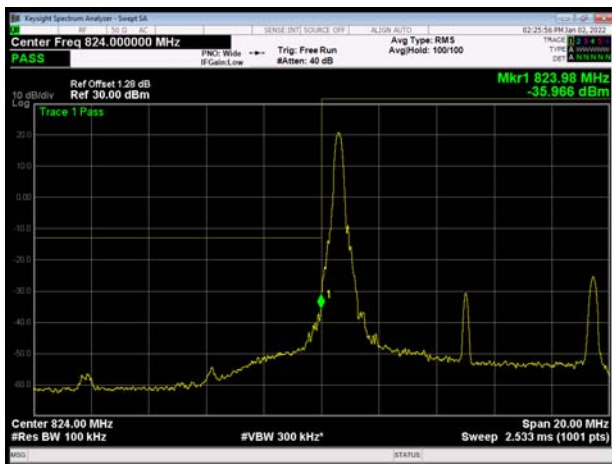

LTE Band 5 16QAM 10MHz CH-High 1RB

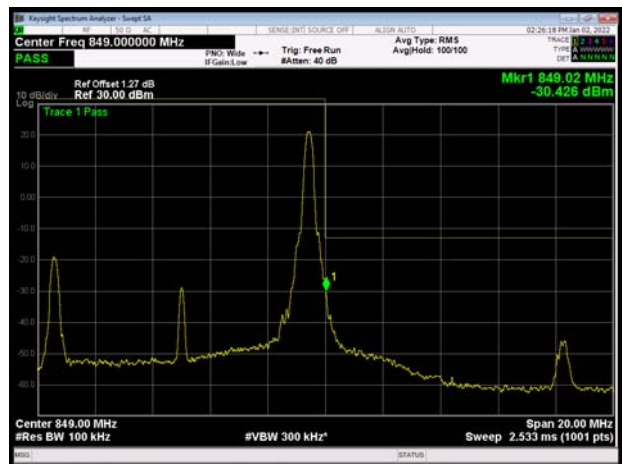



LTE Band 5 16QAM 10MHz CH-Low 100%RB

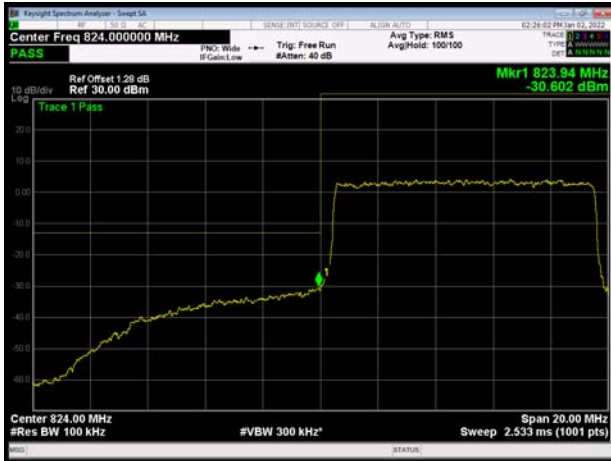

LTE Band 5 16QAM 10MHz CH-High 100%RB



LTE Band 5 64QAM 1.4MHz CH-Low 1RB

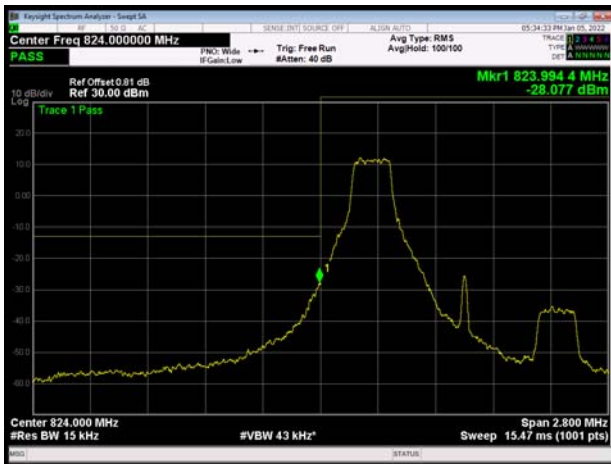

LTE Band 5 64QAM 1.4MHz CH-High 1RB

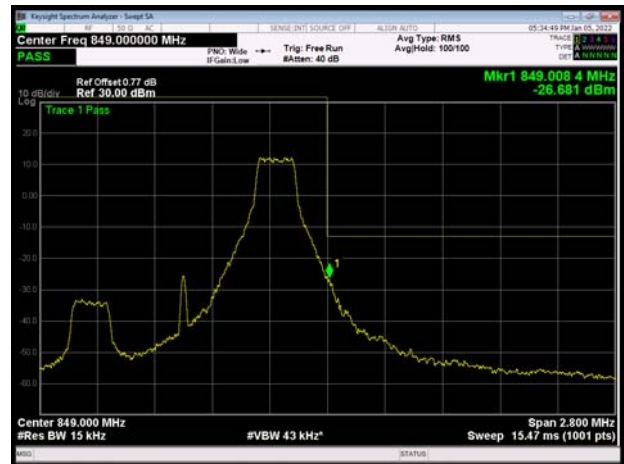

LTE Band 5 64QAM 1.4MHz CH-Low 100%RB

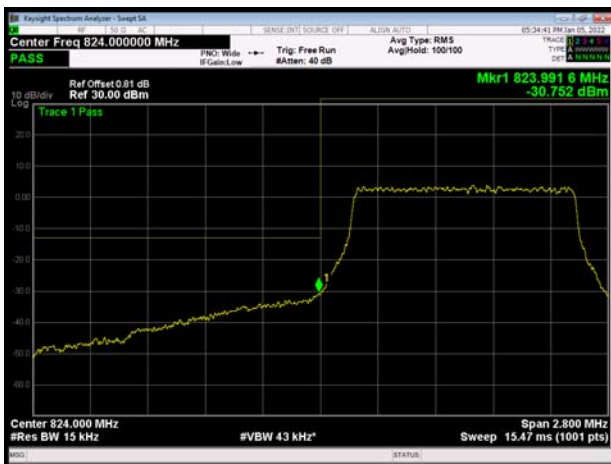

LTE Band 5 64QAM 1.4MHz CH-High 100%RB



LTE Band 5 64QAM 3MHz CH-Low 1RB

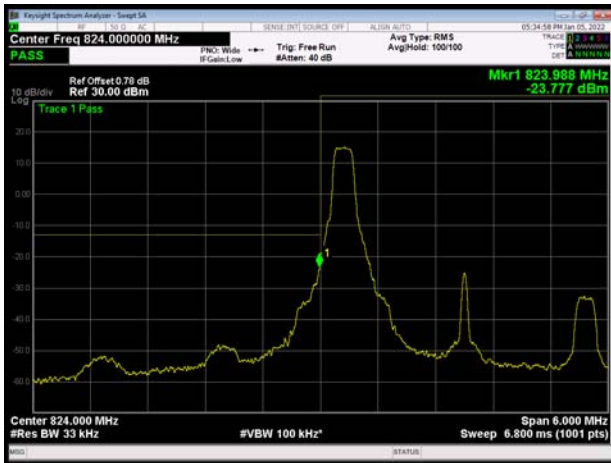

LTE Band 5 64QAM 3MHz CH-High 1RB

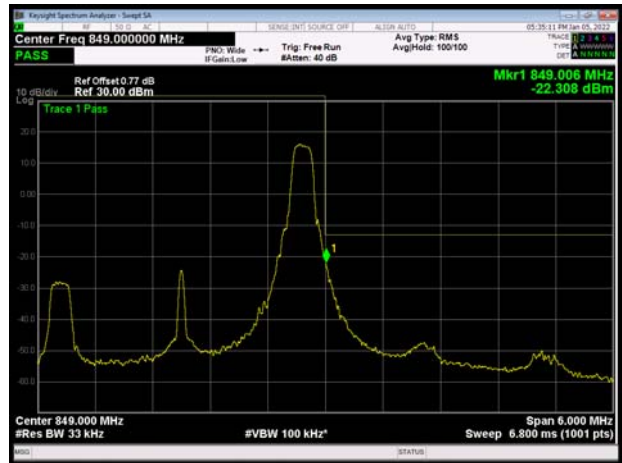

LTE Band 5 64QAM 3MHz CH-Low 100%RB

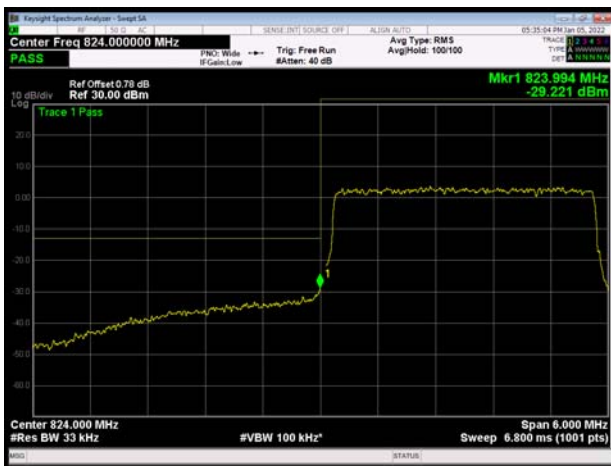

LTE Band 5 64QAM 3MHz CH-High 100%RB

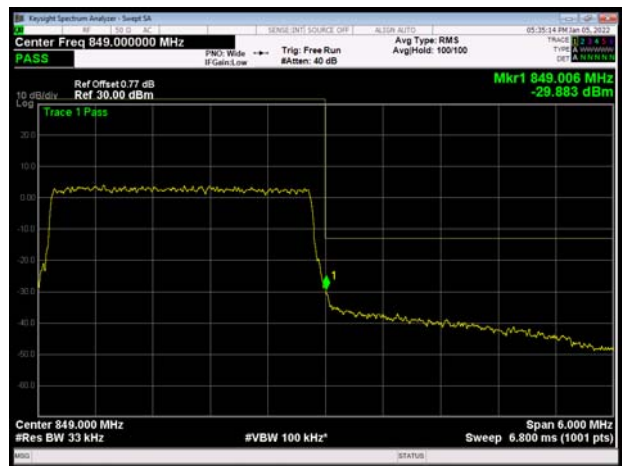

LTE Band 5 64QAM 5MHz CH-Low 1RB

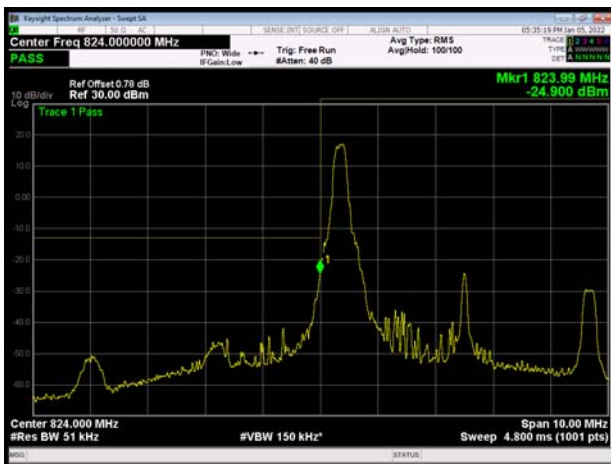

LTE Band 5 64QAM 5MHz CH-High 1RB

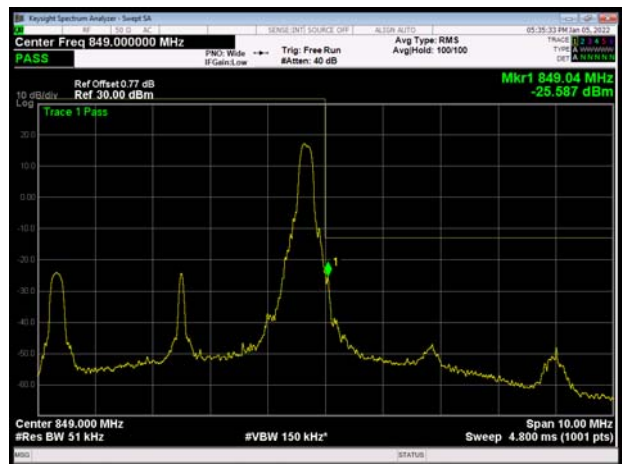



LTE Band 5 64QAM 5MHz CH-Low 100%RB

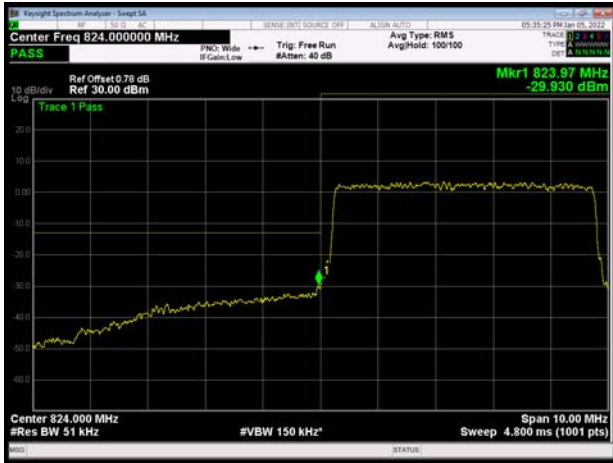

LTE Band 5 64QAM 5MHz CH-High 100%RB

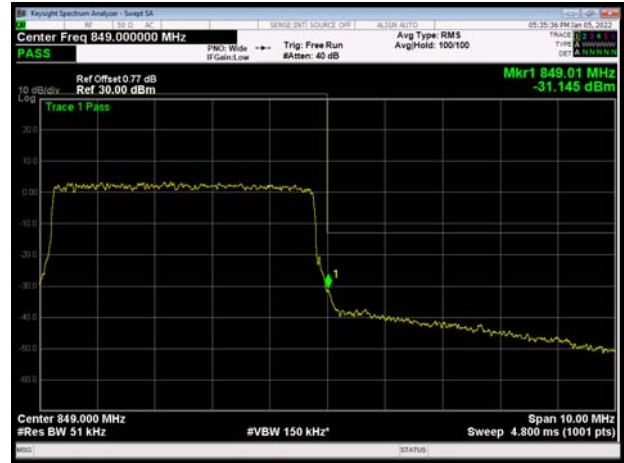

LTE Band 5 64QAM 10MHz CH-Low 1RB

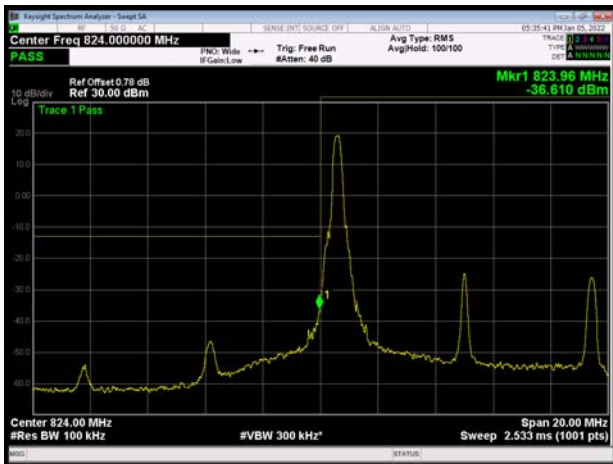

LTE Band 5 64QAM 10MHz CH-High 1RB

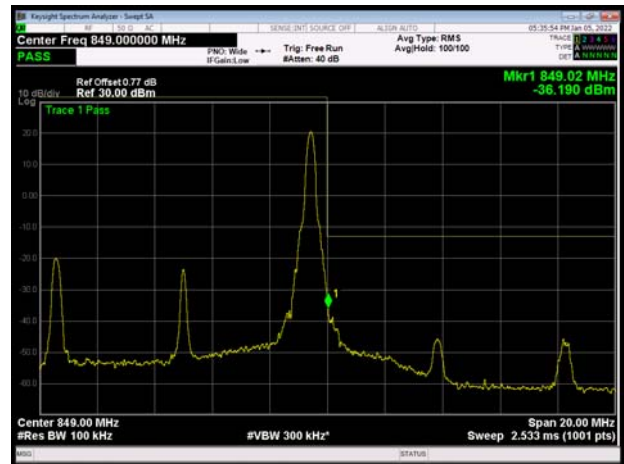

LTE Band 5 64QAM 10MHz CH-Low 100%RB

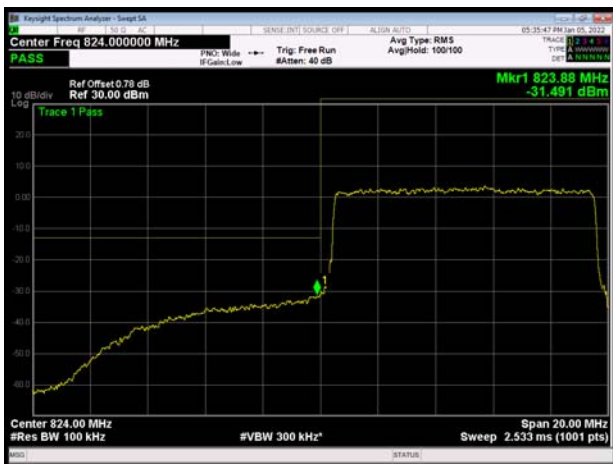

LTE Band 5 64QAM 10MHz CH-High 100%RB

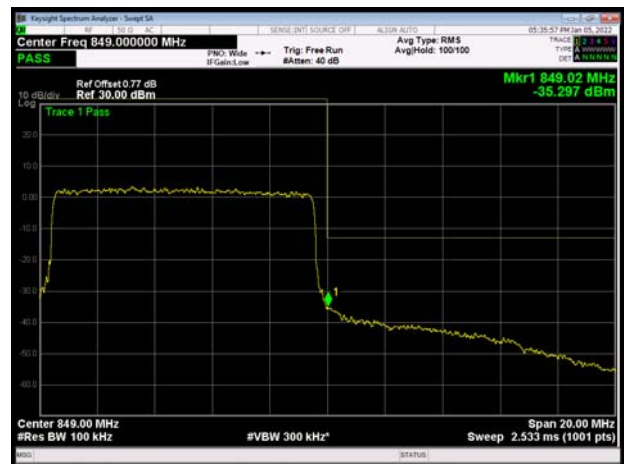

5.4. Peak-to-Average Power Ratio (PAPR)

Ambient condition

Temperature	Relative humidity	Pressure
23°C ~25°C	45%~50%	101.5kPa

Methods of Measurement

Measure the total peak power and record as P_{Pk} . And measure the total average power and record as P_{Avg} . Both the peak and average power levels must be expressed in the same logarithmic units (e.g., dBm). Determine the PAPR from:

$$PAPR (dB) = P_{Pk} (dBm) - P_{Avg} (dBm).$$

Test Setup

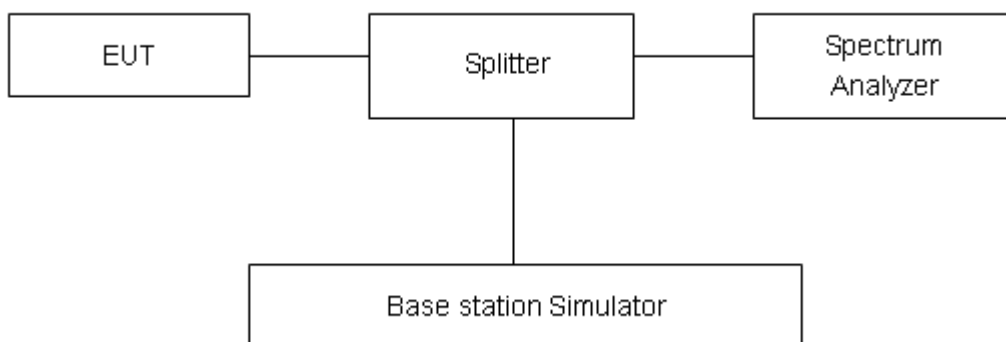

Limits

According to the Sec. 22.913(d), The peak-to-average ratio (PAR) of the transmission must not exceed 13 dB.

Measurement Uncertainty

The assessed measurement uncertainty to ensure 95% confidence level for the normal distribution is with the coverage factor $k = 2$, $U = 0.4$ dB.

Test Results

Mode	Channel	Frequency (MHz)	Peak (dBm)	Avg (dBm)	PAPR (dB)	Limit (dB)	Conclusion
GSM 850 (GMSK)	128	824.2	31.82	29.07	2.75	≤13	PASS
	190	836.6	31.93	29.17	2.76	≤13	PASS
	251	848.8	32.09	29.30	2.79	≤13	PASS
GPRS 850 (GMSK)	128	824.2	31.90	29.16	2.74	≤13	PASS
	190	836.6	32.01	29.24	2.77	≤13	PASS
	251	848.8	32.14	29.35	2.79	≤13	PASS
EGPRS 850 (8PSK)	128	824.2	29.27	23.40	5.87	≤13	PASS
	190	836.6	29.26	23.42	5.84	≤13	PASS
	251	848.8	29.31	23.47	5.84	≤13	PASS
WCDMA Band V (RMC)	4132	826.4	26.17	23.16	3.01	≤13	PASS
	4183	836.6	25.94	23.05	2.89	≤13	PASS
	4233	846.6	26.22	23.20	3.02	≤13	PASS

LTE Band 5								
Modulation	Bandwidth (MHz)	Channel	Frequency (MHz)	Peak (dBm)	Avg (dBm)	PAPR (dB)	Limit (dB)	Conclusion
QPSK	1.4	20407	824.7	28.16	23.27	4.89	≤13	PASS
		20525	836.5	27.59	23.06	4.53	≤13	PASS
		20643	848.3	28.10	23.08	5.02	≤13	PASS
	3	20415	825.5	28.32	23.15	5.17	≤13	PASS
		20525	836.5	27.62	23.05	4.57	≤13	PASS
		20635	847.5	28.26	23.18	5.08	≤13	PASS
	5	20425	826.5	28.39	23.13	5.26	≤13	PASS
		20525	836.5	27.66	23.02	4.64	≤13	PASS
		20625	846.5	28.15	23.06	5.09	≤13	PASS
	10	20450	829	28.36	23.15	5.21	≤13	PASS
		20525	836.5	27.90	23.10	4.80	≤13	PASS
		20600	844	28.00	22.99	5.01	≤13	PASS
16QAM	1.4	20407	824.7	28.04	22.28	5.76	≤13	PASS
		20525	836.5	27.48	22.05	5.43	≤13	PASS
		20643	848.3	27.91	21.83	6.08	≤13	PASS
	3	20415	825.5	28.16	22.17	5.99	≤13	PASS
		20525	836.5	27.56	22.06	5.50	≤13	PASS



	5	20635	847.5	28.12	22.16	5.96	≤13	PASS	
		20425	826.5	28.25	22.29	5.96	≤13	PASS	
		20525	836.5	27.52	22.05	5.47	≤13	PASS	
		20625	846.5	28.06	22.13	5.93	≤13	PASS	
	10	20450	829	28.11	22.04	6.07	≤13	PASS	
		20525	836.5	27.78	22.12	5.66	≤13	PASS	
		20600	844	27.95	22.13	5.82	≤13	PASS	
	64QAM	1.4	20407	824.7	27.03	21.48	5.55	≤13	PASS
			20525	836.5	26.50	20.99	5.51	≤13	PASS
20643			848.3	27.13	21.05	6.08	≤13	PASS	
3		20415	825.5	27.07	21.08	5.99	≤13	PASS	
		20525	836.5	26.53	20.93	5.60	≤13	PASS	
		20635	847.5	27.15	21.11	6.04	≤13	PASS	
5		20425	826.5	27.22	21.22	6.00	≤13	PASS	
		20525	836.5	26.61	21.19	5.42	≤13	PASS	
		20625	846.5	27.07	21.12	5.95	≤13	PASS	
10		20450	829	27.36	21.32	6.04	≤13	PASS	
		20525	836.5	26.81	21.06	5.75	≤13	PASS	
		20600	844	26.76	20.83	5.93	≤13	PASS	

5.5. Frequency Stability

Ambient condition

Temperature	Relative humidity	Pressure
23°C ~25°C	45%~50%	101.5kPa

Method of Measurement

Frequency Stability (Temperature Variation)

The temperature inside the climate chamber is varied from -30°C to +50°C in 10°C step size,

(1) With all power removed, the temperature was decreased to 0°C and permitted to stabilize for three hours.

(2) Measure the carrier frequency with the test equipment in a “call mode”. These measurements should be made within 1 minute of powering up the mobile station, to prevent significant self warming.

(3) Repeat the above measurements at 10°C increments from -30°C to +50°C. Allow at least 1.5 hours at each temperature, un-powered, before making measurements. Frequency Stability (Voltage Variation)

The frequency stability shall be measured with variation of primary supply voltage as follows:

Primary Supply Voltage: The primary supply voltage is varied from 85% to 115% of the nominal value for non hand-carried battery and AC powered equipment. For hand-carried, battery-powered equipment, primary supply voltage is reduced to the battery operating end point which shall be specified by the manufacturer.

This transceiver is specified to operate with an input voltage of between 3.6 V and 4.2 V, with a nominal voltage of 3.87V.

Test setup

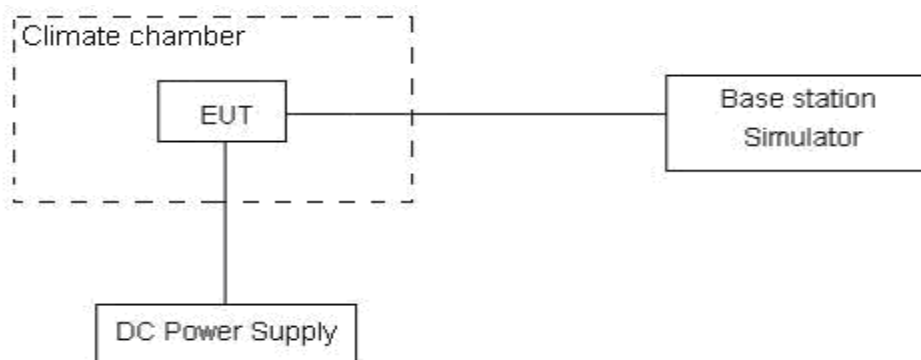

Limits

According to the Sec. 22.355, the frequency stability of the carrier shall be accurate to within 2.5 ppm of the received frequency for mobile stations.

Limits	≤ 2.5 ppm
--------	-----------

Measurement Uncertainty

The assessed measurement uncertainty to ensure 99.75% confidence level for the normal distribution is with the coverage factor $k = 3$, $U = 0.01\text{ppm}$.

Test Result

GSM850						
Condition		Freq.Error (Hz)	Freq.Error (Hz)	Frequency Stability (ppm)	Frequency Stability (ppm)	Verdict
Temperature	Voltage	GMSK	8PSK	GMSK	8PSK	
Normal (25°C)	Normal	7.57	2.90	0.00905	0.00347	PASS
Extreme (50°C)		13.65	13.30	0.01631	0.01589	PASS
Extreme (40°C)		14.64	2.27	0.01750	0.00272	PASS
Extreme (30°C)		11.96	16.91	0.01430	0.02021	PASS
Extreme (20°C)		10.34	8.57	0.01236	0.01025	PASS
Extreme (10°C)		5.67	2.63	0.00678	0.00315	PASS
Extreme (0°C)		13.82	12.87	0.01652	0.01538	PASS
Extreme (-10°C)		1.40	4.74	0.00167	0.00567	PASS
Extreme (-20°C)		8.31	17.95	0.00994	0.02145	PASS
Extreme (-30°C)		16.73	3.07	0.01999	0.00367	PASS
25°C	LV	9.83	4.10	0.01175	0.00490	PASS
	HV	11.39	12.92	0.01361	0.01544	PASS

WCDMA Band V						
Condition		Freq.Error (Hz)	Freq.Error (Hz)	Frequency Stability (ppm)	Frequency Stability (ppm)	Verdict
Temperature	Voltage	BPSK	QPSK	BPSK	QPSK	
Normal (25°C)	Normal	10.33	12.62	0.01235	0.01509	PASS
Extreme (50°C)		4.30	14.04	0.00514	0.01679	PASS
Extreme (40°C)		17.03	9.29	0.02036	0.01111	PASS
Extreme (30°C)		17.96	3.28	0.02146	0.00392	PASS
Extreme (20°C)		14.58	5.08	0.01743	0.00607	PASS
Extreme (10°C)		1.84	5.22	0.00221	0.00624	PASS
Extreme (0°C)		16.61	9.18	0.01985	0.01098	PASS
Extreme (-10°C)		4.26	9.05	0.00509	0.01082	PASS
Extreme (-20°C)		9.70	8.09	0.01159	0.00966	PASS
Extreme (-30°C)		9.79	1.77	0.01171	0.00212	PASS
25°C	LV	11.89	12.35	0.01421	0.01476	PASS
	HV	11.10	11.01	0.01326	0.01317	PASS



LTE Band 5								
Condition		Freq.Error (Hz)	Freq.Error (Hz)	Freq.Error (Hz)	Frequency Stability (ppm)	Frequency Stability (ppm)	Frequency Stability (ppm)	Verdict
BANDWIDTH	1.4MHz							
Temperature	Voltage	64QAM	16QAM	QPSK	64QAM	16QAM	QPSK	
Normal (25°C)	Normal	15.33	13.39	15.08	0.01832	0.01601	0.01803	PASS
Extreme (50°C)		15.81	12.21	15.88	0.01890	0.01460	0.01899	PASS
Extreme (40°C)		1.65	4.98	11.26	0.00198	0.00596	0.01346	PASS
Extreme (30°C)		1.80	12.66	9.07	0.00216	0.01514	0.01085	PASS
Extreme (20°C)		6.54	4.51	7.61	0.00782	0.00539	0.00910	PASS
Extreme (10°C)		15.70	7.02	13.93	0.01877	0.00839	0.01665	PASS
Extreme (0°C)		15.52	13.85	10.86	0.01856	0.01655	0.01298	PASS
Extreme (-10°C)		13.77	1.43	5.60	0.01647	0.00171	0.00670	PASS
Extreme (-20°C)		9.72	14.77	8.64	0.01162	0.01766	0.01032	PASS
Extreme (-30°C)		14.91	9.13	8.67	0.01783	0.01091	0.01036	PASS
25°C	LV	13.60	16.69	14.73	0.01625	0.01995	0.01761	PASS
	HV	17.79	11.34	14.23	0.02127	0.01356	0.01701	PASS
Condition		Freq.Error (Hz)	Freq.Error (Hz)	Freq.Error (Hz)	Frequency Stability (ppm)	Frequency Stability (ppm)	Frequency Stability (ppm)	Verdict
BANDWIDTH	3MHz							
Temperature	Voltage	64QAM	16QAM	QPSK	64QAM	16QAM	QPSK	
Normal (25°C)	Normal	5.29	6.38	9.84	0.00632	0.00762	0.01177	PASS
Extreme (50°C)		5.38	14.32	5.30	0.00644	0.01712	0.00634	PASS
Extreme (40°C)		2.64	6.35	2.64	0.00315	0.00759	0.00315	PASS
Extreme (30°C)		5.89	7.54	8.43	0.00705	0.00902	0.01008	PASS
Extreme (20°C)		7.20	4.20	8.30	0.00861	0.00502	0.00992	PASS
Extreme (10°C)		1.03	3.26	10.32	0.00123	0.00389	0.01233	PASS
Extreme (0°C)		2.31	14.35	10.61	0.00276	0.01715	0.01269	PASS
Extreme (-10°C)		7.14	3.62	16.68	0.00854	0.00433	0.01995	PASS
Extreme (-20°C)		17.26	14.62	14.67	0.02063	0.01748	0.01754	PASS
Extreme (-30°C)		17.14	16.52	13.84	0.02049	0.01975	0.01654	PASS
25°C	LV	6.54	9.29	7.86	0.00782	0.01111	0.00939	PASS
	HV	12.84	17.19	3.50	0.01535	0.02055	0.00418	PASS
Condition		Freq.Error (Hz)	Freq.Error (Hz)	Freq.Error (Hz)	Frequency Stability (ppm)	Frequency Stability (ppm)	Frequency Stability (ppm)	Verdict
BANDWIDTH	5MHz							
Temperature	Voltage	64QAM	16QAM	QPSK	64QAM	16QAM	QPSK	
Normal (25°C)	Normal	13.95	2.60	10.43	0.01668	0.00311	0.01247	PASS
Extreme (50°C)		8.61	2.40	10.75	0.01029	0.00287	0.01285	PASS
Extreme (40°C)		17.31	12.14	4.37	0.02069	0.01451	0.00523	PASS
Extreme (30°C)		6.29	1.11	15.05	0.00752	0.00133	0.01799	PASS
Extreme (20°C)		10.57	5.71	3.84	0.01264	0.00682	0.00459	PASS



Extreme (10°C)		7.64	12.77	17.80	0.00914	0.01527	0.02128	PASS
Extreme (0°C)		15.78	5.03	15.94	0.01886	0.00601	0.01905	PASS
Extreme (-10°C)		16.79	3.83	8.91	0.02007	0.00457	0.01065	PASS
Extreme (-20°C)		10.92	17.15	14.88	0.01306	0.02050	0.01779	PASS
Extreme (-30°C)		5.42	4.11	14.57	0.00648	0.00492	0.01742	PASS
25°C	LV	7.21	3.01	8.44	0.00861	0.00360	0.01008	PASS
	HV	5.59	9.39	16.04	0.00668	0.01123	0.01918	PASS
Condition		Freq.Error (Hz)	Freq.Error (Hz)	Freq.Error (Hz)	Frequency Stability (ppm)	Frequency Stability (ppm)	Frequency Stability (ppm)	Verdict
BANDWIDTH	10MHz							
Temperature	Voltage	64QAM	16QAM	QPSK	64QAM	16QAM	QPSK	
Normal (25°C)	Normal	7.72	16.15	4.41	0.00923	0.01930	0.00527	PASS
Extreme (50°C)		15.29	4.36	9.19	0.01828	0.00521	0.01098	PASS
Extreme (40°C)		17.36	14.46	11.73	0.02075	0.01729	0.01402	PASS
Extreme (30°C)		9.21	3.08	5.31	0.01101	0.00368	0.00634	PASS
Extreme (20°C)		6.88	14.36	10.60	0.00823	0.01716	0.01267	PASS
Extreme (10°C)		17.48	17.21	8.99	0.02089	0.02057	0.01075	PASS
Extreme (0°C)		6.81	9.26	4.64	0.00814	0.01107	0.00555	PASS
Extreme (-10°C)		8.99	14.04	6.62	0.01075	0.01679	0.00791	PASS
Extreme (-20°C)		10.99	3.50	16.80	0.01314	0.00418	0.02009	PASS
Extreme (-30°C)		17.86	9.28	6.93	0.02135	0.01109	0.00829	PASS
25°C	LV	13.65	12.51	14.93	0.01632	0.01495	0.01784	PASS
	HV	14.38	11.89	7.68	0.01719	0.01421	0.00918	PASS

5.6. Spurious Emissions at Antenna Terminals

Ambient condition

Temperature	Relative humidity	Pressure
23°C ~25°C	45%~50%	101.5kPa

Method of Measurement

The EUT was connected to Spectrum Analyzer and Base Station Simulator via power Splitter. The measurement is carried out using a spectrum analyzer. The spectrum analyzer scans from 9kHz to the 10th harmonic of the carrier.

The peak detector is used. RBW are set to 100 kHz and VBW are set to 300 kHz for below 1G, RBW are set to 1MHz and VBW are set to 3MHz for above 1G, Sweep is set to ATUO.

RBW is set to 1 kHz (0.009MHz~ 0.15 MHz),

RBW is set to 10 kHz (0.15 MHz~ 30 MHz)

RBW is set to 100 kHz (30MHz~1000 MHz)

RBW is set to 1000 kHz (above 1000MHz)

The modulation mode and RB allocation refer to section 5.1, using the maximum output power configuration.

Test setup

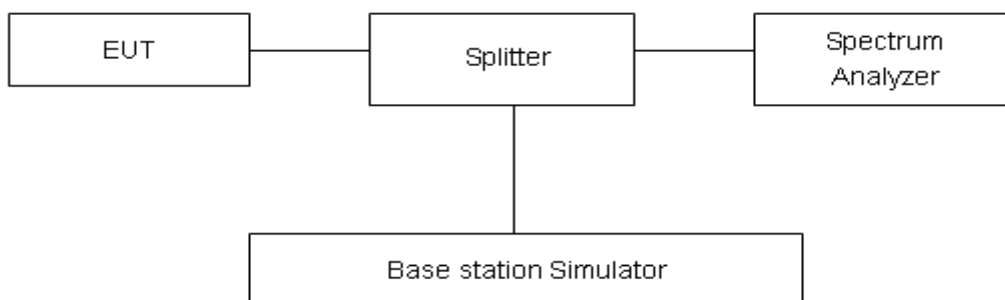

Limits

Rule Part 22.917(a) specifies that “The power of any emission outside of the authorized operating frequency ranges must be attenuated below the transmitting power (P) by a factor of at least 43 + 10 log (P) dB.”

Limit	-13 dBm

Measurement Uncertainty

The assessed measurement uncertainty to ensure 99.75% confidence level for the normal distribution is with the coverage factor $k = 1.96$.

Frequency	Uncertainty
9kHz-1GHz	0.684 dB
1GHz-20GHz	1.407 dB



Test Result

Sweep the whole frequency band through the range from 9kHz to the 10th harmonic of the carrier, the emissions more than 20 dB below the limit are not reported.

The signal beyond the limit is carrier.

GSM 850 CH-Low 9kHz ~ 20GHz

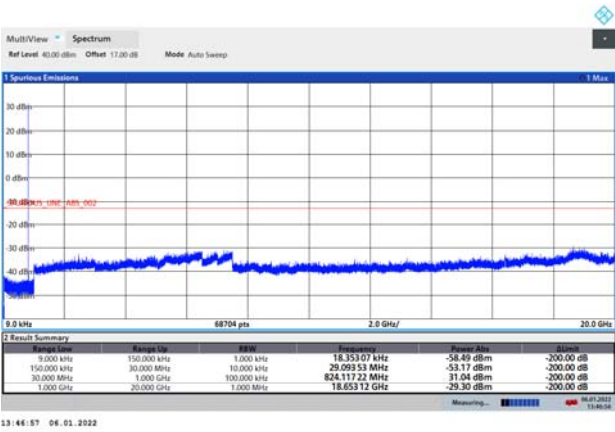

GPRS 850 CH-Low 9kHz ~ 20GHz

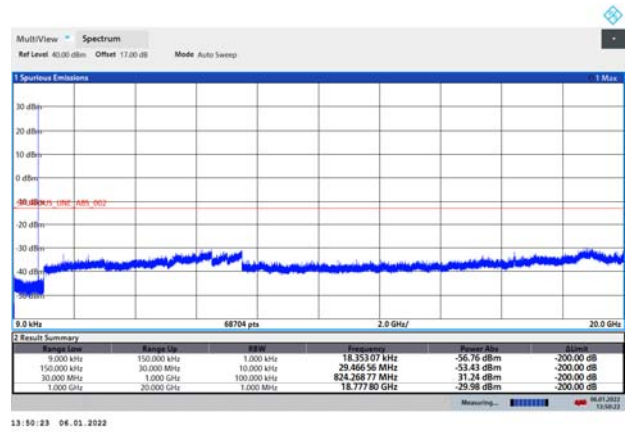

GSM 850 CH-Middle 9kHz ~ 20GHz

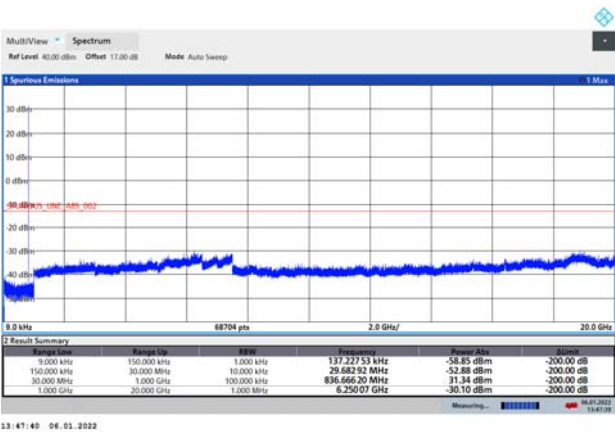

GPRS 850 CH-Middle 9kHz ~ 20GHz

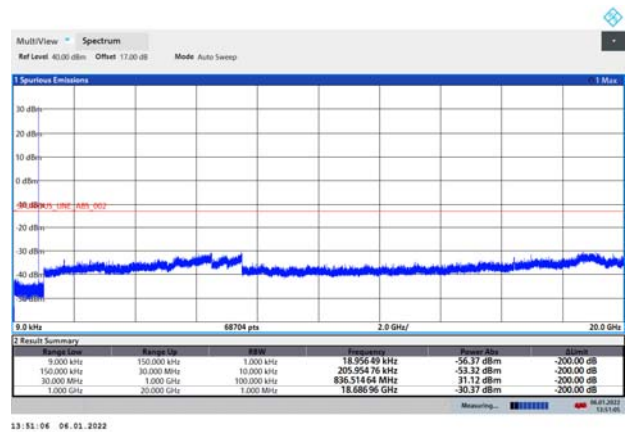

GSM 850 CH-High 9kHz ~ 20GHz

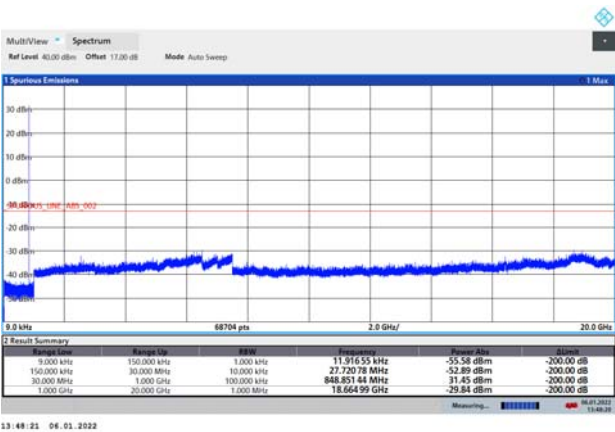

GPRS 850 CH-High 9kHz ~ 20GHz

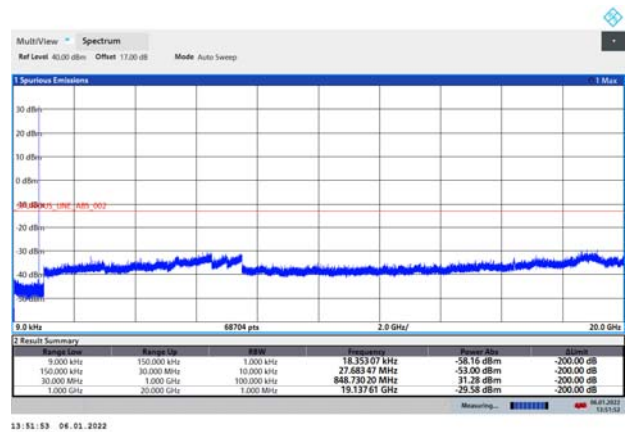



EGPRS 850 CH-Low 9kHz ~ 20GHz

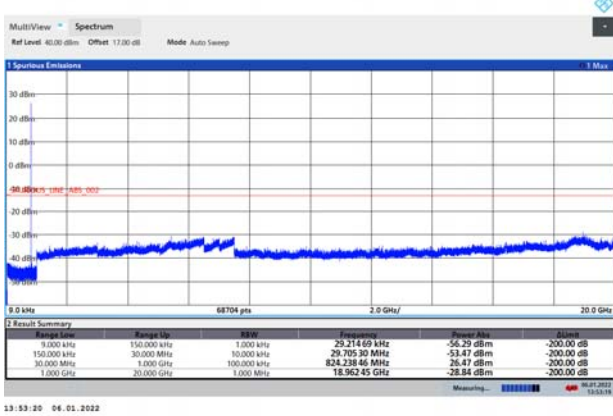

WCDMA BAND V CH-Low 9kHz ~ 20GHz

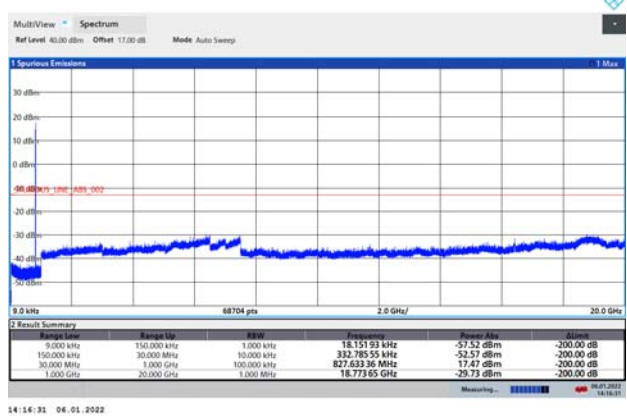

EGPRS 850 CH-Middle 9kHz ~ 20GHz

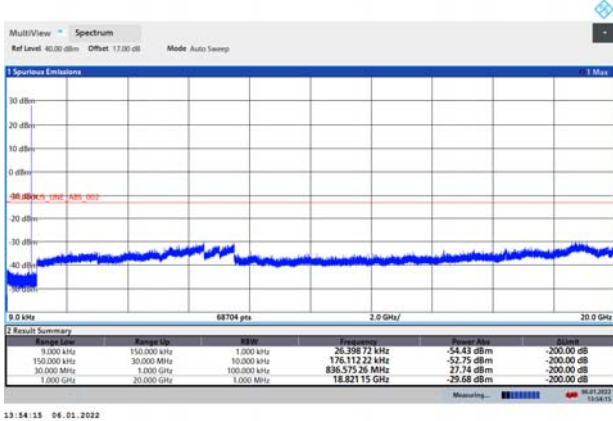

WCDMA BAND V CH-Middle 9kHz ~ 20GHz

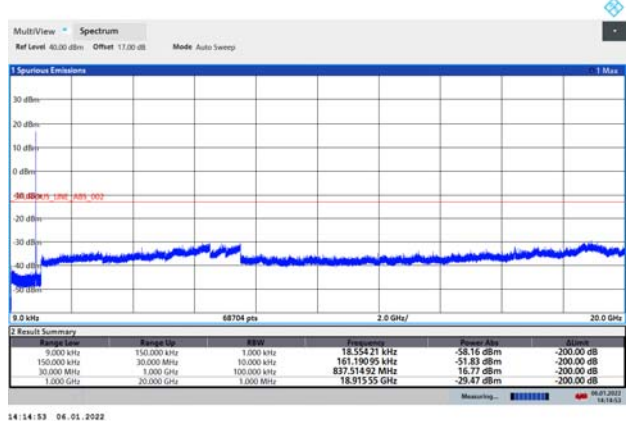

EGPRS 850 CH-High 9kHz ~ 20GHz

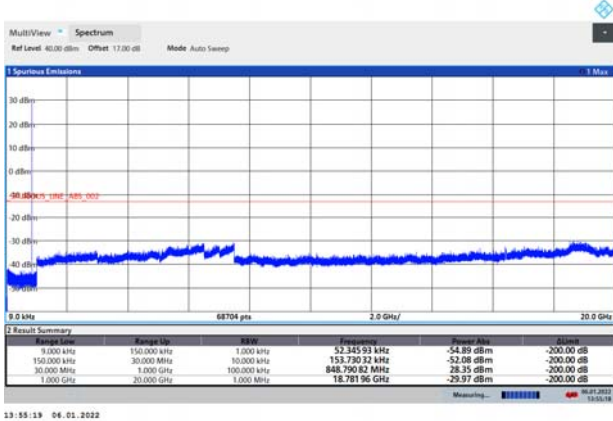

WCDMA BAND V CH-High 9kHz ~ 20GHz

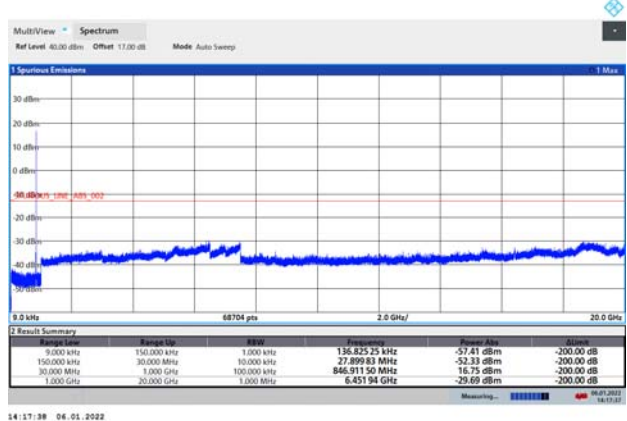

LTE Band 5 1.4MHz CH-Low 9kHz~10GHz

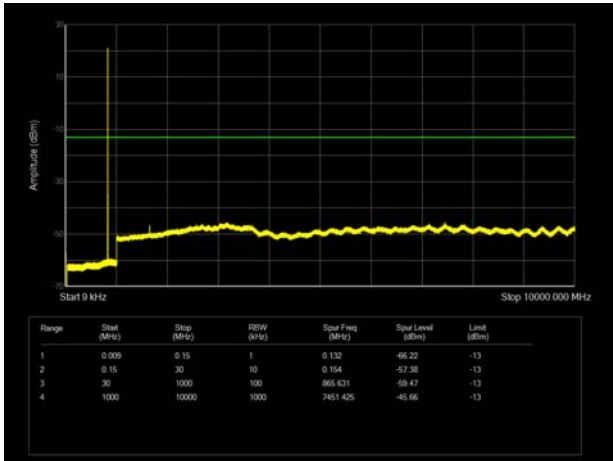

LTE Band 5 3MHz CH-Low 9kHz~10GHz

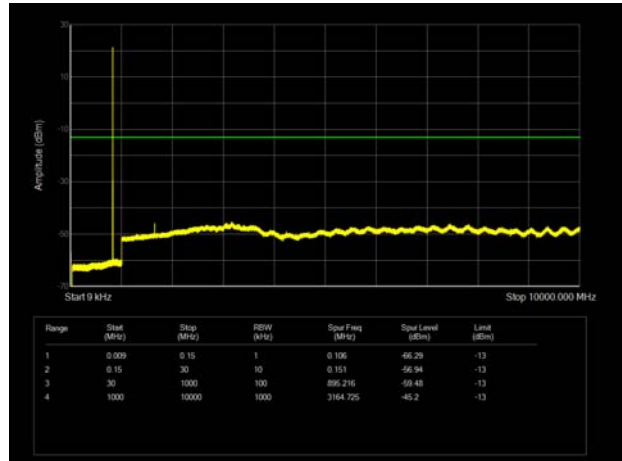

LTE Band 5 1.4MHz CH-Middle 9kHz~10GHz

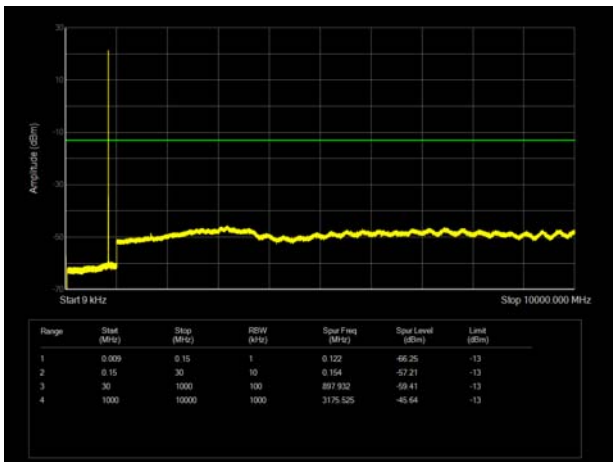

LTE Band 5 3MHz CH-Middle 9kHz~10GHz

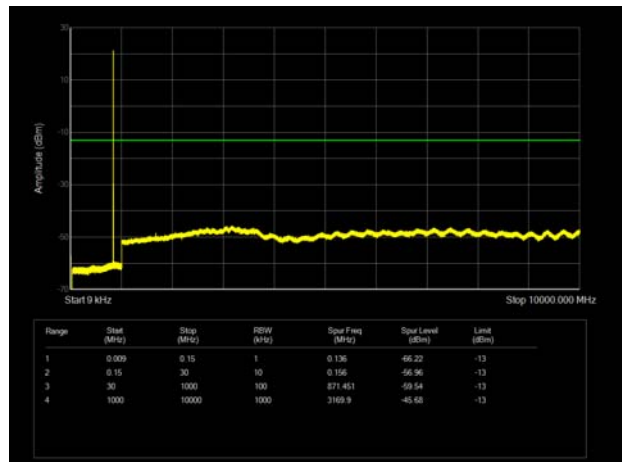

LTE Band 5 1.4MHz CH-High 9kHz~10GHz

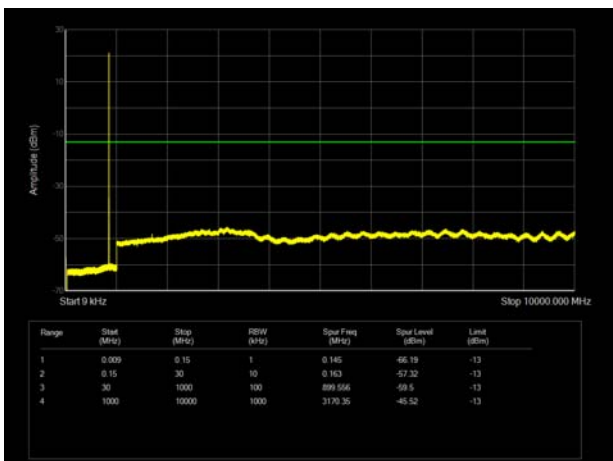

LTE Band 5 3MHz CH-High 9kHz~10GHz

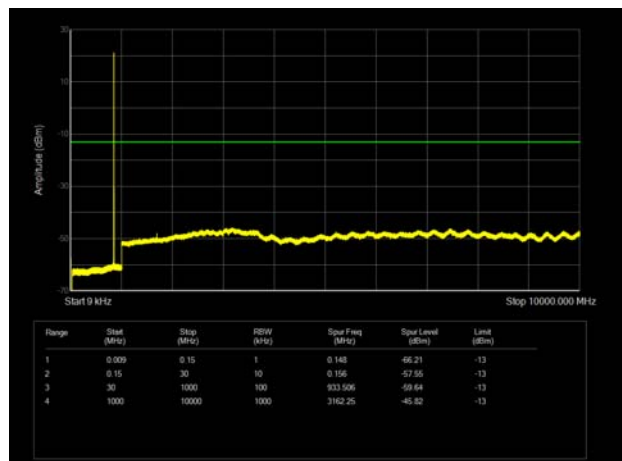

LTE Band 5 5MHz CH-Low 9kHz~10GHz

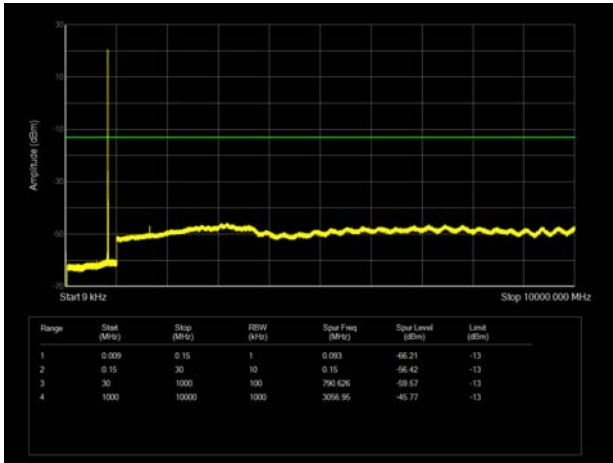

LTE Band 5 10MHz CH-Low 9kHz~10GHz

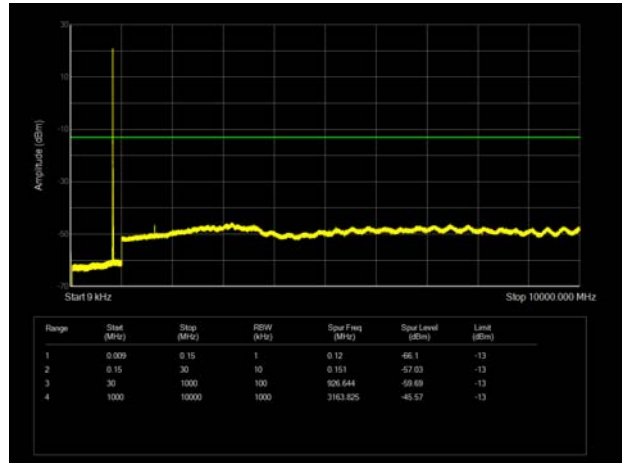

LTE Band 5 5MHz CH-Middle 9kHz~10GHz

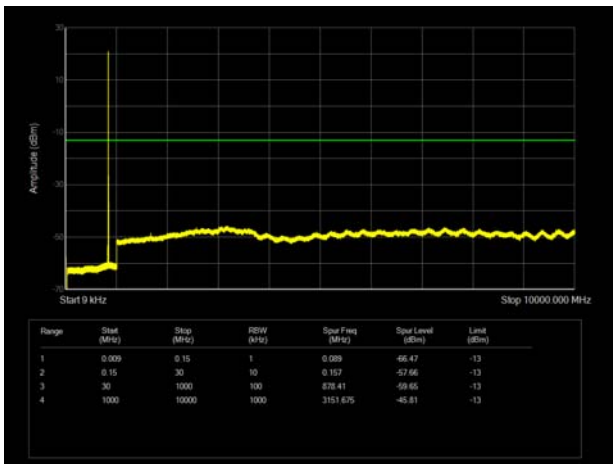

LTE Band 5 10MHz CH-Middle 9kHz~10GHz

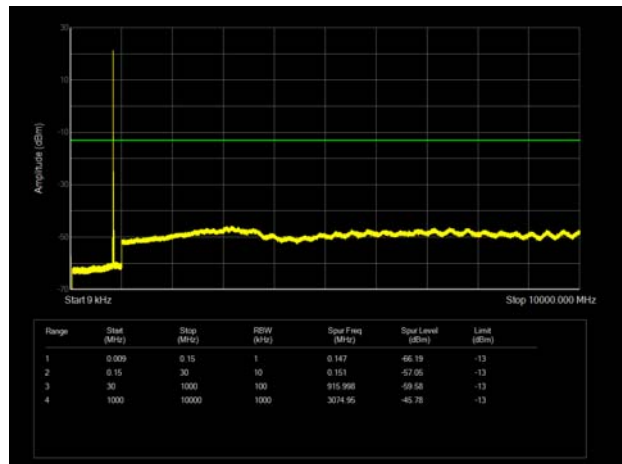

LTE Band 5 5MHz CH-High 9kHz~10GHz

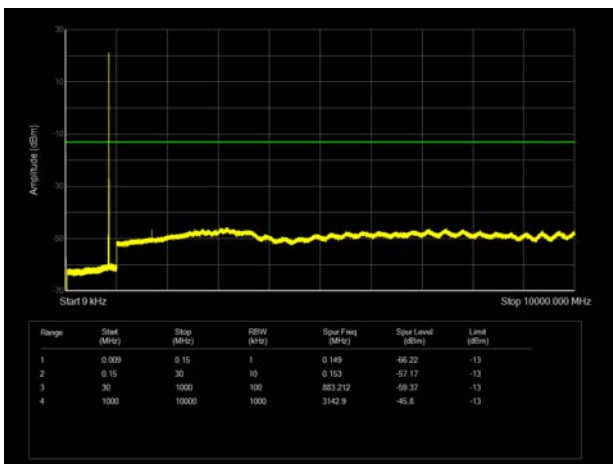

LTE Band 5 10MHz CH-High 9kHz~10GHz

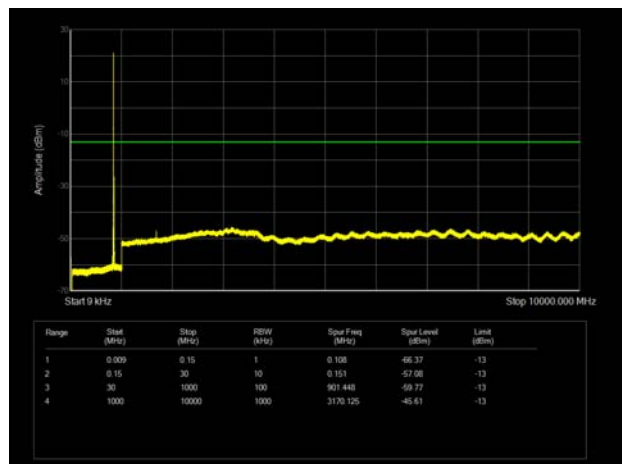

5.7. Radiates Spurious Emission

Ambient condition

Temperature	Relative humidity	Pressure
23°C ~25°C	45%~50%	101.5kPa

Method of Measurement

1. The testing follows FCC KDB 971168 v03r01 Section 5.8 and ANSI C63.26 (2015).
2. Below 1GHz: The EUT is placed on a turntable 0.8 meters above the ground in the chamber, 3 meter away from the antenna. The maximal emission value is acquired by adjusting the antenna height, polarisation and turntable azimuth. Normally, the height range of antenna is 1 m to 4 m, the azimuth range of turntable is 0° to 360°, and the receive antenna has two polarizations Vertical (V) and Horizontal (H). Above 1GHz: (Note: the FCC's permission to use 1.5m as an alternative per TCBC Conf call of Dec. 2, 2014.) The EUT is placed on a turntable 1.5 meters above the ground in the chamber, 3 meter away from the antenna. The maximal emission value is acquired by adjusting the antenna height, polarisation and turntable azimuth. Normally, the height range of antenna is 1 m to 4 m, the azimuth range of turntable is 0° to 360°, and the receive antenna has two polarizations Vertical (V) and Horizontal (H).
3. A loop antenna, A log-periodic antenna or horn antenna shall be substituted in place of the EUT. The log-periodic antenna will be driven by a signal generator and the level will be adjusted till the same power value on the spectrum analyzer or receiver. The level of the spurious emissions can be calculated through the level of the signal generator, cable loss, the gain of the substitution antenna and the reading of the spectrum analyzer or receiver.
4. The EUT is then put into continuously transmitting mode at its maximum power level during the test. Set Test Receiver or Spectrum RBW=100kHz, VBW=300kHz for 30MHz to 1GHz and RBW=1MHz, VBW=3MHz for above 1GHz, and the maximum value of the receiver should be recorded as (Pr).
5. The EUT shall be replaced by a substitution antenna. In the chamber, an substitution antenna for the frequency band of interest is placed at the reference point of the chamber. An RF Signal source for the frequency band of interest is connected to the substitution antenna with a cable that has been constructed to not interfere with the radiation pattern of the antenna. A power (PMea) is applied to the input of the substitution antenna, and adjust the level of the signal generator output until the value of the receiver reach the previously recorded (Pr). The power of signal source (PMea) is recorded. The test should be performed by rotating the test item and adjusting the receiving antenna polarization.
6. A amplifier should be connected to the Signal Source output port. And the cable should be connect between the Amplifier and the Substitution Antenna. The cable loss (Pcl), the Substitution Antenna Gain (Ga) and the Amplifier Gain (PAg) should be recorded after test.
7. The measurement results are obtained as described below:
Power(EIRP)=PMea- PAg - Pcl + Ga
The measurement results are amend as described below:
Power(EIRP)=PMea- Pcl + Ga
8. This value is EIRP since the measurement is calibrated using an antenna of known gain (2.15 dB) and known input power. ERP can be calculated from EIRP by subtracting the gain of the dipole, ERP

= EIRP-2.15dB.

The modulation mode and RB allocation refer to section 5.1, using the maximum output power configuration.

Test setup

9KHz ~ 30MHz

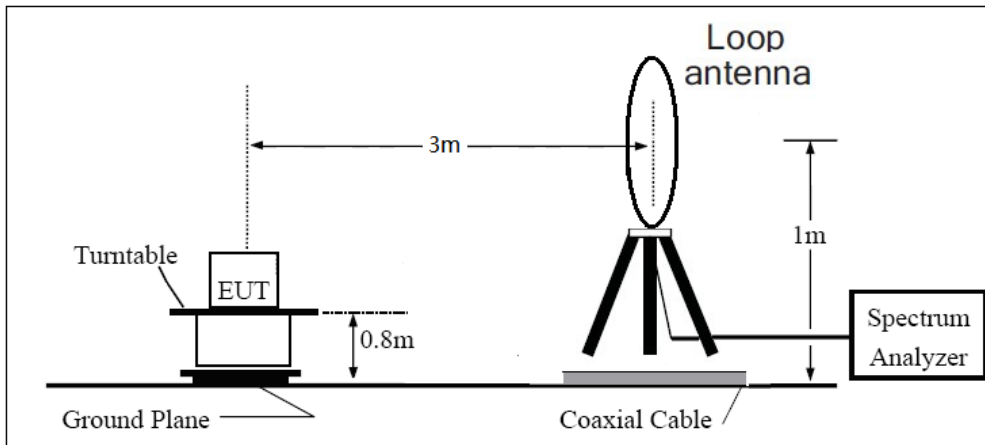

30MHz ~ 1GHz

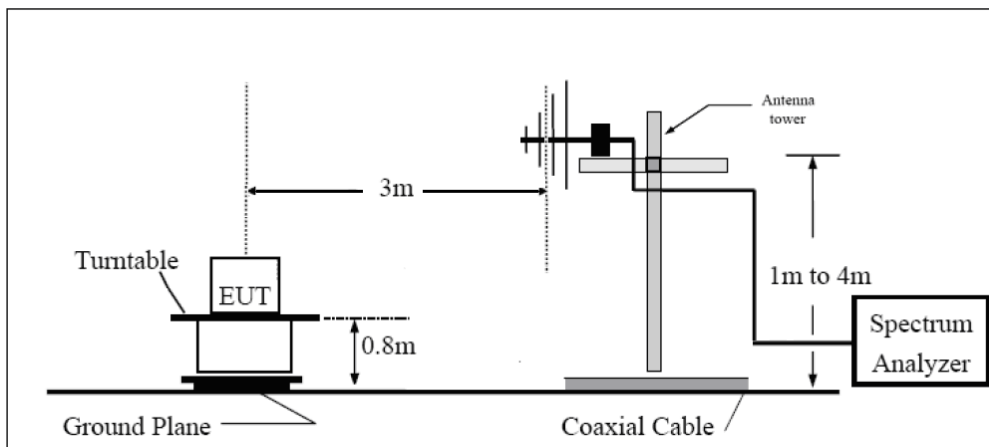

Above 1GHz

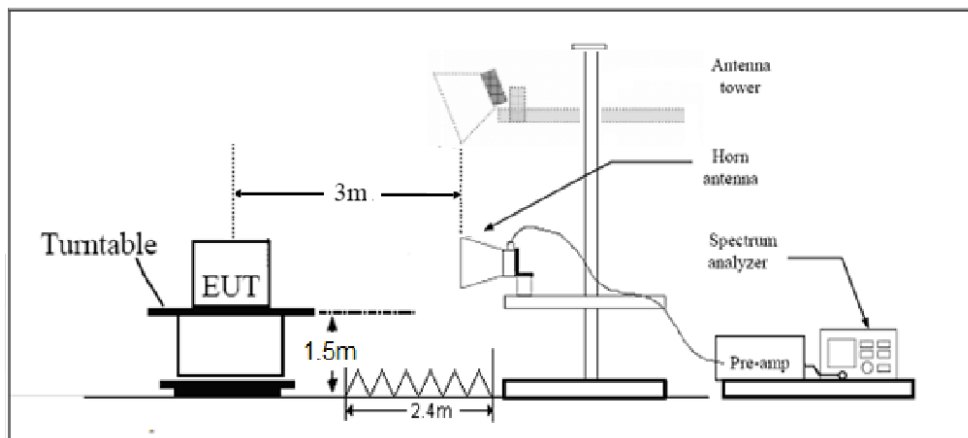

Note: Area side:2.4mX3.6m

Limits

Rule Part 22.917(a) specifies that “The power of any emission outside of the authorized operating frequency ranges must be attenuated below the transmitting power (P) by a factor of at least $43 + 10 \log (P)$ dB.”

Limit	-13 dBm
-------	---------

Measurement Uncertainty

The assessed measurement uncertainty to ensure 95% confidence level for the normal distribution is with the coverage factor $k = 1.96$, $U = 3.55$ dB.

**Test Result**

Sweep the whole frequency band through the range from 9kHz to the 10th harmonic of the carrier, the emissions below the noise floor will not be recorded in the report.

Low Antenna

GSM 850 CH-Middle

Harmonic	Frequency (MHz)	SG (dBm)	Cable Loss (dB)	Gain (dBi)	Antenna Polarization	ERP Level (dBm)	Limit (dBm)	Margin (dB)	Azimuth (deg)
2	1672.45	-59.67	2.30	12.00	Horizontal	-52.12	-13.00	39.12	45
3	2509.55	-55.88	1.70	8.70	Horizontal	-51.03	-13.00	38.03	90
4	3346.40	-64.41	2.70	12.70	Horizontal	-56.56	-13.00	43.56	270
5	4183.00	-62.77	3.00	12.50	Horizontal	-55.42	-13.00	42.42	0
6	5019.60	-59.96	3.40	12.50	Horizontal	-53.01	-13.00	40.01	315
7	5856.20	-59.58	3.40	12.80	Horizontal	-52.33	-13.00	39.33	225
8	6692.80	-57.69	4.10	11.50	Horizontal	-52.44	-13.00	39.44	135
9	7529.40	-54.73	4.20	12.20	Horizontal	-48.88	-13.00	35.88	0
10	8366.00	-55.12	4.30	12.50	Horizontal	-49.07	-13.00	36.07	45

Note: 1.The other Spurious RF Radiated emissions level is no more than noise floor.

2.The worst emission was found in the antenna is Horizontal position.

WCDMA Band V CH-Middle

Harmonic	Frequency (MHz)	SG (dBm)	Cable Loss (dB)	Gain (dBi)	Antenna Polarization	ERP Level (dBm)	Limit (dBm)	Margin (dB)	Azimuth (deg)
2	1652.80	-66.53	1.70	8.70	Horizontal	-61.68	-13.00	48.68	270
3	2479.20	-67.22	2.30	12.00	Horizontal	-59.67	-13.00	46.67	180
4	3305.60	-64.28	2.70	12.70	Horizontal	-56.43	-13.00	43.43	45
5	4132.00	-62.36	3.00	12.50	Horizontal	-55.01	-13.00	42.01	0
6	4958.40	-59.95	3.40	12.50	Horizontal	-53.00	-13.00	40.00	0
7	5784.80	-59.73	3.40	12.80	Horizontal	-52.48	-13.00	39.48	0
8	6611.20	-58.47	4.10	11.50	Horizontal	-53.22	-13.00	40.22	90
9	7437.60	-52.64	4.20	12.20	Horizontal	-46.79	-13.00	33.79	180
10	8264.00	-55.78	4.30	12.50	Horizontal	-49.73	-13.00	36.73	45

Note: 1.The other Spurious RF Radiated emissions level is no more than noise floor.

2.The worst emission was found in the antenna is Horizontal position.



LTE Band 5 1.4MHz CH-Middle

Harmonic	Frequency (MHz)	SG (dBm)	Cable Loss (dB)	Gain (dBi)	Antenna Polarization	ERP Level (dBm)	Limit (dBm)	Margin (dB)	Azimuth (deg)
2	1672.15	-64.73	1.70	8.70	Horizontal	-59.88	-13.00	46.88	315
3	2508.25	-62.96	2.30	12.00	Horizontal	-55.41	-13.00	42.41	0
4	3343.20	-66.11	2.70	12.70	Horizontal	-58.26	-13.00	45.26	225
5	4179.00	-63.26	3.00	12.50	Horizontal	-55.91	-13.00	42.91	45
6	5014.80	-60.59	3.40	12.50	Horizontal	-53.64	-13.00	40.64	315
7	5850.60	-58.99	3.40	12.80	Horizontal	-51.74	-13.00	38.74	0
8	6686.40	-57.66	4.10	11.50	Horizontal	-52.41	-13.00	39.41	180
9	7522.20	-54.39	4.20	12.20	Horizontal	-48.54	-13.00	35.54	225
10	8358.00	-55.27	4.30	12.50	Horizontal	-49.22	-13.00	36.22	135

Note: 1.The other Spurious RF Radiated emissions level is no more than noise floor.

2.The worst emission was found in the antenna is Horizontal position.

LTE Band 5 5MHz CH-Middle

Harmonic	Frequency (MHz)	SG (dBm)	Cable Loss (dB)	Gain (dBi)	Antenna Polarization	ERP Level (dBm)	Limit (dBm)	Margin (dB)	Azimuth (deg)
2	1669.00	-65.72	1.70	8.70	Horizontal	-60.87	-13.00	47.87	180
3	2503.10	-60.80	2.30	12.00	Horizontal	-53.25	-13.00	40.25	270
4	3337.50	-65.74	2.70	12.70	Horizontal	-57.89	-13.00	44.89	90
5	4171.88	-62.53	3.00	12.50	Horizontal	-55.18	-13.00	42.18	0
6	5006.25	-59.77	3.40	12.50	Horizontal	-52.82	-13.00	39.82	135
7	5840.63	-58.60	3.40	12.80	Horizontal	-51.35	-13.00	38.35	45
8	6675.00	-57.67	4.10	11.50	Horizontal	-52.42	-13.00	39.42	225
9	7509.38	-54.74	4.20	12.20	Horizontal	-48.89	-13.00	35.89	180
10	8343.75	-54.81	4.30	12.50	Horizontal	-48.76	-13.00	35.76	315

Note: 1.The other Spurious RF Radiated emissions level is no more than noise floor.

2.The worst emission was found in the antenna is Horizontal position.



LTE Band 5 10MHz CH-Middle

Harmonic	Frequency (MHz)	SG (dBm)	Cable Loss (dB)	Gain (dBi)	Antenna Polarization	ERP Level (dBm)	Limit (dBm)	Margin (dB)	Azimuth (deg)
2	1664.15	-64.70	1.70	8.70	Horizontal	-59.85	-13.00	46.85	315
3	2496.30	-61.41	2.30	12.00	Horizontal	-53.86	-13.00	40.86	315
4	3346.00	-65.63	2.70	12.70	Horizontal	-57.78	-13.00	44.78	45
5	4182.50	-63.83	3.00	12.50	Horizontal	-56.48	-13.00	43.48	270
6	5019.00	-59.65	3.40	12.50	Horizontal	-52.70	-13.00	39.70	135
7	5855.50	-59.23	3.40	12.80	Horizontal	-51.98	-13.00	38.98	225
8	6692.00	-59.06	4.10	11.50	Horizontal	-53.81	-13.00	40.81	45
9	7528.50	-55.02	4.20	12.20	Horizontal	-49.17	-13.00	36.17	180
10	8365.00	-55.57	4.30	12.50	Horizontal	-49.52	-13.00	36.52	225

Note: 1.The other Spurious RF Radiated emissions level is no more than noise floor.
2.The worst emission was found in the antenna is Horizontal position.

Upper Antenna

GSM 850 CH-Middle

Harmonic	Frequency (MHz)	SG (dBm)	Cable Loss (dB)	Gain (dBi)	Antenna Polarization	ERP Level (dBm)	Limit (dBm)	Margin (dB)	Azimuth (deg)
2	1672.45	-67.39	2.30	12.00	Horizontal	-59.84	-13.00	46.84	45
3	2509.55	-55.62	1.70	8.70	Horizontal	-50.77	-13.00	37.77	90
4	3346.40	-66.63	2.70	12.70	Horizontal	-58.78	-13.00	45.78	270
5	4183.00	-64.18	3.00	12.50	Horizontal	-56.83	-13.00	43.83	0
6	5019.60	-59.62	3.40	12.50	Horizontal	-52.67	-13.00	39.67	315
7	5856.20	-59.63	3.40	12.80	Horizontal	-52.38	-13.00	39.38	225
8	6692.80	-59.67	4.10	11.50	Horizontal	-54.42	-13.00	41.42	135
9	7529.40	-54.72	4.20	12.20	Horizontal	-48.87	-13.00	35.87	0
10	8366.00	-56.00	4.30	12.50	Horizontal	-49.95	-13.00	36.95	45

Note: 1.The other Spurious RF Radiated emissions level is no more than noise floor.
2.The worst emission was found in the antenna is Horizontal position.



WCDMA Band V CH-Middle

Harmonic	Frequency (MHz)	SG (dBm)	Cable Loss (dB)	Gain (dBi)	Antenna Polarization	ERP Level (dBm)	Limit (dBm)	Margin (dB)	Azimuth (deg)
2	1671.80	-64.62	1.70	8.70	Horizontal	-59.77	-13.00	46.77	270
3	2507.15	-65.41	2.30	12.00	Horizontal	-57.86	-13.00	44.86	180
4	3346.40	-66.54	2.70	12.70	Horizontal	-58.69	-13.00	45.69	45
5	4183.00	-63.98	3.00	12.50	Horizontal	-56.63	-13.00	43.63	0
6	5019.60	-59.79	3.40	12.50	Horizontal	-52.84	-13.00	39.84	0
7	5856.20	-60.61	3.40	12.80	Horizontal	-53.36	-13.00	40.36	0
8	6692.80	-58.45	4.10	11.50	Horizontal	-53.20	-13.00	40.20	90
9	7529.40	-55.39	4.20	12.20	Horizontal	-49.54	-13.00	36.54	180
10	8366.00	-55.78	4.30	12.50	Horizontal	-49.73	-13.00	36.73	45

Note: 1.The other Spurious RF Radiated emissions level is no more than noise floor.

2.The worst emission was found in the antenna is Horizontal position.

LTE Band 5 1.4MHz CH-Middle

Harmonic	Frequency (MHz)	SG (dBm)	Cable Loss (dB)	Gain (dBi)	Antenna Polarization	ERP Level (dBm)	Limit (dBm)	Margin (dB)	Azimuth (deg)
2	1672.15	-64.17	1.70	8.70	Horizontal	-59.32	-13.00	46.32	315
3	2508.25	-63.03	2.30	12.00	Horizontal	-55.48	-13.00	42.48	0
4	3343.20	-68.01	2.70	12.70	Horizontal	-60.16	-13.00	47.16	225
5	4179.00	-64.88	3.00	12.50	Horizontal	-57.53	-13.00	44.53	45
6	5014.80	-62.13	3.40	12.50	Horizontal	-55.18	-13.00	42.18	315
7	5850.60	-62.35	3.40	12.80	Horizontal	-55.10	-13.00	42.10	0
8	6686.40	-58.46	4.10	11.50	Horizontal	-53.21	-13.00	40.21	180
9	7522.20	-56.06	4.20	12.20	Horizontal	-50.21	-13.00	37.21	225
10	8358.00	-55.99	4.30	12.50	Horizontal	-49.94	-13.00	36.94	135

Note: 1.The other Spurious RF Radiated emissions level is no more than noise floor.

2.The worst emission was found in the antenna is Horizontal position.



LTE Band 5 5MHz CH-Middle

Harmonic	Frequency (MHz)	SG (dBm)	Cable Loss (dB)	Gain (dBi)	Antenna Polarization	ERP Level (dBm)	Limit (dBm)	Margin (dB)	Azimuth (deg)
2	1669.00	-65.39	1.70	8.70	Horizontal	-60.54	-13.00	47.54	180
3	2503.10	-58.96	2.30	12.00	Horizontal	-51.41	-13.00	38.41	270
4	3337.50	-67.61	2.70	12.70	Horizontal	-59.76	-13.00	46.76	90
5	4171.88	-64.96	3.00	12.50	Horizontal	-57.61	-13.00	44.61	0
6	5006.25	-62.37	3.40	12.50	Horizontal	-55.42	-13.00	42.42	135
7	5840.63	-61.76	3.40	12.80	Horizontal	-54.51	-13.00	41.51	45
8	6675.00	-58.28	4.10	11.50	Horizontal	-53.03	-13.00	40.03	225
9	7509.38	-54.97	4.20	12.20	Horizontal	-49.12	-13.00	36.12	180
10	8343.75	-55.78	4.30	12.50	Horizontal	-49.73	-13.00	36.73	315

Note: 1.The other Spurious RF Radiated emissions level is no more than noise floor.
2.The worst emission was found in the antenna is Horizontal position.

LTE Band 5 10MHz CH-Middle

Harmonic	Frequency (MHz)	SG (dBm)	Cable Loss (dB)	Gain (dBi)	Antenna Polarization	ERP Level (dBm)	Limit (dBm)	Margin (dB)	Azimuth (deg)
2	1664.15	-65.07	1.70	8.70	Horizontal	-60.22	-13.00	47.22	315
3	2496.30	-58.00	2.30	12.00	Horizontal	-50.45	-13.00	37.45	315
4	3346.00	-68.63	2.70	12.70	Horizontal	-60.78	-13.00	47.78	45
5	4182.50	-64.80	3.00	12.50	Horizontal	-57.45	-13.00	44.45	270
6	5019.00	-63.11	3.40	12.50	Horizontal	-56.16	-13.00	43.16	135
7	5855.50	-62.39	3.40	12.80	Horizontal	-55.14	-13.00	42.14	225
8	6692.00	-57.94	4.10	11.50	Horizontal	-52.69	-13.00	39.69	45
9	7528.50	-55.12	4.20	12.20	Horizontal	-49.27	-13.00	36.27	180
10	8365.00	-55.74	4.30	12.50	Horizontal	-49.69	-13.00	36.69	225

Note: 1.The other Spurious RF Radiated emissions level is no more than noise floor.
2.The worst emission was found in the antenna is Horizontal position.

6. Main Test Instruments

Name	Manufacturer	Type	Serial Number	Calibration Date	Expiration Date
Base Station Simulator	R&S	CMW500	113645	2021-05-15	2022-05-14
Climate Chamber	Weiss	VT4002	58226119450 010	2021-05-15	2022-05-14
Spectrum Analyzer	Keysight	N9020A	MY52330084	2021-05-15	2022-05-14
Universal Radio Communication Tester	Key sight	E5515C	GB44400275	2021-05-15	2022-05-14
Signal Analyzer	R&S	FSV3030	101411	2021-12-12	2022-12-12
Signal Analyzer	R&S	FSV30	100815	2021-12-12	2022-12-11
TRILOG Broadband Antenna	Schwarzbeck	VULB 9163	01439	2021-06-30	2024-06-29
Horn Antenna	Schwarzbeck	BBHA 9120D	01799	2019-09-21	2022-09-20
Software	R&S	EMC32	9.26.0	/	/

*****END OF REPORT *****



ANNEX A: The EUT Appearance

The EUT Appearance are submitted separately.



ANNEX B: Test Setup Photos

The Test Setup Photos are submitted separately.