



# RF TEST REPORT

**Applicant**      Xiaomi Communications Co., Ltd.  
**FCC ID**          2AFZZ3QAG  
**Product**        Mobile Phone  
**Brand**            Redmi  
**Model**            220333QAG  
**Report No.**      R2111A1052-R1  
**Issue Date**      January 6, 2022

TA Technology (Shanghai) Co., Ltd. tested the above equipment in accordance with the requirements in **FCC CFR47 Part 2 (2020)/ FCC CFR 47 Part 22H (2020)**. The test results show that the equipment tested is capable of demonstrating compliance with the requirements as documented in this report.

Prepared by: Peng Tao

Approved by: Kai Xu

---

**TA Technology (Shanghai) Co., Ltd.**

No.145, Jintang Rd, Tangzhen Industry Park, Pudong Shanghai, China

TEL: +86-021-50791141/2/3

FAX: +86-021-50791141/2/3-8000



## TABLE OF CONTENT

1. Test Laboratory .....	4
1.1. Notes of the Test Report .....	4
1.2. Test facility .....	4
1.3. Testing Location .....	4
2. General Description of Equipment under Test.....	5
2.1. Applicant and Manufacturer Information .....	5
2.2. General Information.....	5
3. Applied Standards.....	7
4. Test Configuration.....	8
5. Test Case Results.....	10
5.1. RF Power Output and Effective Radiated Power .....	10
5.2. Occupied Bandwidth .....	15
5.3. Band Edge Compliance.....	26
5.4. Peak-to-Average Power Ratio (PAPR) .....	37
5.5. Frequency Stability.....	40
5.6. Spurious Emissions at Antenna Terminals .....	44
5.7. Radiates Spurious Emission .....	49
6. Main Test Instruments .....	57
ANNEX A: The EUT Appearance .....	58
ANNEX B: Test Setup Photos .....	59



## Summary of measurement results

No.	Test Case	Clause in FCC rules	Verdict
1	RF Power Output and Effective Radiated Power	2.1046 22.913(a)(5)	PASS
2	Occupied Bandwidth	2.1049	PASS
3	Band Edge Compliance	2.1051 / 22.917(a)	PASS
4	Peak-to-Average Power Ratio	22.913(d)/ KDB 971168 D01(5.7)	PASS
5	Frequency Stability	2.1055 / 22.355	PASS
6	Spurious Emissions at Antenna Terminals	2.1051 / 22.917(a)	PASS
7	Radiates Spurious Emission	2.1053 / 22.917 (a)	PASS

Date of Testing: December 16, 2021 ~ December 19, 2021

Date of Sample Received: December 9, 2021

Note: PASS: The EUT complies with the essential requirements in the standard.

FAIL: The EUT does not comply with the essential requirements in the standard.

All indications of Pass/Fail in this report are opinions expressed by TA Technology (Shanghai) Co., Ltd. based on interpretations and/or observations of test results. Measurement Uncertainties were not taken into account and are published for informational purposes only.



## 1. Test Laboratory

### 1.1. Notes of the Test Report

This report shall not be reproduced in full or partial, without the written approval of **TA technology (shanghai) co., Ltd.** The results documented in this report apply only to the tested sample, under the conditions and modes of operation as described herein. Measurement Uncertainties were not taken into account and are published for informational purposes only. This report is written to support regulatory compliance of the applicable standards stated above.

### 1.2. Test facility

#### **FCC (Designation number: CN1179, Test Firm Registration Number: 446626)**

TA Technology (Shanghai) Co., Ltd. has been listed on the US Federal Communications Commission list of test facilities recognized to perform measurements.

#### **A2LA (Certificate Number: 3857.01)**

TA Technology (Shanghai) Co., Ltd. has been listed by American Association for Laboratory Accreditation to perform measurement.

### 1.3. Testing Location

Company: TA Technology (Shanghai) Co., Ltd.  
Address: No.145, Jintang Rd, Tangzhen Industry Park, Pudong  
City: Shanghai  
Post code: 201201  
Country: P. R. China  
Contact: Xu Kai  
Telephone: +86-021-50791141/2/3  
Fax: +86-021-50791141/2/3-8000  
Website: <http://www.ta-shanghai.com>  
E-mail: [xukai@ta-shanghai.com](mailto:xukai@ta-shanghai.com)

## 2. General Description of Equipment under Test

### 2.1. Applicant and Manufacturer Information

Applicant	Xiaomi Communications Co., Ltd.
Applicant address	#019, 9th Floor, Building 6, 33 Xi'erqi Middle Road, Haidian District, Beijing, China, 100085
Manufacturer	Xiaomi Communications Co., Ltd.
Manufacturer address	#019, 9th Floor, Building 6, 33 Xi'erqi Middle Road, Haidian District, Beijing, China, 100085

### 2.2. General Information

EUT Description			
Model	220333QAG		
IMEI	IMEI 1: 864763060060009 IMEI 2: 864763060060017		
Hardware Version	P1.1		
Software Version	MIUI13		
Antenna Type	PIFA Antenna		
Antenna Gain	Band	Low Antenna	Upper Antenna
	GSM850	-3.40 dBi	-1.10 dBi
	WCDMA Band V	-3.40 dBi	-1.10 dBi
	LTE Band 5	-2.90 dBi	-0.89 dBi
Test Mode(s)	GSM 850; WCDMA Band V; LTE Band 5;		
Test Modulation	(GSM/GPRS)GMSK, (EGPRS) GMSK/ 8PSK; (WCDMA) BPSK, QPSK; (LTE)QPSK,16QAM, 64QAM		
GPRS Multislot Class	33		
EGPRS Multislot Class	33		
HSDPA UE Category	24		
HSUPA UE Category	6		
LTE Category	5		
Maximum E.R.P.	GSM 850:	29.12 dBm	
	WCDMA Band V:	21.55 dBm	
	LTE Band 5:	20.94 dBm	
Rated Power Supply Voltage	3.87V		
Operating Voltage	Minimum: 3.6V    Maximum: 4.2V		
Operating Temperature	Lowest: 0°C    Highest: +40°C		
Testing Temperature	Lowest: -30°C    Highest: +50°C		
Operating Frequency Range(s)	Band	Tx (MHz)	Rx (MHz)



	GSM850	824 ~ 849	869 ~ 894
	WCDMA Band V	824 ~ 849	869 ~ 894
	LTE Band 5	824 ~ 849	869 ~ 894

Note: 1. The EUT is sent from the applicant to TA and the information of the EUT is declared by the applicant.



### 3. Applied Standards

According to the specifications of the manufacturer, it must comply with the requirements of the following standards:

**Test standards:**

**FCC CFR 47 Part 22H (2020)**

**FCC CFR47 Part 2 (2020)**

**Reference standard:**

**ANSI C63.26 (2015)**

**KDB 971168 D01 Power Meas License Digital Systems v03r01**

## 4. Test Configuration

There is more than one SIM card slot, each one should be applied throughout the compliance test respectively, and however, only the worst case (SIM 1) will be recorded in this report.

Radiated measurements are performed by rotating the EUT in three different orthogonal test planes. EUT stand-up position (Z axis), lie-down position (X, Y axis). Receiver antenna polarization (horizontal and vertical), the worst emission was found in position (Z axis, horizontal polarization; Z axis, horizontal polarization, Upper Antenna; X axis, vertical polarization, Low Antenna) and the worst case was recorded.

All mode and data rates and positions and RB size and modulations were investigated. Subsequently, only the worst case emissions are reported.

The following testing in GSM/WCDMA/LTE is set based on the maximum RF Output Power.

Test modes are chosen to be reported as the worst case configuration below:

Test items	Modes/Modulation	
	GSM 850	WCDMA Band V
RF Power Output and Effective Radiated power	GSM GPRS EGPRS	RMC HSDPA/HSUPA DC-HSDPA
Occupied Bandwidth	GSM GPRS(1Tx slot) EGPRS(1Tx slot)	RMC
Band Edge Compliance	GSM GPRS(1Tx slot) EGPRS(1Tx slot)	RMC
Peak-to-Average Power Ratio	GSM GPRS(1Tx slot) EGPRS(1Tx slot)	RMC
Frequency Stability	GSM GPRS(1Tx slot) EGPRS(1Tx slot)	RMC
Spurious Emissions at Antenna Terminals	GSM	RMC
Radiates Spurious Emission	GSM	RMC



Test modes are chosen as the worst case configuration below for LTE Band 5.

Test items	Bandwidth (MHz)				Modulation		RB			Test Channel		
	1.4	3	5	10	QPSK	16QAM/ 64QAM	1	50%	100%	L	M	H
RF power output and Effective Radiated power	O	O	O	O	O	O	O	O	O	O	O	O
Occupied Bandwidth	O	O	O	O	O	O	-	-	O	O	O	O
Band Edge Compliance	O	O	O	O	O	O	O	-	O	O	-	O
Peak-to-Average Power Ratio	O	O	O	O	O	O	-	-	O	O	O	O
Frequency Stability	O	O	O	O	O	O	O	-	-	-	O	-
Spurious Emissions at Antenna Terminals	O	O	O	O	O	-	O	-	-	O	O	O
Radiates Spurious Emission	O	-	O	O	O	-	O	-	-	-	O	-
Note	1. The mark "O" means that this configuration is chosen for testing. 2. The mark "-" means that this configuration is not testing.											

## 5. Test Case Results

### 5.1. RF Power Output and Effective Radiated Power

#### Ambient condition

Temperature	Relative humidity	Pressure
23°C ~25°C	45%~50%	101.5kPa

#### Methods of Measurement

During the process of the testing, The EUT was connected to the Base Station Simulator with a known loss. The EUT is controlled by the Base Station Simulator test set to ensure max power transmission with proper modulation.

ERP can then be calculated as follows:

$$\text{EIRP (dBm)} = \text{Output Power (dBm)} - \text{Losses (dB)} + \text{Antenna Gain (dBi)}$$

where:dBd refers to gain relative to an ideal dipole.

$$\text{EIRP (dBm)} = \text{ERP (dBm)} + 2.15 \text{ (dB)}.$$

#### Test Setup

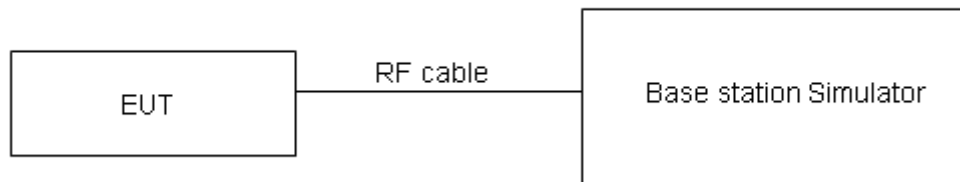

#### Limits

No specific RF power output requirements in part 2.1046.

Rule Part 22.913(a)(5) specifies that "Mobile/portable stations are limited to 7 watts ERP".

Limit	≤ 7 W (38.45 dBm)
-------	-------------------

#### Measurement Uncertainty

The assessed measurement uncertainty to ensure 95% confidence level for the normal distribution is with the coverage factor  $k = 2$ ,  $U = 0.4$  dB for RF power output,  $k = 2$ ,  $U = 1.19$  dB for ERP.



## Test Results

GSM 850		Maximum Output Power (dBm)			Low Antenna ERP (dBm)			Upper Antenna ERP (dBm)		
		Channel 128	Channel 190	Channel 251	Channel 128	Channel 190	Channel 251	Channel 128	Channel 190	Channel 251
		824.2 (MHz)	836.6 (MHz)	848.8 (MHz)	824.2 (MHz)	836.6 (MHz)	848.8 (MHz)	824.2 (MHz)	836.6 (MHz)	848.8 (MHz)
GSM(GMSK)	Results	31.78	32.01	32.16	26.73	26.96	27.11	28.74	28.97	29.12
GPRS (GMSK)	1TXslot	31.64	32.07	32.11	26.59	27.02	27.06	28.60	29.03	29.07
	2TXslots	30.27	30.64	30.83	25.22	25.59	25.78	27.23	27.60	27.79
	3TXslots	27.86	28.14	28.27	22.81	23.09	23.22	24.82	25.10	25.23
	4TXslots	26.54	26.81	26.85	21.49	21.76	21.80	23.50	23.77	23.81
EGPRS (8PSK)	1TXslot	25.91	26.42	26.21	20.86	21.37	21.16	22.87	23.38	23.17
	2TXslots	24.97	24.92	24.84	19.92	19.87	19.79	21.93	21.88	21.80
	3TXslots	22.62	22.97	22.72	17.57	17.92	17.67	19.58	19.93	19.68
	4TXslots	21.77	21.69	21.82	16.72	16.64	16.77	18.73	18.65	18.78

WCDMA Band V		Maximum Output Power (dBm)			Low Antenna ERP (dBm)			Upper Antenna ERP (dBm)		
		Channel 4132	Channel 4183	Channel 4233	Channel 4132	Channel 4183	Channel 4233	Channel 4132	Channel 4183	Channel 4233
		826.4 (MHz)	836.6 (MHz)	846.6 (MHz)	826.4 (MHz)	836.6 (MHz)	846.6 (MHz)	826.4 (MHz)	836.6 (MHz)	846.6 (MHz)
RMC		24.49	24.47	24.59	19.44	19.42	19.54	21.45	21.43	21.55
HSDPA	Sub - Test 1	23.91	23.89	24.01	18.86	18.84	18.96	20.87	20.85	20.97
	Sub - Test 2	23.90	23.88	24.00	18.85	18.83	18.95	20.86	20.84	20.96
	Sub - Test 3	23.39	23.37	23.49	18.34	18.32	18.44	20.35	20.33	20.45
	Sub - Test 4	23.38	23.36	23.48	18.33	18.31	18.43	20.34	20.32	20.44
HSUPA	Sub - Test 1	22.87	22.85	22.97	17.82	17.80	17.92	19.83	19.81	19.93
	Sub - Test 2	20.86	20.84	20.96	15.81	15.79	15.91	17.82	17.80	17.92
	Sub - Test 3	21.84	21.83	21.95	16.79	16.78	16.90	18.80	18.79	18.91
	Sub - Test 4	20.83	20.82	20.94	15.78	15.77	15.89	17.79	17.78	17.90
	Sub - Test 5	24.32	24.31	24.43	19.27	19.26	19.38	21.28	21.27	21.39
DC-HSDPA	Sub - Test 1	23.83	23.83	23.93	18.78	18.78	18.88	20.79	20.79	20.89
	Sub - Test 2	23.82	23.82	23.92	18.77	18.77	18.87	20.78	20.78	20.88
	Sub - Test 3	23.40	23.31	23.43	18.35	18.26	18.38	20.36	20.27	20.39
	Sub - Test 4	23.39	23.30	23.42	18.34	18.25	18.37	20.35	20.26	20.38



LTE Band 5				Maximum Output Power(dBm)			Low Antenna ERP (dBm)			Upper Antenna ERP (dBm)		
BW	Modulation	RB size	RB offset	Channel/Frequency(MHz)								
				20407 /824.7	20525 /836.5	20643 /848.3	20407 /824.7	20525 /836.5	20643 /848.3	20407 /824.7	20525 /836.5	20643 /848.3
1.4MHz	QPSK	1	0	23.66	23.47	23.65	18.61	18.42	18.60	20.62	20.43	20.61
		1	2	23.74	23.95	23.89	18.69	18.90	18.84	20.70	20.91	20.85
		1	5	23.23	23.60	23.43	18.18	18.55	18.38	20.19	20.56	20.39
		3	0	23.38	23.39	23.38	18.33	18.34	18.33	20.34	20.35	20.34
		3	2	23.24	23.42	23.40	18.19	18.37	18.35	20.20	20.38	20.36
		3	3	23.18	23.26	23.24	18.13	18.21	18.19	20.14	20.22	20.20
		6	0	22.49	22.42	22.50	17.44	17.37	17.45	19.45	19.38	19.46
	16QAM	1	0	22.32	22.07	22.24	17.27	17.02	17.19	19.28	19.03	19.20
		1	2	22.30	22.46	22.45	17.25	17.41	17.40	19.26	19.42	19.41
		1	5	22.26	22.13	22.23	17.21	17.08	17.18	19.22	19.09	19.19
		3	0	22.30	22.28	22.33	17.25	17.23	17.28	19.26	19.24	19.29
		3	2	22.45	22.55	22.62	17.40	17.50	17.57	19.41	19.51	19.58
		3	3	22.31	22.52	22.26	17.26	17.47	17.21	19.27	19.48	19.22
		6	0	21.35	21.49	21.46	16.30	16.44	16.41	18.31	18.45	18.42
	64QAM	1	0	21.35	21.32	21.41	16.30	16.27	16.36	18.31	18.28	18.37
		1	2	21.87	22.09	21.81	16.82	17.04	16.76	18.83	19.05	18.77
		1	5	21.14	21.51	21.20	16.09	16.46	16.15	18.10	18.47	18.16
		3	0	21.37	21.40	21.43	16.32	16.35	16.38	18.33	18.36	18.39
		3	2	21.54	21.56	21.53	16.49	16.51	16.48	18.50	18.52	18.49
		3	3	21.28	21.56	21.23	16.23	16.51	16.18	18.24	18.52	18.19
		6	0	20.44	20.38	20.47	15.39	15.33	15.42	17.40	17.34	17.43
BW	Modulation	RB size	RB offset	Channel/Frequency(MHz)								
				20415 /825.5	20525 /836.5	20635 /847.5	20415 /825.5	20525 /836.5	20635 /847.5	20415 /825.5	20525 /836.5	20635 /847.5
3MHz	QPSK	1	0	23.68	23.51	23.68	18.63	18.46	18.63	20.64	20.47	20.64
		1	7	23.72	23.98	23.93	18.67	18.93	18.88	20.68	20.94	20.89
		1	14	23.26	23.65	23.47	18.21	18.60	18.42	20.22	20.61	20.43
		8	0	22.48	22.51	22.51	17.43	17.46	17.46	19.44	19.47	19.47
		8	4	22.36	22.52	22.52	17.31	17.47	17.47	19.32	19.48	19.48
		8	7	22.28	22.37	22.34	17.23	17.32	17.29	19.24	19.33	19.30
		15	0	22.49	22.46	22.53	17.44	17.41	17.48	19.45	19.42	19.49
	16QAM	1	0	22.35	22.09	22.27	17.30	17.04	17.22	19.31	19.05	19.23



		1	7	22.33	22.46	22.49	17.28	17.41	17.44	19.29	19.42	19.45
		1	14	22.28	22.17	22.26	17.23	17.12	17.21	19.24	19.13	19.22
		8	0	21.41	21.41	21.45	16.36	16.36	16.40	18.37	18.37	18.41
		8	4	21.56	21.68	21.74	16.51	16.63	16.69	18.52	18.64	18.70
		8	7	21.41	21.64	21.39	16.36	16.59	16.34	18.37	18.60	18.35
		15	0	21.38	21.53	21.49	16.33	16.48	16.44	18.34	18.49	18.45
	64QAM	1	0	21.38	21.34	21.44	16.33	16.29	16.39	18.34	18.30	18.40
		1	7	21.90	22.09	21.83	16.85	17.04	16.78	18.86	19.05	18.79
		1	14	21.16	21.50	21.23	16.11	16.45	16.18	18.12	18.46	18.19
		8	0	20.48	20.53	20.55	15.43	15.48	15.50	17.44	17.49	17.51
		8	4	20.65	20.69	20.65	15.60	15.64	15.60	17.61	17.65	17.61
		8	7	20.38	20.68	20.36	15.33	15.63	15.31	17.34	17.64	17.32
		15	0	20.47	20.42	20.50	15.42	15.37	15.45	17.43	17.38	17.46
BW	Modulation	RB size	RB offset	Channel/Frequency(MHz)								
				20425 /826.5	20525 /836.5	20625 /846.5	20425 /826.5	20525 /836.5	20625 /846.5	20425 /826.5	20525 /836.5	20625 /846.5
5MHz	QPSK	1	0	23.66	23.46	23.65	18.61	18.41	18.60	20.62	20.42	20.61
		1	13	23.71	23.98	23.91	18.66	18.93	18.86	20.67	20.94	20.87
		1	24	23.22	23.59	23.42	18.17	18.54	18.37	20.18	20.55	20.38
		12	0	22.46	22.47	22.48	17.41	17.42	17.43	19.42	19.43	19.44
		12	6	22.34	22.48	22.47	17.29	17.43	17.42	19.30	19.44	19.43
		12	13	22.25	22.36	22.31	17.20	17.31	17.26	19.21	19.32	19.27
		25	0	22.51	22.43	22.50	17.46	17.38	17.45	19.47	19.39	19.46
	16QAM	1	0	22.29	22.06	22.24	17.24	17.01	17.19	19.25	19.02	19.20
		1	13	22.31	22.45	22.47	17.26	17.40	17.42	19.27	19.41	19.43
		1	24	22.25	22.13	22.22	17.20	17.08	17.17	19.21	19.09	19.18
		12	0	21.39	21.40	21.43	16.34	16.35	16.38	18.35	18.36	18.39
		12	6	21.52	21.62	21.69	16.47	16.57	16.64	18.48	18.58	18.65
		12	13	21.39	21.60	21.36	16.34	16.55	16.31	18.35	18.56	18.32
		25	0	21.36	21.49	21.44	16.31	16.44	16.39	18.32	18.45	18.40
	64QAM	1	0	21.32	21.31	21.41	16.27	16.26	16.36	18.28	18.27	18.37
		1	13	21.88	22.08	21.81	16.83	17.03	16.76	18.84	19.04	18.77
		1	24	21.17	21.49	21.23	16.12	16.44	16.18	18.13	18.45	18.19
		12	0	20.48	20.56	20.57	15.43	15.51	15.52	17.44	17.52	17.53
		12	6	20.62	20.65	20.63	15.57	15.60	15.58	17.58	17.61	17.59
		12	13	20.36	20.64	20.33	15.31	15.59	15.28	17.32	17.60	17.29
		25	0	20.45	20.38	20.45	15.40	15.33	15.40	17.41	17.34	17.41



BW	Modulation	RB size	RB offset	Channel/Frequency(MHz)								
				20450 /829	20525 /836.5	20600 /844	20450 /829	20525 /836.5	20600 /844	20450 /829	20525 /836.5	20600 /844
10MHz	QPSK	1	0	23.63	23.42	23.62	18.58	18.37	18.57	20.59	20.38	20.58
		1	25	23.70	23.94	23.89	18.65	18.89	18.84	20.66	20.90	20.85
		1	49	23.20	23.58	23.39	18.15	18.53	18.34	20.16	20.54	20.35
		25	0	22.43	22.42	22.44	17.38	17.37	17.39	19.39	19.38	19.40
		25	13	22.32	22.44	22.44	17.27	17.39	17.39	19.28	19.40	19.40
		25	25	22.22	22.31	22.27	17.17	17.26	17.22	19.18	19.27	19.23
		50	0	22.48	22.38	22.46	17.43	17.33	17.41	19.44	19.34	19.42
	16QAM	1	0	22.19	22.02	22.19	17.14	16.97	17.14	19.15	18.98	19.15
		1	25	22.27	22.43	22.43	17.22	17.38	17.38	19.23	19.39	19.39
		1	49	22.23	22.10	22.20	17.18	17.05	17.15	19.19	19.06	19.16
		25	0	21.36	21.36	21.40	16.31	16.31	16.35	18.32	18.32	18.36
		25	13	21.49	21.60	21.66	16.44	16.55	16.61	18.45	18.56	18.62
		25	25	21.36	21.55	21.32	16.31	16.50	16.27	18.32	18.51	18.28
		50	0	21.34	21.45	21.41	16.29	16.40	16.36	18.30	18.41	18.37
	64QAM	1	0	21.30	21.27	21.36	16.25	16.22	16.31	18.26	18.23	18.32
		1	25	21.84	22.06	21.77	16.79	17.01	16.72	18.80	19.02	18.73
		1	49	21.11	21.43	21.17	16.06	16.38	16.12	18.07	18.39	18.13
		25	0	20.43	20.48	20.50	15.38	15.43	15.45	17.39	17.44	17.46
		25	13	20.58	20.61	20.57	15.53	15.56	15.52	17.54	17.57	17.53
		25	25	20.33	20.59	20.29	15.28	15.54	15.24	17.29	17.55	17.25
		50	0	20.43	20.34	20.42	15.38	15.29	15.37	17.39	17.30	17.38

## 5.2. Occupied Bandwidth

### Ambient condition

Temperature	Relative humidity	Pressure
23°C ~25°C	45%~50%	101.5kPa

### Method of Measurement

The EUT was connected to Spectrum Analyzer and Base Station Simulator via power Splitter. The occupied bandwidth is measured using spectrum analyzer.

RBW is set to  $\geq 1\%EBW$ , VBW is set to 3x RBW.

99% power and -26dBc occupied bandwidths are recorded. Spectrum analyzer plots are included on the following pages.

### Test Setup

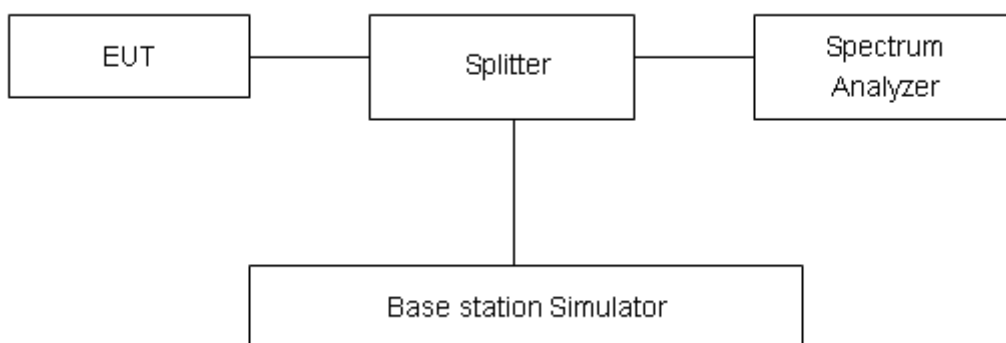

### Limits

No specific occupied bandwidth requirements in part 2.1049.

### Measurement Uncertainty

The assessed measurement uncertainty to ensure 95% confidence level for the normal distribution is with the coverage factor  $k = 2$ ,  $U = 624\text{Hz}$ .



## Test Result

Mode	Channel	Frequency (MHz)	99% Power Bandwidth (MHz)	-26dBc Bandwidth(MHz)
GSM 850 (GMSK)	128	824.2	0.249	0.311
	190	836.6	0.245	0.314
	251	848.8	0.244	0.305
GPRS 850 (GMSK)	128	824.2	0.241	0.310
	190	836.6	0.246	0.314
	251	848.8	0.248	0.317
EGPRS 850 (8PSK)	128	824.2	0.246	0.309
	190	836.6	0.251	0.313
	251	848.8	0.244	0.318
WCDMA Band V (RMC)	4132	826.4	4.123	4.708
	4183	836.6	4.106	4.668
	4233	846.6	4.120	4.684

LTE Band 5						
RB	Modulation	Bandwidth (MHz)	Channel	Frequency (MHz)	99% Power Bandwidth(MHz)	-26dBc Bandwidth(MHz)
100%	QPSK	1.4	20407	824.7	1.095	1.280
			20525	836.5	1.088	1.294
			20643	848.3	1.099	1.297
		3	20415	825.5	2.704	2.997
			20525	836.5	2.705	2.998
			20635	847.5	2.708	2.965
		5	20425	826.5	4.499	4.910
			20525	836.5	4.505	5.011
			20625	846.5	4.503	4.924
		10	20450	829	8.966	9.733
			20525	836.5	8.980	9.810
			20600	844	8.984	9.863
	16QAM	1.4	20407	824.7	1.096	1.300
			20525	836.5	1.097	1.283
			20643	848.3	1.099	1.254





		3	20415	825.5	2.687	3.008
			20525	836.5	2.708	2.995
			20635	847.5	2.699	2.985
		5	20425	826.5	4.513	5.009
			20525	836.5	4.497	4.976
			20625	846.5	4.510	4.948
		10	20450	829	8.964	9.742
			20525	836.5	8.968	9.743
			20600	844	8.958	9.883
	64QAM	1.4	20407	824.7	1.097	1.284
			20525	836.5	1.098	1.310
			20643	848.3	1.094	1.270
		3	20415	825.5	2.704	2.999
			20525	836.5	2.705	2.963
			20635	847.5	2.696	2.991
		5	20425	826.5	4.495	4.964
			20525	836.5	4.520	5.013
			20625	846.5	4.512	4.908
		10	20450	829	8.990	9.820
			20525	836.5	8.975	9.793
			20600	844	8.961	9.901

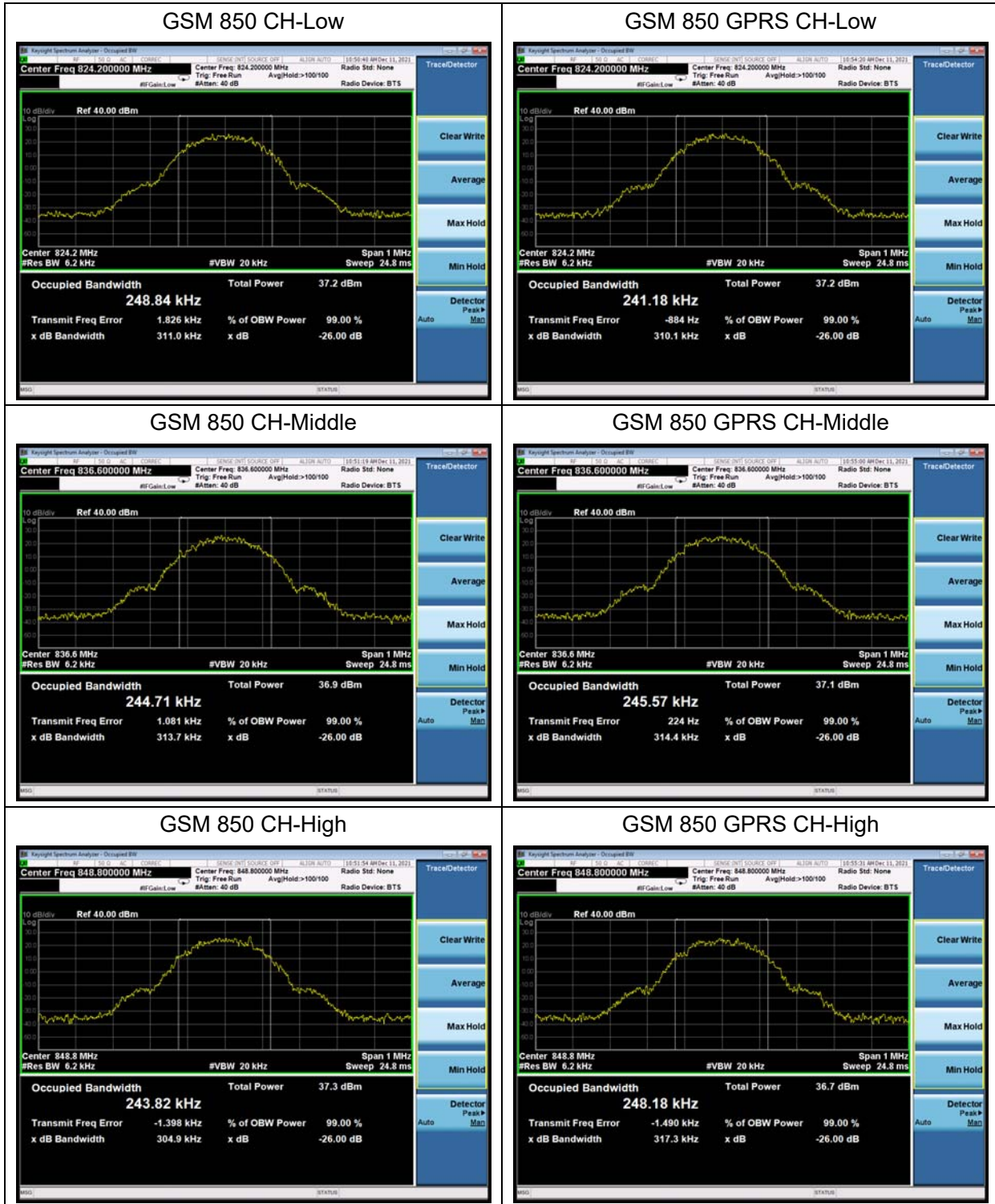

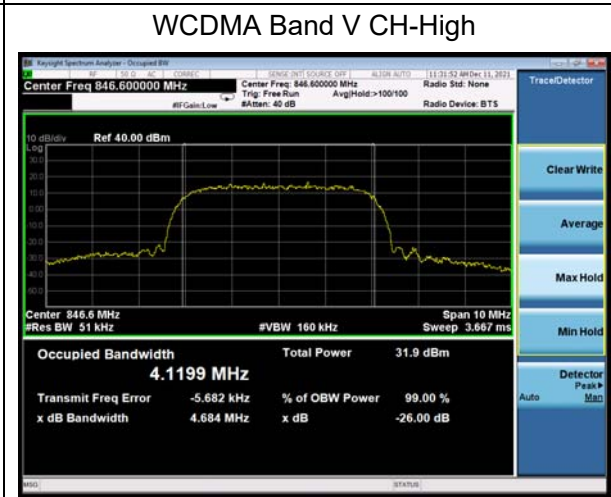
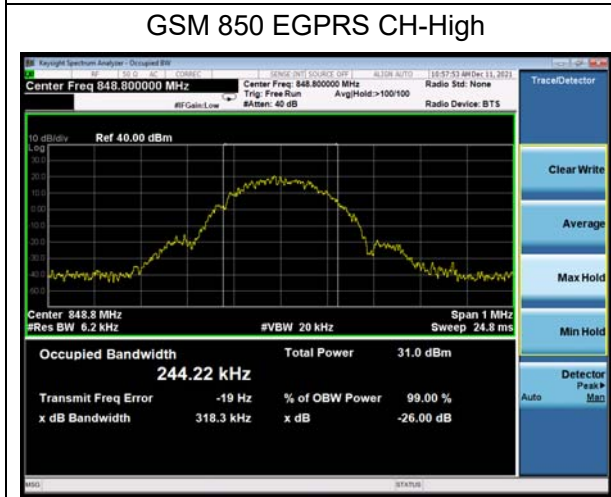
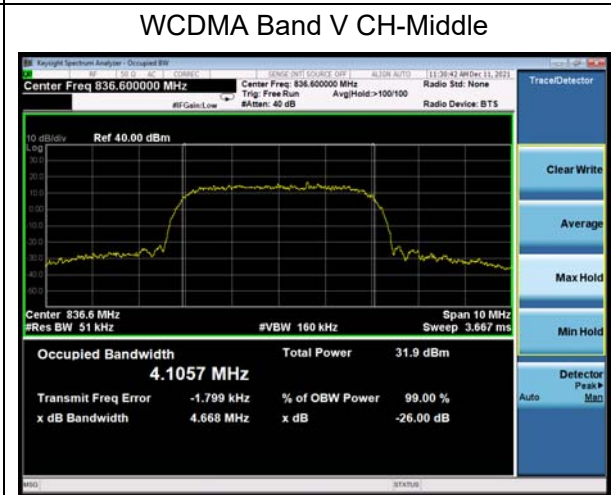
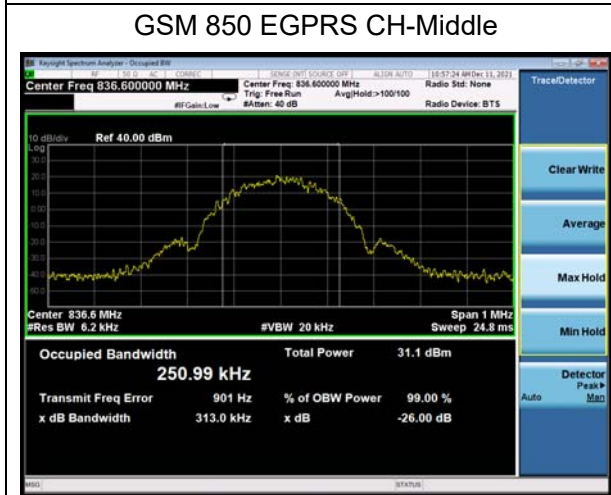
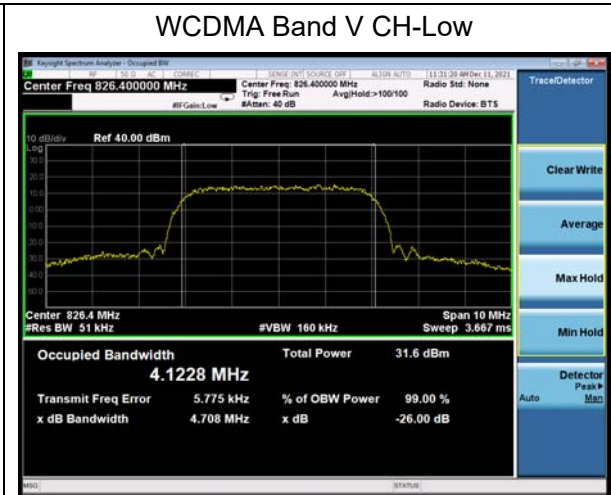
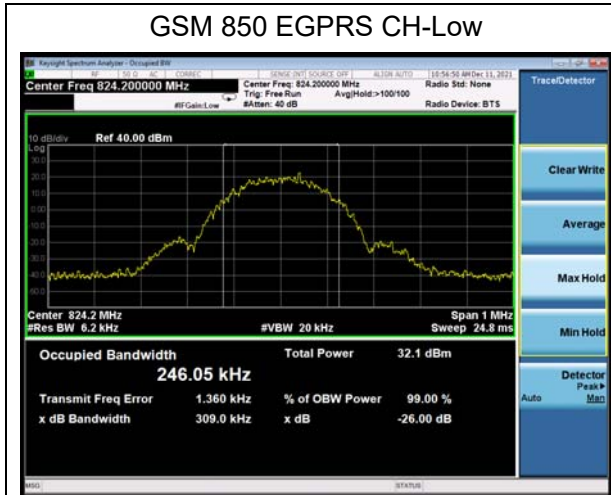

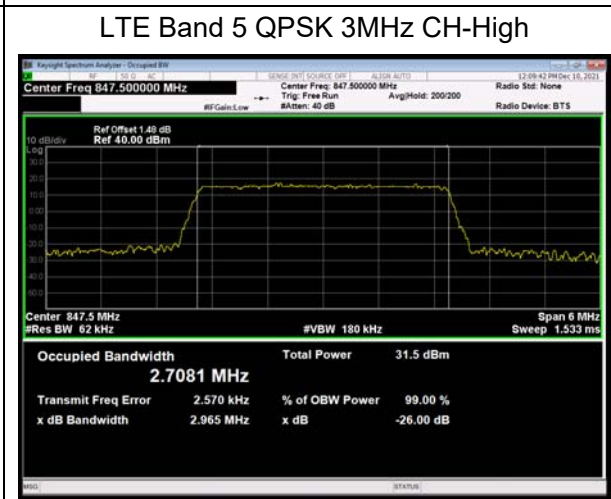
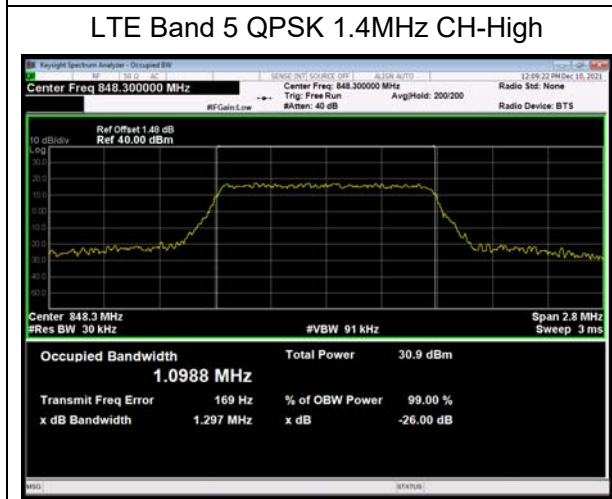
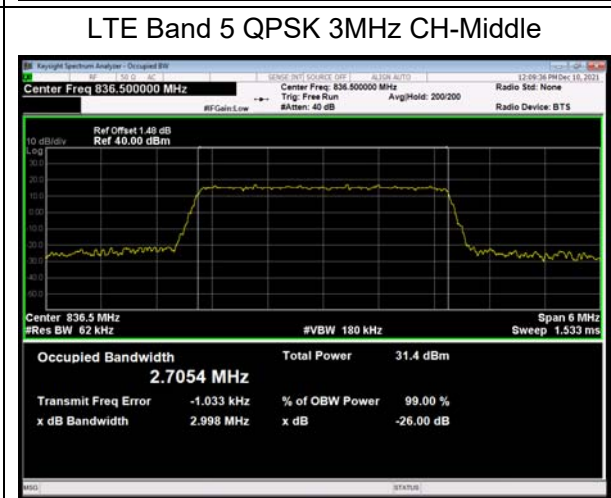
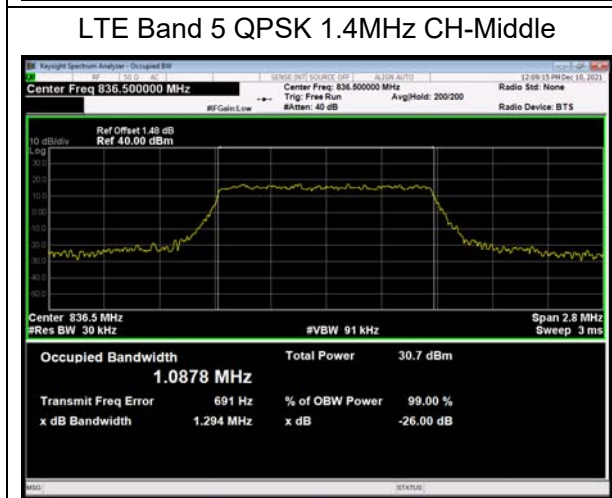
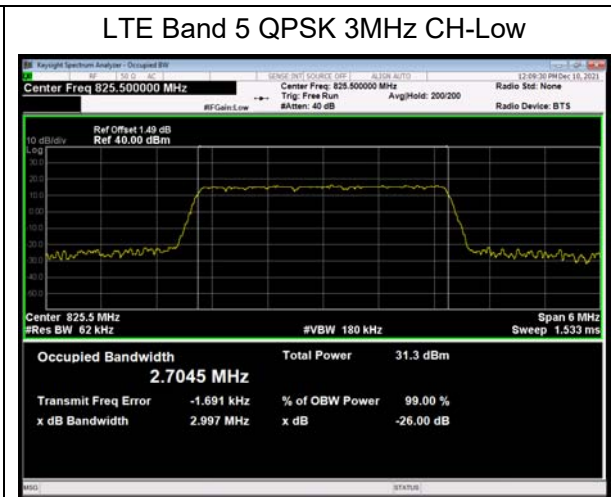
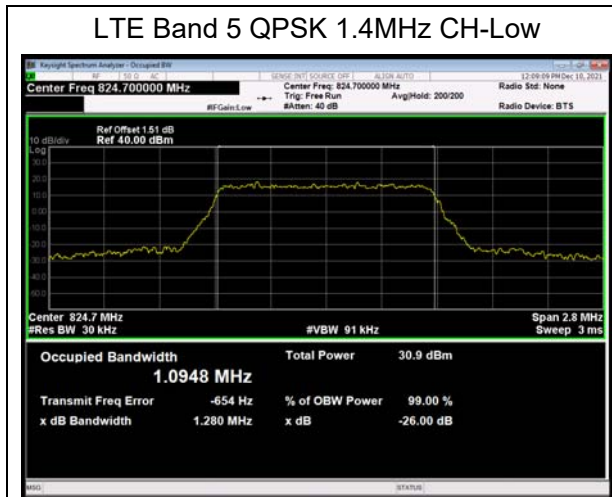

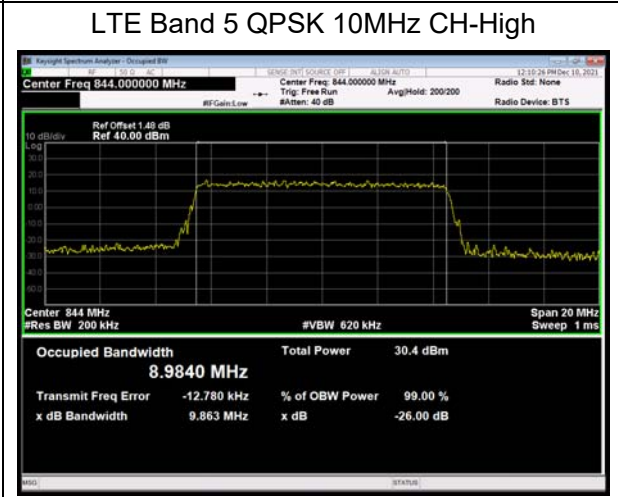
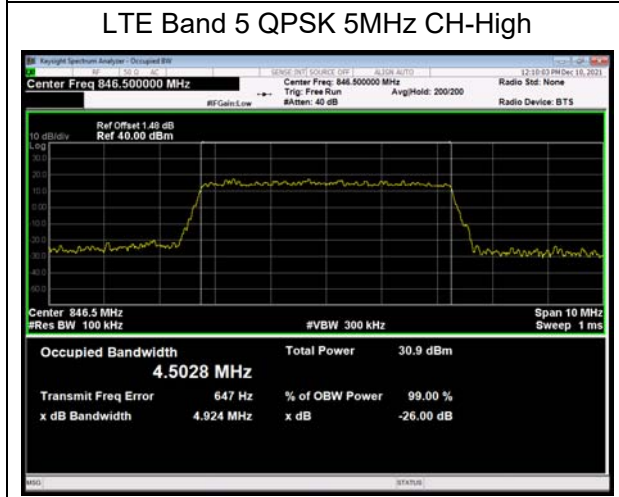
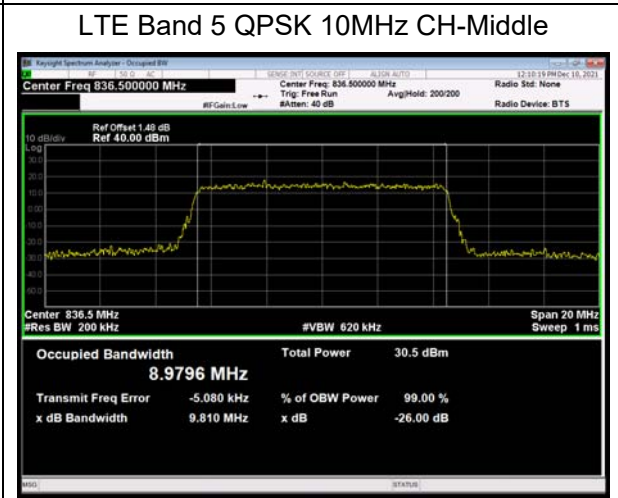
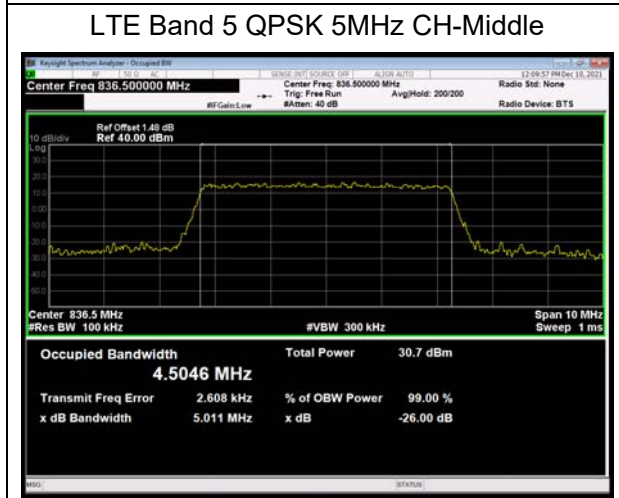
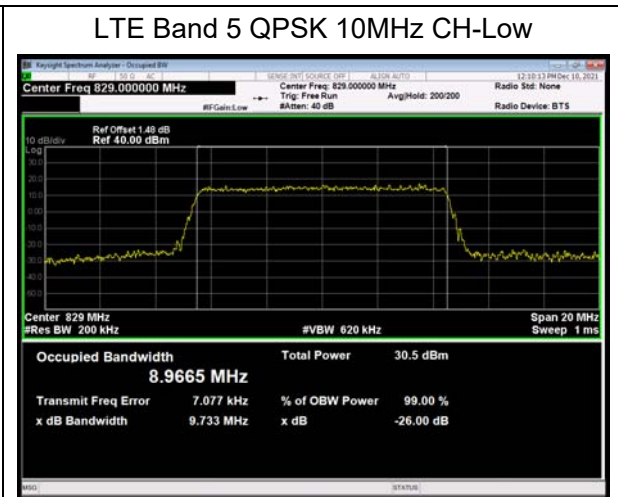
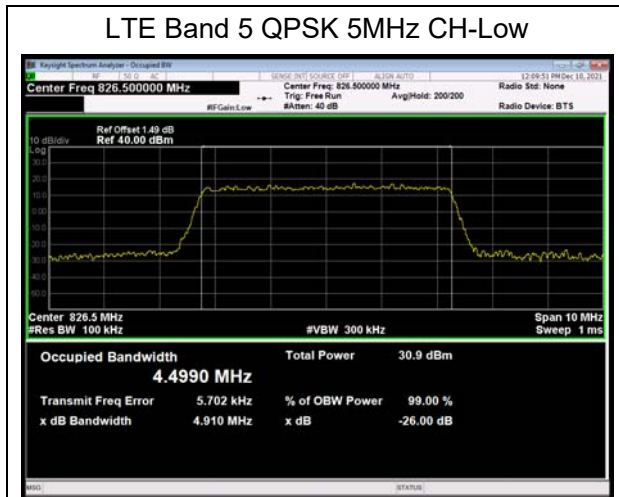



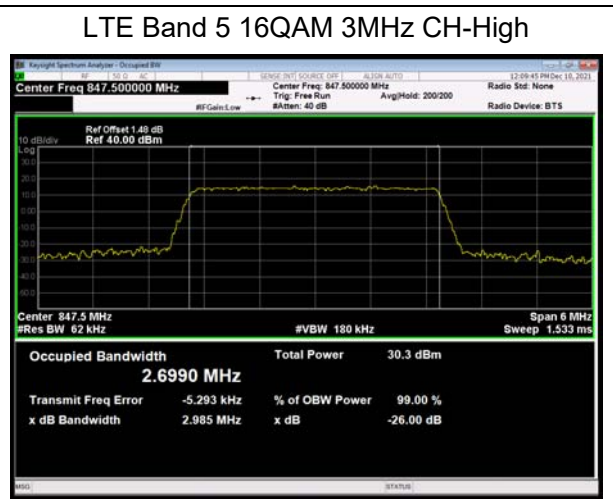
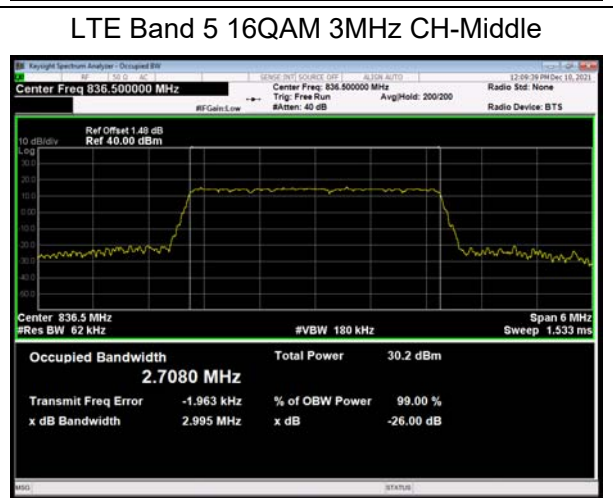
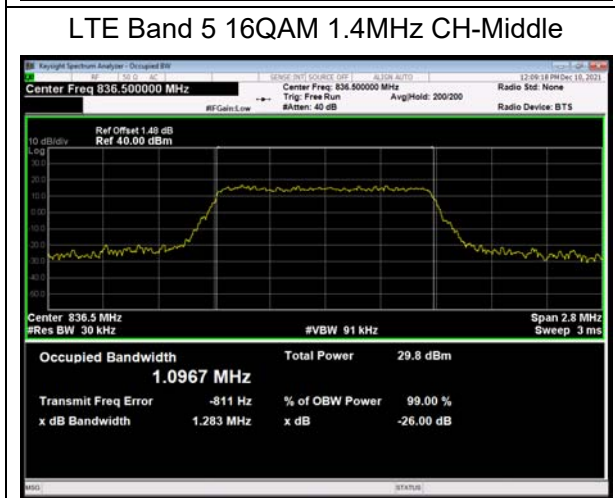
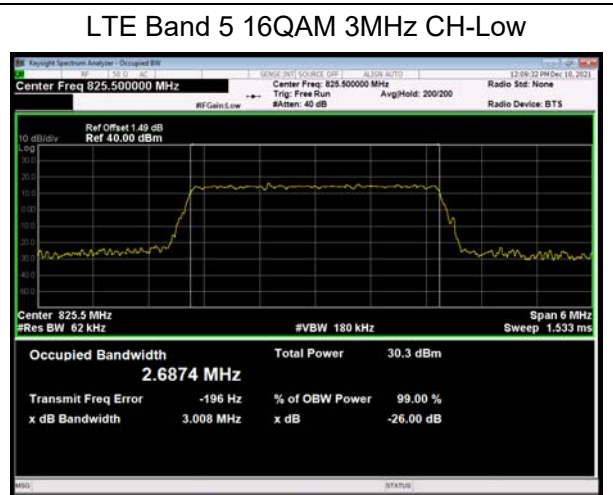
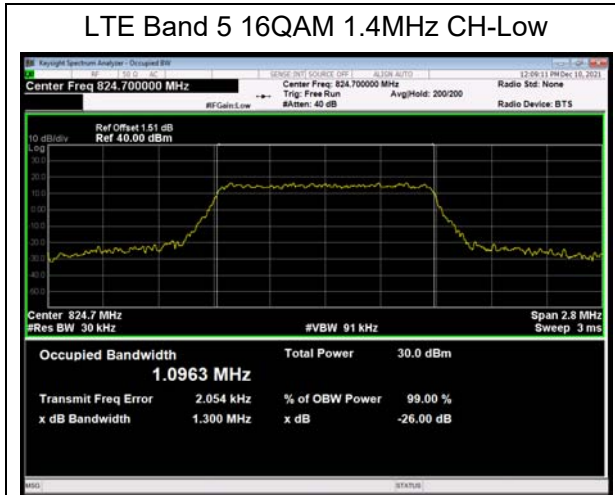

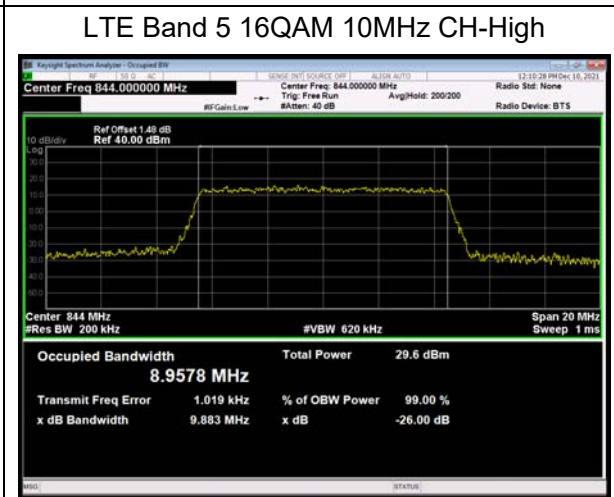
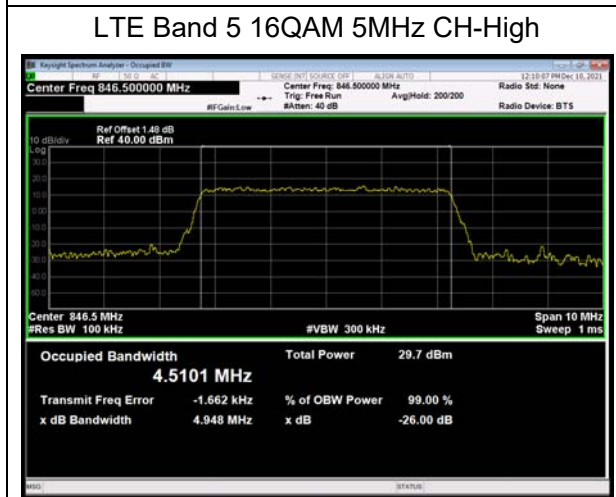
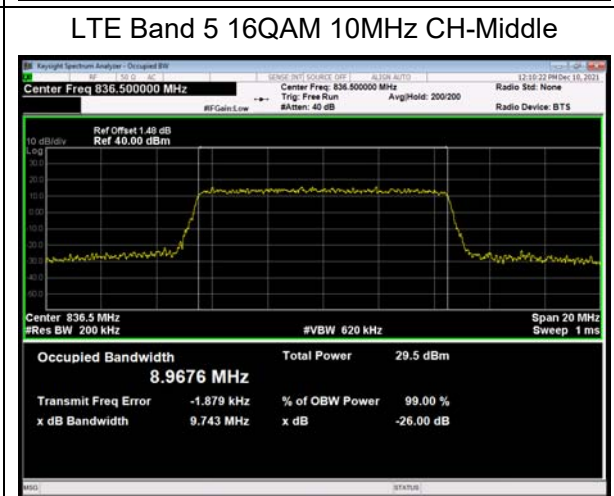
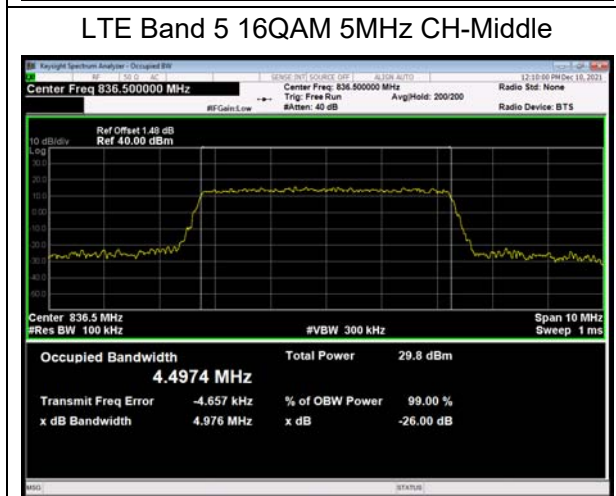
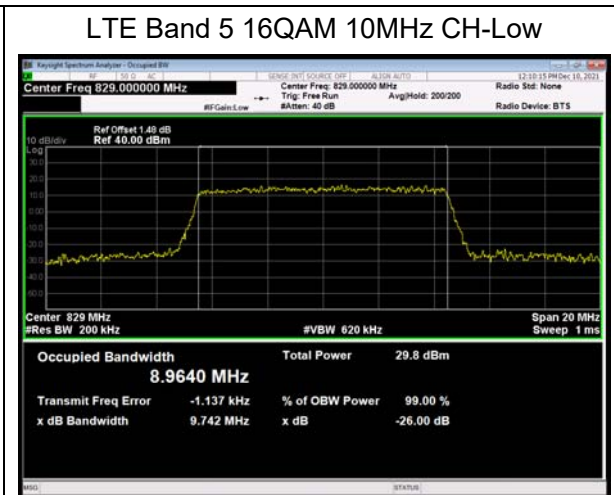
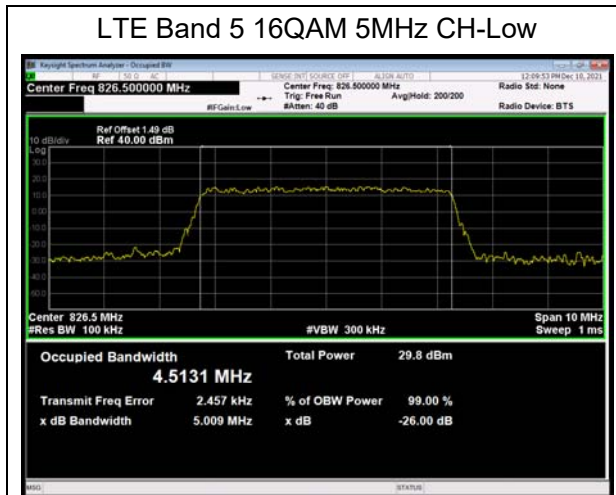

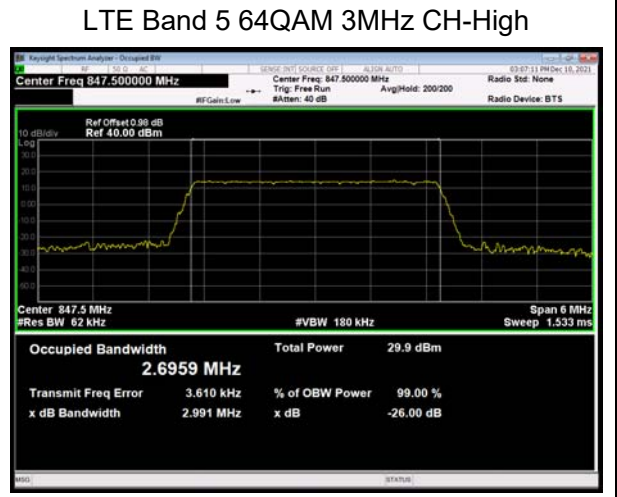
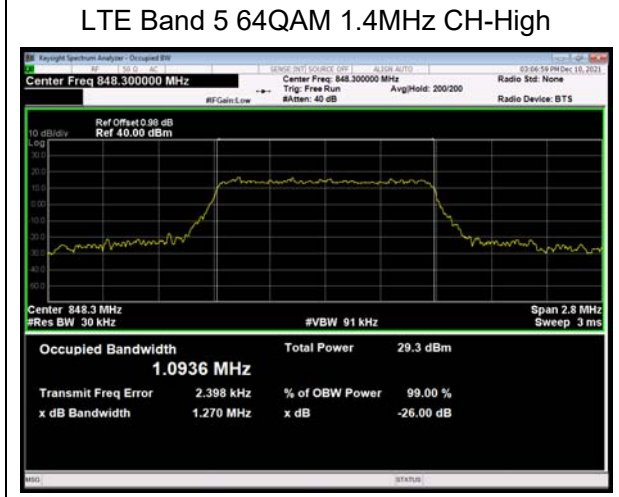
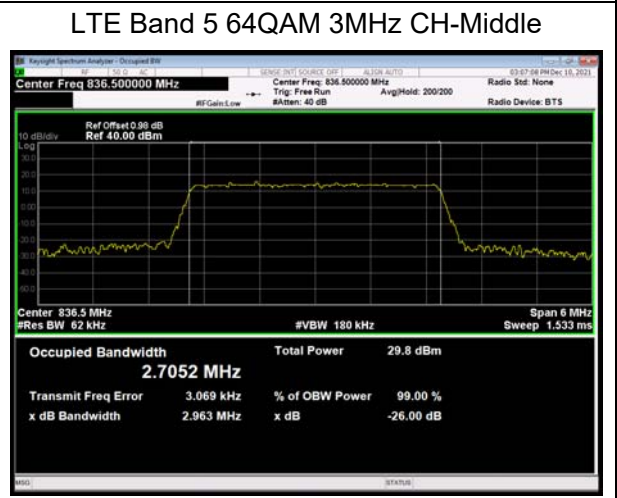
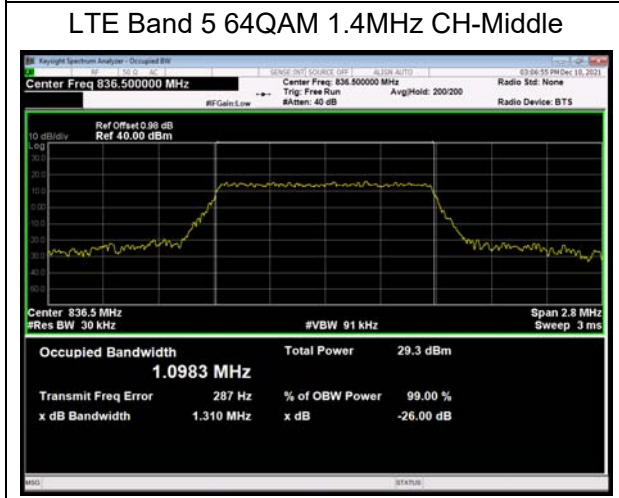
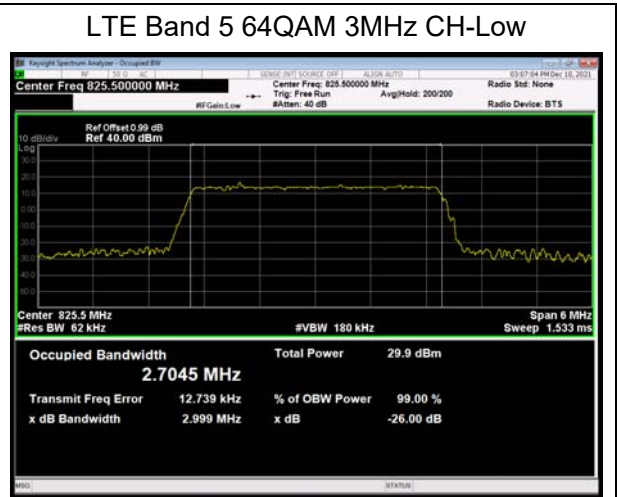
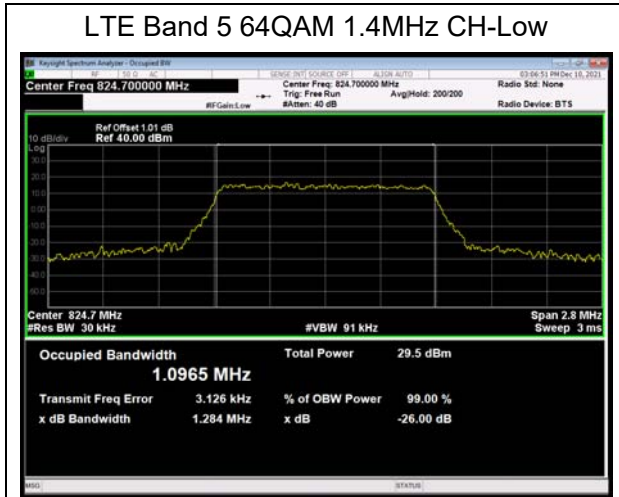



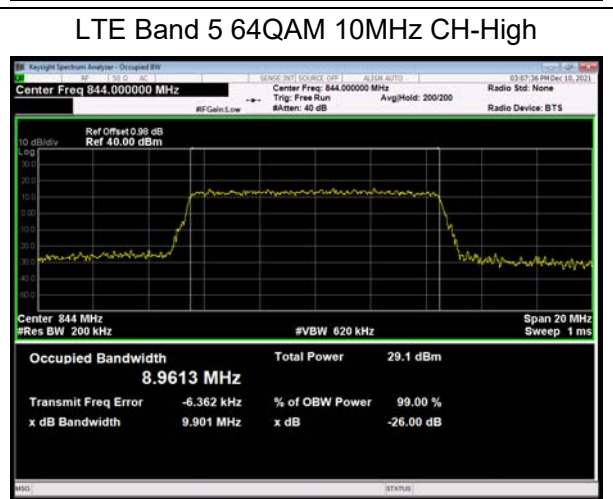
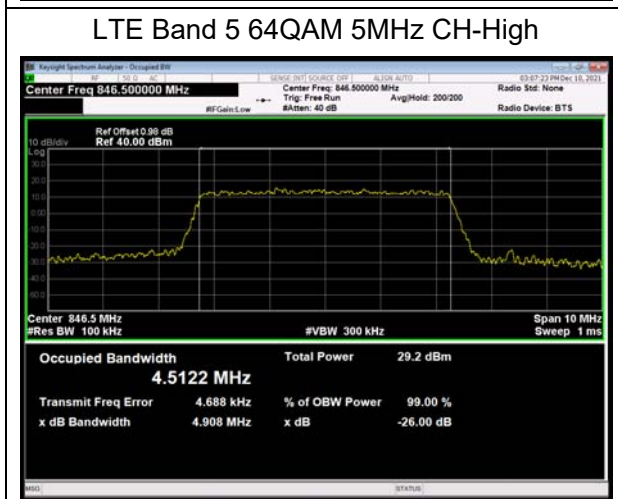
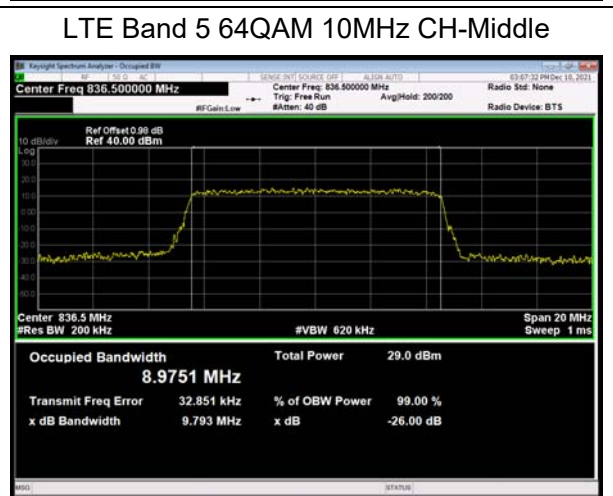
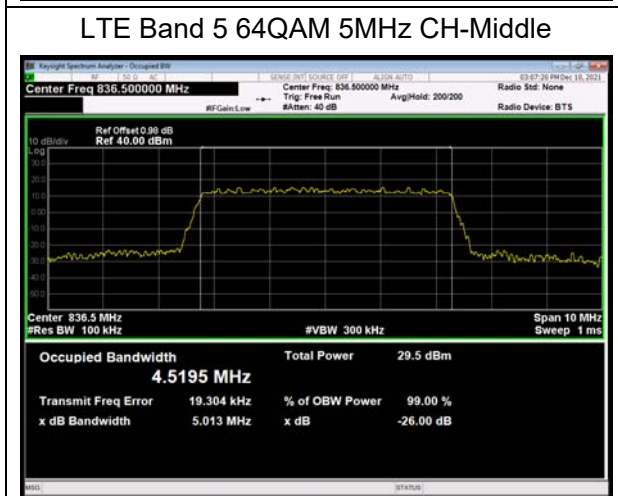
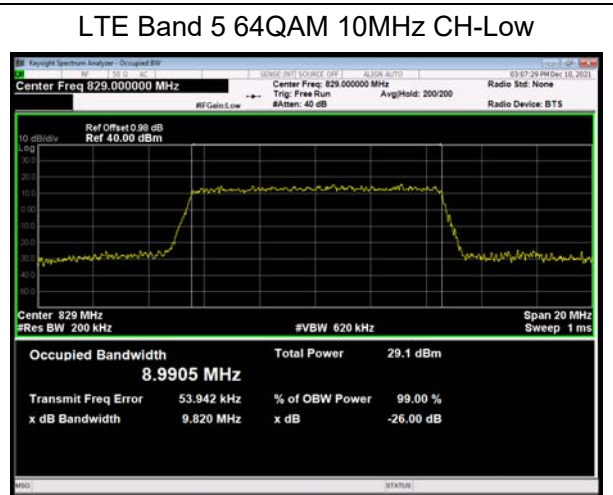
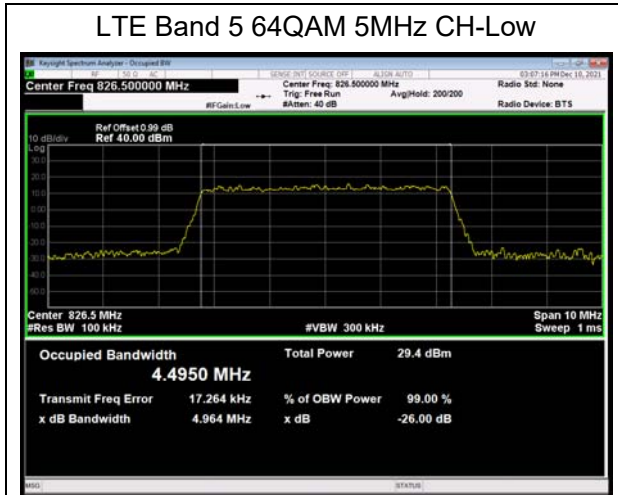

### 5.3. Band Edge Compliance

#### Ambient condition

Temperature	Relative humidity	Pressure
23°C ~25°C	45%~50%	101.5kPa

#### Method of Measurement

The EUT was connected to Spectrum Analyzer and Base Station Simulator via power Splitter. The band edge of the lowest and highest channels were measured. The average detector is used. RBW is set to  $\geq 1\%EBW$ , VBW is set to 3x RBW.

Spectrum analyzer plots are included on the following pages.

#### Test Setup

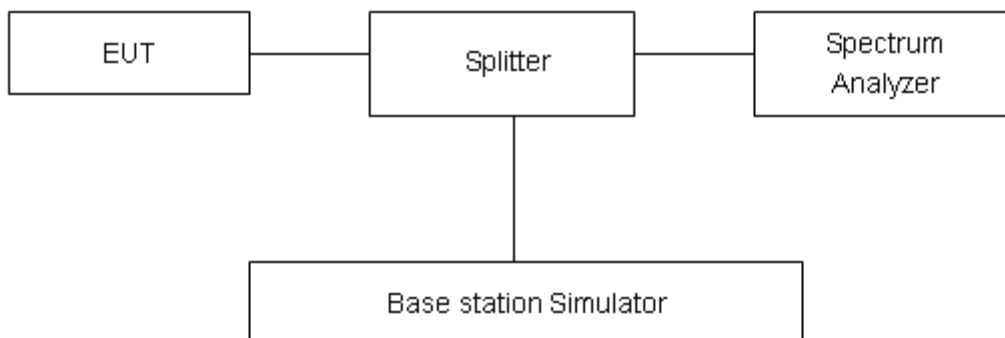

#### Limits

Rule Part 22.917(a) specifies that “The power of any emission outside of the authorized operating frequency ranges must be attenuated below the transmitting power (P) by a factor of at least 43 + 10 log(P) dB.”

Limit	-13 dBm
-------	---------

#### Measurement Uncertainty

The assessed measurement uncertainty to ensure 95% confidence level for the normal distribution is with the coverage factor  $k = 1.96$ ,  $U=0.684dB$ .

Test Result:

GSM 850 CH-Low



GSM 850 CH-High

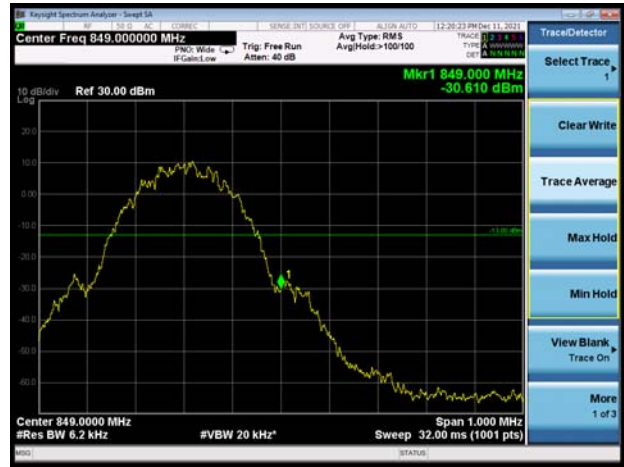

GSM 850 GPRS CH-Low



GSM 850 GPRS CH-High

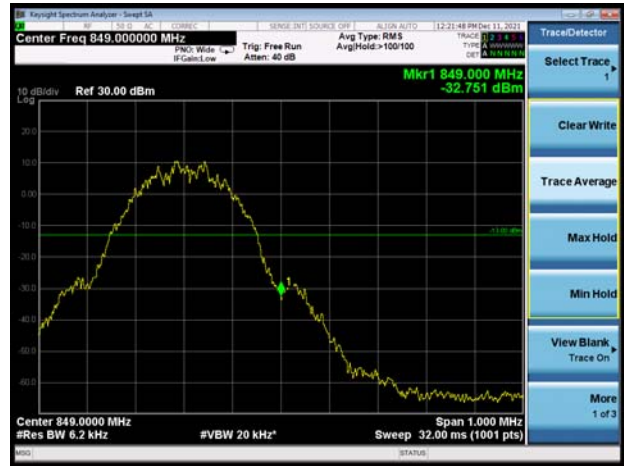

GSM 850 EGPRS CH-Low

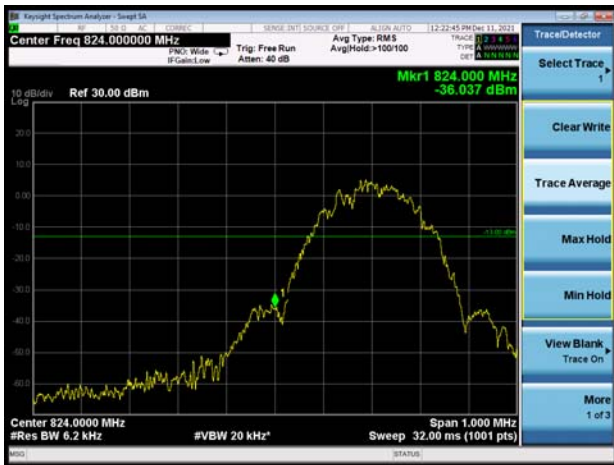

GSM 850 EGPRS CH-High





### WCDMA Band V CH-Low



### WCDMA Band V CH-High





### LTE Band 5 QPSK 1.4MHz CH-Low 1RB

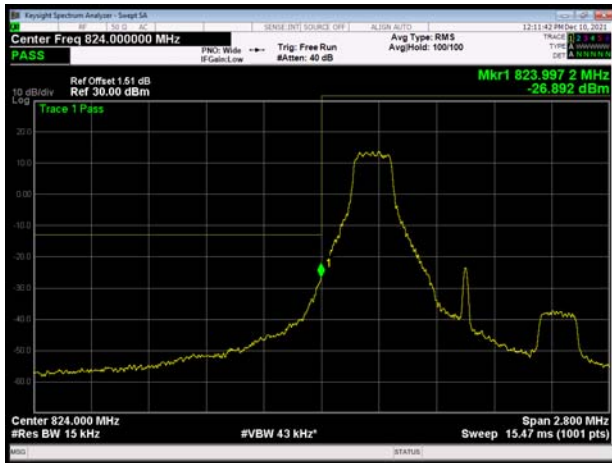

### LTE Band 5 QPSK 1.4MHz CH-High 1RB

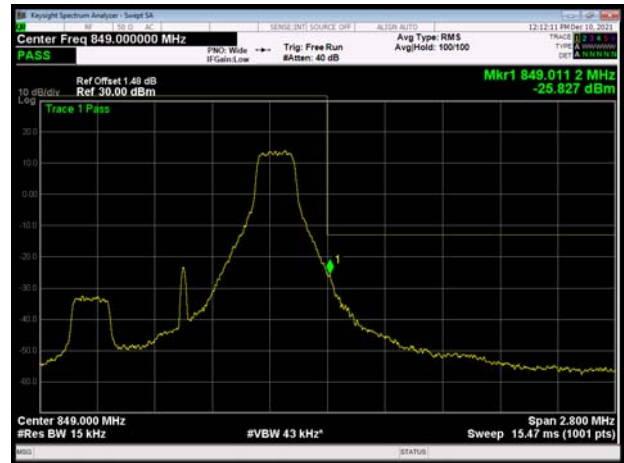

### LTE Band 5 QPSK 1.4MHz CH-Low 100%RB



### LTE Band 5 QPSK 1.4MHz CH-High 100%RB



### LTE Band 5 QPSK 3MHz CH-Low 1RB

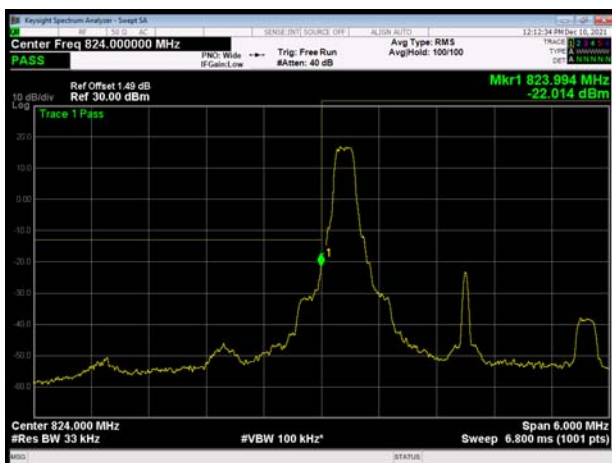

### LTE Band 5 QPSK 3MHz CH-High 1RB

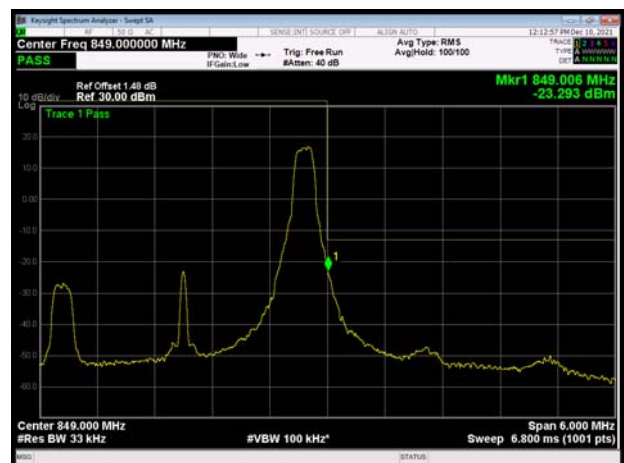





LTE Band 5 QPSK 3MHz CH-Low 100%RB

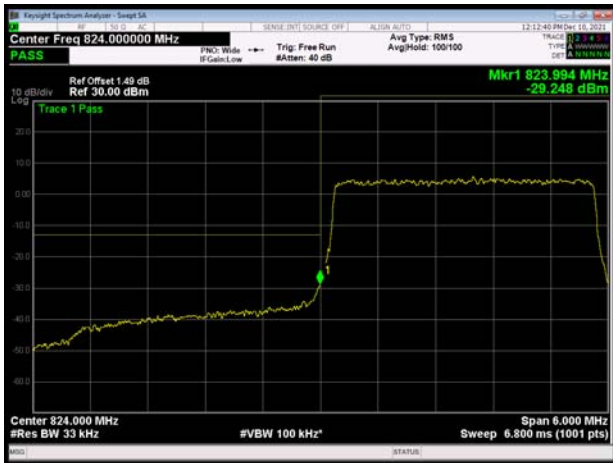

LTE Band 5 QPSK 3MHz CH-High 100%RB

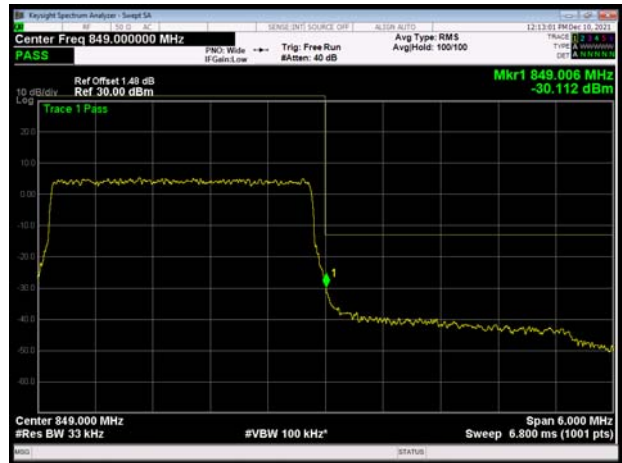

LTE Band 5 QPSK 5MHz CH-Low 1RB

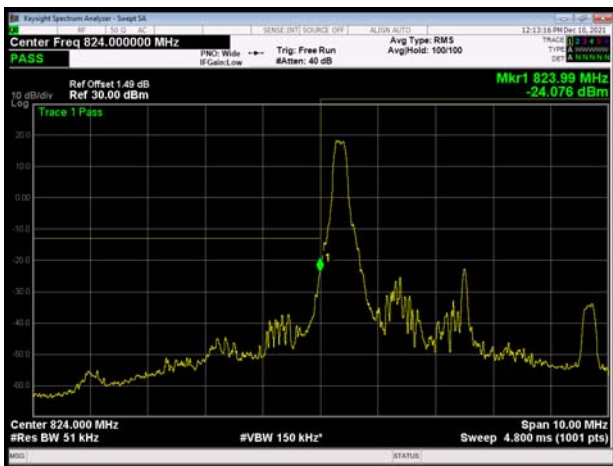

LTE Band 5 QPSK 5MHz CH-High 1RB

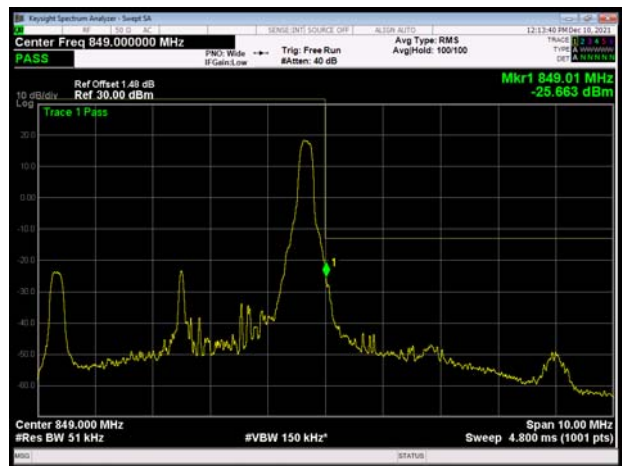

LTE Band 5 QPSK 5MHz CH-Low 100%RB

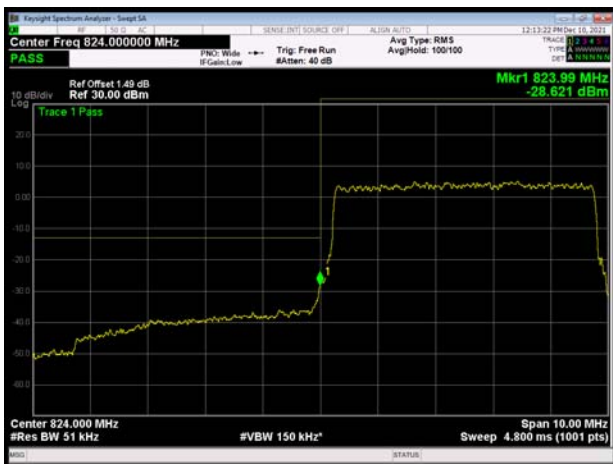

LTE Band 5 QPSK 5MHz CH-High 100%RB

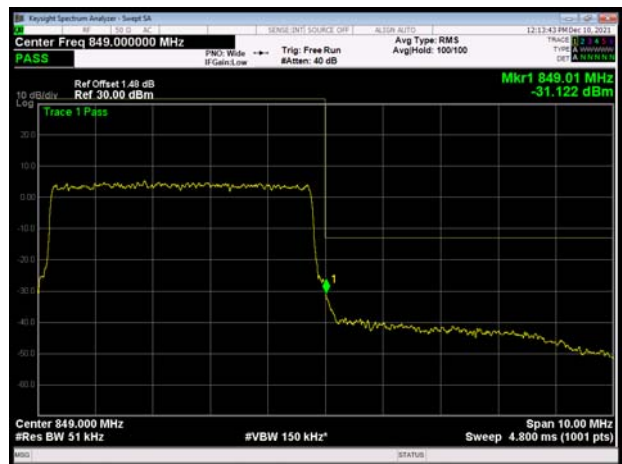



LTE Band 5 QPSK 10MHz CH-Low 1RB

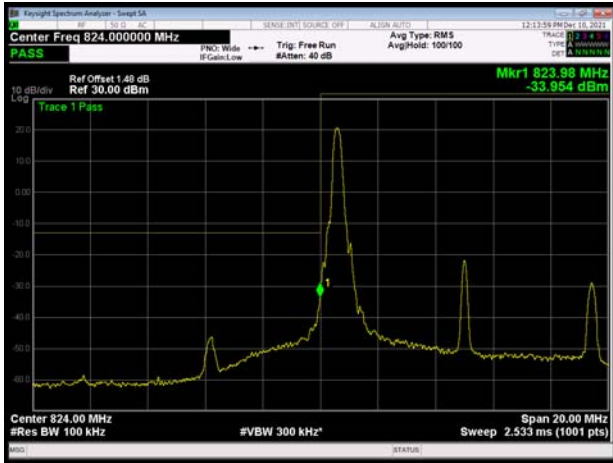

LTE Band 5 QPSK 10MHz CH-High 1RB

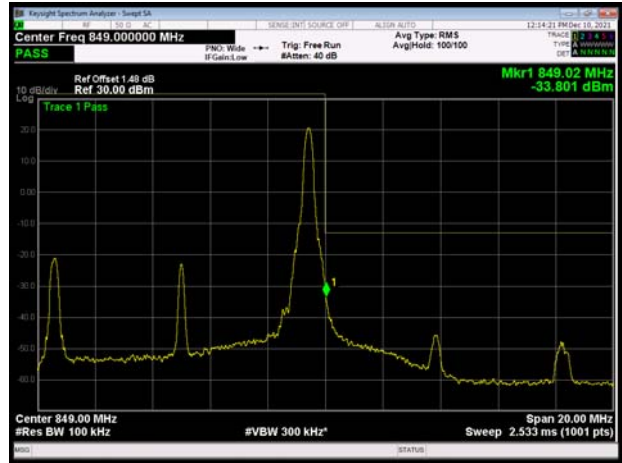

LTE Band 5 QPSK 10MHz CH-Low 100%RB

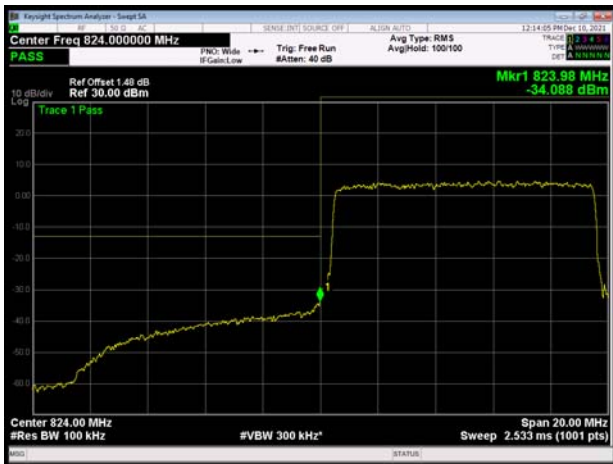

LTE Band 5 QPSK 10MHz CH-High 100%RB

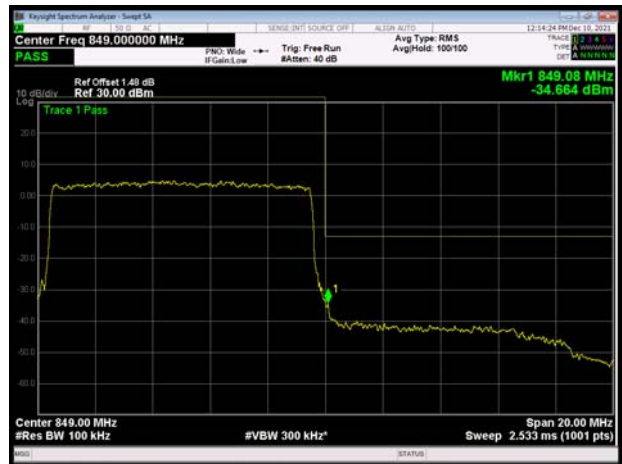

LTE Band 5 16QAM 1.4MHz CH-Low 1RB

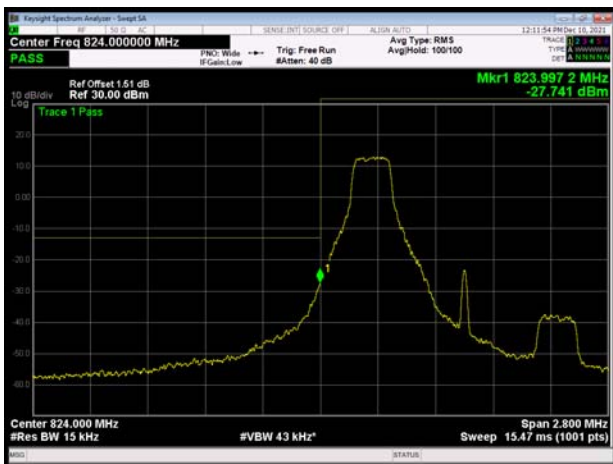

LTE Band 5 16QAM 1.4MHz CH-High 1RB

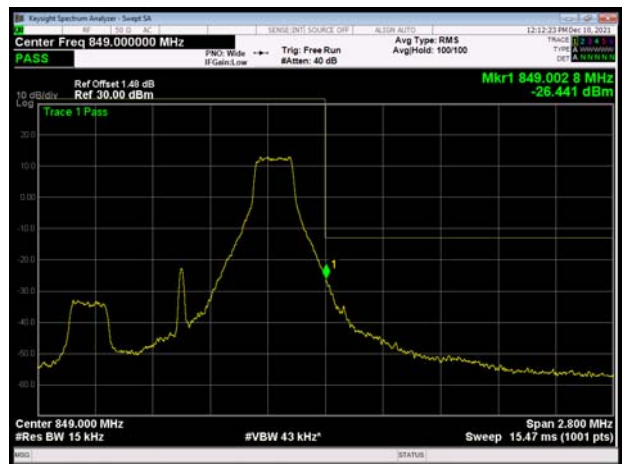



LTE Band 5 16QAM 1.4MHz CH-Low 100%RB



LTE Band 5 16QAM 1.4MHz CH-High 100%RB



LTE Band 5 16QAM 3MHz CH-Low 1RB

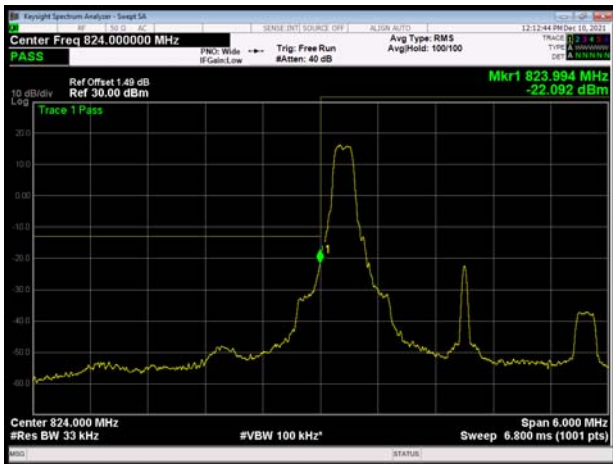

LTE Band 5 16QAM 3MHz CH-High 1RB

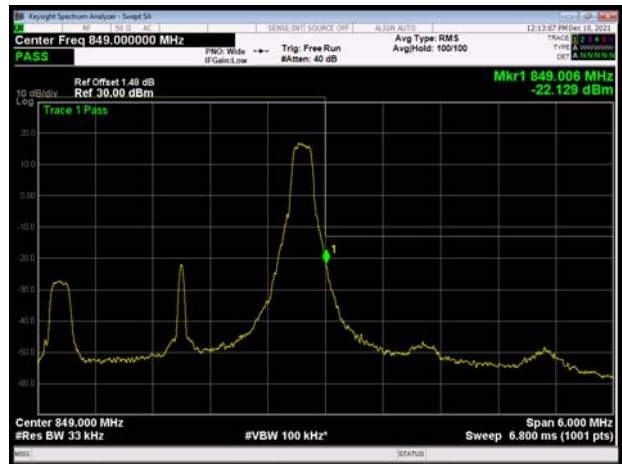

LTE Band 5 16QAM 3MHz CH-Low 100%RB

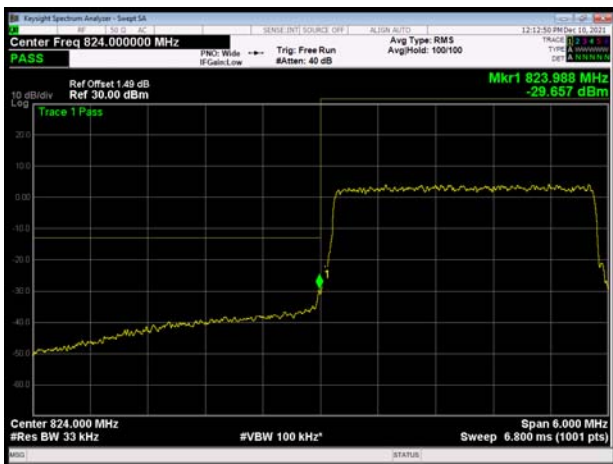

LTE Band 5 16QAM 3MHz CH-High 100%RB

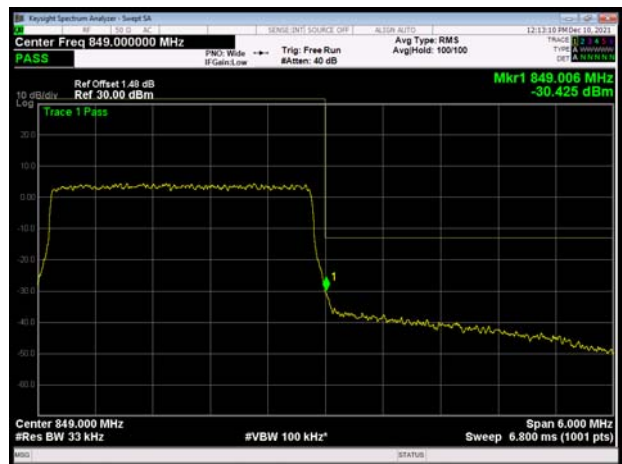





LTE Band 5 16QAM 5MHz CH-Low 1RB

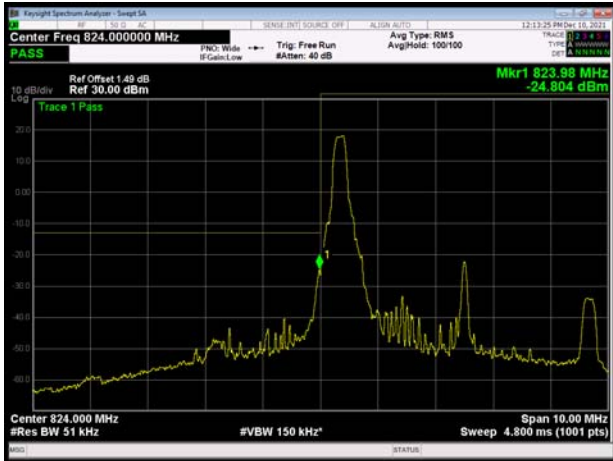

LTE Band 5 16QAM 5MHz CH-High 1RB

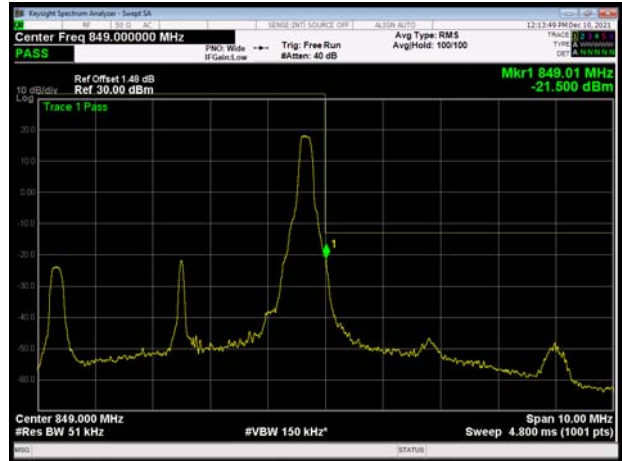

LTE Band 5 16QAM 5MHz CH-Low 100%RB

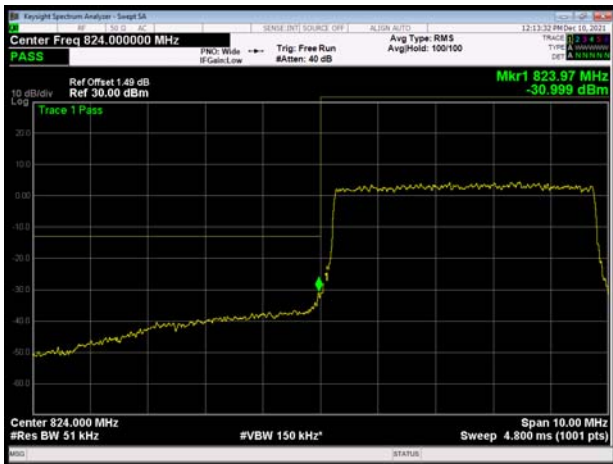

LTE Band 5 16QAM 5MHz CH-High 100%RB

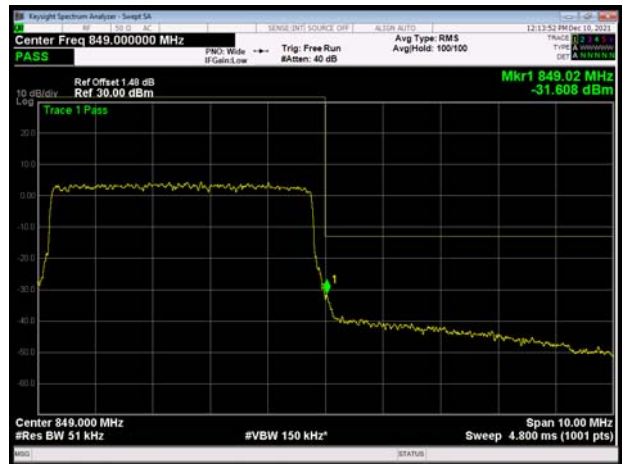

LTE Band 5 16QAM 10MHz CH-Low 1RB

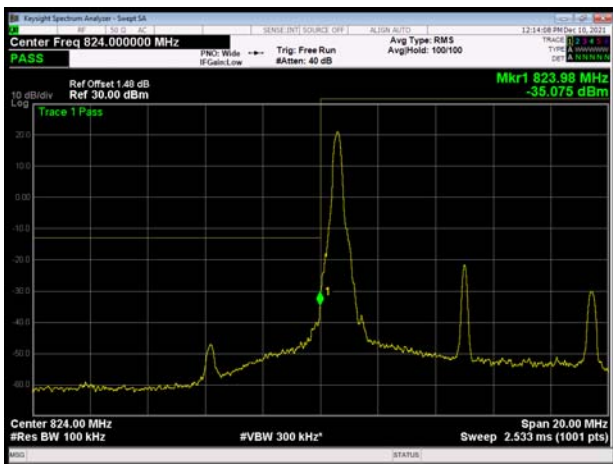

LTE Band 5 16QAM 10MHz CH-High 1RB

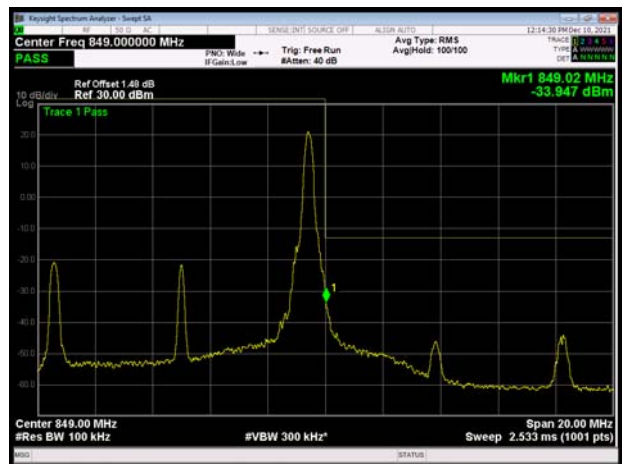



LTE Band 5 16QAM 10MHz CH-Low 100%RB

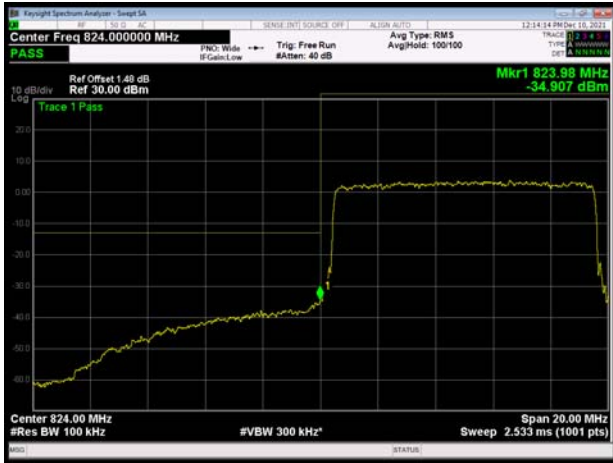

LTE Band 5 16QAM 10MHz CH-High 100%RB

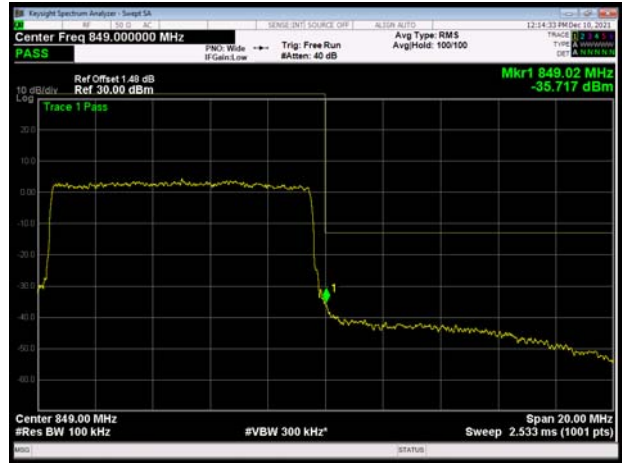

LTE Band 5 64QAM 1.4MHz CH-Low 1RB

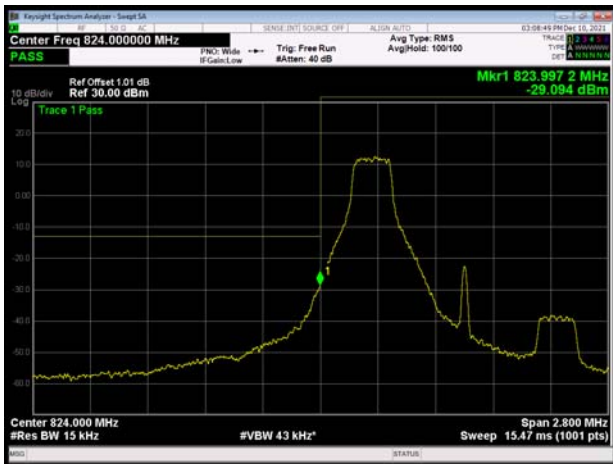

LTE Band 5 64QAM 1.4MHz CH-High 1RB

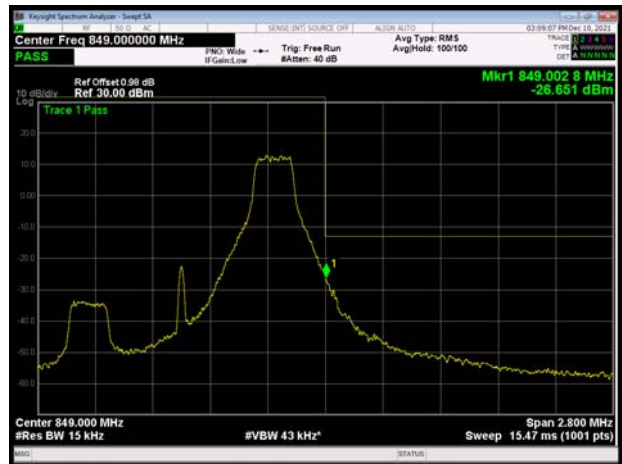

LTE Band 5 64QAM 1.4MHz CH-Low 100%RB

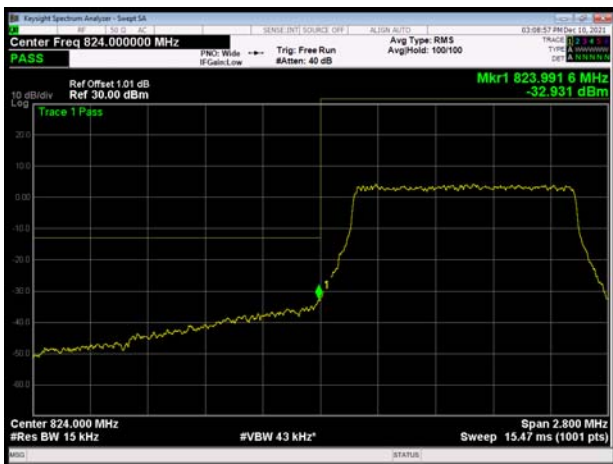

LTE Band 5 64QAM 1.4MHz CH-High 100%RB



LTE Band 5 64QAM 3MHz CH-Low 1RB

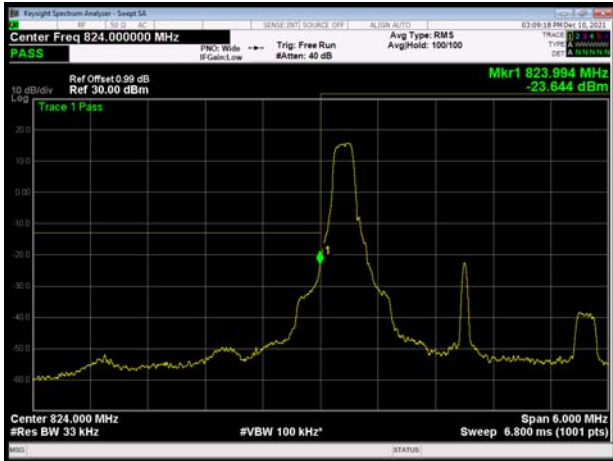

LTE Band 5 64QAM 3MHz CH-High 1RB

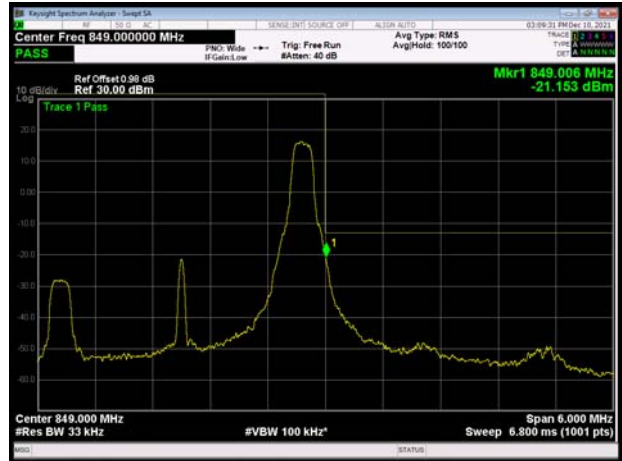

LTE Band 5 64QAM 3MHz CH-Low 100%RB

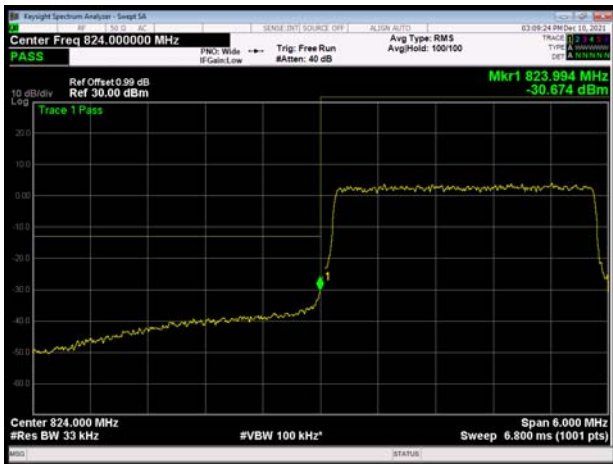

LTE Band 5 64QAM 3MHz CH-High 100%RB



LTE Band 5 64QAM 5MHz CH-Low 1RB

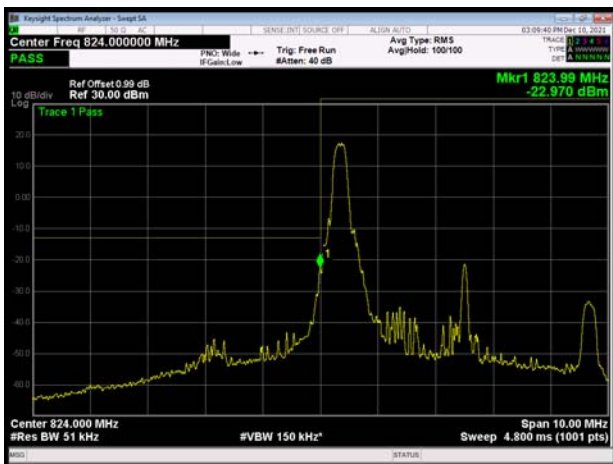

LTE Band 5 64QAM 5MHz CH-High 1RB

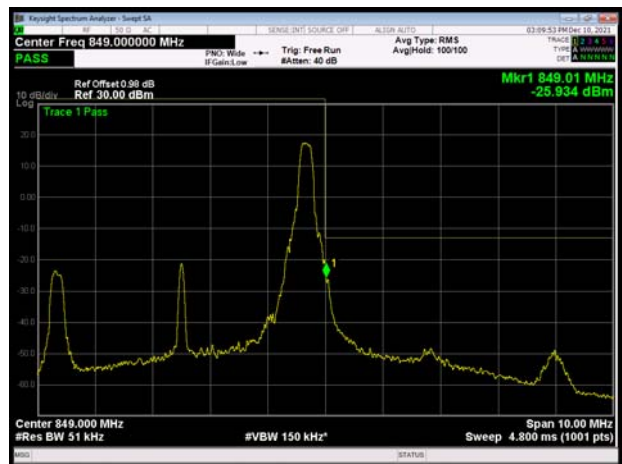



LTE Band 5 64QAM 5MHz CH-Low 100%RB

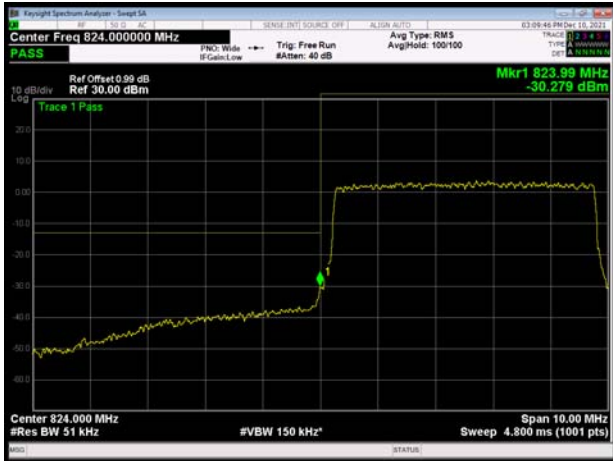

LTE Band 5 64QAM 5MHz CH-High 100%RB

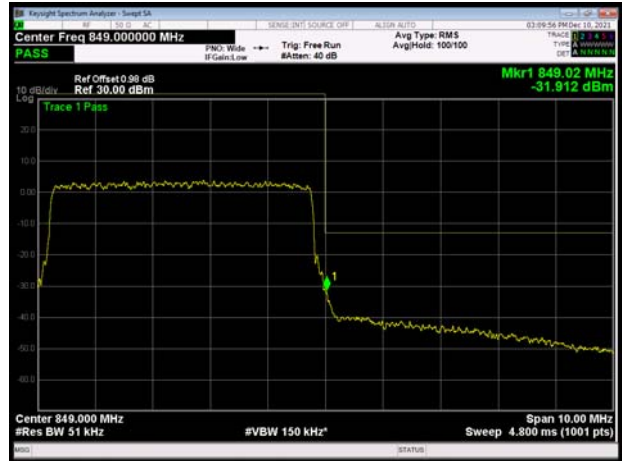

LTE Band 5 64QAM 10MHz CH-Low 1RB

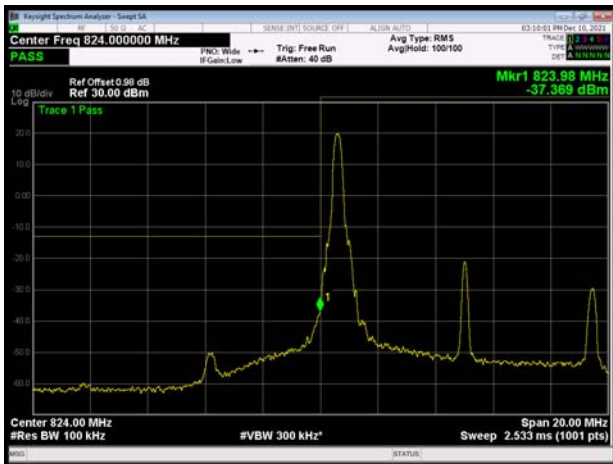

LTE Band 5 64QAM 10MHz CH-High 1RB

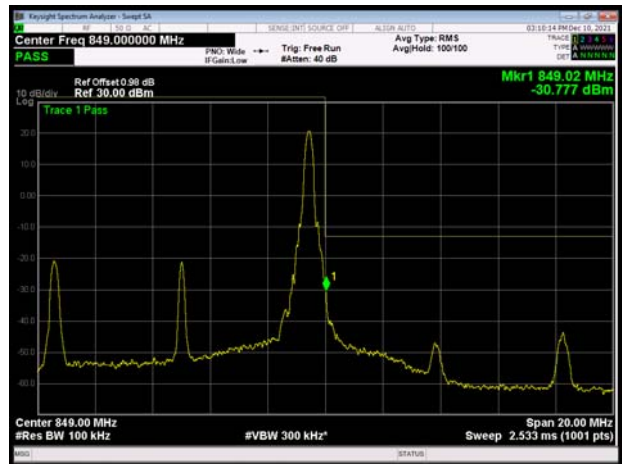

LTE Band 5 64QAM 10MHz CH-Low 100%RB

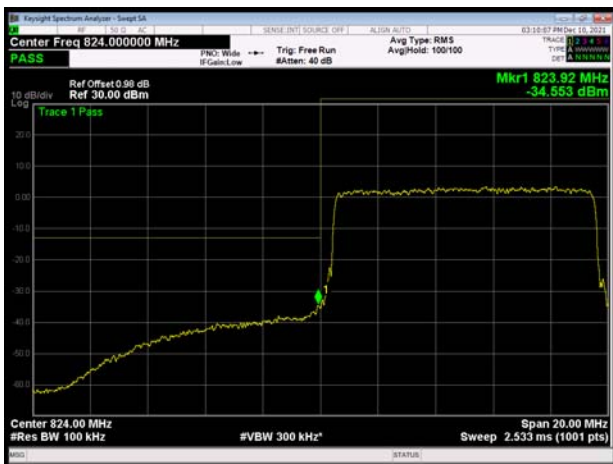

LTE Band 5 64QAM 10MHz CH-High 100%RB





## 5.4. Peak-to-Average Power Ratio (PAPR)

### Ambient condition

Temperature	Relative humidity	Pressure
23°C ~25°C	45%~50%	101.5kPa

### Methods of Measurement

Measure the total peak power and record as  $P_{Pk}$ . And measure the total average power and record as  $P_{Avg}$ . Both the peak and average power levels must be expressed in the same logarithmic units (e.g., dBm). Determine the PAPR from:

$$PAPR (dB) = P_{Pk} (dBm) - P_{Avg} (dBm).$$

### Test Setup

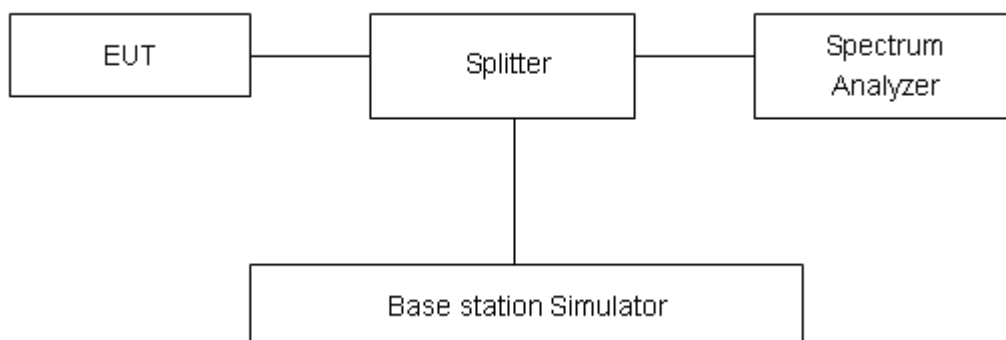

### Limits

According to the Sec. 22.913(d), The peak-to-average ratio (PAR) of the transmission must not exceed 13 dB.

### Measurement Uncertainty

The assessed measurement uncertainty to ensure 95% confidence level for the normal distribution is with the coverage factor  $k = 2$ ,  $U = 0.4$  dB.

**Test Results**

Mode	Channel	Frequency (MHz)	Peak (dBm)	Avg (dBm)	PAPR (dB)	Limit (dB)	Conclusion
GSM 850 (GMSK)	128	824.2	31.24	28.50	2.74	≤13	PASS
	190	836.6	31.12	28.36	2.76	≤13	PASS
	251	848.8	31.40	28.62	2.78	≤13	PASS
GPRS 850 (GMSK)	128	824.2	31.34	28.60	2.74	≤13	PASS
	190	836.6	31.35	28.60	2.75	≤13	PASS
	251	848.8	31.48	28.70	2.78	≤13	PASS
EGPRS 850 (8PSK)	128	824.2	28.75	22.87	5.88	≤13	PASS
	190	836.6	28.70	22.82	5.88	≤13	PASS
	251	848.8	28.70	22.82	5.88	≤13	PASS
WCDMA Band V (RMC)	4132	826.4	25.95	23.09	2.86	≤13	PASS
	4183	836.6	25.82	23.10	2.72	≤13	PASS
	4233	846.6	25.83	22.98	2.85	≤13	PASS

LTE Band 5								
Modulation	Bandwidth (MHz)	Channel	Frequency (MHz)	Peak (dBm)	Avg (dBm)	PAPR (dB)	Limit (dB)	Conclusion
QPSK	1.4	20407	824.7	28.01	22.73	5.28	≤13	PASS
		20525	836.5	27.73	22.76	4.97	≤13	PASS
		20643	848.3	27.95	22.92	5.03	≤13	PASS
	3	20415	825.5	28.14	22.84	5.30	≤13	PASS
		20525	836.5	27.78	22.76	5.02	≤13	PASS
		20635	847.5	27.91	22.72	5.19	≤13	PASS
	5	20425	826.5	28.11	22.85	5.26	≤13	PASS
		20525	836.5	27.80	22.78	5.02	≤13	PASS
		20625	846.5	27.96	22.80	5.16	≤13	PASS
	10	20450	829	27.97	22.79	5.18	≤13	PASS
		20525	836.5	27.77	22.64	5.13	≤13	PASS
		20600	844	27.83	22.65	5.18	≤13	PASS
16QAM	1.4	20407	824.7	27.75	21.69	6.06	≤13	PASS
		20525	836.5	27.60	21.80	5.80	≤13	PASS
		20643	848.3	27.99	21.96	6.03	≤13	PASS
	3	20415	825.5	27.79	21.70	6.09	≤13	PASS
		20525	836.5	27.68	21.77	5.91	≤13	PASS



	5	20635	847.5	27.84	21.82	6.02	≤13	PASS	
		20425	826.5	27.87	21.85	6.02	≤13	PASS	
		20525	836.5	27.60	21.72	5.88	≤13	PASS	
		20625	846.5	27.70	21.70	6.00	≤13	PASS	
	10	20450	829	27.71	21.68	6.03	≤13	PASS	
		20525	836.5	27.56	21.58	5.98	≤13	PASS	
		20600	844	27.75	21.74	6.01	≤13	PASS	
	64QAM	1.4	20407	824.7	27.36	21.29	6.07	≤13	PASS
			20525	836.5	27.18	21.32	5.86	≤13	PASS
20643			848.3	27.36	21.48	5.88	≤13	PASS	
3		20415	825.5	27.38	21.31	6.07	≤13	PASS	
		20525	836.5	27.18	21.33	5.85	≤13	PASS	
		20635	847.5	27.37	21.34	6.03	≤13	PASS	
5		20425	826.5	27.42	21.46	5.96	≤13	PASS	
		20525	836.5	27.15	21.30	5.85	≤13	PASS	
		20625	846.5	27.34	21.38	5.96	≤13	PASS	
10		20450	829	27.30	21.29	6.01	≤13	PASS	
		20525	836.5	27.11	21.15	5.96	≤13	PASS	
		20600	844	27.20	21.16	6.04	≤13	PASS	

### 5.5. Frequency Stability

#### Ambient condition

Temperature	Relative humidity	Pressure
23°C ~25°C	45%~50%	101.5kPa

#### Method of Measurement

##### Frequency Stability (Temperature Variation)

The temperature inside the climate chamber is varied from -30°C to +50°C in 10°C step size,

(1) With all power removed, the temperature was decreased to 0°C and permitted to stabilize for three hours.

(2) Measure the carrier frequency with the test equipment in a “call mode”. These measurements should be made within 1 minute of powering up the mobile station, to prevent significant self warming.

(3) Repeat the above measurements at 10°C increments from -30°C to +50°C. Allow at least 1.5 hours at each temperature, un-powered, before making measurements. Frequency Stability (Voltage Variation)

The frequency stability shall be measured with variation of primary supply voltage as follows:

**Primary Supply Voltage:** The primary supply voltage is varied from 85% to 115% of the nominal value for non hand-carried battery and AC powered equipment. For hand-carried, battery-powered equipment, primary supply voltage is reduced to the battery operating end point which shall be specified by the manufacturer.

This transceiver is specified to operate with an input voltage of between 3.6 V and 4.2 V, with a nominal voltage of 3.87V.

#### Test setup

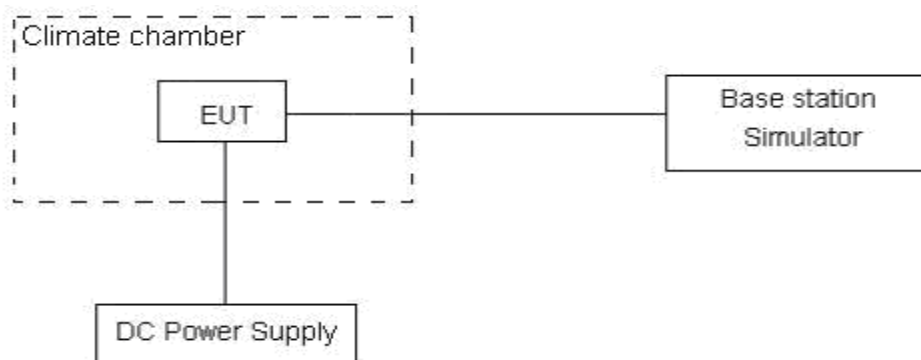

#### Limits

According to the Sec. 22.355, the frequency stability of the carrier shall be accurate to within 2.5 ppm of the received frequency for mobile stations.

Limits	≤ 2.5 ppm
--------	-----------

#### Measurement Uncertainty

The assessed measurement uncertainty to ensure 99.75% confidence level for the normal distribution is with the coverage factor  $k = 3$ ,  $U = 0.01\text{ppm}$ .



**Test Result**

GSM850						
Condition		Freq.Error (Hz)	Freq.Error (Hz)	Frequency Stability (ppm)	Frequency Stability (ppm)	Verdict
Temperature	Voltage	GMSK	8PSK	GMSK	8PSK	
Normal (25°C)	Normal	16.95	11.77	0.02026	0.01406	PASS
Extreme (50°C)		9.89	14.23	0.01182	0.01700	PASS
Extreme (40°C)		4.89	16.85	0.00584	0.02014	PASS
Extreme (30°C)		7.53	7.73	0.00900	0.00924	PASS
Extreme (20°C)		5.72	13.53	0.00684	0.01618	PASS
Extreme (10°C)		11.42	16.87	0.01365	0.02017	PASS
Extreme (0°C)		13.09	13.66	0.01565	0.01633	PASS
Extreme (-10°C)		11.91	11.46	0.01424	0.01370	PASS
Extreme (-20°C)		8.33	6.53	0.00995	0.00781	PASS
Extreme (-30°C)		1.99	8.82	0.00238	0.01055	PASS
25°C	LV	3.27	13.01	0.00391	0.01555	PASS
	HV	8.84	2.19	0.01056	0.00262	PASS

WCDMA Band V						
Condition		Freq.Error (Hz)	Freq.Error (Hz)	Frequency Stability (ppm)	Frequency Stability (ppm)	Verdict
Temperature	Voltage	BPSK	QPSK	BPSK	QPSK	
Normal (25°C)	Normal	11.96	5.33	0.01430	0.00637	PASS
Extreme (50°C)		8.38	13.70	0.01002	0.01638	PASS
Extreme (40°C)		1.47	4.86	0.00175	0.00580	PASS
Extreme (30°C)		16.17	8.71	0.01933	0.01041	PASS
Extreme (20°C)		10.70	11.33	0.01279	0.01354	PASS
Extreme (10°C)		16.02	11.47	0.01915	0.01371	PASS
Extreme (0°C)		2.74	6.08	0.00328	0.00727	PASS
Extreme (-10°C)		16.42	15.55	0.01963	0.01859	PASS
Extreme (-20°C)		9.35	13.33	0.01117	0.01593	PASS
Extreme (-30°C)		9.55	8.05	0.01142	0.00962	PASS
25°C	LV	5.47	3.73	0.00654	0.00446	PASS
	HV	16.59	14.10	0.01983	0.01685	PASS



LTE Band 5								
Condition		Freq.Error (Hz)	Freq.Error (Hz)	Freq.Error (Hz)	Frequency Stability (ppm)	Frequency Stability (ppm)	Frequency Stability (ppm)	Verdict
BANDWIDTH	1.4MHz							
Temperature	Voltage	64QAM	16QAM	QPSK	64QAM	16QAM	QPSK	
Normal (25°C)	Normal	4.36	12.40	16.23	0.00521	0.01482	0.01941	PASS
Extreme (50°C)		11.52	15.93	13.67	0.01377	0.01904	0.01634	PASS
Extreme (40°C)		9.67	16.89	7.88	0.01157	0.02019	0.00942	PASS
Extreme (30°C)		7.28	12.46	15.13	0.00870	0.01489	0.01809	PASS
Extreme (20°C)		7.65	5.25	3.59	0.00915	0.00627	0.00430	PASS
Extreme (10°C)		2.98	17.94	10.96	0.00356	0.02145	0.01310	PASS
Extreme (0°C)		2.56	13.94	16.39	0.00307	0.01666	0.01959	PASS
Extreme (-10°C)		17.12	17.81	12.77	0.02047	0.02130	0.01526	PASS
Extreme (-20°C)		14.87	11.05	2.38	0.01777	0.01322	0.00284	PASS
Extreme (-30°C)		7.98	2.42	5.90	0.00954	0.00290	0.00705	PASS
25°C		LV	6.94	1.07	12.80	0.00830	0.00128	0.01530
	HV	4.30	2.48	15.24	0.00514	0.00296	0.01821	PASS
Condition		Freq.Error (Hz)	Freq.Error (Hz)	Freq.Error (Hz)	Frequency Stability (ppm)	Frequency Stability (ppm)	Frequency Stability (ppm)	Verdict
BANDWIDTH	3MHz							
Temperature	Voltage	64QAM	16QAM	QPSK	64QAM	16QAM	QPSK	
Normal (25°C)	Normal	3.07	11.63	3.31	0.00367	0.01390	0.00396	PASS
Extreme (50°C)		12.48	11.59	4.93	0.01492	0.01385	0.00590	PASS
Extreme (40°C)		10.87	2.87	6.29	0.01300	0.00343	0.00752	PASS
Extreme (30°C)		3.54	11.05	2.69	0.00423	0.01321	0.00322	PASS
Extreme (20°C)		13.15	10.38	6.67	0.01572	0.01240	0.00798	PASS
Extreme (10°C)		5.71	2.34	11.54	0.00682	0.00280	0.01380	PASS
Extreme (0°C)		4.72	3.62	7.53	0.00564	0.00433	0.00900	PASS
Extreme (-10°C)		4.34	17.38	16.45	0.00518	0.02077	0.01966	PASS
Extreme (-20°C)		3.40	4.31	2.84	0.00406	0.00515	0.00339	PASS
Extreme (-30°C)		7.05	7.01	14.89	0.00842	0.00838	0.01780	PASS
25°C		LV	5.80	1.43	17.96	0.00694	0.00171	0.02147
	HV	2.38	15.01	2.09	0.00285	0.01794	0.00250	PASS
Condition		Freq.Error (Hz)	Freq.Error (Hz)	Freq.Error (Hz)	Frequency Stability (ppm)	Frequency Stability (ppm)	Frequency Stability (ppm)	Verdict
BANDWIDTH	5MHz							
Temperature	Voltage	64QAM	16QAM	QPSK	64QAM	16QAM	QPSK	
Normal (25°C)	Normal	16.93	15.98	8.36	0.02024	0.01910	0.00999	PASS
Extreme (50°C)		16.63	7.35	6.46	0.01988	0.00878	0.00773	PASS
Extreme (40°C)		9.98	6.20	15.23	0.01193	0.00741	0.01821	PASS



Extreme (30°C)		11.89	3.23	9.31	0.01421	0.00387	0.01113	PASS
Extreme (20°C)		6.09	14.66	1.49	0.00728	0.01753	0.00178	PASS
Extreme (10°C)		17.88	9.38	1.34	0.02138	0.01121	0.00160	PASS
Extreme (0°C)		10.43	13.48	17.72	0.01247	0.01612	0.02118	PASS
Extreme (-10°C)		10.79	5.03	11.87	0.01290	0.00601	0.01419	PASS
Extreme (-20°C)		9.34	6.62	17.03	0.01116	0.00791	0.02036	PASS
Extreme (-30°C)		7.87	4.25	1.37	0.00941	0.00508	0.00164	PASS
25°C	LV	9.65	10.39	16.88	0.01154	0.01242	0.02018	PASS
	HV	3.83	7.73	8.22	0.00458	0.00924	0.00983	PASS
Condition		Freq.Error (Hz)	Freq.Error (Hz)	Freq.Error (Hz)	Frequency Stability (ppm)	Frequency Stability (ppm)	Frequency Stability (ppm)	Verdict
BANDWIDTH	10MHz							
Temperature	Voltage	64QAM	16QAM	QPSK	64QAM	16QAM	QPSK	
Normal (25°C)	Normal	7.87	2.00	17.76	0.00941	0.00239	0.02124	PASS
Extreme (50°C)		4.96	14.38	7.70	0.00593	0.01719	0.00920	PASS
Extreme (40°C)		2.90	15.00	14.81	0.00347	0.01793	0.01770	PASS
Extreme (30°C)		4.37	15.43	11.60	0.00523	0.01845	0.01387	PASS
Extreme (20°C)		13.50	8.28	5.48	0.01613	0.00990	0.00655	PASS
Extreme (10°C)		10.53	13.53	12.95	0.01259	0.01617	0.01548	PASS
Extreme (0°C)		15.70	3.79	4.81	0.01877	0.00453	0.00575	PASS
Extreme (-10°C)		2.06	10.71	17.71	0.00246	0.01280	0.02118	PASS
Extreme (-20°C)		15.26	1.30	7.16	0.01824	0.00156	0.00856	PASS
Extreme (-30°C)		12.27	15.00	7.33	0.01467	0.01794	0.00877	PASS
25°C	LV	10.84	2.69	5.10	0.01295	0.00321	0.00610	PASS
	HV	14.94	14.98	3.87	0.01785	0.01791	0.00462	PASS

### 5.6. Spurious Emissions at Antenna Terminals

#### Ambient condition

Temperature	Relative humidity	Pressure
23°C ~25°C	45%~50%	101.5kPa

#### Method of Measurement

The EUT was connected to Spectrum Analyzer and Base Station Simulator via power Splitter. The measurement is carried out using a spectrum analyzer. The spectrum analyzer scans from 9kHz to the 10th harmonic of the carrier.

The peak detector is used. RBW are set to 100 kHz and VBW are set to 300 kHz for below 1G, RBW are set to 1MHz and VBW are set to 3MHz for above 1G, Sweep is set to ATUO.

RBW is set to 1 kHz (0.009MHz~ 0.15 MHz),

RBW is set to 10 kHz (0.15 MHz~ 30 MHz)

RBW is set to 100 kHz (30MHz~1000 MHz)

RBW is set to 1000 kHz (above 1000MHz)

The modulation mode and RB allocation refer to section 5.1, using the maximum output power configuration.

#### Test setup

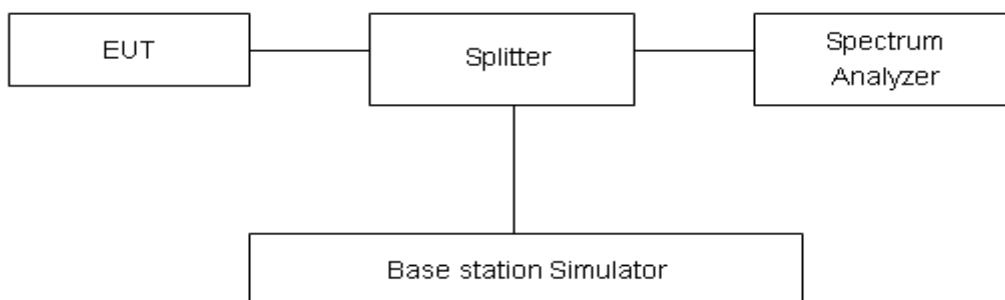

#### Limits

Rule Part 22.917(a) specifies that “The power of any emission outside of the authorized operating frequency ranges must be attenuated below the transmitting power (P) by a factor of at least 43 + 10 log (P) dB.”

Limit	-13 dBm

#### Measurement Uncertainty

The assessed measurement uncertainty to ensure 99.75% confidence level for the normal distribution is with the coverage factor  $k = 1.96$ .

Frequency	Uncertainty
9kHz-1GHz	0.684 dB
1GHz-20GHz	1.407 dB



Test Result

Sweep the whole frequency band through the range from 9kHz to the 10th harmonic of the carrier, the emissions more than 20 dB below the limit are not reported.

The signal beyond the limit is carrier.

GSM 850 CH-Low 9kHz ~ 20GHz

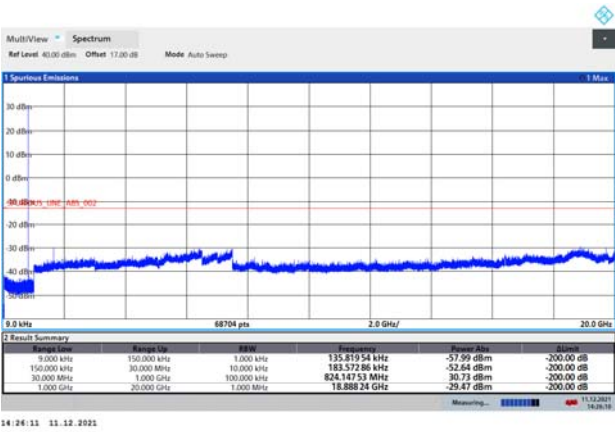

GPRS 850 CH-Low 9kHz ~ 20GHz

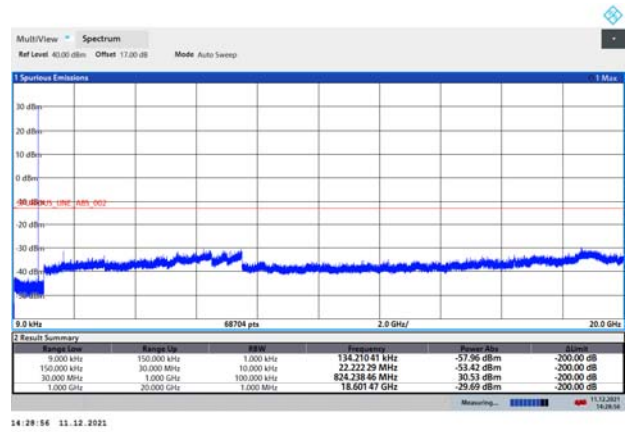

GSM 850 CH-Middle 9kHz ~ 20GHz

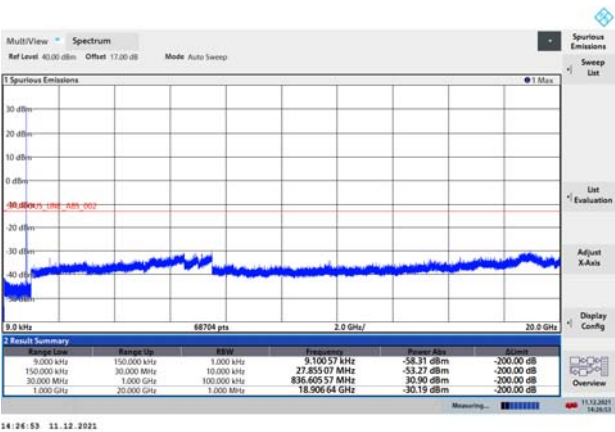

GPRS 850 CH-Middle 9kHz ~ 20GHz

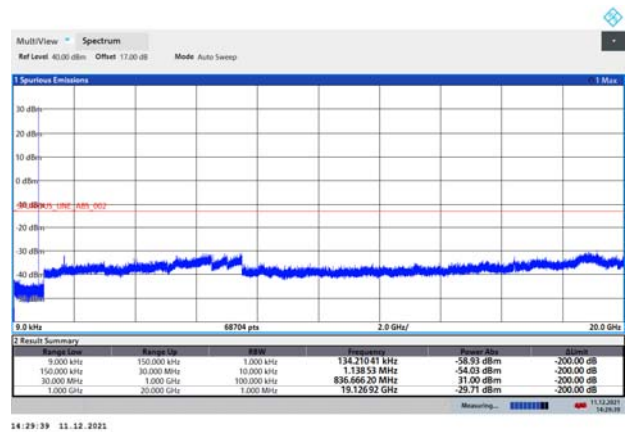

GSM 850 CH-High 9kHz ~ 20GHz

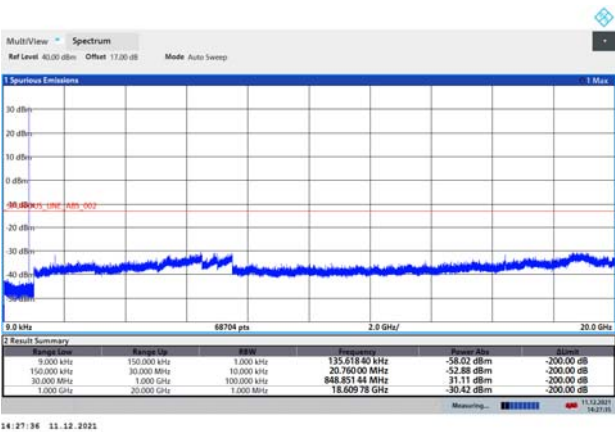

GPRS 850 CH-High 9kHz ~ 20GHz

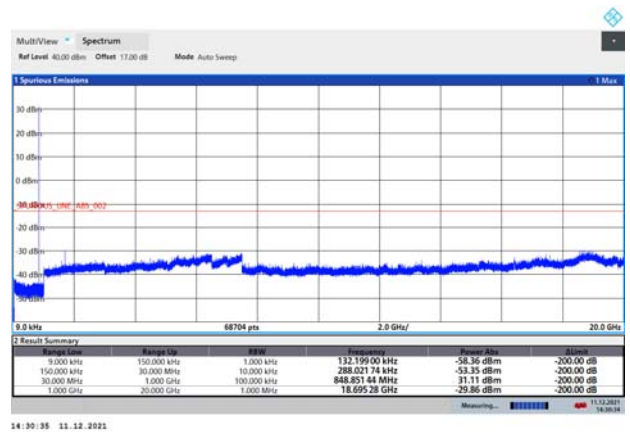



### EGPRS 850 CH-Low 9kHz ~ 20GHz

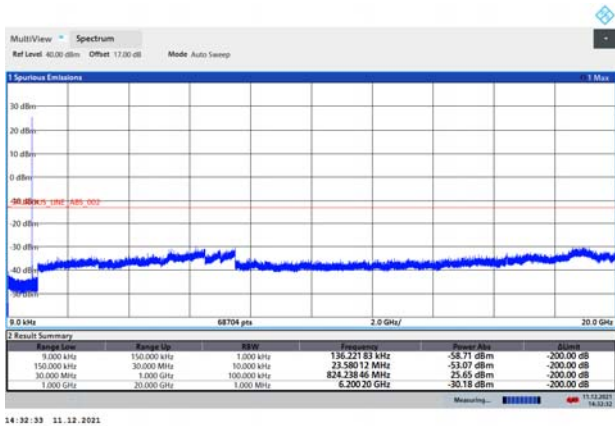

14:30:33 11.12.2021

### WCDMA BAND V CH-Low 9kHz ~ 20GHz

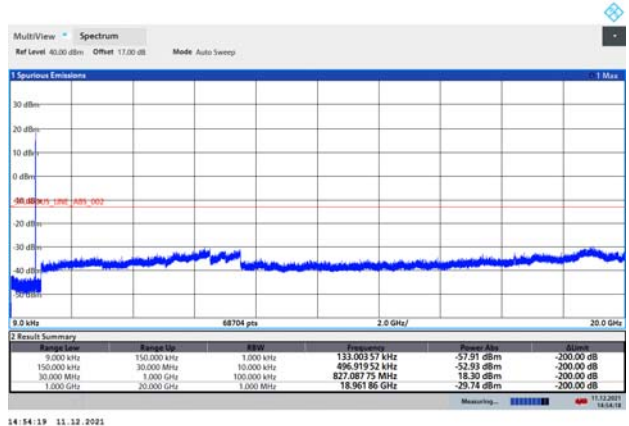

14:34:19 11.12.2021

### EGPRS 850 CH-Middle 9kHz ~ 20GHz

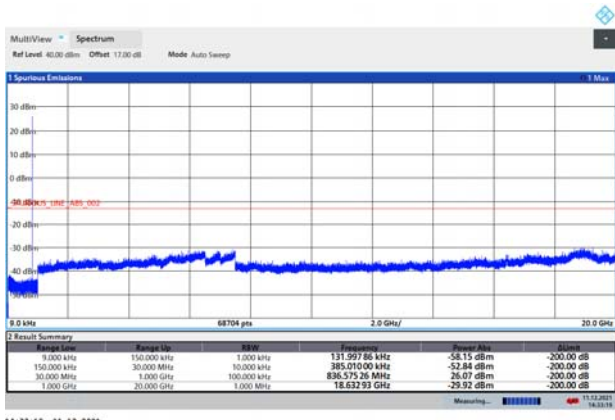

14:33:19 11.12.2021

### WCDMA BAND V CH-Middle 9kHz ~ 20GHz

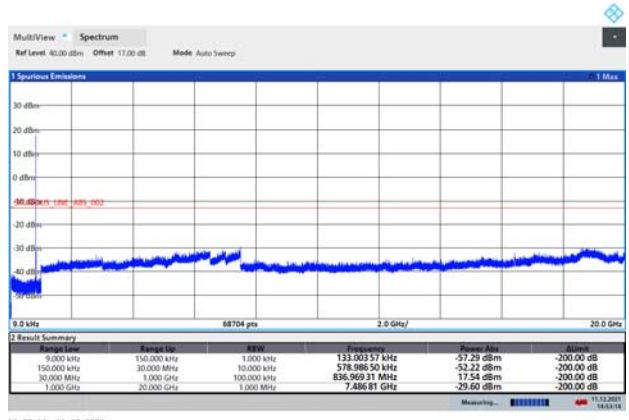

14:33:14 11.12.2021

### EGPRS 850 CH-High 9kHz ~ 20GHz

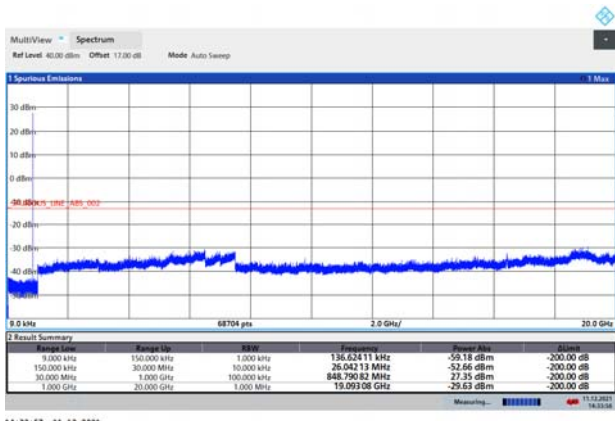

14:33:57 11.12.2021

### WCDMA BAND V CH-High 9kHz ~ 20GHz

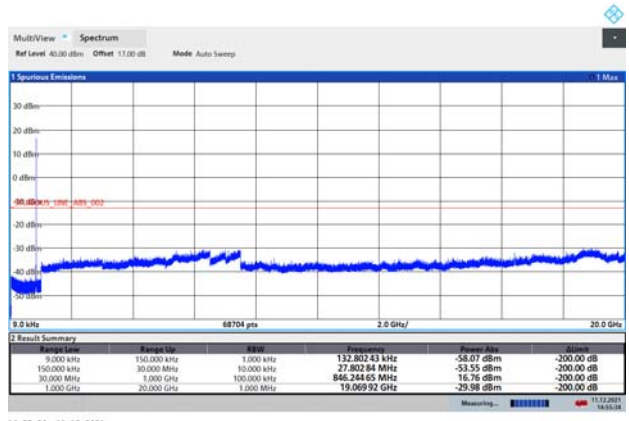

14:35:34 11.12.2021



LTE Band 5 1.4MHz CH-Low 9kHz~10GHz

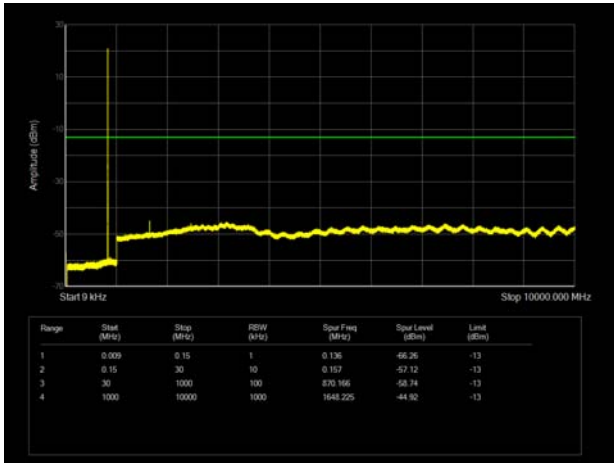

LTE Band 5 3MHz CH-Low 9kHz~10GHz

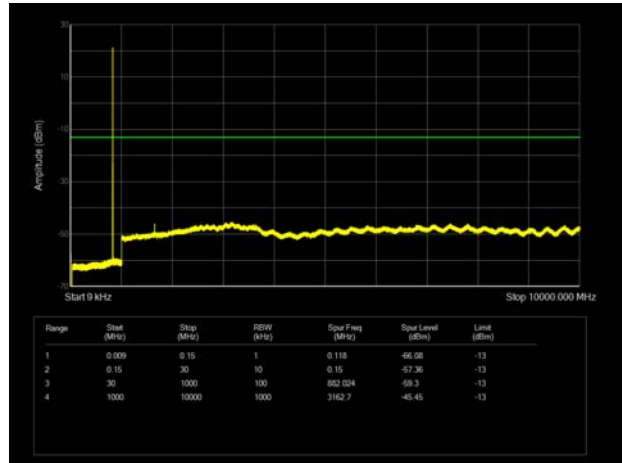

LTE Band 5 1.4MHz CH-Middle 9kHz~10GHz

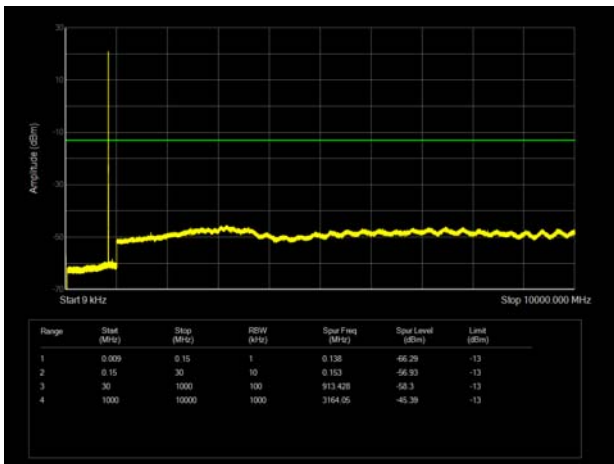

LTE Band 5 3MHz CH-Middle 9kHz~10GHz

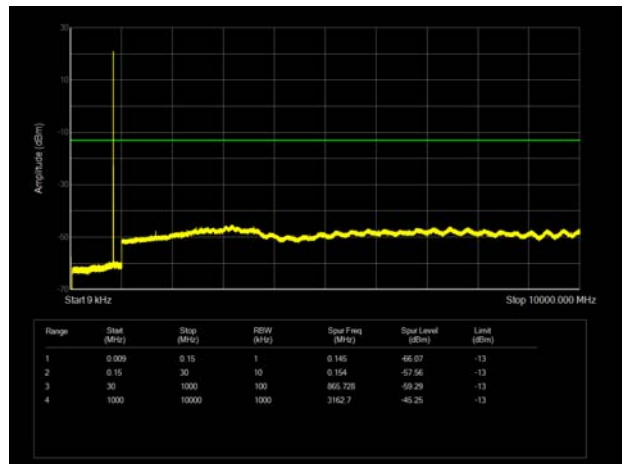

LTE Band 5 1.4MHz CH-High 9kHz~10GHz

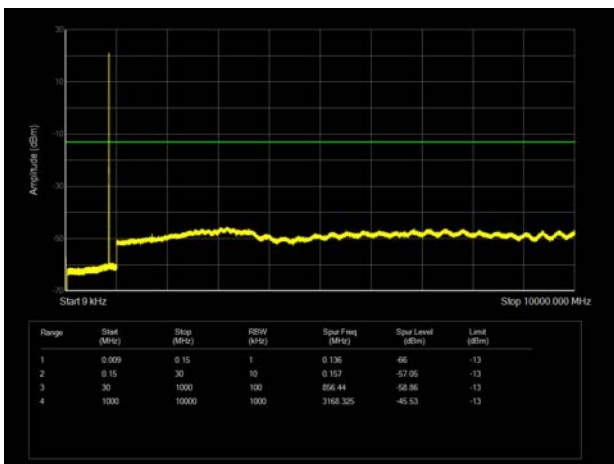

LTE Band 5 3MHz CH-High 9kHz~10GHz

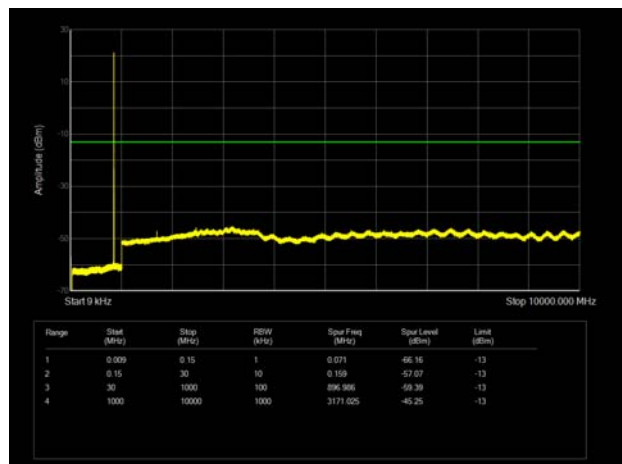



LTE Band 5 5MHz CH-Low 9kHz~10GHz

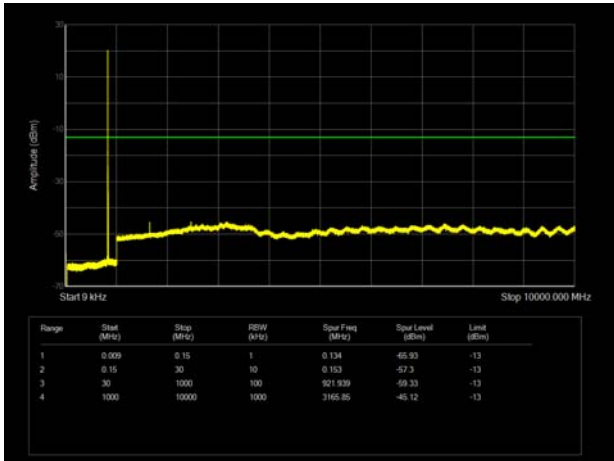

LTE Band 5 10MHz CH-Low 9kHz~10GHz

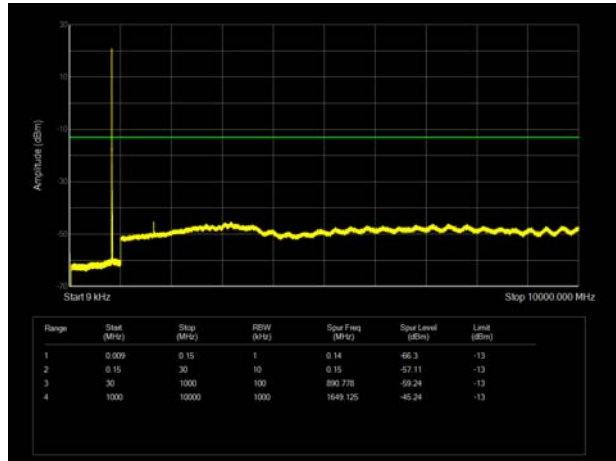

LTE Band 5 5MHz CH-Middle 9kHz~10GHz

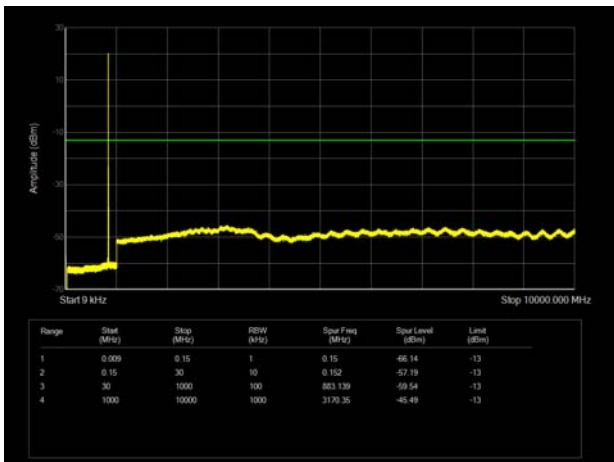

LTE Band 5 10MHz CH-Middle 9kHz~10GHz

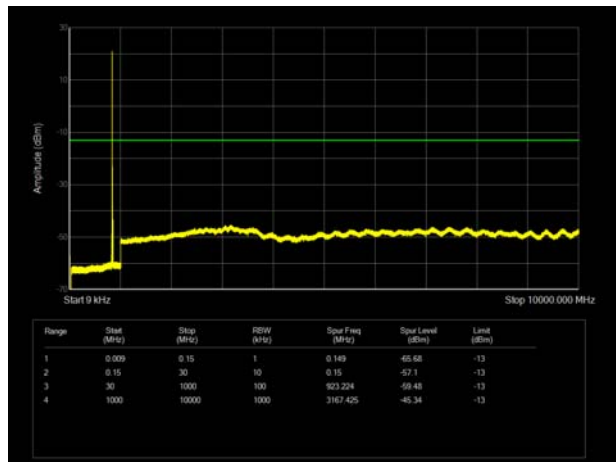

LTE Band 5 5MHz CH-High 9kHz~10GHz

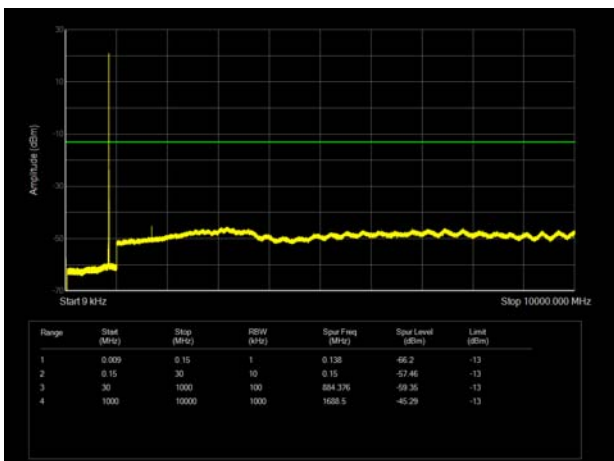

LTE Band 5 10MHz CH-High 9kHz~10GHz

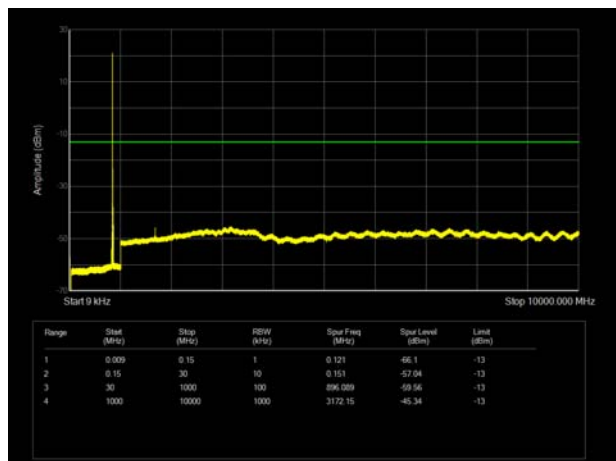

## 5.7. Radiates Spurious Emission

### Ambient condition

Temperature	Relative humidity	Pressure
23°C ~25°C	45%~50%	101.5kPa

### Method of Measurement

1. The testing follows FCC KDB 971168 v03r01 Section 5.8 and ANSI C63.26 (2015).
2. Below 1GHz: The EUT is placed on a turntable 0.8 meters above the ground in the chamber, 3 meter away from the antenna. The maximal emission value is acquired by adjusting the antenna height, polarisation and turntable azimuth. Normally, the height range of antenna is 1 m to 4 m, the azimuth range of turntable is 0° to 360°, and the receive antenna has two polarizations Vertical (V) and Horizontal (H). Above 1GHz: (Note: the FCC's permission to use 1.5m as an alternative per TCBC Conf call of Dec. 2, 2014.) The EUT is placed on a turntable 1.5 meters above the ground in the chamber, 3 meter away from the antenna. The maximal emission value is acquired by adjusting the antenna height, polarisation and turntable azimuth. Normally, the height range of antenna is 1 m to 4 m, the azimuth range of turntable is 0° to 360°, and the receive antenna has two polarizations Vertical (V) and Horizontal (H).
3. A loop antenna, A log-periodic antenna or horn antenna shall be substituted in place of the EUT. The log-periodic antenna will be driven by a signal generator and the level will be adjusted till the same power value on the spectrum analyzer or receiver. The level of the spurious emissions can be calculated through the level of the signal generator, cable loss, the gain of the substitution antenna and the reading of the spectrum analyzer or receiver.
4. The EUT is then put into continuously transmitting mode at its maximum power level during the test. Set Test Receiver or Spectrum RBW=100kHz, VBW=300kHz for 30MHz to 1GHz and RBW=1MHz, VBW=3MHz for above 1GHz, and the maximum value of the receiver should be recorded as (Pr).
5. The EUT shall be replaced by a substitution antenna. In the chamber, an substitution antenna for the frequency band of interest is placed at the reference point of the chamber. An RF Signal source for the frequency band of interest is connected to the substitution antenna with a cable that has been constructed to not interfere with the radiation pattern of the antenna. A power (PMea) is applied to the input of the substitution antenna, and adjust the level of the signal generator output until the value of the receiver reach the previously recorded (Pr). The power of signal source (PMea) is recorded. The test should be performed by rotating the test item and adjusting the receiving antenna polarization.
6. A amplifier should be connected to the Signal Source output port. And the cable should be connect between the Amplifier and the Substitution Antenna. The cable loss (Pcl), the Substitution Antenna Gain (Ga) and the Amplifier Gain (PAg) should be recorded after test.
7. The measurement results are obtained as described below:  
Power(EIRP)=PMea- PAg - Pcl + Ga  
The measurement results are amend as described below:  
Power(EIRP)=PMea- Pcl + Ga
8. This value is EIRP since the measurement is calibrated using an antenna of known gain (2.15 dB) and known input power. ERP can be calculated from EIRP by subtracting the gain of the dipole, ERP

= EIRP-2.15dB.

The modulation mode and RB allocation refer to section 5.1, using the maximum output power configuration.

**Test setup**

**9KHz ~ 30MHz**

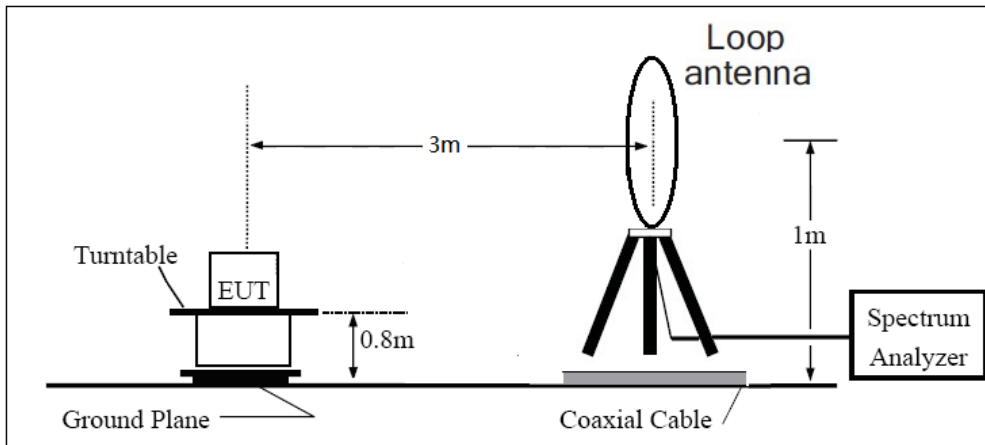

**30MHz ~ 1GHz**

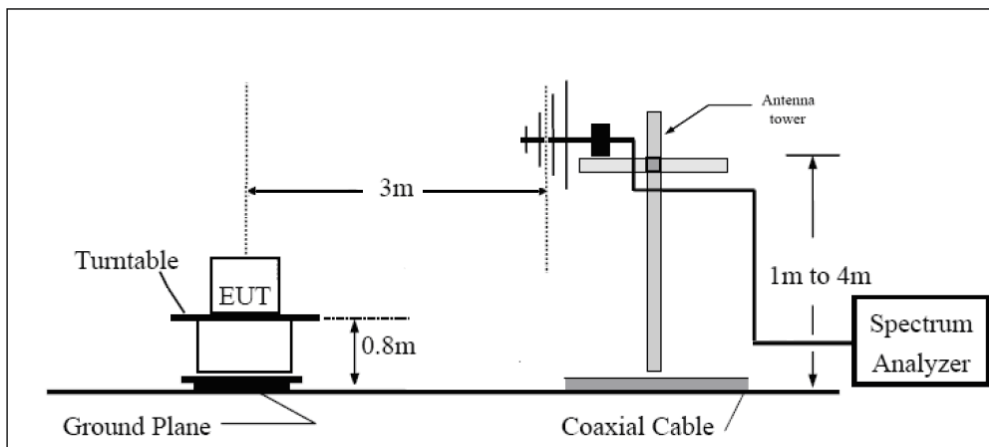

**Above 1GHz**

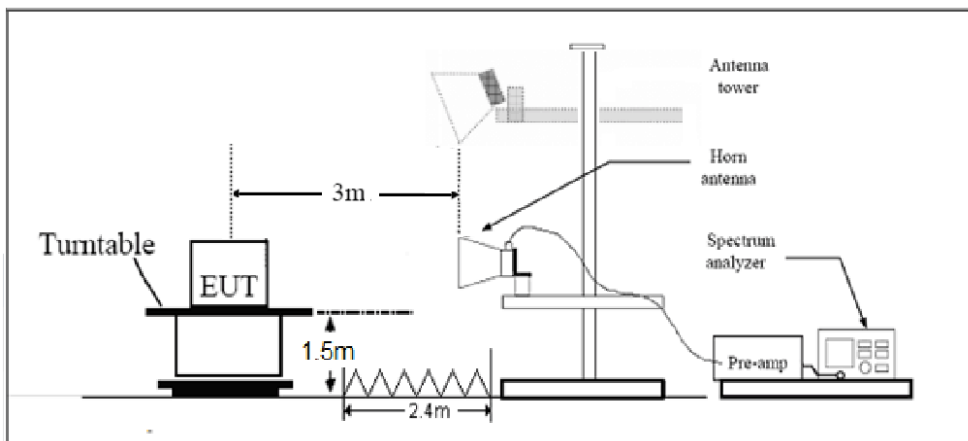

Note: Area side:2.4mX3.6m

**Limits**

Rule Part 22.917(a) specifies that “The power of any emission outside of the authorized operating frequency ranges must be attenuated below the transmitting power (P) by a factor of at least  $43 + 10 \log (P)$  dB.”

Limit	-13 dBm
-------	---------

**Measurement Uncertainty**

The assessed measurement uncertainty to ensure 95% confidence level for the normal distribution is with the coverage factor  $k = 1.96$ ,  $U = 3.55$  dB.

**Test Result**

Sweep the whole frequency band through the range from 9kHz to the 10th harmonic of the carrier, the emissions below the noise floor will not be recorded in the report.

**Low Antenna**

GSM 850 CH-Middle

Harmonic	Frequency (MHz)	SG (dBm)	Cable Loss (dB)	Gain (dBi)	Antenna Polarization	ERP Level (dBm)	Limit (dBm)	Margin (dB)	Azimuth (deg)
2	1673.00	-56.95	2.30	12.00	Horizontal	-49.40	-13.00	36.40	90
3	2509.80	-61.57	1.70	8.70	Horizontal	-56.72	-13.00	43.72	45
4	3346.40	-66.05	2.70	12.70	Horizontal	-58.20	-13.00	45.20	45
5	4183.00	-64.11	3.00	12.50	Horizontal	-56.76	-13.00	43.76	315
6	5019.60	-62.12	3.40	12.50	Horizontal	-55.17	-13.00	42.17	90
7	5856.20	-62.36	3.40	12.80	Horizontal	-55.11	-13.00	42.11	180
8	6692.80	-57.78	4.10	11.50	Horizontal	-52.53	-13.00	39.53	0
9	7529.40	-56.00	4.20	12.20	Horizontal	-50.15	-13.00	37.15	45
10	8366.00	-56.61	4.30	12.50	Horizontal	-50.56	-13.00	37.56	315

Note: 1.The other Spurious RF Radiated emissions level is no more than noise floor.

2.The worst emission was found in the antenna is Horizontal position.

WCDMA Band V CH-Middle

Harmonic	Frequency (MHz)	SG (dBm)	Cable Loss (dB)	Gain (dBi)	Antenna Polarization	ERP Level (dBm)	Limit (dBm)	Margin (dB)	Azimuth (deg)
2	1673.20	-56.69	1.70	8.70	Horizontal	-51.84	-13.00	38.84	315
3	2510.40	-65.40	2.30	12.00	Horizontal	-57.85	-13.00	44.85	225
4	3346.40	-65.74	2.70	12.70	Horizontal	-57.89	-13.00	44.89	45
5	4183.00	-64.10	3.00	12.50	Horizontal	-56.75	-13.00	43.75	0
6	5019.60	-62.14	3.40	12.50	Horizontal	-55.19	-13.00	42.19	180
7	5856.20	-62.36	3.40	12.80	Horizontal	-55.11	-13.00	42.11	90
8	6692.80	-58.50	4.10	11.50	Horizontal	-53.25	-13.00	40.25	315
9	7529.40	-55.93	4.20	12.20	Horizontal	-50.08	-13.00	37.08	270
10	8366.00	-56.67	4.30	12.50	Horizontal	-50.62	-13.00	37.62	225

Note: 1.The other Spurious RF Radiated emissions level is no more than noise floor.

2.The worst emission was found in the antenna is Horizontal position.



## LTE Band 5 1.4MHz CH-Middle

Harmonic	Frequency (MHz)	SG (dBm)	Cable Loss (dB)	Gain (dBi)	Antenna Polarization	ERP Level (dBm)	Limit (dBm)	Margin (dB)	Azimuth (deg)
2	1673.00	-62.71	1.70	8.70	Horizontal	-57.86	-13.00	44.86	45
3	2509.50	-63.51	2.30	12.00	Horizontal	-55.96	-13.00	42.96	225
4	3343.20	-66.47	2.70	12.70	Horizontal	-58.62	-13.00	45.62	45
5	4179.00	-64.51	3.00	12.50	Horizontal	-57.16	-13.00	44.16	270
6	5014.80	-62.84	3.40	12.50	Horizontal	-55.89	-13.00	42.89	180
7	5850.60	-62.96	3.40	12.80	Horizontal	-55.71	-13.00	42.71	0
8	6686.40	-59.12	4.10	11.50	Horizontal	-53.87	-13.00	40.87	45
9	7522.20	-56.75	4.20	12.20	Horizontal	-50.90	-13.00	37.90	315
10	8358.00	-56.54	4.30	12.50	Horizontal	-50.49	-13.00	37.49	90

Note: 1.The other Spurious RF Radiated emissions level is no more than noise floor.

2.The worst emission was found in the antenna is Horizontal position.

## LTE Band 5 5MHz CH-Middle

Harmonic	Frequency (MHz)	SG (dBm)	Cable Loss (dB)	Gain (dBi)	Antenna Polarization	ERP Level (dBm)	Limit (dBm)	Margin (dB)	Azimuth (deg)
2	1668.60	-61.78	1.70	8.70	Horizontal	-56.93	-13.00	43.93	90
3	2503.30	-64.48	2.30	12.00	Horizontal	-56.93	-13.00	43.93	0
4	3337.50	-66.07	2.70	12.70	Horizontal	-58.22	-13.00	45.22	90
5	4171.88	-64.70	3.00	12.50	Horizontal	-57.35	-13.00	44.35	135
6	5006.25	-62.72	3.40	12.50	Horizontal	-55.77	-13.00	42.77	90
7	5840.63	-62.67	3.40	12.80	Horizontal	-55.42	-13.00	42.42	225
8	6675.00	-58.46	4.10	11.50	Horizontal	-53.21	-13.00	40.21	0
9	7509.38	-55.34	4.20	12.20	Horizontal	-49.49	-13.00	36.49	45
10	8343.75	-57.22	4.30	12.50	Horizontal	-51.17	-13.00	38.17	315

Note: 1.The other Spurious RF Radiated emissions level is no more than noise floor.

2.The worst emission was found in the antenna is Horizontal position.



## LTE Band 5 10MHz CH-Middle

Harmonic	Frequency (MHz)	SG (dBm)	Cable Loss (dB)	Gain (dBi)	Antenna Polarization	ERP Level (dBm)	Limit (dBm)	Margin (dB)	Azimuth (deg)
2	1664.40	-62.04	1.70	8.70	Horizontal	-57.19	-13.00	44.19	270
3	2496.60	-59.27	2.30	12.00	Horizontal	-51.72	-13.00	38.72	90
4	3346.00	-66.27	2.70	12.70	Horizontal	-58.42	-13.00	45.42	45
5	4182.50	-64.50	3.00	12.50	Horizontal	-57.15	-13.00	44.15	315
6	5019.00	-62.86	3.40	12.50	Horizontal	-55.91	-13.00	42.91	225
7	5855.50	-63.21	3.40	12.80	Horizontal	-55.96	-13.00	42.96	90
8	6692.00	-59.07	4.10	11.50	Horizontal	-53.82	-13.00	40.82	0
9	7528.50	-56.86	4.20	12.20	Horizontal	-51.01	-13.00	38.01	180
10	8365.00	-56.65	4.30	12.50	Horizontal	-50.60	-13.00	37.60	270

Note: 1.The other Spurious RF Radiated emissions level is no more than noise floor.

2.The worst emission was found in the antenna is Horizontal position.

## Upper Antenna

## GSM 850 CH-Middle

Harmonic	Frequency (MHz)	SG (dBm)	Cable Loss (dB)	Gain (dBi)	Antenna Polarization	ERP Level (dBm)	Limit (dBm)	Margin (dB)	Azimuth (deg)
2	1673.55	-66.73	2.30	12.00	Horizontal	-59.18	-13.00	46.18	45
3	2509.65	-45.82	1.70	8.70	Horizontal	-40.97	-13.00	27.97	315
4	3346.40	-67.17	2.70	12.70	Horizontal	-59.32	-13.00	46.32	225
5	4183.00	-65.19	3.00	12.50	Horizontal	-57.84	-13.00	44.84	315
6	5019.60	-61.90	3.40	12.50	Horizontal	-54.95	-13.00	41.95	45
7	5856.20	-63.72	3.40	12.80	Horizontal	-56.47	-13.00	43.47	135
8	6692.80	-59.01	4.10	11.50	Horizontal	-53.76	-13.00	40.76	270
9	7529.40	-57.21	4.20	12.20	Horizontal	-51.36	-13.00	38.36	180
10	8366.00	-56.10	4.30	12.50	Horizontal	-50.05	-13.00	37.05	315

Note: 1.The other Spurious RF Radiated emissions level is no more than noise floor.

2.The worst emission was found in the antenna is Horizontal position.





## WCDMA Band V CH-Middle

Harmonic	Frequency (MHz)	SG (dBm)	Cable Loss (dB)	Gain (dBi)	Antenna Polarization	ERP Level (dBm)	Limit (dBm)	Margin (dB)	Azimuth (deg)
2	1673.20	-63.06	1.70	8.70	Horizontal	-58.21	-13.00	45.21	45
3	2509.80	-64.74	2.30	12.00	Horizontal	-57.19	-13.00	44.19	225
4	3346.40	-66.42	2.70	12.70	Horizontal	-58.57	-13.00	45.57	180
5	4183.00	-63.97	3.00	12.50	Horizontal	-56.62	-13.00	43.62	315
6	5019.60	-62.18	3.40	12.50	Horizontal	-55.23	-13.00	42.23	135
7	5856.20	-62.63	3.40	12.80	Horizontal	-55.38	-13.00	42.38	0
8	6692.80	-57.62	4.10	11.50	Horizontal	-52.37	-13.00	39.37	225
9	7529.40	-56.27	4.20	12.20	Horizontal	-50.42	-13.00	37.42	90
10	8366.00	-56.60	4.30	12.50	Horizontal	-50.55	-13.00	37.55	315

Note: 1.The other Spurious RF Radiated emissions level is no more than noise floor.

2.The worst emission was found in the antenna is Horizontal position.

## LTE Band 5 1.4MHz CH-Middle

Harmonic	Frequency (MHz)	SG (dBm)	Cable Loss (dB)	Gain (dBi)	Antenna Polarization	ERP Level (dBm)	Limit (dBm)	Margin (dB)	Azimuth (deg)
2	1673.00	-56.10	1.70	8.70	Horizontal	-51.25	-13.00	38.25	0
3	2509.50	-62.12	2.30	12.00	Horizontal	-54.57	-13.00	41.57	90
4	3343.20	-66.08	2.70	12.70	Horizontal	-58.23	-13.00	45.23	225
5	4179.00	-64.12	3.00	12.50	Horizontal	-56.77	-13.00	43.77	45
6	5014.80	-62.10	3.40	12.50	Horizontal	-55.15	-13.00	42.15	135
7	5850.60	-62.07	3.40	12.80	Horizontal	-54.82	-13.00	41.82	315
8	6686.40	-58.14	4.10	11.50	Horizontal	-52.89	-13.00	39.89	180
9	7522.20	-55.68	4.20	12.20	Horizontal	-49.83	-13.00	36.83	135
10	8358.00	-55.85	4.30	12.50	Horizontal	-49.80	-13.00	36.80	315

Note: 1.The other Spurious RF Radiated emissions level is no more than noise floor.

2.The worst emission was found in the antenna is Horizontal position.



## LTE Band 5 5MHz CH-Middle

Harmonic	Frequency (MHz)	SG (dBm)	Cable Loss (dB)	Gain (dBi)	Antenna Polarization	ERP Level (dBm)	Limit (dBm)	Margin (dB)	Azimuth (deg)
2	1668.60	-57.38	1.70	8.70	Horizontal	-52.53	-13.00	39.53	45
3	2503.30	-59.71	2.30	12.00	Horizontal	-52.16	-13.00	39.16	315
4	3337.50	-65.34	2.70	12.70	Horizontal	-57.49	-13.00	44.49	225
5	4171.88	-63.16	3.00	12.50	Horizontal	-55.81	-13.00	42.81	90
6	5006.25	-60.70	3.40	12.50	Horizontal	-53.75	-13.00	40.75	45
7	5840.63	-61.60	3.40	12.80	Horizontal	-54.35	-13.00	41.35	315
8	6675.00	-58.72	4.10	11.50	Horizontal	-53.47	-13.00	40.47	0
9	7509.38	-55.02	4.20	12.20	Horizontal	-49.17	-13.00	36.17	180
10	8343.75	-56.02	4.30	12.50	Horizontal	-49.97	-13.00	36.97	270

Note: 1.The other Spurious RF Radiated emissions level is no more than noise floor.  
2.The worst emission was found in the antenna is Horizontal position.

## LTE Band 5 10MHz CH-Middle

Harmonic	Frequency (MHz)	SG (dBm)	Cable Loss (dB)	Gain (dBi)	Antenna Polarization	ERP Level (dBm)	Limit (dBm)	Margin (dB)	Azimuth (deg)
2	1664.40	-56.64	1.70	8.70	Horizontal	-51.79	-13.00	38.79	45
3	2496.60	-58.03	2.30	12.00	Horizontal	-50.48	-13.00	37.48	270
4	3346.00	-65.77	2.70	12.70	Horizontal	-57.92	-13.00	44.92	0
5	4182.50	-63.75	3.00	12.50	Horizontal	-56.40	-13.00	43.40	180
6	5019.00	-61.78	3.40	12.50	Horizontal	-54.83	-13.00	41.83	0
7	5855.50	-62.53	3.40	12.80	Horizontal	-55.28	-13.00	42.28	45
8	6692.00	-58.42	4.10	11.50	Horizontal	-53.17	-13.00	40.17	315
9	7528.50	-57.65	4.20	12.20	Horizontal	-51.80	-13.00	38.80	90
10	8365.00	-56.43	4.30	12.50	Horizontal	-50.38	-13.00	37.38	135

Note: 1.The other Spurious RF Radiated emissions level is no more than noise floor.  
2.The worst emission was found in the antenna is Horizontal position.

## 6. Main Test Instruments

Name	Manufacturer	Type	Serial Number	Calibration Date	Expiration Date
Base Station Simulator	R&S	CMW500	113645	2021-05-15	2022-05-14
Climate Chamber	Weiss	VT4002	58226119450 010	2021-05-15	2022-05-14
Spectrum Analyzer	Keysight	N9020A	MY52330084	2021-05-15	2022-05-14
Universal Radio Communication Tester	Key sight	E5515C	GB44400275	2021-05-15	2022-05-14
Signal Analyzer	R&S	FSV3030	101411	2021-12-12	2022-12-12
Signal Analyzer	R&S	FSV30	100815	2021-12-12	2022-12-11
TRILOG Broadband Antenna	Schwarzbeck	VULB 9163	01439	2021-06-30	2024-06-29
Horn Antenna	Schwarzbeck	BBHA 9120D	01799	2019-09-21	2022-09-20
Software	R&S	EMC32	9.26.0	/	/

\*\*\*\*\*END OF REPORT \*\*\*\*\*



## **ANNEX A: The EUT Appearance**

The EUT Appearance are submitted separately.



## **ANNEX B: Test Setup Photos**

The Test Setup Photos are submitted separately.