



# RF TEST REPORT

**Applicant**      Xiaomi Communications Co., Ltd.  
**FCC ID**          2AFZZ33SG  
**Product**        Mobile Phone  
**Brand**            Redmi  
**Model**            220733SG  
**Report No.**      R2207A0665-R2  
**Issue Date**      August 16, 2022

TA Technology (Shanghai) Co., Ltd. tested the above equipment in accordance with the requirements in **FCC CFR47 Part 2 (2021)/ FCC CFR 47 Part 24E (2021)**. The test results show that the equipment tested is capable of demonstrating compliance with the requirements as documented in this report.

Prepared by: Xu Ying

Approved by: Xu Kai

---

**TA Technology (Shanghai) Co., Ltd.**

Building 3, No.145, Jintang Rd, Tangzhen Industry Park, Pudong Shanghai, China

TEL: +86-021-50791141/2/3

FAX: +86-021-50791141/2/3-8000



## TABLE OF CONTENT

1. Test Laboratory .....	4
1.1. Notes of the test report .....	4
1.2. Test facility .....	4
1.3. Testing Location .....	4
2. General Description of Equipment under Test .....	5
2.1. Applicant and Manufacturer Information .....	5
2.2. General information .....	5
3. Applied Standards .....	7
4. Test Configuration .....	8
5. Test Case .....	9
5.1. RF Power Output and Effective Isotropic Radiated Power .....	9
5.2. Occupied Bandwidth .....	10
5.3. Band Edge Compliance .....	11
5.4. Peak-to-Average Power Ratio (PAPR) .....	12
5.5. Frequency Stability .....	13
5.6. Spurious Emissions at Antenna Terminals .....	15
5.7. Radiates Spurious Emission .....	16
6. Test Results .....	19
6.1. RF Power Output and Effective Isotropic Radiated Power .....	19
6.2. Occupied Bandwidth .....	20
6.3. Band Edge Compliance .....	23
6.4. Peak-to-Average Power Ratio (PAPR) .....	24
6.5. Frequency Stability .....	25
6.6. Spurious Emissions at Antenna Terminals .....	26
6.7. Radiates Spurious Emission .....	28
7. Main Test Instruments .....	30
ANNEX A: The EUT Appearance .....	31
ANNEX B: Test Setup Photos .....	32
ANNEX C: Product Change Description (Variant 1) .....	33
ANNEX D: Product Change Description (Variant 2) .....	34



## Summary of measurement results

No.	Test Case	Clause in FCC rules	Verdict
1	RF Power Output and Effective Isotropic Radiated Power	2.1046 24.232(c)	PASS
2	Occupied Bandwidth	2.1049	PASS
3	Band Edge Compliance	2.1051 /24.238(a)	PASS
4	Peak-to-Average Power Ratio	24.232/KDB 971168 D01(5.7)	PASS
5	Frequency Stability	2.1055 / 24.235	PASS
6	Spurious Emissions at Antenna Terminals	2.1051 / 24.238(a)	PASS
7	Radiates Spurious Emission	2.1053 / 24.238(a)	PASS
Date of Testing: June 20, 2022 ~ July 2, 2022			
Date of Sample Received: June 16, 2022			
Note: PASS: The EUT complies with the essential requirements in the standard. FAIL: The EUT does not comply with the essential requirements in the standard. All indications of Pass/Fail in this report are opinions expressed by TA Technology (Shanghai) Co., Ltd. based on interpretations and/or observations of test results. Measurement Uncertainties were not taken into account and are published for informational purposes only.			

**220733SG (Report No.: R2207A0665-R2) is a variant model (Variant 2) of 220733SG (Report No.: R2206A0534-R2). There is only added the 2nd supplier PA of product. There is only verified power, and did not worsen, so they were not recorded in the report. Test values all duplicated from Original for variant.**

**The detailed product change description please refers to the *Difference Declaration Letter*.**

**220733SG (Report No.: R2206A0534-R2) is a variant model (Variant 1) of 220733SL (Report No.: R2206A0532-R2). There is only verified power, and did not worsen, so they were not recorded in the report. Test values all duplicated from Original for variant .The detailed product change description please refers to following table:**

/	Original	Variant
<b>Model</b>	<b>220733SL</b>	<b>220733SG</b>
<b>Band</b>	GSM:B2/3/5/8; WCDMA:B1/2/4/5/8; LTE FDD:B1/2/3/4/5/7/8/28; LTE TDD:B38/41(2496-2690MHz);	GSM: B2/3/5/8; WCDMA: B1/5/8; LTE FDD: B1/3/5/7/8/20/28; LTE FDD: B38/41(2496-2690MHz);
<b>Others</b>	The same	

**The detailed product change description please refers to the *Difference Declaration Letter*.**



## 1. Test Laboratory

### 1.1. Notes of the test report

This report shall not be reproduced in full or partial, without the written approval of **TA technology (shanghai) co., Ltd.** The results documented in this report apply only to the tested sample, under the conditions and modes of operation as described herein. Measurement Uncertainties were not taken into account and are published for informational purposes only. This report is written to support regulatory compliance of the applicable standards stated above.

### 1.2. Test facility

#### **FCC (Designation number: CN1179, Test Firm Registration Number: 446626)**

TA Technology (Shanghai) Co., Ltd. has been listed on the US Federal Communications Commission list of test facilities recognized to perform measurements.

#### **A2LA (Certificate Number: 3857.01)**

TA Technology (Shanghai) Co., Ltd. has been listed by American Association for Laboratory Accreditation to perform measurement.

### 1.3. Testing Location

Company: TA Technology (Shanghai) Co., Ltd.  
Address: Building 3, No.145, Jintang Rd, Tangzhen Industry Park, Pudong Shanghai, China  
City: Shanghai  
Post code: 201201  
Country: P. R. China  
Contact: Xu Kai  
Telephone: +86-021-50791141/2/3  
Fax: +86-021-50791141/2/3-8000  
Website: <http://www.ta-shanghai.com>  
E-mail: [xukai@ta-shanghai.com](mailto:xukai@ta-shanghai.com)

## 2. General Description of Equipment under Test

### 2.1. Applicant and Manufacturer Information

Applicant	Xiaomi Communications Co., Ltd.
Applicant address	019, 9th Floor, Building 6, 33 Xi'erqi Middle Road, Haidian District, Beijing, China, 100085
Manufacturer	Xiaomi Communications Co., Ltd.
Manufacturer address	#019, 9th Floor, Building 6, 33 Xi'erqi Middle Road, Haidian District, Beijing, China, 100085

### 2.2. General information

EUT Description			
Model	220733SG		
IMEI	Original (220733SL)	IMEI 1: 869674060125087 IMEI 2: 869674060125095	
	Variant 1 (220733SG)	IMEI 1: 866681060031226 IMEI 2: 866681060031234	
	Variant 2 (220733SG)	IMEI 1: 866681060035128 IMEI 2: 866681060035136	
Hardware Version	P1.1		
Software Version	Android 12		
Antenna Type	PIFA Antenna		
Antenna Gain	Band	Low Antenna	Upper Antenna
	GSM1900	-0.9 dBi	-1.0 dBi
Test Mode(s)	GSM1900;		
Test Modulation	(GSM/GPRS)GMSK, (EGPRS) GMSK/ 8PSK;		
GPRS Multislot Class	12		
EGPRS Multislot Class	12		
Maximum E.I.R.P	GSM 1900:	29.41 dBm	
Rated Power Supply Voltage	3.85V		
Operating Voltage	Minimum: 3.6V	Maximum: 4.4V	
Operating Temperature	Lowest: 0°C	Highest: +40°C	
Testing Temperature	Lowest: -30°C	Highest: +50°C	
Operating Frequency Range(s)	Band	Tx (MHz)	Rx (MHz)
	GSM1900	1850 ~ 1910	1930 ~ 1990
Note: 1. The EUT is sent from the applicant to TA and the information of the EUT is declared by the applicant. 2. Low antenna and Upper antenna can't transmit simultaneously.			



Item	Configure 1	Configure 2
WIFI test socket	support	remove
PL sensor	support	remove
Note: This report only records data for Configure 1.		

### 3. Applied Standards

According to the specifications of the manufacturer, it must comply with the requirements of the following standards:

**Test standards:**

**FCC CFR 47 Part 24E (2021)**

**FCC CFR47 Part 2 (2021)**

**Reference standard:**

**ANSI C63.26-2015**

**KDB 971168 D01 Power Meas License Digital Systems v03r01**

## 4. Test Configuration

There is more than one SIM card slot, each one should be applied throughout the compliance test respectively, and however, only the worst case (SIM 1) will be recorded in this report.

Radiated measurements are performed by rotating the EUT in three different orthogonal test planes. EUT stand-up position (Z axis), lie-down position (X, Y axis). Receiver antenna polarization (horizontal and vertical), the worst emission was found in position (Z axis, horizontal polarization for Upper Antenna GSM Band; X axis, horizontal polarization for Low Antenna GSM Band) and the worst case was recorded.

All mode and data rates and positions and RB size and modulations were investigated. Subsequently, only the worst case emissions are reported.

The following testing in GSM is set based on the maximum RF Output Power.

Test modes are chosen to be reported as the worst case configuration below:

Test items	Modes/Modulation
	GSM 1900
RF Power Output and Effective Isotropic Radiated Power	GSM GPRS EGPRS
Occupied Bandwidth	GSM GPRS(1Tx slot) EGPRS(1Tx slot)
Band Edge Compliance	GSM GPRS(1Tx slot) EGPRS(1Tx slot)
Peak-to-Average Power Ratio	GSM GPRS(1Tx slot) EGPRS(1Tx slot)
Frequency Stability	GSM GPRS(1Tx slot) EGPRS(1Tx slot)
Spurious Emissions at Antenna Terminals	GSM
Radiates Spurious Emission	GSM



## 5. Test Case

### 5.1. RF Power Output and Effective Isotropic Radiated Power

#### Ambient condition

Temperature	Relative humidity	Pressure
23°C ~25°C	45%~50%	101.5kPa

#### Methods of Measurement

During the process of the testing, The EUT was connected to the Base Station Simulator with a known loss. The EUT is controlled by the Base Station Simulator test set to ensure max power transmission with proper modulation.

ERP can then be calculated as follows:

$$\text{EIRP (dBm)} = \text{Output Power (dBm)} - \text{Losses (dB)} + \text{Antenna Gain (dBi)}$$

where:dBd refers to gain relative to an ideal dipole.

$$\text{EIRP (dBm)} = \text{ERP (dBm)} + 2.15 \text{ (dB.)}$$

#### Test Setup

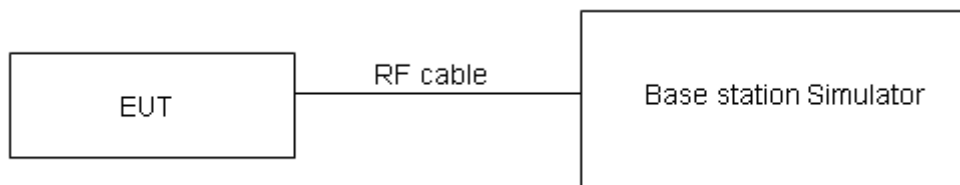

#### Limits

No specific RF power output requirements in part 2.1046.

Rule Part 24.232(c) Mobile and portable stations are limited to 2 watts EIRP.

Rule Part 24.232(e) Peak transmit power must be measured over any interval of continuous transmission using instrumentation calibrated in terms of an rms-equivalent voltage.

Limit	$\leq 2 \text{ W}$ (33 dBm)
-------	-----------------------------

#### Measurement Uncertainty

The assessed measurement uncertainty to ensure 95% confidence level for the normal distribution is with the coverage factor  $k = 2$ ,  $U = 0.4 \text{ dB}$  for RF power output,  $k = 2$ ,  $U = 1.19 \text{ dB}$  for EIRP.

#### Test Results

Refer to the section 6.1 of this report for test data.

## 5.2.Occupied Bandwidth

### Ambient condition

Temperature	Relative humidity	Pressure
23°C ~25°C	45%~50%	101.5kPa

### Method of Measurement

The EUT was connected to Spectrum Analyzer and Base Station Simulator via power Splitter. The occupied bandwidth is measured using spectrum analyzer.

RBW is set to  $\geq 1\%EBW$ , VBW is set to 3x RBW.

99% power and -26dBc occupied bandwidths are recorded. Spectrum analyzer plots are included on the following pages.

### Test Setup

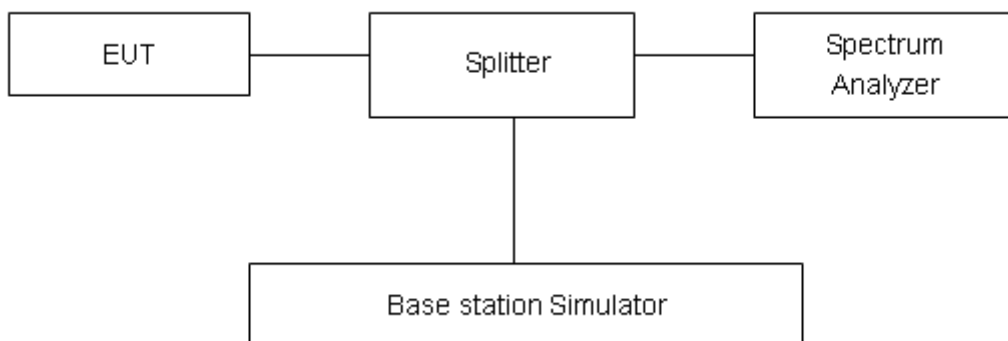

### Limits

No specific occupied bandwidth requirements in part 2.1049.

### Measurement Uncertainty

The assessed measurement uncertainty to ensure 95% confidence level for the normal distribution is with the coverage factor  $k = 2$ ,  $U = 624\text{Hz}$ .

### Test Results

Refer to the section 6.2 of this report for test data.

### 5.3. Band Edge Compliance

#### Ambient condition

Temperature	Relative humidity	Pressure
23°C ~25°C	45%~50%	101.5kPa

#### Method of Measurement

The EUT was connected to Spectrum Analyzer and Base Station Simulator via power Splitter. The band edge of the lowest and highest channels were measured. The Average detector is used and RBW is set to  $\geq 1\%EBW$ , VBW is set to 3x RBW.

Spectrum analyzer plots are included on the following pages.

#### Test Setup

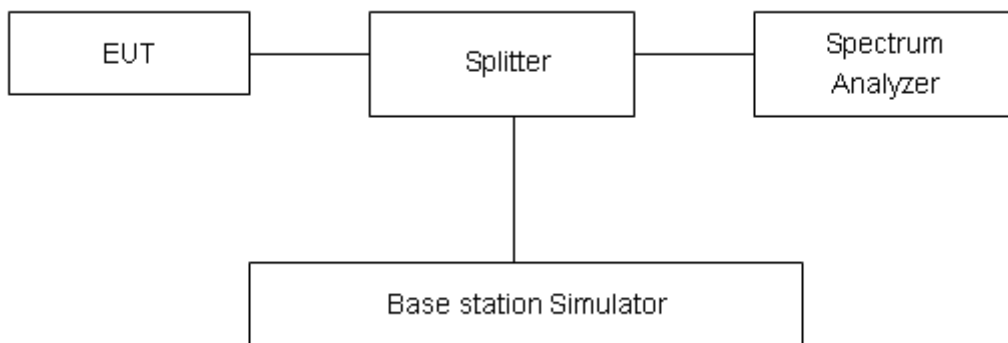

#### Limits

Rule Part 24.238(a) specifies that “on any frequency outside a licensee’s frequency block, the power of any emission shall be attenuated below the transmitter power (P) by at least  $43 + 10 \log_{10} (P)$  dB.”

Limit	-13 dBm
-------	---------

#### Measurement Uncertainty

The assessed measurement uncertainty to ensure 95% confidence level for the normal distribution is with the coverage factor  $k = 1.96$ ,  $U=0.684dB$ .

#### Test Results

Refer to the section 6.3 of this report for test data.

### 5.4. Peak-to-Average Power Ratio (PAPR)

#### Ambient condition

Temperature	Relative humidity	Pressure
23°C ~25°C	45%~50%	101.5kPa

#### Methods of Measurement

Measure the total peak power and record as PPK. And measure the total average power and record as PAvg. Both the peak and average power levels must be expressed in the same logarithmic units (e.g., dBm). Determine the PAPR from:

$$PAPR (dB) = PPK (dBm) - PAvg (dBm).$$

#### Test Setup

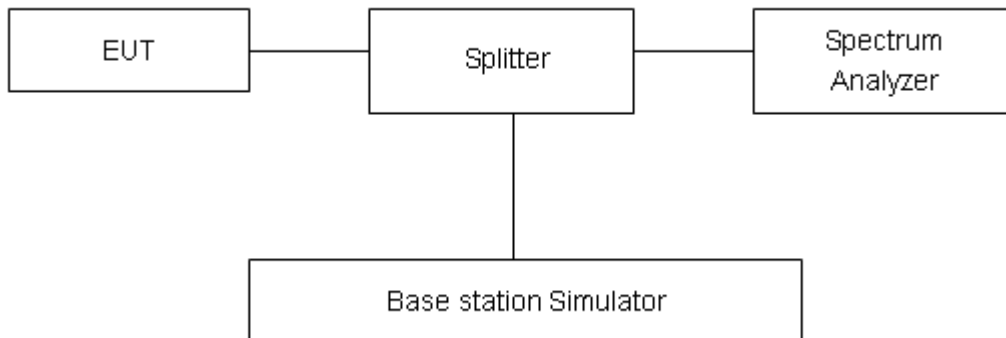

#### Limits

In measuring transmissions in this band using an average power technique, the peak-to-average ratio (PAR) of the transmission may not exceed 13 dB in 24.232(d).

#### Measurement Uncertainty

The assessed measurement uncertainty to ensure 95% confidence level for the normal distribution is with the coverage factor  $k = 2$ ,  $U = 0.4$  dB.

#### Test Results

Refer to the section 6.4 of this report for test data.

### 5.5. Frequency Stability

#### Ambient condition

Temperature	Relative humidity	Pressure
23°C ~25°C	45%~50%	101.5kPa

#### Method of Measurement

##### Frequency Stability (Temperature Variation)

The temperature inside the climate chamber is varied from -30°C to +50°C in 10°C step size,

(1) With all power removed, the temperature was decreased to 0°C and permitted to stabilize for three hours.

(2) Measure the carrier frequency with the test equipment in a “call mode”. These measurements should be made within 1 minute of powering up the mobile station, to prevent significant self warming.

(3) Repeat the above measurements at 10°C increments from -30°C to +50°C. Allow at least 1.5 hours at each temperature, un-powered, before making measurements.

##### Frequency Stability (Voltage Variation)

The frequency stability shall be measured with variation of primary supply voltage as follows:

**Primary Supply Voltage:** The primary supply voltage is varied from 85% to 115% of the nominal value for non hand-carried battery and AC powered equipment. For hand-carried, battery-powered equipment, primary supply voltage is reduced to the battery operating end point which shall be specified by the manufacturer.

This transceiver is specified to operate with an input voltage of between 3.6 V and 4.4 V, with a nominal voltage of 3.85V.

#### Test setup

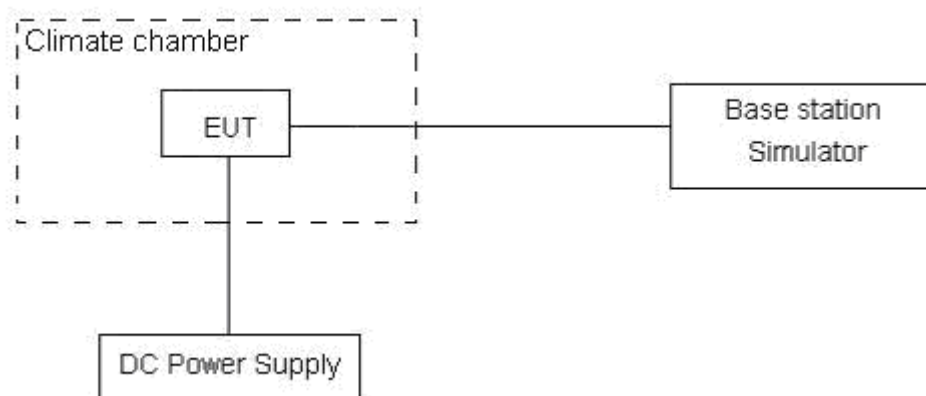

**Limits**

The frequency stability shall be sufficient to ensure that the fundamental emission stays within the authorized frequency block

**Measurement Uncertainty**

The assessed measurement uncertainty to ensure 99.75% confidence level for the normal distribution is with the coverage factor  $k = 3$ ,  $U = 0.01\text{ppm}$ .

**Test Results**

Refer to the section 6.5 of this report for test data.

## 5.6. Spurious Emissions at Antenna Terminals

### Ambient condition

Temperature	Relative humidity	Pressure
23°C ~25°C	45%~50%	101.5kPa

### Method of Measurement

The EUT was connected to Spectrum Analyzer and Base Station Simulator via power Splitter. The measurement is carried out using a spectrum analyzer. The spectrum analyzer scans from 9kHz to the 10th harmonic of the carrier. The peak detector is used.

RBW is set to 100kHz, VBW is set to 300kHz for 30MHz~1GHz

RBW is set to 1MHz, VBW is set to 3MHz for above 1GHz, Sweep is set to ATUO.

RBW is set to 1 kHz (0.009MHz~ 0.15 MHz),

RBW is set to 10 kHz (0.15 MHz~ 30 MHz)

RBW is set to 100 kHz (30MHz~1000 MHz)

RBW is set to 1000 kHz (above 1000MHz)

The modulation mode and RB allocation refer to section 5.1, using the maximum output power configuration.

### Test setup

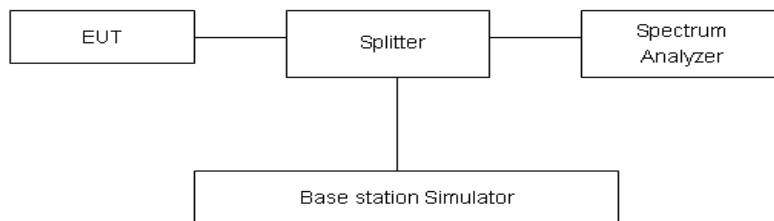

### Limits

Rule Part 24.238(a) specifies that “on any frequency outside a licensee’s frequency block, the power of any emission shall be attenuated below the transmitter power (P) by at least  $43 + 10 \log_{10}(P)$  dB.”

Limit	-13 dBm

### Measurement Uncertainty

The assessed measurement uncertainty to ensure 99.75% confidence level for the normal distribution is with the coverage factor  $k = 1.96$ .

Frequency	Uncertainty
9kHz-1GHz	0.684 dB
1GHz-20GHz	1.407 dB

### Test Results

Refer to the section 6.6 of this report for test data.

## 5.7. Radiates Spurious Emission

### Ambient condition

Temperature	Relative humidity	Pressure
23°C ~25°C	45%~50%	101.5kPa

### Method of Measurement

1. The testing follows FCC KDB 971168 v03r01 Section 5.8 and ANSI C63.26-2015.
2. Below 1GHz: The EUT is placed on a turntable 0.8 meters above the ground in the chamber, 3 meter away from the antenna. The maximal emission value is acquired by adjusting the antenna height, polarisation and turntable azimuth. Normally, the height range of antenna is 1 m to 4 m, the azimuth range of turntable is 0° to 360°, and the receive antenna has two polarizations Vertical (V) and Horizontal (H). Above 1GHz: (Note: the FCC's permission to use 1.5m as an alternative per TCBC Conf call of Dec. 2, 2014.) The EUT is placed on a turntable 1.5 meters above the ground in the chamber, 3 meter away from the antenna. The maximal emission value is acquired by adjusting the antenna height, polarisation and turntable azimuth. Normally, the height range of antenna is 1 m to 4 m, the azimuth range of turntable is 0° to 360°, and the receive antenna has two polarizations Vertical (V) and Horizontal (H).
3. A loop antenna, A log-periodic antenna or horn antenna shall be substituted in place of the EUT. The log-periodic antenna will be driven by a signal generator and the level will be adjusted till the same power value on the spectrum analyzer or receiver. The level of the spurious emissions can be calculated through the level of the signal generator, cable loss, the gain of the substitution antenna and the reading of the spectrum analyzer or receiver.
4. The EUT is then put into continuously transmitting mode at its maximum power level during the test. Set Test Receiver or Spectrum RBW=1MHz, VBW=3MHz, and the maximum value of the receiver should be recorded as (Pr).
5. The EUT shall be replaced by a substitution antenna. In the chamber, an substitution antenna for the frequency band of interest is placed at the reference point of the chamber. An RF Signal source for the frequency band of interest is connected to the substitution antenna with a cable that has been constructed to not interfere with the radiation pattern of the antenna. A power (PMea) is applied to the input of the substitution antenna, and adjust the level of the signal generator output until the value of the receiver reach the previously recorded (Pr). The power of signal source (PMea) is recorded. The test should be performed by rotating the test item and adjusting the receiving antenna polarization.
6. A amplifier should be connected to the Signal Source output port. And the cable should be connect between the Amplifier and the Substitution Antenna. The cable loss (Pcl) ,the Substitution Antenna Gain (Ga) and the Amplifier Gain (PAg) should be recorded after test.
7. The measurement results are obtained as described below:  
Power(EIRP)=PMea- PAg - Pcl + Ga  
The measurement results are amend as described below:  
Power(EIRP)=PMea- Pcl + Ga
8. This value is EIRP since the measurement is calibrated using an antenna of known gain (2.15 dB) and known input power. ERP can be calculated from EIRP by subtracting the gain of the dipole, ERP



= EIRP-2.15dB.

The modulation mode and RB allocation refer to section 5.1, using the maximum output power configuration.

**Test setup**

**9KHz~ 30MHz**

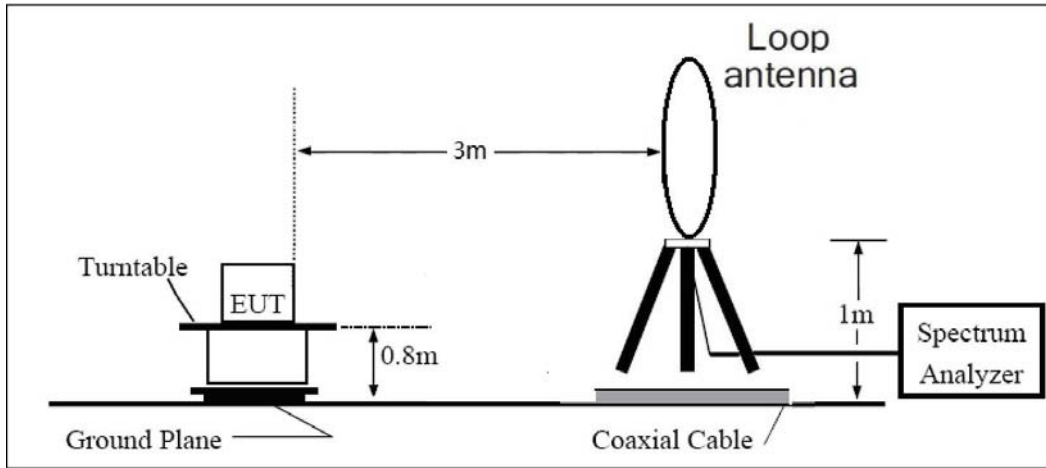

**30MHz~ 1GHz**

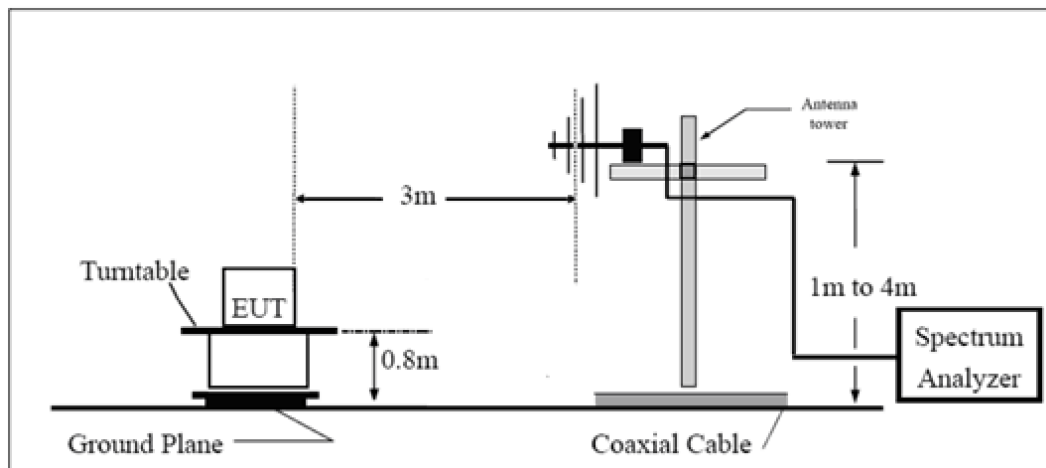

**Above 1GHz**

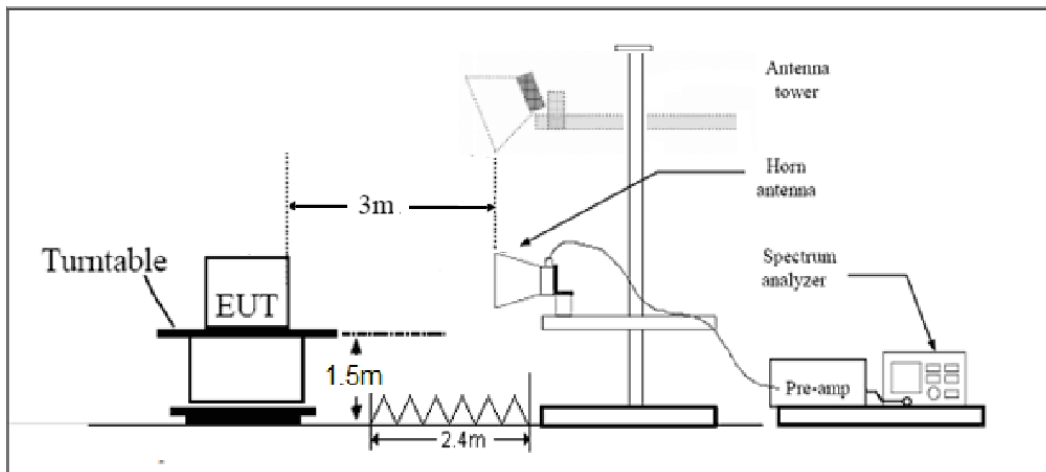

Note: Area side: 2.4mX3.6m

**Limits**

Rule Part 24.238(a) specifies that “on any frequency outside a licensee's frequency block, the power of any emission shall be attenuated below the transmitter power (P) by at least  $43 + 10 \log_{10}(P)$  dB.”

Limit	-13 dBm
-------	---------

**Measurement Uncertainty**

The assessed measurement uncertainty to ensure 95% confidence level for the normal distribution is with the coverage factor  $k = 1.96$ ,  $U = 3.55$  dB.

**Test Results**

Refer to the section 6.7 of this report for test data.

## 6. Test Results

### 6.1.RF Power Output and Effective Isotropic Radiated Power

GSM 1900 Low Antenna		Maximum Output Power (dBm)			EIRP (dBm)		
		Channel/Frenqucy(MHz)			Channel/Frenqucy(MHz)		
		512/1850.2	661/1880	810/1909.8	512/1850.2	661/1880	810/1909.8
GSM	CS	29.43	29.48	29.35	28.53	28.58	28.45
GPRS/EGPRS (GMSK)	1 Tx Slot	29.43	29.48	29.35	28.53	28.58	28.45
	2 Tx Slots	26.04	25.96	25.90	25.14	25.06	25.00
	3 Tx Slots	25.87	25.72	25.72	24.97	24.82	24.82
	4 Tx Slots	24.49	24.56	24.32	23.59	23.66	23.42
EGPRS (8PSK)	1 Tx Slot	25.82	25.79	25.72	24.92	24.89	24.82
	2 Tx Slots	23.51	23.52	23.54	22.61	22.62	22.64
	3 Tx Slots	21.82	21.94	21.82	20.92	21.04	20.92
	4 Tx Slots	20.53	20.54	20.56	19.63	19.64	19.66

GSM 1900 Upper Antenna		Maximum Output Power (dBm)			EIRP (dBm)		
		Channel/Frenqucy(MHz)			Channel/Frenqucy(MHz)		
		512/1850.2	661/1880	810/1909.8	512/1850.2	661/1880	810/1909.8
GSM	CS	30.40	30.41	30.15	29.40	29.41	29.15
GPRS/EGPRS (GMSK)	1 Tx Slot	30.40	30.41	30.15	29.40	29.41	29.15
	2 Tx Slots	26.66	26.77	26.42	25.66	25.77	25.42
	3 Tx Slots	26.48	26.56	26.17	25.48	25.56	25.17
	4 Tx Slots	25.00	25.11	24.76	24.00	24.11	23.76
EGPRS (8PSK)	1 Tx Slot	26.78	26.49	26.59	25.78	25.49	25.59
	2 Tx Slots	23.51	23.56	23.61	22.51	22.56	22.61
	3 Tx Slots	22.82	22.60	22.57	21.82	21.60	21.57
	4 Tx Slots	21.46	21.26	21.32	20.46	20.26	20.32

## 6.2. Occupied Bandwidth

Mode	Channel	Frequency (MHz)	99% Power Bandwidth (MHz)	-26dBc Bandwidth(MHz)
GSM 1900 (GMSK)	512	1850.2	0.243	0.314
	661	1880.0	0.253	0.316
	810	1909.8	0.244	0.308
GPRS 1900 (GMSK)	512	1850.2	0.244	0.313
	661	1880.0	0.251	0.317
	810	1909.8	0.242	0.309
EGPRS 1900 (8PSK)	512	1850.2	0.255	0.319
	661	1880.0	0.248	0.310
	810	1909.8	0.255	0.319

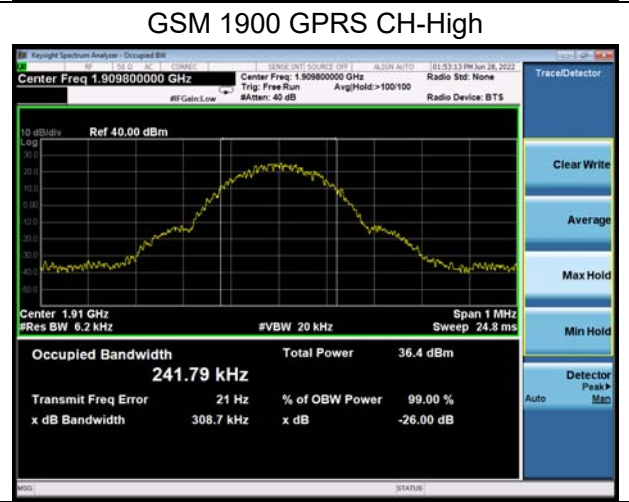
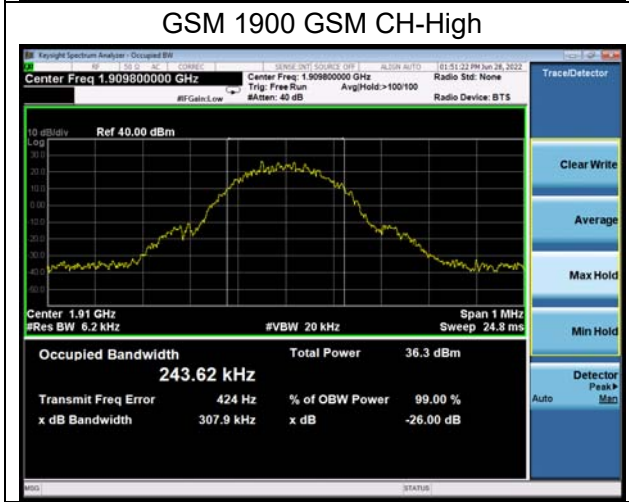
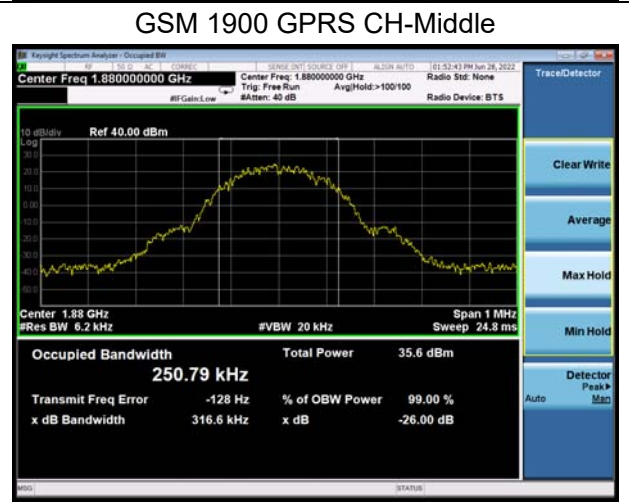
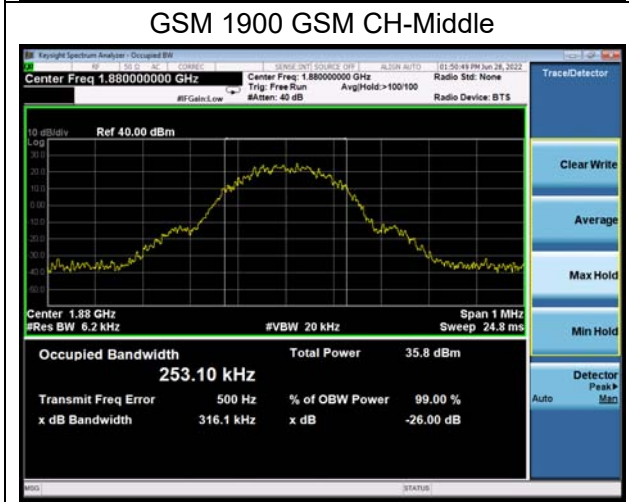
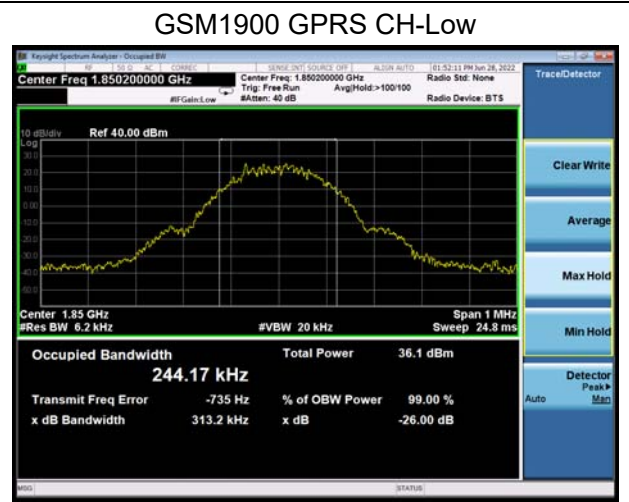

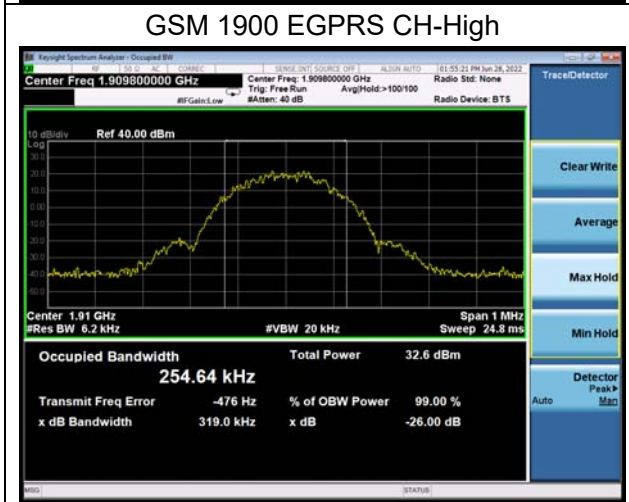
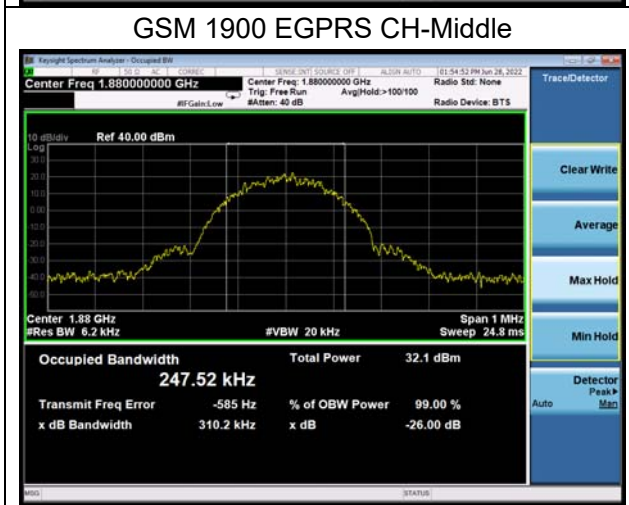
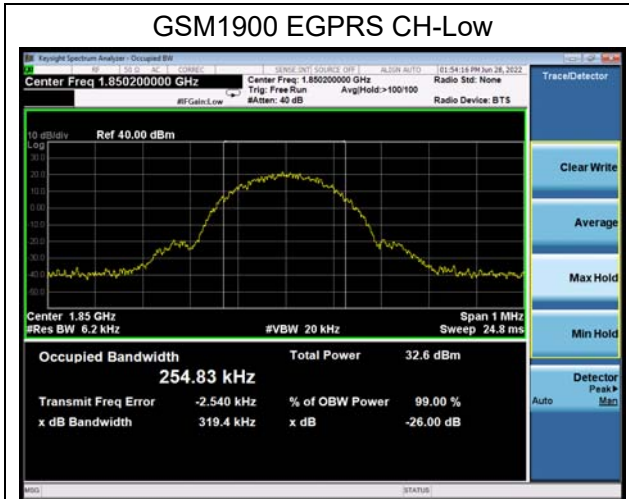

### 6.3. Band Edge Compliance

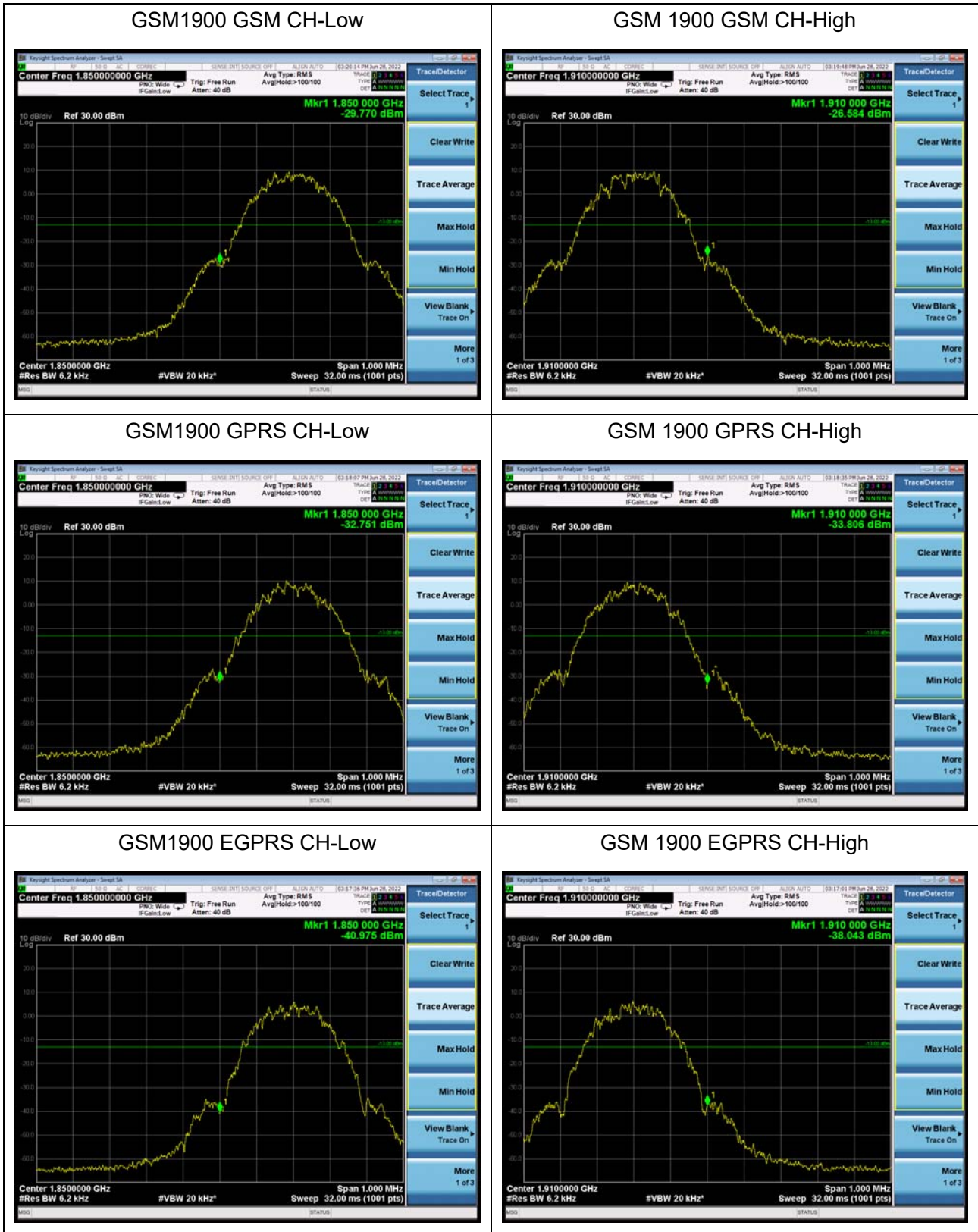

#### 6.4. Peak-to-Average Power Ratio (PAPR)

Mode	Channel	Frequency (MHz)	Peak(dBm)	Avg(dBm)	PAPR(dB)	Limit(dB)	Conclusion
GSM 1900 (GMSK)	512	1850.2	30.75	27.92	2.83	≤13	PASS
	661	1880	30.67	27.82	2.85	≤13	PASS
	810	1909.8	30.48	25.63	4.85	≤13	PASS
GPRS 1900 (GMSK)	512	1850.2	30.73	27.90	2.83	≤13	PASS
	661	1880	30.54	27.70	2.84	≤13	PASS
	810	1909.8	30.41	25.63	4.78	≤13	PASS
EGPRS 1900 (8PSK)	512	1850.2	29.58	23.95	5.63	≤13	PASS
	661	1880	29.48	23.83	5.65	≤13	PASS
	810	1909.8	29.66	22.27	7.39	≤13	PASS



### 6.5. Frequency Stability

GSM 1900						
Condition		Freq.Error (Hz)	Freq.Error (Hz)	Frequency Stability (ppm)	Frequency Stability (ppm)	Verdict
Temperature	Voltage	GMSK	8PSK	GMSK	8PSK	
Normal (25°C)	Normal	4.76	1.55	0.00253	0.00082	PASS
Extreme (50°C)		3.51	8.18	0.00187	0.00435	PASS
Extreme (40°C)		15.32	2.69	0.00815	0.00143	PASS
Extreme (30°C)		10.08	11.72	0.00536	0.00623	PASS
Extreme (20°C)		1.36	5.31	0.00072	0.00283	PASS
Extreme (10°C)		16.01	5.17	0.00852	0.00275	PASS
Extreme (0°C)		1.90	17.18	0.00101	0.00914	PASS
Extreme (-10°C)		14.67	17.19	0.00780	0.00914	PASS
Extreme (-20°C)		15.62	13.72	0.00831	0.00730	PASS
Extreme (-30°C)		5.81	9.60	0.00309	0.00510	PASS
25°C	LV	2.34	9.04	0.00125	0.00481	PASS
	HV	6.62	17.84	0.00352	0.00949	PASS

### 6.6. Spurious Emissions at Antenna Terminals

Sweep the whole frequency band through the range from 9kHz to the 10th harmonic of the carrier, the emissions more than 20 dB below the limit are not reported. The signal beyond the limit is carrier.

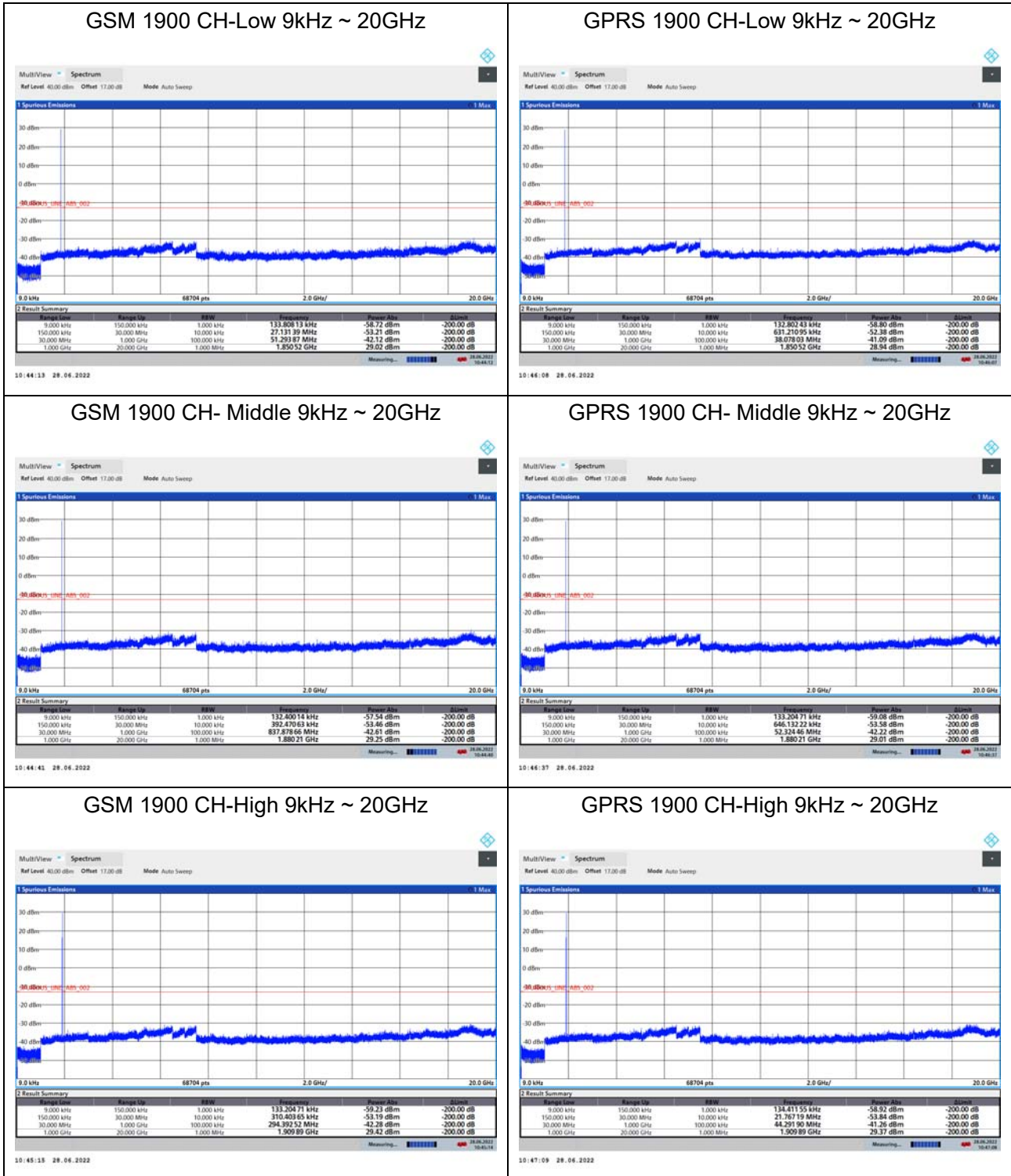

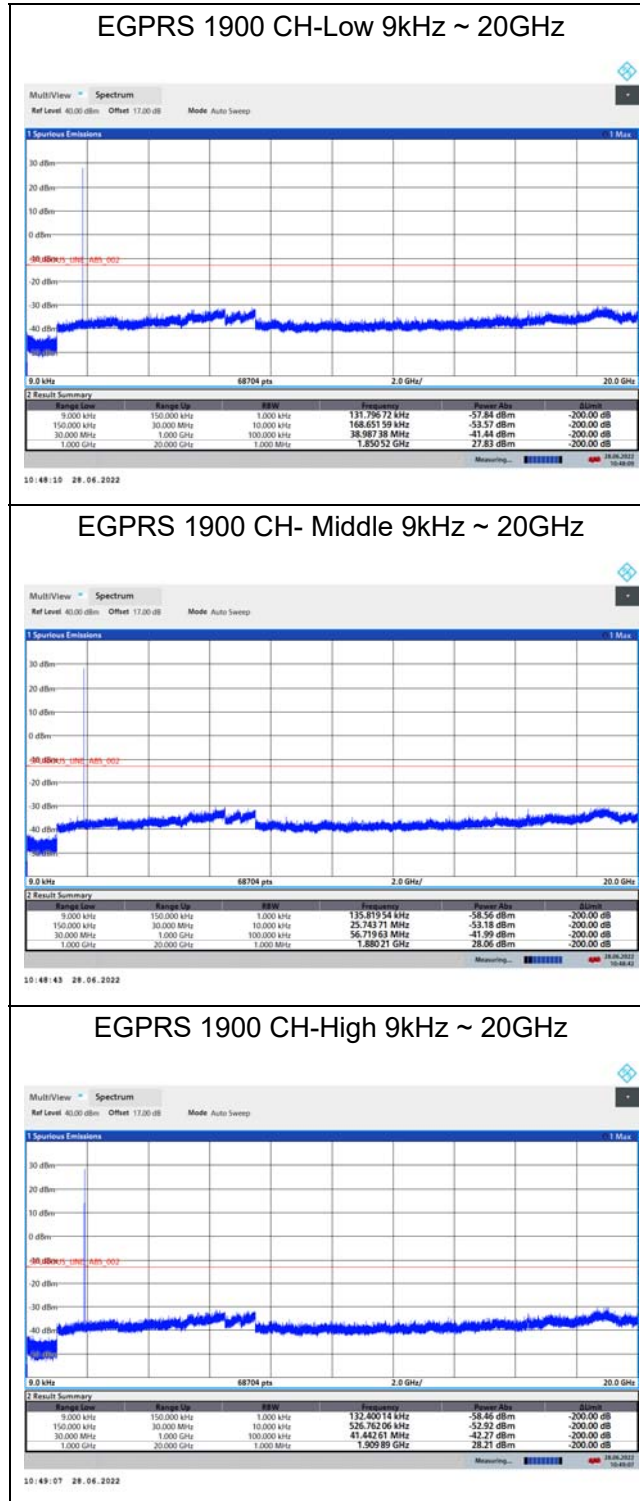

### 6.7. Radiates Spurious Emission

Sweep the whole frequency band through the range from 9kHz to the 10th harmonic of the carrier, the emissions below the noise floor will not be recorded in the report.

#### Upper Antenna

GSM 1900 CH-Middle

Harmonic	Frequency (MHz)	SG (dBm)	Cable Loss (dB)	Gain (dBi)	Antenna Polarization	EIRP Level (dBm)	Limit (dBm)	Margin (dB)	Azimuth (deg)
2	3760.00	-65.13	2.60	12.50	Horizontal	-55.23	-13.00	42.23	315
3	5640.00	-57.05	3.30	12.50	Horizontal	-47.85	-13.00	34.85	90
4	7520.00	-59.29	4.20	12.20	Horizontal	-51.29	-13.00	38.29	225
5	9400.00	-54.74	4.30	11.10	Horizontal	-47.94	-13.00	34.94	0
6	11280.00	-51.93	5.90	11.90	Horizontal	-45.93	-13.00	32.93	180
7	13160.00	-51.79	5.70	14.00	Horizontal	-43.49	-13.00	30.49	45
8	15040.00	-47.70	5.80	13.10	Horizontal	-40.40	-13.00	27.40	135
9	16920.00	-49.46	6.10	14.60	Horizontal	-40.96	-13.00	27.96	225
10	18800.00	--	--	--	--	--	--	--	--

Note: 1. The other Spurious RF Radiated emissions level is no more than noise floor.

2. The worst emission was found in the antenna is Horizontal position.

**Low Antenna**

GSM 1900 CH-Middle

Harmonic	Frequency (MHz)	SG (dBm)	Cable Loss (dB)	Gain (dBi)	Antenna Polarization	EIRP Level (dBm)	Limit (dBm)	Margin (dB)	Azimuth (deg)
2	3760.00	-58.47	2.60	12.50	Horizontal	-48.57	-13.00	35.57	135
3	5640.00	-45.39	3.30	12.50	Horizontal	-36.19	-13.00	23.19	180
4	7520.00	-59.98	4.20	12.20	Horizontal	-51.98	-13.00	38.98	45
5	9400.00	-53.19	4.30	11.10	Horizontal	-46.39	-13.00	33.39	315
6	11280.00	-51.38	5.90	11.90	Horizontal	-45.38	-13.00	32.38	225
7	13160.00	-52.45	5.70	14.00	Horizontal	-44.15	-13.00	31.15	90
8	15040.00	-48.30	5.80	13.10	Horizontal	-41.00	-13.00	28.00	0
9	16920.00	-49.84	6.10	14.60	Horizontal	-41.34	-13.00	28.34	270
10	18800.00	--	--	--	--	--	--	--	--

Note: 1. The other Spurious RF Radiated emissions level is no more than noise floor.

2. The worst emission was found in the antenna is Horizontal position.

## 7. Main Test Instruments

Name	Manufacturer	Type	Serial Number	Calibration Date	Expiration Date
Base Station Simulator	R&S	CMW500	150415	2022-05-14	2023-05-13
Spectrum Analyzer	Keysight	N9020A	MY50510203	2021-12-12	2022-12-11
Universal Radio Communication Tester	Agilent	E5515C	GB44400275	2021-12-12	2022-12-11
Signal Analyzer	R&S	FSV3030	101411	2021-12-12	2022-12-11
Climatic Chamber	ESPEC	SU-242	93000506	2021-12-12	2022-12-11
<b>Radiates Spurious Emission</b>					
Signal Analyzer	R&S	FSV30	100815	2021-12-12	2022-12-11
Loop Antenna	SCHWARZBECK	FMZB1519	1519-047	2020-04-02	2023-04-01
TRILOG Broadband Antenna	SCHWARZBECK	VULB 9163	391	2019-12-16	2022-12-15
Horn Antenna	R&S	HF907	102723	2020-08-11	2023-08-10
Horn Antenna	ETS-Lindgren	3160-09	00102643	2021-10-10	2024-10-09
Software	R&S	EMC32	10.35.10	/	/

\*\*\*\*\*END OF REPORT \*\*\*\*\*



## **ANNEX A: The EUT Appearance**

**The EUT Appearance is submitted separately.**



## **ANNEX B: Test Setup Photos**

**The Test Setup Photos is submitted separately.**





## **ANNEX C: Product Change Description (Variant 1)**

The Product Change Description are submitted separately.



## **ANNEX D: Product Change Description (Variant 2)**

The Product Change Description are submitted separately.