

Plot 30 GSM 1900 Back Side Middle (Distance 15mm)

Date: 2022/6/23

Communication System: UID 0, GSM (0); Frequency: 1880 MHz; Duty Cycle: 1:8.3

Medium parameters used: $f = 1880$ MHz; $\sigma = 1.42$ S/m; $\epsilon_r = 38.948$; $\rho = 1000$ kg/m³

Ambient Temperature: 22.3 °C Liquid Temperature: 21.5 °C

Phantom section: Flat Section

DASY5 Configuration:

Sensor-Surface: 1.4mm (Mechanical Surface Detection)

Probe: EX3DV4 - SN3677; ConvF(7.88, 7.88, 7.88); Calibrated: 2021/8/12

Electronics: DAE4 SN1692; Calibrated: 2021/10/4

Phantom: SAM 2; Type: QD000P40CD; Serial: TP:1666

Measurement SW: DASY52, Version 52.10 (4); SEMCAD X Version 14.6.14 (7483)

Back Side Middle/Area Scan (8x14x1): Measurement grid: dx=15mm, dy=15mm

Maximum value of SAR (measured) = 0.23 W/kg

Back Side Middle/Zoom Scan (5x5x7)/Cube 0: Measurement grid: dx=8mm, dy=8mm, dz=5mm

Reference Value = 5.167 V/m; Power Drift = 0.036 dB

Peak SAR (extrapolated) = 0.318 W/kg

SAR(1 g) = 0.211 W/kg; SAR(10 g) = 0.135W/kg

Maximum value of SAR (measured) = 0.25 W/kg

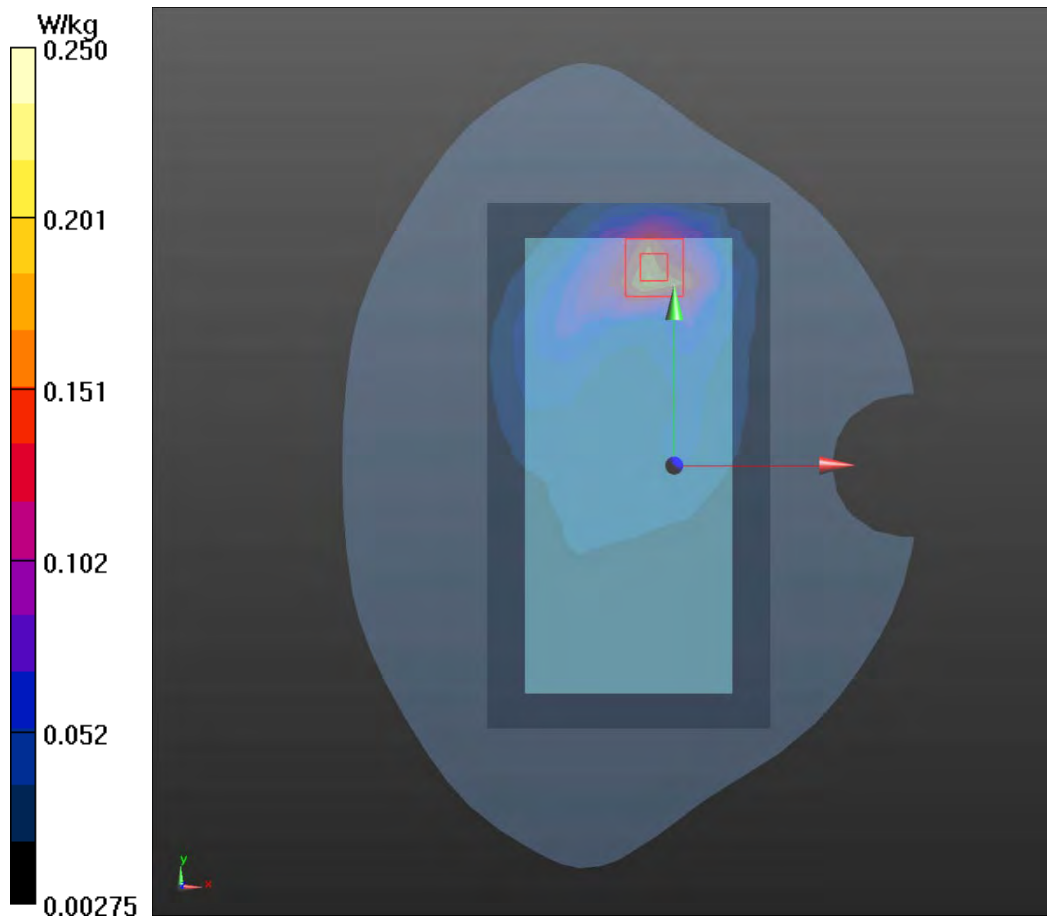

Plot 31 LTE Band 7 1RB Back Side High (Distance 15mm)

Date: 2022/6/30

Communication System: UID 0, LTE (0); Frequency: 2560 MHz; Duty Cycle: 1:1

Medium parameters used: $f = 2560$ MHz; $\sigma = 1.971$ S/m; $\epsilon_r = 37.231$; $\rho = 1000$ kg/m³

Ambient Temperature: 22.3 °C Liquid Temperature: 21.5 °C

Phantom section: Flat Section

DASY5 Configuration:

Sensor-Surface: 1.4mm (Mechanical Surface Detection)

Probe: EX3DV4 - SN3677; ConvF(7.25, 7.25, 7.25); Calibrated: 2021/8/12

Electronics: DAE4 SN1692; Calibrated: 2021/10/4

Phantom: SAM 2; Type: QD000P40CD; Serial: TP:1666

Measurement SW: DASY52, Version 52.10 (4); SEMCAD X Version 14.6.14 (7483)

Back Side High/Area Scan (10x18x1): Measurement grid: dx=12mm, dy=12mm

Maximum value of SAR (measured) = 0.915 W/kg

Back Side High/Zoom Scan (7x7x7)/Cube 0: Measurement grid: dx=5mm, dy=5mm, dz=5mm

Reference Value = 4.432 V/m; Power Drift = 0.022 dB

Peak SAR (extrapolated) = 2.09 W/kg

SAR(1 g) = 0.765 W/kg; SAR(10 g) = 0.398 W/kg

Maximum value of SAR (measured) = 1.20 W/kg

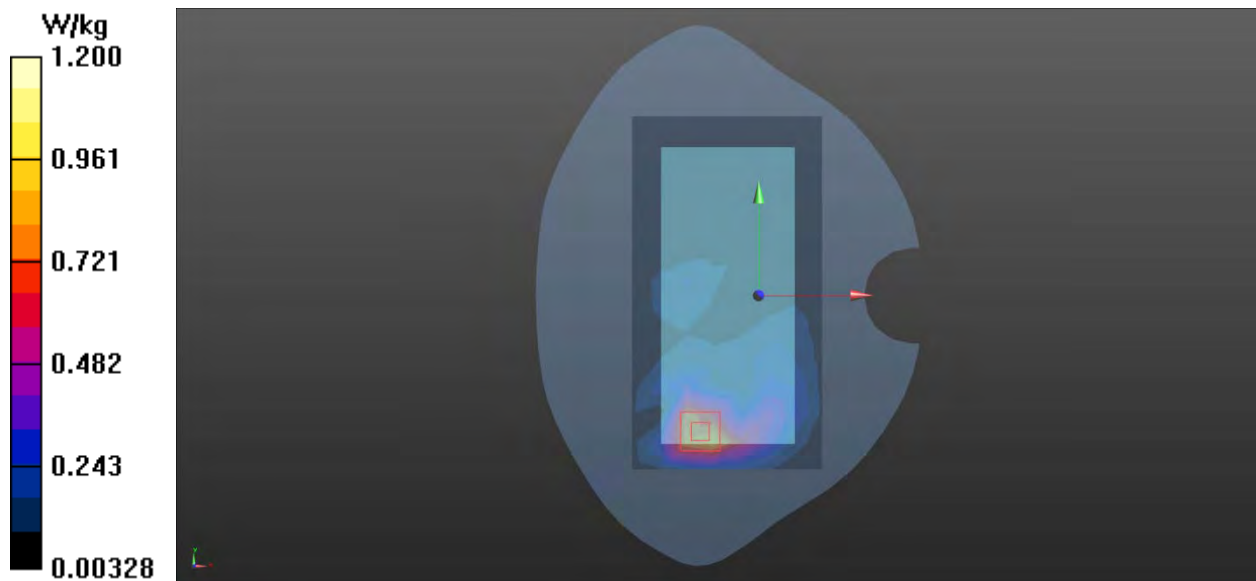

Plot 32 802.11b Back Side Low (Distance 15mm)

Date: 2022/6/28

Communication System: UID 0, 802.11b (0); Frequency: 2412 MHz; Duty Cycle: 1:1.02

Medium parameters used: $f = 2412$ MHz; $\sigma = 1.801$ S/m; $\epsilon_r = 37.737$; $\rho = 1000$ kg/m³

Ambient Temperature: 22.3 °C Liquid Temperature: 21.5 °C

Phantom section: Flat Section

DASY5 Configuration:

Sensor-Surface: 1.4mm (Mechanical Surface Detection)

Probe: EX3DV4 - SN3677; ConvF(7.50, 7.50, 7.50); Calibrated: 2021/8/12

Electronics: DAE4 SN1692; Calibrated: 2021/10/4

Phantom: SAM 2; Type: QD000P40CD; Serial: TP:1666

Measurement SW: DASY52, Version 52.10 (4); SEMCAD X Version 14.6.14 (7483)

Back Side Low/Area Scan (10x18x1): Measurement grid: dx=12mm, dy=12mm

Maximum value of SAR (measured) = 0.158 W/kg

Back Side Low/Zoom Scan (7x7x7)/Cube 0: Measurement grid: dx=5mm, dy=5mm, dz=5mm

Reference Value = 5.475 V/m; Power Drift = 0.021 dB

Peak SAR (extrapolated) = 0.246 W/kg

SAR(1 g) = 0.154 W/kg; SAR(10 g) = 0.085 W/kg

Maximum value of SAR (measured) = 0.164 W/kg

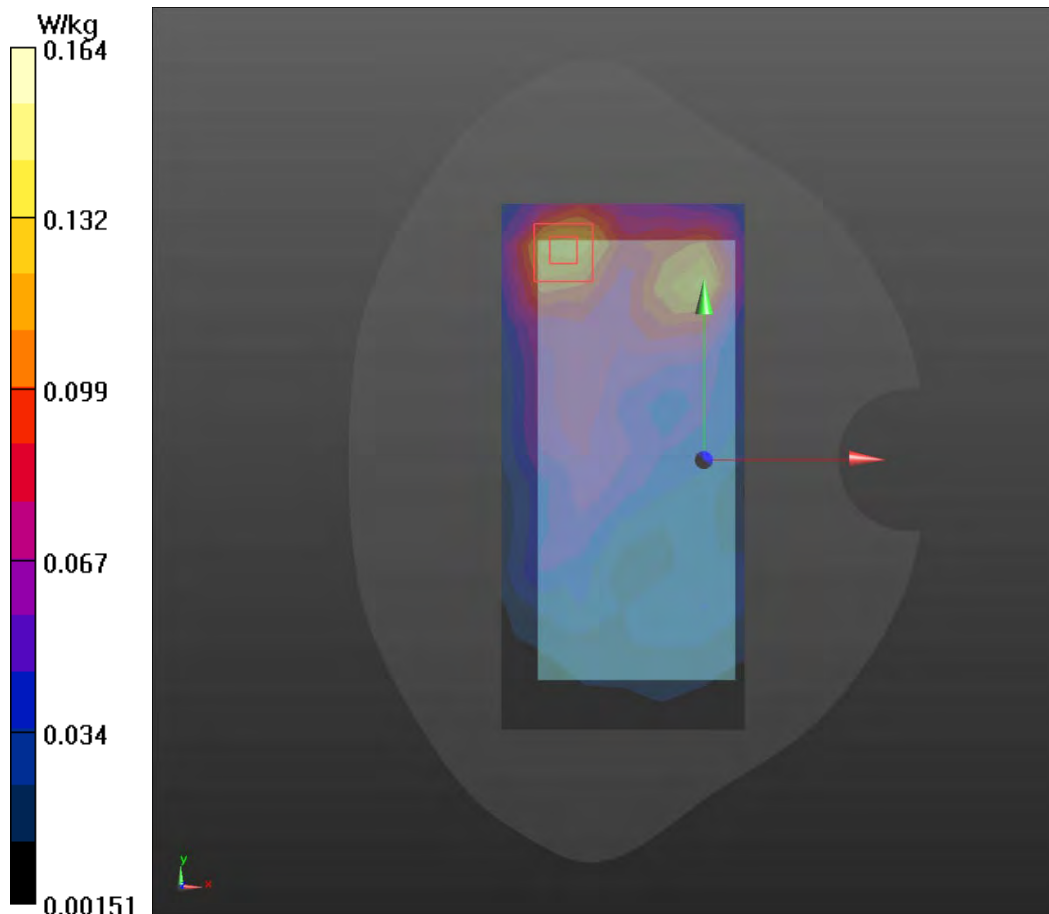

Plot 33 GSM 850 GPRS (3Txslots) Back Side Middle (Distance 10mm)

Date: 2022/6/26

Communication System: UID 0, GPRS 3TX (0); Frequency: 836.6 MHz; Duty Cycle: 1:2.77

Medium parameters used: $f = 836.6$ MHz; $\sigma = 0.953$ S/m; $\epsilon_r = 39.762$; $\rho = 1000$ kg/m³

Ambient Temperature: 22.3 °C Liquid Temperature: 21.5 °C

Phantom section: Flat Section

DASY5 Configuration:

Sensor-Surface: 1.4mm (Mechanical Surface Detection)

Probe: EX3DV4 - SN3677; ConvF(9.30, 9.30, 9.30); Calibrated: 2021/8/12

Electronics: DAE4 SN1692; Calibrated: 2021/10/4

Phantom: SAM 2; Type: QD000P40CD; Serial: TP:1666

Measurement SW: DASY52, Version 52.10 (4); SEMCAD X Version 14.6.14 (7483)

Back Side Middle/Area Scan (8x14x1): Measurement grid: dx=15mm, dy=15mm

Maximum value of SAR (measured) = 0.57 W/kg

Back Side Middle/Zoom Scan (5x5x7)/Cube 0: Measurement grid: dx=8mm, dy=8mm, dz=5mm

Reference Value = 17.96 V/m; Power Drift = 0.011 dB

Peak SAR (extrapolated) = 0.799 W/kg

SAR(1 g) = 0.582W/kg; SAR(10 g) = 0.344 W/kg

Maximum value of SAR (measured) = 0.580 W/kg

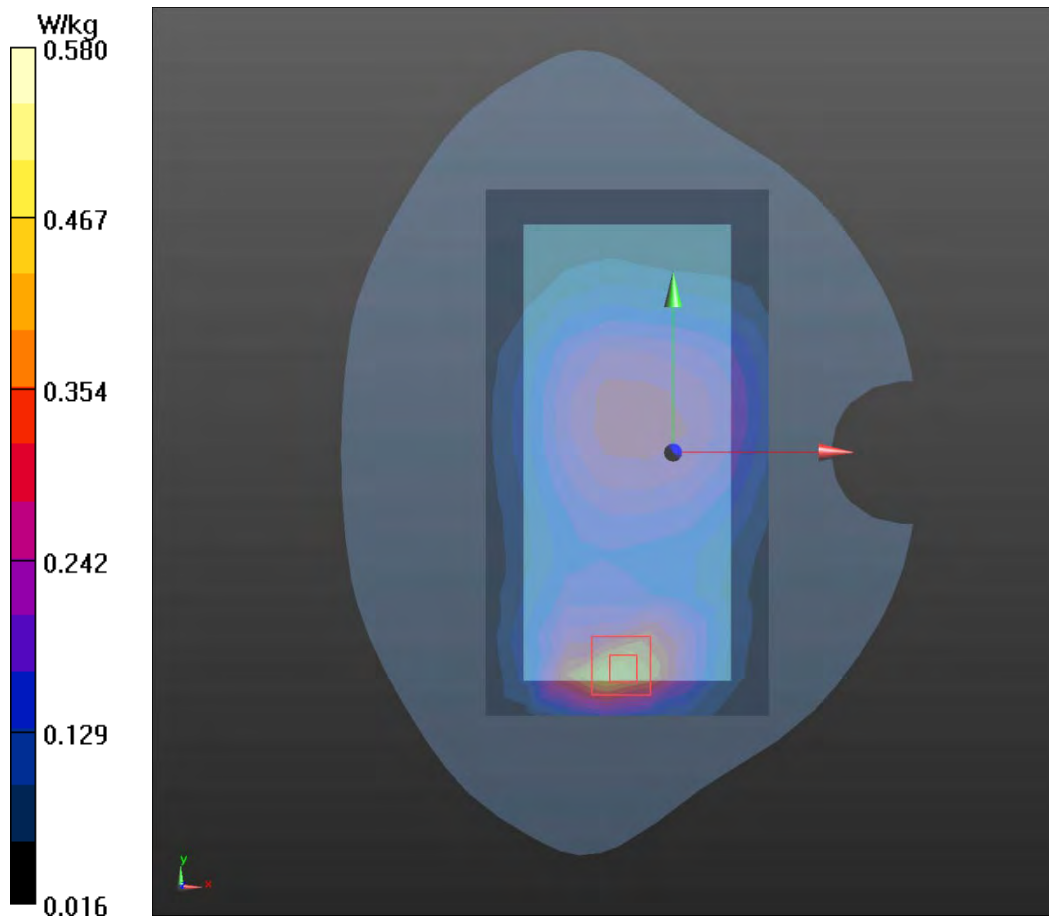

Plot 34 GSM 1900 GPRS (4Txslots) Top Edge Middle (Distance 10mm)

Date: 2022/6/23

Communication System: UID 0, GPRS 4TX (0); Frequency: 1880 MHz; Duty Cycle: 1:2.07

Medium parameters used: $f = 1880$ MHz; $\sigma = 1.42$ S/m; $\epsilon_r = 38.948$; $\rho = 1000$ kg/m³

Ambient Temperature: 22.3 °C Liquid Temperature: 21.5 °C

Phantom section: Flat Section

DASY5 Configuration:

Sensor-Surface: 1.4mm (Mechanical Surface Detection)

Probe: EX3DV4 - SN3677; ConvF(7.88, 7.88, 7.88); Calibrated: 2021/8/12

Electronics: DAE4 SN1692; Calibrated: 2021/10/4

Phantom: SAM 2; Type: QD000P40CD; Serial: TP:1666

Measurement SW: DASY52, Version 52.10 (4); SEMCAD X Version 14.6.14 (7483)

Top Edge Middle/Area Scan (4x8x1): Measurement grid: dx=15mm, dy=15mm

Maximum value of SAR (measured) = 0.498 W/kg

Top Edge Middle/Zoom Scan (5x5x7)/Cube 0: Measurement grid: dx=8mm, dy=8mm, dz=5mm

Reference Value = 12.53 V/m; Power Drift = 0.16 dB

Peak SAR (extrapolated) = 0.869 W/kg

SAR(1 g) = 0.495 W/kg; SAR(10 g) = 0.258 W/kg

Maximum value of SAR (measured) = 0.559 W/kg

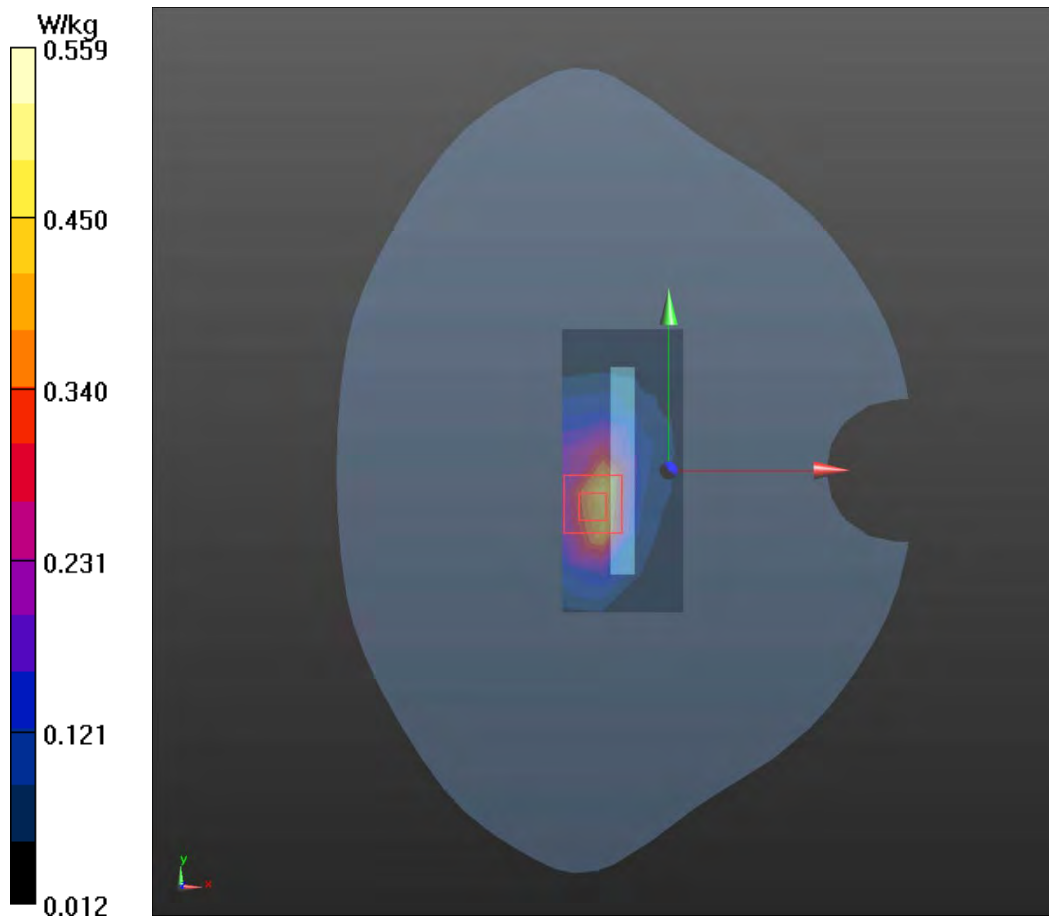

Plot 35 UMTS Band V Top Edge Middle (Distance 10mm)

Date: 2022/6/26

Communication System: UID 0, WCDMA (0); Frequency: 836.6 MHz; Duty Cycle: 1:1

Medium parameters used: $f = 836.6$ MHz; $\sigma = 0.953$ S/m; $\epsilon_r = 39.762$; $\rho = 1000$ kg/m³

Ambient Temperature: 22.3 °C Liquid Temperature: 21.5 °C

Phantom section: Flat Section

DASY5 Configuration:

Sensor-Surface: 1.4mm (Mechanical Surface Detection)

Probe: EX3DV4 - SN3677; ConvF(9.30, 9.30, 9.30); Calibrated: 2021/8/12

Electronics: DAE4 SN1692; Calibrated: 2021/10/4

Phantom: SAM 2; Type: QD000P40CD; Serial: TP:1666

Measurement SW: DASY52, Version 52.10 (4); SEMCAD X Version 14.6.14 (7483)

Top Edge Middle /Area Scan (4x8x1): Measurement grid: dx=15mm, dy=15mm

Maximum value of SAR (measured) = 0.368 W/kg

Top Edge Middle /Zoom Scan (5x5x7)/Cube 0: Measurement grid: dx=8mm, dy=8mm, dz=5mm

Reference Value = 14.08 V/m; Power Drift = 0.00 dB

Peak SAR (extrapolated) = 0.399 W/kg

SAR(1 g) = 0.362 W/kg; SAR(10 g) = 0.211 W/kg

Maximum value of SAR (measured) = 0.370 W/kg

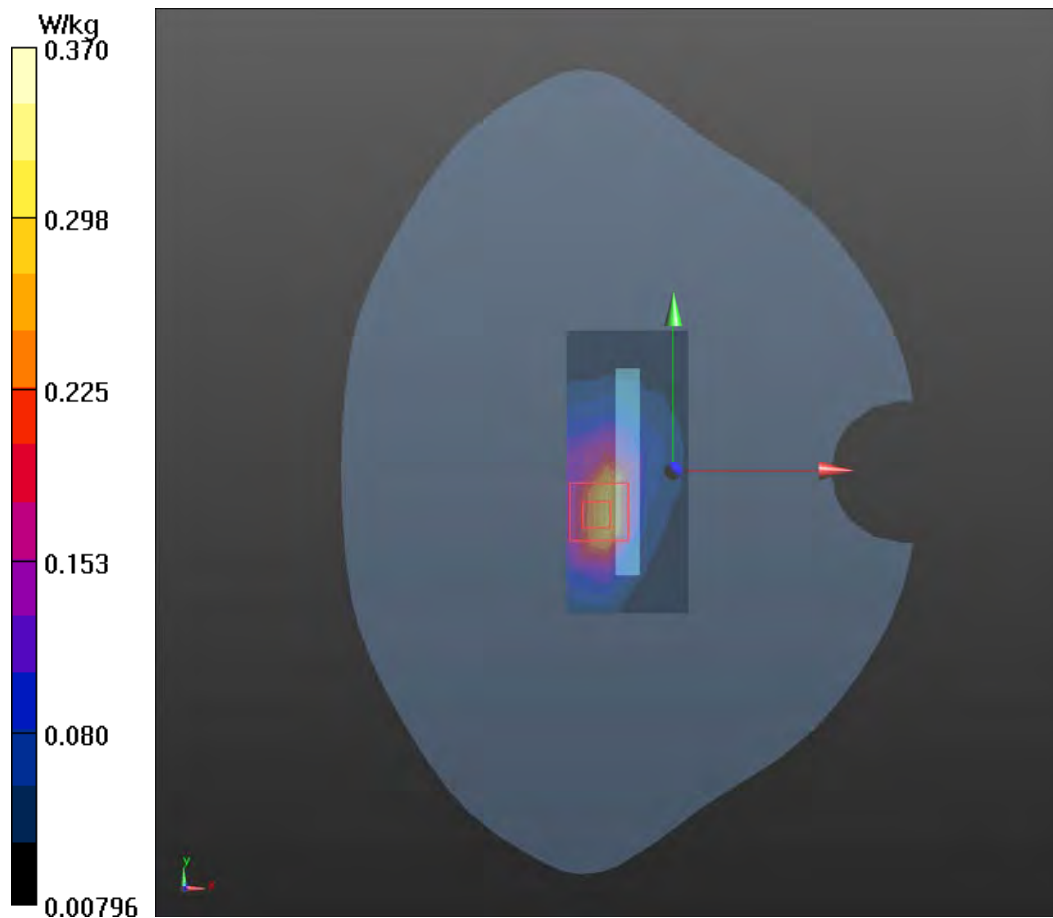

Plot 36 LTE Band 5 1RB Front Side High (Distance 10mm)

Date: 2022/6/26

Communication System: UID 0, LTE (0); Frequency: 844 MHz; Duty Cycle: 1:1

Medium parameters used: $f = 844$ MHz; $\sigma = 0.958$ S/m; $\epsilon_r = 39.728$; $\rho = 1000$ kg/m³

Ambient Temperature: 22.3 °C Liquid Temperature: 21.5 °C

Phantom section: Flat Section

DASY5 Configuration:

Sensor-Surface: 1.4mm (Mechanical Surface Detection)

Probe: EX3DV4 - SN3677; ConvF(9.30, 9.30, 9.30); Calibrated: 2021/8/12

Electronics: DAE4 SN1692; Calibrated: 2021/10/4

Phantom: SAM 2; Type: QD000P40CD; Serial: TP:1666

Measurement SW: DASY52, Version 52.10 (4); SEMCAD X Version 14.6.14 (7483)

Front Side High/Area Scan (8x14x1): Measurement grid: dx=15mm, dy=15mm

Maximum value of SAR (measured) = 0.615 W/kg

Front Side High/Zoom Scan (5x5x7)/Cube 0: Measurement grid: dx=8mm, dy=8mm, dz=5mm

Reference Value = 16.25 V/m; Power Drift = 0.041 dB

Peak SAR (extrapolated) = 0.969 W/kg

SAR(1 g) = 0.495 W/kg; SAR(10 g) = 0.265 W/kg

Maximum value of SAR (measured) = 0.631 W/kg

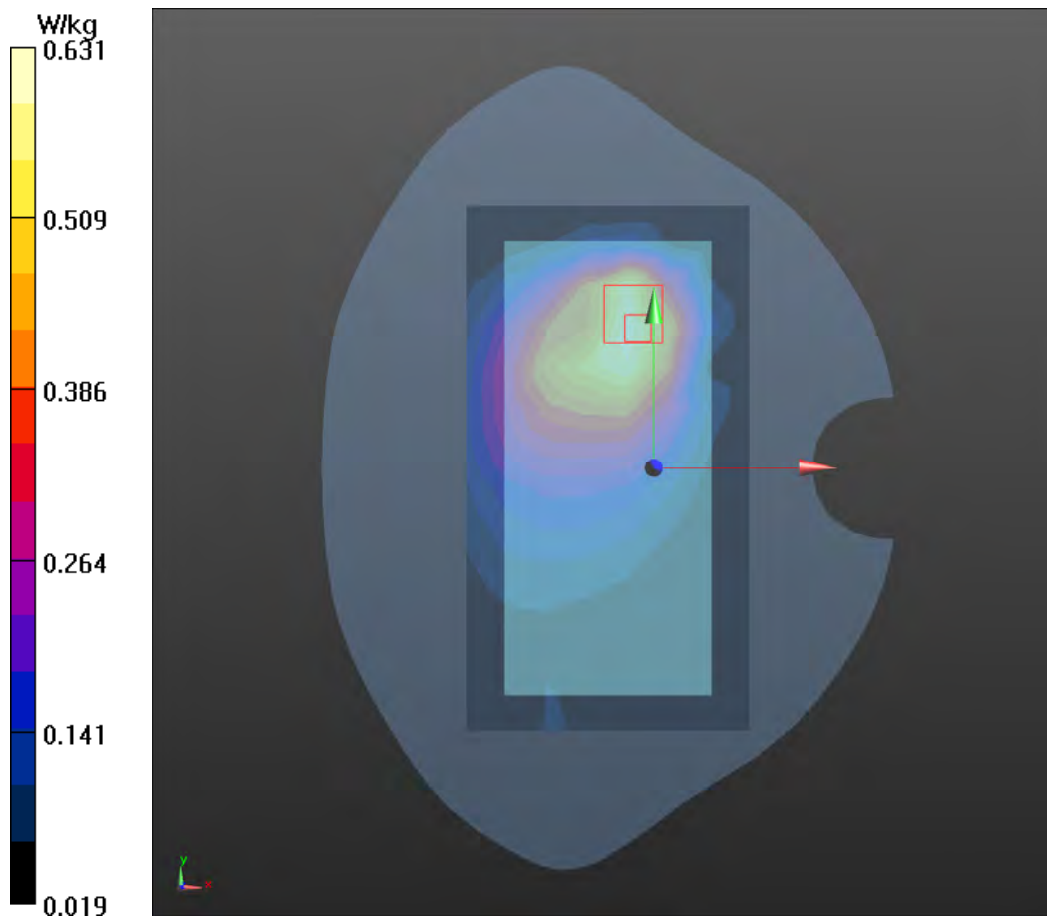

Plot 37 LTE Band 7 1RB Front Side High (Distance 10mm)

Date: 2022/7/2

Communication System: UID 0, LTE (0); Frequency: 2560 MHz; Duty Cycle: 1:1

Medium parameters used: $f = 2560$ MHz; $\sigma = 1.971$ S/m; $\epsilon_r = 37.231$; $\rho = 1000$ kg/m³

Ambient Temperature: 22.3 °C Liquid Temperature: 21.5 °C

Phantom section: Flat Section

DASY5 Configuration:

Sensor-Surface: 1.4mm (Mechanical Surface Detection)

Probe: EX3DV4 - SN3677; ConvF(7.25, 7.25, 7.25); Calibrated: 2021/8/12

Electronics: DAE4 SN1692; Calibrated: 2021/10/4

Phantom: SAM 2; Type: QD000P40CD; Serial: TP:1666

Measurement SW: DASY52, Version 52.10 (4); SEMCAD X Version 14.6.14 (7483)

Front Side High/Area Scan (10x18x1): Measurement grid: dx=12mm, dy=12mm

Maximum value of SAR (measured) = 0.926 W/kg

Front Side High/Zoom Scan (7x7x7)/Cube 0: Measurement grid: dx=5mm, dy=5mm, dz=5mm

Reference Value = 10.67 V/m; Power Drift = -0.09 dB

Peak SAR (extrapolated) = 1.43 W/kg

SAR(1 g) = 0.895 W/kg; SAR(10 g) = 0.439 W/kg

Maximum value of SAR (measured) = 0.980 W/kg

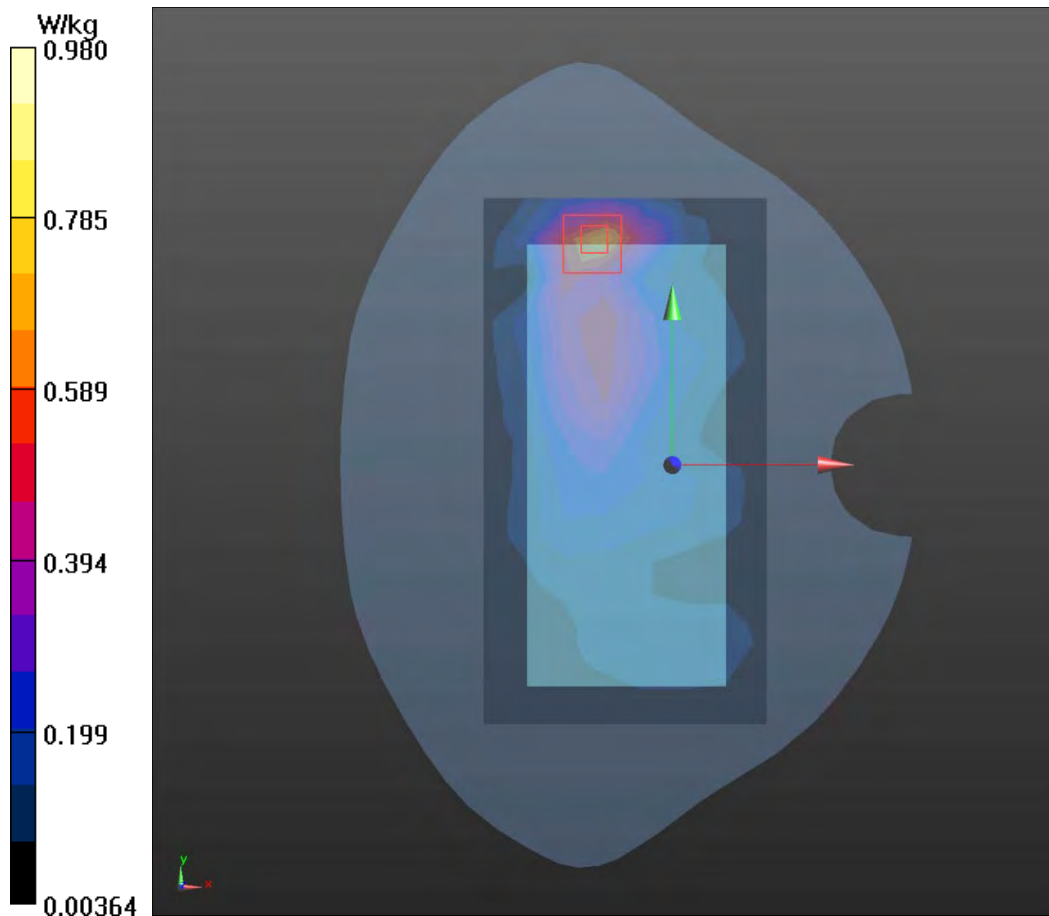

Plot 38 LTE Band 38 1RB Top Edge High (Distance 10mm)

Date: 2022/7/2

Communication System: UID 0, LTE (0); Frequency: 2610 MHz; Duty Cycle: 1:1.58

Medium parameters used: $f = 2610$ MHz; $\sigma = 2.027$ S/m; $\epsilon_r = 37.056$; $\rho = 1000$ kg/m³

Ambient Temperature: 22.3 °C Liquid Temperature: 21.5 °C

Phantom section: Flat Section

DASY5 Configuration:

Sensor-Surface: 1.4mm (Mechanical Surface Detection)

Probe: EX3DV4 - SN3677; ConvF(7.25, 7.25, 7.25); Calibrated: 2021/8/12

Electronics: DAE4 SN1692; Calibrated: 2021/10/4

Phantom: SAM 2; Type: QD000P40CD; Serial: TP:1666

Measurement SW: DASY52, Version 52.10 (4); SEMCAD X Version 14.6.14 (7483)

Top Edge High/Area Scan (5x10x1): Measurement grid: dx=12mm, dy=12mm

Maximum value of SAR (measured) = 0.821 W/kg

Top Edge High/Zoom Scan (7x7x7)/Cube 0: Measurement grid: dx=5mm, dy=5mm, dz=5mm

Reference Value = 7.660 V/m; Power Drift = 0.15 dB

Peak SAR (extrapolated) = 1.86 W/kg

SAR(1 g) = 0.814 W/kg; SAR(10 g) = 0.339 W/kg

Maximum value of SAR (measured) = 0.839 W/kg

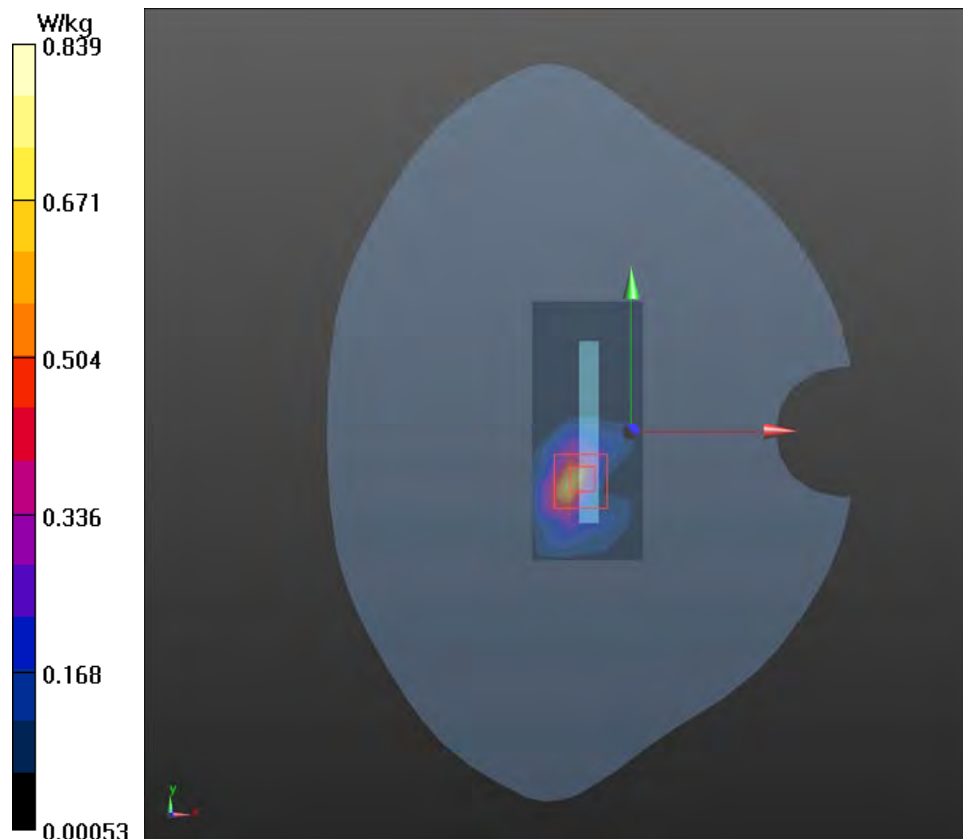

Plot 39 LTE Band 41 50%RB Top Edge Middle (Distance 10mm)

Date: 2022/7/3

Communication System: UID 0, LTE (0); Frequency: 2593 MHz; Duty Cycle: 1:1.58

Medium parameters used: $f = 2593$ MHz; $\sigma = 1.984$ S/m; $\epsilon_r = 37.196$; $\rho = 1000$ kg/m³

Ambient Temperature: 22.3 °C Liquid Temperature: 21.5 °C

Phantom section: Flat Section

DASY5 Configuration:

Sensor-Surface: 1.4mm (Mechanical Surface Detection)

Probe: EX3DV4 - SN3677; ConvF(7.25, 7.25, 7.25); Calibrated: 2021/8/12

Electronics: DAE4 SN1692; Calibrated: 2021/10/4

Phantom: SAM 2; Type: QD000P40CD; Serial: TP:1666

Measurement SW: DASY52, Version 52.10 (4); SEMCAD X Version 14.6.14 (7483)

Top Edge Middle/Area Scan (5x10x1): Measurement grid: dx=12mm, dy=12mm

Maximum value of SAR (measured) = 0.854 W/kg

Top Edge Middle/Zoom Scan (7x7x7)/Cube 0: Measurement grid: dx=5mm, dy=5mm, dz=5mm

Reference Value = 8.247 V/m; Power Drift = 0.087 dB

Peak SAR (extrapolated) = 1.91 W/kg

SAR(1 g) = 0.878 W/kg; SAR(10 g) = 0.386 W/kg

Maximum value of SAR (measured) = 0.965 W/kg

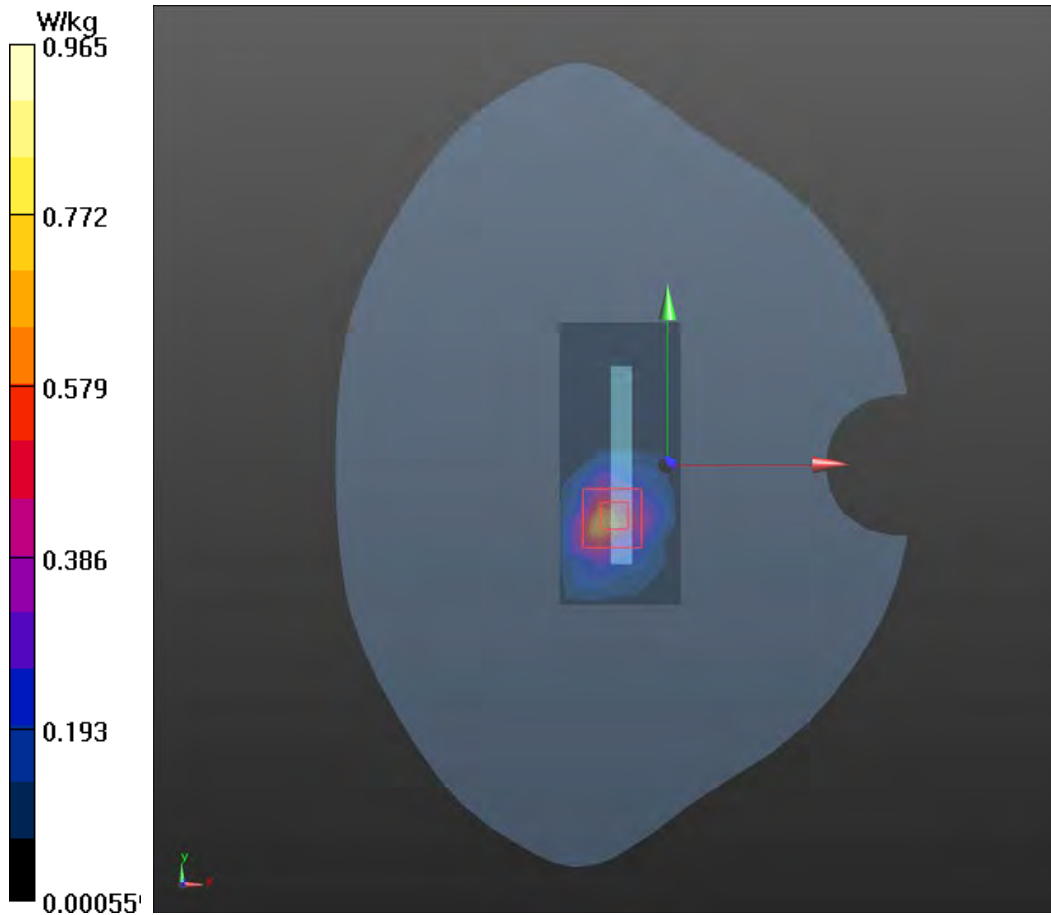

Plot 40 802.11b Back Side Low (Distance 10mm)

Date: 2022/6/28

Communication System: UID 0, 802.11b (0); Frequency: 2412 MHz;Duty Cycle: 1:1.02

Medium parameters used: $f = 2412$ MHz; $\sigma = 1.801$ S/m; $\epsilon_r = 37.737$; $\rho = 1000$ kg/m³

Ambient Temperature:22.3 °C Liquid Temperature: 21.5°C

Phantom section: Flat Section

DASY5 Configuration:

Sensor-Surface: 1.4mm (Mechanical Surface Detection)

Probe: EX3DV4 - SN3677; ConvF(7.50, 7.50, 7.50); Calibrated: 2021/8/12

Electronics: DAE4 SN1692; Calibrated: 2021/10/4

Phantom: SAM 2; Type: QD000P40CD; Serial: TP:1666

Measurement SW: DASY52, Version 52.10 (4); SEMCAD X Version 14.6.14 (7483)

Back Side Low/Area Scan (10x18x1): Measurement grid: dx=12mm, dy=12mm

Maximum value of SAR (measured) = 0.274 W/kg

Back Side Low/Zoom Scan (7x7x7)/Cube 0: Measurement grid: dx=5mm, dy=5mm, dz=5mm

Reference Value = 6.335 V/m; Power Drift = 0.011 dB

Peak SAR (extrapolated) = 0.511 W/kg

SAR(1 g) = 0.256 W/kg; SAR(10 g) = 0.125 W/kg

Maximum value of SAR (measured) = 0.287 W/kg

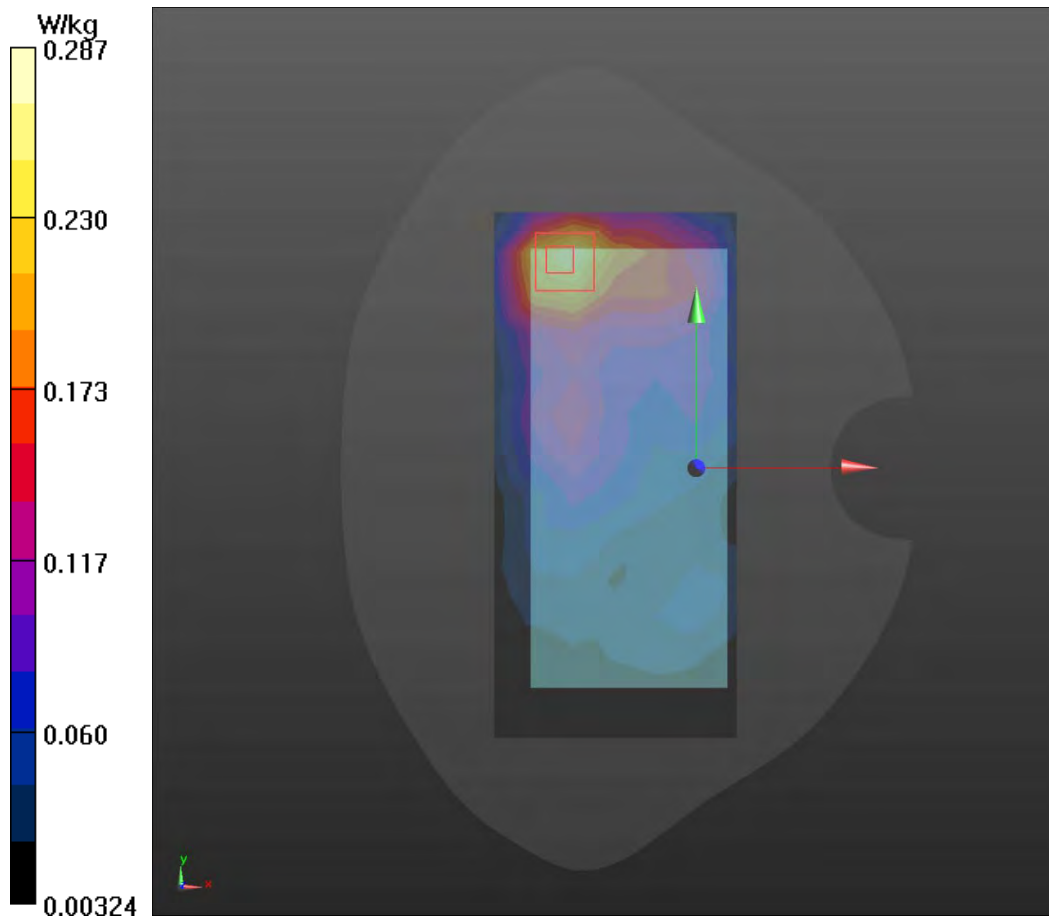

Plot 41 Bluetooth Back Side Low (Distance 10mm)

Date: 2022/6/28

Communication System: UID 0, BT (0); Frequency: 2402 MHz; Duty Cycle: 1:1.32

Medium parameters used: $f = 2402$ MHz; $\sigma = 1.789$ S/m; $\epsilon_r = 37.77$; $\rho = 1000$ kg/m³

Ambient Temperature: 22.3 °C Liquid Temperature: 21.5 °C

Phantom section: Flat Section

DASY5 Configuration:

Sensor-Surface: 1.4mm (Mechanical Surface Detection)

Probe: EX3DV4 - SN3677; ConvF(7.50, 7.50, 7.50); Calibrated: 2021/8/12

Electronics: DAE4 SN1692; Calibrated: 2021/10/4

Phantom: SAM 2; Type: QD000P40CD; Serial: TP:1666

Measurement SW: DASY52, Version 52.10 (4); SEMCAD X Version 14.6.14 (7483)

Back Side Low/Area Scan (10x18x1): Measurement grid: dx=12mm, dy=12mm

Maximum value of SAR (measured) = 0 W/kg

Back Side Low/Zoom Scan (7x7x7)/Cube 0: Measurement grid: dx=5mm, dy=5mm, dz=5mm

Reference Value = 1.539 V/m; Power Drift = -0.028 dB

Peak SAR (extrapolated) = 0 W/kg

SAR(1 g) = 0 W/kg; SAR(10 g) = 0 W/kg

Maximum value of SAR (measured) = 0 W/kg

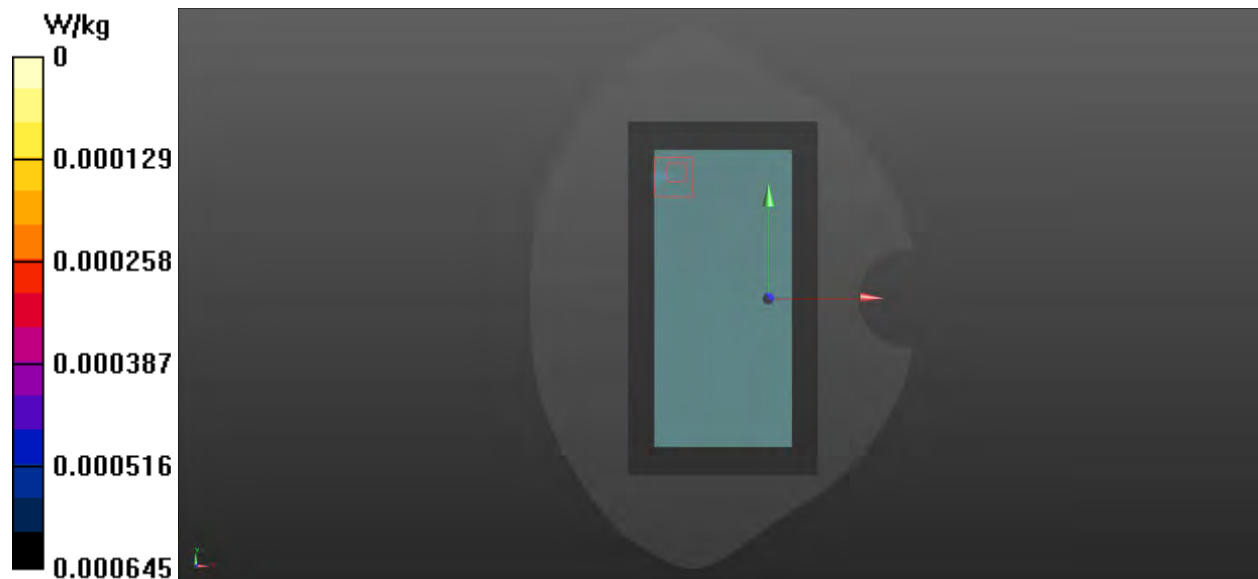

Plot 42 LTE Band 7 1RB Top Edge High (Distance 0mm)

Date: 2022/7/4

Communication System: UID 0, LTE (0); Frequency: 2560 MHz; Duty Cycle: 1:1

Medium parameters used: $f = 2560$ MHz; $\sigma = 1.971$ S/m; $\epsilon_r = 37.231$; $\rho = 1000$ kg/m³

Ambient Temperature: 22.3 °C Liquid Temperature: 21.5 °C

Phantom section: Flat Section

DASY5 Configuration:

Sensor-Surface: 1.4mm (Mechanical Surface Detection)

Probe: EX3DV4 - SN3677; ConvF(7.25, 7.25, 7.25); Calibrated: 2021/8/12

Electronics: DAE4 SN1692; Calibrated: 2021/10/4

Phantom: SAM 2; Type: QD000P40CD; Serial: TP:1666

Measurement SW: DASY52, Version 52.10 (4); SEMCAD X Version 14.6.14 (7483)

Top Edge High/Area Scan (5x10x1): Measurement grid: dx=12mm, dy=12mm

Maximum value of SAR (measured) = 3.73 W/kg

Top Edge High/Zoom Scan (7x7x7)/Cube 0: Measurement grid: dx=5mm, dy=5mm, dz=5mm

Reference Value = 17.58 V/m; Power Drift = 0.027 dB

Peak SAR (extrapolated) = 9.26 W/kg

SAR(1 g) = 3.09 W/kg; SAR(10 g) = 1.26 W/kg

Maximum value of SAR (measured) = 4.12 W/kg

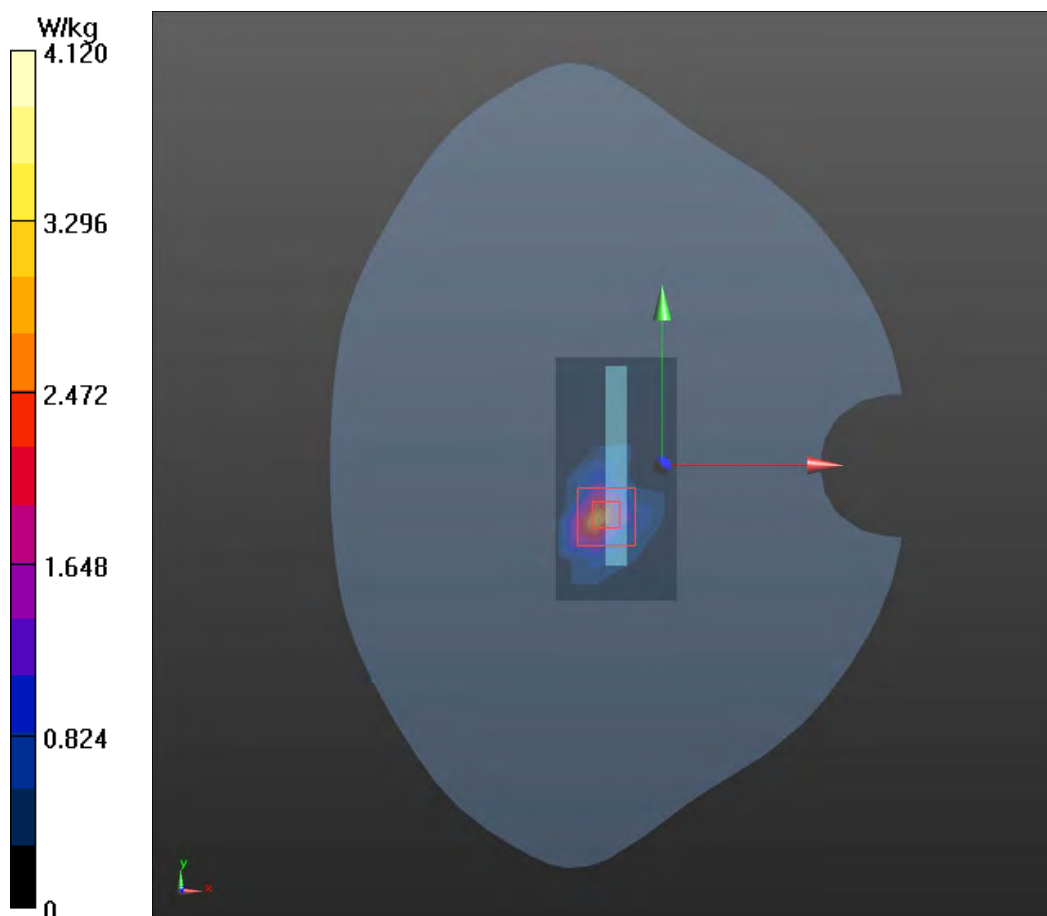

Plot 43 LTE Band 38 1RB Top Edge High (Distance 0mm)

Date: 2022/7/4

Communication System: UID 0, LTE (0); Frequency: 2610 MHz; Duty Cycle: 1:1.58

Medium parameters used: $f = 2610$ MHz; $\sigma = 2.027$ S/m; $\epsilon_r = 37.056$; $\rho = 1000$ kg/m³

Ambient Temperature: 22.3 °C Liquid Temperature: 21.5 °C

Phantom section: Flat Section

DASY5 Configuration:

Sensor-Surface: 1.4mm (Mechanical Surface Detection)

Probe: EX3DV4 - SN3677; ConvF(7.25, 7.25, 7.25); Calibrated: 2021/8/12

Electronics: DAE4 SN1692; Calibrated: 2021/10/4

Phantom: SAM 2; Type: QD000P40CD; Serial: TP:1666

Measurement SW: DASY52, Version 52.10 (4); SEMCAD X Version 14.6.14 (7483)

Top Edge High/Area Scan (5x10x1): Measurement grid: dx=12mm, dy=12mm

Maximum value of SAR (measured) = 3.25 W/kg

Top Edge High/Zoom Scan (7x7x7)/Cube 0: Measurement grid: dx=5mm, dy=5mm, dz=5mm

Reference Value = 17.30 V/m; Power Drift = 0.04 dB

Peak SAR (extrapolated) = 9.85 W/kg

SAR(1 g) = 3.5 W/kg; SAR(10 g) = 1.2 W/kg

Maximum value of SAR (measured) = 4.24 W/kg

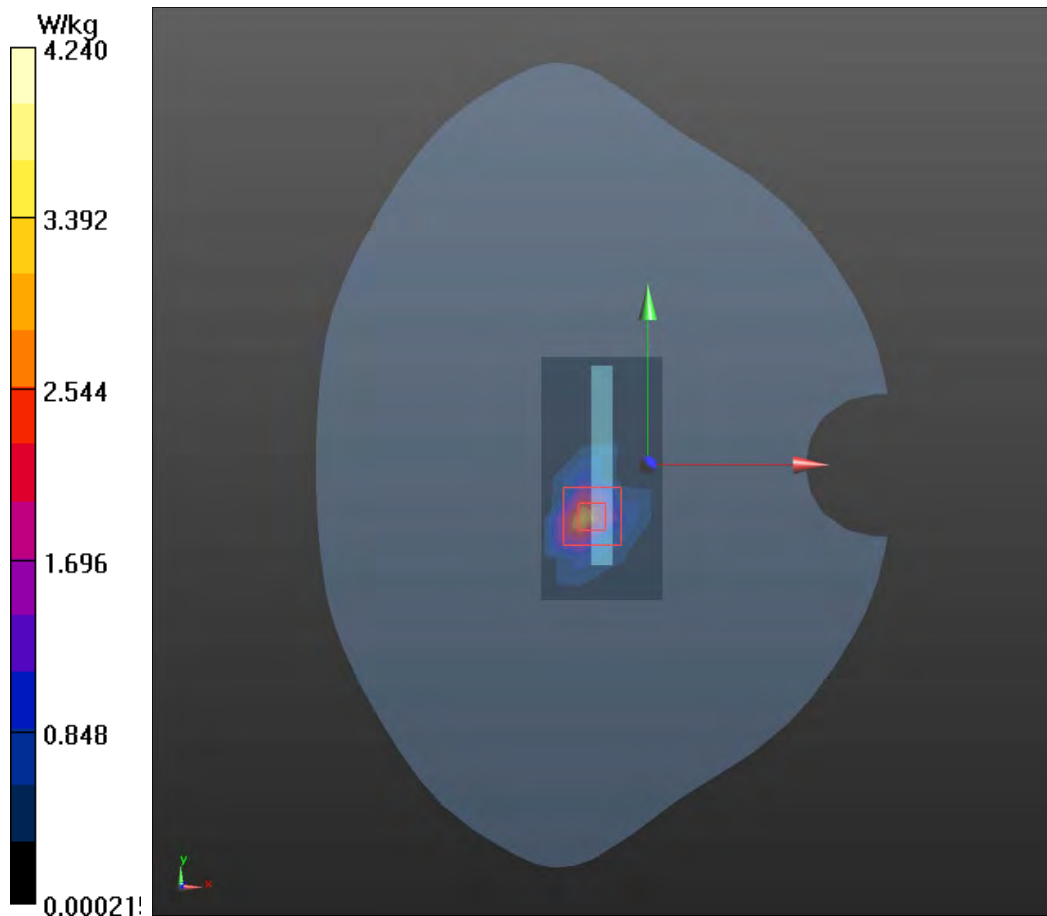

Plot 44 LTE Band 41 1RB Top Edge Middle (Distance 0mm)

Date: 2022/7/3

Communication System: UID 0, LTE (0); Frequency: 2593 MHz; Duty Cycle: 1:1.58

Medium parameters used: $f = 2593$ MHz; $\sigma = 2.063$ S/m; $\epsilon_r = 36.918$; $\rho = 1000$ kg/m³

Ambient Temperature: 22.3 °C Liquid Temperature: 21.5 °C

Phantom section: Flat Section

DASY5 Configuration:

Sensor-Surface: 1.4mm (Mechanical Surface Detection)

Probe: EX3DV4 - SN3677; ConvF(7.25, 7.25, 7.25); Calibrated: 2021/8/12

Electronics: DAE4 SN1692; Calibrated: 2021/10/4

Phantom: SAM 2; Type: QD000P40CD; Serial: TP:1666

Measurement SW: DASY52, Version 52.10 (4); SEMCAD X Version 14.6.14 (7483)

Top Edge Middle /Area Scan (5x10x1): Measurement grid: dx=12mm, dy=12mm

Maximum value of SAR (measured) = 3.82 W/kg

Top Edge Middle/Zoom Scan (7x7x7)/Cube 0: Measurement grid: dx=5mm, dy=5mm, dz=5mm

Reference Value = 15.57 V/m; Power Drift = 0.193 dB

Peak SAR (extrapolated) = 9.49 W/kg

SAR(1 g) = 3.72 W/kg; SAR(10 g) = 1.25 W/kg

Maximum value of SAR (measured) = 3.83 W/kg

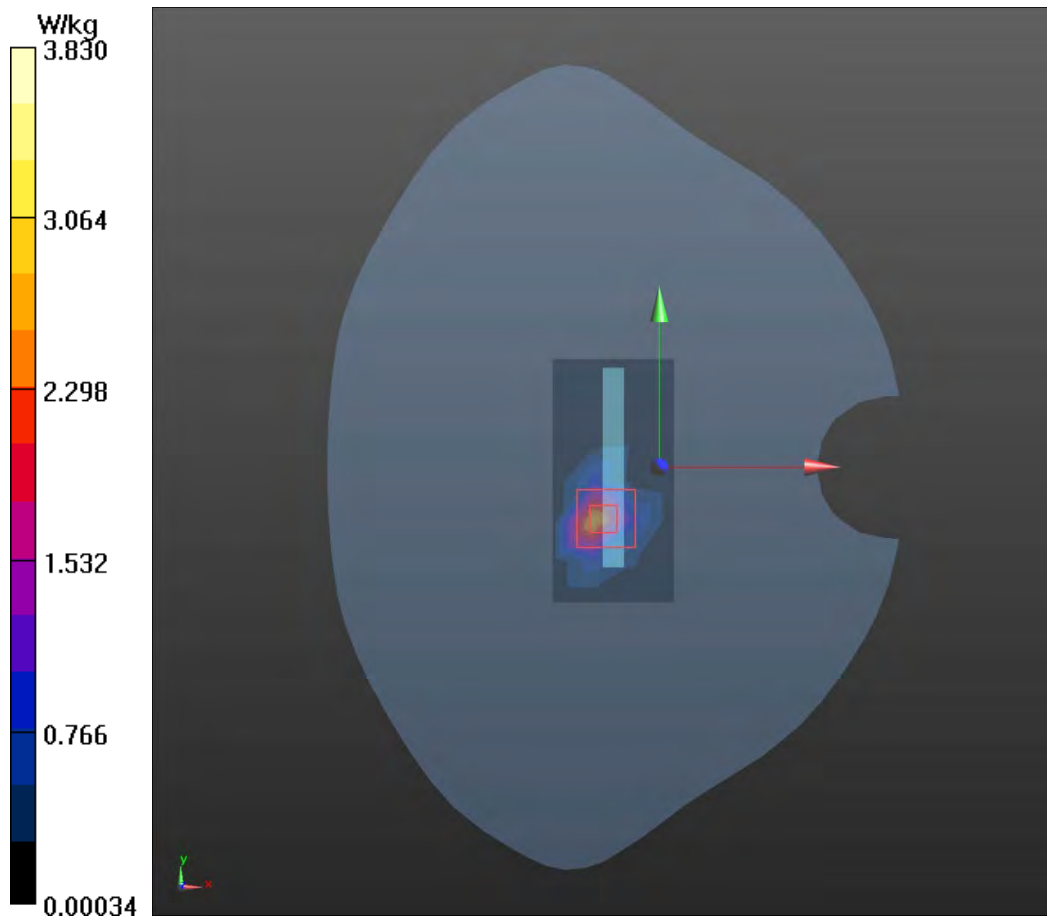

Plot 45 UMTS Band V Front Side Middle (Distance 10mm)

Date: 2022/6/25

Communication System: UID 0, WCDMA (0); Frequency: 836.6 MHz; Duty Cycle: 1:1

Medium parameters used: $f = 836.6$ MHz; $\sigma = 0.953$ S/m; $\epsilon_r = 39.762$; $\rho = 1000$ kg/m³

Ambient Temperature: 22.3 °C Liquid Temperature: 21.5 °C

Phantom section: Flat Section

DASY5 Configuration:

Sensor-Surface: 1.4mm (Mechanical Surface Detection)

Probe: EX3DV4 - SN3677; ConvF(9.30, 9.30, 9.30); Calibrated: 2021/8/12

Electronics: DAE4 SN1692; Calibrated: 2021/10/4

Phantom: SAM 2; Type: QD000P40CD; Serial: TP:1666

Measurement SW: DASY52, Version 52.10 (4); SEMCAD X Version 14.6.14 (7483)

Front Side Middle/Area Scan (8x14x1): Measurement grid: dx=15mm, dy=15mm
dx=10mm, dy=10mm

Maximum value of SAR (measured) = 0.201 W/kg

Front Side Middle/Zoom Scan (5x5x7)/Cube 0: Measurement grid: dx=8mm, dy=8mm, dz=5mm

Reference Value = 5.884 V/m; Power Drift = 0.09 dB

Peak SAR (extrapolated) = 0.326 W/kg

SAR(1 g) = 0.198 W/kg; SAR(10 g) = 0.130 W/kg

Maximum value of SAR (measured) = 0.256 W/kg

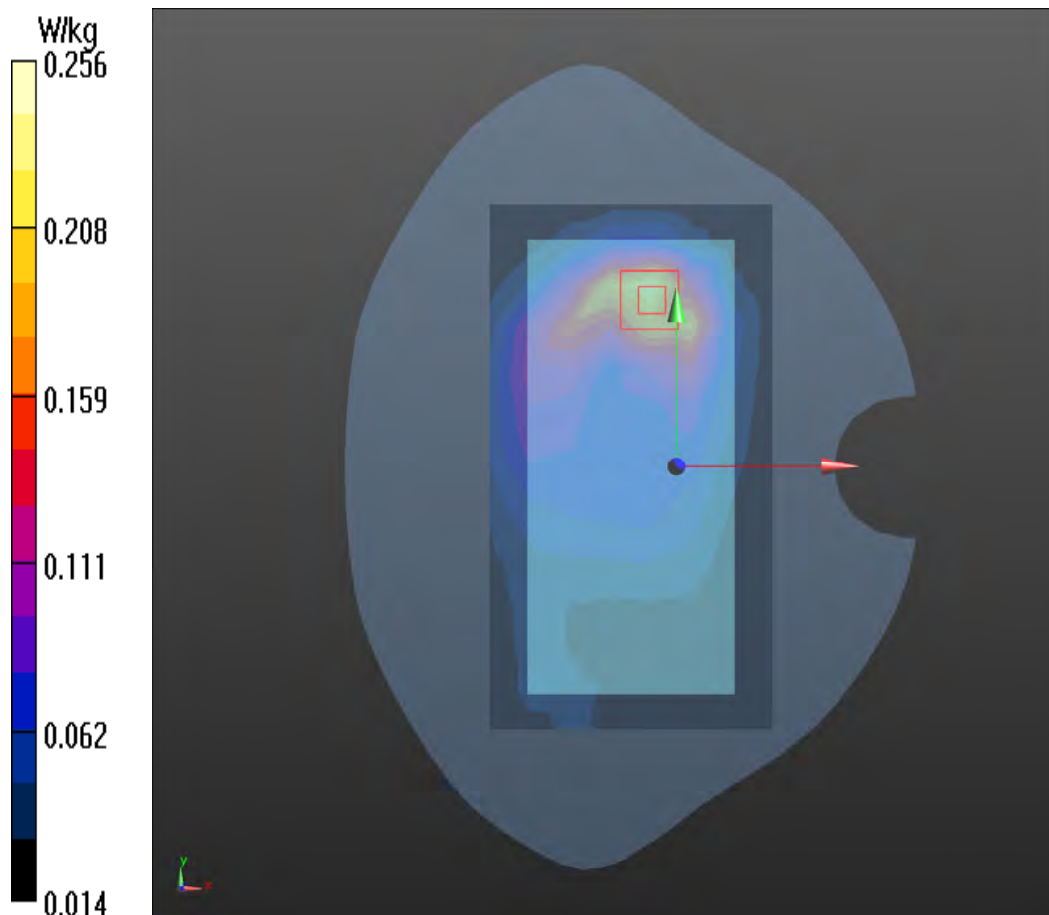

Plot 46 LTE Band 5 1RB Front Side High (Distance 10mm)

Date: 2022/6/25

Communication System: UID 0, LTE (0); Frequency: 844 MHz; Duty Cycle: 1:1

Medium parameters used: $f = 844$ MHz; $\sigma = 0.958$ S/m; $\epsilon_r = 39.728$; $\rho = 1000$ kg/m³

Ambient Temperature: 22.3 °C Liquid Temperature: 21.5 °C

Phantom section: Flat Section

DASY5 Configuration:

Sensor-Surface: 1.4mm (Mechanical Surface Detection)

Probe: EX3DV4 - SN3677; ConvF(9.30, 9.30, 9.30); Calibrated: 2021/8/12

Electronics: DAE4 SN1692; Calibrated: 2021/10/4

Phantom: SAM 2; Type: QD000P40CD; Serial: TP:1666

Measurement SW: DASY52, Version 52.10 (4); SEMCAD X Version 14.6.14 (7483)

Front Side High/Area Scan (8x14x1): Measurement grid: dx=15mm, dy=15mm

Maximum value of SAR (measured) = 0.615 W/kg

Front Side High/Zoom Scan (5x5x7)/Cube 0: Measurement grid: dx=8mm, dy=8mm, dz=5mm

Reference Value = 16.25 V/m; Power Drift = -0.101 dB

Peak SAR (extrapolated) = 0.969 W/kg

SAR(1 g) = 0.471 W/kg; SAR(10 g) = 0.245 W/kg

Maximum value of SAR (measured) = 0.631 W/kg

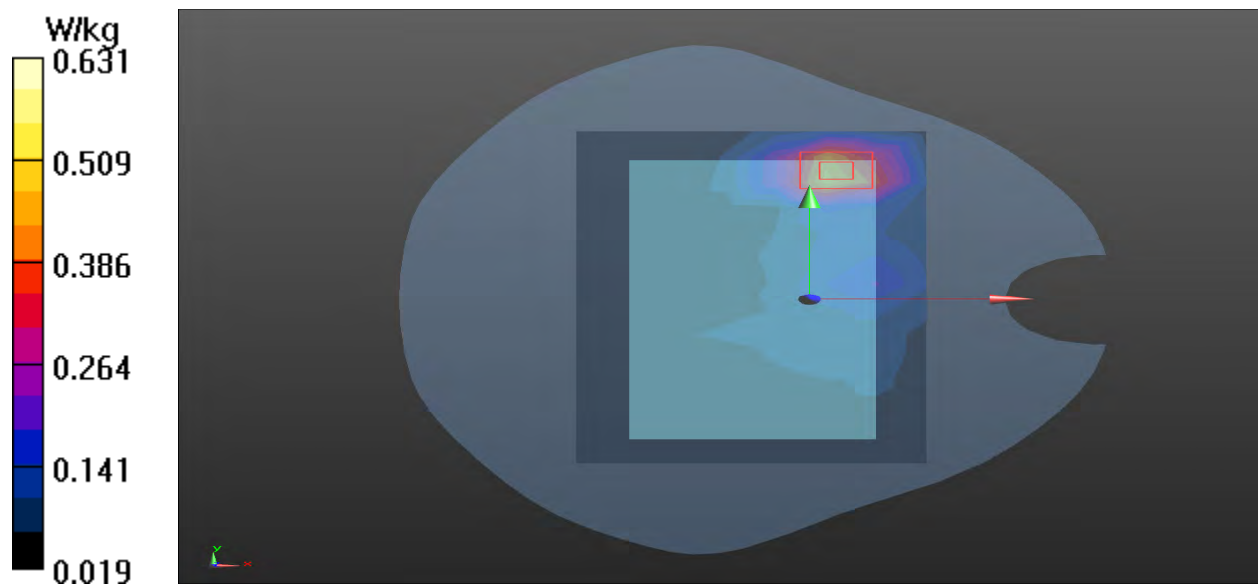

Plot 47 LTE Band 38 1RB Front Side High (Distance 10mm)

Date: 2022/7/1

Communication System: UID 0, LTE (0); Frequency: 2610 MHz; Duty Cycle: 1:1.58

Medium parameters used: $f = 2610$ MHz; $\sigma = 2.027$ S/m; $\epsilon_r = 37.056$; $\rho = 1000$ kg/m³

Ambient Temperature: 22.3 °C Liquid Temperature: 21.5 °C

Phantom section: Flat Section

DASY5 Configuration:

Sensor-Surface: 1.4mm (Mechanical Surface Detection)

Probe: EX3DV4 - SN3677; ConvF(7.25, 7.25, 7.25); Calibrated: 2021/8/12

Electronics: DAE4 SN1692; Calibrated: 2021/10/4

Phantom: SAM 2; Type: QD000P40CD; Serial: TP:1666

Measurement SW: DASY52, Version 52.10 (4); SEMCAD X Version 14.6.14 (7483)

Front Side High/Area Scan (10x18x1): Measurement grid: dx=12mm, dy=12mm

Maximum value of SAR (measured) = 0.493 W/kg

Front Side High/Zoom Scan (7x7x7)/Cube 0: Measurement grid: dx=5mm, dy=5mm, dz=5mm

Reference Value = 3.045 V/m; Power Drift = 0.11 dB

Peak SAR (extrapolated) = 1.12 W/kg

SAR(1 g) = 0.490 W/kg; SAR(10 g) = 0.243 W/kg

Maximum value of SAR (measured) = 0.661 W/kg

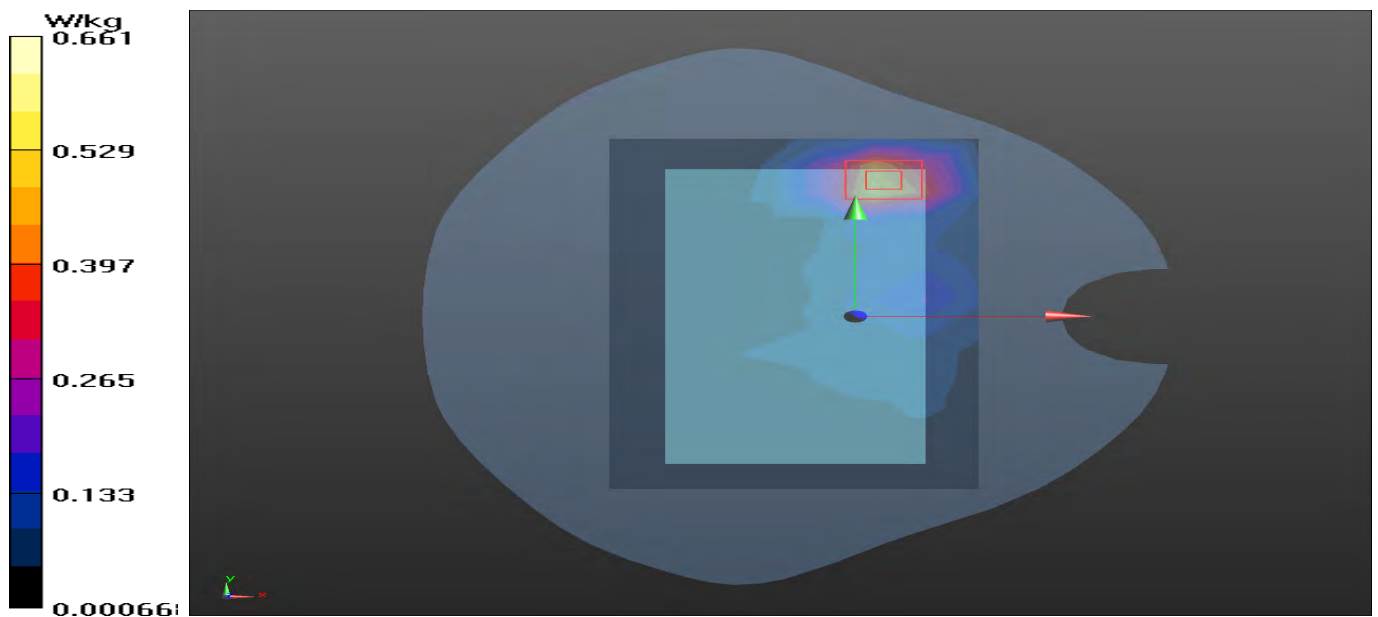

Plot 48 LTE Band 41 1RB Front Side Middle (Distance 10mm)

Date: 2022/7/1

Communication System: UID 0, LTE (0); Frequency: 2593MHz; Duty Cycle: 1:1.58

Medium parameters used: $f = 2593\text{MHz}$; $\sigma = 2.063\text{ S/m}$; $\epsilon_r = 36.918$; $\rho = 1000\text{ kg/m}^3$

Ambient Temperature: $22.3\text{ }^\circ\text{C}$ Liquid Temperature: $21.5\text{ }^\circ\text{C}$

Phantom section: Flat Section

DASY5 Configuration:

Sensor-Surface: 1.4mm (Mechanical Surface Detection)

Probe: EX3DV4 - SN3677; ConvF(7.25, 7.25, 7.25); Calibrated: 2021/8/12

Electronics: DAE4 SN1692; Calibrated: 2021/10/4

Phantom: SAM 2; Type: QD000P40CD; Serial: TP:1666

Measurement SW: DASY52, Version 52.10 (4); SEMCAD X Version 14.6.14 (7483)

Front Side Middle/Area Scan (10x18x1): Measurement grid: $dx=12\text{mm}$, $dy=12\text{mm}$

Maximum value of SAR (measured) = 0.505 W/kg

Front Side Middle/Zoom Scan (7x7x7)/Cube 0: Measurement grid: $dx=5\text{mm}$, $dy=5\text{mm}$, $dz=5\text{mm}$

Reference Value = 2.360 V/m ; Power Drift = 0.06 dB

Peak SAR (extrapolated) = 1.46 W/kg

SAR(1 g) = 0.497 W/kg ; SAR(10 g) = 0.245 W/kg

Maximum value of SAR (measured) = 0.510 W/kg

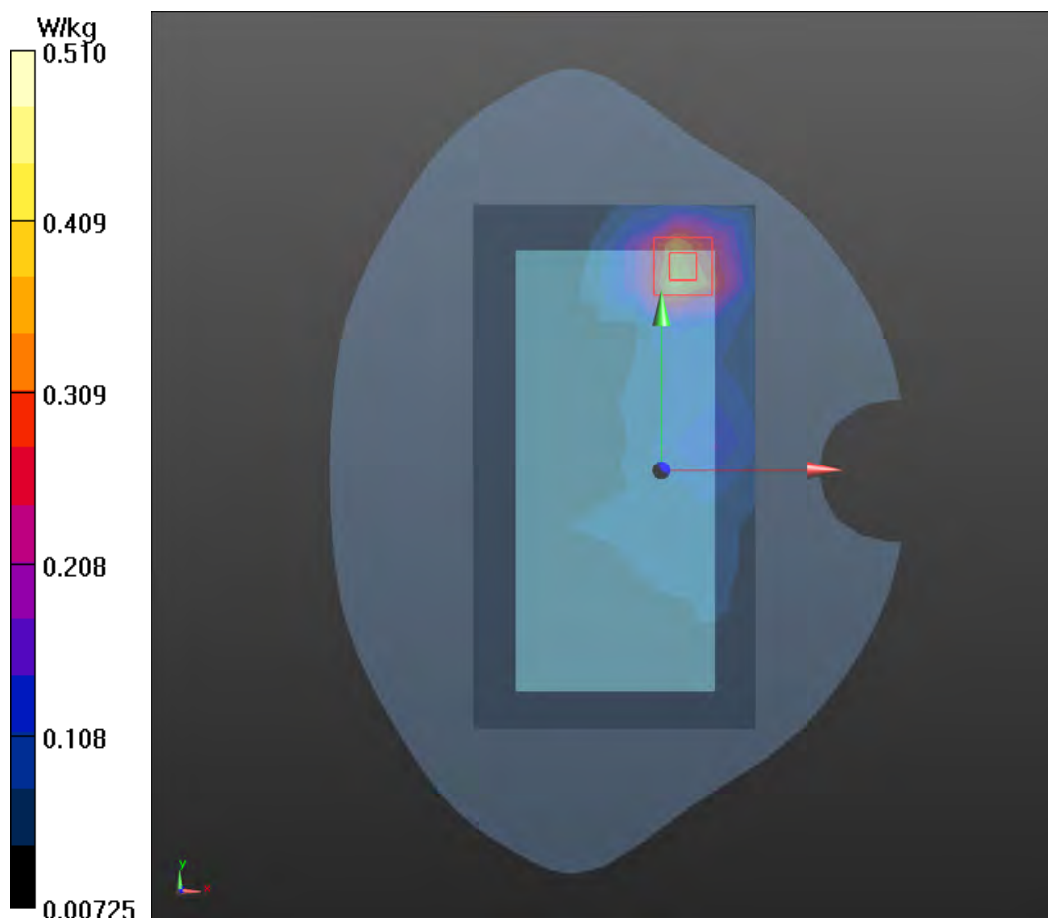



ANNEX D: Probe Calibration Certificate (SN: 3677)



In Collaboration with
s p e a g
CALIBRATION LABORATORY



中国认可
国际互认
校准
CALIBRATION
CNAS L0570

Add: No.52 HuaYuanBei Road, Haidian District, Beijing, 100191, China
Tel: +86-10-62304633-2512 Fax: +86-10-62304633-2504
E-mail: cttl@chinattl.com Http://www.chinattl.cn

Client TA(Shanghai)

Certificate No: Z21-60285

CALIBRATION CERTIFICATE

Object EX3DV4 - SN : 3677

Calibration Procedure(s)
FF-Z11-004-02
Calibration Procedures for Dosimetric E-field Probes

Calibration date: August 12, 2021

This calibration Certificate documents the traceability to national standards, which realize the physical units of measurements(SI). The measurements and the uncertainties with confidence probability are given on the following pages and are part of the certificate.

All calibrations have been conducted in the closed laboratory facility: environment temperature(22±3)°C and humidity<70%.

Calibration Equipment used (M&TE critical for calibration)

Primary Standards	ID #	Cal Date(Calibrated by, Certificate No.)	Scheduled Calibration
Power Meter NRP2	101919	15-Jun-21(CTTL, No.J21X04466)	Jun-22
Power sensor NRP-Z91	101547	15-Jun-21(CTTL, No.J21X04466)	Jun-22
Power sensor NRP-Z91	101548	15-Jun-21(CTTL, No.J21X04466)	Jun-22
Reference 10dBAttenuator	18N50W-10dB	10-Feb-20(CTTL, No.J20X00525)	Feb-22
Reference 20dBAttenuator	18N50W-20dB	10-Feb-20(CTTL, No.J20X00526)	Feb-22
Reference Probe EX3DV4	SN 3617	27-Jan-21(SPEAG, No.EX3-3617_Jan21)	Jan-22
DAE4	SN 1556	15-Jan-21(SPEAG, No.DAE4-1556_Jan21)	Jan-22
Secondary Standards	ID #	Cal Date(Calibrated by, Certificate No.)	Scheduled Calibration
SignalGenerator MG3700A	6201052605	16-Jun-21(CTTL, No.J21X04467)	Jun-22
Network Analyzer E5071C	MY46110673	21-Jan-21(CTTL, No.J20X00515)	Jan-22

	Name	Function	Signature
Calibrated by:	Yu Zongying	SAR Test Engineer	
Reviewed by:	Lin Hao	SAR Test Engineer	
Approved by:	Qi Dianyuan	SAR Project Leader	

Issued: August 14, 2021

This calibration certificate shall not be reproduced except in full without written approval of the laboratory.



In Collaboration with
s p e a g
CALIBRATION LABORATORY

Add: No.52 HuaYuanBei Road, Haidian District, Beijing, 100191, China
 Tel: +86-10-62304633-2512 Fax: +86-10-62304633-2504
 E-mail: cttl@chinattl.com [Http://www.chinattl.cn](http://www.chinattl.cn)

Glossary:

TSL	tissue simulating liquid
NORM _{x,y,z}	sensitivity in free space
ConvF	sensitivity in TSL / NORM _{x,y,z}
DCP	diode compression point
CF	crest factor (1/duty_cycle) of the RF signal
A,B,C,D	modulation dependent linearization parameters
Polarization Φ	Φ rotation around probe axis
Polarization θ	θ rotation around an axis that is in the plane normal to probe axis (at measurement center), i $\theta=0$ is normal to probe axis

Connector Angle information used in DASY system to align probe sensor X to the robot coordinate system

Calibration is Performed According to the Following Standards:

- a) IEEE Std 1528-2013, "IEEE Recommended Practice for Determining the Peak Spatial-Averaged Specific Absorption Rate (SAR) in the Human Head from Wireless Communications Devices: Measurement Techniques", June 2013
- b) IEC 62209-1, "Measurement procedure for the assessment of Specific Absorption Rate (SAR) from hand-held and body-mounted devices used next to the ear (frequency range of 300 MHz to 6 GHz)", July 2016
- c) IEC 62209-2, "Procedure to determine the Specific Absorption Rate (SAR) for wireless communication devices used in close proximity to the human body (frequency range of 30 MHz to 6 GHz)", March 2010
- d) KDB 865664, "SAR Measurement Requirements for 100 MHz to 6 GHz"

Methods Applied and Interpretation of Parameters:

- **NORM_{x,y,z}:** Assessed for E-field polarization $\theta=0$ ($f \leq 900\text{MHz}$ in TEM-cell; $f > 1800\text{MHz}$: waveguide). NORM_{x,y,z} are only intermediate values, i.e., the uncertainties of NORM_{x,y,z} does not effect the E^2 -field uncertainty inside TSL (see below ConvF).
- **NORM(f)_{x,y,z} = NORM_{x,y,z}* frequency_response** (see Frequency Response Chart). This linearization is implemented in DASY4 software versions later than 4.2. The uncertainty of the frequency response is included in the stated uncertainty of ConvF.
- **DCP_{x,y,z}:** DCP are numerical linearization parameters assessed based on the data of power sweep (no uncertainty required). DCP does not depend on frequency nor media.
- **PAR:** PAR is the Peak to Average Ratio that is not calibrated but determined based on the signal characteristics.
- **A_{x,y,z}; B_{x,y,z}; C_{x,y,z}; VR_{x,y,z}:** A,B,C are numerical linearization parameters assessed based on the data of power sweep for specific modulation signal. The parameters do not depend on frequency nor media. VR is the maximum calibration range expressed in RMS voltage across the diode.
- **ConvF and Boundary Effect Parameters:** Assessed in flat phantom using E-field (or Temperature Transfer Standard for $f \leq 800\text{MHz}$) and inside waveguide using analytical field distributions based on power measurements for $f > 800\text{MHz}$. The same setups are used for assessment of the parameters applied for boundary compensation (alpha, depth) of which typical uncertainty valued are given. These parameters are used in DASY4 software to improve probe accuracy close to the boundary. The sensitivity in TSL corresponds to NORM_{x,y,z}* ConvF whereby the uncertainty corresponds to that given for ConvF. A frequency dependent ConvF is used in DASY version 4.4 and higher which allows extending the validity from $\pm 50\text{MHz}$ to $\pm 100\text{MHz}$.
- **Spherical isotropy (3D deviation from isotropy):** In a field of low gradients realized using a flat phantom exposed by a patch antenna.
- **Sensor Offset:** The sensor offset corresponds to the offset of virtual measurement center from the probe tip (on probe axis). No tolerance required.
- **Connector Angle:** The angle is assessed using the information gained by determining the NORM_x (no uncertainty required).



Add: No.52 HuaYuanBei Road, Haidian District, Beijing, 100191, China
 Tel: +86-10-62304633-2512 Fax: +86-10-62304633-2504
 E-mail: cttl@chinattl.com Http://www.chinattl.cn

DASY/EASY – Parameters of Probe: EX3DV4 – SN:3677

Basic Calibration Parameters

	Sensor X	Sensor Y	Sensor Z	Unc (k=2)
Norm($\mu\text{V}/(\text{V}/\text{m})^2$) ^A	0.41	0.46	0.40	±10.0%
DCP(mV) ^B	99.3	101.9	101.5	

Modulation Calibration Parameters

UID	Communication System Name		A dB	B dB $\sqrt{\mu\text{V}}$	C	D dB	VR mV	Unc ^E (k=2)
0	CW	X	0.0	0.0	1.0	0.00	158.2	±2.0%
		Y	0.0	0.0	1.0		170.4	
		Z	0.0	0.0	1.0		156.9	

The reported uncertainty of measurement is stated as the standard uncertainty of Measurement multiplied by the coverage factor $k=2$, which for a normal distribution Corresponds to a coverage probability of approximately 95%.

^A The uncertainties of Norm X, Y, Z do not affect the E²-field uncertainty inside TSL (see Page 4).

^B Numerical linearization parameter: uncertainty not required.

^E Uncertainty is determined using the max. deviation from linear response applying rectangular distribution and is expressed for the square of the field value.



Add: No.52 HuaYuanBei Road, Haidian District, Beijing, 100191, China
Tel: +86-10-62304633-2512 Fax: +86-10-62304633-2504
E-mail: cttl@chinattl.com Http://www.chinattl.cn

DASY/EASY – Parameters of Probe: EX3DV4 – SN:3677

Calibration Parameter Determined in Head Tissue Simulating Media

f [MHz] ^C	Relative Permittivity ^F	Conductivity (S/m) ^F	ConvF X	ConvF Y	ConvF Z	Alpha ^G	Depth ^G (mm)	Unct. (k=2)
750	41.9	0.89	9.64	9.64	9.64	0.40	0.80	±12.1%
835	41.5	0.90	9.30	9.30	9.30	0.16	1.29	±12.1%
1750	40.1	1.37	8.22	8.22	8.22	0.24	1.00	±12.1%
1900	40.0	1.40	7.88	7.88	7.88	0.24	1.10	±12.1%
2000	40.0	1.40	7.96	7.96	7.96	0.21	1.17	±12.1%
2300	39.5	1.67	7.67	7.67	7.67	0.66	0.68	±12.1%
2450	39.2	1.80	7.50	7.50	7.50	0.66	0.70	±12.1%
2600	39.0	1.96	7.25	7.25	7.25	0.62	0.73	±12.1%
3300	38.2	2.71	7.00	7.00	7.00	0.45	0.94	±13.3%
3500	37.9	2.91	6.92	6.92	6.92	0.45	0.98	±13.3%
3700	37.7	3.12	6.71	6.71	6.71	0.45	1.04	±13.3%
3900	37.5	3.32	6.62	6.62	6.62	0.40	1.25	±13.3%
4100	37.2	3.53	6.66	6.66	6.66	0.30	1.38	±13.3%
4400	36.9	3.84	6.43	6.43	6.43	0.35	1.35	±13.3%
4600	36.7	4.04	6.35	6.35	6.35	0.50	1.13	±13.3%
4800	36.4	4.25	6.30	6.30	6.30	0.45	1.25	±13.3%
4950	36.3	4.40	6.13	6.13	6.13	0.45	1.25	±13.3%
5250	35.9	4.71	5.45	5.45	5.45	0.50	1.30	±13.3%
5600	35.5	5.07	5.00	5.00	5.00	0.60	1.15	±13.3%
5750	35.4	5.22	5.04	5.04	5.04	0.55	1.26	±13.3%

^C Frequency validity above 300 MHz of ±100MHz only applies for DASY v4.4 and higher (Page 2), else it is restricted to ±50MHz. The uncertainty is the RSS of ConvF uncertainty at calibration frequency and the uncertainty for the indicated frequency band. Frequency validity below 300 MHz is ± 10, 25, 40, 50 and 70 MHz for ConvF assessments at 30, 64, 128, 150 and 220 MHz respectively. Above 5 GHz frequency validity can be extended to ± 110 MHz.

^F At frequency below 3 GHz, the validity of tissue parameters (ϵ and σ) can be relaxed to ±10% if liquid compensation formula is applied to measured SAR values. At frequencies above 3 GHz, the validity of tissue parameters (ϵ and σ) is restricted to ±5%. The uncertainty is the RSS of the ConvF uncertainty for indicated target tissue parameters.

^G Alpha/Depth are determined during calibration. SPEAG warrants that the remaining deviation due to the boundary effect after compensation is always less than ± 1% for frequencies below 3 GHz and below ± 2% for the frequencies between 3-6 GHz at any distance larger than half the probe tip diameter from the boundary.

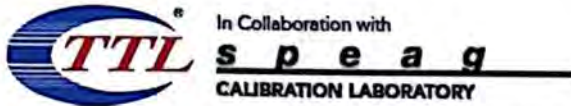

Add: No.52 HuaYuanBei Road, Haidian District, Beijing, 100191, China
Tel: +86-10-62304633-2512 Fax: +86-10-62304633-2504
E-mail: cttl@chinattl.com [Http://www.chinattl.cn](http://www.chinattl.cn)

Frequency Response of E-Field (TEM-Cell: ifi110 EXX, Waveguide: R22)

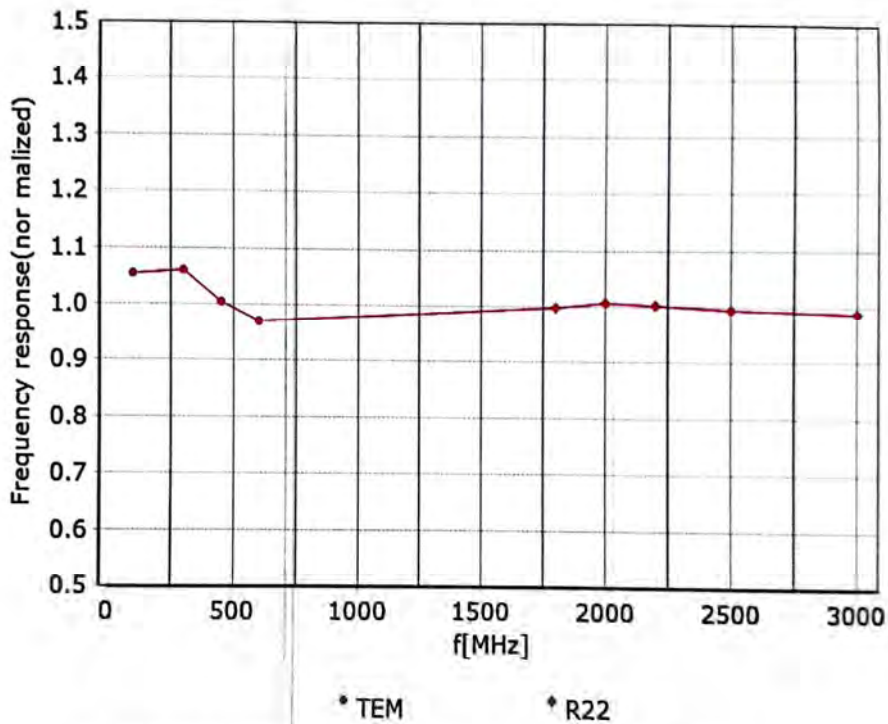

Uncertainty of Frequency Response of E-field: $\pm 7.4\%$ ($k=2$)

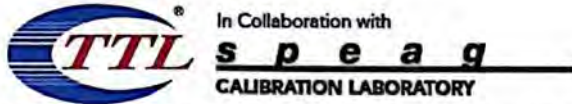

Add: No.52 HuaYuanBei Road, Haidian District, Beijing, 100191, China
 Tel: +86-10-62304633-2512 Fax: +86-10-62304633-2504
 E-mail: cttl@chinattl.com [Http://www.chinattl.cn](http://www.chinattl.cn)

Receiving Pattern (Φ), $\theta=0^\circ$

f=600 MHz, TEM

f=1800 MHz, R22

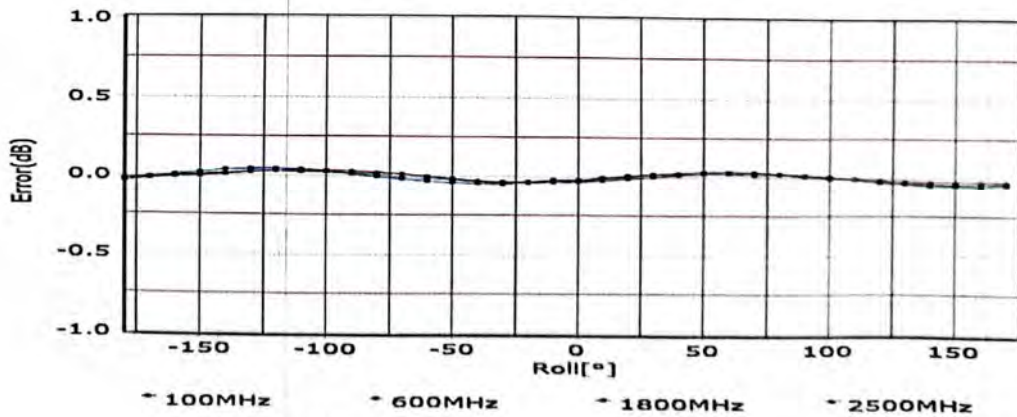
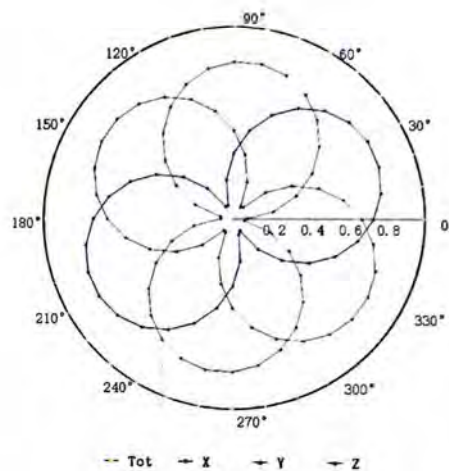
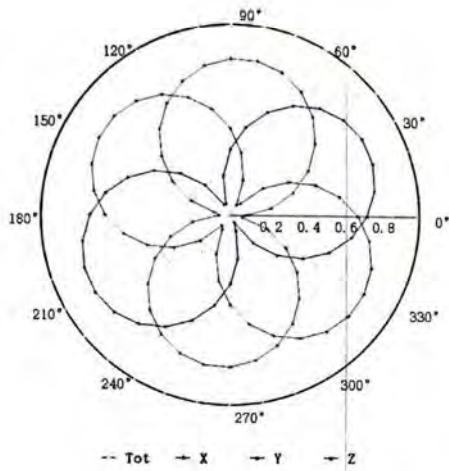

Uncertainty of Axial Isotropy Assessment: $\pm 1.2\%$ ($k=2$)

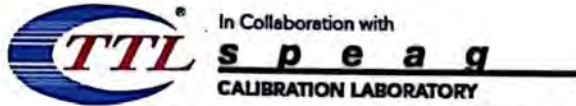

Add: No.52 HuaYuanBei Road, Haidian District, Beijing, 100191, China
 Tel: +86-10-62304633-2512 Fax: +86-10-62304633-2504
 E-mail: cttl@chinattl.com Http://www.chinattl.cn

Dynamic Range f(SAR_{head}) (TEM cell, f = 900 MHz)

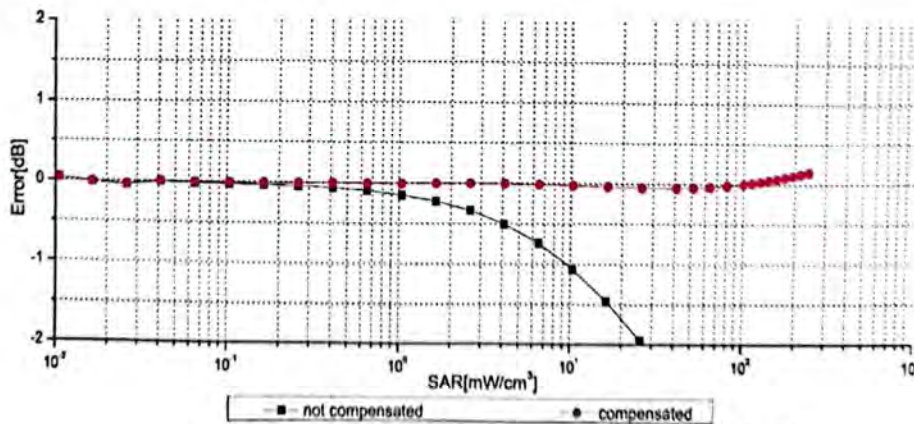
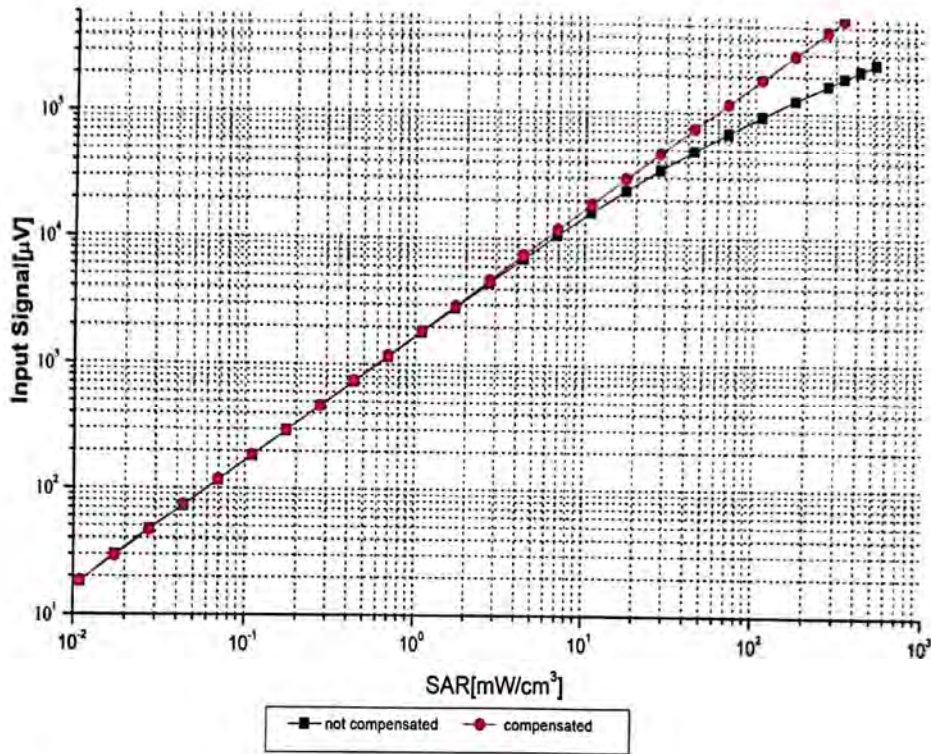

Uncertainty of Linearity Assessment: ±0.9% (k=2)

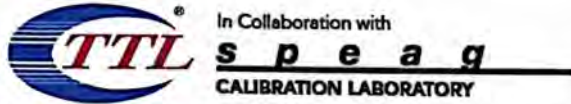

Add: No.52 HuaYuanBei Road, Haidian District, Beijing, 100191, China
 Tel: +86-10-62304633-2512 Fax: +86-10-62304633-2504
 E-mail: cttl@chinattl.com Http://www.chinattl.cn

Conversion Factor Assessment

f=750 MHz,WGLS R9(H_convF)

f=1750 MHz,WGLS R22(H_convF)

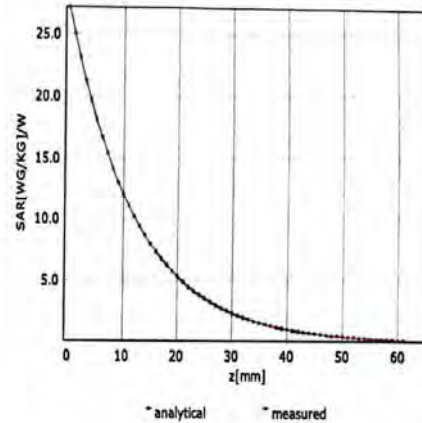
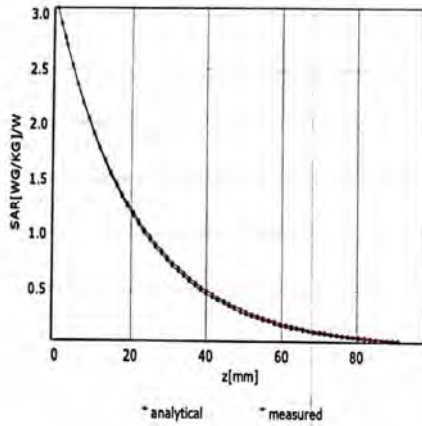

Deviation from Isotropy in Liquid

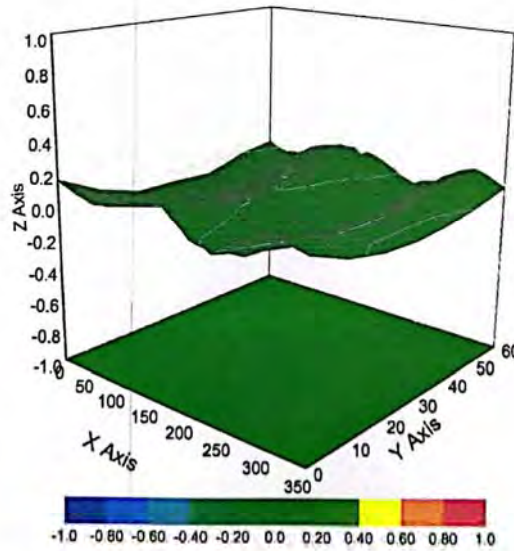

Uncertainty of Spherical Isotropy Assessment: $\pm 3.2\%$ ($k=2$)



Add: No.52 HuaYuanBei Road, Haidian District, Beijing, 100191, China
 Tel: +86-10-62304633-2512 Fax: +86-10-62304633-2504
 E-mail: cttl@chinattl.com <http://www.chinattl.cn>

DASY/EASY – Parameters of Probe: EX3DV4 – SN:3677

Other Probe Parameters

Sensor Arrangement	Triangular
Connector Angle (°)	117.4
Mechanical Surface Detection Mode	enabled
Optical Surface Detection Mode	disable
Probe Overall Length	337mm
Probe Body Diameter	10mm
Tip Length	9mm
Tip Diameter	2.5mm
Probe Tip to Sensor X Calibration Point	1mm
Probe Tip to Sensor Y Calibration Point	1mm
Probe Tip to Sensor Z Calibration Point	1mm
Recommended Measurement Distance from Surface	1.4mm



ANNEX E: Probe Calibration Certificate (SN: 7543)



In Collaboration with
s p e a g
CALIBRATION LABORATORY

Add: No 52 HuaYuanBei Road, Haidian District, Beijing, 100191, China
Tel: +86-10-62304633-2512 Fax: +86-10-62304633-2504
E-mail: cttl@chinattl.com Http: www.chinattl.cn



中国认可
国际互认
校准
CALIBRATION
CNAS L0570

Client **TA(Shanghai)**Certificate No: **Z21-60417****CALIBRATION CERTIFICATE**Object **EX3DV4 - SN : 7543**

Calibration Procedure(s) **FF-Z11-004-02**
Calibration Procedures for Dosimetric E-field Probes

Calibration date: **December 28, 2021**

This calibration Certificate documents the traceability to national standards, which realize the physical units of measurements(SI). The measurements and the uncertainties with confidence probability are given on the following pages and are part of the certificate.

All calibrations have been conducted in the closed laboratory facility: environment temperature(22±3)°C and humidity<70%.

Calibration Equipment used (M&TE critical for calibration)

Primary Standards	ID #	Cal Date(Calibrated by, Certificate No.)	Scheduled Calibration
Power Meter NRP2	101919	15-Jun-21(CTTL, No.J21X04466)	Jun-22
Power sensor NRP-Z91	101547	15-Jun-21(CTTL, No.J21X04466)	Jun-22
Power sensor NRP-Z91	101548	15-Jun-21(CTTL, No.J21X04466)	Jun-22
Reference 10dBAttenuator	18N50W-10dB	10-Feb-20(CTTL, No.J20X00525)	Feb-22
Reference 20dBAttenuator	18N50W-20dB	10-Feb-20(CTTL, No.J20X00526)	Feb-22
Reference Probe EX3DV4	SN 3617	27-Jan-21(SPEAG, No.EX3-3617_Jan21)	Jan-22
DAE4	SN 1555	20-Aug-21(SPEAG, No.DAE4-1555_Aug21/2)	Aug-22
Secondary Standards	ID #	Cal Date(Calibrated by, Certificate No.)	Scheduled Calibration
SignalGenerator MG3700A	6201052605	16-Jun-21(CTTL, No.J21X04467)	Jun-22
Network Analyzer E5071C	MY46110673	21-Jan-21(CTTL, No.J20X00515)	Jan-22

Calibrated by:	Name	Function	Signature
	Yu Zongying	SAR Test Engineer	
Reviewed by:	Lin Hao	SAR Test Engineer	
Approved by:	Qi Dianyuan	SAR Project Leader	

This calibration certificate shall not be reproduced except in full without written approval of the laboratory.

Issued: December 30, 2021

Certificate No: Z21-60417

Page 1 of 9

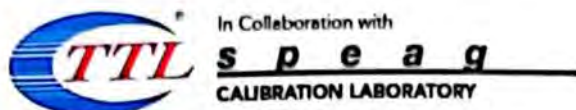

Add: No 52 HuaYuanBei Road, Haidian District, Beijing, 100191, China
 Tel: +86-10-62304633-2512 Fax: +86-10-62304633-2504
 E-mail: ctl@chinatl.com <http://www.chinatl.cn>

Glossary:

TSL	tissue simulating liquid
NORM _{x,y,z}	sensitivity in free space
ConvF	sensitivity in TSL / NORM _{x,y,z}
DCP	diode compression point
CF	crest factor (1/duty_cycle) of the RF signal
A,B,C,D	modulation dependent linearization parameters
Polarization Φ	Φ rotation around probe axis
Polarization θ	θ rotation around an axis that is in the plane normal to probe axis (at measurement center). $\theta=0$ is normal to probe axis
Connector Angle	information used in DASY system to align probe sensor X to the robot coordinate system

Calibration is Performed According to the Following Standards:

- a) IEEE Std 1528-2013, "IEEE Recommended Practice for Determining the Peak Spatial-Averaged Specific Absorption Rate (SAR) in the Human Head from Wireless Communications Devices Measurement Techniques", June 2013
- b) IEC 62209-1, "Measurement procedure for the assessment of Specific Absorption Rate (SAR) from hand-held and body-mounted devices used next to the ear (frequency range of 300 MHz to 6 GHz)", July 2016
- c) IEC 62209-2, "Procedure to determine the Specific Absorption Rate (SAR) for wireless communication devices used in close proximity to the human body (frequency range of 30 MHz to 6 GHz)", March 2010
- d) KDB 865664, "SAR Measurement Requirements for 100 MHz to 6 GHz"

Methods Applied and Interpretation of Parameters:

- **NORM_{x,y,z}:** Assessed for E-field polarization $\theta=0$ (fs900MHz in TEM-cell; f>1800MHz: waveguide). NORM_{x,y,z} are only intermediate values, i.e., the uncertainties of NORM_{x,y,z} does not effect the E^2 -field uncertainty inside TSL (see below ConvF).
- **NORM(f)_{x,y,z} = NORM_{x,y,z} * frequency_response** (see Frequency Response Chart). This linearization is implemented in DASY4 software versions later than 4.2. The uncertainty of the frequency response is included in the stated uncertainty of ConvF.
- **DCP_{x,y,z}:** DCP are numerical linearization parameters assessed based on the data of power sweep (no uncertainty required). DCP does not depend on frequency nor media.
- **PAR:** PAR is the Peak to Average Ratio that is not calibrated but determined based on the signal characteristics.
- **A_{x,y,z}; B_{x,y,z}; C_{x,y,z}; VR_{x,y,z}; A,B,C** are numerical linearization parameters assessed based on the data of power sweep for specific modulation signal. The parameters do not depend on frequency nor media. VR is the maximum calibration range expressed in RMS voltage across the diode
- **ConvF and Boundary Effect Parameters:** Assessed in flat phantom using E-field (or Temperature Transfer Standard for fs800MHz) and inside waveguide using analytical field distributions based on power measurements for f > 800MHz. The same setups are used for assessment of the parameters applied for boundary compensation (alpha, depth) of which typical uncertainty valued are given. These parameters are used in DASY4 software to improve probe accuracy close to the boundary. The sensitivity in TSL corresponds to NORM_{x,y,z} * ConvF whereby the uncertainty corresponds to that given for ConvF. A frequency dependent ConvF is used in DASY version 4.4 and higher which allows extending the validity from ± 50 MHz to ± 100 MHz.
- **Spherical Isotropy (3D deviation from isotropy):** in a field of low gradients realized using a flat phantom exposed by a patch antenna.
- **Sensor Offset:** The sensor offset corresponds to the offset of virtual measurement center from the probe tip (on probe axis). No tolerance required.
- **Connector Angle:** The angle is assessed using the information gained by determining the NORM_x (no uncertainty required).

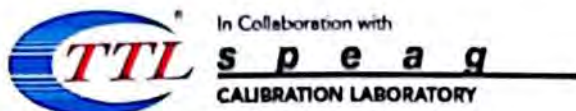

In Collaboration with
TTL s p e a g
CALIBRATION LABORATORY
 Add: No 52 HuaYuanBei Road, Haidian District, Beijing, 100191, China
 Tel: +86-10-62304633-2512 Fax: +86-10-62304633-2504
 E-mail: ctl@chinatl.com [Http://www.chinatl.cn](http://www.chinatl.cn)

DASY/EASY – Parameters of Probe: EX3DV4 – SN:7543

Basic Calibration Parameters

	Sensor X	Sensor Y	Sensor Z	Unc (k=2)
Norm($\mu V/(V/m)^2$) ^A	0.62	0.69	0.55	±10.0%
DCP(mV) ^B	100.4	104.2	102.3	

Modulation Calibration Parameters

UID	Communication System Name		A dB	B dB $\sqrt{\mu V}$	C	D dB	VR mV	Unc ^E (k=2)
0	CW	X	0.0	0.0	1.0	0.00	197.2	±2.7%
		Y	0.0	0.0	1.0		206.6	
		Z	0.0	0.0	1.0		180.8	

The reported uncertainty of measurement is stated as the standard uncertainty of Measurement multiplied by the coverage factor $k=2$, which for a normal distribution Corresponds to a coverage probability of approximately 95%.

^A The uncertainties of Norm X, Y, Z do not affect the E²-field uncertainty inside TSL (see Page 4).

^B Numerical linearization parameter; uncertainty not required.

^E Uncertainty is determined using the max. deviation from linear response applying rectangular distribution and is expressed for the square of the field value.



In Collaboration with
TTL **s p e a g**
CALIBRATION LABORATORY
 Add: No.52 HuaYuanBei Road, Haidian District, Beijing, 100191, China
 Tel: +86-10-62304633-2512 Fax: +86-10-62304633-2504
 E-mail: ttl@chinattl.com Http://www.chinattl.cn

DASY/EASY – Parameters of Probe: EX3DV4 – SN:7543

Calibration Parameter Determined in Head Tissue Simulating Media

f [MHz] ^C	Relative Permittivity ^F	Conductivity (S/m) ^F	ConvF X	ConvF Y	ConvF Z	Alpha ^G	Depth ^G (mm)	Unct. (k=2)
750	41.9	0.89	10.27	10.27	10.27	0.17	1.26	±12.1%
835	41.5	0.90	9.89	9.89	9.89	0.14	1.62	±12.1%
1750	40.1	1.37	8.42	8.42	8.42	0.28	0.95	±12.1%
1900	40.0	1.40	8.20	8.20	8.20	0.28	1.03	±12.1%
2000	40.0	1.40	8.23	8.23	8.23	0.26	1.08	±12.1%
2300	39.5	1.67	7.68	7.68	7.68	0.62	0.70	±12.1%
2450	39.2	1.80	7.49	7.49	7.49	0.68	0.69	±12.1%
2600	39.0	1.96	7.24	7.24	7.24	0.50	0.81	±12.1%
3300	38.2	2.71	6.94	6.94	6.94	0.41	1.05	±13.3%
3500	37.9	2.91	6.79	6.79	6.79	0.43	1.03	±13.3%
3700	37.7	3.12	6.51	6.51	6.51	0.44	1.01	±13.3%
3900	37.5	3.32	6.40	6.40	6.40	0.35	1.35	±13.3%
4100	37.2	3.53	6.49	6.49	6.49	0.40	1.15	±13.3%
4400	36.9	3.84	6.32	6.32	6.32	0.35	1.35	±13.3%
4600	36.7	4.04	6.22	6.22	6.22	0.45	1.20	±13.3%
4800	36.4	4.25	6.16	6.16	6.16	0.45	1.20	±13.3%
4950	36.3	4.40	5.95	5.95	5.95	0.45	1.25	±13.3%
5250	35.9	4.71	5.44	5.44	5.44	0.45	1.25	±13.3%
5600	35.5	5.07	4.81	4.81	4.81	0.55	1.20	±13.3%
5750	35.4	5.22	4.94	4.94	4.94	0.55	1.25	±13.3%

^C Frequency validity above 300 MHz of ±100MHz only applies for DASY v4.4 and higher (Page 2), else it is restricted to ±50MHz. The uncertainty is the RSS of ConvF uncertainty at calibration frequency and the uncertainty for the indicated frequency band. Frequency validity below 300 MHz is ± 10, 25, 40, 50 and 70 MHz for ConvF assessments at 30, 64, 128, 150 and 220 MHz respectively. Above 5 GHz frequency validity can be extended to ± 110 MHz.

^F At frequency below 3 GHz, the validity of tissue parameters (ϵ and σ) can be relaxed to ±10% if liquid compensation formula is applied to measured SAR values. At frequencies above 3 GHz, the validity of tissue parameters (ϵ and σ) is restricted to ±5%. The uncertainty is the RSS of the ConvF uncertainty for indicated target tissue parameters.

^G Alpha/Depth are determined during calibration. SPEAG warrants that the remaining deviation due to the boundary effect after compensation is always less than ± 1% for frequencies below 3 GHz and below ± 2% for the frequencies between 3-6 GHz at any distance larger than half the probe tip diameter from the boundary

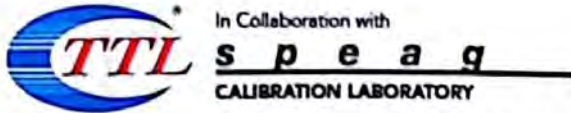

Add: No.52 HuaYuanBei Road, Haidian District, Beijing, 100191, China
Tel: +86-10-62304633-2512 Fax: +86-10-62304633-2504
E-mail: cttl@chinattl.com [Http://www.chinattl.cn](http://www.chinattl.cn)

Frequency Response of E-Field (TEM-Cell: ifi110 EXX, Waveguide: R22)

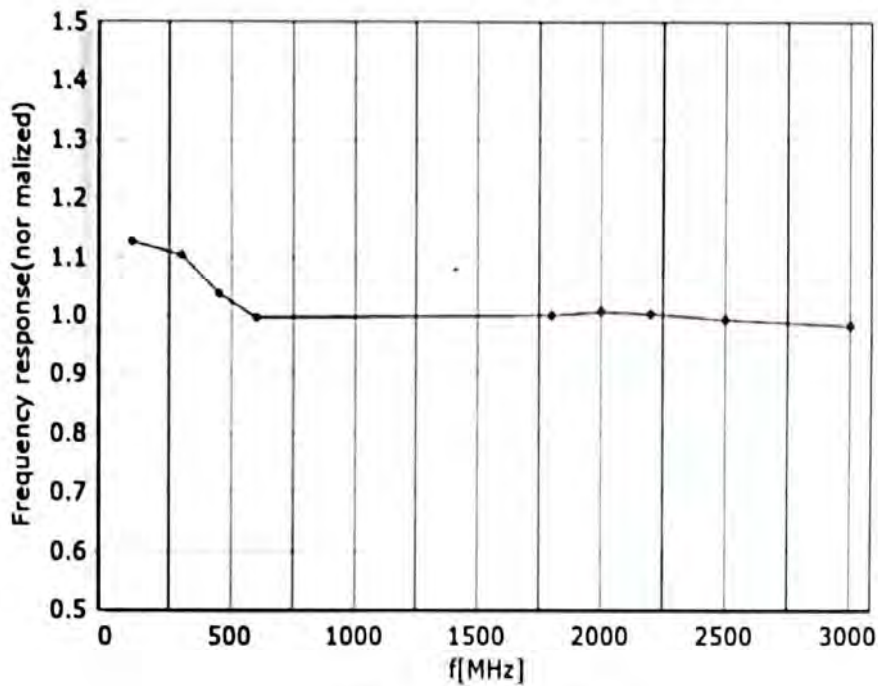

* TEM

* R22

Uncertainty of Frequency Response of E-field: $\pm 7.4\%$ ($k=2$)



Add: No.52 HuaYuanBei Road, Haidian District, Beijing, 100191, China
 Tel: +86-10-62304633-2512 Fax: +86-10-62304633-2504
 E-mail: cttl@chinattl.com <http://www.chinattl.cn>

Receiving Pattern (Φ), $\theta=0^\circ$

f=600 MHz, TEM

f=1800 MHz, R22

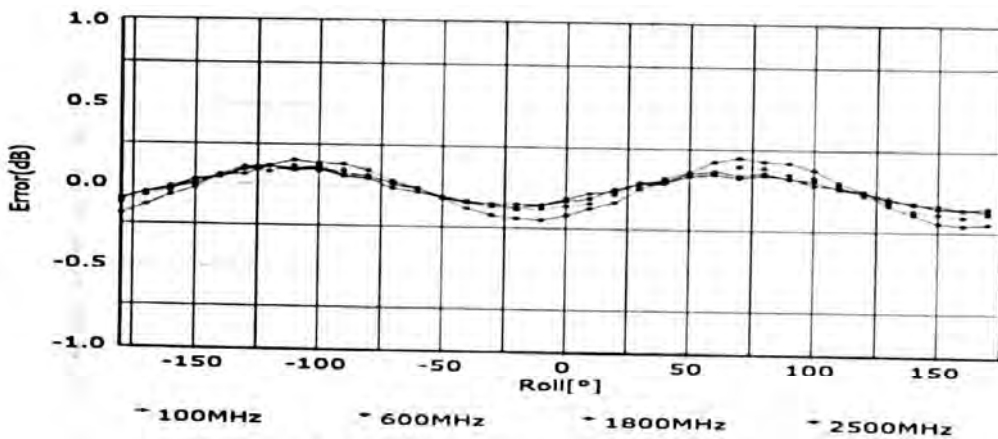
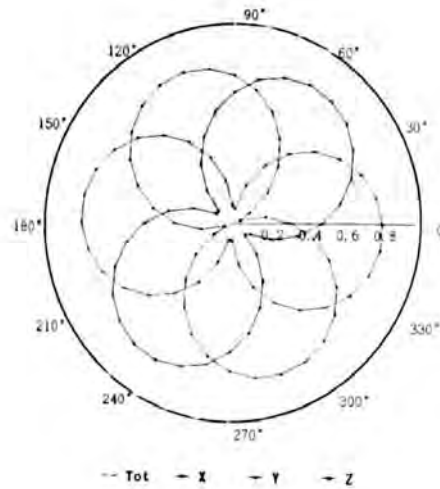
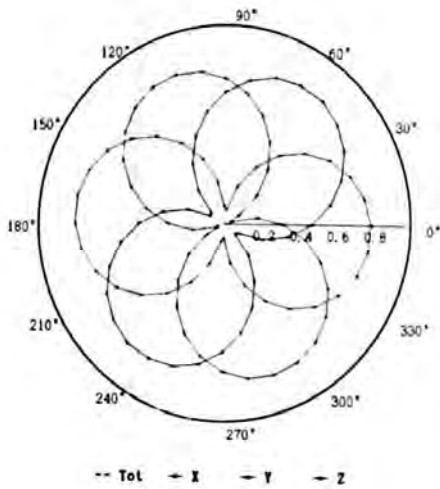

Uncertainty of Axial Isotropy Assessment: $\pm 1.2\%$ ($k=2$)



Add: No.52 HuaYuanBei Road, Haidian District, Beijing, 100191, China
 Tel: +86-10-62304633-2512 Fax: +86-10-62304633-2504
 E-mail: cttl@chinattl.com [Http://www.chinattl.cn](http://www.chinattl.cn)

Dynamic Range $f(\text{SAR}_{\text{head}})$ (TEM cell, $f = 900 \text{ MHz}$)

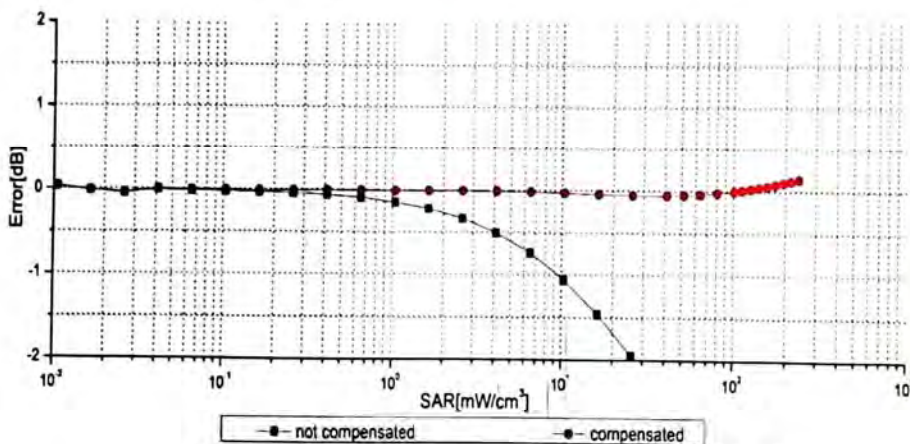
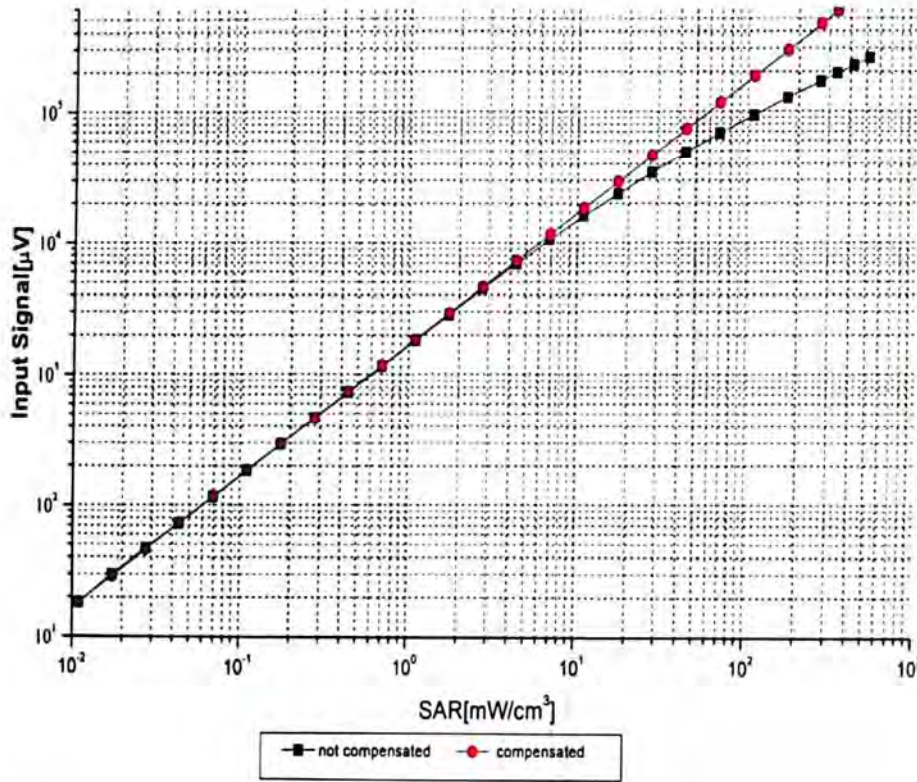

Uncertainty of Linearity Assessment: $\pm 0.9\%$ ($k=2$)

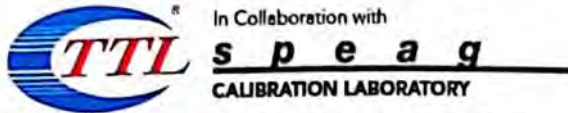

Add: No.52 HuaYuanBei Road, Haidian District, Beijing, 100191, China
 Tel: +86-10-62304633-2512 Fax: +86-10-62304633-2504
 E-mail: cttl@chinattl.com Http://www.chinattl.cn

Conversion Factor Assessment

f=750 MHz,WGLS R9(H_convF)

f=1750 MHz,WGLS R22(H_convF)

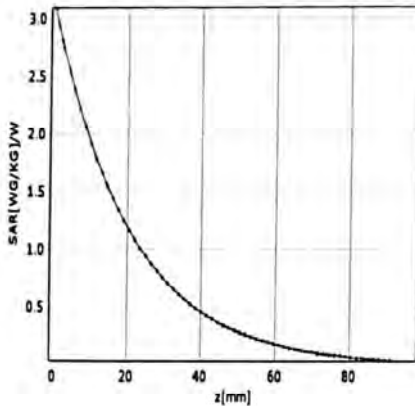

* analytical * measured

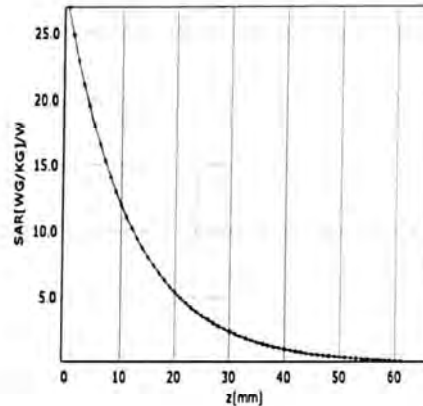

* analytical * measured

Deviation from Isotropy in Liquid

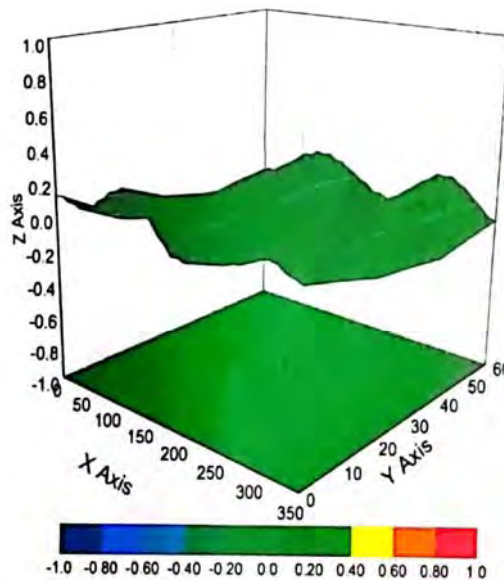

Uncertainty of Spherical Isotropy Assessment: $\pm 3.2\%$ ($k=2$)



Add: No.52 HuaYuanBei Road, Haidian District, Beijing, 100191, China
 Tel: +86-10-62304633-2512 Fax: +86-10-62304633-2504
 E-mail: ttl@chinattl.com [Http://www.chinattl.cn](http://www.chinattl.cn)

DASY/EASY – Parameters of Probe: EX3DV4 – SN:7543

Other Probe Parameters

Sensor Arrangement	Triangular
Connector Angle (°)	50.7
Mechanical Surface Detection Mode	enabled
Optical Surface Detection Mode	disable
Probe Overall Length	337mm
Probe Body Diameter	10mm
Tip Length	9mm
Tip Diameter	2.5mm
Probe Tip to Sensor X Calibration Point	1mm
Probe Tip to Sensor Y Calibration Point	1mm
Probe Tip to Sensor Z Calibration Point	1mm
Recommended Measurement Distance from Surface	1.4mm



ANNEX F: D835V2 Dipole Calibration Certificate



In Collaboration with
s p e a g
CALIBRATION LABORATORY



中国认可
国际互认
校准
CALIBRATION
CNAS L0570

Add: No.51 Xueyuan Road, Haidian District, Beijing, 100191, China
Tel: +86-10-62304633-2079 Fax: +86-10-62304633-2504
E-mail: cttl@chinattl.com http://www.chinattl.cn

Client TA(Shanghai)

Certificate No: Z20-60296

CALIBRATION CERTIFICATE

Object D835V2 - SN: 4d020

Calibration Procedure(s) FF-Z11-003-01
Calibration Procedures for dipole validation kits

Calibration date: August 28, 2020

This calibration Certificate documents the traceability to national standards, which realize the physical units of measurements(SI). The measurements and the uncertainties with confidence probability are given on the following pages and are part of the certificate.

All calibrations have been conducted in the closed laboratory facility: environment temperature(22±3)°C and humidity<70%.

Calibration Equipment used (M&TE critical for calibration)

Primary Standards	ID #	Cal Date(Callibrated by, Certificate No.)	Scheduled Calibration
Power Meter NRP2	106276	12-May-20 (CTTL, No.J20X02965)	May-21
Power sensor NRP6A	101369	12-May-20 (CTTL, No.J20X02965)	May-21
Reference Probe EX3DV4	SN 3617	30-Jan-20(SPEAG, No.EX3-3617_Jan20)	Jan-21
DAE4	SN 771	10-Feb-20(CTTL-SPEAG, No.Z20-60017)	Feb-21
Secondary Standards	ID #	Cal Date(Callibrated by, Certificate No.)	Scheduled Calibration
Signal Generator E4438C	MY49071430	25-Feb-20 (CTTL, No.J20X00516)	Feb-21
NetworkAnalyzer E5071C	MY46110673	10-Feb-20 (CTTL, No.J20X00515)	Feb-21

	Name	Function	Signature
Calibrated by:	Zhao Jing	SAR Test Engineer	
Reviewed by:	Lin Hao	SAR Test Engineer	
Approved by:	Qi Dianyuan	SAR Project Leader	

Issued: September 3, 2020

This calibration certificate shall not be reproduced except in full without written approval of the laboratory.

Certificate No: Z20-60296

Page 1 of 8



In Collaboration with
s p e a g
CALIBRATION LABORATORY

Add: No.51 Xueyuan Road, Haidian District, Beijing, 100191, China
Tel: +86-10-62304633-2079 Fax: +86-10-62304633-2504
E-mail: cttl@chinattl.com http://www.chinattl.cn

Glossary:

TSL	tissue simulating liquid
ConvF	sensitivity in TSL / NORM _{x,y,z}
N/A	not applicable or not measured

Calibration is Performed According to the Following Standards:

- IEEE Std 1528-2013, "IEEE Recommended Practice for Determining the Peak Spatial-Averaged Specific Absorption Rate (SAR) in the Human Head from Wireless Communications Devices: Measurement Techniques", June 2013
- IEC 62209-1, "Measurement procedure for assessment of specific absorption rate of human exposure to radio frequency fields from hand-held and body-mounted wireless communication devices- Part 1: Device used next to the ear (Frequency range of 300MHz to 6GHz)", July 2016
- IEC 62209-2, "Procedure to measure the Specific Absorption Rate (SAR) For wireless communication devices used in close proximity to the human body (frequency range of 30MHz to 6GHz)", March 2010
- KDB865664, SAR Measurement Requirements for 100 MHz to 6 GHz

Additional Documentation:

- DASY4/5 System Handbook

Methods Applied and Interpretation of Parameters:

- Measurement Conditions:** Further details are available from the Validation Report at the end of the certificate. All figures stated in the certificate are valid at the frequency indicated.
- Antenna Parameters with TSL:** The dipole is mounted with the spacer to position its feed point exactly below the center marking of the flat phantom section, with the arms oriented parallel to the body axis.
- Feed Point Impedance and Return Loss:** These parameters are measured with the dipole positioned under the liquid filled phantom. The impedance stated is transformed from the measurement at the SMA connector to the feed point. The Return Loss ensures low reflected power. No uncertainty required.
- Electrical Delay:** One-way delay between the SMA connector and the antenna feed point. No uncertainty required.
- SAR measured:** SAR measured at the stated antenna input power.
- SAR normalized:** SAR as measured, normalized to an input power of 1 W at the antenna connector.
- SAR for nominal TSL parameters:** The measured TSL parameters are used to calculate the nominal SAR result.

The reported uncertainty of measurement is stated as the standard uncertainty of Measurement multiplied by the coverage factor $k=2$, which for a normal distribution Corresponds to a coverage probability of approximately 95%.



In Collaboration with
s p e a g
 CALIBRATION LABORATORY

Add: No.51 Xueyuan Road, Haidian District, Beijing, 100191, China
 Tel: +86-10-62304633-2079 Fax: +86-10-62304633-2504
 E-mail: cttl@chinattl.com http://www.chinattl.cn

Measurement Conditions

DASY system configuration, as far as not given on page 1.

DASY Version	DASY52	V52.10.4
Extrapolation	Advanced Extrapolation	
Phantom	Triple Flat Phantom 5.1C	
Distance Dipole Center - TSL	15 mm	with Spacer
Zoom Scan Resolution	dx, dy, dz = 5 mm	
Frequency	835 MHz ± 1 MHz	

Head TSL parameters

The following parameters and calculations were applied.

	Temperature	Permittivity	Conductivity
Nominal Head TSL parameters	22.0 °C	41.5	0.90 mho/m
Measured Head TSL parameters	(22.0 ± 0.2) °C	41.2 ± 6 %	0.88 mho/m ± 6 %
Head TSL temperature change during test	<1.0 °C	---	---

SAR result with Head TSL

SAR averaged over 1 cm ³ (1 g) of Head TSL	Condition	
SAR measured	250 mW input power	2.37 W/kg
SAR for nominal Head TSL parameters	normalized to 1W	9.65 W/kg ± 18.8 % (k=2)
SAR averaged over 10 cm ³ (10 g) of Head TSL	Condition	
SAR measured	250 mW input power	1.57 W/kg
SAR for nominal Head TSL parameters	normalized to 1W	6.37 W/kg ± 18.7 % (k=2)

Body TSL parameters

The following parameters and calculations were applied.

	Temperature	Permittivity	Conductivity
Nominal Body TSL parameters	22.0 °C	55.2	0.97 mho/m
Measured Body TSL parameters	(22.0 ± 0.2) °C	55.0 ± 6 %	0.96 mho/m ± 6 %
Body TSL temperature change during test	<1.0 °C	---	---

SAR result with Body TSL

SAR averaged over 1 cm ³ (1 g) of Body TSL	Condition	
SAR measured	250 mW input power	2.42 W/kg
SAR for nominal Body TSL parameters	normalized to 1W	9.76 W /kg ± 18.8 % (k=2)
SAR averaged over 10 cm ³ (10 g) of Body TSL	Condition	
SAR measured	250 mW input power	1.59 W/kg
SAR for nominal Body TSL parameters	normalized to 1W	6.40 W/kg ± 18.7 % (k=2)



In Collaboration with
s p e a g
 CALIBRATION LABORATORY

Add: No.51 Xueyuan Road, Haidian District, Beijing, 100191, China
 Tel: +86-10-62304633-2079 Fax: +86-10-62304633-2504
 E-mail: ctrl@chinattl.com http://www.chinattl.cn

Appendix (Additional assessments outside the scope of CNAS L0570)

Antenna Parameters with Head TSL

Impedance, transformed to feed point	54.8Ω+ 1.73jΩ
Return Loss	- 26.2dB

Antenna Parameters with Body TSL

Impedance, transformed to feed point	46.0Ω- 2.47jΩ
Return Loss	- 26.2dB

General Antenna Parameters and Design

Electrical Delay (one direction)	1.258 ns
----------------------------------	----------

After long term use with 100W radiated power, only a slight warming of the dipole near the feedpoint can be measured.

The dipole is made of standard semirigid coaxial cable. The center conductor of the feeding line is directly connected to the second arm of the dipole. The antenna is therefore short-circuited for DC-signals. On some of the dipoles, small end caps are added to the dipole arms in order to improve matching when loaded according to the position as explained in the "Measurement Conditions" paragraph. The SAR data are not affected by this change. The overall dipole length is still according to the Standard. No excessive force must be applied to the dipole arms, because they might bend or the soldered connections near the feedpoint may be damaged.

Additional EUT Data

Manufactured by	SPEAG
-----------------	-------



In Collaboration with
s p e a g
CALIBRATION LABORATORY

Add: No.51 Xueyuan Road, Haidian District, Beijing, 100191, China
Tel: +86-10-62304633-2079 Fax: +86-10-62304633-2504
E-mail: cttl@chinattl.com http://www.chinattl.cn

DASY5 Validation Report for Head TSL

Date: 08.28.2020

Test Laboratory: CTTL, Beijing, China

DUT: Dipole 835 MHz; Type: D835V2; Serial: D835V2 - SN: 4d020

Communication System: UID 0, CW; Frequency: 835 MHz; Duty Cycle: 1:1

Medium parameters used: $f = 835$ MHz; $\sigma = 0.877$ S/m; $\epsilon_r = 41.23$; $\rho = 1000$ kg/m³

Phantom section: Center Section

DASY5 Configuration:

- Probe: EX3DV4 - SN3617; ConvF(9.66, 9.66, 9.66) @ 835 MHz; Calibrated: 2020-01-30
- Sensor-Surface: 1.4mm (Mechanical Surface Detection)
- Electronics: DAE4 Sn771; Calibrated: 2020-02-10
- Phantom: MFP_V5.1C (20deg probe tilt); Type: QD 000 P51 Cx; Serial: 1062
- Measurement SW: DASY52, Version 52.10 (4); SEMCAD X Version 14.6.14 (7483)

Dipole Calibration/Zoom Scan (7x7x7) (7x7x7)/Cube 0: Measurement grid: dx=5mm, dy=5mm, dz=5mm

Reference Value = 58.09 V/m; Power Drift = -0.03 dB

Peak SAR (extrapolated) = 3.46 W/kg

SAR(1 g) = 2.37 W/kg; SAR(10 g) = 1.57 W/kg

Smallest distance from peaks to all points 3 dB below = 16.6 mm

Ratio of SAR at M2 to SAR at M1 = 68.1%

Maximum value of SAR (measured) = 3.12 W/kg

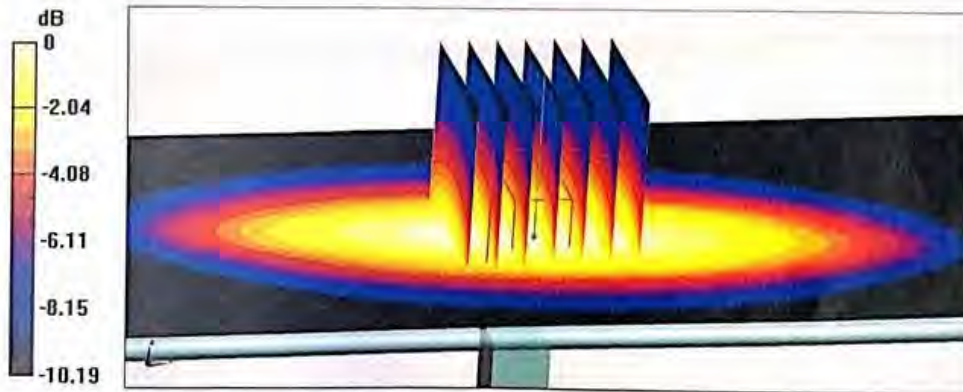



In Collaboration with
s p e a g
CALIBRATION LABORATORY

Add: No.51 Xueyuan Road, Haidian District, Beijing, 100191, China
Tel: +86-10-62304633-2079 Fax: +86-10-62304633-2504
E-mail: ettl@chinattl.com http://www.chinattl.cn

Impedance Measurement Plot for Head TSL

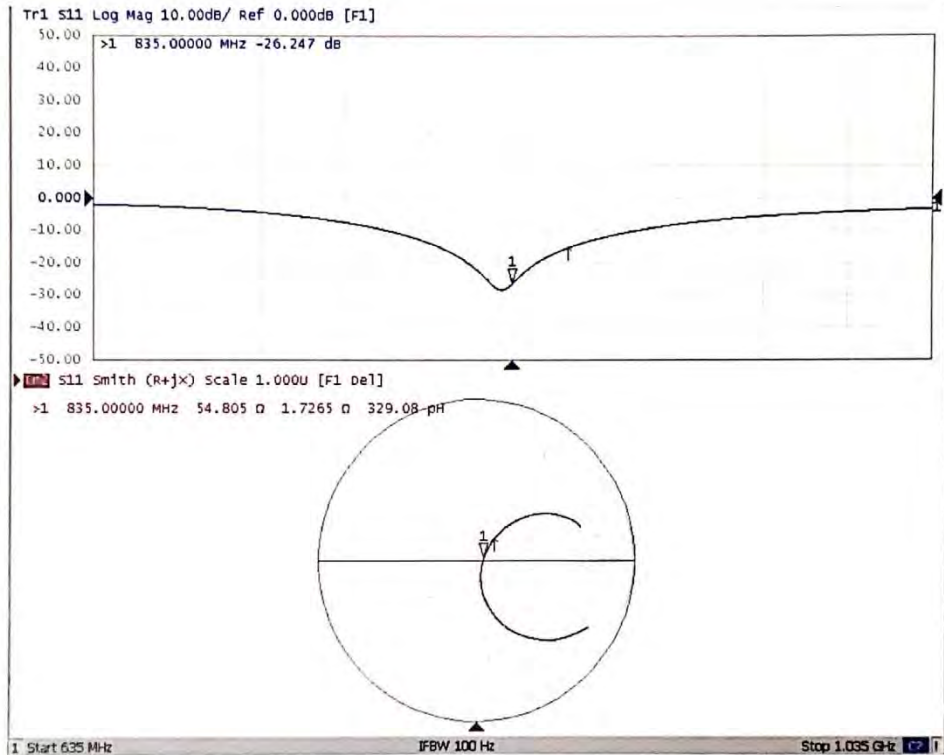



In Collaboration with
s p e a g
CALIBRATION LABORATORY

Add: No.51 Xueyuan Road, Haidian District, Beijing, 100191, China
Tel: +86-10-62304633-2079 Fax: +86-10-62304633-2504
E-mail: cttl@chinattl.com http://www.chinattl.cn

DASY5 Validation Report for Body TSL

Date: 08.28.2020

Test Laboratory: CTTL, Beijing, China

DUT: Dipole 835 MHz; Type: D835V2; Serial: D835V2 - SN: 4d020

Communication System: UID 0, CW; Frequency: 835 MHz; Duty Cycle: 1:1

Medium parameters used: $f = 835 \text{ MHz}$; $\sigma = 0.958 \text{ S/m}$; $\epsilon_r = 55.02$; $\rho = 1000 \text{ kg/m}^3$

Phantom section: Right Section

DASY5 Configuration:

- Probe: EX3DV4 - SN3617; ConvF(9.53, 9.53, 9.53) @ 835 MHz; Calibrated: 2020-01-30
- Sensor-Surface: 1.4mm (Mechanical Surface Detection)
- Electronics: DAE4 Sn771; Calibrated: 2020-02-10
- Phantom: MFP_V5.1C (20deg probe tilt); Type: QD 000 P51 Cx; Serial: 1062
- Measurement SW: DASY52, Version 52.10 (4); SEMCAD X Version 14.6.14 (7483)

Dipole Calibration/Zoom Scan (7x7x7) (7x7x7)/Cube 0: Measurement grid: dx=5mm, dy=5mm, dz=5mm

Reference Value = 56.88 V/m; Power Drift = -0.01 dB

Peak SAR (extrapolated) = 3.65 W/kg

SAR(1 g) = 2.42 W/kg; SAR(10 g) = 1.59 W/kg

Smallest distance from peaks to all points 3 dB below = 15.8 mm

Ratio of SAR at M2 to SAR at M1 = 66.5%

Maximum value of SAR (measured) = 3.24 W/kg

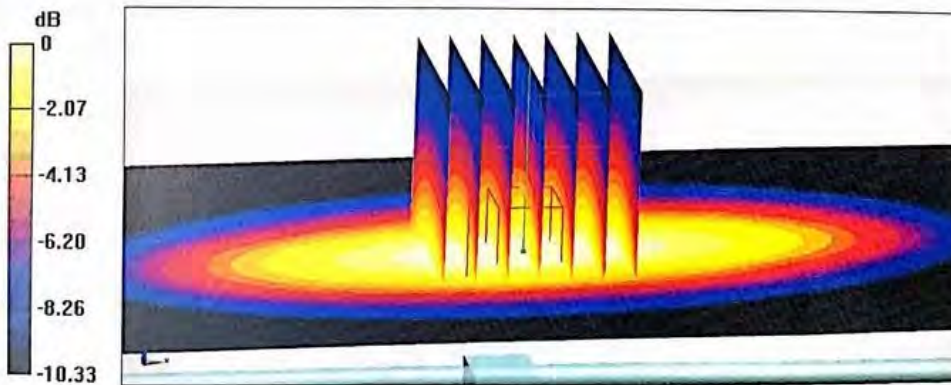

0 dB = 3.24 W/kg = 5.11 dBW/kg



In Collaboration with
s p e a g
CALIBRATION LABORATORY

Add: No.51 Xueyuan Road, Haidian District, Beijing, 100191, China
Tel: +86-10-62304633-2079 Fax: +86-10-62304633-2504
E-mail: ettl@chinattl.com http://www.chinattl.cn

Impedance Measurement Plot for Body TSL

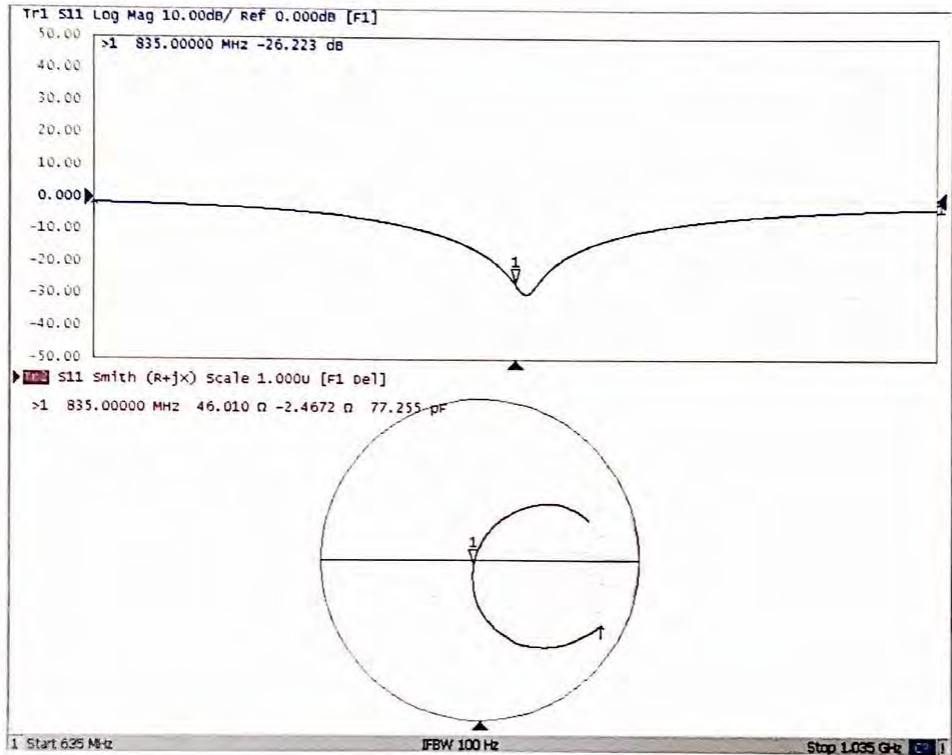



ANNEX G: D1750V2 Dipole Calibration Certificate



In Collaboration with
s p e a g
CALIBRATION LABORATORY



中国认可
国际互认
校准
CALIBRATION
CNAS L0570

Add: No.51 Xueyuan Road, Haidian District, Beijing, 100191, China
Tel: +86-10-62304633-2079 Fax: +86-10-62304633-2504
E-mail: cttl@chinattl.com http://www.chinattl.cn

Client TA(Shanghai)

Certificate No: Z20-60079

CALIBRATION CERTIFICATE

Object D1750V2 - SN: 1033

Calibration Procedure(s) FF-Z11-003-01
Calibration Procedures for dipole validation kits

Calibration date: February 25, 2020

This calibration Certificate documents the traceability to national standards, which realize the physical units of measurements(SI). The measurements and the uncertainties with confidence probability are given on the following pages and are part of the certificate.

All calibrations have been conducted in the closed laboratory facility: environment temperature(22±3)°C and humidity<70%.

Calibration Equipment used (M&TE critical for calibration)

Primary Standards	ID #	Cal Date(Calibrated by, Certificate No.)	Scheduled Calibration
Power Meter NRP2	106276	11-Apr-19 (CTTL, No.J19X02605)	Apr-20
Power sensor NRP6A	101369	11-Apr-19 (CTTL, No.J19X02605)	Apr-20
Reference Probe EX3DV4	SN 3846	25-Mar-19(CTTL-SPEAG,No.Z19-60064)	Mar-20
DAE4	SN 1555	22-Aug-19(CTTL-SPEAG,No.Z19-60295)	Aug-20
Secondary Standards	ID #	Cal Date(Calibrated by, Certificate No.)	Scheduled Calibration
Signal Generator E4438C	MY49071430	10-Feb-20 (CTTL, No.J20X00516)	Feb-21
NetworkAnalyzer E5071C	MY46110673	10-Feb-20 (CTTL, No.J20X00515)	Feb-21

	Name	Function	Signature
Calibrated by:	Zhao Jing	SAR Test Engineer	
Reviewed by:	Lin Hao	SAR Test Engineer	
Approved by:	Qi Dianyuan	SAR Project Leader	

Issued: February 29, 2020

This calibration certificate shall not be reproduced except in full without written approval of the laboratory.

Certificate No: Z20-60079

Page 1 of 8



In Collaboration with
s p e a g
CALIBRATION LABORATORY

Add: No.51 Xueyuan Road, Haidian District, Beijing, 100191, China
Tel: +86-10-62304633-2079 Fax: +86-10-62304633-2504
E-mail: cttl@chinattl.com http://www.chinattl.cn

Glossary:

TSL	tissue simulating liquid
ConvF	sensitivity in TSL / NORM _{x,y,z}
N/A	not applicable or not measured

Calibration is Performed According to the Following Standards:

- IEEE Std 1528-2013, "IEEE Recommended Practice for Determining the Peak Spatial-Averaged Specific Absorption Rate (SAR) in the Human Head from Wireless Communications Devices: Measurement Techniques", June 2013
- IEC 62209-1, "Measurement procedure for assessment of specific absorption rate of human exposure to radio frequency fields from hand-held and body-mounted wireless communication devices- Part 1: Device used next to the ear (Frequency range of 300MHz to 6GHz)", July 2016
- IEC 62209-2, "Procedure to measure the Specific Absorption Rate (SAR) For wireless communication devices used in close proximity to the human body (frequency range of 30MHz to 6GHz)", March 2010
- KDB865664, SAR Measurement Requirements for 100 MHz to 6 GHz

Additional Documentation:

- DASY4/5 System Handbook

Methods Applied and Interpretation of Parameters:

- Measurement Conditions:** Further details are available from the Validation Report at the end of the certificate. All figures stated in the certificate are valid at the frequency indicated.
- Antenna Parameters with TSL:** The dipole is mounted with the spacer to position its feed point exactly below the center marking of the flat phantom section, with the arms oriented parallel to the body axis.
- Feed Point Impedance and Return Loss:** These parameters are measured with the dipole positioned under the liquid filled phantom. The impedance stated is transformed from the measurement at the SMA connector to the feed point. The Return Loss ensures low reflected power. No uncertainty required.
- Electrical Delay:** One-way delay between the SMA connector and the antenna feed point. No uncertainty required.
- SAR measured:** SAR measured at the stated antenna input power.
- SAR normalized:** SAR as measured, normalized to an input power of 1 W at the antenna connector.
- SAR for nominal TSL parameters:** The measured TSL parameters are used to calculate the nominal SAR result.

The reported uncertainty of measurement is stated as the standard uncertainty of Measurement multiplied by the coverage factor $k=2$, which for a normal distribution Corresponds to a coverage probability of approximately 95%.



Add: No.51 Xueyuan Road, Haidian District, Beijing, 100191, China
 Tel: +86-10-62304633-2079 Fax: +86-10-62304633-2504
 E-mail: cttl@chinattl.com http://www.chinattl.cn

Measurement Conditions

DASY system configuration, as far as not given on page 1.

DASY Version	DASY52	V52.10.4
Extrapolation	Advanced Extrapolation	
Phantom	Triple Flat Phantom 5.1C	
Distance Dipole Center - TSL	10 mm	with Spacer
Zoom Scan Resolution	dx, dy, dz = 5 mm	
Frequency	1750 MHz ± 1 MHz	

Head TSL parameters

The following parameters and calculations were applied.

	Temperature	Permittivity	Conductivity
Nominal Head TSL parameters	22.0 °C	40.1	1.37 mho/m
Measured Head TSL parameters	(22.0 ± 0.2) °C	39.1 ± 6 %	1.35 mho/m ± 6 %
Head TSL temperature change during test	<1.0 °C	----	----

SAR result with Head TSL

SAR averaged over 1 cm ³ (1 g) of Head TSL	Condition	
SAR measured	250 mW input power	8.93 W/kg
SAR for nominal Head TSL parameters	normalized to 1W	35.9 W/kg ± 18.8 % (k=2)
SAR averaged over 10 cm ³ (10 g) of Head TSL	Condition	
SAR measured	250 mW input power	4.71 W/kg
SAR for nominal Head TSL parameters	normalized to 1W	18.9 W/kg ± 18.7 % (k=2)

Body TSL parameters

The following parameters and calculations were applied.

	Temperature	Permittivity	Conductivity
Nominal Body TSL parameters	22.0 °C	53.4	1.49 mho/m
Measured Body TSL parameters	(22.0 ± 0.2) °C	52.4 ± 6 %	1.48 mho/m ± 6 %
Body TSL temperature change during test	<1.0 °C	----	----

SAR result with Body TSL

SAR averaged over 1 cm ³ (1 g) of Body TSL	Condition	
SAR measured	250 mW input power	9.24 W/kg
SAR for nominal Body TSL parameters	normalized to 1W	36.9 W/kg ± 18.8 % (k=2)
SAR averaged over 10 cm ³ (10 g) of Body TSL	Condition	
SAR measured	250 mW input power	4.95 W/kg
SAR for nominal Body TSL parameters	normalized to 1W	19.8 W/kg ± 18.7 % (k=2)



In Collaboration with
s p e a g
CALIBRATION LABORATORY

Add: No.51 Xueyuan Road, Haidian District, Beijing, 100191, China
Tel: +86-10-62304633-2079 Fax: +86-10-62304633-2504
E-mail: cttl@chinattl.com http://www.chinattl.cn

Appendix (Additional assessments outside the scope of CNAS L0570)

Antenna Parameters with Head TSL

Impedance, transformed to feed point	48.8Ω- 0.06 jΩ
Return Loss	- 38.3 dB

Antenna Parameters with Body TSL

Impedance, transformed to feed point	44.5Ω- 0.85 jΩ
Return Loss	- 24.5 dB

General Antenna Parameters and Design

Electrical Delay (one direction)	1.085 ns
----------------------------------	----------

After long term use with 100W radiated power, only a slight warming of the dipole near the feedpoint can be measured.

The dipole is made of standard semirigid coaxial cable. The center conductor of the feeding line is directly connected to the second arm of the dipole. The antenna is therefore short-circuited for DC-signals. On some of the dipoles, small end caps are added to the dipole arms in order to improve matching when loaded according to the position as explained in the "Measurement Conditions" paragraph. The SAR data are not affected by this change. The overall dipole length is still according to the Standard.

No excessive force must be applied to the dipole arms, because they might bend or the soldered connections near the feedpoint may be damaged.

Additional EUT Data

Manufactured by	SPEAG
-----------------	-------



In Collaboration with
TTL **s p e a g**
CALIBRATION LABORATORY
 Add: No.51 Xueyuan Road, Haidian District, Beijing, 100191, China
 Tel: +86-10-62304633-2079 Fax: +86-10-62304633-2504
 E-mail: cttl@chinattl.com http://www.chinattl.cn

DASY5 Validation Report for Head TSL

Date: 02.25.2020

Test Laboratory: CTTL, Beijing, China

DUT: Dipole 1750 MHz; Type: D1750V2; Serial: D1750V2 - SN: 1033

Communication System: UID 0, CW; Frequency: 1750 MHz; Duty Cycle: 1:1

Medium parameters used: $f = 1750$ MHz; $\sigma = 1.349$ S/m; $\epsilon_r = 39.06$; $\rho = 1000$ kg/m³

Phantom section: Right Section

DASY5 Configuration:

- Probe: EX3DV4 - SN3846; ConvF(8.2, 8.2, 8.2) @ 1750 MHz; Calibrated: 2019-03-25
- Sensor-Surface: 1.4mm (Mechanical Surface Detection)
- Electronics: DAE4 Sn1555; Calibrated: 2019-08-22
- Phantom: MFP_V5.1C (20deg probe tilt); Type: QD 000 P51 Cx; Serial: 1062
- Measurement SW: DASY52, Version 52.10 (4); SEMCAD X Version 14.6.14 (7483)

System Performance Check/Zoom Scan (7x7x7) (7x7x7)/Cube 0: Measurement grid:

$dx=5$ mm, $dy=5$ mm, $dz=5$ mm

Reference Value = 98.26 V/m; Power Drift = -0.02 dB

Peak SAR (extrapolated) = 16.9 W/kg

SAR(1 g) = 8.93 W/kg; SAR(10 g) = 4.71 W/kg

Smallest distance from peaks to all points 3 dB below = 10 mm

Ratio of SAR at M2 to SAR at M1 = 53.5%

Maximum value of SAR (measured) = 13.9 W/kg

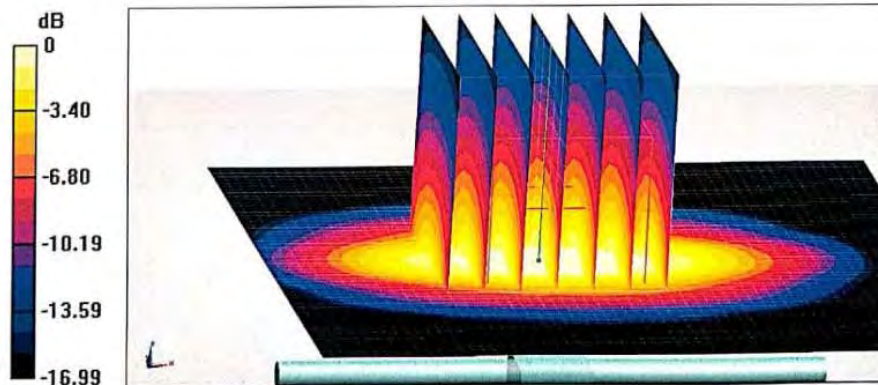

0 dB = 13.9 W/kg = 11.43 dBW/kg



In Collaboration with
s p e a g
CALIBRATION LABORATORY

Add: No.51 Xueyuan Road, Haidian District, Beijing, 100191, China
Tel: +86-10-62304633-2079 Fax: +86-10-62304633-2504
E-mail: cttl@chinattl.com http://www.chinattl.cn

Impedance Measurement Plot for Head TSL

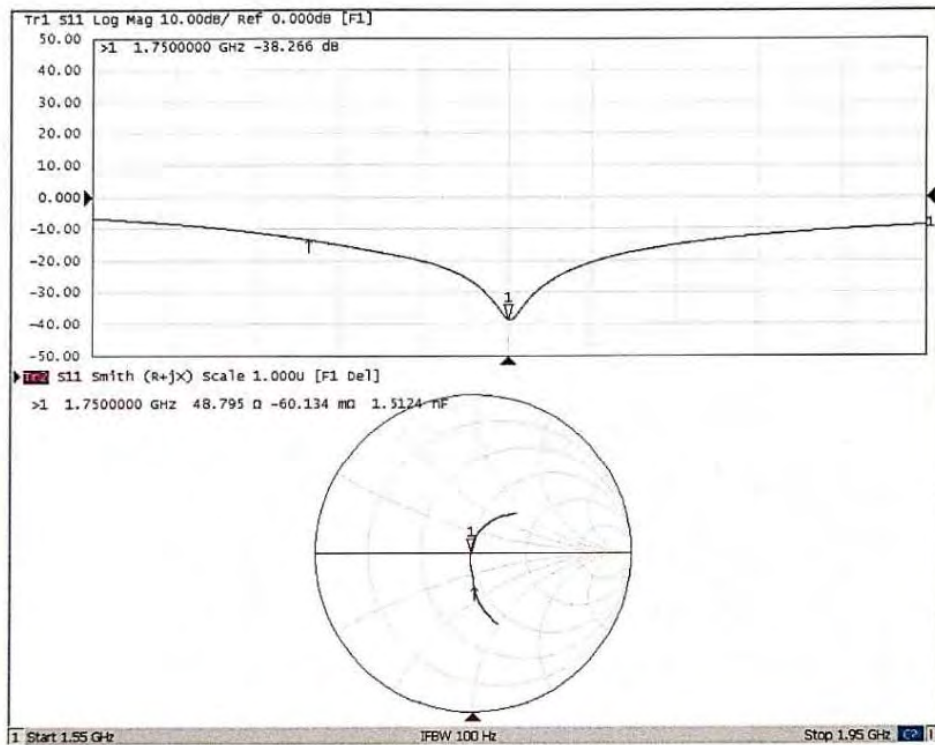

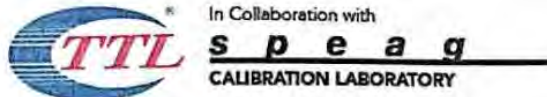

Add: No.51 Xueyuan Road, Haidian District, Beijing, 100191, China
 Tel: +86-10-62304633-2079 Fax: +86-10-62304633-2504
 E-mail: cttl@chinattl.com http://www.chinattl.cn

DASY5 Validation Report for Body TSL

Date: 02.25.2020

Test Laboratory: CTTL, Beijing, China

DUT: Dipole 1750 MHz; Type: D1750V2; Serial: D1750V2 - SN: 1033

Communication System: UID 0, CW; Frequency: 1750 MHz; Duty Cycle: 1:1

Medium parameters used: $f = 1750$ MHz; $\sigma = 1.482$ S/m; $\epsilon_r = 52.35$; $\rho = 1000$ kg/m³

Phantom section: Center Section

DASY5 Configuration:

- Probe: EX3DV4 - SN3846; ConvF(7.8, 7.8, 7.8) @ 1750 MHz; Calibrated: 2019-03-25
- Sensor-Surface: 1.4mm (Mechanical Surface Detection)
- Electronics: DAE4 Sn1555; Calibrated: 2019-08-22
- Phantom: MFP_V5.1C (20deg probe tilt); Type: QD 000 P51 Cx; Serial: 1062
- Measurement SW: DASY52, Version 52.10 (4); SEMCAD X Version 14.6.14 (7483)

System Performance Check/Zoom Scan (7x7x7) (7x7x7)/Cube 0: Measurement grid:

dx=5mm, dy=5mm, dz=5mm

Reference Value = 94.32 V/m; Power Drift = 0.00 dB

Peak SAR (extrapolated) = 16.9 W/kg

SAR(1 g) = 9.24 W/kg; SAR(10 g) = 4.95 W/kg

Smallest distance from peaks to all points 3 dB below = 9.2 mm

Ratio of SAR at M2 to SAR at M1 = 56%

Maximum value of SAR (measured) = 14.1 W/kg

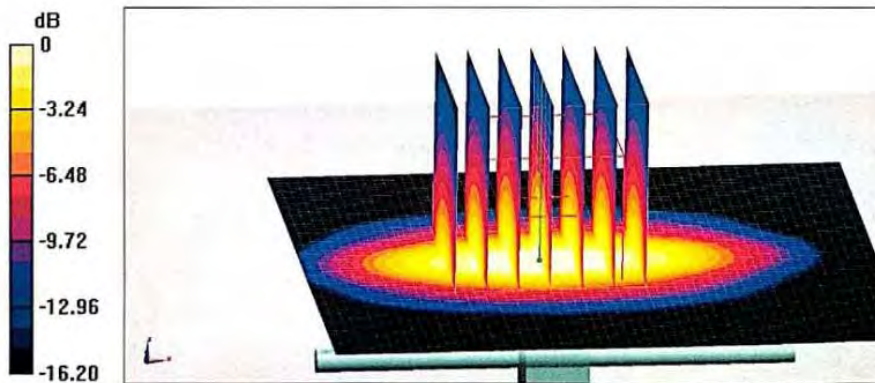

0 dB = 14.1 W/kg = 11.49 dBW/kg



Add: No.51 Xueyuan Road, Haidian District, Beijing, 100191, China
Tel: +86-10-62304633-2079 Fax: +86-10-62304633-2504
E-mail: cttl@chinattl.com http://www.chinattl.cn

Impedance Measurement Plot for Body TSL

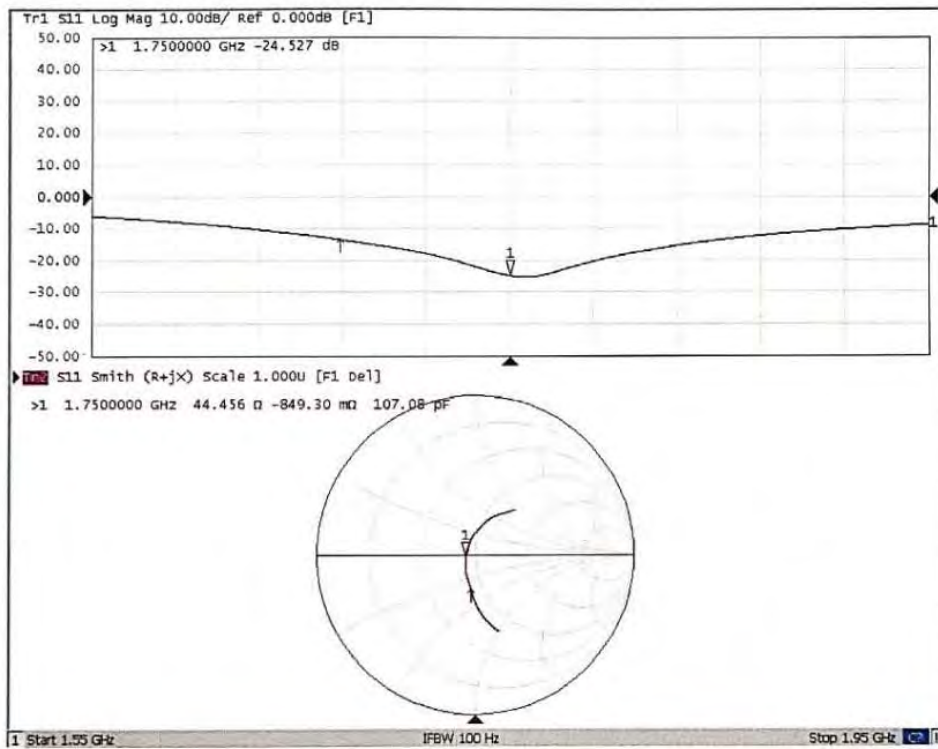



ANNEX H: D1900V2 Dipole Calibration Certificate



In Collaboration with
s p e a g
CALIBRATION LABORATORY

Add: No.51 Xueyuan Road, Haidian District, Beijing, 100191, China
Tel: +86-10-62304633-2079 Fax: +86-10-62304633-2504
E-mail: cttl@chinattl.com http://www.chinattl.cn



中国认可
国际互认
校准
CALIBRATION
CNAS L0570

Client TA(Shanghai)

Certificate No: Z20-60297

CALIBRATION CERTIFICATE

Object D1900V2 - SN: 5d060

Calibration Procedure(s) FF-Z11-003-01
Calibration Procedures for dipole validation kits

Calibration date: August 27, 2020

This calibration Certificate documents the traceability to national standards, which realize the physical units of measurements(SI). The measurements and the uncertainties with confidence probability are given on the following pages and are part of the certificate.

All calibrations have been conducted in the closed laboratory facility: environment temperature(22±3)°C and humidity<70%.

Calibration Equipment used (M&TE critical for calibration)

Primary Standards	ID #	Cal Date(Calibrated by, Certificate No.)	Scheduled Calibration
Power Meter NRP2	106276	12-May-20 (CTTL, No.J20X02965)	May-21
Power sensor NRP6A	101369	12-May-20 (CTTL, No.J20X02965)	May-21
Reference Probe EX3DV4	SN 3617	30-Jan-20(SPEAG,No.EX3-3617_Jan20)	Jan-21
DAE4	SN 771	10-Feb-20(CTTL-SPEAG,No.Z20-60017)	Feb-21
Secondary Standards	ID #	Cal Date(Calibrated by, Certificate No.)	Scheduled Calibration
Signal Generator E4438C	MY49071430	25-Feb-20 (CTTL, No.J20X00516)	Feb-21
NetworkAnalyzer E5071C	MY46110673	10-Feb-20 (CTTL, No.J20X00515)	Feb-21

	Name	Function	Signature
Calibrated by:	Zhao Jing	SAR Test Engineer	
Reviewed by:	Lin Hao	SAR Test Engineer	
Approved by:	Qi Dianyuan	SAR Project Leader	

Issued: September 3, 2020

This calibration certificate shall not be reproduced except in full without written approval of the laboratory.



In Collaboration with
s p e a g
CALIBRATION LABORATORY

Add: No.51 Xueyuan Road, Haidian District, Beijing, 100191, China
Tel: +86-10-62304633-2079 Fax: +86-10-62304633-2504
E-mail: cttl@chinattl.com http://www.chinattl.cn

Glossary:

TSL	tissue simulating liquid
ConvF	sensitivity in TSL / NORM _{x,y,z}
N/A	not applicable or not measured

Calibration is Performed According to the Following Standards:

- IEEE Std 1528-2013, "IEEE Recommended Practice for Determining the Peak Spatial-Averaged Specific Absorption Rate (SAR) in the Human Head from Wireless Communications Devices: Measurement Techniques", June 2013
- IEC 62209-1, "Measurement procedure for assessment of specific absorption rate of human exposure to radio frequency fields from hand-held and body-mounted wireless communication devices- Part 1: Device used next to the ear (Frequency range of 300MHz to 6GHz)", July 2016
- IEC 62209-2, "Procedure to measure the Specific Absorption Rate (SAR) For wireless communication devices used in close proximity to the human body (frequency range of 30MHz to 6GHz)", March 2010
- KDB865664, SAR Measurement Requirements for 100 MHz to 6 GHz

Additional Documentation:

- DASY4/5 System Handbook

Methods Applied and Interpretation of Parameters:

- Measurement Conditions:** Further details are available from the Validation Report at the end of the certificate. All figures stated in the certificate are valid at the frequency indicated.
- Antenna Parameters with TSL:** The dipole is mounted with the spacer to position its feed point exactly below the center marking of the flat phantom section, with the arms oriented parallel to the body axis.
- Feed Point Impedance and Return Loss:** These parameters are measured with the dipole positioned under the liquid filled phantom. The impedance stated is transformed from the measurement at the SMA connector to the feed point. The Return Loss ensures low reflected power. No uncertainty required.
- Electrical Delay:** One-way delay between the SMA connector and the antenna feed point. No uncertainty required.
- SAR measured:** SAR measured at the stated antenna input power.
- SAR normalized:** SAR as measured, normalized to an input power of 1 W at the antenna connector.
- SAR for nominal TSL parameters:** The measured TSL parameters are used to calculate the nominal SAR result.

The reported uncertainty of measurement is stated as the standard uncertainty of Measurement multiplied by the coverage factor $k=2$, which for a normal distribution Corresponds to a coverage probability of approximately 95%.

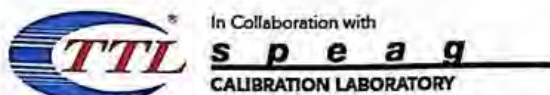

In Collaboration with
TTL **s p e a g**
CALIBRATION LABORATORY
 Add: No.51 Xueyuan Road, Haidian District, Beijing, 100191, China
 Tel: +86-10-62304633-2079 Fax: +86-10-62304633-2504
 E-mail: ettl@chinattl.com http://www.chinattl.cn

Measurement Conditions

DASY system configuration, as far as not given on page 1.

DASY Version	DASY52	V52.10.4
Extrapolation	Advanced Extrapolation	
Phantom	Triple Flat Phantom 5.1C	
Distance Dipole Center - TSL	10 mm	with Spacer
Zoom Scan Resolution	dx, dy, dz = 5 mm	
Frequency	1900 MHz ± 1 MHz	

Head TSL parameters

The following parameters and calculations were applied.

	Temperature	Permittivity	Conductivity
Nominal Head TSL parameters	22.0 °C	40.0	1.40 mho/m
Measured Head TSL parameters	(22.0 ± 0.2) °C	41.1 ± 6 %	1.40 mho/m ± 6 %
Head TSL temperature change during test	<1.0 °C	---	---

SAR result with Head TSL

SAR averaged over 1 cm ³ (1 g) of Head TSL	Condition	
SAR measured	250 mW input power	9.82 W/kg
SAR for nominal Head TSL parameters	normalized to 1W	39.5 W/kg ± 18.8 % (k=2)
SAR averaged over 10 cm ³ (10 g) of Head TSL	Condition	
SAR measured	250 mW input power	5.04 W/kg
SAR for nominal Head TSL parameters	normalized to 1W	20.2 W/kg ± 18.7 % (k=2)

Body TSL parameters

The following parameters and calculations were applied.

	Temperature	Permittivity	Conductivity
Nominal Body TSL parameters	22.0 °C	53.3	1.52 mho/m
Measured Body TSL parameters	(22.0 ± 0.2) °C	53.5 ± 6 %	1.51 mho/m ± 6 %
Body TSL temperature change during test	<1.0 °C	---	---

SAR result with Body TSL

SAR averaged over 1 cm ³ (1 g) of Body TSL	Condition	
SAR measured	250 mW input power	9.89 W/kg
SAR for nominal Body TSL parameters	normalized to 1W	39.8 W/kg ± 18.8 % (k=2)
SAR averaged over 10 cm ³ (10 g) of Body TSL	Condition	
SAR measured	250 mW input power	5.13 W/kg
SAR for nominal Body TSL parameters	normalized to 1W	20.6 W/kg ± 18.7 % (k=2)

Certificate No: Z20-60297

Page 3 of 8

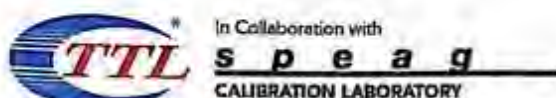

Add: No.51 Xueyuan Road, Haidian District, Beijing, 100191, China
 Tel: +86-10-62304633-2079 Fax: +86-10-62304633-2504
 E-mail: etl@chinattl.com http://www.chinattl.cn

Appendix (Additional assessments outside the scope of CNAS L0570)

Antenna Parameters with Head TSL

Impedance, transformed to feed point	52.5Ω+ 6.58jΩ
Return Loss	- 23.3dB

Antenna Parameters with Body TSL

Impedance, transformed to feed point	48.0Ω+ 6.72jΩ
Return Loss	- 22.9dB

General Antenna Parameters and Design

Electrical Delay (one direction)	1.061 ns
----------------------------------	----------

After long term use with 100W radiated power, only a slight warming of the dipole near the feedpoint can be measured.

The dipole is made of standard semirigid coaxial cable. The center conductor of the feeding line is directly connected to the second arm of the dipole. The antenna is therefore short-circuited for DC-signals. On some of the dipoles, small end caps are added to the dipole arms in order to improve matching when loaded according to the position as explained in the "Measurement Conditions" paragraph. The SAR data are not affected by this change. The overall dipole length is still according to the Standard. No excessive force must be applied to the dipole arms, because they might bend or the soldered connections near the feedpoint may be damaged.

Additional EUT Data

Manufactured by	SPEAG
-----------------	-------

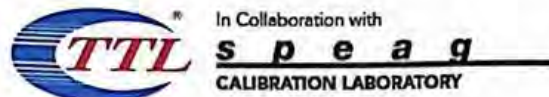

Add: No.51 Xueyuan Road, Haidian District, Beijing, 100191, China
 Tel: +86-10-62304633-2079 Fax: +86-10-62304633-2504
 E-mail: cttl@chinattl.com http://www.chinattl.cn

DASY5 Validation Report for Head TSL

Date: 08.27.2020

Test Laboratory: CTTL, Beijing, China

DUT: Dipole 1900 MHz; Type: D1900V2; Serial: D1900V2 - SN: 5d060

Communication System: UID 0, CW; Frequency: 1900 MHz; Duty Cycle: 1:1

Medium parameters used: $f = 1900$ MHz; $\sigma = 1.404$ S/m; $\epsilon_r = 41.12$; $\rho = 1000$ kg/m³

Phantom section: Center Section

DASY5 Configuration:

- Probe: EX3DV4 - SN3617; ConvF(8.14, 8.14, 8.14) @ 1900 MHz; Calibrated: 2020-01-30
- Sensor-Surface: 1.4mm (Mechanical Surface Detection)
- Electronics: DAE4 Sn771; Calibrated: 2020-02-10
- Phantom: MFP_V5.1C (20deg probe tilt); Type: QD 000 P51 Cx; Serial: 1062
- Measurement SW: DASY52, Version 52.10 (4); SEMCAD X Version 14.6.14 (7483)

System Performance Check/Zoom Scan (7x7x7) (7x7x7)/Cube 0: Measurement grid:

dx=5mm, dy=5mm, dz=5mm

Reference Value = 100.3 V/m; Power Drift = -0.03 dB

Peak SAR (extrapolated) = 19.0 W/kg

SAR(1 g) = 9.82 W/kg; SAR(10 g) = 5.04 W/kg

Smallest distance from peaks to all points 3 dB below = 10 mm

Ratio of SAR at M2 to SAR at M1 = 51.9%

Maximum value of SAR (measured) = 15.6 W/kg

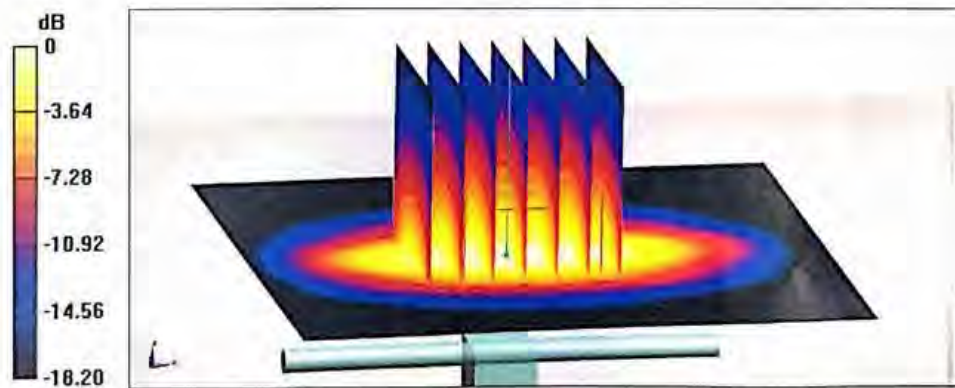

0 dB = 15.6 W/kg = 11.93 dBW/kg



Add: No.51 Xueyuan Road, Haidian District, Beijing, 100191, China
Tel: +86-10-62304633-2079 Fax: +86-10-62304633-2504
E-mail: ttl@chinattl.com http://www.chinattl.cn

Impedance Measurement Plot for Head TSL

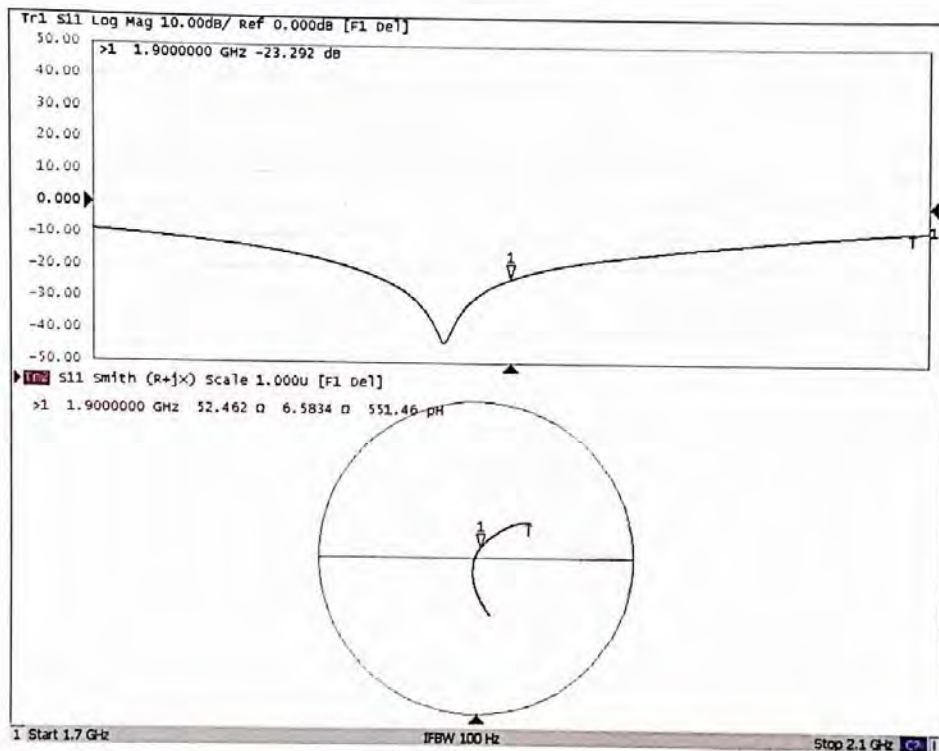

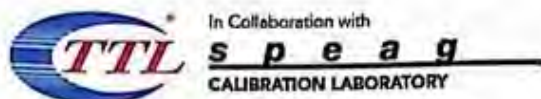

Add: No.51 Xueyuan Road, Haidian District, Beijing, 100191, China
 Tel: +86-10-62304633-2079 Fax: +86-10-62304633-2504
 E-mail: cttl@chinattl.com http://www.chinattl.cn

DASY5 Validation Report for Body TSL

Date: 08.27.2020

Test Laboratory: CTTL, Beijing, China

DUT: Dipole 1900 MHz; Type: D1900V2; Serial: D1900V2 - SN: 5d060

Communication System: UID 0, CW; Frequency: 1900 MHz; Duty Cycle: 1:1

Medium parameters used: $f = 1900$ MHz; $\sigma = 1.508$ S/m; $\epsilon_r = 53.5$; $\rho = 1000$ kg/m³

Phantom section: Right Section

DASY5 Configuration:

- Probe: EX3DV4 - SN3617; ConvF(7.94, 7.94, 7.94) @ 1900 MHz; Calibrated: 2020-01-30
- Sensor-Surface: 1.4mm (Mechanical Surface Detection)
- Electronics: DAE4 Sn771; Calibrated: 2020-02-10
- Phantom: MFP_V5.1C (20deg probe tilt); Type: QD 000 P51 Cx; Serial: 1062
- Measurement SW: DASY52, Version 52.10 (4); SEMCAD X Version 14.6.14 (7483)

System Performance Check/Zoom Scan (7x7x7) (7x7x7)/Cube 0: Measurement grid:

$dx=5$ mm, $dy=5$ mm, $dz=5$ mm

Reference Value = 97.34 V/m; Power Drift = -0.03 dB

Peak SAR (extrapolated) = 18.2 W/kg

SAR(1 g) = 9.89 W/kg; SAR(10 g) = 5.13 W/kg

Smallest distance from peaks to all points 3 dB below = 9 mm

Ratio of SAR at M2 to SAR at M1 = 55.4%

Maximum value of SAR (measured) = 15.3 W/kg



0 dB = 15.3 W/kg = 11.85 dBW/kg

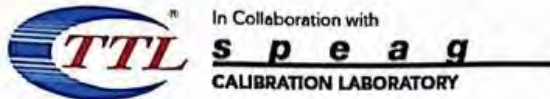

Add: No.51 Xueyuan Road, Haidian District, Beijing, 100191, China
Tel: +86-10-62304633-2079 Fax: +86-10-62304633-2504
E-mail: ttl@chinattl.com http://www.chinattl.cn

Impedance Measurement Plot for Body TSL

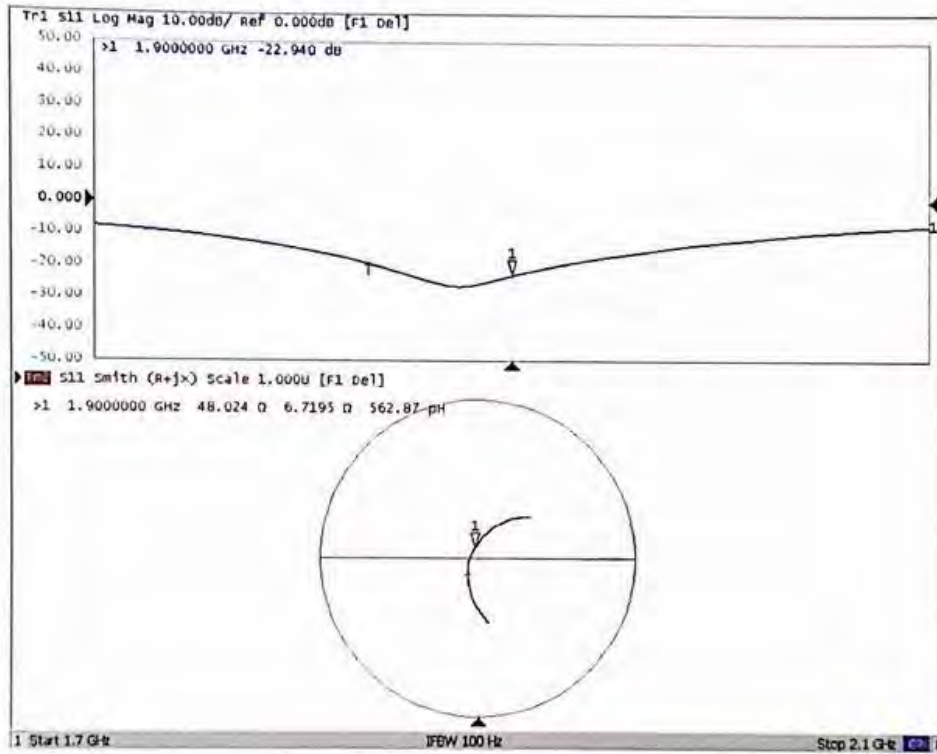



ANNEX I: D2450V2 Dipole Calibration Certificate



In Collaboration with
s p e a g
CALIBRATION LABORATORY



中国认可
国际互认
校准
CALIBRATION
CNAS L0570

Add: No.51 Xueyuan Road, Haidian District, Beijing, 100191, China
Tel: +86-10-62304633-2079 Fax: +86-10-62304633-2504
E-mail: ettl@chinattl.com http://www.chinattl.cn

Client TA(Shanghai)

Certificate No: Z20-60298

CALIBRATION CERTIFICATE			
Object	D2450V2 - SN: 788		
Calibration Procedure(s)	FF-Z11-003-01 Calibration Procedures for dipole validation kits		
Calibration date:	August 27, 2020		
<p>This calibration Certificate documents the traceability to national standards, which realize the physical units of measurements(SI). The measurements and the uncertainties with confidence probability are given on the following pages and are part of the certificate.</p> <p>All calibrations have been conducted in the closed laboratory facility: environment temperature(22±3)°C and humidity<70%.</p> <p>Calibration Equipment used (M&TE critical for calibration)</p>			
Primary Standards	ID #	Cal Date(Calibrated by, Certificate No.)	Scheduled Calibration
Power Meter NRP2	106276	12-May-20 (CTTL, No.J20X02965)	May-21
Power sensor NRP6A	101369	12-May-20 (CTTL, No.J20X02965)	May-21
Reference Probe EX3DVB4	SN 3617	30-Jan-20(SPEAG, No.EX3-3617_Jan20)	Jan-21
DAE4	SN 771	10-Feb-20(CTTL-SPEAG, No.Z20-60017)	Feb-21
Secondary Standards	ID #	Cal Date(Calibrated by, Certificate No.)	Scheduled Calibration
Signal Generator E4438C	MY49071430	25-Feb-20 (CTTL, No.J20X00516)	Feb-21
NetworkAnalyzer E5071C	MY46107873	10-Feb-20 (CTTL, No.J20X00515)	Feb-21
Calibrated by:	Name	Function	Signature
	Zhao Jing	SAR Test Engineer	
Reviewed by:	Lin Hao	SAR Test Engineer	
Approved by:	Qi Dianyuan	SAR Project Leader	
Issued: September 2, 2020			
This calibration certificate shall not be reproduced except in full without written approval of the laboratory.			

Certificate No: Z20-60298

Page 1 of 8



In Collaboration with
s p e a q
CALIBRATION LABORATORY

Add: No.51 Xueyuan Road, Haidian District, Beijing, 100191, China
Tel: +86-10-62304633-2079 Fax: +86-10-62304633-2504
E-mail: cttl@chinattl.com http://www.chinattl.cn

Glossary:

TSL	tissue simulating liquid
ConvF	sensitivity in TSL / NORM _{x,y,z}
N/A	not applicable or not measured

Calibration is Performed According to the Following Standards:

- IEEE Std 1528-2013, "IEEE Recommended Practice for Determining the Peak Spatial-Averaged Specific Absorption Rate (SAR) in the Human Head from Wireless Communications Devices: Measurement Techniques", September 2013
- IEC 62209-1, "Measurement procedure for assessment of specific absorption rate of human exposure to radio frequency fields from hand-held and body-mounted wireless communication devices- Part 1: Device used next to the ear (Frequency range of 300MHz to 6GHz)", July 2016
- IEC 62209-2, "Procedure to measure the Specific Absorption Rate (SAR) For wireless communication devices used in close proximity to the human body (frequency range of 30MHz to 6GHz)", March 2010
- KDB865664, SAR Measurement Requirements for 100 MHz to 6 GHz

Additional Documentation:

- DASY4/5 System Handbook

Methods Applied and Interpretation of Parameters:

- Measurement Conditions:** Further details are available from the Validation Report at the end of the certificate. All figures stated in the certificate are valid at the frequency indicated.
- Antenna Parameters with TSL:** The dipole is mounted with the spacer to position its feed point exactly below the center marking of the flat phantom section, with the arms oriented parallel to the body axis.
- Feed Point Impedance and Return Loss:** These parameters are measured with the dipole positioned under the liquid filled phantom. The impedance stated is transformed from the measurement at the SMA connector to the feed point. The Return Loss ensures low reflected power. No uncertainty required.
- Electrical Delay:** One-way delay between the SMA connector and the antenna feed point. No uncertainty required.
- SAR measured:** SAR measured at the stated antenna input power.
- SAR normalized:** SAR as measured, normalized to an input power of 1 W at the antenna connector.
- SAR for nominal TSL parameters:** The measured TSL parameters are used to calculate the nominal SAR result.

The reported uncertainty of measurement is stated as the standard uncertainty of Measurement multiplied by the coverage factor $k=2$, which for a normal distribution Corresponds to a coverage probability of approximately 95%.



In Collaboration with
s p e a g
CALIBRATION LABORATORY

Add: No.51 Xueyuan Road, Haidian District, Beijing, 100191, China
Tel: +86-10-62304633-2079 Fax: +86-10-62304633-2504
E-mail: cttl@chinattl.com http://www.chinattl.cn

Measurement Conditions

DASY system configuration, as far as not given on page 1.

DASY Version	DASY52	V52.10.4
Extrapolation	Advanced Extrapolation	
Phantom	Triple Flat Phantom 5.1C	
Distance Dipole Center - TSL	10 mm	with Spacer
Zoom Scan Resolution	dx, dy, dz = 5 mm	
Frequency	2450 MHz ± 1 MHz	

Head TSL parameters

The following parameters and calculations were applied.

	Temperature	Permittivity	Conductivity
Nominal Head TSL parameters	22.0 °C	39.2	1.80 mho/m
Measured Head TSL parameters	(22.0 ± 0.2) °C	39.5 ± 6 %	1.79 mho/m ± 6 %
Head TSL temperature change during test	<1.0 °C	---	---

SAR result with Head TSL

SAR averaged over 1 cm ³ (1 g) of Head TSL	Condition	
SAR measured	250 mW input power	13.0 W/kg
SAR for nominal Head TSL parameters	normalized to 1W	52.3 W/kg ± 18.8 % (k=2)
SAR averaged over 10 cm ³ (10 g) of Head TSL	Condition	
SAR measured	250 mW input power	5.99 W/kg
SAR for nominal Head TSL parameters	normalized to 1W	24.0 W/kg ± 18.7 % (k=2)

Body TSL parameters

The following parameters and calculations were applied.

	Temperature	Permittivity	Conductivity
Nominal Body TSL parameters	22.0 °C	52.7	1.95 mho/m
Measured Body TSL parameters	(22.0 ± 0.2) °C	52.1 ± 6 %	1.94 mho/m ± 6 %
Body TSL temperature change during test	<1.0 °C	---	---

SAR result with Body TSL

SAR averaged over 1 cm ³ (1 g) of Body TSL	Condition	
SAR measured	250 mW input power	13.1 W/kg
SAR for nominal Body TSL parameters	normalized to 1W	52.4 W/kg ± 18.8 % (k=2)
SAR averaged over 10 cm ³ (10 g) of Body TSL	Condition	
SAR measured	250 mW input power	6.08 W/kg
SAR for nominal Body TSL parameters	normalized to 1W	24.3 W/kg ± 18.7 % (k=2)



In Collaboration with
s p e a g
CALIBRATION LABORATORY

Add: No.51 Xueyuan Road, Haidian District, Beijing, 100191, China
 Tel: +86-10-62304633-2079 Fax: +86-10-62304633-2504
 E-mail: cttl@chinattl.com http://www.chinattl.cn

Appendix (Additional assessments outside the scope of CNAS L0570)

Antenna Parameters with Head TSL

Impedance, transformed to feed point	54.5Ω+ 1.44 jΩ
Return Loss	- 26.9dB

Antenna Parameters with Body TSL

Impedance, transformed to feed point	50.9Ω+ 5.09 jΩ
Return Loss	- 25.8dB

General Antenna Parameters and Design

Electrical Delay (one direction)	1.018 ns
----------------------------------	----------

After long term use with 100W radiated power, only a slight warming of the dipole near the feedpoint can be measured.

The dipole is made of standard semirigid coaxial cable. The center conductor of the feeding line is directly connected to the second arm of the dipole. The antenna is therefore short-circuited for DC-signals. On some of the dipoles, small end caps are added to the dipole arms in order to improve matching when loaded according to the position as explained in the "Measurement Conditions" paragraph. The SAR data are not affected by this change. The overall dipole length is still according to the Standard. No excessive force must be applied to the dipole arms, because they might bend or the soldered connections near the feedpoint may be damaged.

Additional EUT Data

Manufactured by	SPEAG
-----------------	-------



In Collaboration with
s p e a g
CALIBRATION LABORATORY

Add: No.51 Xueyuan Road, Haidian District, Beijing, 100191, China
Tel: +86-10-62304633-2079 Fax: +86-10-62304633-2504
E-mail: cttl@chinattl.com http://www.chinattl.cn

DASY5 Validation Report for Head TSL

Date: 08.27.2020

Test Laboratory: CTTL, Beijing, China

DUT: Dipole 2450 MHz; Type: D2450V2; Serial: D2450V2 - SN: 786

Communication System: UTD 0, CW; Frequency: 2450 MHz; Duty Cycle: 1:1

Medium parameters used: $f = 2450$ MHz; $\sigma = 1.787$ S/m; $\epsilon_r = 39.53$; $\rho = 1000$ kg/m³

Phantom section: Center Section

DASY5 Configuration:

- Probe: EX3DV4 - SN3617; ConvF(7.65, 7.65, 7.65) @ 2450 MHz; Calibrated: 2020-01-30
- Sensor-Surface: 1.4mm (Mechanical Surface Detection)
- Electronics: DAE4 Sn771; Calibrated: 2020-02-10
- Phantom: MFP_V5.1C (20deg probe tilt); Type: QD 000 P51 Cx; Serial: 1062
- Measurement SW: DASY52, Version 52.10 (4); SEMCAD X Version 14.6.14 (7483)

Dipole Calibration/Zoom Scan (7x7x7) (7x7x7)/Cube 0: Measurement grid: dx=5mm, dy=5mm, dz=5mm

Reference Value = 102.7 V/m; Power Drift = -0.04 dB

Peak SAR (extrapolated) = 27.7 W/kg

SAR(1 g) = 13 W/kg; SAR(10 g) = 5.99 W/kg

Smallest distance from peaks to all points 3 dB below = 8.9 mm

Ratio of SAR at M2 to SAR at M1 = 47%

Maximum value of SAR (measured) = 22.0 W/kg

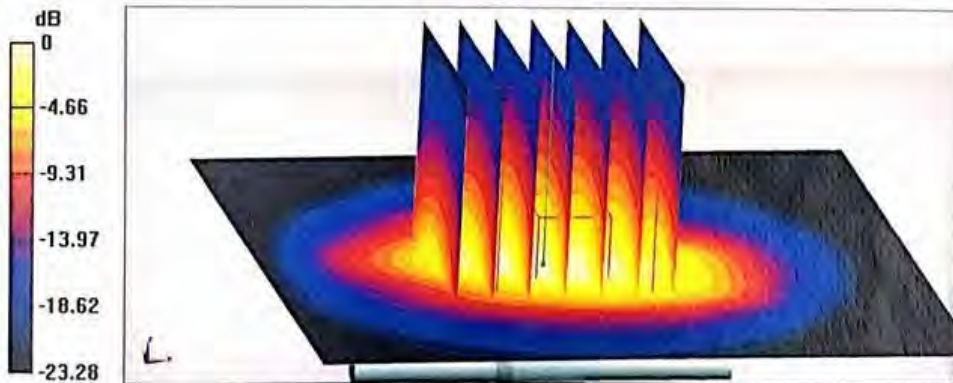

0 dB = 22.0 W/kg = 13.42 dBW/kg



In Collaboration with
s p e a g
CALIBRATION LABORATORY

Add: No.51 Xueyuan Road, Haidian District, Beijing, 100191, China
Tel: +86-10-62304633-2079 Fax: +86-10-62304633-2504
E-mail: cttl@chinattl.com http://www.chinattl.cn

Impedance Measurement Plot for Head TSL

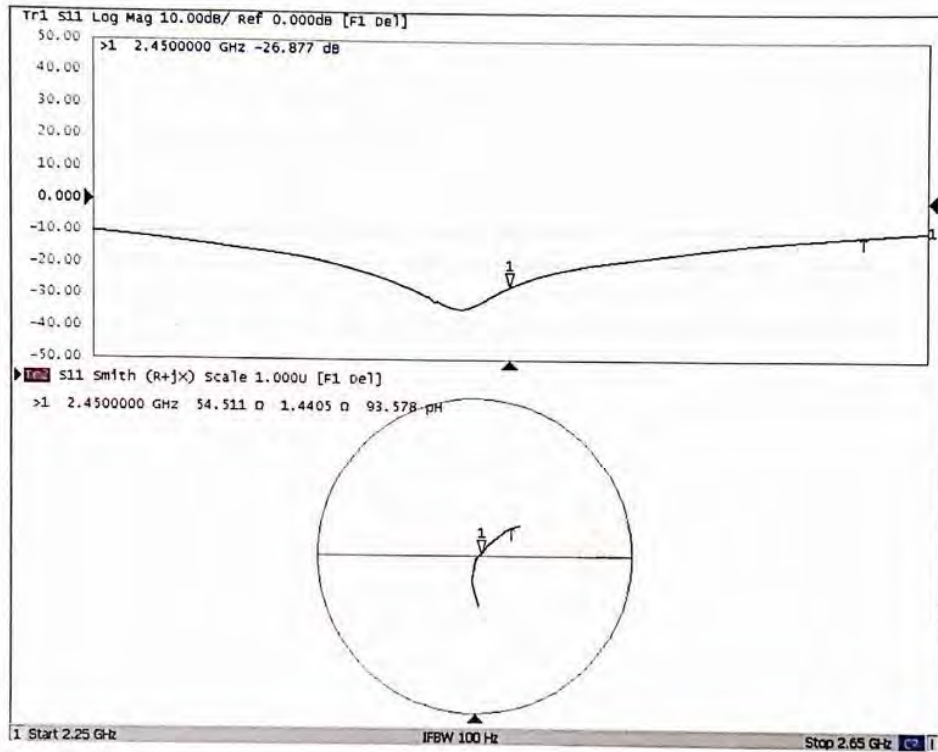



In Collaboration with
s p e a g
CALIBRATION LABORATORY

Add: No.51 Xueyuan Road, Haidian District, Beijing, 100191, China
Tel: +86-10-62304633-2079 Fax: +86-10-62304633-2504
E-mail: cttl@chinattl.com http://www.chinattl.cn

DASY5 Validation Report for Body TSL

Date: 08.27.2020

Test Laboratory: CTTL, Beijing, China

DUT: Dipole 2450 MHz; Type: D2450V2; Serial: D2450V2 - SN: 786

Communication System: UID 0, CW; Frequency: 2450 MHz; Duty Cycle: 1:1

Medium parameters used: $f = 2450$ MHz; $\sigma = 1.938$ S/m; $\epsilon_r = 52.06$; $\rho = 1000$ kg/m³

Phantom section: Right Section

DASY5 Configuration:

- Probe: EX3DV4 - SN3617; ConvF(7.76, 7.76, 7.76) @ 2450 MHz; Calibrated: 2020-01-30
- Sensor-Surface: 1.4mm (Mechanical Surface Detection)
- Electronics: DAE4 Sn771; Calibrated: 2020-02-10
- Phantom: MFP_V5.IC (20deg probe tilt); Type: QD 000 P51 Cx; Serial: 1062
- Measurement SW: DASY52, Version 52.10 (4); SEMCAD X Version 14.6.14 (7483)

Dipole Calibration/Zoom Scan (7x7x7) (7x7x7)/Cube 0: Measurement grid: dx=5mm, dy=5mm, dz=5mm

Reference Value = 102.9 V/m; Power Drift = -0.03 dB

Peak SAR (extrapolated) = 26.9 W/kg

SAR(1 g) = 13.1 W/kg; SAR(10 g) = 6.08 W/kg

Smallest distance from peaks to all points 3 dB below = 8.5 mm

Ratio of SAR at M2 to SAR at M1 = 49.9%

Maximum value of SAR (measured) = 21.8 W/kg

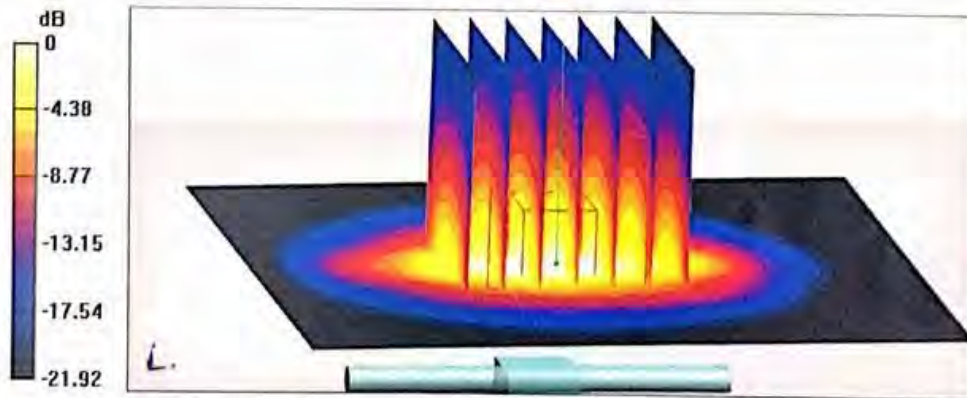

0 dB = 21.8 W/kg = 13.38 dBW/kg



In Collaboration with
s p e a g
CALIBRATION LABORATORY

Add: No.51 Xueyuan Road, Haidian District, Beijing, 100191, China
Tel: +86-10-62304633-2079 Fax: +86-10-62304633-2504
E-mail: cttl@chinattl.com http://www.chinattl.cn

Impedance Measurement Plot for Body TSL

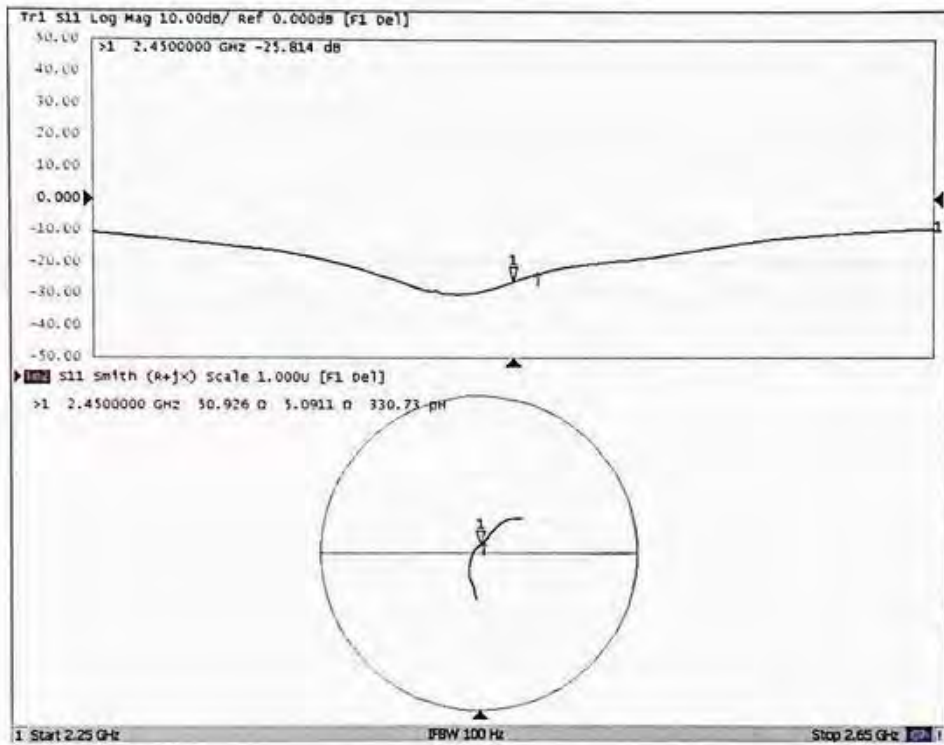



ANNEX J: D2600V2 Dipole Calibration Certificate



In Collaboration with
s p e a g
CALIBRATION LABORATORY

Add: No.52 HuaYuanBei Road, Haidian District, Beijing, 100191, Chi
Tel: +86-10-62304633-2079 Fax: +86-10-62304633-2504
E-mail: cntl@chinattl.com http://www.chinattl.cn



中国认可
国际互认
校准
CALIBRATION
CNAS L0570

Client TA(Shanghai)

Certificate No: Z21-60156

CALIBRATION CERTIFICATE

Object D2600V2 - SN: 1025

Calibration Procedure(s)
FF-Z11-003-01
Calibration Procedures for dipole validation kits

Calibration date: April 23, 2021

This calibration Certificate documents the traceability to national standards, which realize the physical units of measurements (SI). The measurements and the uncertainties with confidence probability are given on the following pages and are part of the certificate.

All calibrations have been conducted in the closed laboratory facility; environment temperature (22±3)°C and humidity<70%.

Calibration Equipment used (M&TE critical for calibration)

Primary Standards	ID #	Cal Date(Calibrated by, Certificate No.)	Scheduled Calibration
Power Meter NRP2	106276	12-May-20 (CTTL, No.J20X02965)	May-21
Power sensor NRP6A	101389	12-May-20 (CTTL, No.J20X02965)	May-21
Reference Probe EX3DV4	SN 3617	27-Jan-21(SPEAG,No.EX3-3617_Jan21)	Jan-22
DAE4	SN 777	08-Jan-21(CTTL-SPEAG,No.Z21-60003)	Jan-22
Secondary Standards	ID #	Cal Date(Calibrated by, Certificate No.)	Scheduled Calibration
Signal Generator E4438C	MY49071430	01-Feb-21 (CTTL, No.J21X00593)	Jan-22
Network Analyzer E5071C	MY46110673	14-Jan-21 (CTTL, No.J21X00232)	Jan-22

	Name	Function	Signature
Calibrated by:	Zhao Jing	SAR Test Engineer	
Reviewed by:	Lin Hao	SAR Test Engineer	
Approved by:	Qi Dianyuan	SAR Project Leader	

Issued: April 29, 2021

This calibration certificate shall not be reproduced except in full without written approval of the laboratory

Certificate No: Z21-60156

Page 1 of 6



In Collaboration with
s p e a g
CALIBRATION LABORATORY

Add: No.52 HuaYuanBei Road, Haidian District, Beijing, 100191, China
Tel: +86-10-62304633-2079 Fax: +86-10-62304633-2504
E-mail: ttl@chinattl.com http://www.chinattl.cn

Glossary:

TSL	tissue simulating liquid
ConvF	sensitivity in TSL / NORM _{x,y,z}
N/A	not applicable or not measured

Calibration is Performed According to the Following Standards:

- IEEE Std 1528-2013, "IEEE Recommended Practice for Determining the Peak Spatial-Averaged Specific Absorption Rate (SAR) in the Human Head from Wireless Communications Devices: Measurement Techniques", June 2013
- IEC 62209-1, "Measurement procedure for assessment of specific absorption rate of human exposure to radio frequency fields from hand-held and body-mounted wireless communication devices- Part 1: Device used next to the ear (Frequency range of 300MHz to 6GHz)", July 2016
- IEC 62209-2, "Procedure to measure the Specific Absorption Rate (SAR) For wireless communication devices used in close proximity to the human body (frequency range of 30MHz to 6GHz)", March 2010
- KDB865664, SAR Measurement Requirements for 100 MHz to 6 GHz

Additional Documentation:

- DASY4/5 System Handbook

Methods Applied and Interpretation of Parameters:

- Measurement Conditions:** Further details are available from the Validation Report at the end of the certificate. All figures stated in the certificate are valid at the frequency indicated.
- Antenna Parameters with TSL:** The dipole is mounted with the spacer to position its feed point exactly below the center marking of the flat phantom section, with the arms oriented parallel to the body axis.
- Feed Point Impedance and Return Loss:** These parameters are measured with the dipole positioned under the liquid filled phantom. The impedance stated is transformed from the measurement at the SMA connector to the feed point. The Return Loss ensures low reflected power. No uncertainty required.
- Electrical Delay:** One-way delay between the SMA connector and the antenna feed point. No uncertainty required.
- SAR measured:** SAR measured at the stated antenna input power.
- SAR normalized:** SAR as measured, normalized to an input power of 1 W at the antenna connector.
- SAR for nominal TSL parameters:** The measured TSL parameters are used to calculate the nominal SAR result.

The reported uncertainty of measurement is stated as the standard uncertainty of Measurement multiplied by the coverage factor $k=2$, which for a normal distribution corresponds to a coverage probability of approximately 95%.



In Collaboration with
s p e a g
CALIBRATION LABORATORY

Add: No.52 HuaYuanBei Road, Haidian District, Beijing, 100191, China
Tel: +86-10-62304633-2079 Fax: +86-10-62304633-2504
E-mail: cttj@chinattl.com http://www.chinattl.cn

Measurement Conditions

DASY system configuration, as far as not given on page 1

DASY Version	DASY52	V52.10.4
Extrapolation	Advanced Extrapolation	
Phantom	Triple Flat Phantom 5.1C	
Distance Dipole Center - TSL	10 mm	with Spacer
Zoom Scan Resolution	dx, dy, dz = 5 mm	
Frequency	2600 MHz ± 1 MHz	

Head TSL parameters

The following parameters and calculations were applied

	Temperature	Permittivity	Conductivity
Nominal Head TSL parameters	22.0 °C	39.0	1.96 mho/m
Measured Head TSL parameters	(22.0 ± 0.2) °C	39.9 ± 6 %	1.94 mho/m ± 6 %
Head TSL temperature change during test	<1.0 °C	—	—

SAR result with Head TSL

SAR averaged over 1 cm ³ (1 g) of Head TSL	Condition	
SAR measured	250 mW input power	13.9 W/kg
SAR for nominal Head TSL parameters	normalized to 1W	56.1 W/kg ± 18.8 % (k=2)
SAR averaged over 10 cm ³ (10 g) of Head TSL	Condition	
SAR measured	250 mW input power	6.10 W/kg
SAR for nominal Head TSL parameters	normalized to 1W	24.5 W/kg ± 18.7 % (k=2)



In Collaboration with
s p e a g
CALIBRATION LABORATORY

Add: No.52 HuaYuanBei Road, Haidian District, Beijing, 100191, China
Tel: +86-10-62304633-2079 Fax: +86-10-62304633-2504
E-mail: cttl@chinattl.com http://www.chinattl.cn

Appendix(Additional assessments outside the scope of CNAS L0570)

Antenna Parameters with Head TSL

Impedance, transformed to feed point	50.1Ω- 7.19jΩ
Return Loss	- 22.9dB

General Antenna Parameters and Design

Electrical Delay (one direction)	1.055 ns
----------------------------------	----------

After long term use with 100W radiated power, only a slight warming of the dipole near the feedpoint can be measured.

The dipole is made of standard semirigid coaxial cable. The center conductor of the feeding line is directly connected to the second arm of the dipole. The antenna is therefore short-circuited for DC-signals. On some of the dipoles, small end caps are added to the dipole arms in order to improve matching when loaded according to the position as explained in the "Measurement Conditions" paragraph. The SAR data are not affected by this change. The overall dipole length is still according to the Standard. No excessive force must be applied to the dipole arms, because they might bend or the soldered connections near the feedpoint may be damaged.

Additional EUT Data

Manufactured by	SPEAG
-----------------	-------



In Collaboration with
s p e a g
CALIBRATION LABORATORY

Add: No.52 HuaYunBei Road, Haidian District, Beijing, 100191, China
Tel: +86-10-62304633-2079 Fax: +86-10-62304633-2504
E-mail: entl@chinattl.com <http://www.chinattl.cn>

DASY5 Validation Report for Head TSL

Date: 04.23.2021

Test Laboratory: CTTL, Beijing, China

DUT: Dipole 2600 MHz; Type: D2600V2; Serial: D2600V2 - SN: 1025

Communication System: UFD 0, CW; Frequency: 2600 MHz; Duty Cycle: 1:1

Medium parameters used: $f = 2600$ MHz; $\sigma = 1.944$ S/m; $\epsilon_r = 39.94$; $\rho = 1000$ kg/m³

Phantom section: Center Section

DASY5 Configuration:

- Probe: EX3DV4 - SN3617; ConvF(7.55, 7.55, 7.55) @ 2600 MHz; Calibrated: 2021-01-27
- Sensor-Surface: 1.4mm (Mechanical Surface Detection)
- Electronics: DAE4 Sn777; Calibrated: 2021-01-08
- Phantom: MFP_V5.1C (20deg probe tilt); Type: QD 000 P51 Cx; Serial: 1062
- Measurement SW: DASY52, Version 52.10 (4); SEMCAD X Version 14.6.14 (7483)

Dipole Calibration/Zoom Scan (7x7x7) (7x7x7)/Cube 0; Measurement grid: dx=5mm, dy=5mm, dz=5mm

Reference Value = 101.1 V/m; Power Drift = -0.09 dB

Peak SAR (extrapolated) = 31.5 W/kg

SAR(1 g) = 13.9 W/kg; SAR(10 g) = 6.1 W/kg

Smallest distance from peaks to all points 3 dB below = 9 mm

Ratio of SAR at M2 to SAR at M1 = 44%

Maximum value of SAR (measured) = 24.4 W/kg

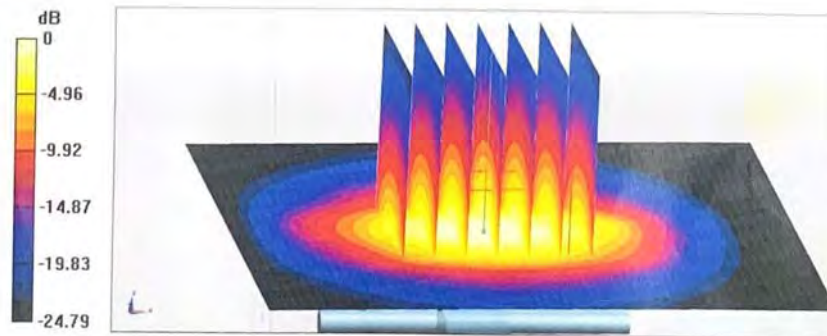

0 dB = 24.4 W/kg = 13.87 dBW/kg



In Collaboration with
s p e a g
CALIBRATION LABORATORY

Add: No.52 HuaYuanBei Road, Haidian District, Beijing, 100191, China
Tel: +86-10-62304633-2079 Fax: +86-10-62304633-2504
E-mail: cttl@chinatl.com http://www.chinatl.cn

Impedance Measurement Plot for Head TSL

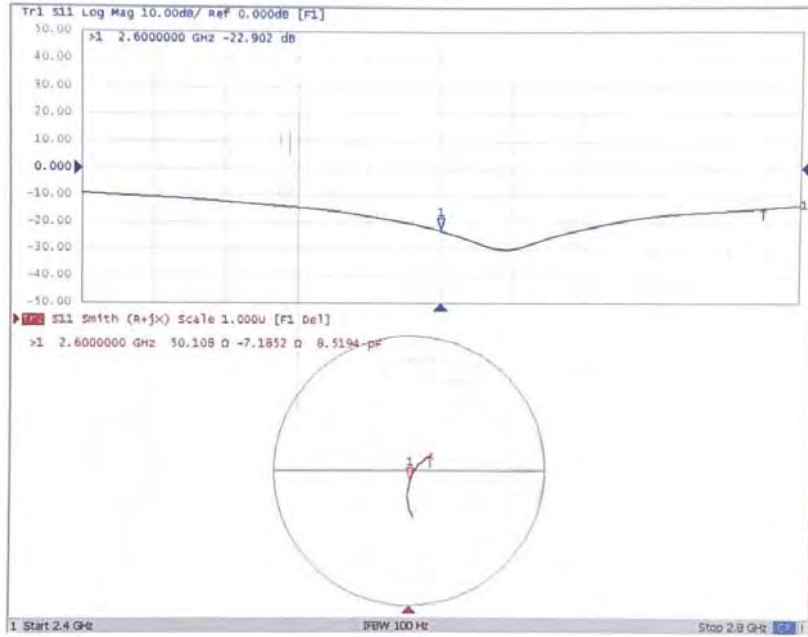

**ANNEX K: DAE4 Calibration Certificate (SN: 1692)**

**Calibration Laboratory of
Schmid & Partner
Engineering AG**
Zeughausstrasse 43, 8004 Zurich, Switzerland



S Schweizerischer Kalibrierdienst
C Service suisse d'étalonnage
S Servizio svizzero di taratura
S Swiss Calibration Service

Accredited by the Swiss Accreditation Service (SAS)
The Swiss Accreditation Service is one of the signatories to the EA
Multilateral Agreement for the recognition of calibration certificates

Accreditation No.: SCS 0108

Client **TA-SH (Auden)**Certificate No: **DAE4-1692_Oct21****CALIBRATION CERTIFICATE**Object **DAE4 - SD 000 D04 BO - SN: 1692**Calibration procedure(s) **QA CAL-06.v30
Calibration procedure for the data acquisition electronics (DAE)**Calibration date: **October 04, 2021**

This calibration certificate documents the traceability to national standards, which realize the physical units of measurements (SI).
The measurements and the uncertainties with confidence probability are given on the following pages and are part of the certificate.

All calibrations have been conducted in the closed laboratory facility: environment temperature (22 ± 3)°C and humidity < 70%.

Calibration Equipment used (M&TE critical for calibration)

Primary Standards	ID #	Cal Date (Certificate No.)	Scheduled Calibration
Keithley Multimeter Type 2001	SN: 0810278	31-Aug-21 (No:31368)	Aug-22
Secondary Standards	ID #	Check Date (in house)	Scheduled Check
Auto DAE Calibration Unit	SE UWS 053 AA 1001	07-Jan-21 (in house check)	In house check: Jan-22
Calibrator Box V2.1	SE UMS 006 AA 1002	07-Jan-21 (in house check)	In house check: Jan-22

Calibrated by:	Name Adrian Gehring	Function Laboratory Technician	Signature
Approved by:	Sven Kühn	Deputy Manager	

Issued: October 4, 2021

This calibration certificate shall not be reproduced except in full without written approval of the laboratory.

Calibration Laboratory of
Schmid & Partner
Engineering AG
Zeughausstrasse 43, 8004 Zurich, Switzerland



S Schweizerischer Kalibrierdienst
C Service suisse d'étalonnage
S Servizio svizzero di taratura
S Swiss Calibration Service

Accredited by the Swiss Accreditation Service (SAS)
The Swiss Accreditation Service is one of the signatories to the EA
Multilateral Agreement for the recognition of calibration certificates

Accreditation No.: SCS 0108

Glossary

DAE data acquisition electronics
Connector angle information used in DASY system to align probe sensor X to the robot coordinate system.

Methods Applied and Interpretation of Parameters

- **DC Voltage Measurement:** Calibration Factor assessed for use in DASY system by comparison with a calibrated instrument traceable to national standards. The figure given corresponds to the full scale range of the voltmeter in the respective range.
- **Connector angle:** The angle of the connector is assessed measuring the angle mechanically by a tool inserted. Uncertainty is not required.
- The following parameters as documented in the Appendix contain technical information as a result from the performance test and require no uncertainty.
 - **DC Voltage Measurement Linearity:** Verification of the Linearity at +10% and -10% of the nominal calibration voltage. Influence of offset voltage is included in this measurement.
 - **Common mode sensitivity:** Influence of a positive or negative common mode voltage on the differential measurement.
 - **Channel separation:** Influence of a voltage on the neighbor channels not subject to an input voltage.
 - **AD Converter Values with inputs shorted:** Values on the internal AD converter corresponding to zero input voltage
 - **Input Offset Measurement:** Output voltage and statistical results over a large number of zero voltage measurements.
 - **Input Offset Current:** Typical value for information; Maximum channel input offset current, not considering the input resistance.
 - **Input resistance:** Typical value for information; DAE input resistance at the connector, during internal auto-zeroing and during measurement.
 - **Low Battery Alarm Voltage:** Typical value for information. Below this voltage, a battery alarm signal is generated.
 - **Power consumption:** Typical value for information. Supply currents in various operating modes.

**DC Voltage Measurement**

A/D - Converter Resolution nominal

High Range: 1LSB = 6.1 μ V, full range = -100...+300 mV

Low Range: 1LSB = 61nV, full range = -1.....+3mV

DASY measurement parameters: Auto Zero Time: 3 sec; Measuring time: 3 sec

Calibration Factors	X	Y	Z
High Range	404.451 \pm 0.02% (k=2)	404.531 \pm 0.02% (k=2)	404.388 \pm 0.02% (k=2)
Low Range	3.95023 \pm 1.50% (k=2)	4.00333 \pm 1.50% (k=2)	3.97913 \pm 1.50% (k=2)

Connector Angle

Connector Angle to be used in DASY system	334.5 $^{\circ}$ \pm 1 $^{\circ}$
---	-------------------------------------

Appendix (Additional assessments outside the scope of SCS0108)

1. DC Voltage Linearity

High Range	Reading (μV)	Difference (μV)	Error (%)
Channel X + Input	199998.31	2.10	0.00
Channel X + Input	20004.35	2.07	0.01
Channel X - Input	-19997.45	4.22	-0.02
Channel Y + Input	199996.63	0.87	0.00
Channel Y + Input	20001.14	-1.08	-0.01
Channel Y - Input	-20002.28	-0.47	0.00
Channel Z + Input	199998.12	1.98	0.00
Channel Z + Input	20002.54	0.26	0.00
Channel Z - Input	-20001.19	0.53	-0.00

Low Range	Reading (μV)	Difference (μV)	Error (%)
Channel X + Input	2001.64	0.32	0.02
Channel X + Input	202.20	0.58	0.29
Channel X - Input	-197.54	0.78	-0.39
Channel Y + Input	1999.35	-1.87	-0.09
Channel Y + Input	200.36	-1.25	-0.62
Channel Y - Input	-199.29	-0.98	0.49
Channel Z + Input	2000.89	-0.32	-0.02
Channel Z + Input	200.91	-0.59	-0.29
Channel Z - Input	-199.57	-1.16	0.58

2. Common mode sensitivity

DASY measurement parameters: Auto Zero Time: 3 sec; Measuring time: 3 sec

	Common mode Input Voltage (mV)	High Range Average Reading (μV)	Low Range Average Reading (μV)
Channel X	200	15.85	13.56
	- 200	-12.16	-14.19
Channel Y	200	21.51	20.97
	- 200	-24.04	-24.35
Channel Z	200	-6.87	-7.13
	- 200	6.28	5.75

3. Channel separation

DASY measurement parameters: Auto Zero Time: 3 sec; Measuring time: 3 sec

	Input Voltage (mV)	Channel X (μV)	Channel Y (μV)	Channel Z (μV)
Channel X	200	-	-0.88	-2.39
Channel Y	200	6.27	-	2.31
Channel Z	200	8.86	3.02	-

**4. AD-Converter Values with Inputs shorted**

DASY measurement parameters: Auto Zero Time: 3 sec; Measuring time: 3 sec

	High Range (LSB)	Low Range (LSB)
Channel X	15949	15587
Channel Y	15899	16465
Channel Z	15625	15999

5. Input Offset MeasurementDASY measurement parameters: Auto Zero Time: 3 sec; Measuring time: 3 sec
Input 10M Ω

	Average (μ V)	min. Offset (μ V)	max. Offset (μ V)	Std. Deviation (μ V)
Channel X	1.24	-0.39	2.50	0.44
Channel Y	-0.70	-1.86	0.77	0.48
Channel Z	-0.23	-1.42	0.54	0.37

6. Input Offset Current

Nominal input circuitry offset current on all channels: <25fA

7. Input Resistance (Typical values for information)

	Zeroing (kOhm)	Measuring (MOhm)
Channel X	200	200
Channel Y	200	200
Channel Z	200	200

8. Low Battery Alarm Voltage (Typical values for information)

Typical values	Alarm Level (VDC)
Supply (+ Vcc)	+7.9
Supply (- Vcc)	-7.6

9. Power Consumption (Typical values for information)

Typical values	Switched off (mA)	Stand by (mA)	Transmitting (mA)
Supply (+ Vcc)	+0.01	+6	+14
Supply (- Vcc)	-0.01	-8	-9

**ANNEX L: DAE4 Calibration Certificate (SN: 1291)**

Add: No.52 HuaYuanBei Road, Haidian District, Beijing, 100191, China
 Tel: +86-10-62304633-2512 Fax: +86-10-62304633-2504
 E-mail: cttl@chinattl.com Http://www.chinattl.cn

Client : **TA(Shanghai)**Certificate No: **Z22-60098****CALIBRATION CERTIFICATE**Object **DAE4 - SN: 1291**

Calibration Procedure(s) **FF-Z11-002-01**
Calibration Procedure for the Data Acquisition Electronics (DAEx)

Calibration date: **March 24, 2022**

This calibration Certificate documents the traceability to national standards, which realize the physical units of measurements(SI). The measurements and the uncertainties with confidence probability are given on the following pages and are part of the certificate.

All calibrations have been conducted in the closed laboratory facility: environment temperature(22±3)°C and humidity<70%.

Calibration Equipment used (M&TE critical for calibration)

Primary Standards	ID #	Cal Date(Calibrated by, Certificate No.)	Scheduled Calibration
-------------------	------	--	-----------------------

Process Calibrator 753	1971018	15-Jun-21 (CTTL, No.J21X04465)	Jun-22
------------------------	---------	--------------------------------	--------

	Name	Function	Signature
Calibrated by:	Yu Zongying	SAR Test Engineer	
Reviewed by:	Lin Hao	SAR Test Engineer	
Approved by:	Qi Dianyuan	SAR Project Leader	

Issued: March 28, 2022

This calibration certificate shall not be reproduced except in full without written approval of the laboratory.

Certificate No: Z22-60098

Page 1 of 3



Add: No.52 HuaYuanBei Road, Haidian District, Beijing, 100191, China
Tel: +86-10-62304633-2512 Fax: +86-10-62304633-2504
E-mail: cttl@chinattl.com Http://www.chinattl.cn

Glossary:

DAE data acquisition electronics
Connector angle information used in DASY system to align probe sensor X to the robot coordinate system.

Methods Applied and Interpretation of Parameters:

- *DC Voltage Measurement:* Calibration Factor assessed for use in DASY system by comparison with a calibrated instrument traceable to national standards. The figure given corresponds to the full scale range of the voltmeter in the respective range.
- *Connector angle:* The angle of the connector is assessed measuring the angle mechanically by a tool inserted. Uncertainty is not required.
- The report provide only calibration results for DAE, it does not contain other performance test results.



Add: No.52 HuaYuanBei Road, Haidian District, Beijing, 100191, China
Tel: +86-10-62304633-2512 Fax: +86-10-62304633-2504
E-mail: cttl@chinattl.com Http://www.chinattl.cn

DC Voltage Measurement

A/D - Converter Resolution nominal
High Range: 1LSB = 6.1μV, full range = -100...+300 mV
Low Range: 1LSB = 61nV, full range = -1.....+3mV
DASY measurement parameters: Auto Zero Time: 3 sec; Measuring time: 3 sec

Calibration Factors	X	Y	Z
High Range	402.577 ± 0.15% (k=2)	403.249 ± 0.15% (k=2)	403.164 ± 0.15% (k=2)
Low Range	3.97371 ± 0.7% (k=2)	3.97778 ± 0.7% (k=2)	3.97281 ± 0.7% (k=2)

Connector Angle

Connector Angle to be used in DASY system	167° ± 1 °
---	------------



ANNEX M: The EUT Appearance

The EUT Appearance are submitted separately.



ANNEX N: Test Setup Photos

The Test Setup Photos are submitted separately.



ANNEX O: Product Change Description (Variant 1)

The Product Change Description are submitted separately.



ANNEX P: Product Change Description (Variant 2)

The Product Change Description are submitted separately.