



RF TEST REPORT

Applicant Xiaomi Communications Co., Ltd.
FCC ID 2AFZZ33SG
Product Mobile Phone
Brand Redmi
Model 220733SG
Report No. R2207A0665-R3
Issue Date August 16, 2022

TA Technology (Shanghai) Co., Ltd. tested the above equipment in accordance with the requirements in **FCC CFR47 Part 2 (2021)/ FCC CFR47 Part 27C (2021)**. The test results show that the equipment tested is capable of demonstrating compliance with the requirements as documented in this report.

Prepared by: Xu Ying

Approved by: Xu Kai

TA Technology (Shanghai) Co., Ltd.

Building 3, No.145, Jintang Rd, Tangzhen Industry Park, Pudong Shanghai, China

TEL: +86-021-50791141/2/3

FAX: +86-021-50791141/2/3-8000



TABLE OF CONTENT

1	Test Laboratory	4
1.1	Notes of the Test Report	4
1.2.	Test facility	4
1.3	Testing Location	4
2	General Description of Equipment under Test	5
2.1	Applicant and Manufacturer Information	5
2.2	General information	5
3	Applied Standards	7
4	Test Configuration	8
5	Test Case	10
5.1	RF Power Output and Effective Isotropic Radiated Power	10
5.2	Occupied Bandwidth	11
5.3	Band Edge Compliance	12
5.4	Peak-to-Average Power Ratio (PAPR)	14
5.5	Frequency Stability	15
5.6	Spurious Emissions at Antenna Terminals	16
5.7	Radiates Spurious Emission	18
6	Test Results	21
6.1	RF Power Output and Effective Isotropic Radiated Power	21
6.2	Occupied Bandwidth	31
6.3	Band Edge Compliance	46
6.4	Peak-to-Average Power Ratio (PAPR)	62
6.5	Frequency Stability	65
6.6	Spurious Emissions at Antenna Terminals	70
6.7	Radiates Spurious Emission	76
7	Main Test Instruments	82
	ANNEX A: The EUT Appearance	83
	ANNEX B: Test Setup Photos	84
	ANNEX C: Product Change Description (Variant 1)	85
	ANNEX D: Product Change Description (Variant 2)	86



Summary of Measurement Results

Number	Test Case	Clause in FCC rules	Verdict
1	RF Power Output and Effective Isotropic Radiated Power	2.1046 /27.50(d)(4) /27.50(h)(2)	PASS
2	Occupied Bandwidth	2.1049	PASS
3	Band Edge Compliance	27.53(h) /27.53(m)	PASS
4	Peak-to-Average Power Ratio	27.50(d)/KDB971168 D01(5.7)	PASS
5	Frequency Stability	2.1055 / 27.54	PASS
6	Spurious Emissions at Antenna Terminals	2.1051 /27.53(h) /27.53(m)	PASS
7	Radiates Spurious Emission	2.1053 /27.53(h) /27.53(m)	PASS

Date of Testing: June 20, 2022 ~ July 2, 2022

Date of Sample Received: June 16, 2022

Note: PASS: The EUT complies with the essential requirements in the standard.

FAIL: The EUT does not comply with the essential requirements in the standard.

All indications of Pass/Fail in this report are opinions expressed by TA Technology (Shanghai) Co., Ltd. based on interpretations and/or observations of test results. Measurement Uncertainties were not taken into account and are published for informational purposes only.

220733SG (Report No.: R2207A0665-R3) is a variant model (Variant 2) of 220733SL (Report No.: R2206A0534-R3). There is only added the 2nd supplier PA of product. There is only verified are power and Radiates Spurious Emission worst Band (LTE Band 7), and did not worsen, so they were not recorded in the report. Test values all duplicated from Original for variant.

The detailed product change description please refers to the *Difference Declaration Letter*.

220733SG (Report No.: R2206A0534-R3) is a variant model (Variant 1) of 220733SL (Report No.: R2206A0532-R3). There is only verified power and tested Radiates Spurious Emission (LTE Band 7), and did not worsen, so they were not recorded in the report. Test values all duplicated from Original for variant .The detailed product change description please refers to following table:

/	Original	Variant
Model	220733SL	220733SG
Band	GSM:B2/3/5/8; WCDMA:B1/2/4/5/8; LTE FDD:B1/2/3/4/5/7/8/28; LTE TDD:B38/41(2496-2690MHz);	GSM: B2/3/5/8; WCDMA: B1/5/8; LTE FDD: B1/3/5/7/8/20/28; LTE FDD: B38/41(2496-2690MHz);
Others	The same	

The detailed product change description please refers to the *Difference Declaration Letter*.



1 Test Laboratory

1.1 Notes of the Test Report

This report shall not be reproduced in full or partial, without the written approval of **TA technology (shanghai) co., Ltd.** The results documented in this report apply only to the tested sample, under the conditions and modes of operation as described herein .Measurement Uncertainties were not taken into account and are published for informational purposes only. This report is written to support regulatory compliance of the applicable standards stated above.

1.2. Test facility

FCC (Designation number: CN1179, Test Firm Registration Number: 446626)

TA Technology (Shanghai) Co., Ltd. has been listed on the US Federal Communications Commission list of test facilities recognized to perform measurements.

A2LA (Certificate Number: 3857.01)

TA Technology (Shanghai) Co., Ltd. has been listed by American Association for Laboratory Accreditation to perform measurement.

1.3 Testing Location

Company: TA Technology (Shanghai) Co., Ltd.
Address: Building 3, No.145, Jintang Rd, Tangzhen Industry Park, Pudong Shanghai, China
City: Shanghai
Post code: 201201
Country: P. R. China
Contact: Xu Kai
Telephone: +86-021-50791141/2/3
Fax: +86-021-50791141/2/3-8000
Website: <http://www.ta-shanghai.com>
E-mail: xukai@ta-shanghai.com

2 General Description of Equipment under Test

2.1 Applicant and Manufacturer Information

Applicant	Xiaomi Communications Co., Ltd.
Applicant address	019, 9th Floor, Building 6, 33 Xi'erqi Middle Road, Haidian District, Beijing, China, 100085
Manufacturer	Xiaomi Communications Co., Ltd.
Manufacturer address	#019, 9th Floor, Building 6, 33 Xi'erqi Middle Road, Haidian District, Beijing, China, 100085

2.2 General information

EUT Description			
Model	220733SG		
IMEI:	Original (220733SL)	IMEI 1: 869674060125087 IMEI 2: 869674060125095	
	Variant 1 (220733SG)	IMEI 1: 866681060023629 IMEI 2: 866681060023637	
	Variant 2(220733SG)	IMEI 1: 866681060035128 IMEI 2: 866681060035136	
Hardware Version	P1.1		
Software Version	Android 12		
Antenna Type	PIFA Antenna		
Antenna Gain	Band	Low Antenna	Upper Antenna
	LTE Band 7	-0.9 dBi	-0.1 dBi
	LTE Band 38	-1.9 dBi	0.2 dBi
	LTE Band 41	-0.9 dBi	1.1 dBi
Test Mode(s)	LTE Band 7/38/41;		
Test Modulation	(LTE) QPSK, 16QAM;		
LTE Category	4		
	LTE Band 7:	23.90 dBm	
	LTE Band 38:	24.12 dBm	
	LTE Band 41:	24.96 dBm	
Rated Power Supply Voltage	3.85V		
Operating Voltage	Minimum: 3.6V Maximum: 4.4V		
Operating Temperature	Lowest: 0°C Highest: +40°C		
Testing Temperature	Lowest: -30°C Highest: +50°C		
Operating Frequency Range(s)	Mode	Tx (MHz)	Rx (MHz)
	LTE Band 7	2500 ~ 2570	2620 ~ 2690
	LTE Band 38	2570 ~ 2620	2570 ~ 2620



	LTE Band 41	2496 ~ 2690	2496 ~ 2690
Note: 1. The EUT is sent from the applicant to TA and the information of the EUT is declared by the applicant. 2. Low antenna and Upper antenna can't transmit simultaneously.			

Item	Configure 1	Configure 2
WIFI test socket	support	remove
PL sensor	support	remove
Note: This report only records data for Configure 1.		



3 Applied Standards

According to the specifications of the manufacturer, it must comply with the requirements of the following standards:

Test standards:

FCC CFR47 Part 27C (2021)

FCC CFR47 Part 2 (2021)

Reference standard:

ANSI C63.26-2015

KDB 971168 D01 Power Meas License Digital Systems v03r01

4 Test Configuration

There is more than one SIM card slot, each one should be applied throughout the compliance test respectively, and however, only the worst case (SIM 1) will be recorded in this report

Radiated measurements are performed by rotating the EUT in three different orthogonal test planes. EUT stand-up position (Z axis), lie-down position (X, Y axis). Receiver antenna polarization (horizontal and vertical), the worst emission was found in position (X axis, horizontal polarization for Low Antenna LTE Band; X axis, horizontal polarization for Upper Antenna LTE Band) and the worst case was recorded.

All mode and data rates and positions and RB size and modulations were investigated.

Subsequently, only the worst case emissions are reported.

The following testing in LTE is set based on the maximum RF Output Power.

The following testing in different Bandwidth is set to detail in the following table:

Test modes are chosen to be reported as the worst case configuration below for LTE Band 7/38/41:

Test items	Modes	Bandwidth (MHz)						Modulation		RB			Test Channel		
		1.4	3	5	10	15	20	QPSK	16QAM	1	50%	100%	L	M	H
RF Power Output and Effective Isotropic Radiated Power	LTE 7	-	-	0	0	0	0	0	0	0	0	0	0	0	0
	LTE 38	-	-	0	0	0	0	0	0	0	0	0	0	0	0
	LTE 41	-	-	0	0	0	0	0	0	0	0	0	0	0	0
Occupied Bandwidth	LTE 7	-	-	0	0	0	0	0	0	-	-	0	0	0	0
	LTE 38	-	-	0	0	0	0	0	0	-	-	0	0	0	0
	LTE 41	-	-	0	0	0	0	0	0	-	-	0	0	0	0
Band Edge Compliance	LTE 7	-	-	0	0	0	0	0	0	0	-	0	0	-	0
	LTE 38	-	-	0	0	0	0	0	0	0	-	0	0	-	0
	LTE 41	-	-	0	0	0	0	0	0	0	-	0	0	-	0
Peak-to-Average Power Ratio	LTE 7	-	-	0	0	0	0	0	0	-	-	0	0	0	0
	LTE 38	-	-	0	0	0	0	0	0	-	-	0	0	0	0
	LTE 41	-	-	0	0	0	0	0	0	-	-	0	0	0	0
Frequency Stability	LTE 7	-	-	0	0	0	0	0	0	0	-	-	-	0	-
	LTE 38	-	-	0	0	0	0	0	0	0	-	-	-	0	-
	LTE 41	-	-	0	0	0	0	0	0	0	-	-	-	0	-
Spurious Emissions at Antenna Terminals	LTE 7	-	-	0	0	0	0	0	-	0	-	-	0	0	0
	LTE 38	-	-	0	0	0	0	0	-	0	-	-	0	0	0
	LTE 41	-	-	0	0	0	0	0	-	0	-	-	0	0	0
Radiates	LTE 7	-	-	0	-	-	0	0	-	0	-	-	-	0	-



Spurious	LTE 38	-	-	O	-	-	O	O	-	O	-	-	-	O	-
Emission	LTE 41	-	-	O	-	-	O	O	-	O	-	-	-	O	-
Note	1. The mark "O" means that this configuration is chosen for testing. 2. The mark "-" means that this configuration is not testing.														

5 Test Case

5.1 RF Power Output and Effective Isotropic Radiated Power

Ambient condition

Temperature	Relative humidity	Pressure
23°C ~25°C	45%~50%	101.5kPa

Methods of Measurement

During the process of the testing, The EUT was connected to the Base Station Simulator with a known loss. The EUT is controlled by the Base Station Simulator test set to ensure max power transmission with proper modulation.

ERP can then be calculated as follows:

$$\text{EIRP (dBm)} = \text{Output Power (dBm)} - \text{Losses (dB)} + \text{Antenna Gain (dBi)}$$

where:dBd refers to gain relative to an ideal dipole.

$$\text{EIRP (dBm)} = \text{ERP (dBm)} + 2.15 \text{ (dB.)}$$

Test Setup

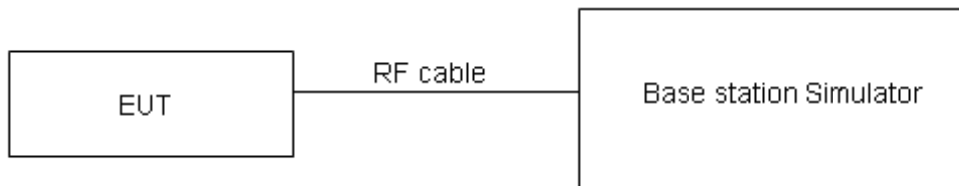

Limits

No specific RF power output requirements in part 2.1046.

Rule Part 27.50(d) (4) specifies that “Fixed, mobile and portable (hand-held) stations operating in the 1710–1755 MHz band are limited to 1 watt EIRP”

Rule Part 27.50(h) (2) specifies that “Mobile and other user stations. Mobile stations are limited to 2.0 watts EIRP. All user stations are limited to 2.0 watts transmitter output power.”

Part 27.50(d)(4)Limit	≤ 1 W (30 dBm)
Part 27.50(h)(2) Limit	≤ 2 W (33 dBm)

Measurement Uncertainty

The assessed measurement uncertainty to ensure 95% confidence level for the normal distribution is with the coverage factor $k = 2$, $U=0.4$ dB for RF power output, $k = 2$, $U= 1.19$ dB for ERP/EIRP.

Test Results

Refer to the section 6.1 of this report for test data.

5.2 Occupied Bandwidth

Ambient condition

Temperature	Relative humidity	Pressure
23°C ~25°C	45%~50%	101.5kPa

Method of Measurement

The EUT was connected to Spectrum Analyzer and Base Station Simulator via power Splitter. The occupied bandwidth is measured using spectrum analyzer.

RBW is set to $\geq 1\%EBW$, VBW is set to 3x RBW.

99% power and -26dBc occupied bandwidths are recorded. Spectrum analyzer plots are included on the following pages.

Test Setup

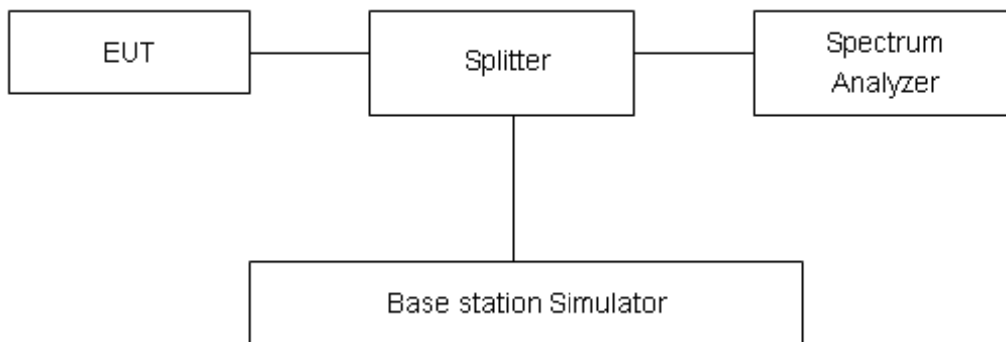

Limits

No specific occupied bandwidth requirements in part 2.1049.

Measurement Uncertainty

The assessed measurement uncertainty to ensure 95% confidence level for the normal distribution is with the coverage factor $k = 2$, $U=624\text{Hz}$.

Test Results

Refer to the section 6.2 of this report for test data.

5.3 Band Edge Compliance

Ambient condition

Temperature	Relative humidity	Pressure
23°C ~25°C	45%~50%	101.5kPa

Method of Measurement

The EUT was connected to Spectrum Analyzer and Base Station Simulator via power Splitter. The band edge of the lowest and highest channels were measured.

The testing follows KDB 971168 D01 v03r01 Section 6.0

The EUT was connected to spectrum analyzer and system simulator via a power divider.

The band edges of low and high channels for the highest RF powers were measured.

For LTE Band 7/38 set RBW \geq 1% EBW in the 1MHz band immediately outside and adjacent to the band edge. Beyond the 1 MHz band from the band edge, RBW=1MHz was used.

For LTE Band 41 the middle channel, high channel set RBW \geq 1% EBW in the 1MHz band immediately outside and adjacent to the band edge. Beyond the 1 MHz band from the band edge, RBW=1MHz was used; Low channel set RBW \geq 2% EBW in the 1MHz band immediately outside and adjacent to the band edge. Beyond the 1 MHz band from the band edge, RBW=1MHz was used. RBW is set to \geq 1%EBW, VBW is set to 3x RBW.

on spectrum analyzer.

Set spectrum analyzer with RMS detector.

The RF fundamental frequency should be excluded against the limit line in the operating frequency band.

Checked that all the results comply with the emission limit line.

Test Setup

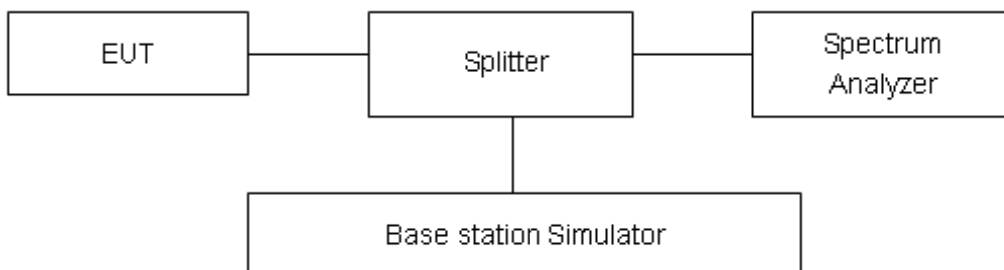

Limits

Rule Part 27.53(i) By a factor of not less than 43 + 10 log (P) dB on all frequencies between 2305 and 2320 MHz.

Rule Part 27.53(h) specifies that “ for operations in the 1695-1710 MHz, 1710-1755 MHz, 1755-1780 MHz, 1915-1920 MHz, 1995-2000 MHz, 2000-2020 MHz, 2110-2155 MHz, 2155-2180 MHz, and 2180-2200 bands, the power of any emission outside a licensee’s frequency block shall be



attenuated below the transmitter power (P) in watts by at least $43 + 10 \log_{10}(P)$ dB”

Rule Part 27.53(m) (4) specifies that “for BRS and EBS stations. For mobile digital stations, the attenuation factor shall be not less than $40 + 10 \log(P)$ dB on all frequencies between the channel edge and 5 megahertz from the channel edge, $43 + 10 \log(P)$ dB on all frequencies between 5 megahertz and X megahertz from the channel edge, and $55 + 10 \log(P)$ dB on all frequencies more than X megahertz from the channel edge, where X is the greater of 6 megahertz or the actual emission bandwidth as defined in paragraph (m)(4) of this section. In addition, the attenuation factor shall not be less than $43 + 10 \log(P)$ dB on all frequencies between 2490.5 MHz and 2496 MHz and $55 + 10 \log(P)$ dB at or below 2490.5 MHz. Mobile Satellite Service licensees operating on frequencies below 2495 MHz may also submit a documented interference complaint against BRS licensees operating on channel BRS Channel 1 on the same terms and conditions as adjacent channel BRS or EBS licensees.

Example:

The limit line is derived from $43 + 10 \log(P)$ dB below the transmitter power P(Watts)

= P(W) - $[43 + 10 \log(P)]$ (dB)

= $[30 + 10 \log(P)]$ (dBm) - $[43 + 10 \log(P)]$ (dB) = -13dBm.

Measurement Uncertainty

The assessed measurement uncertainty to ensure 95% confidence level for the normal distribution is with the coverage factor $k = 1.96$, $U = 0.684$ dB.

Test Results

Refer to the section 6.3 of this report for test data.

5.4 Peak-to-Average Power Ratio (PAPR)

Ambient condition

Temperature	Relative humidity	Pressure
23°C ~25°C	45%~50%	101.5kPa

Methods of Measurement

Measure the total peak power and record as PPk. And measure the total average power and record as PAvg. Both the peak and average power levels must be expressed in the same logarithmic units (e.g., dBm). Determine the PAPR from:

$$PAPR (dB) = PPk (dBm) - PAvg (dBm).$$

Test Setup

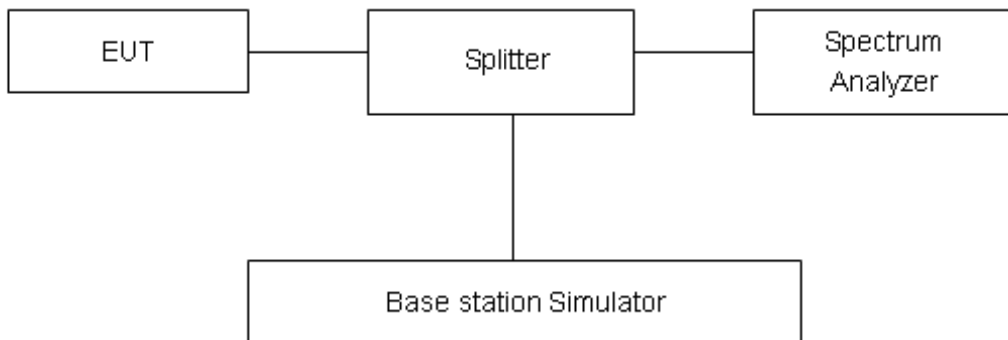

Limits

Rule Part 27.50(d)(5) Equipment employed must be authorized in accordance with the provisions of 24.51. Power measurements for transmissions by stations authorized under this section may be made either in accordance with a Commission-approved average power technique or in compliance with paragraph (d)(6) of this section. In measuring transmissions in this band using an average power technique, the peak-to-average ratio (PAR) of the transmission may not exceed 13 dB.

Measurement Uncertainty

The assessed measurement uncertainty to ensure 95% confidence level for the normal distribution is with the coverage factor $k = 2$, $U = 0.4$ dB.

Test Results

Refer to the section 6.4 of this report for test data.

5.5 Frequency Stability

Ambient condition

Temperature	Relative humidity	Pressure
23°C ~25°C	45%~50%	101.5kPa

Method of Measurement

Frequency Stability (Temperature Variation)

The temperature inside the climate chamber is varied from -30°C to +50°C in 10°C step size.

(1)With all power removed, the temperature was decreased to -10°C and permitted to stabilize for three hours.

(2)Measure the carrier frequency with the test equipment in a “call mode”. These measurements should be made within 1 minute of powering up the mobile station, to prevent significant self warming.

(3) Repeat the above measurements at 10°C increments from -30°C to +50°C. Allow at least 1.5 hours at each temperature, un-powered, before making measurements.

Frequency Stability (Voltage Variation)

The frequency stability shall be measured with variation of primary supply voltage as follows:

Primary Supply Voltage: The primary supply voltage is varied from 85% to 115% of the nominal value for non hand-carried battery and AC powered equipment. For hand-carried, battery-powered equipment, primary supply voltage is reduced to the battery operating end point which shall be specified by the manufacturer.

This transceiver is specified to operate with an input voltage of between 3.6 V and 4.4 V, with a nominal voltage of 3.85V.

Test setup

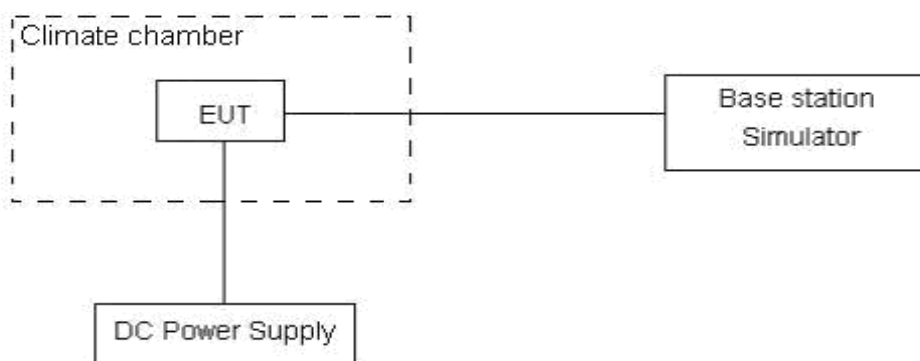

Limits

The frequency stability shall be sufficient to ensure that the fundamental emissions stay within the authorized bands of operation.

Measurement Uncertainty

The assessed measurement uncertainty to ensure 99.75% confidence level for the normal distribution is with the coverage factor $k = 3, U=0.01\text{ppm}$.

Test Results

Refer to the section 6.5 of this report for test data.

5.6 Spurious Emissions at Antenna Terminals

Ambient condition

Temperature	Relative humidity	Pressure
23°C ~25°C	45%~50%	101.5kPa

Method of Measurement

The EUT was connected to Spectrum Analyzer and Base Station Simulator via power Splitter. The measurement is carried out using a spectrum analyzer. The spectrum analyzer scans from 9kHz to the 10th harmonic of the carrier. The peak detector is used.

RBW is set to 100kHz, VBW is set to 300kHz for 30MHz~1GHz

RBW is set to 1MHz, VBW is set to 3MHz for above 1GHz, Sweep is set to ATUO.

RBW is set to 1 kHz (0.009MHz~ 0.15 MHz),

RBW is set to 10 kHz (0.15 MHz~ 30 MHz)

RBW is set to 100 kHz (30MHz~1000 MHz)

RBW is set to 1000 kHz (above 1000MHz)

Of those disturbances below (limit – 20 dB), the mark is not required for the EUT.

The modulation mode and RB allocation refer to section 5.1, using the maximum output power configuration.

Test setup

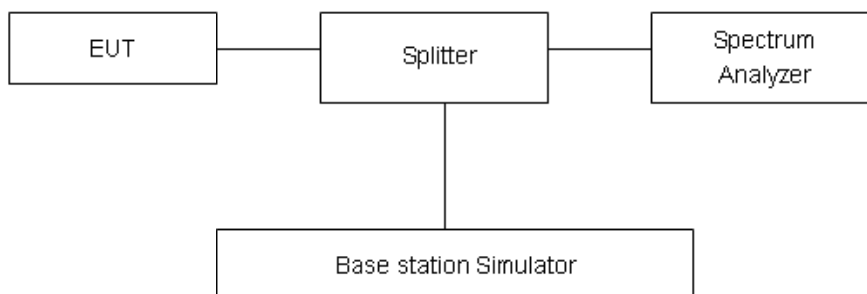

Limits

Rule Part 27.53(h) specifies that “for operations in the 1695-1710 MHz, 1710-1755 MHz, 1755-1780 MHz, 1915-1920 MHz, 1995-2000 MHz, 2000-2020 MHz, 2110-2155 MHz, 2155-2180 MHz, and 2180-2200 bands, the power of any emission outside a licensee's frequency block shall be attenuated below the transmitter power (P) in watts by at least $43 + 10 \log_{10}(P)$ dB..”

Rule Part 27.53(m) $55 + 10 \log(P)$ dB on all frequencies more than X megahertz from the channel edge, where X is the greater of 6 megahertz or the actual emission bandwidth as defined in paragraph (m)(4) of this section.

Part 27.53(h) Limit	-13 dBm
Part 27.53(m) Limit	-25 dBm



Measurement Uncertainty

The assessed measurement uncertainty to ensure 99.75% confidence level for the normal distribution is with the coverage factor $k = 1.96$.

Frequency	Uncertainty
9kHz-1GHz	0.684 dB
1GHz-30GHz	1.407 dB

Test Results

Refer to the section 6.6 of this report for test data.

5.7 Radiates Spurious Emission

Ambient condition

Temperature	Relative humidity	Pressure
23°C ~25°C	45%~50%	101.5kPa

Method of Measurement

- The testing follows FCC KDB 971168 D01 v03r01 Section 5.8 and ANSI C63.26-2015.
- Below 1GHz: The EUT is placed on a turntable 0.8 meters above the ground in the chamber, 3 meter away from the antenna. The maximal emission value is acquired by adjusting the antenna height, polarisation and turntable azimuth. Normally, the height range of antenna is 1 m to 4 m, the azimuth range of turntable is 0° to 360°, and the receive antenna has two polarizations Vertical (V) and Horizontal (H). Above 1GHz: (Note: the FCC's permission to use 1.5m as an alternative per TCBC Conf call of Dec. 2, 2014.) The EUT is placed on a turntable 1.5 meters above the ground in the chamber, 3 meter away from the antenna. The maximal emission value is acquired by adjusting the antenna height, polarisation and turntable azimuth. Normally, the height range of antenna is 1 m to 4 m, the azimuth range of turntable is 0° to 360°, and the receive antenna has two polarizations Vertical (V) and Horizontal (H).
- A loop antenna, A log-periodic antenna or horn antenna shall be substituted in place of the EUT. The log-periodic antenna will be driven by a signal generator and the level will be adjusted till the same power value on the spectrum analyzer or receiver. The level of the spurious emissions can be calculated through the level of the signal generator, cable loss, the gain of the substitution antenna and the reading of the spectrum analyzer or receiver.
- The EUT is then put into continuously transmitting mode at its maximum power level during the test. Set Test Receiver or Spectrum RBW=100kHz, VBW=300kHz for 30MHz to 1GHz and RBW=1MHz, VBW=3MHz for above 1GHz, and the maximum value of the receiver should be recorded as (Pr).
- The EUT shall be replaced by a substitution antenna. In the chamber, an substitution antenna for the frequency band of interest is placed at the reference point of the chamber. An RF Signal source for the frequency band of interest is connected to the substitution antenna with a cable that has been constructed to not interfere with the radiation pattern of the antenna. A power (PMea) is applied to the input of the substitution antenna, and adjust the level of the signal generator output until the value of the receiver reach the previously recorded (Pr). The power of signal source (PMea) is recorded. The test should be performed by rotating the test item and adjusting the receiving antenna polarization.
- A amplifier should be connected to the Signal Source output port. And the cable should be connect between the Amplifier and the Substitution Antenna. The cable loss (Pcl) ,the Substitution Antenna Gain (Ga) and the Amplifier Gain (PAg) should be recorded after test.
- The measurement results are obtained as described below:

$$\text{Power(EIRP)} = \text{PMea} - \text{PAg} - \text{Pcl} + \text{Ga}$$
 The measurement results are amend as described below:

$$\text{Power(EIRP)} = \text{PMea} - \text{Pcl} + \text{Ga}$$
- This value is EIRP since the measurement is calibrated using an antenna of known gain (2.15 dB) and known input power. ERP can be calculated from EIRP by subtracting the gain of the dipole, $\text{ERP} = \text{EIRP} - 2.15\text{dB}$.

The modulation mode and RB allocation refer to section 5.1, using the maximum output power configuration.

Test setup

9KHz~ 30MHz

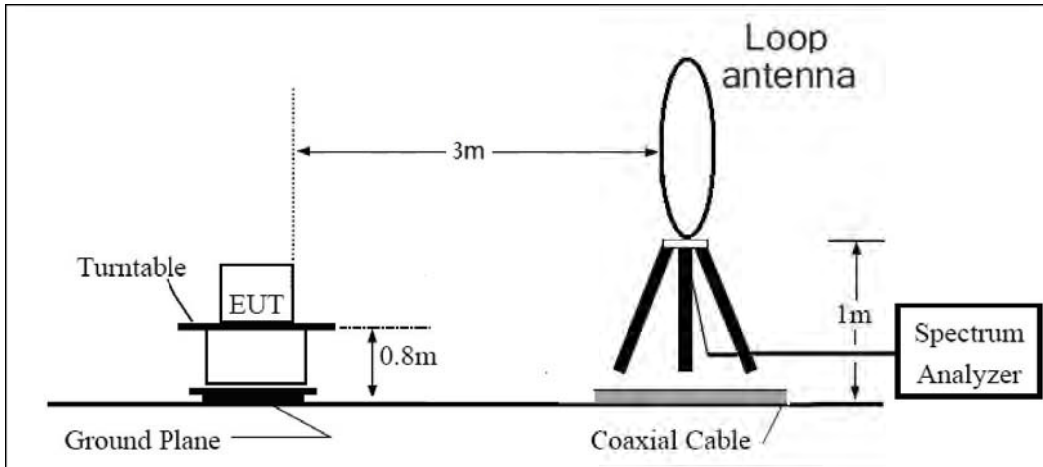

30MHz~ 1GHz

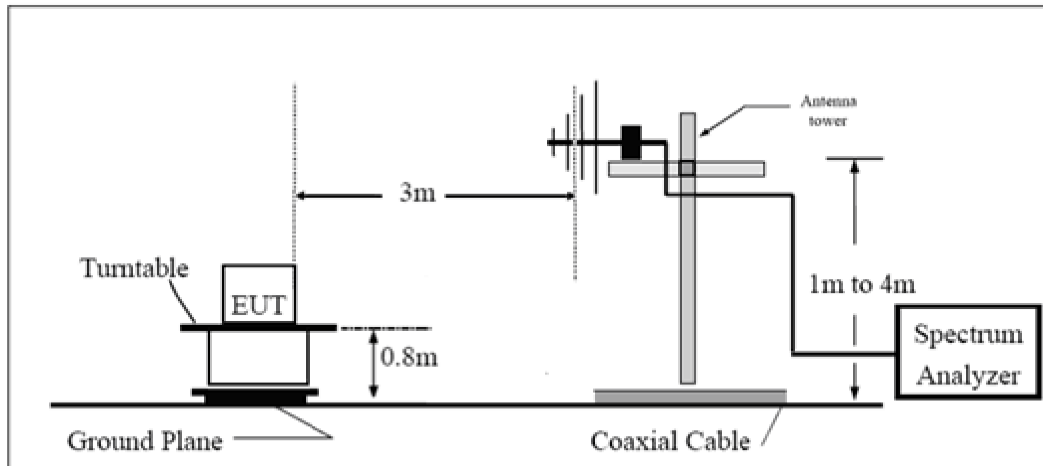

Above 1GHz

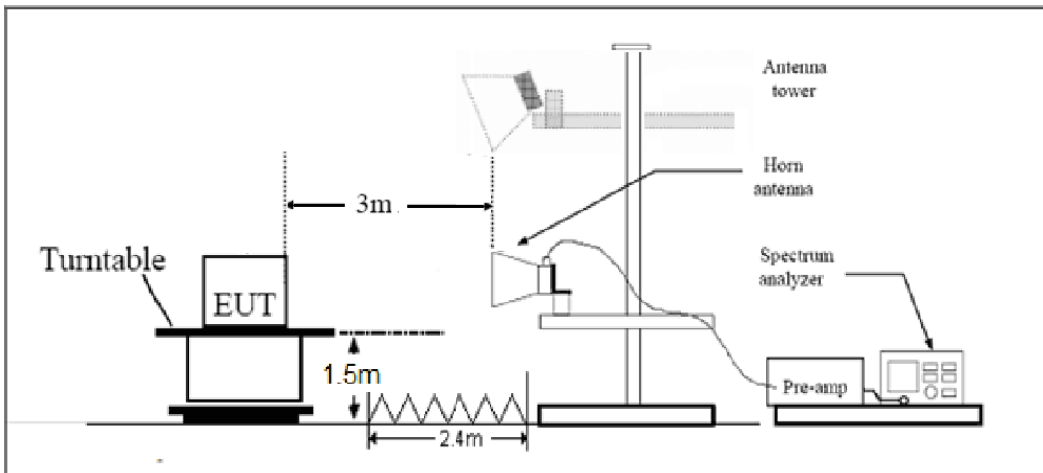

Note: Area side:2.4mX3.6m



Limits

Rule Part 27.53(h) specifies that “for operations in the 1695-1710 MHz, 1710-1755 MHz, 1755-1780 MHz, 1915-1920 MHz, 1995-2000 MHz, 2000-2020 MHz, 2110-2155 MHz, 2155-2180 MHz, and 2180-2200 bands, the power of any emission outside a licensee's frequency block shall be attenuated below the transmitter power (P) in watts by at least $43 + 10 \log_{10}(P)$ dB.”

Rule Part 27.53(m) $55 + 10 \log(P)$ dB on all frequencies more than X megahertz from the channel edge, where X is the greater of 6 megahertz or the actual emission bandwidth as defined in paragraph (m)(4) of this section.

Part 27.53(h) Limit	-13 dBm
Part 27.53(m) Limit	-25 dBm

Measurement Uncertainty

The assessed measurement uncertainty to ensure 95% confidence level for the normal distribution is with the coverage factor $k = \pm 1.96$, $U = \pm 3.55$ dB.

Test Results

Refer to the section 6.7 of this report for test data.

6 Test Results

6.1 RF Power Output and Effective Isotropic Radiated Power

LTE Band 7 Low Antenna				Maximum Output Power (dBm)			EIRP (dBm)		
Bandwidth	Modulation	RB allocation	offset	Channel/Frequency(MHz)			Channel/Frequency(MHz)		
				20775/2502 .5	21100/2535	21425/2567 .5	20775/2502 .5	21100/2535	21425/2567 .5
5MHz	QPSK	1	0	22.65	22.89	22.90	21.75	21.99	22.00
		1	13	23.10	23.23	23.30	22.20	22.33	22.40
		1	24	22.84	23.00	23.07	21.94	22.10	22.17
		12	0	22.03	22.23	22.33	21.13	21.33	21.43
		12	6	22.13	22.33	22.37	21.23	21.43	21.47
		12	13	22.18	22.29	22.25	21.28	21.39	21.35
		25	0	22.12	22.28	22.27	21.22	21.38	21.37
	16QAM	1	0	22.01	22.09	22.16	21.11	21.19	21.26
		1	13	22.49	22.45	22.56	21.59	21.55	21.66
		1	24	22.18	22.28	22.33	21.28	21.38	21.43
		12	0	21.09	21.22	21.29	20.19	20.32	20.39
		12	6	21.18	21.30	21.37	20.28	20.40	20.47
		12	13	21.17	21.27	21.21	20.27	20.37	20.31
		25	0	21.13	21.22	21.24	20.23	20.32	20.34
Bandwidth	Modulation	RB allocation	offset	Channel/Frequency(MHz)			Channel/Frequency(MHz)		
				20800/2505	21100/2535	21400/2565	20800/2505	21100/2535	21400/2565
10MHz	QPSK	1	0	22.67	22.90	22.93	21.77	22.00	22.03
		1	25	23.13	23.28	23.34	22.23	22.38	22.44
		1	49	22.86	23.04	23.10	21.96	22.14	22.20
		25	0	22.06	22.28	22.37	21.16	21.38	21.47
		25	13	22.16	22.38	22.41	21.26	21.48	21.51
		25	25	22.20	22.33	22.30	21.30	21.43	21.40
		50	0	22.16	22.30	22.31	21.26	21.40	21.41
	16QAM	1	0	22.05	22.12	22.18	21.15	21.22	21.28
		1	25	22.53	22.49	22.59	21.63	21.59	21.69
		1	49	22.21	22.30	22.36	21.31	21.40	21.46
		25	0	21.12	21.27	21.33	20.22	20.37	20.43
		25	13	21.20	21.34	21.40	20.30	20.44	20.50
		25	25	21.20	21.32	21.25	20.30	20.42	20.35
		50	0	21.16	21.27	21.28	20.26	20.37	20.38



Bandwidth	Modulation	RB allocation	offset	Channel/Frequency(MHz)			Channel/Frequency(MHz)		
				20825/2507	21100/2535	21375/2562	20825/2507	21100/2535	21375/2562
				.5		.5	.5		.5
15MHz	QPSK	1	0	22.66	22.86	22.91	21.76	21.96	22.01
		1	38	23.11	23.27	23.31	22.21	22.37	22.41
		1	74	22.83	22.99	23.06	21.93	22.09	22.16
		36	0	22.04	22.24	22.34	21.14	21.34	21.44
		36	18	22.13	22.33	22.37	21.23	21.43	21.47
		36	39	22.17	22.30	22.26	21.27	21.40	21.36
		75	0	22.14	22.26	22.26	21.24	21.36	21.36
	16QAM	1	0	22.03	22.10	22.16	21.13	21.20	21.26
		1	38	22.51	22.46	22.57	21.61	21.56	21.67
		1	74	22.19	22.26	22.33	21.29	21.36	21.43
		36	0	21.09	21.25	21.30	20.19	20.35	20.40
		36	18	21.17	21.29	21.36	20.27	20.39	20.46
		36	39	21.18	21.28	21.22	20.28	20.38	20.32
		75	0	21.13	21.22	21.24	20.23	20.32	20.34
Bandwidth	Modulation	RB allocation	offset	Channel/Frequency(MHz)			Channel/Frequency(MHz)		
				20850/2510	21100/2535	21350/2560	20850/2510	21100/2535	21350/2560
20MHz	QPSK	1	0	22.63	22.82	22.88	21.73	21.92	21.98
		1	50	23.10	23.23	23.29	22.20	22.33	22.39
		1	99	22.81	22.98	23.03	21.91	22.08	22.13
		50	0	22.01	22.19	22.30	21.11	21.29	21.40
		50	25	22.11	22.29	22.34	21.21	21.39	21.44
		50	50	22.14	22.25	22.22	21.24	21.35	21.32
		100	0	22.11	22.21	22.52	21.21	21.31	21.62
	16QAM	1	0	22.00	22.06	22.11	21.10	21.16	21.21
		1	50	22.48	22.44	22.53	21.58	21.54	21.63
		1	99	22.16	22.23	22.31	21.26	21.33	21.41
		50	0	21.06	21.21	21.27	20.16	20.31	20.37
		50	25	21.14	21.27	21.33	20.24	20.37	20.43
		50	50	21.15	21.23	21.18	20.25	20.33	20.28
		100	0	21.11	21.18	21.21	20.21	20.28	20.31

LTE Band 7 Upper Antenna				Maximum Output Power (dBm)			EIRP (dBm)		
Bandwidth	Modulation	RB allocation	offset	Channel/Frequency(MHz)			Channel/Frequency(MHz)		
				20775/2502	21100/2535	21425/2567	20775/2502	21100/2535	21425/2567
				.5		.5	.5		.5
5MHz	QPSK	1	0	23.29	23.48	23.51	23.19	23.38	23.41
		1	13	23.76	23.86	23.96	23.66	23.76	23.86
		1	24	23.52	23.62	23.69	23.42	23.52	23.59
		12	0	22.69	22.84	22.97	22.59	22.74	22.87



	16QAM	12	6	22.74	22.87	23.01	22.64	22.77	22.91
		12	13	22.79	22.88	22.89	22.69	22.78	22.79
		25	0	22.69	22.88	22.95	22.59	22.78	22.85
		1	0	22.55	22.75	22.86	22.45	22.65	22.76
		1	13	23.08	23.24	23.27	22.98	23.14	23.17
		1	24	22.76	22.98	22.96	22.66	22.88	22.86
		12	0	21.74	21.85	22.00	21.64	21.75	21.90
		12	6	21.80	21.89	22.07	21.70	21.79	21.97
		12	13	21.85	21.94	21.89	21.75	21.84	21.79
		25	0	21.80	21.86	21.92	21.70	21.76	21.82
Bandwidth	Modulation	RB allocation	offset	Channel/Frequency(MHz)			Channel/Frequency(MHz)		
				20800/2505	21100/2535	21400/2565	20800/2505	21100/2535	21400/2565
10MHz	QPSK	1	0	23.31	23.49	23.54	23.21	23.39	23.44
		1	25	23.79	23.91	24.00	23.69	23.81	23.90
		1	49	23.54	23.66	23.72	23.44	23.56	23.62
		25	0	22.72	22.89	23.01	22.62	22.79	22.91
		25	13	22.77	22.92	23.05	22.67	22.82	22.95
		25	25	22.81	22.92	22.94	22.71	22.82	22.84
		50	0	22.73	22.90	22.99	22.63	22.80	22.89
	16QAM	1	0	22.59	22.78	22.88	22.49	22.68	22.78
		1	25	23.12	23.28	23.30	23.02	23.18	23.20
		1	49	22.79	23.00	22.99	22.69	22.90	22.89
		25	0	21.77	21.90	22.04	21.67	21.80	21.94
		25	13	21.82	21.93	22.10	21.72	21.83	22.00
		25	25	21.88	21.99	21.93	21.78	21.89	21.83
		50	0	21.83	21.91	21.96	21.73	21.81	21.86
Bandwidth	Modulation	RB allocation	offset	Channel/Frequency(MHz)			Channel/Frequency(MHz)		
				20825/2507.5	21100/2535	21375/2562.5	20825/2507.5	21100/2535	21375/2562.5
15MHz	QPSK	1	0	23.30	23.45	23.52	23.20	23.35	23.42
		1	38	23.77	23.90	23.97	23.67	23.80	23.87
		1	74	23.51	23.61	23.68	23.41	23.51	23.58
		36	0	22.70	22.85	22.98	22.60	22.75	22.88
		36	18	22.74	22.87	23.01	22.64	22.77	22.91
		36	39	22.78	22.89	22.90	22.68	22.79	22.80
		75	0	22.71	22.86	22.94	22.61	22.76	22.84
	16QAM	1	0	22.57	22.76	22.86	22.47	22.66	22.76
		1	38	23.10	23.25	23.28	23.00	23.15	23.18
		1	74	22.77	22.96	22.96	22.67	22.86	22.86
		36	0	21.74	21.88	22.01	21.64	21.78	21.91
		36	18	21.79	21.88	22.06	21.69	21.78	21.96
		36	39	21.86	21.95	21.90	21.76	21.85	21.80
		75	0	21.80	21.86	21.92	21.70	21.76	21.82



Bandwidth	Modulation	RB allocation	offset	Channel/Frequency(MHz)			Channel/Frequency(MHz)		
				20850/2510	21100/2535	21350/2560	20850/2510	21100/2535	21350/2560
20MHz	QPSK	1	0	23.27	23.41	23.49	23.17	23.31	23.39
		1	50	23.76	23.86	23.95	23.66	23.76	23.85
		1	99	23.49	23.60	23.65	23.39	23.50	23.55
		50	0	22.67	22.80	22.94	22.57	22.70	22.84
		50	25	22.72	22.83	22.98	22.62	22.73	22.88
		50	50	22.75	22.84	22.86	22.65	22.74	22.76
		100	0	22.68	22.81	22.90	22.58	22.71	22.80
	16QAM	1	0	22.54	22.72	22.81	22.44	22.62	22.71
		1	50	23.07	23.23	23.24	22.97	23.13	23.14
		1	99	22.74	22.93	22.94	22.64	22.83	22.84
		50	0	21.71	21.84	21.98	21.61	21.74	21.88
		50	25	21.76	21.86	22.03	21.66	21.76	21.93
		50	50	21.83	21.90	21.86	21.73	21.80	21.76
		100	0	21.78	21.82	21.89	21.68	21.72	21.79

LTE Band 38 Low Antenna				Maximum Output Power (dBm)			EIRP (dBm)		
Bandwidth	Modulation	RB allocation	offset	Channel/Frequency(MHz)			Channel/Frequency(MHz)		
				37775/2572 .5	38000/2595	38225/2617 .5	37775/2572 .5	38000/2595	38225/2617 .5
5MHz	QPSK	1	0	22.70	22.79	22.81	20.80	20.89	20.91
		1	13	23.11	23.12	23.22	21.21	21.22	21.32
		1	24	22.80	22.85	22.97	20.90	20.95	21.07
		12	0	22.07	22.09	22.17	20.17	20.19	20.27
		12	6	22.09	22.15	22.26	20.19	20.25	20.36
		12	13	22.08	22.13	22.23	20.18	20.23	20.33
		25	0	22.09	22.18	22.28	20.19	20.28	20.38
	16QAM	1	0	21.91	21.92	22.06	20.01	20.02	20.16
		1	13	22.30	22.34	22.44	20.40	20.44	20.54
		1	24	21.98	22.08	22.15	20.08	20.18	20.25
		12	0	21.11	21.14	21.23	19.21	19.24	19.33
		12	6	21.18	21.21	21.33	19.28	19.31	19.43
		12	13	21.08	21.16	21.28	19.18	19.26	19.38
		25	0	21.14	21.18	21.25	19.24	19.28	19.35
Bandwidth	Modulation	RB allocation	offset	Channel/Frequency(MHz)			Channel/Frequency(MHz)		
				37800/2575	38000/2595	38200/2615	37800/2575	38000/2595	38200/2615
10MHz	QPSK	1	0	22.72	22.80	22.84	20.82	20.90	20.94
		1	25	23.14	23.17	23.26	21.24	21.27	21.36
		1	49	22.82	22.89	23.00	20.92	20.99	21.10
		25	0	22.10	22.14	22.21	20.20	20.24	20.31
		25	13	22.12	22.20	22.30	20.22	20.30	20.40



		25	25	22.10	22.17	22.28	20.20	20.27	20.38
		50	0	22.13	22.20	22.32	20.23	20.30	20.42
	16QAM	1	0	21.95	21.95	22.08	20.05	20.05	20.18
		1	25	22.34	22.38	22.47	20.44	20.48	20.57
		1	49	22.01	22.10	22.18	20.11	20.20	20.28
		25	0	21.14	21.19	21.27	19.24	19.29	19.37
		25	13	21.20	21.25	21.36	19.30	19.35	19.46
		25	25	21.11	21.21	21.32	19.21	19.31	19.42
		50	0	21.17	21.23	21.29	19.27	19.33	19.39
Bandwidth	Modulation	RB allocation	offset	Channel/Frequency(MHz)			Channel/Frequency(MHz)		
				37825/2577 .5	38000/2595	38175/2612 .5	37825/2577 .5	38000/2595	38175/2612 .5
15MHz	QPSK	1	0	22.71	22.76	22.82	20.81	20.86	20.92
		1	38	23.12	23.16	23.23	21.22	21.26	21.33
		1	74	22.79	22.84	22.96	20.89	20.94	21.06
		36	0	22.08	22.10	22.18	20.18	20.20	20.28
		36	18	22.09	22.15	22.26	20.19	20.25	20.36
		36	39	22.07	22.14	22.24	20.17	20.24	20.34
		75	0	22.11	22.16	22.27	20.21	20.26	20.37
	16QAM	1	0	21.93	21.93	22.06	20.03	20.03	20.16
		1	38	22.32	22.35	22.45	20.42	20.45	20.55
		1	74	21.99	22.06	22.15	20.09	20.16	20.25
		36	0	21.11	21.17	21.24	19.21	19.27	19.34
		36	18	21.17	21.20	21.32	19.27	19.30	19.42
		36	39	21.09	21.17	21.29	19.19	19.27	19.39
		75	0	21.14	21.18	21.25	19.24	19.28	19.35
Bandwidth	Modulation	RB allocation	offset	Channel/Frequency(MHz)			Channel/Frequency(MHz)		
				37850/2580	38000/2595	38150/2610	37850/2580	38000/2595	38150/2610
20MHz	QPSK	1	0	22.68	22.72	22.79	20.78	20.82	20.89
		1	50	23.11	23.12	23.21	21.21	21.22	21.31
		1	99	22.77	22.83	22.93	20.87	20.93	21.03
		50	0	22.05	22.05	22.14	20.15	20.15	20.24
		50	25	22.07	22.11	22.23	20.17	20.21	20.33
		50	50	22.04	22.09	22.20	20.14	20.19	20.30
		100	0	22.08	22.11	22.23	20.18	20.21	20.33
	16QAM	1	0	21.90	21.89	22.01	20.00	19.99	20.11
		1	50	22.29	22.33	22.41	20.39	20.43	20.51
		1	99	21.96	22.03	22.13	20.06	20.13	20.23
		50	0	21.08	21.13	21.21	19.18	19.23	19.31
		50	25	21.14	21.18	21.29	19.24	19.28	19.39
		50	50	21.06	21.12	21.25	19.16	19.22	19.35
		100	0	21.12	21.14	21.22	19.22	19.24	19.32



LTE Band 38 Upper Antenna				Maximum Output Power (dBm)			EIRP (dBm)		
Bandwidth	Modulation	RB allocation	offset	Channel/Frequency(MHz)			Channel/Frequency(MHz)		
				37775/2572 .5	38000/2595	38225/2617 .5	37775/2572 .5	38000/2595	38225/2617 .5
5MHz	QPSK	1	0	23.44	23.49	23.52	23.64	23.69	23.72
		1	13	23.81	23.82	23.88	24.01	24.02	24.08
		1	24	23.53	23.51	23.54	23.73	23.71	23.74
		12	0	22.75	22.77	22.79	22.95	22.97	22.99
		12	6	22.81	22.85	22.86	23.01	23.05	23.06
		12	13	22.77	22.77	22.79	22.97	22.97	22.99
		25	0	22.78	22.86	22.84	22.98	23.06	23.04
	16QAM	1	0	22.63	22.68	22.73	22.83	22.88	22.93
		1	13	23.05	23.05	23.09	23.25	23.25	23.29
		1	24	22.74	22.79	22.75	22.94	22.99	22.95
		12	0	21.85	21.85	21.84	22.05	22.05	22.04
		12	6	21.93	21.90	21.95	22.13	22.10	22.15
		12	13	21.81	21.83	21.91	22.01	22.03	22.11
		25	0	21.83	21.87	21.88	22.03	22.07	22.08
Bandwidth	Modulation	RB allocation	offset	Channel/Frequency(MHz)			Channel/Frequency(MHz)		
				37800/2575	38000/2595	38200/2615	37800/2575	38000/2595	38200/2615
10MHz	QPSK	1	0	23.46	23.50	23.55	23.66	23.70	23.75
		1	25	23.84	23.87	23.92	24.04	24.07	24.12
		1	49	23.55	23.55	23.57	23.75	23.75	23.77
		25	0	22.78	22.82	22.83	22.98	23.02	23.03
		25	13	22.84	22.90	22.90	23.04	23.10	23.10
		25	25	22.79	22.81	22.84	22.99	23.01	23.04
		50	0	22.82	22.88	22.88	23.02	23.08	23.08
	16QAM	1	0	22.67	22.71	22.75	22.87	22.91	22.95
		1	25	23.09	23.09	23.12	23.29	23.29	23.32
		1	49	22.77	22.81	22.78	22.97	23.01	22.98
		25	0	21.88	21.90	21.88	22.08	22.10	22.08
		25	13	21.95	21.94	21.98	22.15	22.14	22.18
		25	25	21.84	21.88	21.95	22.04	22.08	22.15
		50	0	21.86	21.92	21.92	22.06	22.12	22.12
Bandwidth	Modulation	RB allocation	offset	Channel/Frequency(MHz)			Channel/Frequency(MHz)		
				37825/2577 .5	38000/2595	38175/2612 .5	37825/2577 .5	38000/2595	38175/2612 .5
15MHz	QPSK	1	0	23.45	23.46	23.53	23.65	23.66	23.73
		1	38	23.82	23.86	23.89	24.02	24.06	24.09
		1	74	23.52	23.50	23.53	23.72	23.70	23.73
		36	0	22.76	22.78	22.80	22.96	22.98	23.00



Bandwidth	Modulation	RB allocation	offset	Channel/Frequency(MHz)			Channel/Frequency(MHz)		
				37850/2580	38000/2595	38150/2610	37850/2580	38000/2595	38150/2610
	16QAM	36	18	22.81	22.85	22.86	23.01	23.05	23.06
		36	39	22.76	22.78	22.80	22.96	22.98	23.00
		75	0	22.80	22.84	22.83	23.00	23.04	23.03
		1	0	22.65	22.69	22.73	22.85	22.89	22.93
		1	38	23.07	23.06	23.10	23.27	23.26	23.30
		1	74	22.75	22.77	22.75	22.95	22.97	22.95
		36	0	21.85	21.88	21.85	22.05	22.08	22.05
		36	18	21.92	21.89	21.94	22.12	22.09	22.14
		36	39	21.82	21.84	21.92	22.02	22.04	22.12
		75	0	21.83	21.87	21.88	22.03	22.07	22.08
20MHz	QPSK	1	0	23.42	23.42	23.50	23.62	23.62	23.70
		1	50	23.81	23.82	23.87	24.01	24.02	24.07
		1	99	23.50	23.49	23.50	23.70	23.69	23.70
		50	0	22.73	22.73	22.76	22.93	22.93	22.96
		50	25	22.79	22.81	22.83	22.99	23.01	23.03
		50	50	22.73	22.73	22.76	22.93	22.93	22.96
		100	0	22.77	22.79	22.79	22.97	22.99	22.99
	16QAM	1	0	22.62	22.65	22.68	22.82	22.85	22.88
		1	50	23.04	23.04	23.06	23.24	23.24	23.26
		1	99	22.72	22.74	22.73	22.92	22.94	22.93
		50	0	21.82	21.84	21.82	22.02	22.04	22.02
		50	25	21.89	21.87	21.91	22.09	22.07	22.11
		50	50	21.79	21.79	21.88	21.99	21.99	22.08
		100	0	21.81	21.83	21.85	22.01	22.03	22.05

LTE Band 41 Low Antenna				Maximum Output Power (dBm)			EIRP (dBm)		
Bandwidth	Modulation	RB allocation	offset	Channel/Frequency(MHz)			Channel/Frequency(MHz)		
				39675/2498.5	40620/2593	41565/2687.5	39675/2498.5	40620/2593	41565/2687.5
5MHz	QPSK	1	0	22.54	22.83	22.94	21.64	21.93	22.04
		1	13	22.83	23.06	23.10	21.93	22.16	22.20
		1	24	22.60	22.84	22.78	21.70	21.94	21.88
		12	0	21.79	22.05	22.11	20.89	21.15	21.21
		12	6	21.87	22.09	22.17	20.97	21.19	21.27
		12	13	21.91	22.07	22.08	21.01	21.17	21.18
		25	0	21.90	22.09	22.12	21.00	21.19	21.22
	16QAM	1	0	21.66	22.03	22.03	20.76	21.13	21.13
		1	13	22.02	22.31	22.25	21.12	21.41	21.35
		1	24	21.79	22.11	22.01	20.89	21.21	21.11
12		0	20.77	21.10	21.16	19.87	20.20	20.26	



Bandwidth	Modulation	RB allocation	offset	Channel/Frequency(MHz)			Channel/Frequency(MHz)		
				39700/2501	40620/2593	41540/2685	39700/2501	40620/2593	41540/2685
10MHz	QPSK	1	0	22.56	22.86	22.95	21.66	21.96	22.05
		1	25	22.86	23.10	23.15	21.96	22.20	22.25
		1	49	22.62	22.87	22.82	21.72	21.97	21.92
		25	0	21.82	22.09	22.16	20.92	21.19	21.26
		25	13	21.90	22.13	22.22	21.00	21.23	21.32
		25	25	21.93	22.12	22.12	21.03	21.22	21.22
		50	0	21.94	22.13	22.14	21.04	21.23	21.24
	16QAM	1	0	21.70	22.05	22.06	20.80	21.15	21.16
		1	25	22.06	22.34	22.29	21.16	21.44	21.39
		1	49	21.82	22.14	22.03	20.92	21.24	21.13
		25	0	20.80	21.14	21.21	19.90	20.24	20.31
		25	13	20.96	21.16	21.23	20.06	20.26	20.33
		25	25	20.94	21.14	21.21	20.04	20.24	20.31
		50	0	20.91	21.16	21.18	20.01	20.26	20.28
Bandwidth	Modulation	RB allocation	offset	Channel/Frequency(MHz)			Channel/Frequency(MHz)		
				39725/2503.5	40620/2593	41515/2682.5	39725/2503.5	40620/2593	41515/2682.5
15MHz	QPSK	1	0	22.55	22.84	22.91	21.65	21.94	22.01
		1	38	22.84	23.07	23.14	21.94	22.17	22.24
		1	74	22.59	22.83	22.77	21.69	21.93	21.87
		36	0	21.80	22.06	22.12	20.90	21.16	21.22
		36	18	21.87	22.09	22.17	20.97	21.19	21.27
		36	39	21.90	22.08	22.09	21.00	21.18	21.19
		75	0	21.92	22.08	22.10	21.02	21.18	21.20
	16QAM	1	0	21.68	22.03	22.04	20.78	21.13	21.14
		1	38	22.04	22.32	22.26	21.14	21.42	21.36
		1	74	21.80	22.11	21.99	20.90	21.21	21.09
		36	0	20.77	21.11	21.19	19.87	20.21	20.29
		36	18	20.93	21.12	21.18	20.03	20.22	20.28
		36	39	20.92	21.11	21.17	20.02	20.21	20.27
		75	0	20.88	21.12	21.13	19.98	20.22	20.23
Bandwidth	Modulation	RB allocation	offset	Channel/Frequency(MHz)			Channel/Frequency(MHz)		
				39750/2506	40620/2593	41490/2680	39750/2506	40620/2593	41490/2680
20MHz	QPSK	1	0	22.52	22.81	22.87	21.62	21.91	21.97
		1	50	22.83	23.05	23.10	21.93	22.15	22.20
		1	99	22.57	22.80	22.76	21.67	21.90	21.86
		50	0	21.77	22.02	22.07	20.87	21.12	21.17
		50	25	21.85	22.06	22.13	20.95	21.16	21.23



		50	50	21.87	22.04	22.04	20.97	21.14	21.14
		100	0	21.89	22.04	22.05	20.99	21.14	21.15
	16QAM	1	0	21.65	21.98	22.00	20.75	21.08	21.10
		1	50	22.01	22.28	22.24	21.11	21.38	21.34
		1	99	21.77	22.09	21.96	20.87	21.19	21.06
		50	0	20.74	21.08	21.15	19.84	20.18	20.25
		50	25	20.90	21.09	21.16	20.00	20.19	20.26
		50	50	20.89	21.07	21.12	19.99	20.17	20.22
		100	0	20.86	21.09	21.09	19.96	20.19	20.19

LTE Band 41 Upper Antenna				Maximum Output Power (dBm)			EIRP (dBm)		
Bandwidth	Modulation	RB allocation	offset	Channel/Frequency(MHz)			Channel/Frequency(MHz)		
				39675/2498 .5	40620/2593	41565/2687 .5	39675/2498 .5	40620/2593	41565/2687 .5
5MHz	QPSK	1	0	23.25	23.53	23.45	24.35	24.63	24.55
		1	13	23.61	23.82	23.67	24.71	24.92	24.77
		1	24	23.39	23.58	23.42	24.49	24.68	24.52
		12	0	22.54	22.83	22.66	23.64	23.93	23.76
		12	6	22.61	22.83	22.69	23.71	23.93	23.79
		12	13	22.68	22.75	22.67	23.78	23.85	23.77
		25	0	22.67	22.81	22.74	23.77	23.91	23.84
	16QAM	1	0	22.42	22.85	22.61	23.52	23.95	23.71
		1	13	22.84	23.02	22.81	23.94	24.12	23.91
		1	24	22.58	22.79	22.66	23.68	23.89	23.76
		12	0	21.59	21.86	21.71	22.69	22.96	22.81
		12	6	21.67	21.91	21.76	22.77	23.01	22.86
		12	13	21.68	21.83	21.72	22.78	22.93	22.82
		25	0	21.65	21.84	21.72	22.75	22.94	22.82
Bandwidth	Modulation	RB allocation	offset	Channel/Frequency(MHz)			Channel/Frequency(MHz)		
				39700/2501	40620/2593	41540/2685	39700/2501	40620/2593	41540/2685
10MHz	QPSK	1	0	23.27	23.56	23.46	24.37	24.66	24.56
		1	25	23.64	23.86	23.72	24.74	24.96	24.82
		1	49	23.41	23.61	23.46	24.51	24.71	24.56
		25	0	22.57	22.87	22.71	23.67	23.97	23.81
		25	13	22.64	22.87	22.74	23.74	23.97	23.84
		25	25	22.70	22.80	22.71	23.80	23.90	23.81
		50	0	22.71	22.85	22.76	23.81	23.95	23.86
	16QAM	1	0	22.46	22.87	22.64	23.56	23.97	23.74
		1	25	22.88	23.05	22.85	23.98	24.15	23.95
		1	49	22.61	22.82	22.68	23.71	23.92	23.78
		25	0	21.62	21.90	21.76	22.72	23.00	22.86
		25	13	21.69	21.94	21.80	22.79	23.04	22.90



Bandwidth	Modulation	RB allocation	offset	Channel/Frequency(MHz)			Channel/Frequency(MHz)		
				39725/2503 .5	40620/2593	41515/2682 .5	39725/2503 .5	40620/2593	41515/2682 .5
		25	25	21.71	21.87	21.77	22.81	22.97	22.87
		50	0	21.68	21.88	21.77	22.78	22.98	22.87
15MHz	QPSK	1	0	23.26	23.54	23.42	24.36	24.64	24.52
		1	38	23.62	23.83	23.71	24.72	24.93	24.81
		1	74	23.38	23.57	23.41	24.48	24.67	24.51
		36	0	22.55	22.84	22.67	23.65	23.94	23.77
		36	18	22.61	22.83	22.69	23.71	23.93	23.79
		36	39	22.67	22.76	22.68	23.77	23.86	23.78
		75	0	22.69	22.80	22.72	23.79	23.90	23.82
	16QAM	1	0	22.44	22.85	22.62	23.54	23.95	23.72
		1	38	22.86	23.03	22.82	23.96	24.13	23.92
		1	74	22.59	22.79	22.64	23.69	23.89	23.74
		36	0	21.59	21.87	21.74	22.69	22.97	22.84
		36	18	21.66	21.90	21.75	22.76	23.00	22.85
		36	39	21.69	21.84	21.73	22.79	22.94	22.83
		75	0	21.65	21.84	21.72	22.75	22.94	22.82
Bandwidth	Modulation	RB allocation	offset	Channel/Frequency(MHz)			Channel/Frequency(MHz)		
				39750/2506	40620/2593	41490/2680	39750/2506	40620/2593	41490/2680
20MHz	QPSK	1	0	23.23	23.51	23.38	24.33	24.61	24.48
		1	50	23.61	23.81	23.67	24.71	24.91	24.77
		1	99	23.36	23.54	23.40	24.46	24.64	24.50
		50	0	22.52	22.80	22.62	23.62	23.90	23.72
		50	25	22.59	22.80	22.65	23.69	23.90	23.75
		50	50	22.64	22.72	22.63	23.74	23.82	23.73
		100	0	22.66	22.76	22.67	23.76	23.86	23.77
	16QAM	1	0	22.41	22.80	22.58	23.51	23.90	23.68
		1	50	22.83	22.99	22.80	23.93	24.09	23.90
		1	99	22.56	22.77	22.61	23.66	23.87	23.71
		50	0	21.56	21.84	21.70	22.66	22.94	22.80
		50	25	21.63	21.87	21.73	22.73	22.97	22.83
		50	50	21.66	21.80	21.68	22.76	22.90	22.78
		100	0	21.63	21.81	21.68	22.73	22.91	22.78

6.2 Occupied Bandwidth

LTE Band 7						
RB	Modulation	Bandwidth (MHz)	Channel	Frequency (MHz)	99% Power Bandwidth(MHz)	-26dBc Bandwidth(MHz)
100%	QPSK	5	20775	2502.5	4.502	4.913
			21100	2535	4.521	4.923
			21425	2567.5	4.499	4.890
		10	20800	2505	9.002	9.657
			21100	2535	9.010	9.639
			21400	2565	8.967	9.605
		15	20825	2507.5	13.483	14.584
			21100	2535	13.462	14.545
			21375	2562.5	13.483	14.643
		20	20850	2510	17.948	19.159
			21100	2535	17.966	19.289
			21350	2560	17.952	19.339
	16QAM	5	20775	2502.5	4.510	4.916
			21100	2535	4.503	4.901
			21425	2567.5	4.510	4.929
		10	20800	2505	8.987	9.677
			21100	2535	9.006	9.726
			21400	2565	8.980	9.700
		15	20825	2507.5	13.506	14.553
			21100	2535	13.455	14.515
			21375	2562.5	13.455	14.456
		20	20850	2510	17.919	19.158
			21100	2535	17.992	19.430
			21350	2560	17.958	19.191



LTE Band 38						
RB	Modulation	Bandwidth (MHz)	Channel	Frequency (MHz)	99% Power Bandwidth(MHz)	-26dBc Bandwidth(MHz)
100%	QPSK	5	37775	2572.5	4.517	5.102
			38000	2595	4.515	4.950
			38225	2617.5	4.511	4.875
		10	37800	2575	8.995	9.735
			38000	2595	8.992	9.549
			38200	2615	9.021	9.651
		15	37825	2577.5	13.520	14.538
			38000	2595	13.454	14.561
			38175	2612.5	13.454	15.324
		20	37850	2580	17.993	19.375
			38000	2595	17.920	19.747
			38150	2610	17.930	19.384
	16QAM	5	37775	2572.5	4.493	4.895
			38000	2595	4.498	5.013
			38225	2617.5	4.491	5.169
		10	37800	2575	8.987	9.504
			38000	2595	8.994	9.923
			38200	2615	8.999	9.621
		15	37825	2577.5	13.482	14.631
			38000	2595	13.475	14.425
			38175	2612.5	13.501	14.362
		20	37850	2580	17.973	19.012
			38000	2595	17.901	19.061
			38150	2610	17.907	19.363

LTE Band 41						
RB	Modulation	Bandwidth (MHz)	Channel	Frequency (MHz)	99% Power Bandwidth(MHz)	-26dBc Bandwidth(MHz)
100%	QPSK	5	39675	2498.5	4.506	5.124
			40620	2593	4.508	5.034
			41565	2687.5	4.485	4.849
		10	39700	2501	8.992	9.468
			40620	2593	8.993	9.585
			41540	2685	9.011	9.701
		15	39725	2503.5	13.416	14.276
			40620	2593	13.439	14.425



			41515	2682.5	13.452	14.444
		20	39750	2506	17.944	19.329
			40620	2593	17.930	21.141
			41490	2680	17.956	19.339
	16QAM	5	39675	2498.5	4.500	4.962
			40620	2593	4.502	4.832
			41565	2687.5	4.499	4.952
		10	39700	2501	8.982	10.186
			40620	2593	8.984	9.553
			41540	2685	8.972	9.842
		15	39725	2503.5	13.456	15.293
			40620	2593	13.484	14.578
			41515	2682.5	13.452	15.698
		20	39750	2506	17.971	19.246
			40620	2593	17.964	19.842
			41490	2680	17.976	19.248



LTE Band 7 QPSK 5MHz CH-Low

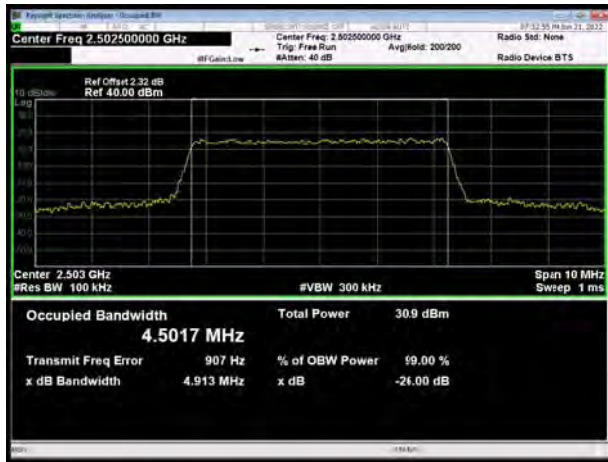

LTE Band 7 QPSK 10MHz CH-Low

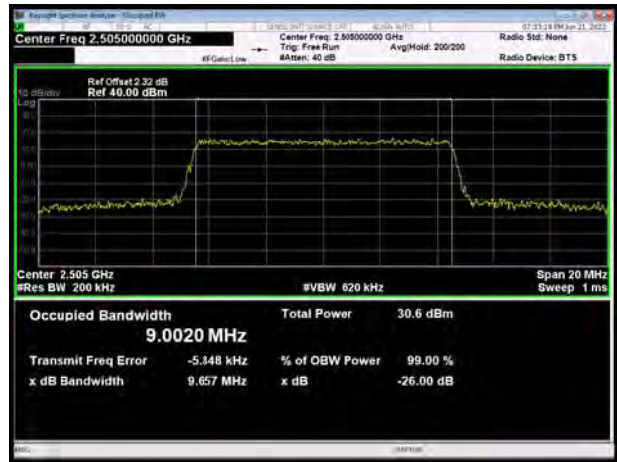

LTE Band 7 QPSK 5MHz CH-Middle



LTE Band 7 QPSK 10MHz CH-Middle

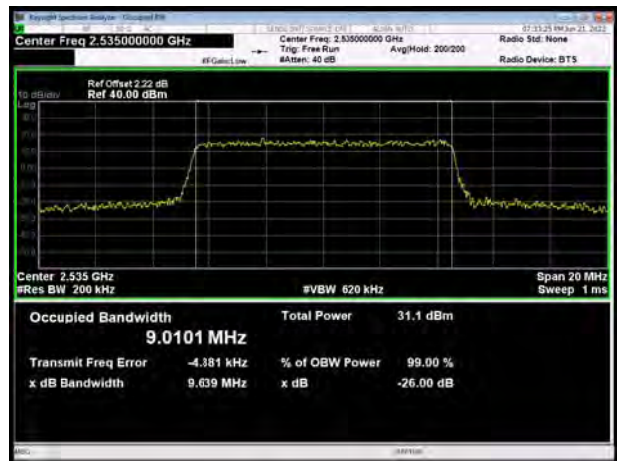

LTE Band 7 QPSK 5MHz CH-High

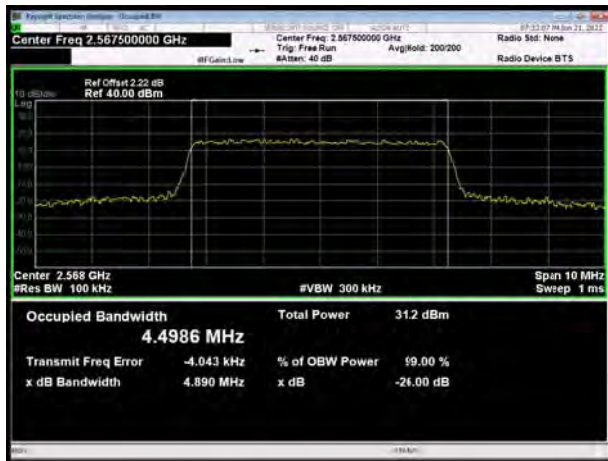

LTE Band 7 QPSK 10MHz CH-High

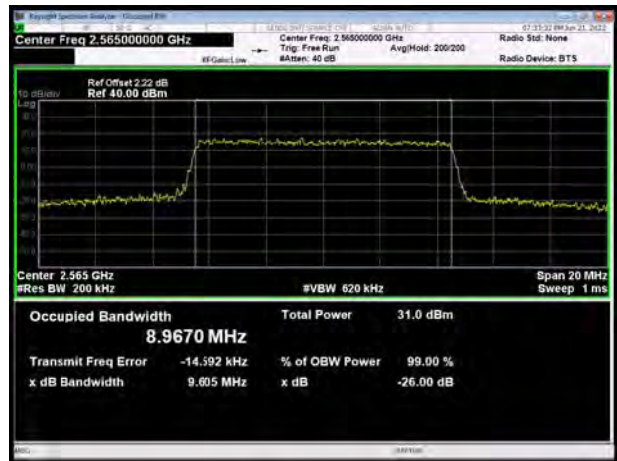



LTE Band 7 QPSK 15MHz CH-Low

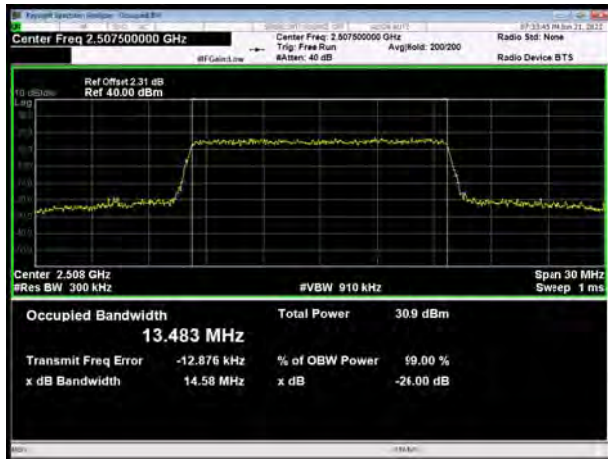

LTE Band 7 QPSK 20MHz CH-Low

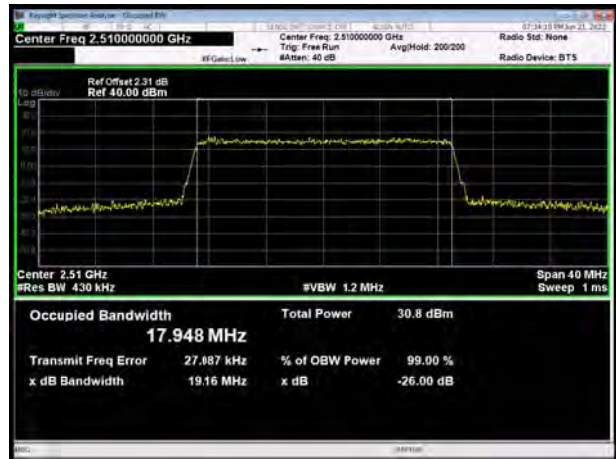

LTE Band 7 QPSK 15MHz CH-Middle

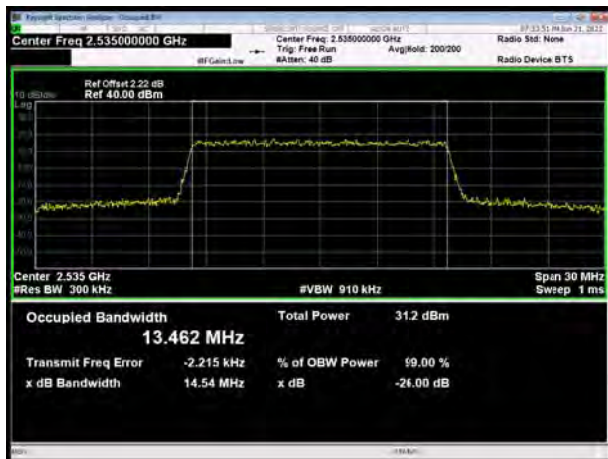

LTE Band 7 QPSK 20MHz CH-Middle

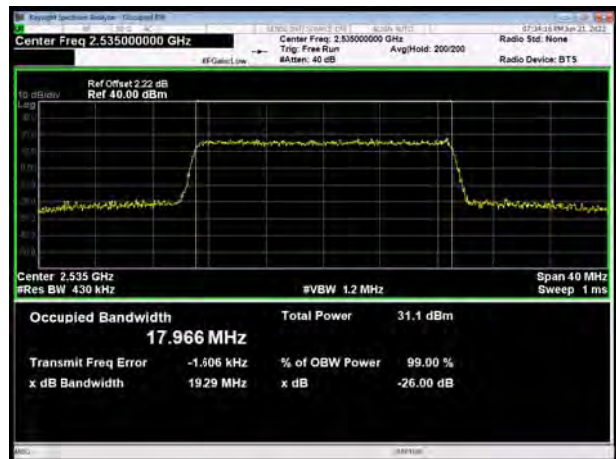

LTE Band 7 QPSK 15MHz CH-High

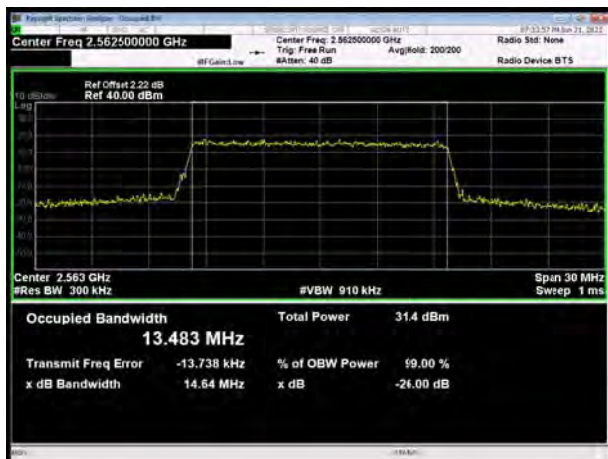

LTE Band 7 QPSK 20MHz CH-High

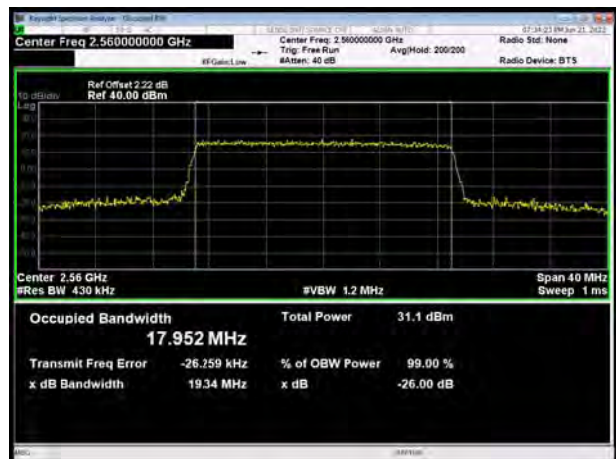



LTE Band 7 16QAM 5MHz CH-Low

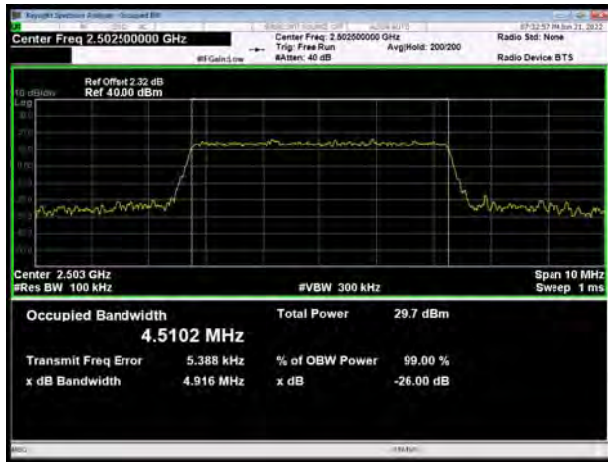

LTE Band 7 16QAM 10MHz CH-Low



LTE Band 7 16QAM 5MHz CH-Middle

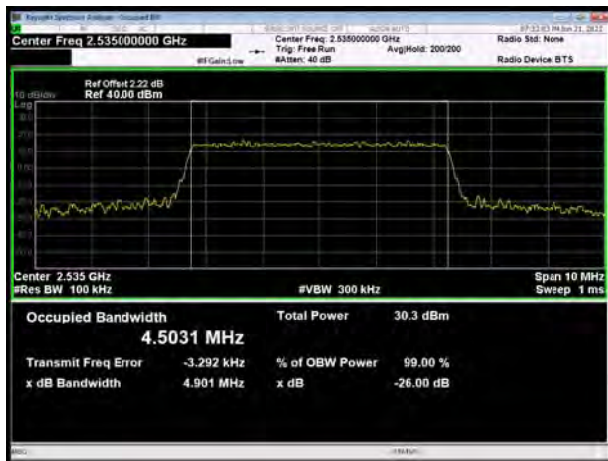

LTE Band 7 16QAM 10MHz CH-Middle



LTE Band 7 16QAM 5MHz CH-High

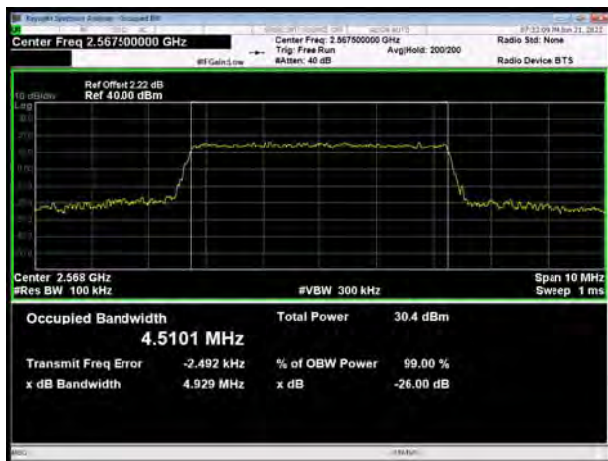

LTE Band 7 16QAM 10MHz CH-High

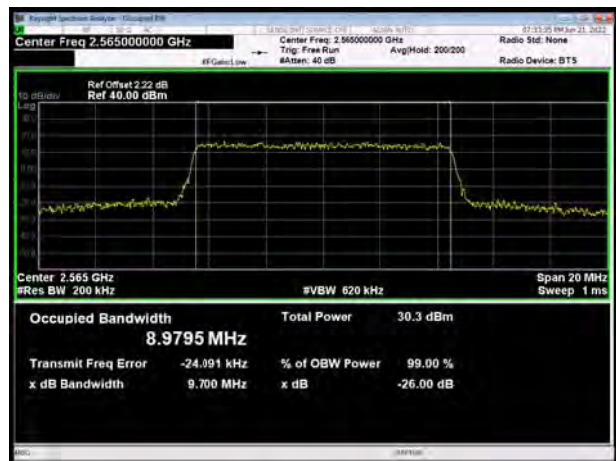

LTE Band 7 16QAM 15MHz CH-Low

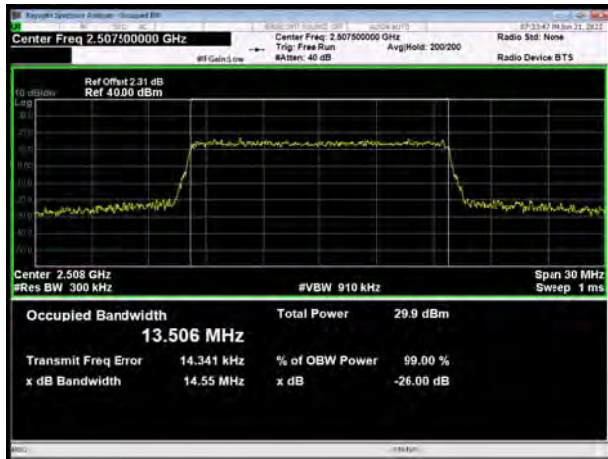

LTE Band 7 16QAM 20MHz CH-Low

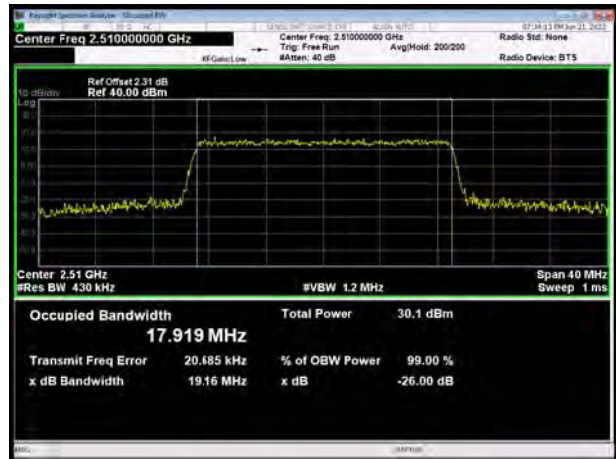

LTE Band 7 16QAM 15MHz CH-Middle

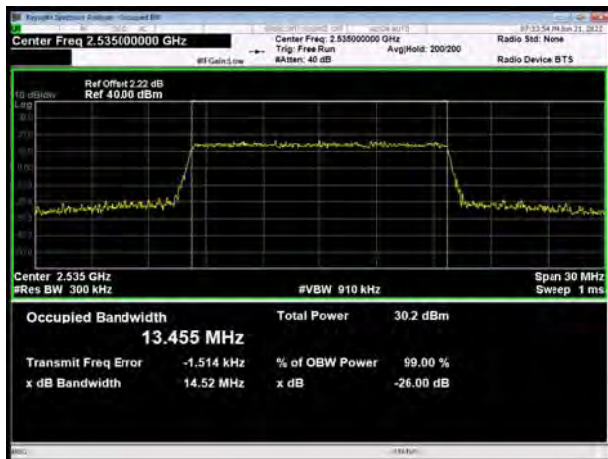

LTE Band 7 16QAM 20MHz CH-Middle

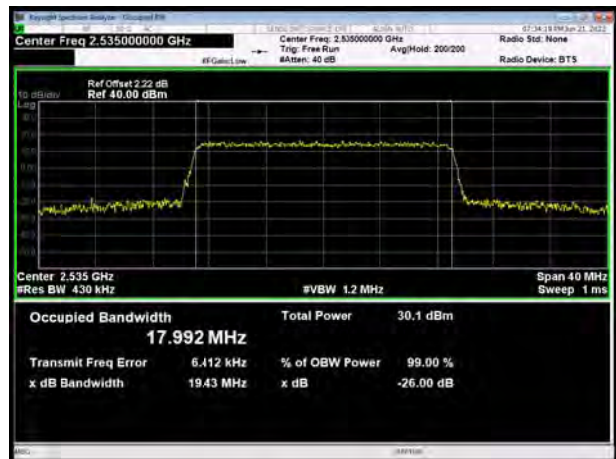

LTE Band 7 16QAM 15MHz CH-High

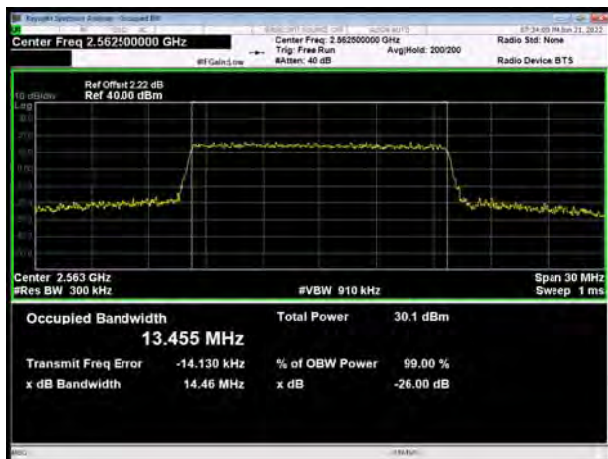

LTE Band 7 16QAM 20MHz CH-High

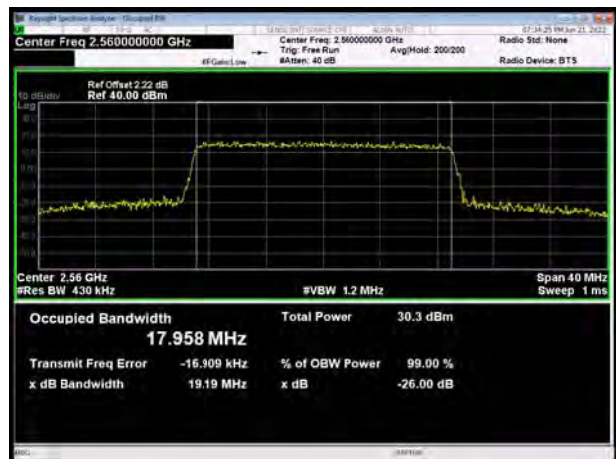



LTE Band 38 QPSK 5MHz CH-Low

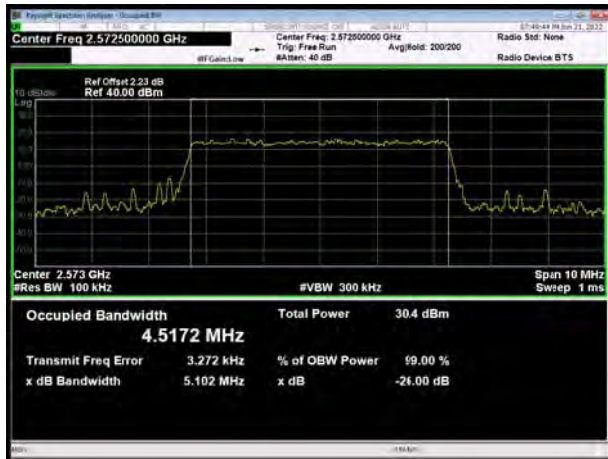

LTE Band 38 QPSK 10MHz CH-Low

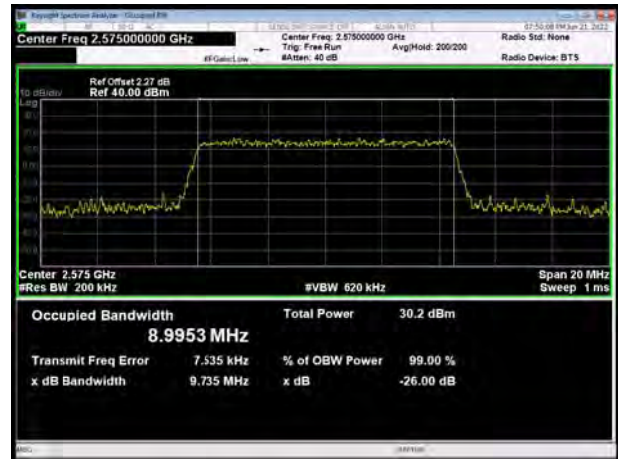

LTE Band 38 QPSK 5MHz CH-Middle

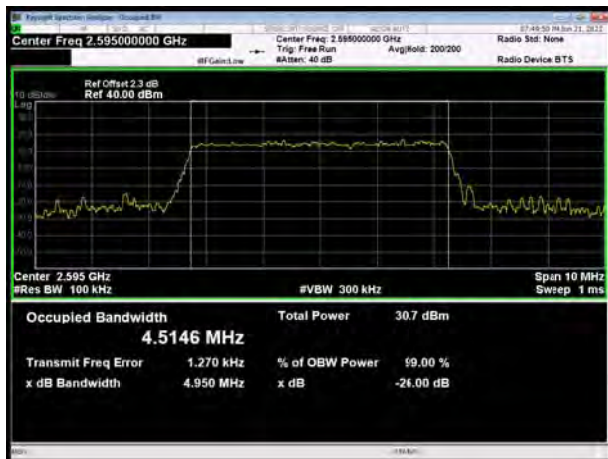

LTE Band 38 QPSK 10MHz CH-Middle

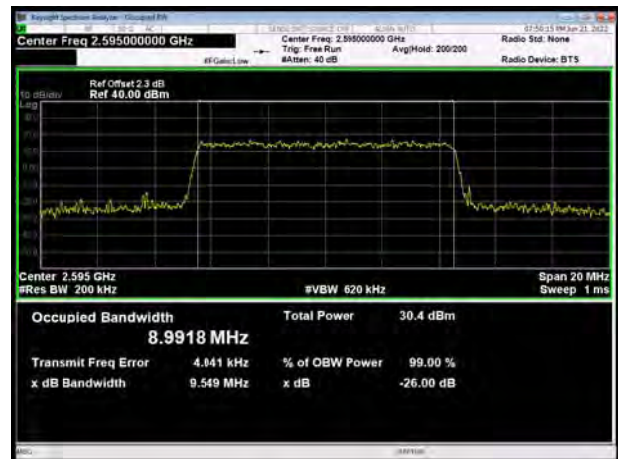

LTE Band 38 QPSK 5MHz CH-High

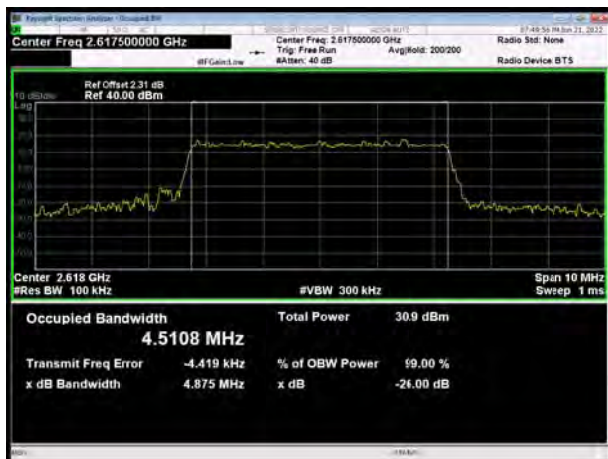

LTE Band 38 QPSK 10MHz CH-High

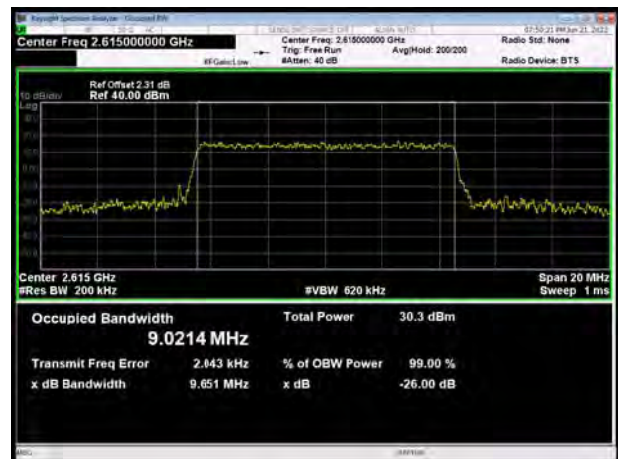



LTE Band 38 QPSK 15MHz CH-Low

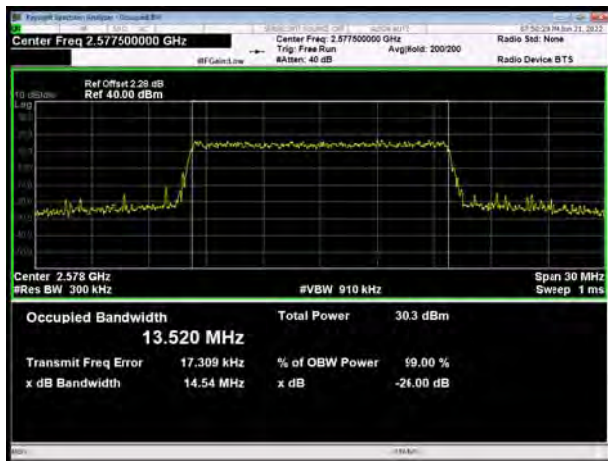

LTE Band 38 QPSK 20MHz CH-Low

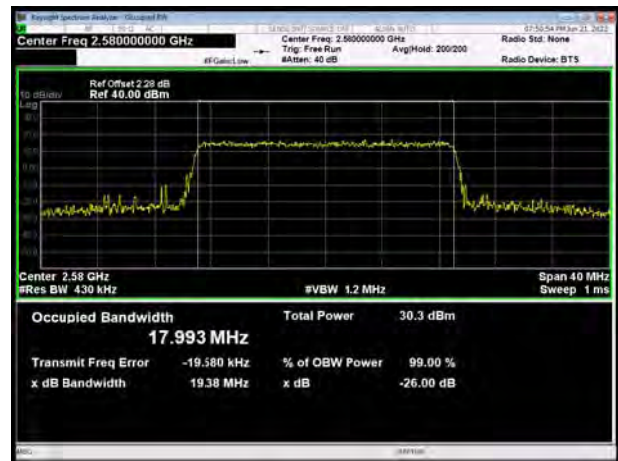

LTE Band 38 QPSK 15MHz CH-Middle

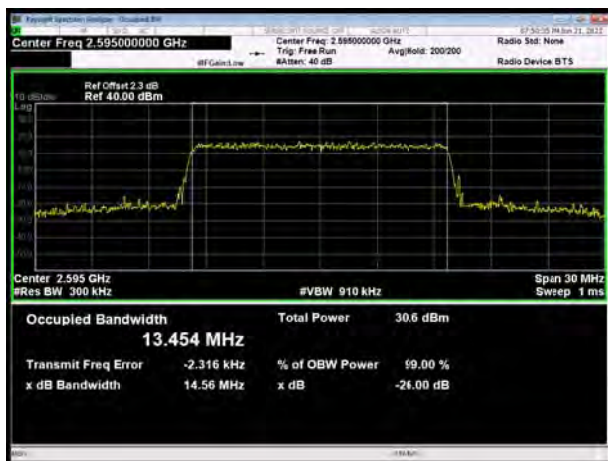

LTE Band 38 QPSK 20MHz CH-Middle

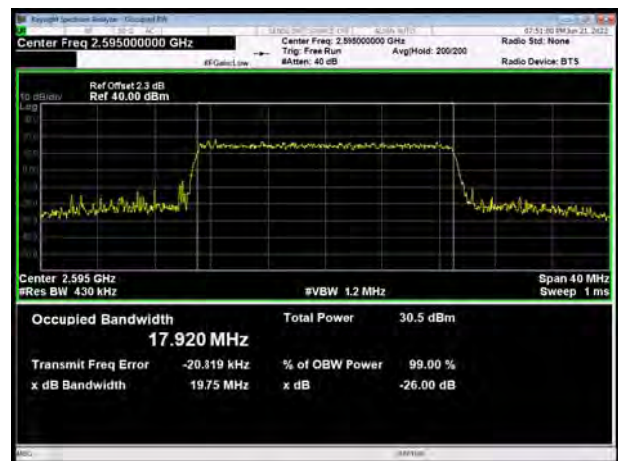

LTE Band 38 QPSK 15MHz CH-High

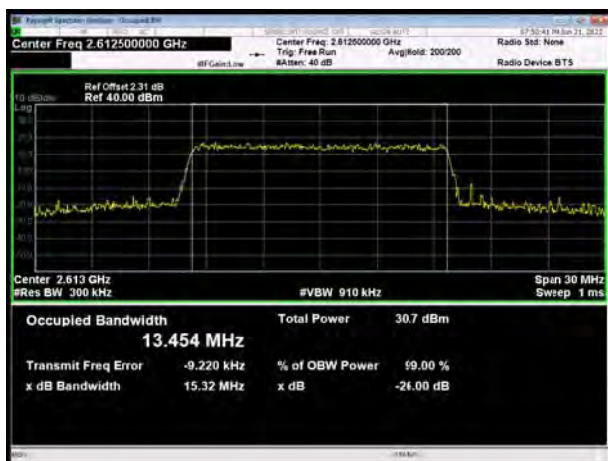

LTE Band 38 QPSK 20MHz CH-High

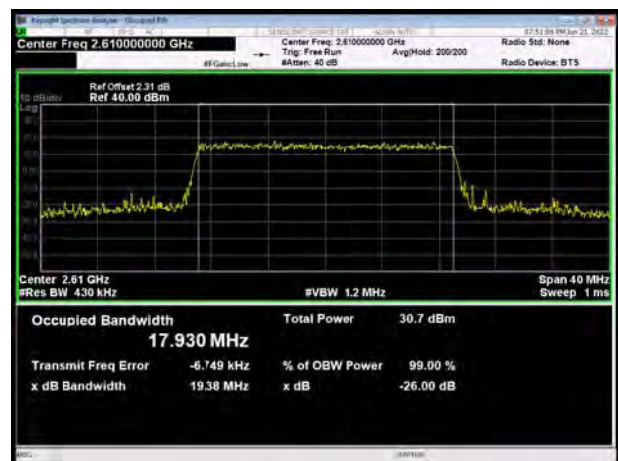



LTE Band 38 16QAM 5MHz CH-Low

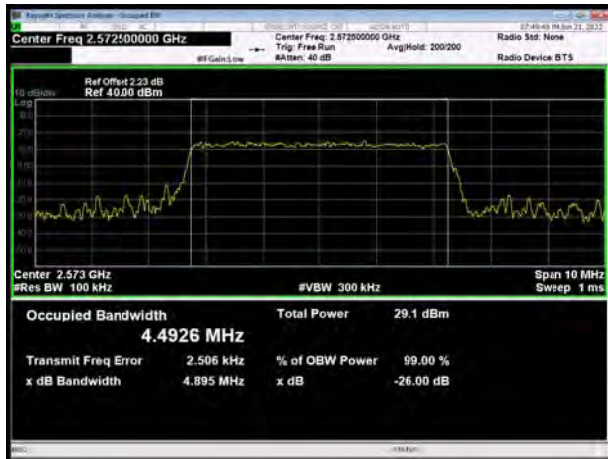

LTE Band 38 16QAM 10MHz CH-Low

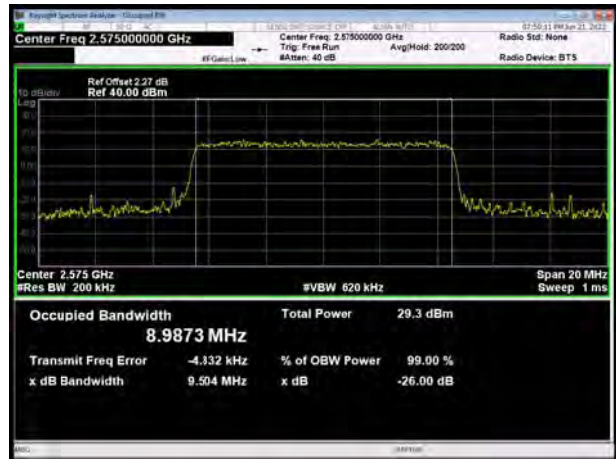

LTE Band 38 16QAM 5MHz CH-Middle

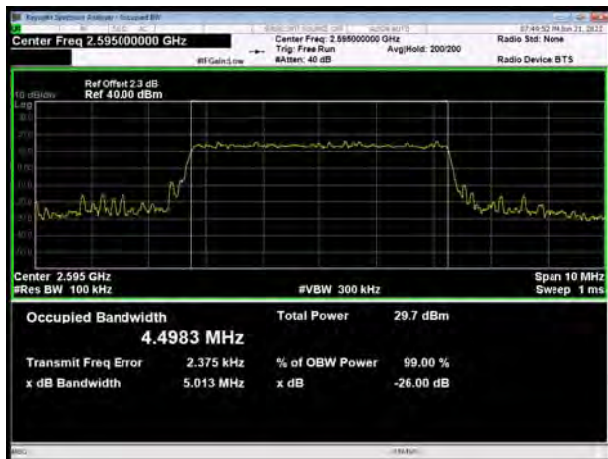

LTE Band 38 16QAM 10MHz CH-Middle

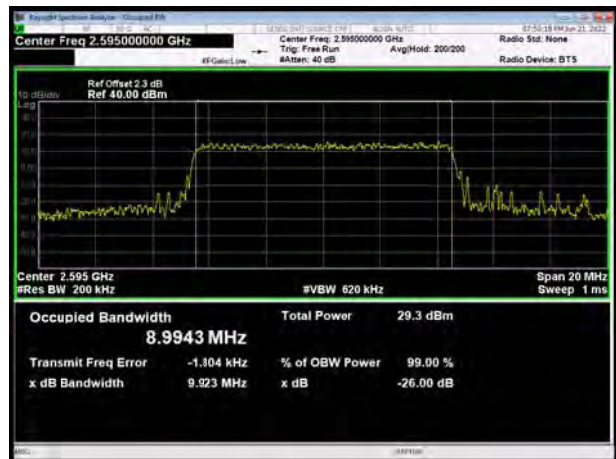

LTE Band 38 16QAM 5MHz CH-High

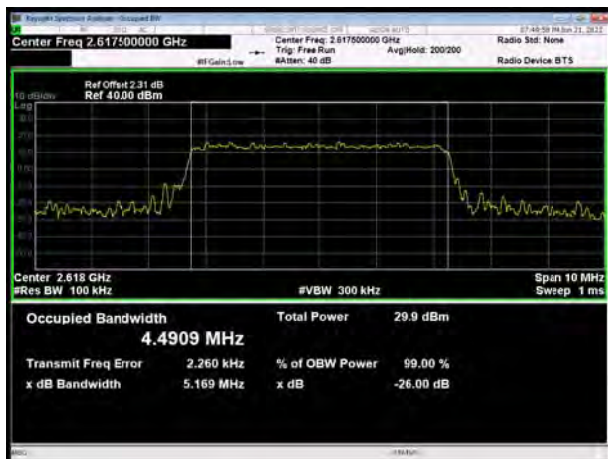

LTE Band 38 16QAM 10MHz CH-High

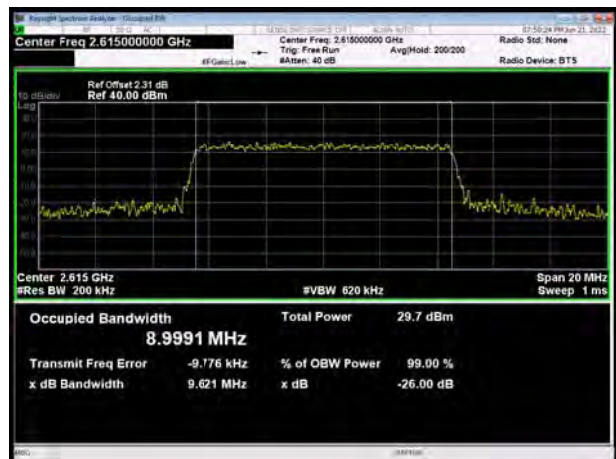

LTE Band 38 16QAM 15MHz CH-Low

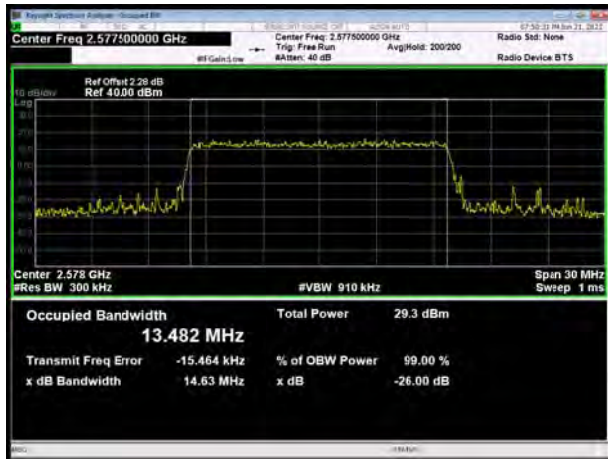

LTE Band 38 16QAM 20MHz CH-Low

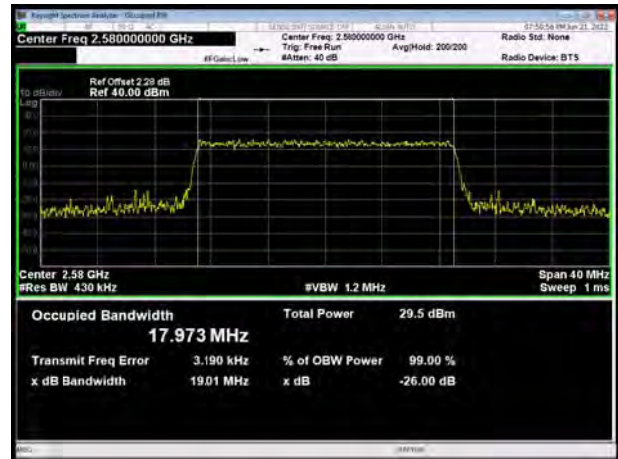

LTE Band 38 16QAM 15MHz CH-Middle

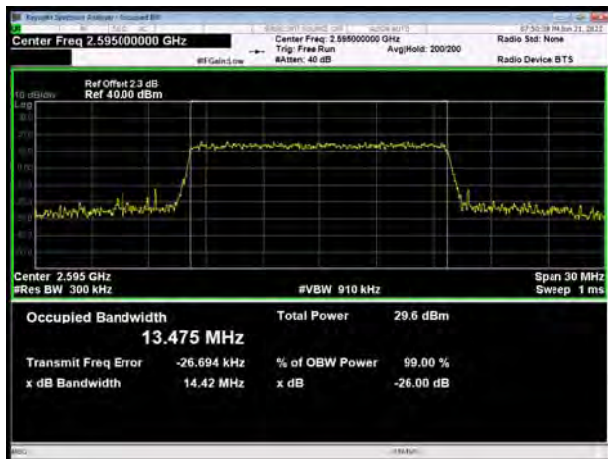

LTE Band 38 16QAM 20MHz CH-Middle

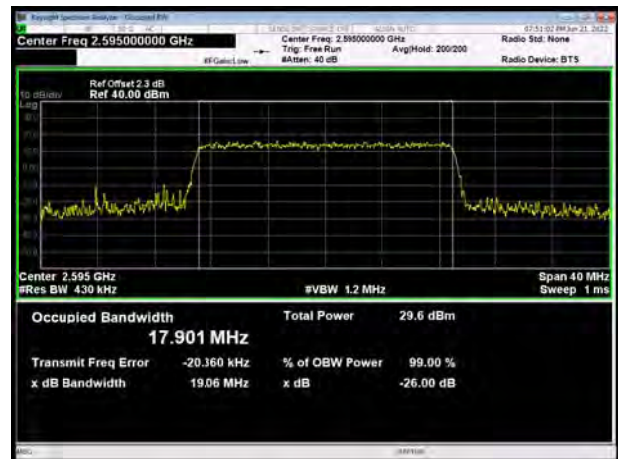

LTE Band 38 16QAM 15MHz CH-High

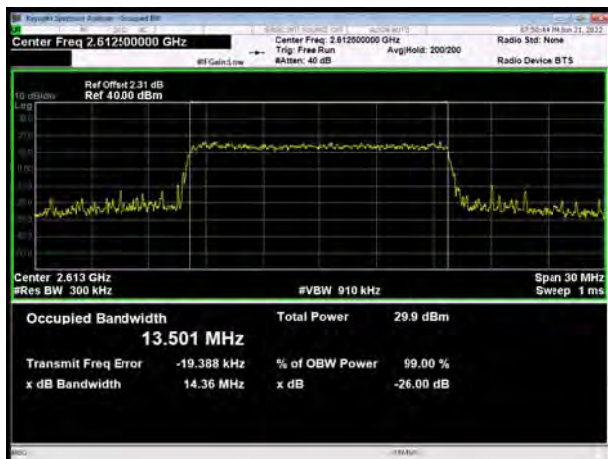

LTE Band 38 16QAM 20MHz CH-High

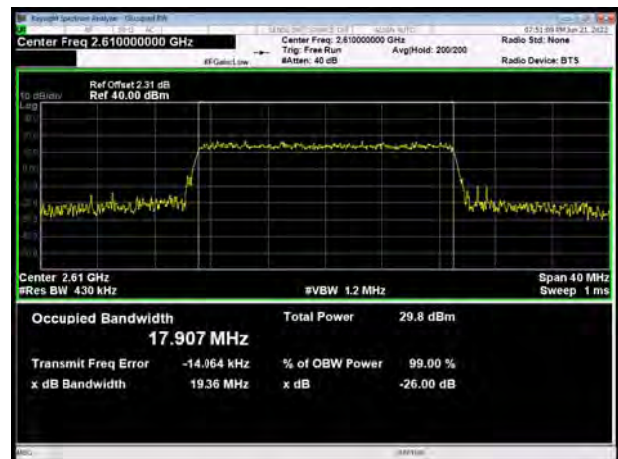



LTE Band 41 QPSK 5MHz CH-Low

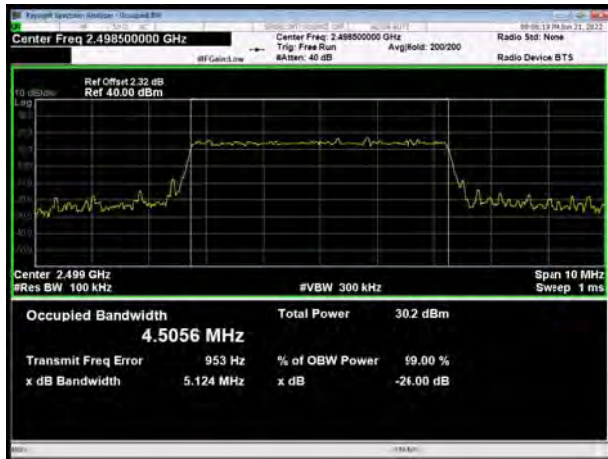

LTE Band 41 QPSK 10MHz CH-Low

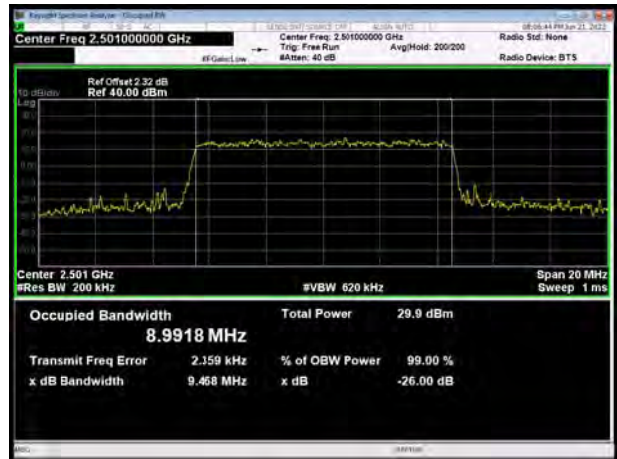

LTE Band 41 QPSK 5MHz CH-Middle

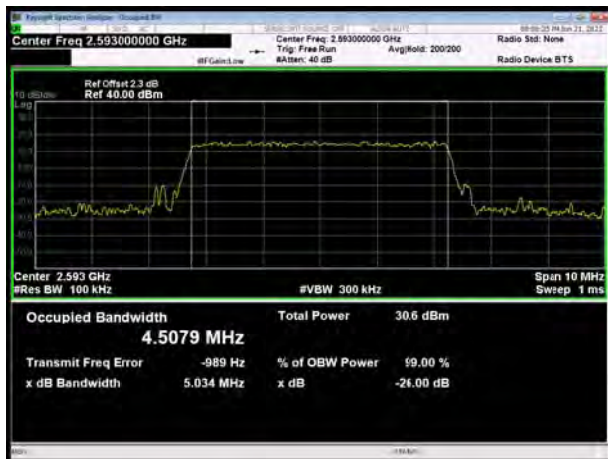

LTE Band 41 QPSK 10MHz CH-Middle

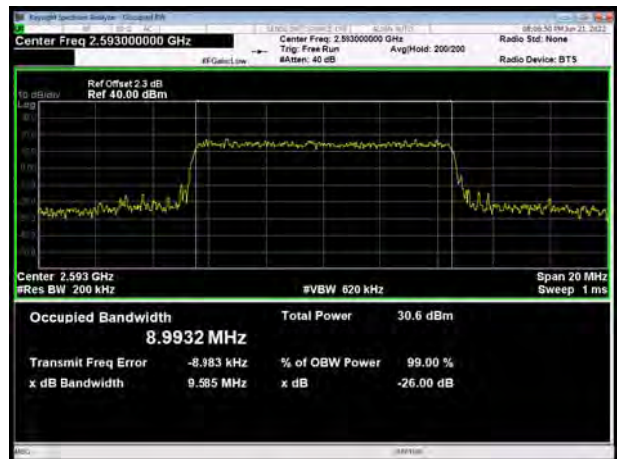

LTE Band 41 QPSK 5MHz CH-High

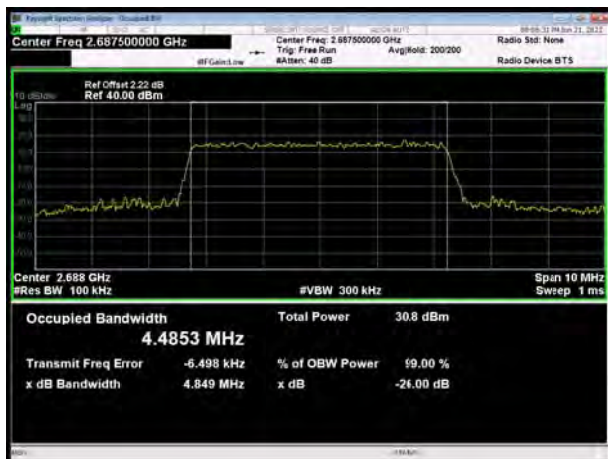

LTE Band 41 QPSK 10MHz CH-High

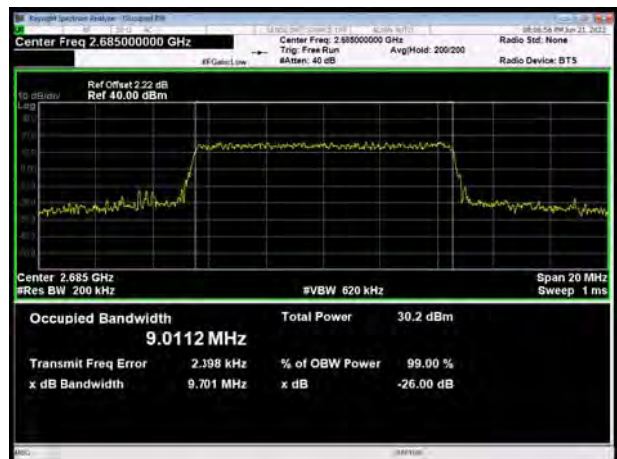



LTE Band 41 QPSK 15MHz CH-Low

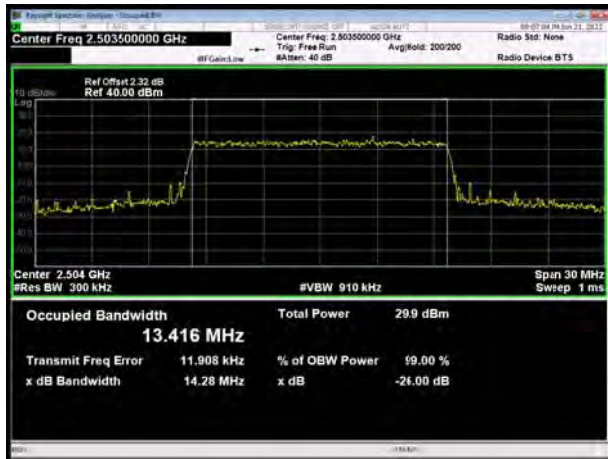

LTE Band 41 QPSK 20MHz CH-Low

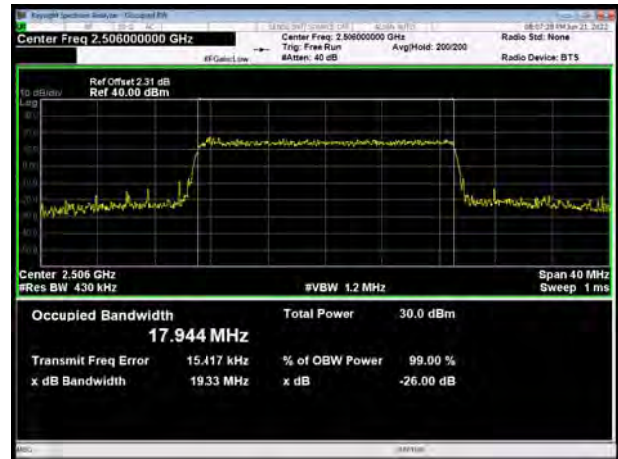

LTE Band 41 QPSK 15MHz CH-Middle

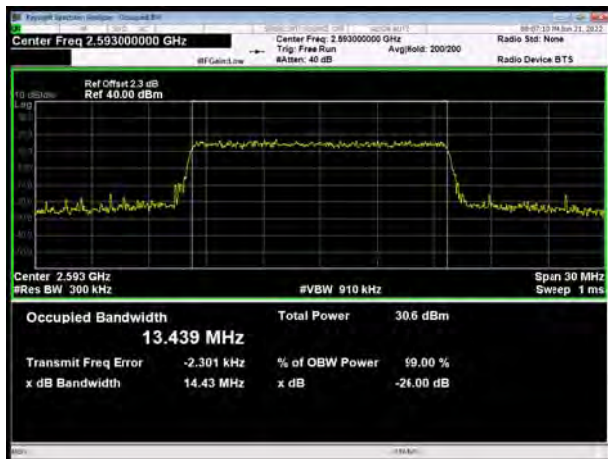

LTE Band 41 QPSK 20MHz CH-Middle

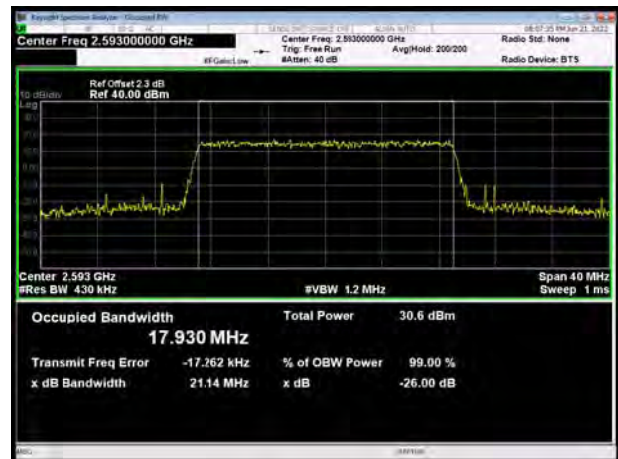

LTE Band 41 QPSK 15MHz CH-High

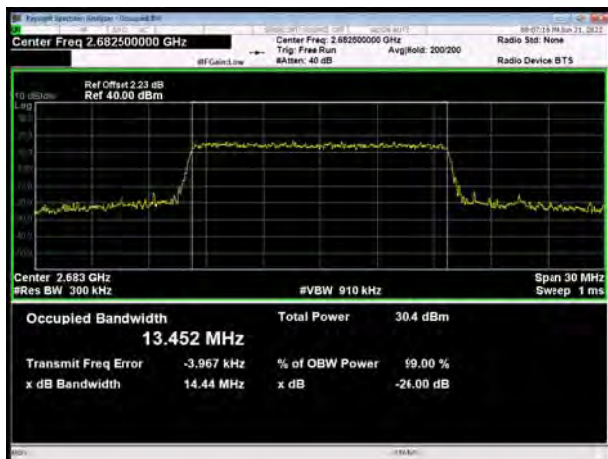

LTE Band 41 QPSK 20MHz CH-High

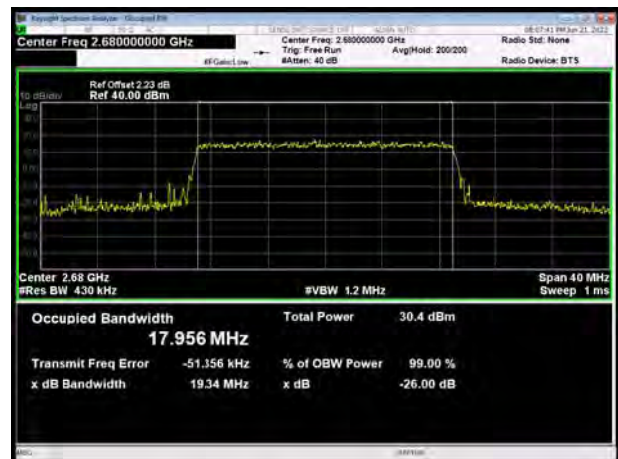



LTE Band 41 16QAM 5MHz CH-Low

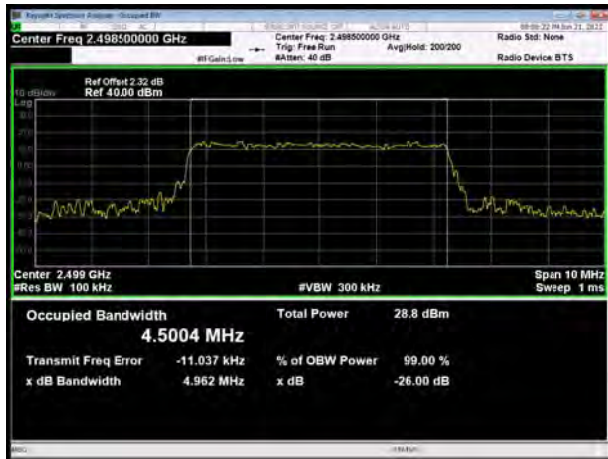

LTE Band 41 16QAM 10MHz CH-Low

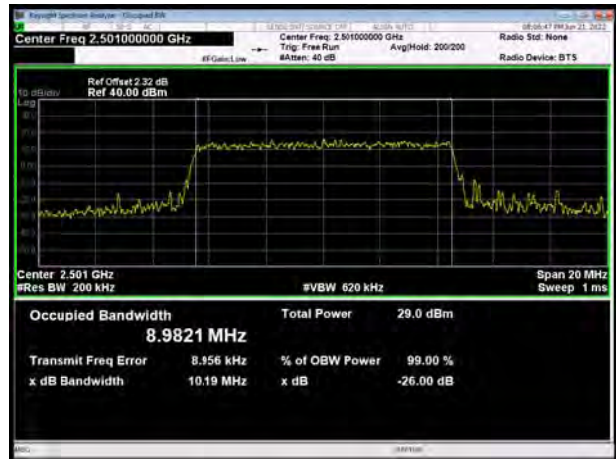

LTE Band 41 16QAM 5MHz CH-Middle

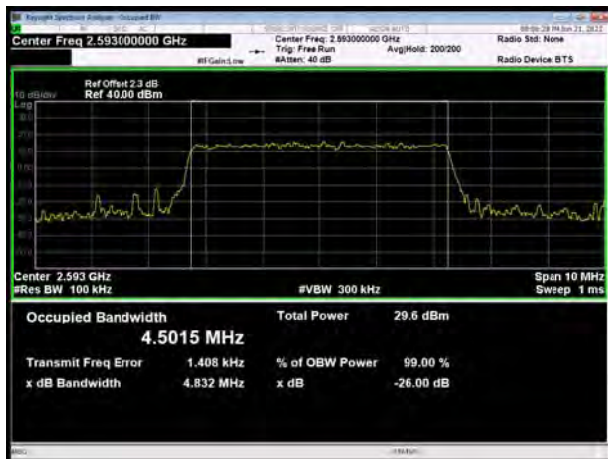

LTE Band 41 16QAM 10MHz CH-Middle

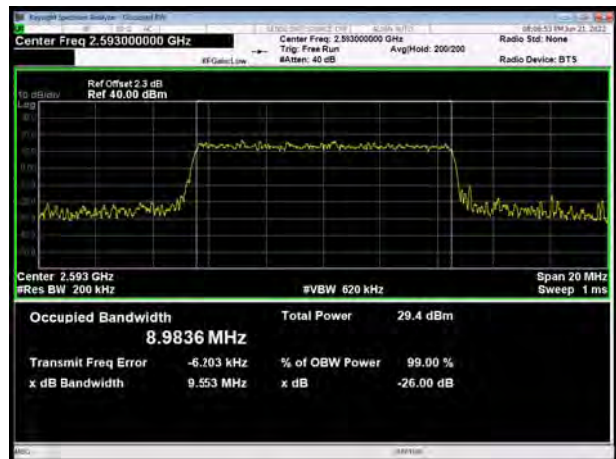

LTE Band 41 16QAM 5MHz CH-High

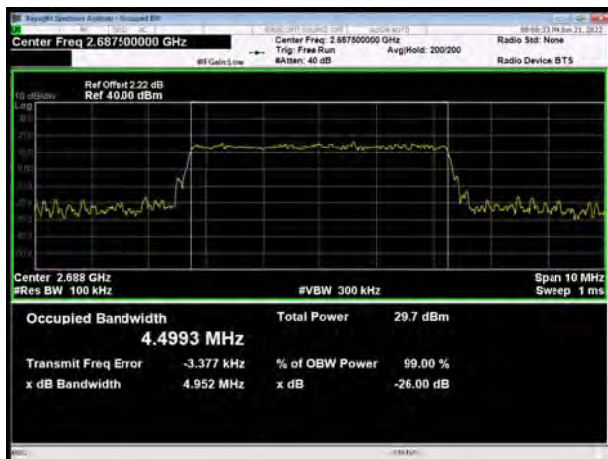

LTE Band 41 16QAM 10MHz CH-High

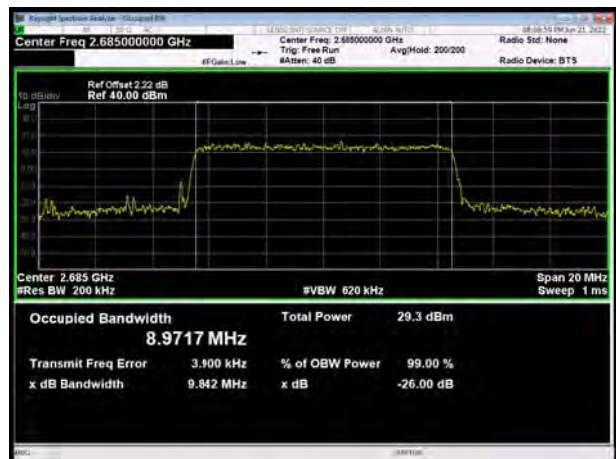



LTE Band 41 16QAM 15MHz CH-Low

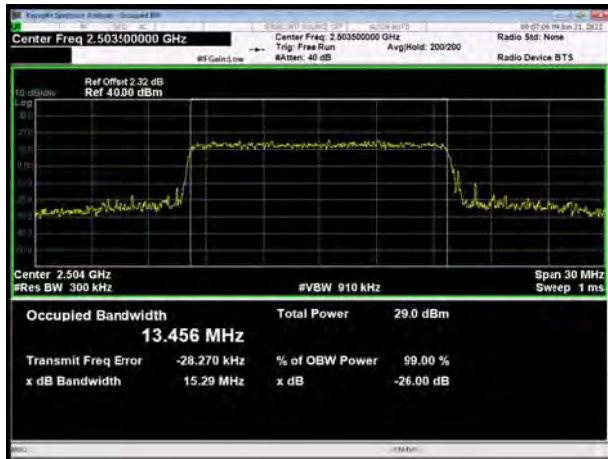

LTE Band 41 16QAM 20MHz CH-Low

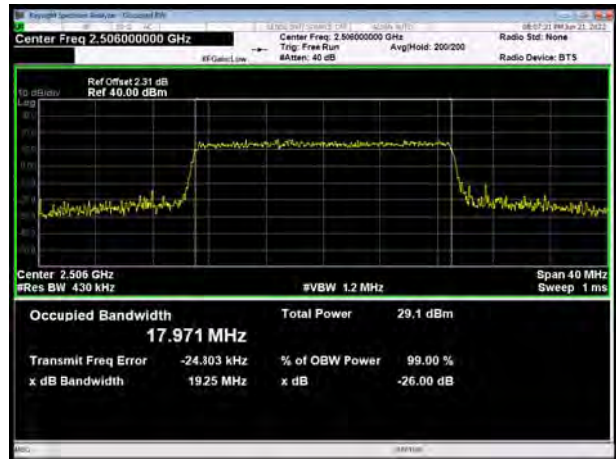

LTE Band 41 16QAM 15MHz CH-Middle

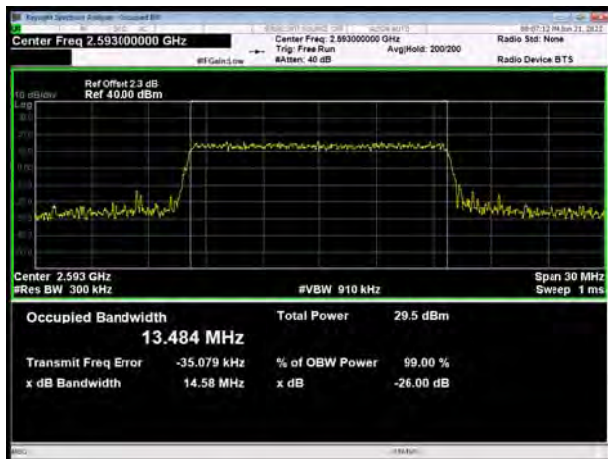

LTE Band 41 16QAM 20MHz CH-Middle

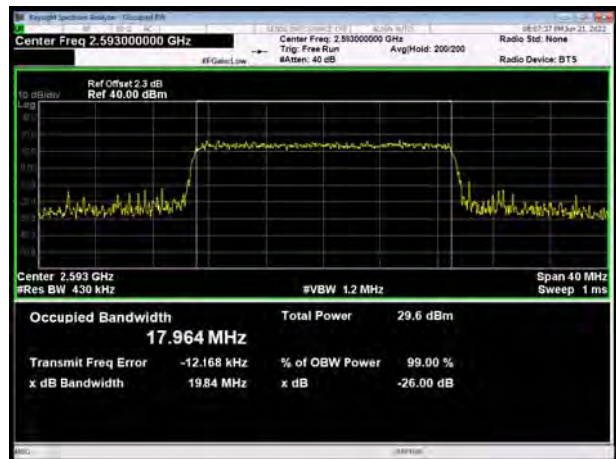

LTE Band 41 16QAM 15MHz CH-High

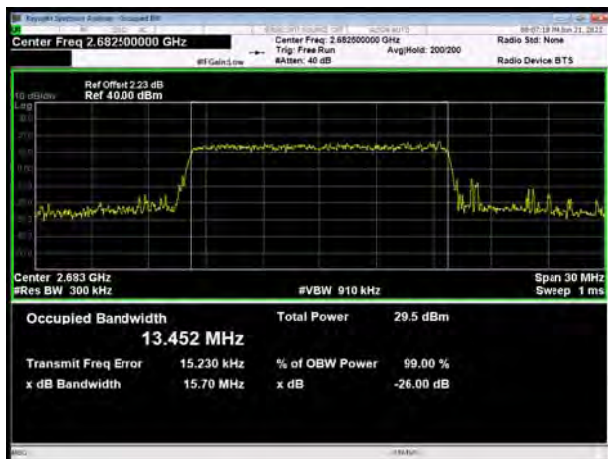

LTE Band 41 16QAM 20MHz CH-High

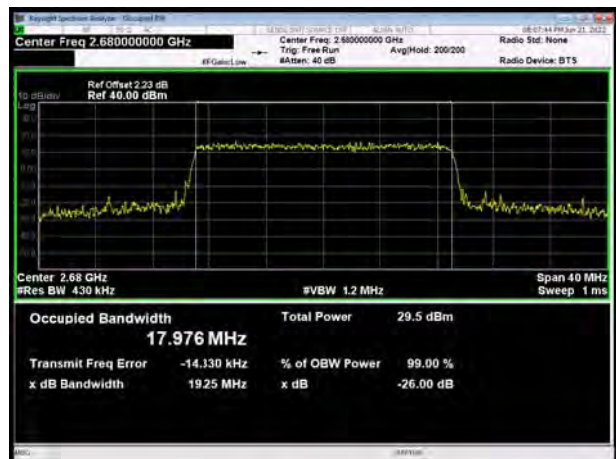

6.3 Band Edge Compliance

All the test traces in the plots shows the test results clearly.

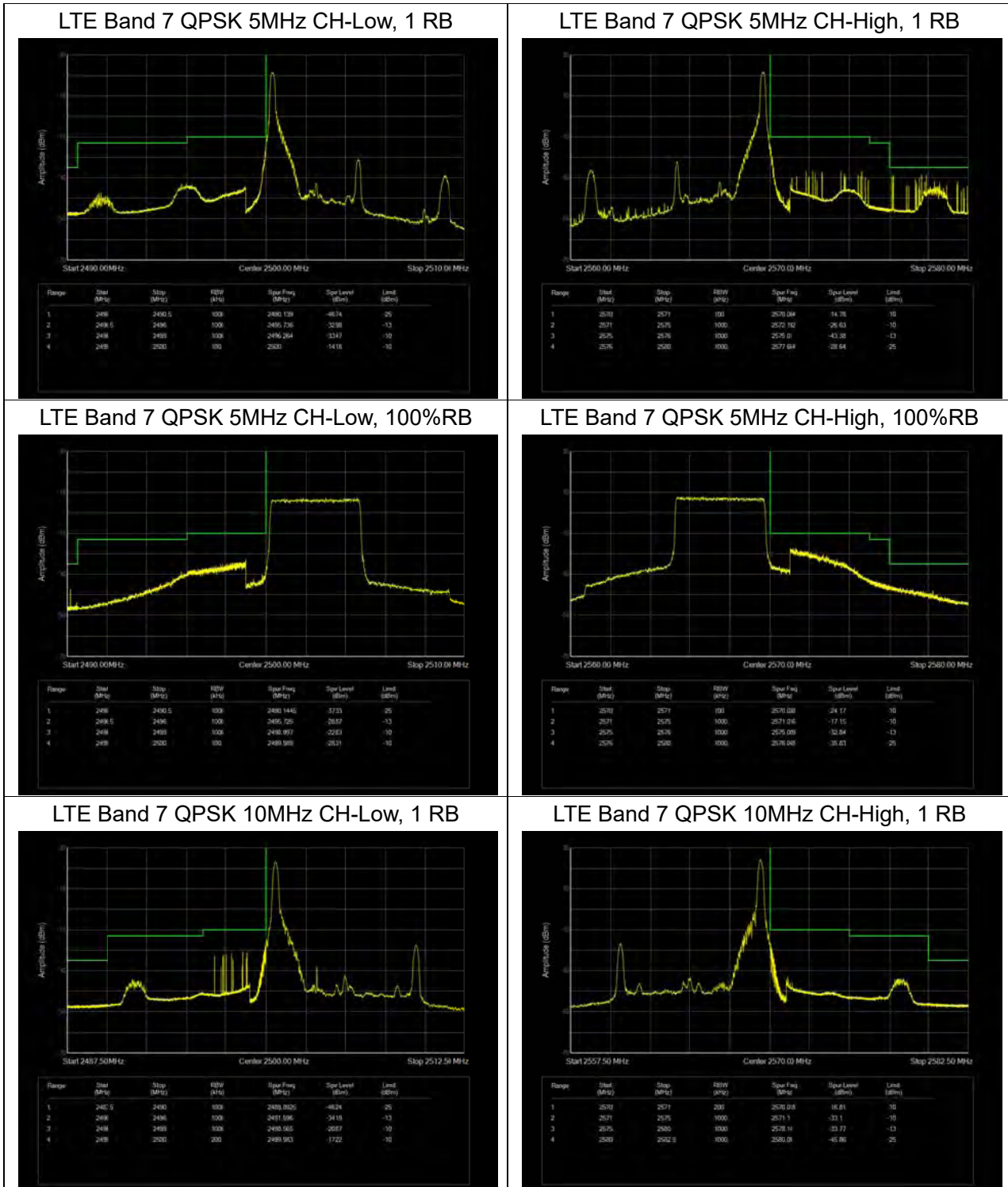



LTE Band 7 QPSK 10MHz CH-Low, 100%RB

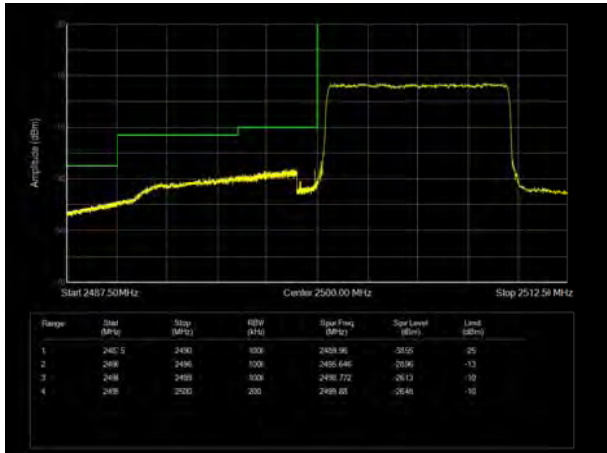

LTE Band 7 QPSK 10MHz CH-High, 100%RB

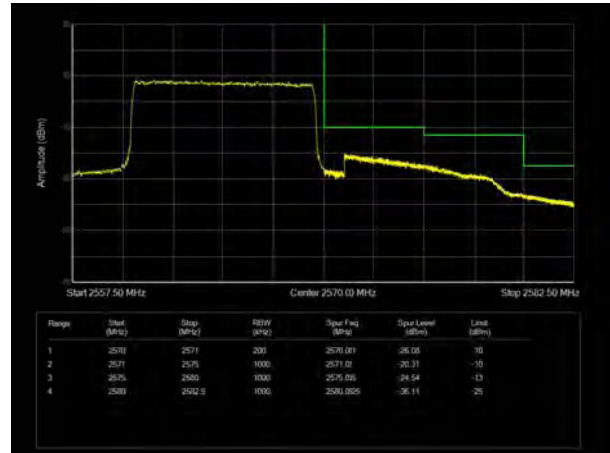

LTE Band 7 QPSK 15MHz CH-Low, 1 RB

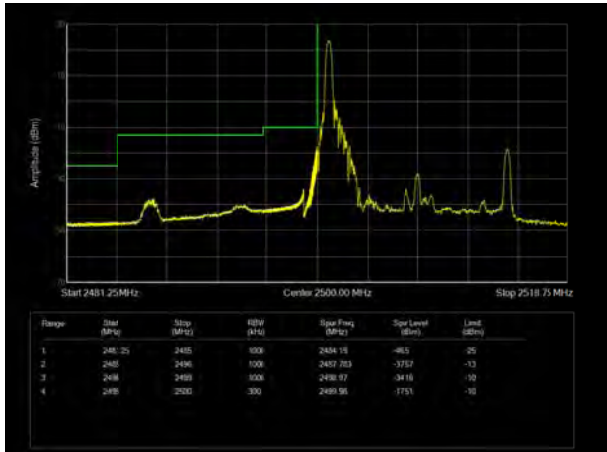

LTE Band 7 QPSK 15MHz CH-High, 1 RB

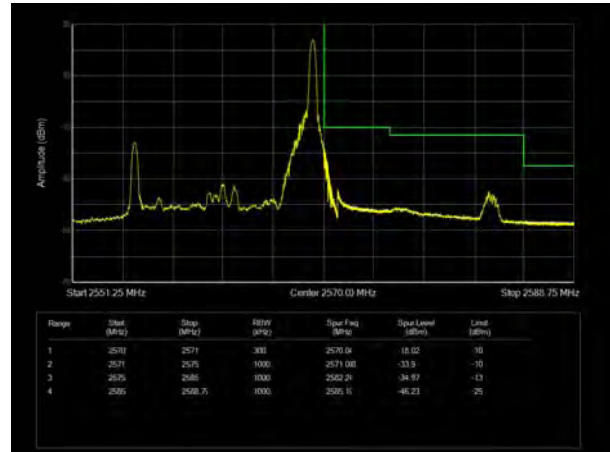

LTE Band 7 QPSK 15MHz CH-Low, 100%RB

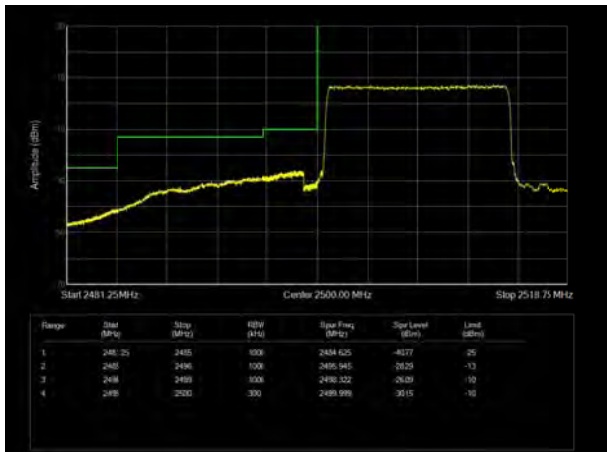

LTE Band 7 QPSK 15MHz CH-High, 100%RB

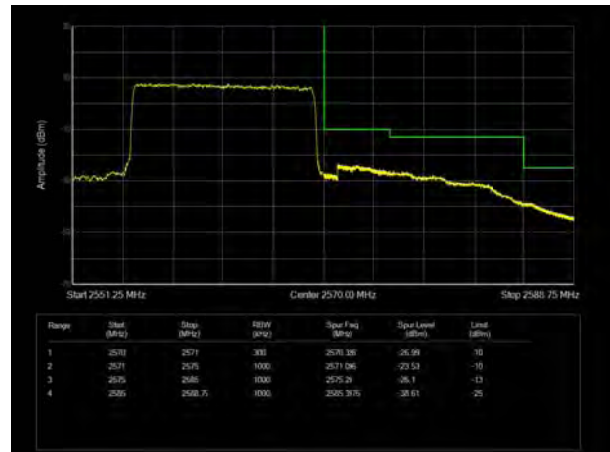

LTE Band 7 QPSK 20MHz CH-Low, 1 RB

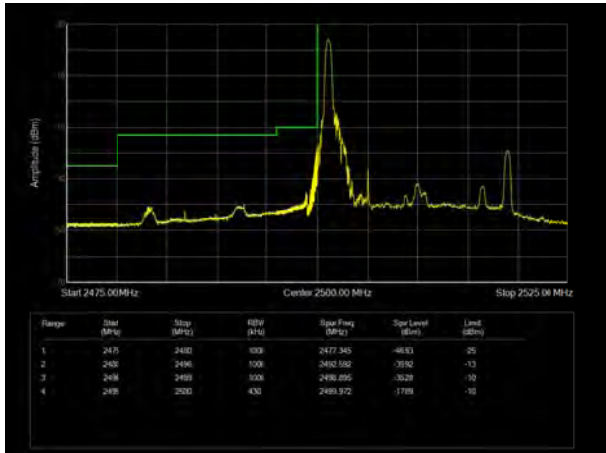

LTE Band 7 QPSK 20MHz CH-High, 1 RB

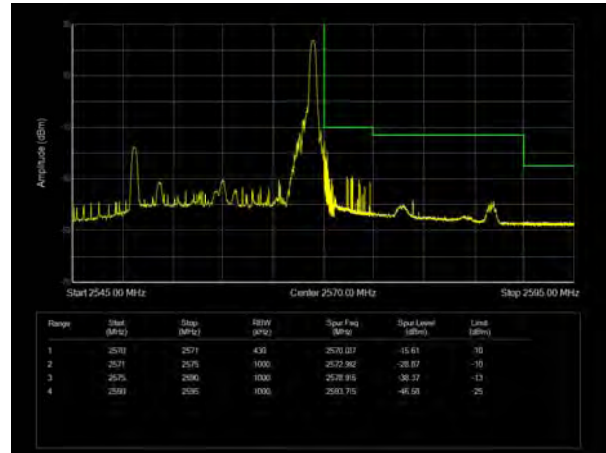

LTE Band 7 QPSK 20MHz CH-Low, 100%RB

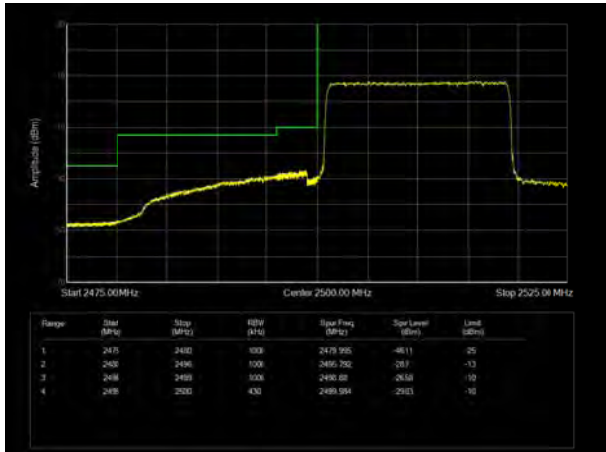

LTE Band 7 QPSK 20MHz CH-High, 100%RB

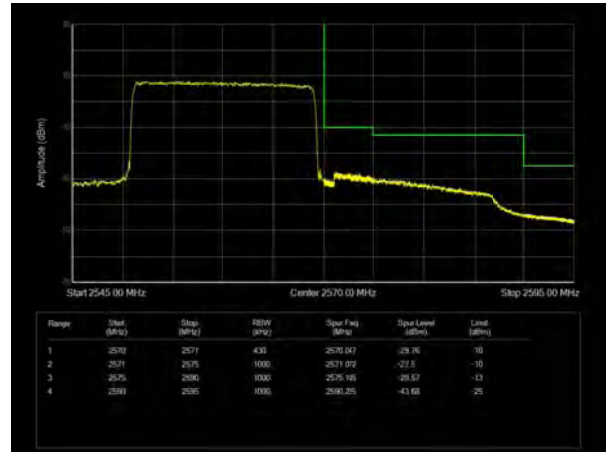

LTE Band 7 16QAM 5MHz CH-Low, 1 RB

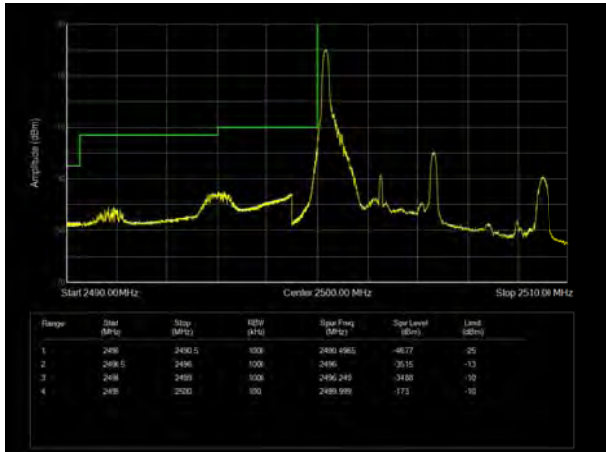

LTE Band 7 16QAM 5MHz CH-High, 1 RB

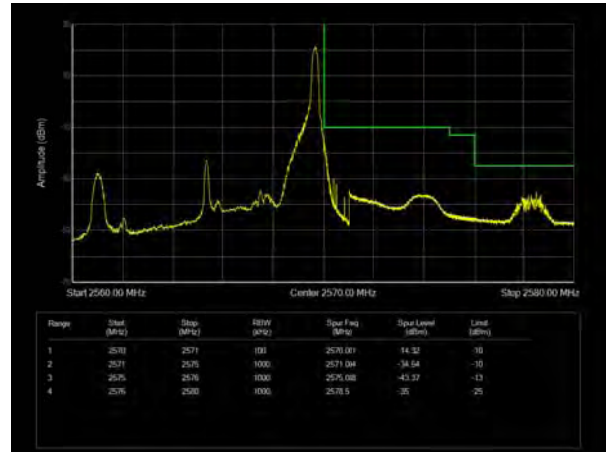



LTE Band 7 16QAM 5MHz CH-Low, 100%RB

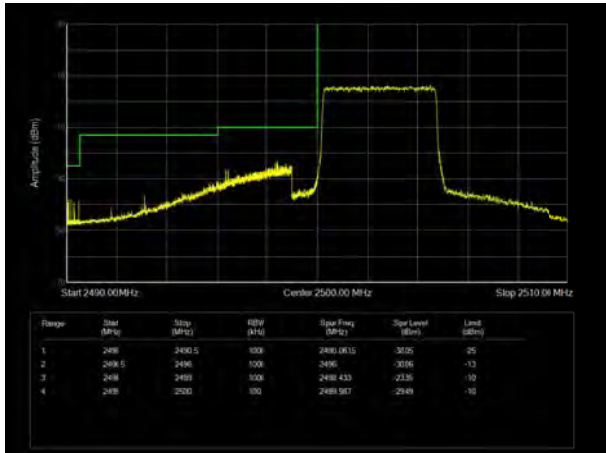

LTE Band 7 16QAM 5MHz CH-High, 100%RB

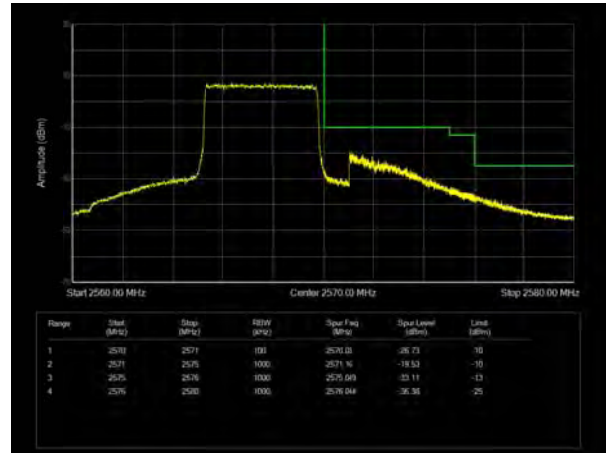

LTE Band 7 16QAM 10MHz CH-Low, 1 RB

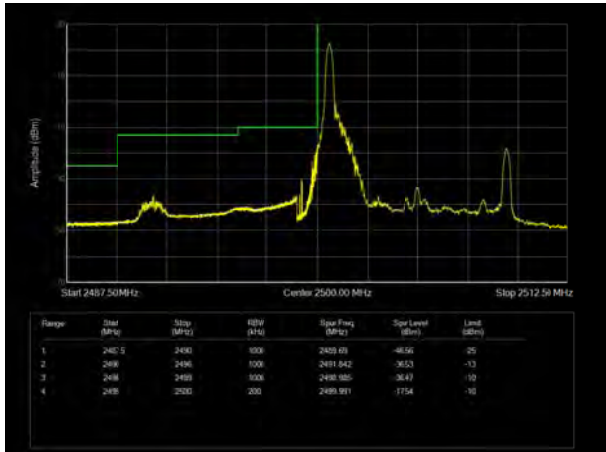

LTE Band 7 16QAM 10MHz CH-High, 1 RB

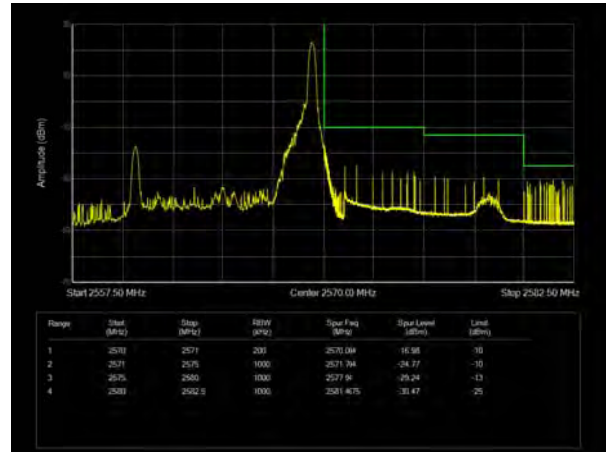

LTE Band 7 16QAM 10MHz CH-Low, 100%RB

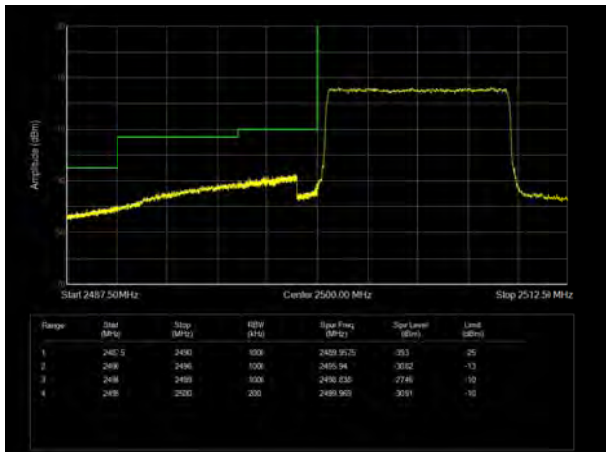

LTE Band 7 16QAM 10MHz CH-High, 100%RB

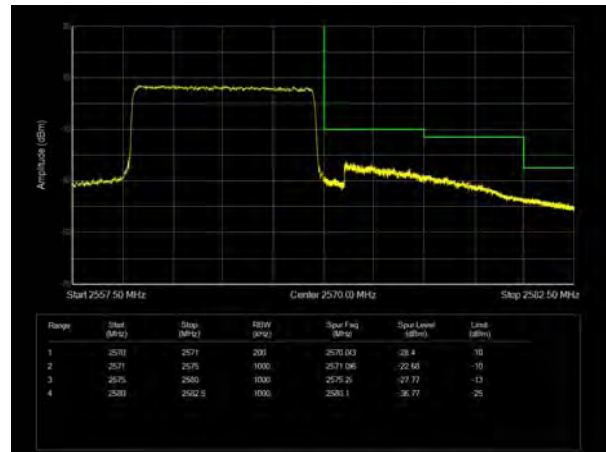



LTE Band 7 16QAM 15MHz CH-Low, 1 RB

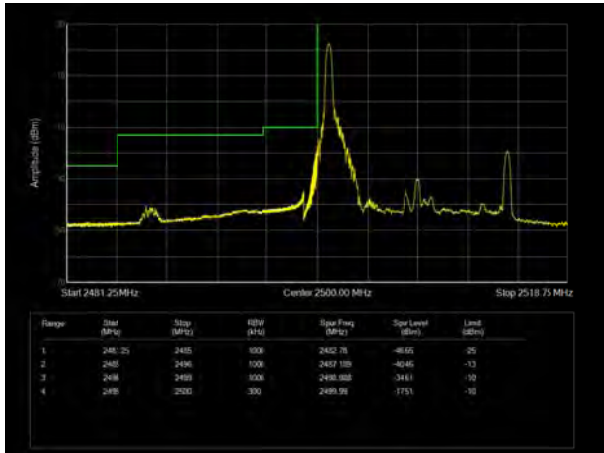

LTE Band 7 16QAM 15MHz CH-High, 1 RB

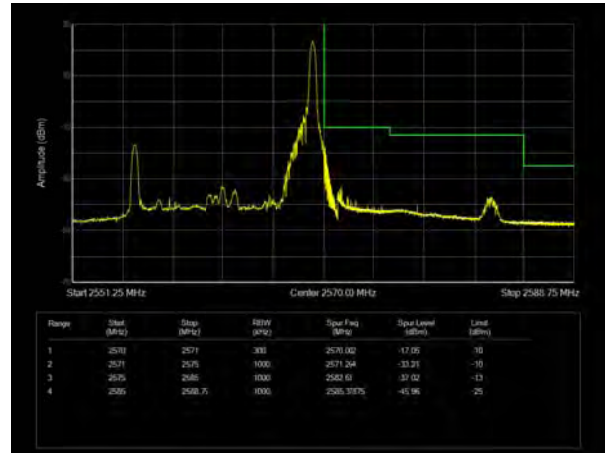

LTE Band 7 16QAM 15MHz CH-Low, 100%RB

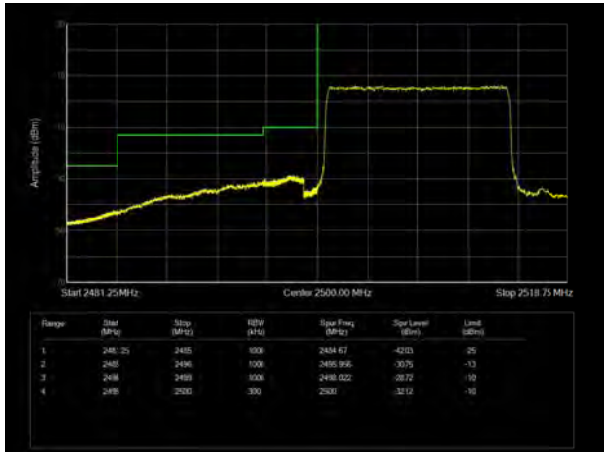

LTE Band 7 16QAM 15MHz CH-High, 100%RB

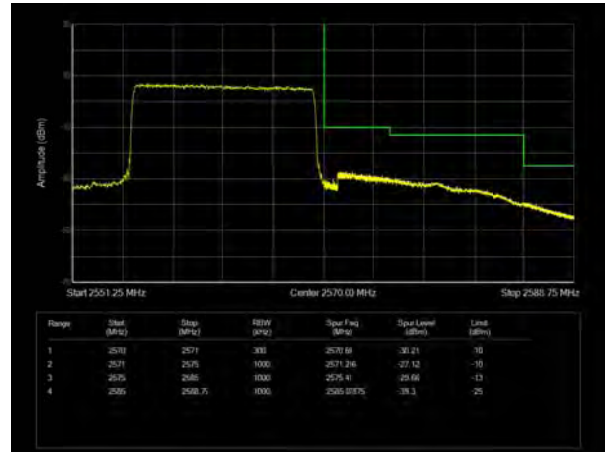

LTE Band 7 16QAM 20MHz CH-Low, 1 RB

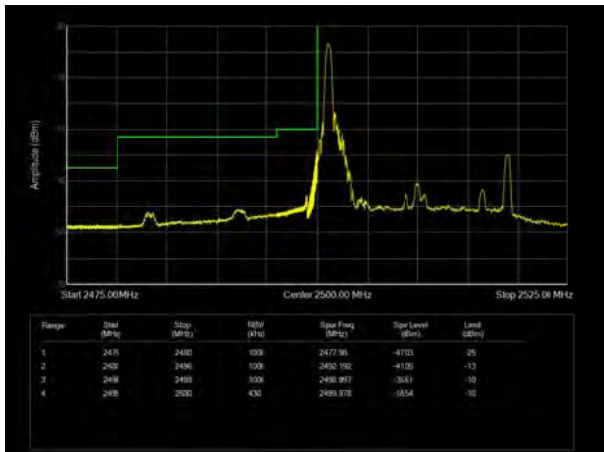

LTE Band 7 16QAM 20MHz CH-High, 1 RB

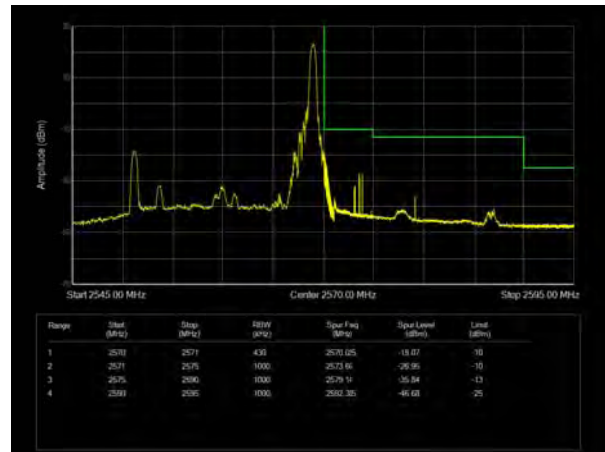



LTE Band 7 16QAM 20MHz CH-Low, 100%RB

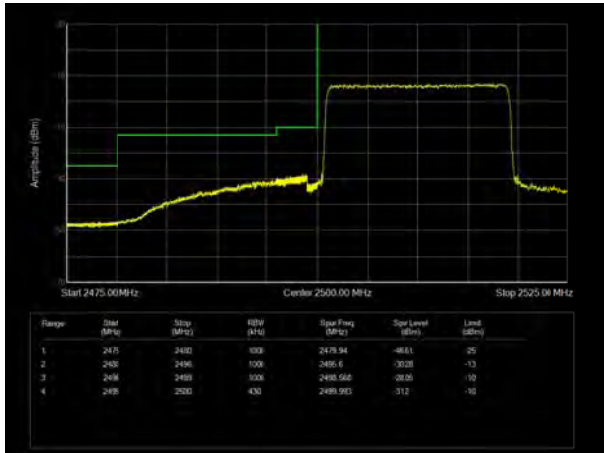

LTE Band 7 16QAM 20MHz CH-High, 100%RB

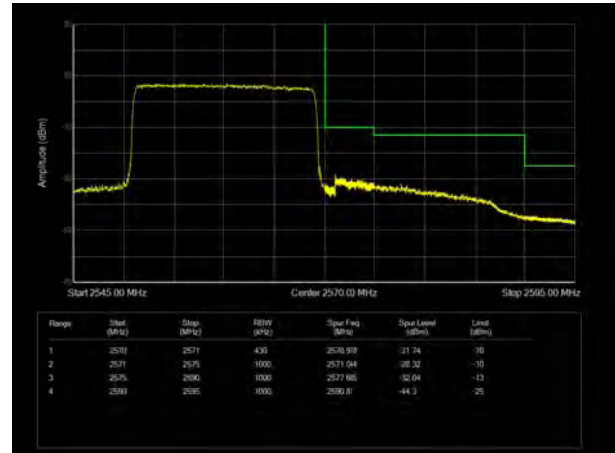

LTE Band 38 QPSK 5MHz CH-Low, 1 RB

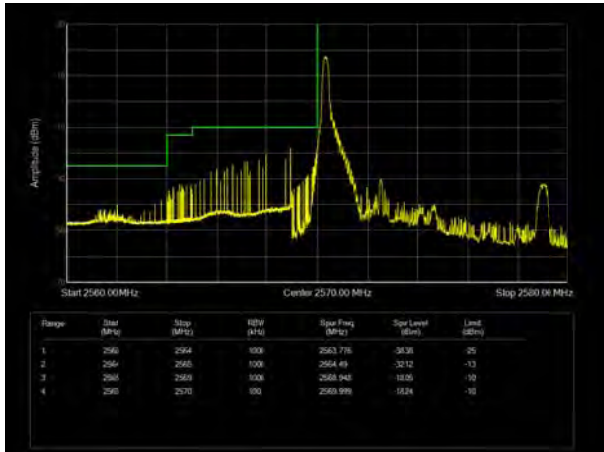

LTE Band 38 QPSK 5MHz CH-High, 1 RB

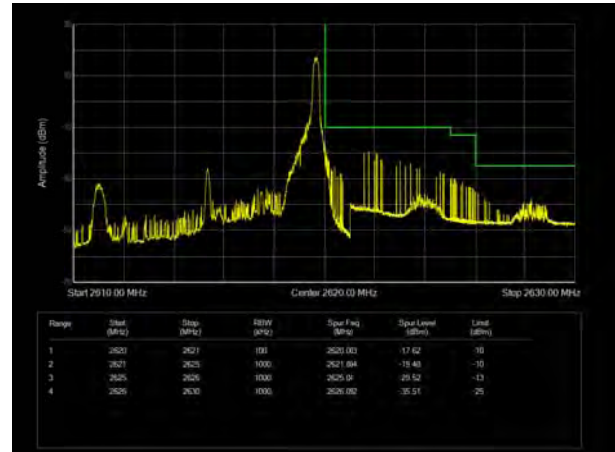

LTE Band 38 QPSK 5MHz CH-Low, 100%RB

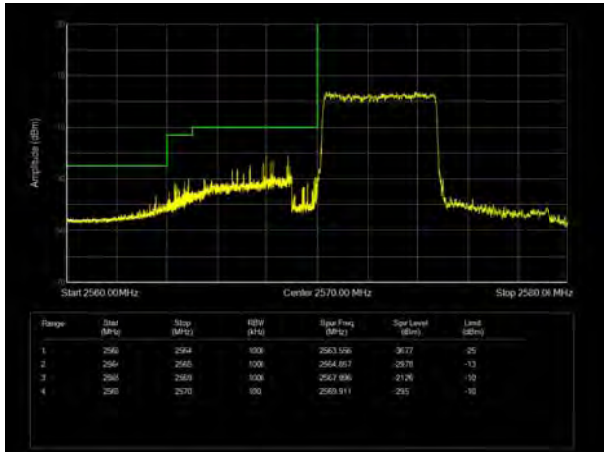

LTE Band 38 QPSK 5MHz CH-High, 100%RB

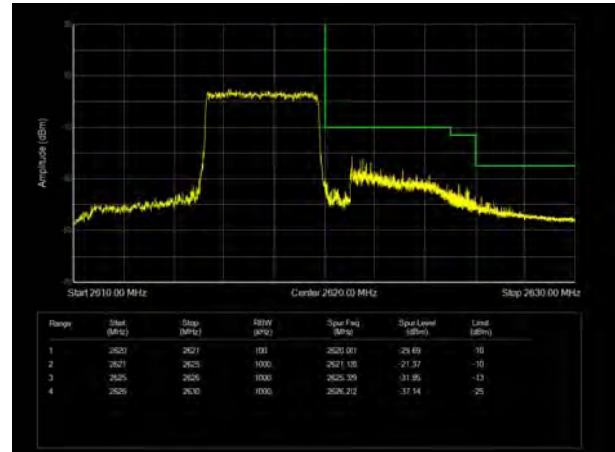



LTE Band 38 QPSK 10MHz CH-Low, 1 RB

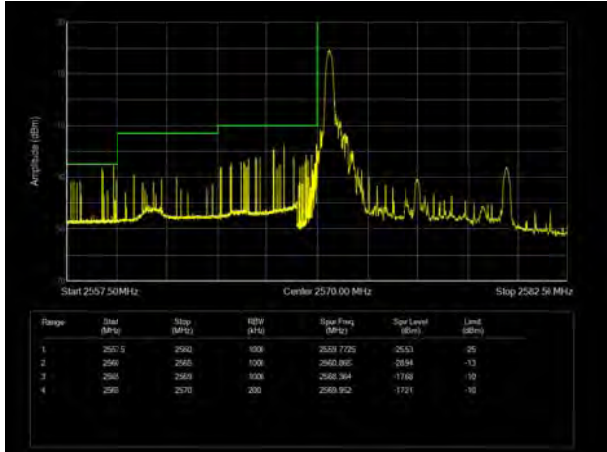

LTE Band 38 QPSK 10MHz CH-High, 1 RB

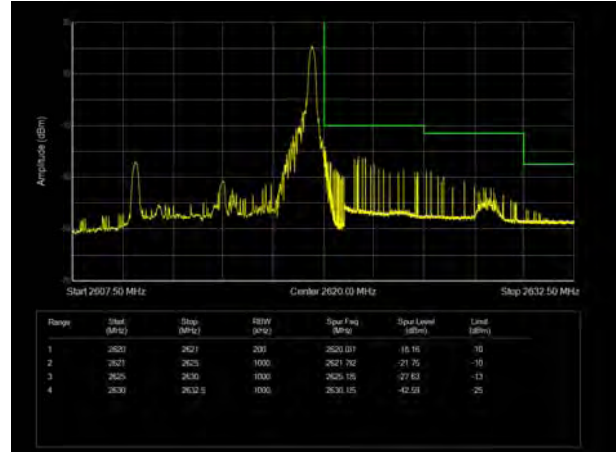

LTE Band 38 QPSK 10MHz CH-Low, 100%RB

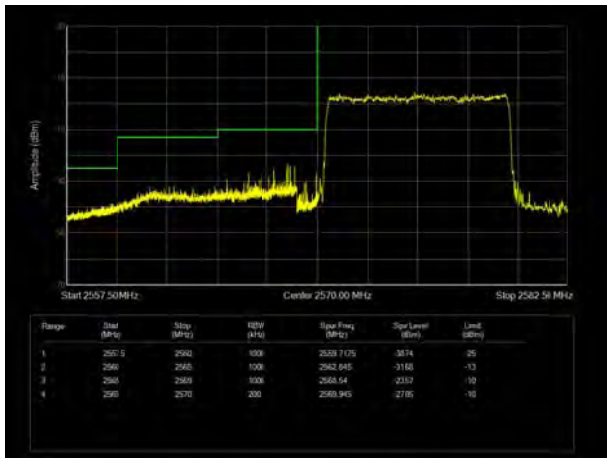

LTE Band 38 QPSK 10MHz CH-High, 100%RB

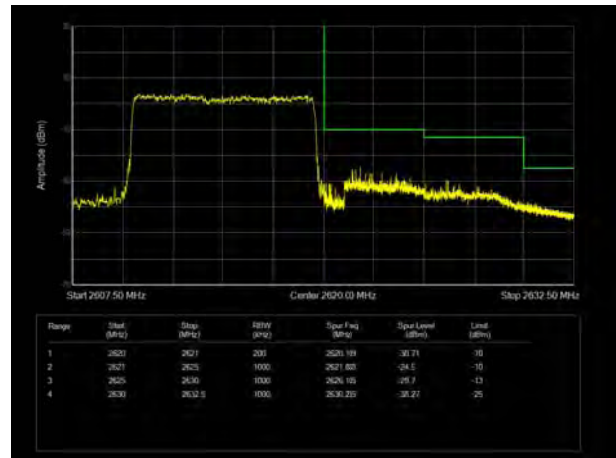

LTE Band 38 QPSK 15MHz CH-Low, 1 RB

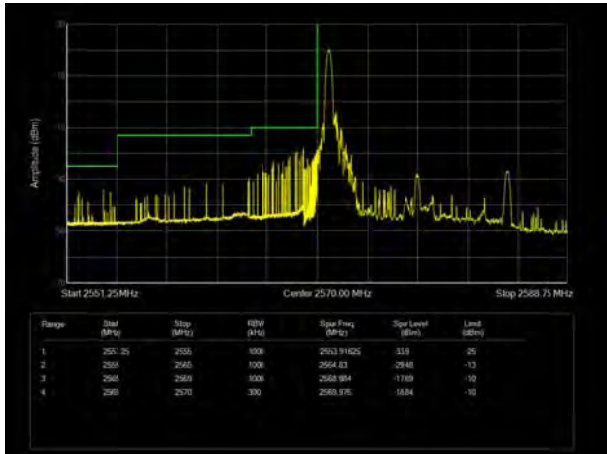

LTE Band 38 QPSK 15MHz CH-High, 1 RB

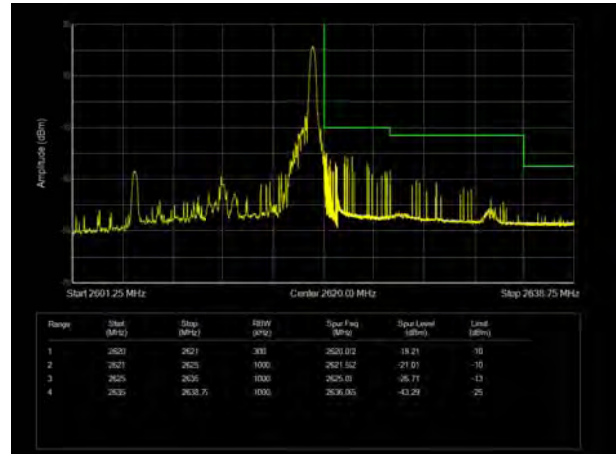



LTE Band 38 QPSK 15MHz CH-Low, 100%RB

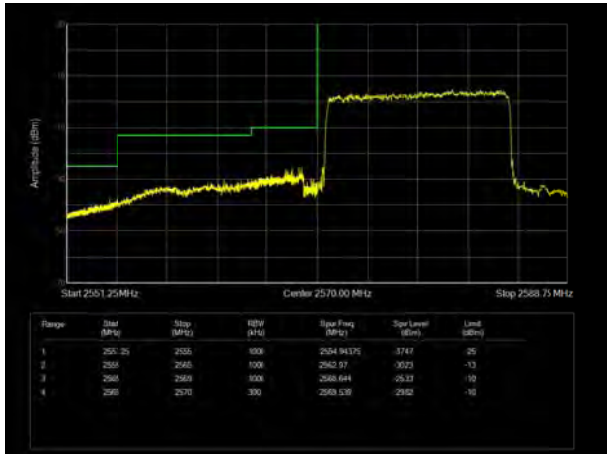

LTE Band 38 QPSK 15MHz CH-High, 100%RB

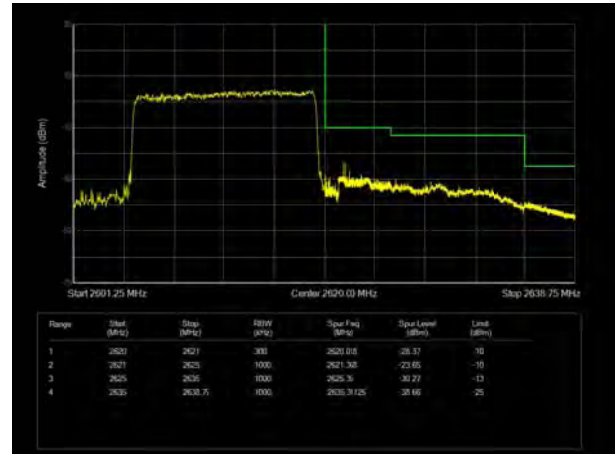

LTE Band 38 QPSK 20MHz CH-Low, 1 RB

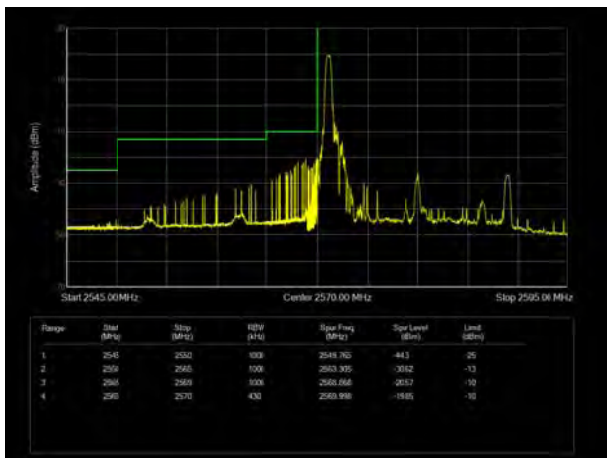

LTE Band 38 QPSK 20MHz CH-High, 1 RB

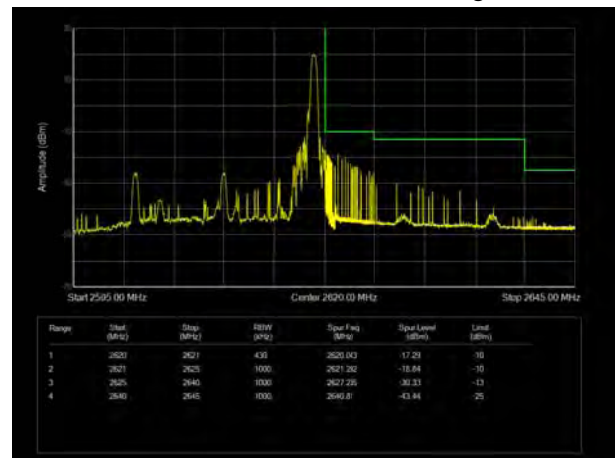

LTE Band 38 QPSK 20MHz CH-Low, 100%RB

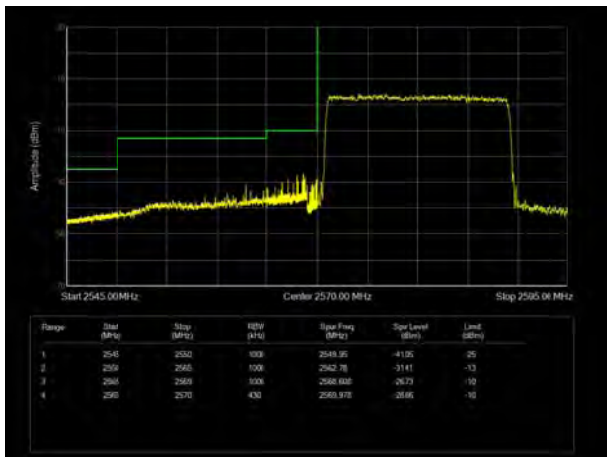

LTE Band 38 QPSK 20MHz CH-High, 100%RB

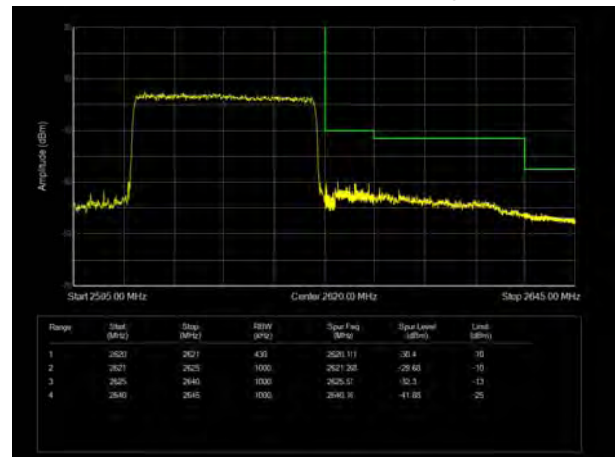



LTE Band 38 16QAM 5MHz CH-Low, 1 RB

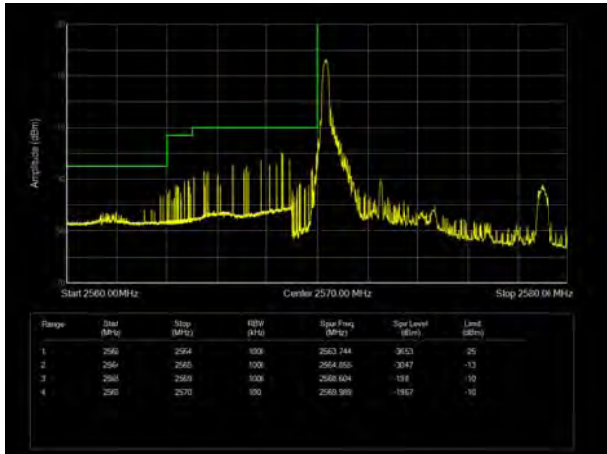

LTE Band 38 16QAM 5MHz CH-High, 1 RB

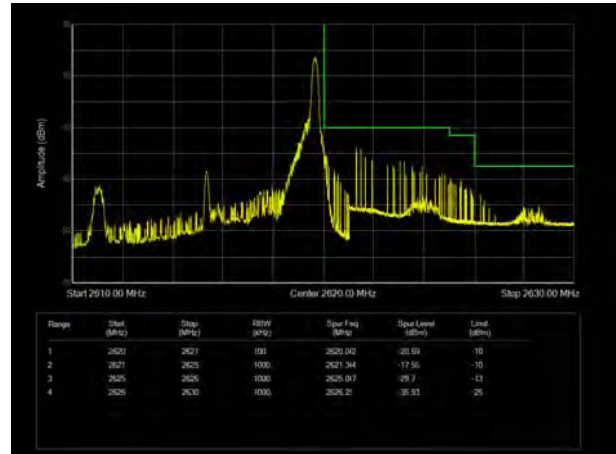

LTE Band 38 16QAM 5MHz CH-Low, 100%RB

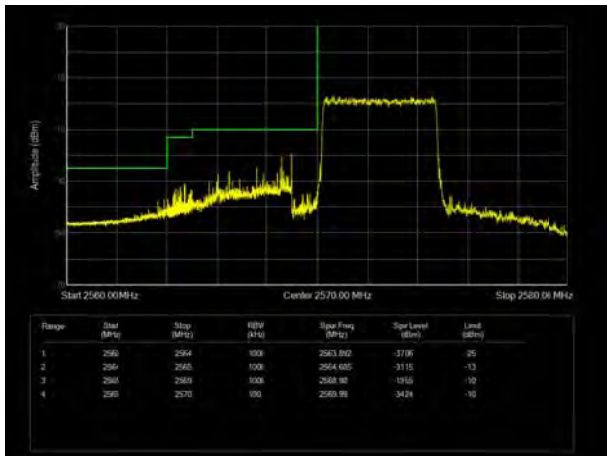

LTE Band 38 16QAM 5MHz CH-High, 100%RB

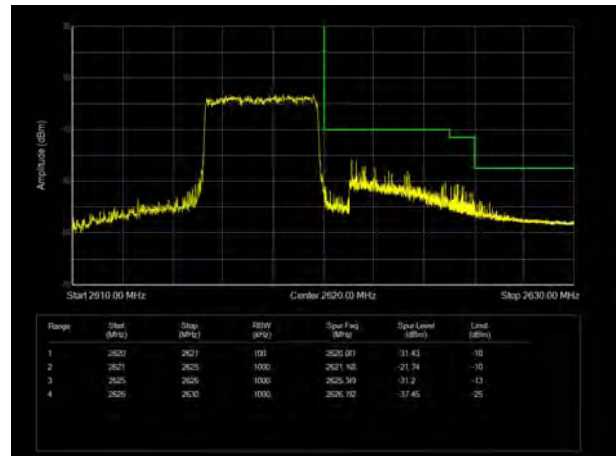

LTE Band 38 16QAM 10MHz CH-Low, 1 RB

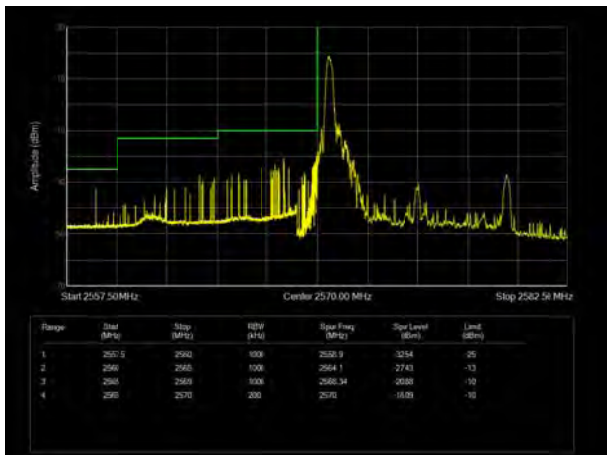

LTE Band 38 16QAM 10MHz CH-High, 1 RB

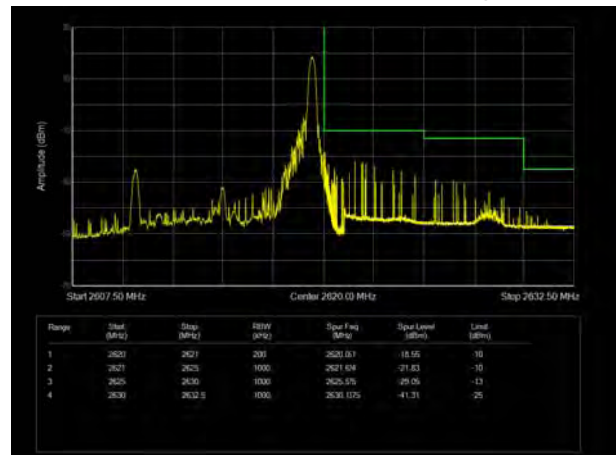



LTE Band 38 16QAM 10MHz CH-Low, 100%RB

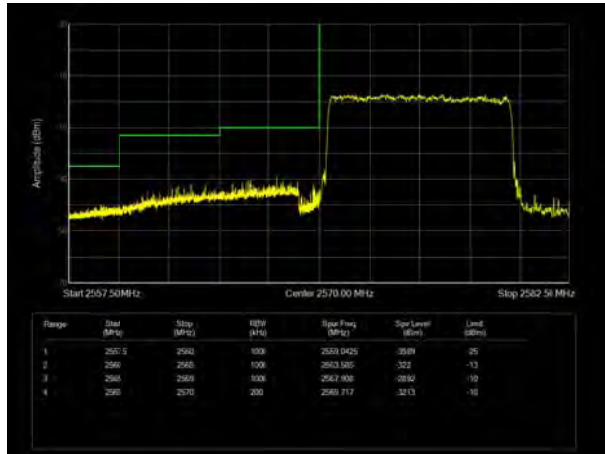

LTE Band 38 16QAM 10MHz CH-High, 100%RB

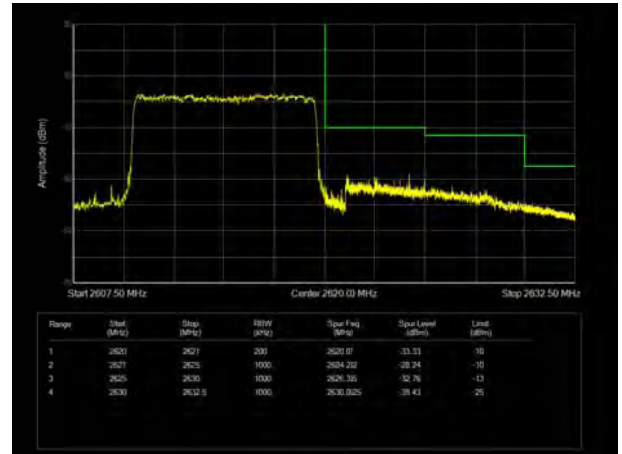

LTE Band 38 16QAM 15MHz CH-Low, 1 RB

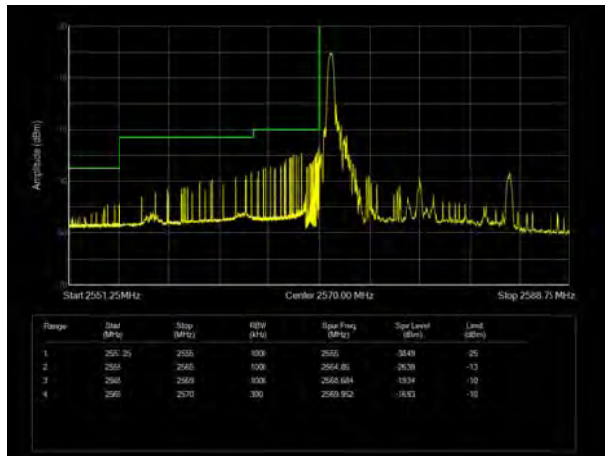

LTE Band 38 16QAM 15MHz CH-High, 1 RB

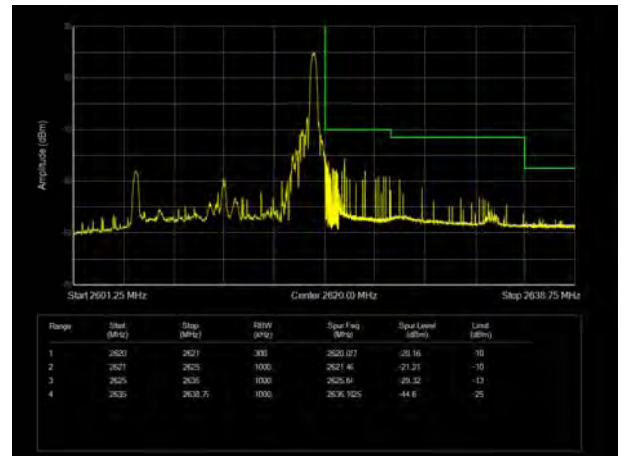

LTE Band 38 16QAM 15MHz CH-Low, 100%RB

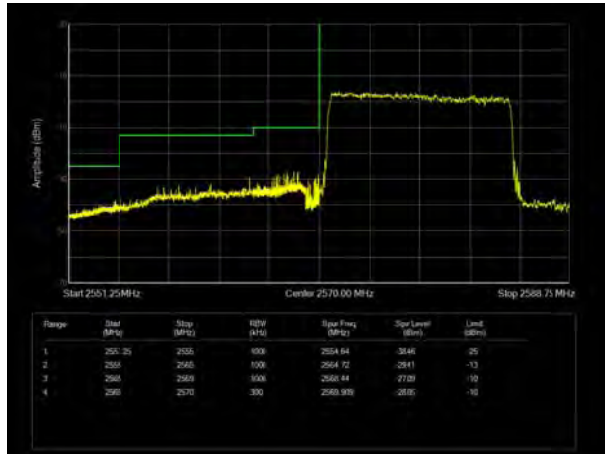

LTE Band 38 16QAM 15MHz CH-High, 100%RB

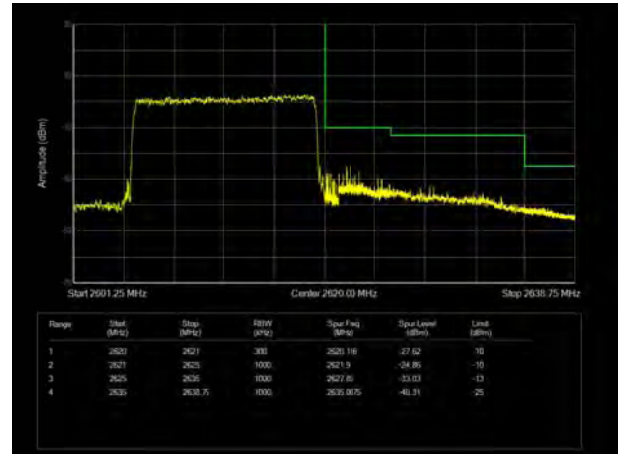



LTE Band 38 16QAM 20MHz CH-Low, 1 RB

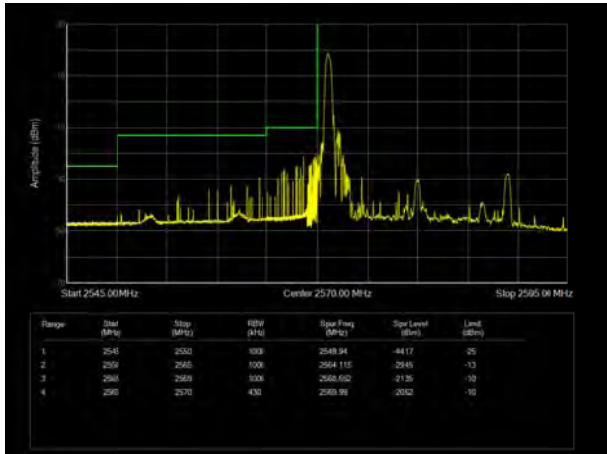

LTE Band 38 16QAM 20MHz CH-High, 1 RB

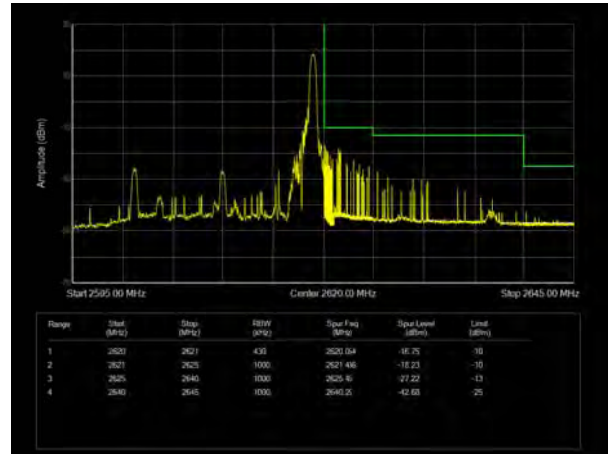

LTE Band 38 16QAM 20MHz CH-Low, 100%RB

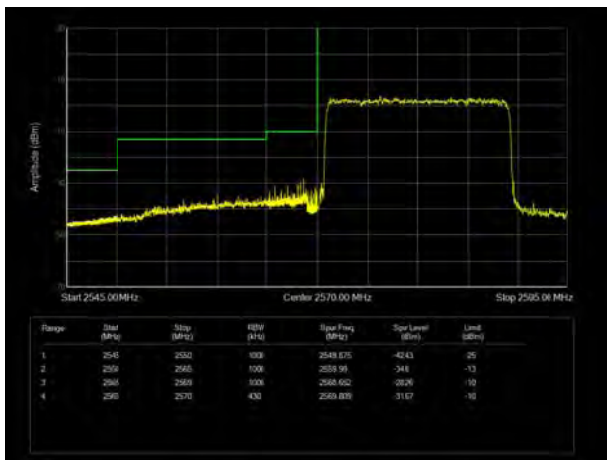

LTE Band 38 16QAM 20MHz CH-High, 100%RB

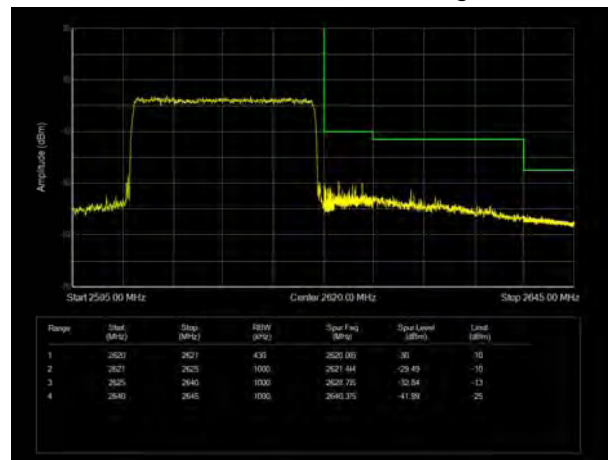

LTE Band 41 QPSK 5MHz CH-Low, 1 RB

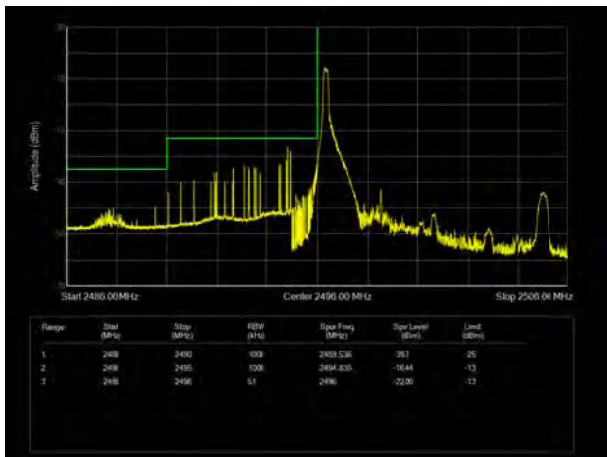

LTE Band 41 QPSK 5MHz CH-High, 1 RB

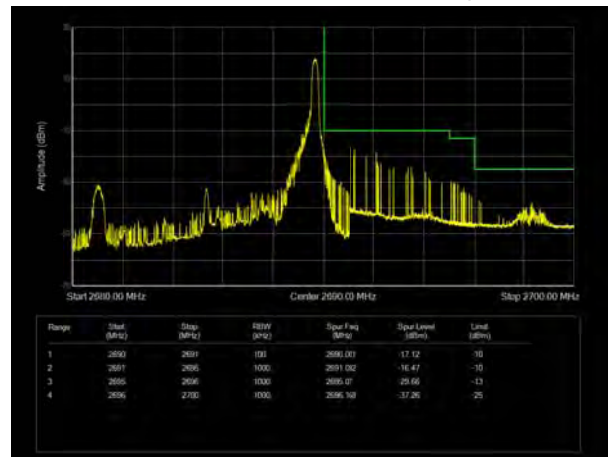



LTE Band 41 QPSK 5MHz CH-Low, 100%RB

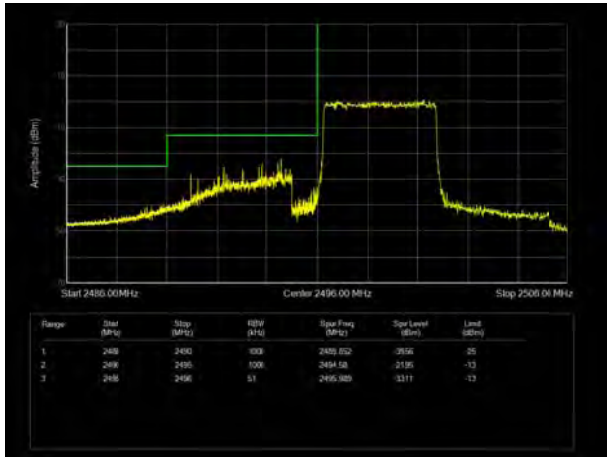

LTE Band 41 QPSK 5MHz CH-High, 100%RB

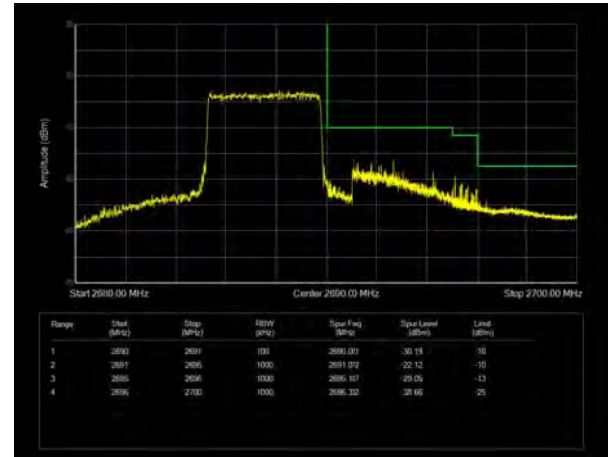

LTE Band 41 QPSK 10MHz CH-Low, 1 RB

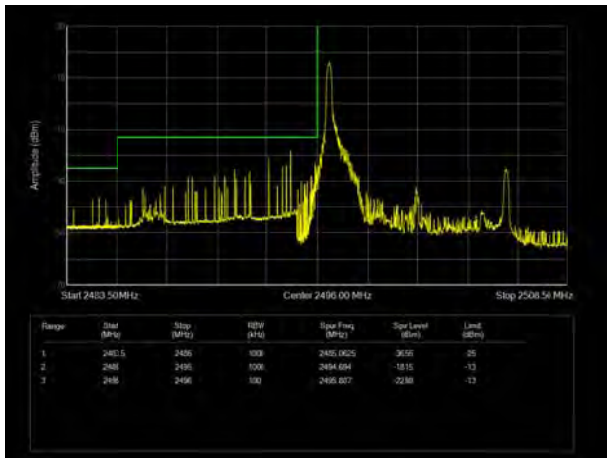

LTE Band 41 QPSK 10MHz CH-High, 1 RB

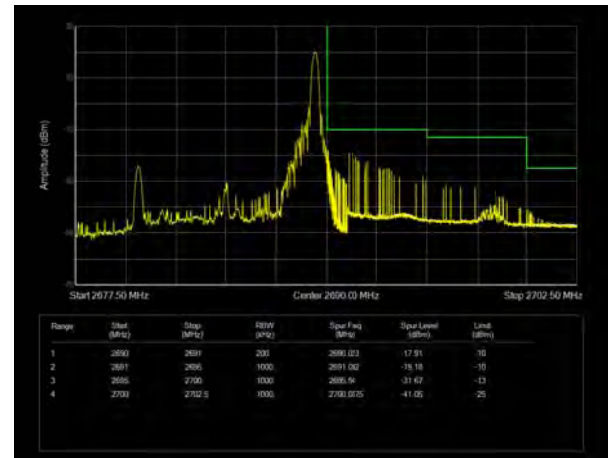

LTE Band 41 QPSK 10MHz CH-Low, 100%RB

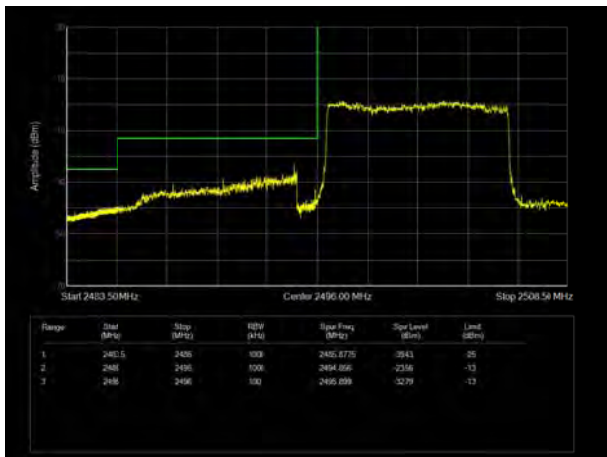

LTE Band 41 QPSK 10MHz CH-High, 100%RB

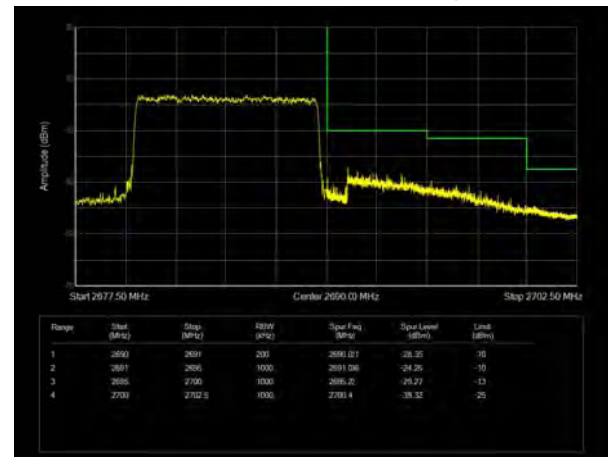



LTE Band 41 QPSK 15MHz CH-Low, 1 RB

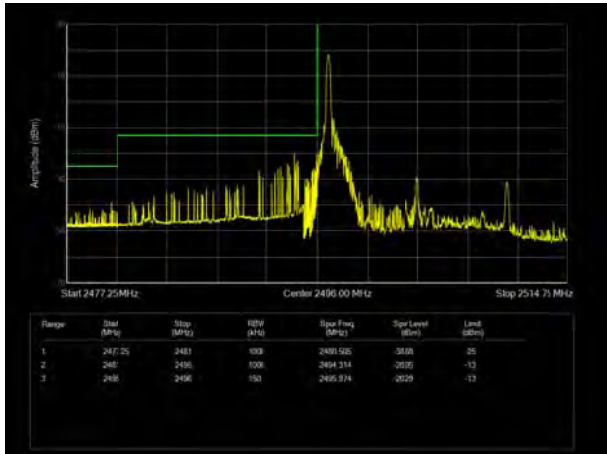

LTE Band 41 QPSK 15MHz CH-High, 1 RB

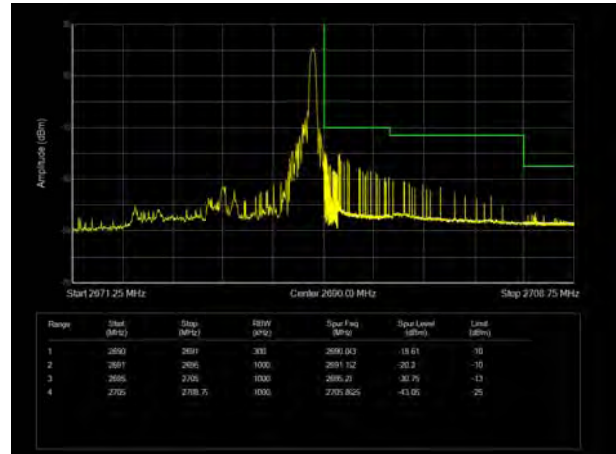

LTE Band 41 QPSK 15MHz CH-Low, 100%RB

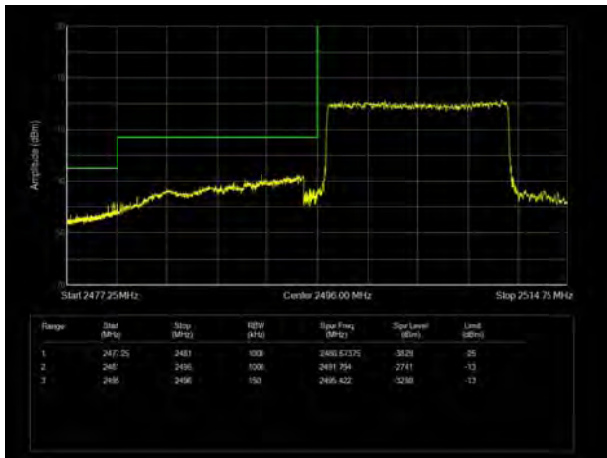

LTE Band 41 QPSK 15MHz CH-High, 100%RB

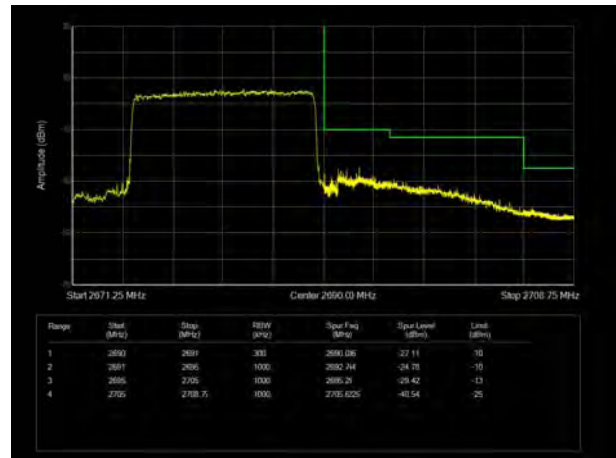

LTE Band 41 QPSK 20MHz CH-Low, 1 RB

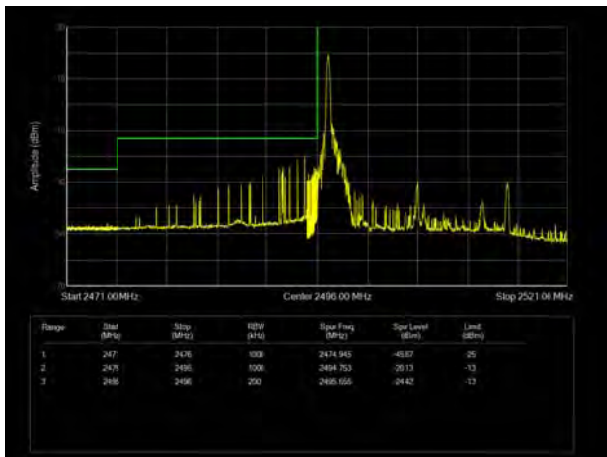

LTE Band 41 QPSK 20MHz CH-High, 1 RB

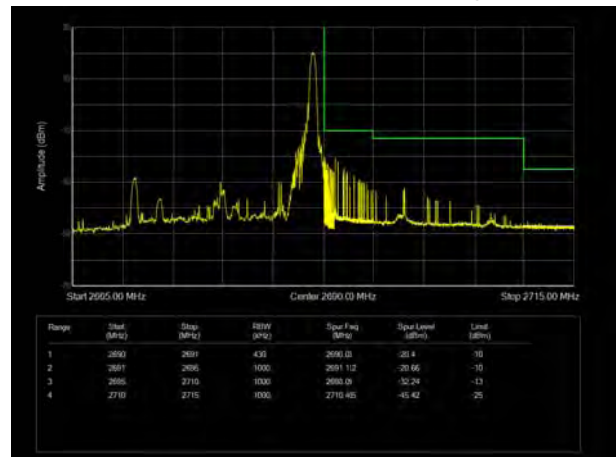



LTE Band 41 QPSK 20MHz CH-Low, 100%RB

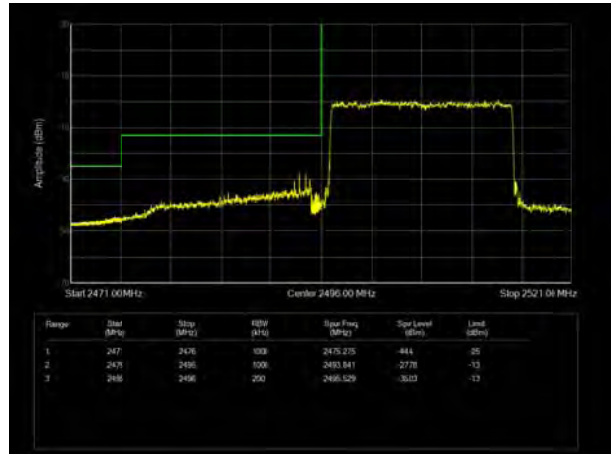

LTE Band 41 QPSK 20MHz CH-High, 100%RB

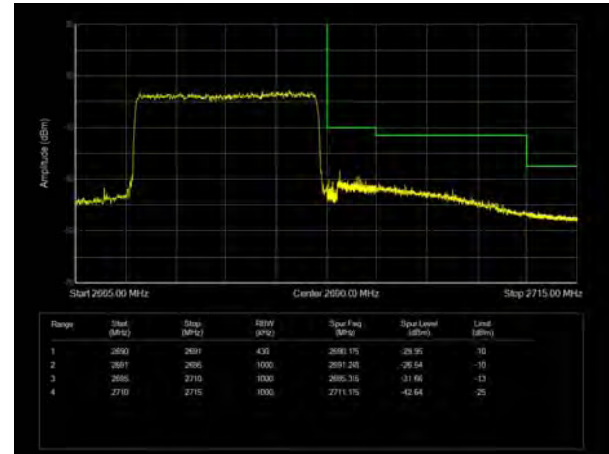

LTE Band 41 16QAM 5MHz CH-Low, 1 RB

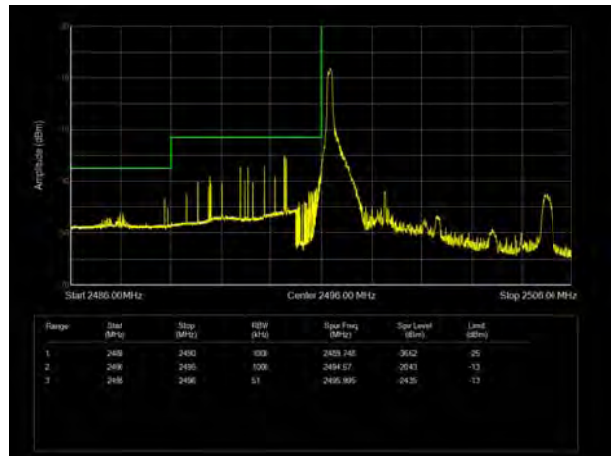

LTE Band 41 16QAM 5MHz CH-High, 1 RB

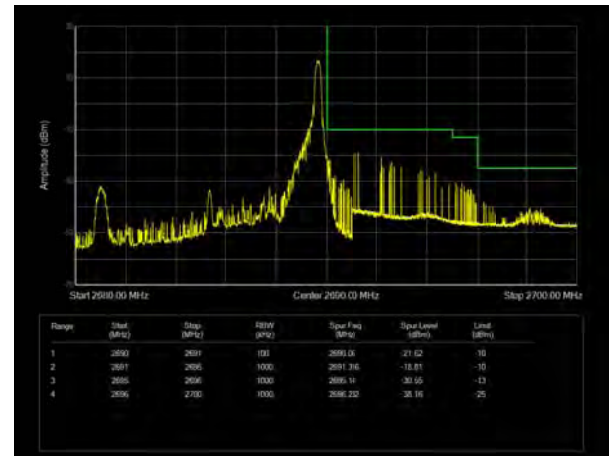

LTE Band 41 16QAM 5MHz CH-Low, 100%RB

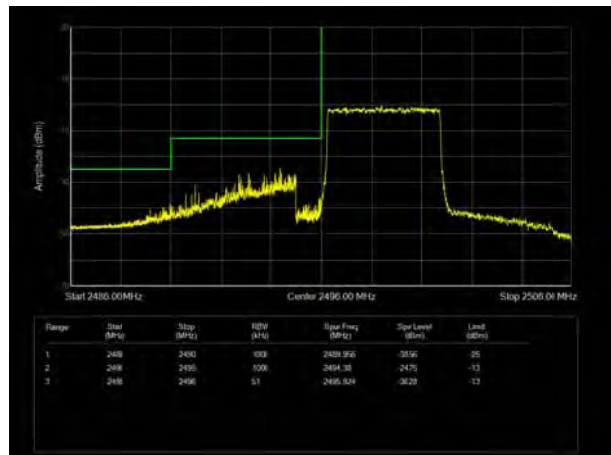

LTE Band 41 16QAM 5MHz CH-High, 100%RB

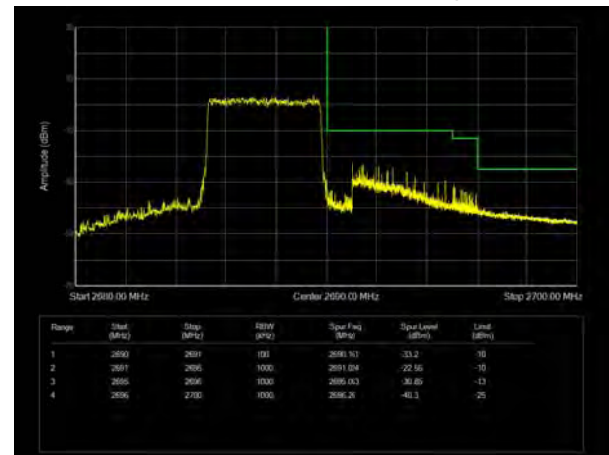



LTE Band 41 16QAM 10MHz CH-Low, 1 RB

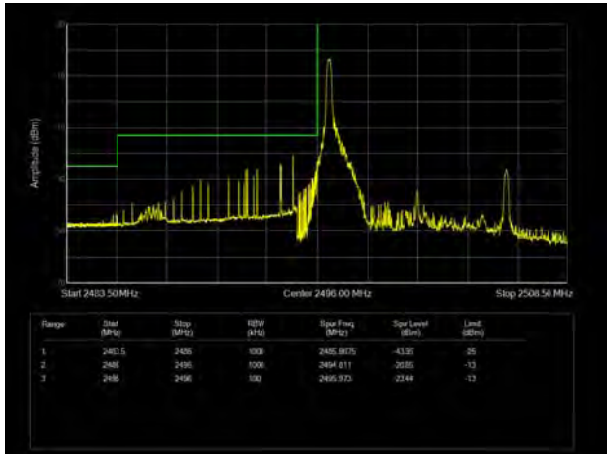

LTE Band 41 16QAM 10MHz CH-High, 1 RB

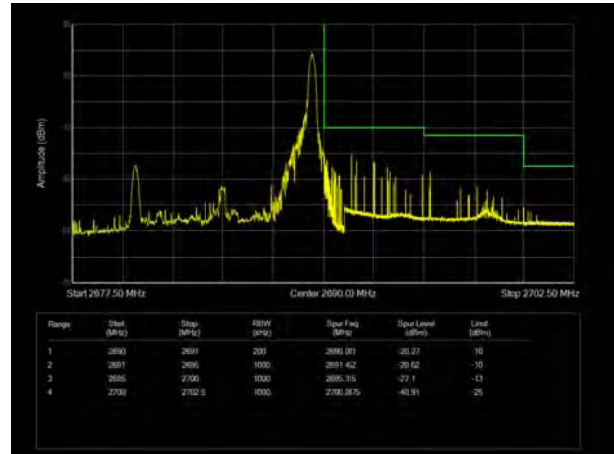

LTE Band 41 16QAM 10MHz CH-Low, 100%RB

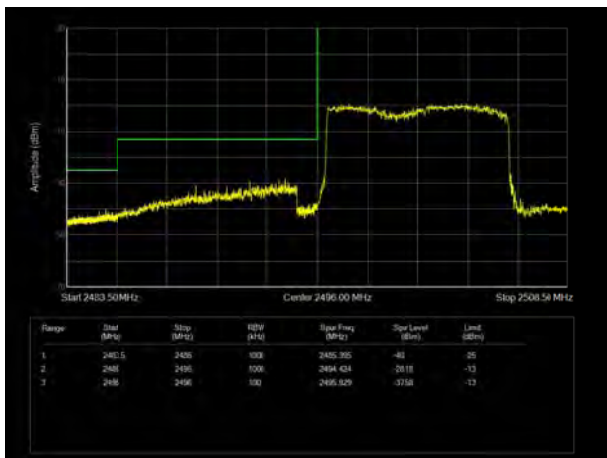

LTE Band 41 16QAM 10MHz CH-High, 100%RB

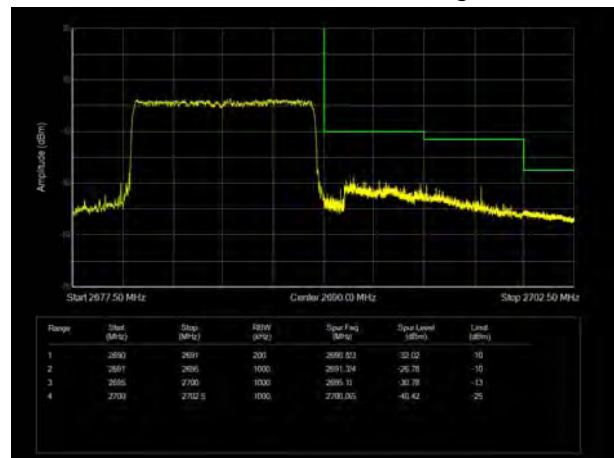

LTE Band 41 16QAM 15MHz CH-Low, 1 RB

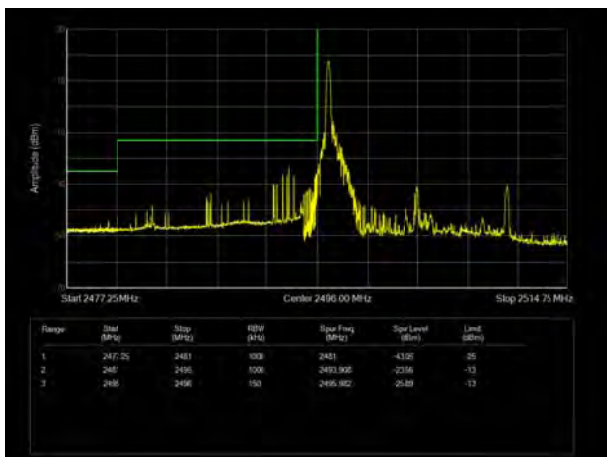

LTE Band 41 16QAM 15MHz CH-High, 1 RB

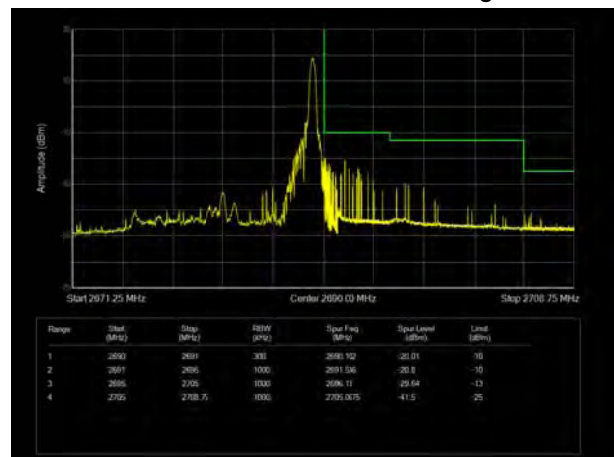



LTE Band 41 16QAM 15MHz CH-Low, 100%RB

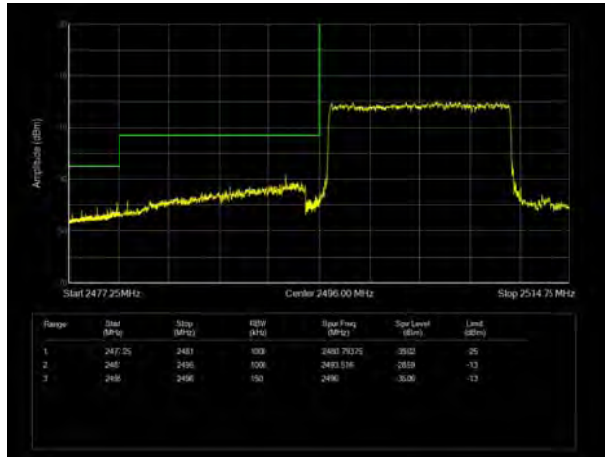

LTE Band 41 16QAM 15MHz CH-High, 100%RB

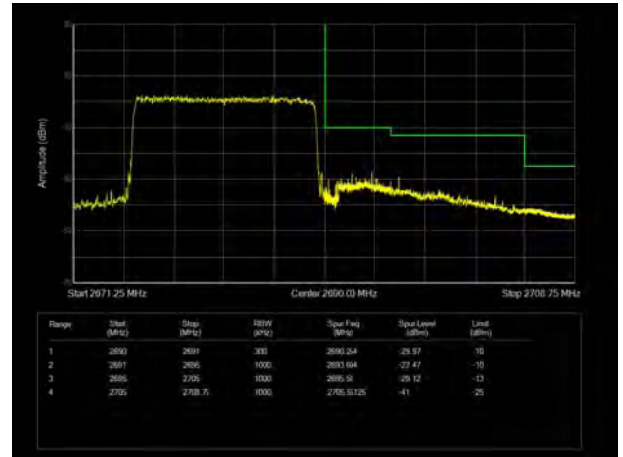

LTE Band 41 16QAM 20MHz CH-Low, RB 1

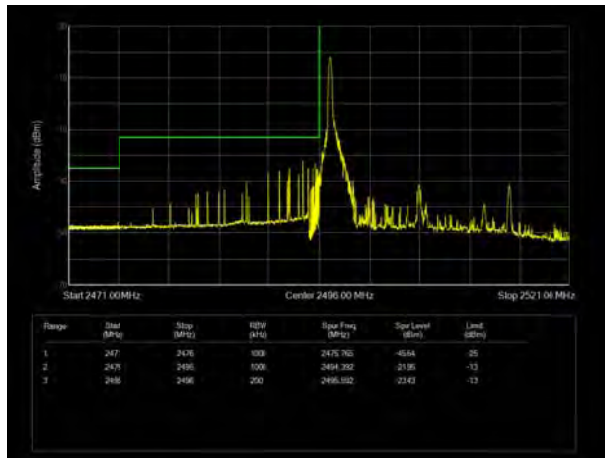

LTE Band 41 16QAM 20MHz CH-High, RB 1

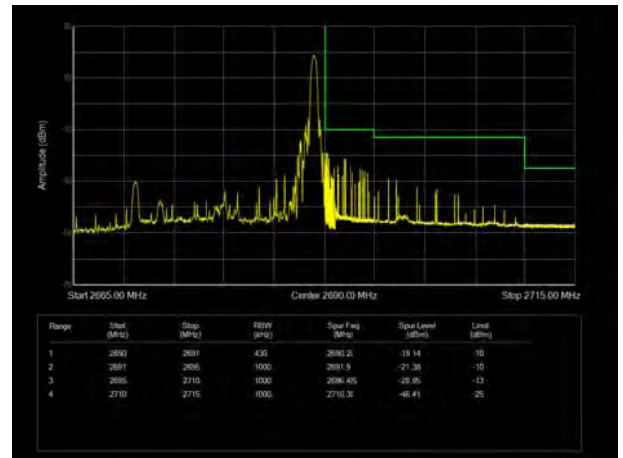

LTE Band 41 16QAM 20MHz CH-Low, 100%RB

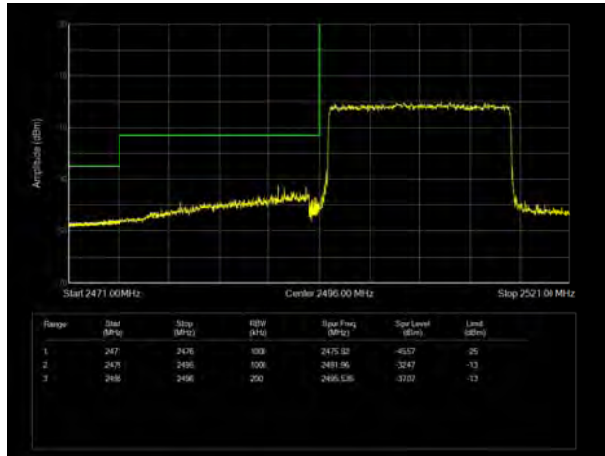

LTE Band 41 16QAM 20MHz CH-High, 100%RB

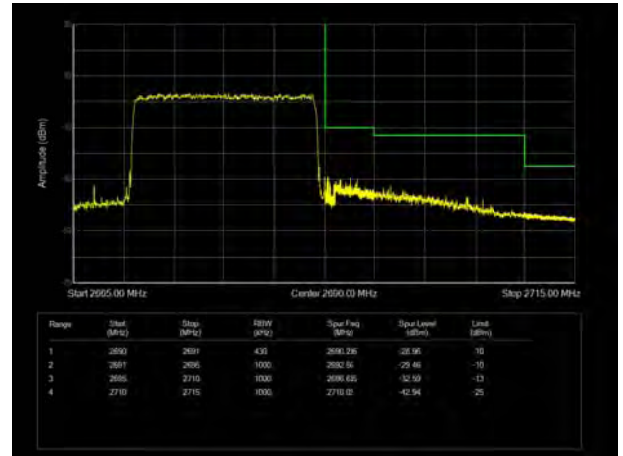



6.4 Peak-to-Average Power Ratio (PAPR)

LTE Band 7								
Modulation	Bandwidth (MHz)	Channel	Frequency (MHz)	Peak (dBm)	Avg (dBm)	PAPR (dB)	Limit (dB)	Conclusion
QPSK	5	20775	2502.5	27.76	23.02	4.74	≤13	PASS
		21100	2535	27.93	23.24	4.69	≤13	PASS
		21425	2567.5	27.82	23.31	4.51	≤13	PASS
	10	20800	2505	27.91	22.96	4.95	≤13	PASS
		21100	2535	27.98	23.22	4.76	≤13	PASS
		21400	2565	27.83	23.28	4.55	≤13	PASS
	15	20825	2507.5	28.31	22.96	5.35	≤13	PASS
		21100	2535	28.41	23.25	5.16	≤13	PASS
		21375	2562.5	28.29	23.37	4.92	≤13	PASS
	20	20850	2510	28.18	22.89	5.29	≤13	PASS
		21100	2535	28.29	23.14	5.15	≤13	PASS
		21350	2560	28.20	23.20	5.00	≤13	PASS
16QAM	5	20775	2502.5	27.53	21.74	5.79	≤13	PASS
		21100	2535	27.74	22.26	5.48	≤13	PASS
		21425	2567.5	27.69	22.34	5.35	≤13	PASS
	10	20800	2505	27.76	22.02	5.74	≤13	PASS
		21100	2535	27.84	22.22	5.62	≤13	PASS
		21400	2565	27.68	22.28	5.40	≤13	PASS
	15	20825	2507.5	27.93	21.96	5.97	≤13	PASS
		21100	2535	28.08	22.23	5.85	≤13	PASS
		21375	2562.5	27.94	22.30	5.64	≤13	PASS
	20	20850	2510	27.94	21.92	6.02	≤13	PASS
		21100	2535	28.09	22.17	5.92	≤13	PASS
		21350	2560	26.97	21.21	5.76	≤13	PASS



LTE Band 38								
Modulation	Bandwidth (MHz)	Channel	Frequency (MHz)	Peak (dBm)	Avg (dBm)	PAPR (dB)	Limit (dB)	Conclusion
QPSK	5	37775	2572.5	27.73	19.51	8.22	≤13	PASS
		38000	2595	27.88	20.12	7.76	≤13	PASS
		38225	2617.5	27.94	19.43	8.51	≤13	PASS
	10	37800	2575	27.71	18.08	9.63	≤13	PASS
		38000	2595	27.88	19.08	8.80	≤13	PASS
		38200	2615	27.93	18.71	9.22	≤13	PASS
	15	37825	2577.5	28.21	19.91	8.30	≤13	PASS
		38000	2595	28.25	19.78	8.47	≤13	PASS
		38175	2612.5	28.44	20.35	8.09	≤13	PASS
	20	37850	2580	27.87	18.55	9.32	≤13	PASS
		38000	2595	28.07	19.15	8.92	≤13	PASS
		38150	2610	28.20	19.12	9.08	≤13	PASS
16QAM	5	37775	2572.5	27.11	16.90	10.21	≤13	PASS
		38000	2595	27.56	17.63	9.93	≤13	PASS
		38225	2617.5	27.74	18.37	9.37	≤13	PASS
	10	37800	2575	27.50	17.14	10.36	≤13	PASS
		38000	2595	27.62	17.79	9.83	≤13	PASS
		38200	2615	27.81	18.02	9.79	≤13	PASS
	15	37825	2577.5	27.80	18.02	9.78	≤13	PASS
		38000	2595	27.90	18.36	9.54	≤13	PASS
		38175	2612.5	28.02	18.36	9.66	≤13	PASS
	20	37850	2580	27.69	18.24	9.45	≤13	PASS
		38000	2595	27.75	17.51	10.24	≤13	PASS
		38150	2610	27.91	18.29	9.62	≤13	PASS

LTE Band 41								
Modulation	Bandwidth (MHz)	Channel	Frequency (MHz)	Peak (dBm)	Avg (dBm)	PAPR (dB)	Limit (dB)	Conclusion
QPSK	5	39675	2498.5	27.27	18.07	9.20	≤13	PASS
		40620	2593	27.93	18.48	9.45	≤13	PASS
		41565	2687.5	27.76	20.09	7.67	≤13	PASS



	10	39700	2501	27.14	17.15	9.99	≤13	PASS
		40620	2593	28.06	19.68	8.38	≤13	PASS
		41540	2685	27.76	18.80	8.96	≤13	PASS
	15	39725	2503.5	27.61	18.11	9.50	≤13	PASS
		40620	2593	28.35	18.60	9.75	≤13	PASS
		41515	2682.5	28.15	18.96	9.19	≤13	PASS
	20	39750	2506	27.56	19.83	7.73	≤13	PASS
		40620	2593	28.17	19.16	9.01	≤13	PASS
		41490	2680	27.95	18.43	9.52	≤13	PASS
16QAM	5	39675	2498.5	27.00	18.79	8.21	≤13	PASS
		40620	2593	27.77	18.26	9.51	≤13	PASS
		41565	2687.5	27.46	17.63	9.83	≤13	PASS
	10	39700	2501	27.08	17.71	9.37	≤13	PASS
		40620	2593	27.82	18.27	9.55	≤13	PASS
		41540	2685	27.74	19.83	7.91	≤13	PASS
	15	39725	2503.5	27.30	17.97	9.33	≤13	PASS
		40620	2593	27.89	16.81	11.08	≤13	PASS
		41515	2682.5	27.82	17.98	9.84	≤13	PASS
	20	39750	2506	27.25	18.02	9.23	≤13	PASS
		40620	2593	27.79	17.03	10.76	≤13	PASS
		41490	2680	27.61	16.89	10.72	≤13	PASS

6.5 Frequency Stability

LTE Band 7						
Condition		Freq.Error (Hz)	Freq.Error (Hz)	Frequency Stability (ppm)	Frequency Stability (ppm)	Verdict
BANDWIDTH	5MHz					
Temperature	Voltage	16QAM	QPSK	16QAM	QPSK	
Normal (25°C)	Normal	16.49	4.97	0.00650	0.00196	PASS
Extreme (50°C)		17.29	16.95	0.00682	0.00669	PASS
Extreme (40°C)		9.38	7.18	0.00370	0.00283	PASS
Extreme (30°C)		5.52	6.30	0.00218	0.00249	PASS
Extreme (20°C)		6.06	1.15	0.00239	0.00045	PASS
Extreme (10°C)		12.70	12.34	0.00501	0.00487	PASS
Extreme (0°C)		10.90	15.73	0.00430	0.00621	PASS
Extreme (-10°C)		13.94	11.66	0.00550	0.00460	PASS
Extreme (-20°C)		12.13	17.99	0.00479	0.00710	PASS
Extreme (-30°C)		9.56	1.17	0.00377	0.00046	PASS
25°C	LV	14.99	14.87	0.00591	0.00587	PASS
	HV	14.04	17.78	0.00554	0.00701	PASS
Condition		Freq.Error (Hz)	Freq.Error (Hz)	Frequency Stability (ppm)	Frequency Stability (ppm)	Verdict
BANDWIDTH	10MHz					
Temperature	Voltage	16QAM	QPSK	16QAM	QPSK	
Normal (25°C)	Normal	11.18	3.52	0.00441	0.00139	PASS
Extreme (50°C)		9.63	10.43	0.00380	0.00411	PASS
Extreme (40°C)		16.97	1.63	0.00669	0.00064	PASS
Extreme (30°C)		12.85	11.05	0.00507	0.00436	PASS
Extreme (20°C)		15.32	10.66	0.00604	0.00421	PASS
Extreme (10°C)		12.78	14.20	0.00504	0.00560	PASS
Extreme (0°C)		4.08	7.68	0.00161	0.00303	PASS
Extreme (-10°C)		14.20	14.00	0.00560	0.00552	PASS
Extreme (-20°C)		2.15	17.47	0.00085	0.00689	PASS
Extreme (-30°C)		12.73	3.67	0.00502	0.00145	PASS
25°C	LV	13.35	10.73	0.00527	0.00423	PASS
	HV	2.22	10.02	0.00088	0.00395	PASS
Condition		Freq.Error (Hz)	Freq.Error (Hz)	Frequency Stability (ppm)	Frequency Stability (ppm)	Verdict
BANDWIDTH	15MHz					
Temperature	Voltage	16QAM	QPSK	16QAM	QPSK	



Normal (25°C)	Normal	8.79	15.11	0.00347	0.00596	PASS
Extreme (50°C)		9.58	13.40	0.00378	0.00528	PASS
Extreme (40°C)		14.06	11.14	0.00555	0.00439	PASS
Extreme (30°C)		1.06	3.02	0.00042	0.00119	PASS
Extreme (20°C)		10.08	11.07	0.00398	0.00437	PASS
Extreme (10°C)		7.48	7.18	0.00295	0.00283	PASS
Extreme (0°C)		13.61	4.40	0.00537	0.00173	PASS
Extreme (-10°C)		3.29	16.29	0.00130	0.00643	PASS
Extreme (-20°C)		2.68	6.33	0.00106	0.00250	PASS
Extreme (-30°C)		13.38	7.41	0.00528	0.00292	PASS
25°C		LV	9.12	16.02	0.00360	0.00632
	HV	17.57	16.22	0.00693	0.00640	PASS
Condition		Freq.Error (Hz)	Freq.Error (Hz)	Frequency Stability (ppm)	Frequency Stability (ppm)	Verdict
BANDWIDTH	20MHz					
Temperature	Voltage	16QAM	QPSK	16QAM	QPSK	
Normal (25°C)	Normal	13.49	14.56	0.00532	0.00574	
Extreme (50°C)		2.20	13.35	0.00087	0.00527	PASS
Extreme (40°C)		5.27	7.56	0.00208	0.00298	PASS
Extreme (30°C)		5.75	10.24	0.00227	0.00404	PASS
Extreme (20°C)		12.83	4.94	0.00506	0.00195	PASS
Extreme (10°C)		14.77	11.38	0.00583	0.00449	PASS
Extreme (0°C)		8.86	8.52	0.00350	0.00336	PASS
Extreme (-10°C)		2.42	7.90	0.00096	0.00312	PASS
Extreme (-20°C)		15.77	2.91	0.00622	0.00115	PASS
Extreme (-30°C)		14.30	11.42	0.00564	0.00451	PASS
25°C		LV	8.28	15.42	0.00327	0.00608
	HV	17.76	10.94	0.00701	0.00432	PASS

LTE Band 38						
Condition		Freq.Error (Hz)	Freq.Error (Hz)	Frequency Stability (ppm)	Frequency Stability (ppm)	Verdict
BANDWIDTH	5MHz					
Temperature	Voltage	16QAM	QPSK	16QAM	QPSK	
Normal (25°C)	Normal	1.78	11.23	0.00069	0.00433	
Extreme (50°C)		4.85	2.79	0.00187	0.00108	PASS
Extreme (40°C)		8.83	3.26	0.00340	0.00126	PASS
Extreme (30°C)		4.36	17.01	0.00168	0.00655	PASS
Extreme (20°C)		14.37	10.30	0.00554	0.00397	PASS
Extreme (10°C)		16.53	4.12	0.00637	0.00159	PASS
Extreme (0°C)		13.03	16.75	0.00502	0.00646	PASS
Extreme (-10°C)		13.26	2.38	0.00511	0.00092	PASS



Extreme (-20°C)		1.98	2.26	0.00076	0.00087	PASS	
Extreme (-30°C)		11.32	17.30	0.00436	0.00667	PASS	
25°C	LV	3.72	16.20	0.00143	0.00624	PASS	
	HV	9.22	16.62	0.00355	0.00640	PASS	
Condition		Freq.Error (Hz)	Freq.Error (Hz)	Frequency Stability (ppm)	Frequency Stability (ppm)	Verdict	
BANDWIDTH	10MHz						
Temperature	Voltage	16QAM	QPSK	16QAM	QPSK		
Normal (25°C)	Normal	11.23	12.29	0.00433	0.00473	PASS	
Extreme (50°C)		6.58	8.17	0.00254	0.00315	PASS	
Extreme (40°C)		10.88	10.24	0.00419	0.00395	PASS	
Extreme (30°C)		4.77	15.40	0.00184	0.00594	PASS	
Extreme (20°C)		14.96	10.75	0.00577	0.00414	PASS	
Extreme (10°C)		7.61	1.72	0.00293	0.00066	PASS	
Extreme (0°C)		1.94	2.90	0.00075	0.00112	PASS	
Extreme (-10°C)		10.49	8.58	0.00404	0.00331	PASS	
Extreme (-20°C)		12.37	8.82	0.00477	0.00340	PASS	
Extreme (-30°C)		12.04	14.04	0.00464	0.00541	PASS	
25°C		LV	3.94	17.95	0.00152	0.00692	PASS
		HV	15.53	11.65	0.00598	0.00449	PASS
Condition		Freq.Error (Hz)	Freq.Error (Hz)	Frequency Stability (ppm)	Frequency Stability (ppm)	Verdict	
BANDWIDTH	15MHz						
Temperature	Voltage	16QAM	QPSK	16QAM	QPSK		
Normal (25°C)	Normal	9.31	5.97	0.00359	0.00230	PASS	
Extreme (50°C)		12.07	1.65	0.00465	0.00064	PASS	
Extreme (40°C)		7.91	12.49	0.00305	0.00481	PASS	
Extreme (30°C)		10.09	1.62	0.00389	0.00062	PASS	
Extreme (20°C)		3.11	2.57	0.00120	0.00099	PASS	
Extreme (10°C)		9.16	3.52	0.00353	0.00136	PASS	
Extreme (0°C)		10.93	17.39	0.00421	0.00670	PASS	
Extreme (-10°C)		8.26	2.25	0.00318	0.00087	PASS	
Extreme (-20°C)		13.91	15.25	0.00536	0.00588	PASS	
Extreme (-30°C)		2.54	10.91	0.00098	0.00421	PASS	
25°C		LV	5.54	14.31	0.00213	0.00551	PASS
		HV	9.17	8.42	0.00353	0.00325	PASS
Condition		Freq.Error (Hz)	Freq.Error (Hz)	Frequency Stability (ppm)	Frequency Stability (ppm)	Verdict	
BANDWIDTH	20MHz						
Temperature	Voltage	16QAM	QPSK	16QAM	QPSK		



Normal (25°C)	Normal	13.27	9.62	0.00154	0.00207	PASS
Extreme (50°C)		13.29	2.85	0.00385	0.00167	PASS
Extreme (40°C)		10.64	16.83	0.00424	0.00661	PASS
Extreme (30°C)		16.42	4.63	0.00116	0.00512	PASS
Extreme (20°C)		12.03	16.92	0.00617	0.00438	PASS
Extreme (10°C)		2.12	13.59	0.00385	0.00123	PASS
Extreme (0°C)		13.02	9.58	0.00501	0.00432	PASS
Extreme (-10°C)		17.02	9.71	0.00270	0.00374	PASS
Extreme (-20°C)		14.84	12.23	0.00039	0.00686	PASS
Extreme (-30°C)		15.75	13.11	0.00039	0.00092	PASS
25°C	LV	10.93	9.92	0.00039	0.00369	PASS
	HV	4.73	2.11	0.00578	0.00519	PASS

LTE Band 41						
Condition		Freq.Error (Hz)	Freq.Error (Hz)	Frequency Stability (ppm)	Frequency Stability (ppm)	Verdict
BANDWIDTH	5MHz					
Temperature	Voltage	16QAM	QPSK	16QAM	QPSK	
Normal (25°C)	Normal	5.90	8.79	0.00227	0.00339	PASS
Extreme (50°C)		10.06	14.93	0.00388	0.00576	PASS
Extreme (40°C)		11.12	16.35	0.00429	0.00631	PASS
Extreme (30°C)		6.45	12.81	0.00249	0.00494	PASS
Extreme (20°C)		6.67	3.15	0.00257	0.00121	PASS
Extreme (10°C)		4.94	1.02	0.00190	0.00039	PASS
Extreme (0°C)		5.97	16.39	0.00230	0.00632	PASS
Extreme (-10°C)		12.48	16.64	0.00481	0.00642	PASS
Extreme (-20°C)		8.07	3.81	0.00311	0.00147	PASS
Extreme (-30°C)		9.22	3.40	0.00356	0.00131	PASS
25°C	LV	7.55	11.34	0.00291	0.00437	PASS
	HV	12.03	12.11	0.00464	0.00467	PASS
Condition		Freq.Error (Hz)	Freq.Error (Hz)	Frequency Stability (ppm)	Frequency Stability (ppm)	Verdict
BANDWIDTH	10MHz					
Temperature	Voltage	16QAM	QPSK	16QAM	QPSK	
Normal (25°C)	Normal	1.64	1.13	0.00063	0.00044	PASS
Extreme (50°C)		1.97	14.35	0.00076	0.00554	PASS
Extreme (40°C)		16.21	9.41	0.00625	0.00363	PASS
Extreme (30°C)		7.18	16.51	0.00277	0.00637	PASS
Extreme (20°C)		9.69	12.14	0.00374	0.00468	PASS
Extreme (10°C)		13.19	11.93	0.00509	0.00460	PASS
Extreme (0°C)		4.98	1.03	0.00192	0.00040	PASS



Extreme (-10℃)		9.72	16.16	0.00375	0.00623	PASS
Extreme (-20℃)		17.59	11.87	0.00679	0.00458	PASS
Extreme (-30℃)		10.52	17.14	0.00406	0.00661	PASS
25℃	LV	16.08	1.84	0.00620	0.00071	PASS
	HV	5.46	6.12	0.00210	0.00236	PASS
Condition		Freq.Error (Hz)	Freq.Error (Hz)	Frequency Stability (ppm)	Frequency Stability (ppm)	Verdict
BANDWIDTH	15MHz					
Temperature	Voltage	16QAM	QPSK	16QAM	QPSK	
Normal (25℃)	Normal	1.45	8.37	0.00056	0.00323	PASS
Extreme (50℃)		7.79	10.05	0.00301	0.00387	PASS
Extreme (40℃)		8.58	4.53	0.00331	0.00175	PASS
Extreme (30℃)		4.08	9.93	0.00157	0.00383	PASS
Extreme (20℃)		12.75	17.60	0.00492	0.00679	PASS
Extreme (10℃)		15.37	11.17	0.00593	0.00431	PASS
Extreme (0℃)		15.52	1.58	0.00599	0.00061	PASS
Extreme (-10℃)		5.49	15.33	0.00212	0.00591	PASS
Extreme (-20℃)		9.17	15.29	0.00354	0.00590	PASS
Extreme (-30℃)		3.33	12.82	0.00128	0.00494	PASS
25℃		LV	8.96	11.37	0.00345	0.00439
	HV	16.63	17.68	0.00641	0.00682	PASS
Condition		Freq.Error (Hz)	Freq.Error (Hz)	Frequency Stability (ppm)	Frequency Stability (ppm)	Verdict
BANDWIDTH	20MHz					
Temperature	Voltage	16QAM	QPSK	16QAM	QPSK	
Normal (25℃)	Normal	2.27	3.40	0.00116	0.00250	PASS
Extreme (50℃)		16.00	8.50	0.00231	0.00480	PASS
Extreme (40℃)		6.71	3.22	0.00501	0.00298	PASS
Extreme (30℃)		11.50	15.79	0.00039	0.00203	PASS
Extreme (20℃)		5.58	5.66	0.00501	0.00174	PASS
Extreme (10℃)		14.51	12.85	0.00501	0.00512	PASS
Extreme (0℃)		1.56	6.21	0.00617	0.00416	PASS
Extreme (-10℃)		13.71	3.92	0.00039	0.00426	PASS
Extreme (-20℃)		3.19	12.23	0.00116	0.00200	PASS
Extreme (-30℃)		13.51	2.49	0.00463	0.00431	PASS
25℃		LV	5.91	17.56	0.00617	0.00390
	HV	4.22	14.12	0.00424	0.00391	PASS

6.6 Spurious Emissions at Antenna Terminals

Sweep the whole frequency band through the range from 9kHz to the 10th harmonic of the carrier, the emissions more than 20 dB below the limit are not reported.

The signal beyond the limit is carrier.

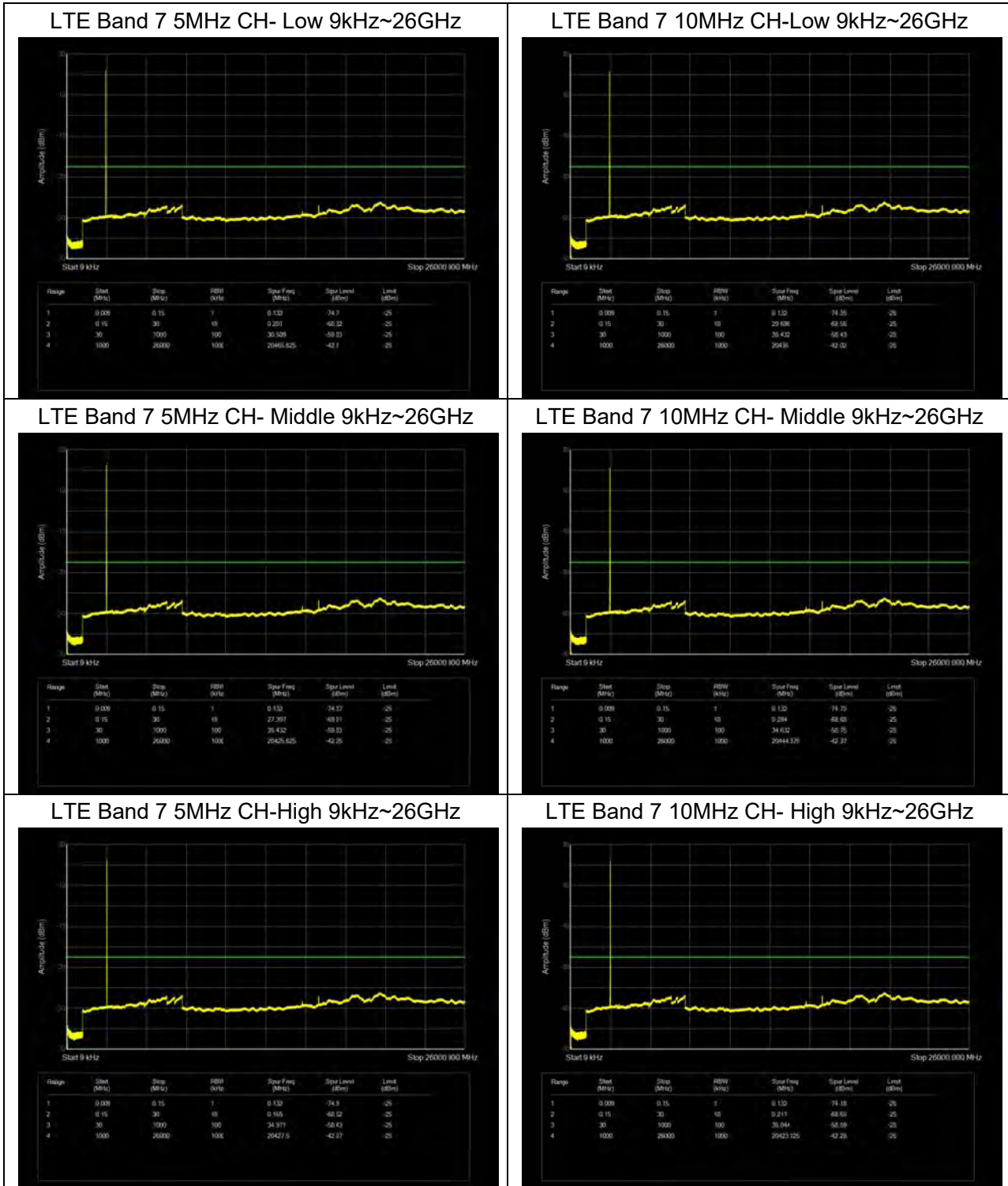



LTE Band 7 15MHz CH- Low 9kHz~26GHz

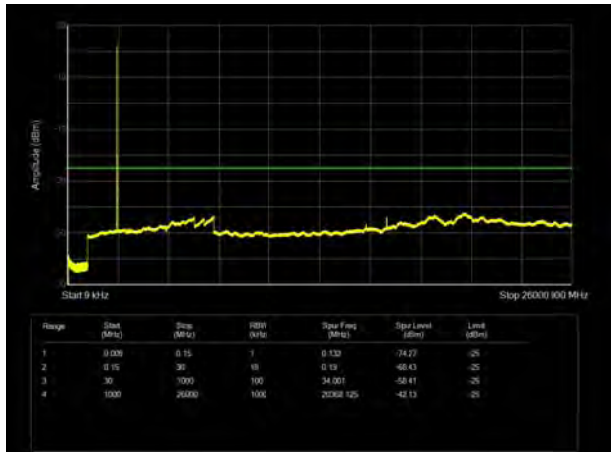

LTE Band 7 20MHz CH-Low 9kHz~26GHz

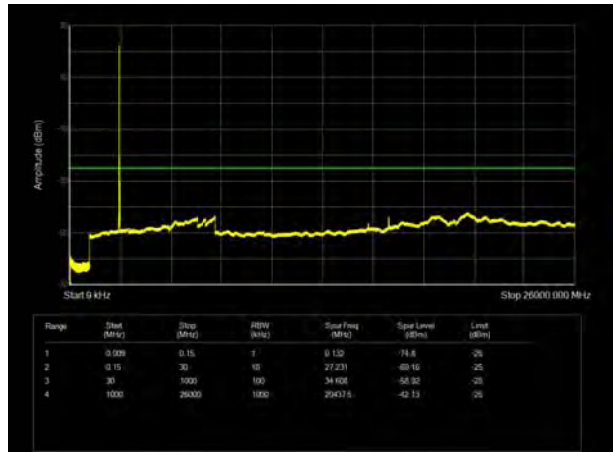

LTE Band 7 15MHz CH- Middle 9kHz~26GHz

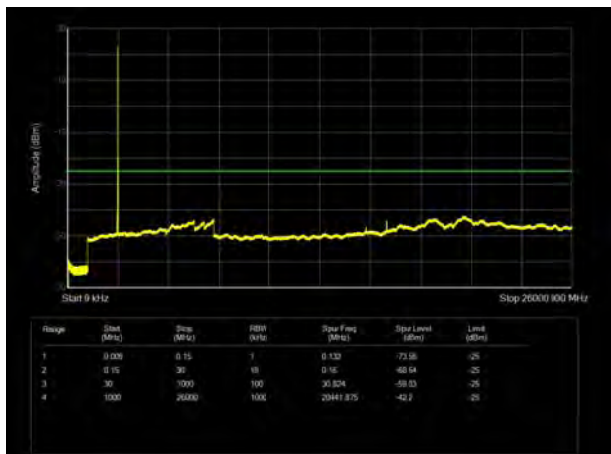

LTE Band 7 20MHz CH- Middle 9kHz~26GHz

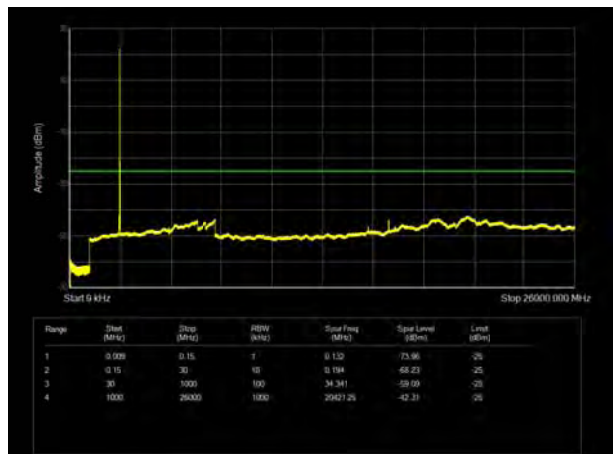

LTE Band 7 15MHz CH-High 9kHz~26GHz

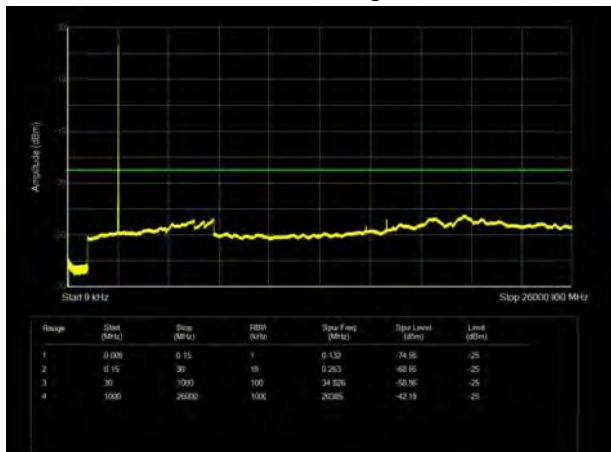

LTE Band 7 20MHz CH- High 9kHz~26GHz





LTE Band 38 5MHz CH-Low 9kHz~26.5GHz

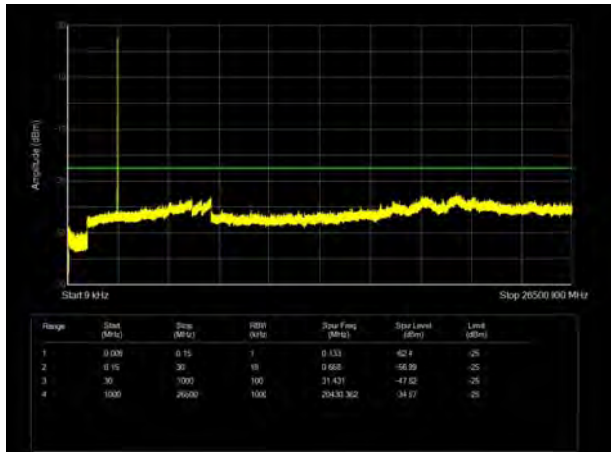

LTE Band 38 10MHz CH- Low 9kHz~26.5GHz

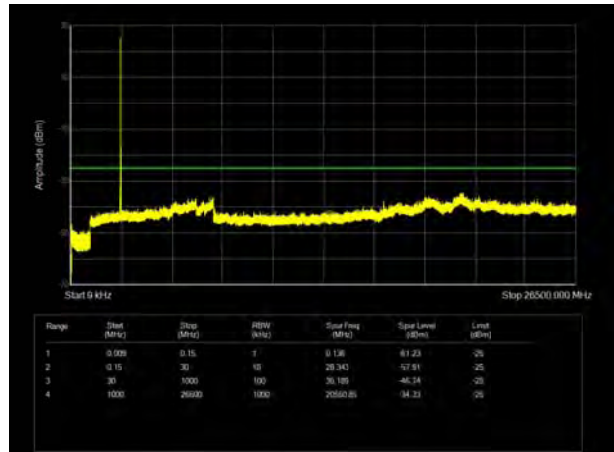

LTE Band 38 5MHz CH- Middle 9kHz~26.5GHz

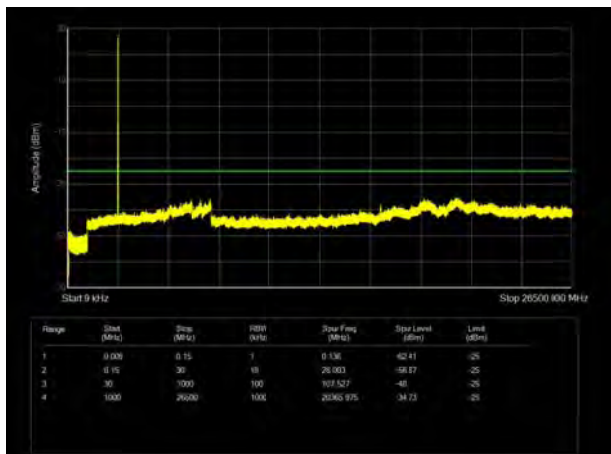

LTE Band 38 10MHz CH- Middle 9kHz~26.5GHz

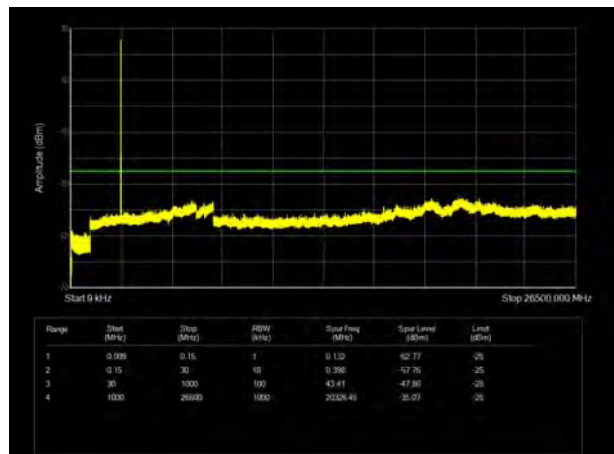

LTE Band 38 5MHz CH- High 9kHz~26.5GHz

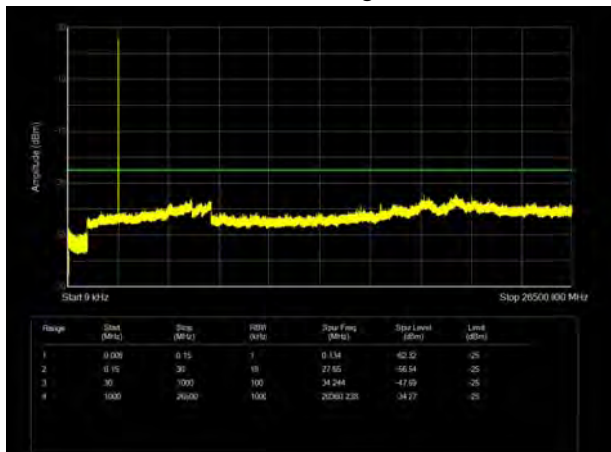

LTE Band 38 10MHz CH-High 9kHz~26.5GHz





LTE Band 38 15MHz CH- Low 9kHz~26.5GHz

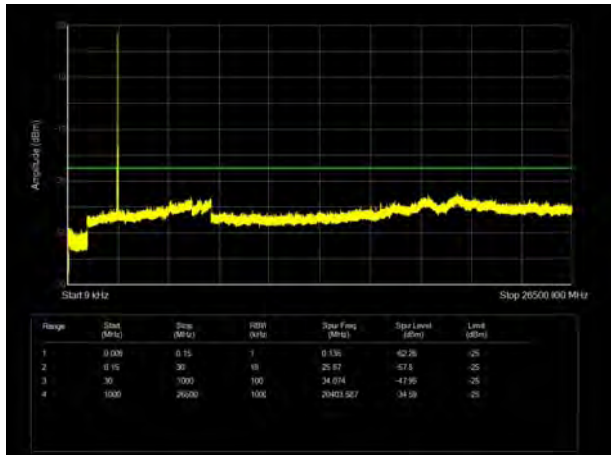

LTE Band 38 20MHz CH-Low 9kHz~26.5GHz

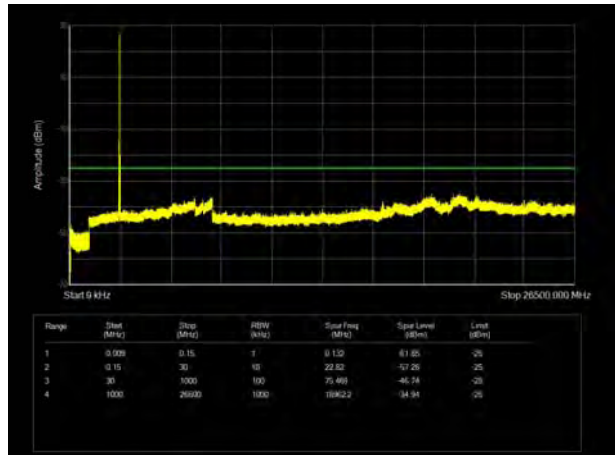

LTE Band 38 15MHz CH- Middle 9kHz~26.5GHz

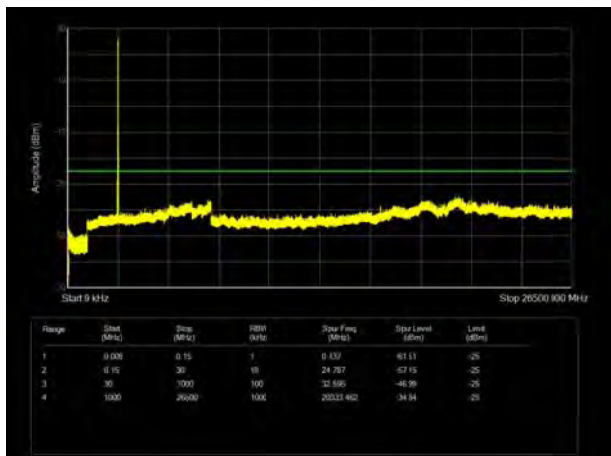

LTE Band 38 20MHz CH- Middle 9kHz~26.5GHz

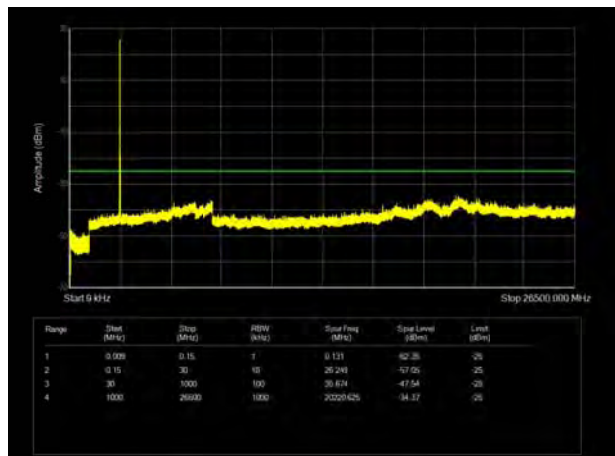

LTE Band 38 15MHz CH-High 9kHz~26.5GHz

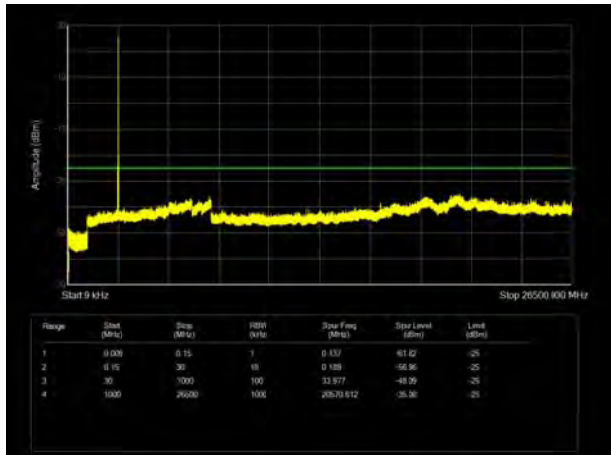

LTE Band 38 20MHz CH- High 9kHz~26.5GHz

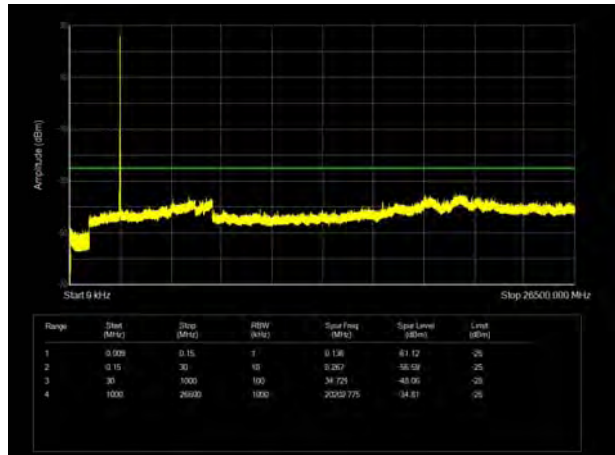



LTE Band 41 5MHz CH-Low 9kHz~30GHz

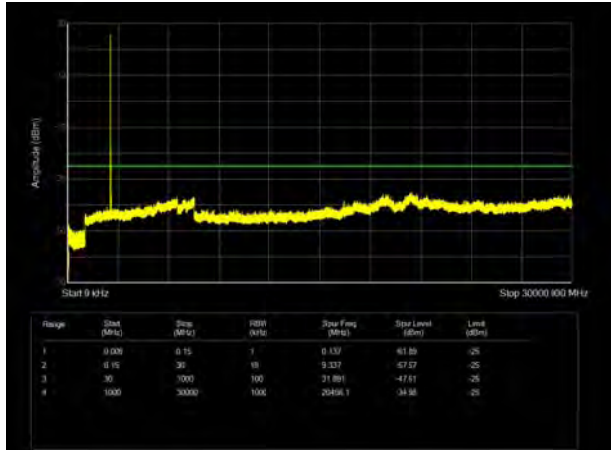

LTE Band 41 10MHz CH- Low 9kHz~30GHz

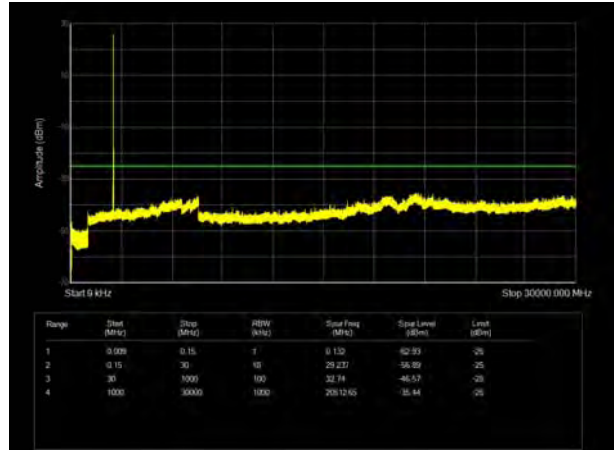

LTE Band 41 5MHz CH- Middle 9kHz~30GHz

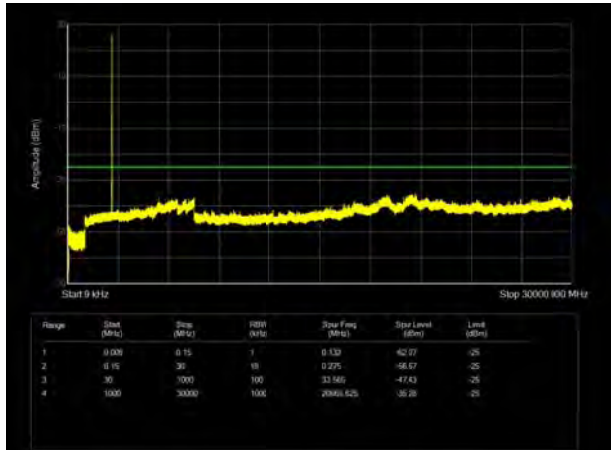

LTE Band 41 10MHz CH- Middle 9kHz~30GHz

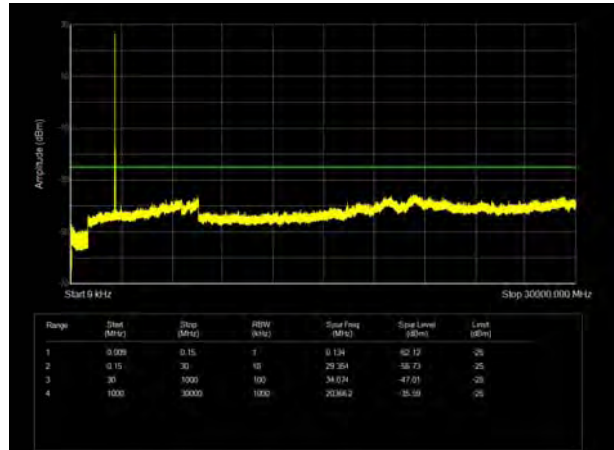

LTE Band 41 5MHz CH- High 9kHz~30GHz

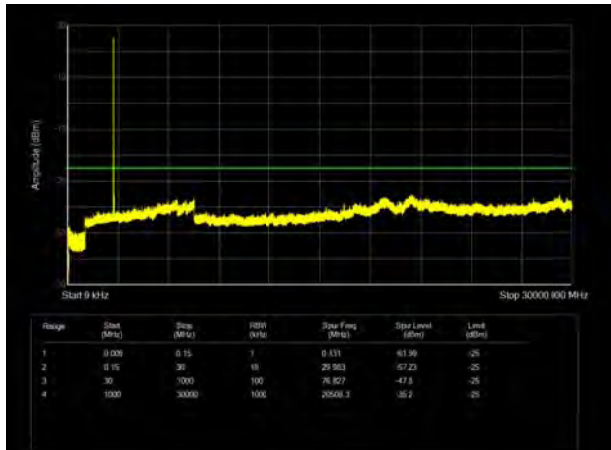

LTE Band 41 10MHz CH-High 9kHz~30GHz

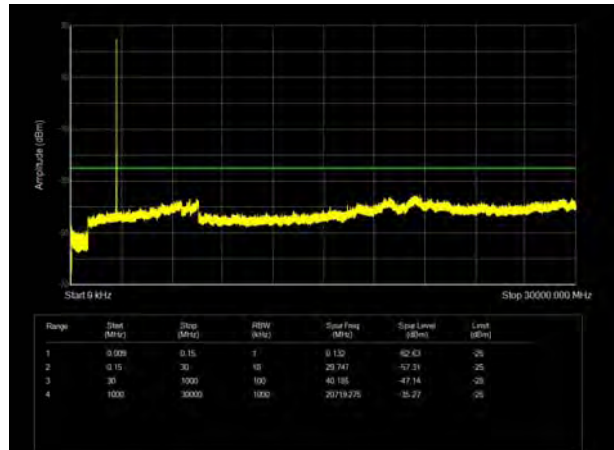

LTE Band 41 15MHz CH- Low 9kHz~30GHz

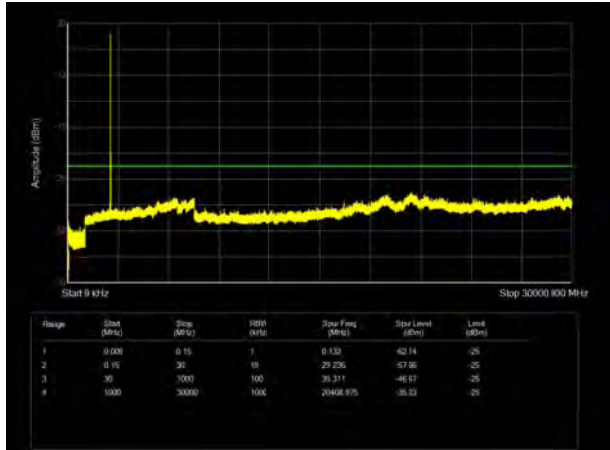

LTE Band 41 20MHz CH-Low 9kHz~30GHz

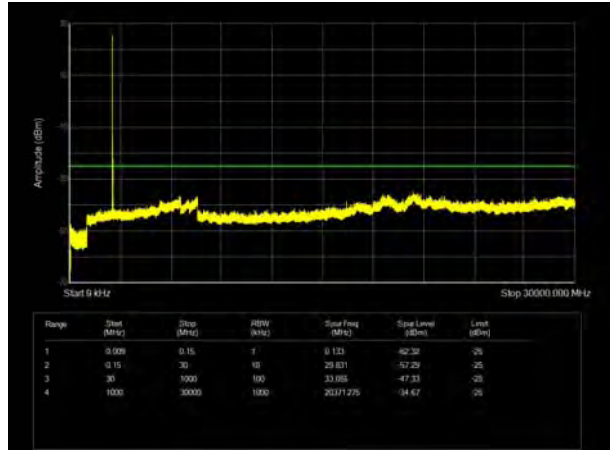

LTE Band 41 15MHz CH- Middle 9kHz~30GHz

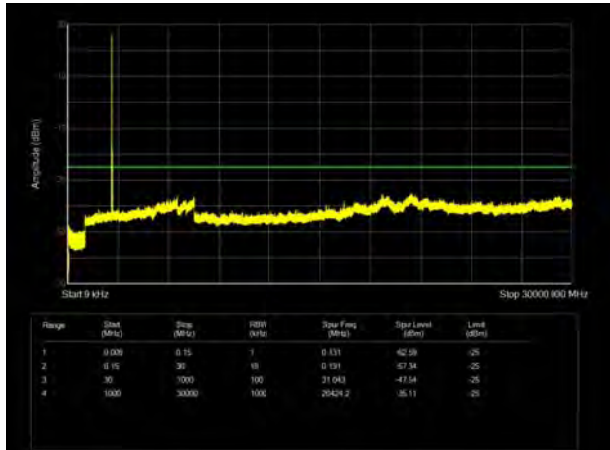

LTE Band 41 20MHz CH- Middle 9kHz~30GHz

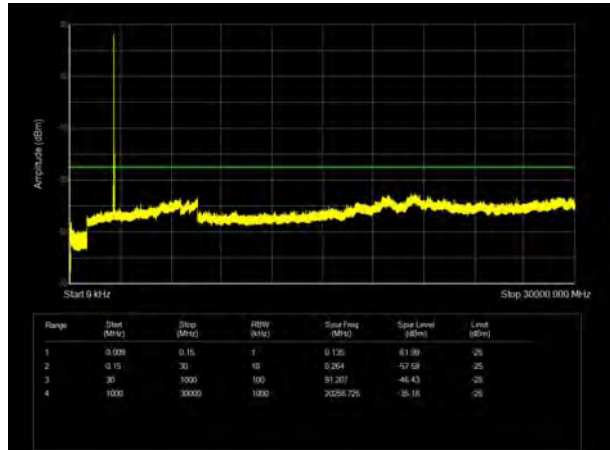

LTE Band 41 15MHz CH-High 9kHz~30GHz



LTE Band 41 20MHz CH- High 9kHz~30GHz

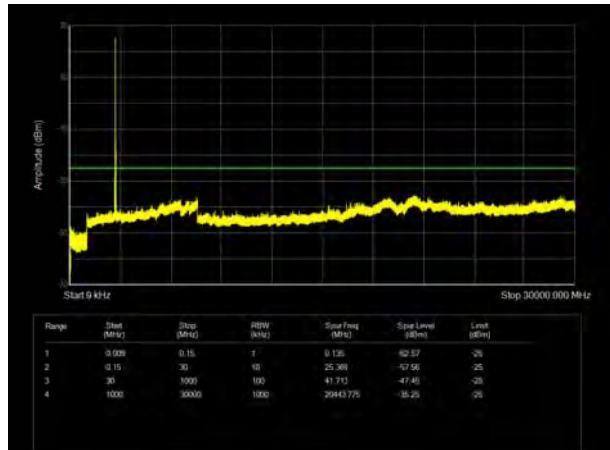



6.7 Radiates Spurious Emission

Sweep the whole frequency band through the range from 9kHz to the 10th harmonic of the carrier, the emissions below the noise floor will not be recorded in the report.

Upper Antenna

LTE Band 7 QPSK 5MHz CH-Middle, RB 1

Harmonic	Frequency (MHz)	SG (dBm)	Cable Loss (dB)	Gain (dBi)	Antenna Polarization	EIRP Level (dBm)	Limit (dBm)	Margin (dB)	Azimuth (deg)
2	5065.80	-58.59	3.40	12.50	Horizontal	-49.49	-25.00	24.49	315
3	7598.60	-58.50	4.40	12.20	Horizontal	-50.70	-25.00	25.70	90
4	10130.63	-50.02	4.70	11.30	Horizontal	-43.42	-25.00	18.42	270
5	12675.00	-51.61	5.40	13.20	Horizontal	-43.81	-25.00	18.81	45
6	15210.00	-47.94	6.10	13.10	Horizontal	-40.94	-25.00	15.94	225
7	17745.00	-50.42	6.10	14.20	Horizontal	-42.32	-25.00	17.32	135
8	20280.00	--	--	--	--	--	--	--	--
9	22815.00	--	--	--	--	--	--	--	--
10	25350.00	--	--	--	--	--	--	--	--

Note: 1.The other Spurious RF Radiated emissions level is no more than noise floor.

2. The worst emission was found in the antenna is Horizontal position.

LTE Band 7 QPSK 20MHz CH-Middle, RB 1

Harmonic	Frequency (MHz)	SG (dBm)	Cable Loss (dB)	Gain (dBi)	Antenna Polarization	EIRP Level (dBm)	Limit (dBm)	Margin (dB)	Azimuth (deg)
2	5052.20	-58.89	3.40	12.50	Horizontal	-49.79	-25.00	24.79	225
3	7578.30	-58.02	4.40	12.20	Horizontal	-50.22	-25.00	25.22	135
4	10104.40	-49.74	4.70	11.30	Horizontal	-43.14	-25.00	18.14	45
5	12630.50	-51.40	5.40	13.20	Horizontal	-43.60	-25.00	18.60	270
6	15156.60	-46.70	6.10	13.10	Horizontal	-39.70	-25.00	14.70	135
7	17745.00	-49.85	6.10	14.20	Horizontal	-41.75	-25.00	16.75	90
8	20208.80	--	--	--	--	--	--	--	--
9	22734.90	--	--	--	--	--	--	--	--
10	25261.00	--	--	--	--	--	--	--	--

Note: 1.The other Spurious RF Radiated emissions level is no more than noise floor.

2. The worst emission was found in the antenna is Horizontal position.



LTE Band 38 QPSK 5MHz CH-Middle, RB 1

Harmonic	Frequency (MHz)	SG (dBm)	Cable Loss (dB)	Gain (dBi)	Antenna Polarization	EIRP Level (dBm)	Limit (dBm)	Margin (dB)	Azimuth (deg)
2	5185.00	-62.49	3.20	12.50	Horizontal	-53.19	-25.00	28.19	90
3	7777.50	-57.58	4.40	12.30	Horizontal	-49.68	-25.00	24.68	45
4	10370.00	-53.46	4.70	11.80	Horizontal	-46.36	-25.00	21.36	225
5	12962.50	-53.90	5.40	14.00	Horizontal	-45.30	-25.00	20.30	0
6	15555.00	-56.66	6.10	16.80	Horizontal	-45.96	-25.00	20.96	135
7	18147.50	--	--	--	--	--	--	--	--
8	20740.00	--	--	--	--	--	--	--	--
9	23332.50	--	--	--	--	--	--	--	--
10	25925.00	--	--	--	--	--	--	--	--

Note: 1. The other Spurious RF Radiated emissions level is no more than noise floor.
2. The worst emission was found in the antenna is Horizontal position.

LTE Band 38 QPSK 20MHz CH-Middle, RB 1

Harmonic	Frequency (MHz)	SG (dBm)	Cable Loss (dB)	Gain (dBi)	Antenna Polarization	EIRP Level (dBm)	Limit (dBm)	Margin (dB)	Azimuth (deg)
2	5170.00	-61.89	3.20	12.50	Horizontal	-52.59	-25.00	27.59	225
3	7755.00	-56.97	4.40	12.30	Horizontal	-49.07	-25.00	24.07	45
4	10340.00	-53.98	4.70	11.80	Horizontal	-46.88	-25.00	21.88	45
5	12925.00	-53.66	5.40	14.00	Horizontal	-45.06	-25.00	20.06	45
6	15510.00	-55.52	6.10	16.80	Horizontal	-44.82	-25.00	19.82	135
7	18095.00	--	--	--	--	--	--	--	--
8	20680.00	--	--	--	--	--	--	--	--
9	23265.00	--	--	--	--	--	--	--	--
10	25850.00	--	--	--	--	--	--	--	--

Note: 1. The other Spurious RF Radiated emissions level is no more than noise floor.
2. The worst emission was found in the antenna is Horizontal position.



LTE Band 41 QPSK 5MHz CH-Middle, RB 1

Harmonic	Frequency (MHz)	SG (dBm)	Cable Loss (dB)	Gain (dBi)	Antenna Polarization	EIRP Level (dBm)	Limit (dBm)	Margin (dB)	Azimuth (deg)
2	5163.30	-62.96	3.20	12.50	Horizontal	-53.66	-25.00	28.66	225
3	7744.95	-58.36	4.40	12.30	Horizontal	-50.46	-25.00	25.46	45
4	10326.60	-53.94	4.70	11.80	Horizontal	-46.84	-25.00	21.84	45
5	12908.25	-52.88	5.40	14.00	Horizontal	-44.28	-25.00	19.28	0
6	15489.90	-53.95	6.10	16.80	Horizontal	-43.25	-25.00	18.25	0
7	18071.55	--	--	--	--	--	--	--	--
8	20653.20	--	--	--	--	--	--	--	--
9	23234.85	--	--	--	--	--	--	--	--
10	25816.50	--	--	--	--	--	--	--	--

Note: 1.The other Spurious RF Radiated emissions level is no more than noise floor.
2. The worst emission was found in the antenna is Horizontal position.

LTE Band 41 QPSK 20MHz CH-Middle, RB 1

Harmonic	Frequency (MHz)	SG (dBm)	Cable Loss (dB)	Gain (dBi)	Antenna Polarization	EIRP Level (dBm)	Limit (dBm)	Margin (dB)	Azimuth (deg)
2	5149.60	-62.43	3.20	12.50	Horizontal	-53.13	-25.00	28.13	225
3	7724.40	-57.42	4.40	12.30	Horizontal	-49.52	-25.00	24.52	135
4	10299.20	-52.66	4.70	11.80	Horizontal	-45.56	-25.00	20.56	0
5	12874.00	-53.46	5.40	14.00	Horizontal	-44.86	-25.00	19.86	45
6	15448.80	-55.53	6.10	16.80	Horizontal	-44.83	-25.00	19.83	45
7	18023.60	--	--	--	--	--	--	--	--
8	20598.40	--	--	--	--	--	--	--	--
9	23173.20	--	--	--	--	--	--	--	--
10	25748.00	--	--	--	--	--	--	--	--

Note: 1.The other Spurious RF Radiated emissions level is no more than noise floor.
2. The worst emission was found in the antenna is Horizontal position.

**Low Antenna**

LTE Band 7 QPSK 5MHz CH-Middle, RB 1

Harmonic	Frequency (MHz)	SG (dBm)	Cable Loss (dB)	Gain (dBi)	Antenna Polarization	EIRP Level (dBm)	Limit (dBm)	Margin (dB)	Azimuth (deg)
2	5065.80	-62.17	3.40	12.50	Horizontal	-53.07	-25.00	28.07	225
3	7598.60	-57.88	4.40	12.20	Horizontal	-50.08	-25.00	25.08	135
4	10130.63	-51.26	4.70	11.30	Horizontal	-44.66	-25.00	19.66	0
5	12675.00	-52.19	5.40	13.20	Horizontal	-44.39	-25.00	19.39	90
6	15210.00	-48.02	6.10	13.10	Horizontal	-41.02	-25.00	16.02	225
7	17745.00	-50.36	6.10	14.20	Horizontal	-42.26	-25.00	17.26	45
8	20280.00	--	--	--	--	--	--	--	--
9	22815.00	--	--	--	--	--	--	--	--
10	25350.00	--	--	--	--	--	--	--	--

Note: 1.The other Spurious RF Radiated emissions level is no more than noise floor.

2. The worst emission was found in the antenna is Horizontal position.

LTE Band 7 QPSK 20MHz CH-Middle, RB 1

Harmonic	Frequency (MHz)	SG (dBm)	Cable Loss (dB)	Gain (dBi)	Antenna Polarization	EIRP Level (dBm)	Limit (dBm)	Margin (dB)	Azimuth (deg)
2	5052.20	-61.65	3.40	12.50	Horizontal	-52.55	-25.00	27.55	225
3	7578.30	-58.93	4.40	12.20	Horizontal	-51.13	-25.00	26.13	45
4	10104.40	-50.85	4.70	11.30	Horizontal	-44.25	-25.00	19.25	0
5	12630.50	-51.11	5.40	13.20	Horizontal	-43.31	-25.00	18.31	225
6	15156.60	-49.60	6.10	13.10	Horizontal	-42.60	-25.00	17.60	45
7	17745.00	-50.22	6.10	14.20	Horizontal	-42.12	-25.00	17.12	0
8	20208.80	--	--	--	--	--	--	--	--
9	22734.90	--	--	--	--	--	--	--	--
10	25261.00	--	--	--	--	--	--	--	--

Note: 1.The other Spurious RF Radiated emissions level is no more than noise floor.

2. The worst emission was found in the antenna is Horizontal position.



LTE Band 38 QPSK 5MHz CH-Middle, RB 1

Harmonic	Frequency (MHz)	SG (dBm)	Cable Loss (dB)	Gain (dBi)	Antenna Polarization	EIRP Level (dBm)	Limit (dBm)	Margin (dB)	Azimuth (deg)
2	5185.00	-61.77	3.20	12.50	Horizontal	-52.47	-25.00	27.47	225
3	7777.50	-57.42	4.40	12.30	Horizontal	-49.52	-25.00	24.52	90
4	10370.00	-52.94	4.70	11.80	Horizontal	-45.84	-25.00	20.84	90
5	12962.50	-52.57	5.40	14.00	Horizontal	-43.97	-25.00	18.97	0
6	15555.00	-53.79	6.10	16.80	Horizontal	-43.09	-25.00	18.09	315
7	18147.50	--	--	--	--	--	--	--	--
8	20740.00	--	--	--	--	--	--	--	--
9	23332.50	--	--	--	--	--	--	--	--
10	25925.00	--	--	--	--	--	--	--	--

Note: 1. The other Spurious RF Radiated emissions level is no more than noise floor.
2. The worst emission was found in the antenna is Horizontal position.

LTE Band 38 QPSK 20MHz CH-Middle, RB 1

Harmonic	Frequency (MHz)	SG (dBm)	Cable Loss (dB)	Gain (dBi)	Antenna Polarization	EIRP Level (dBm)	Limit (dBm)	Margin (dB)	Azimuth (deg)
2	5170.00	-61.54	3.20	12.50	Horizontal	-52.24	-25.00	27.24	45
3	7755.00	-57.84	4.40	12.30	Horizontal	-49.94	-25.00	24.94	0
4	10340.00	-52.82	4.70	11.80	Horizontal	-45.72	-25.00	20.72	45
5	12925.00	-54.23	5.40	14.00	Horizontal	-45.63	-25.00	20.63	135
6	15510.00	-54.83	6.10	16.80	Horizontal	-44.13	-25.00	19.13	90
7	18095.00	--	--	--	--	--	--	--	--
8	20680.00	--	--	--	--	--	--	--	--
9	23265.00	--	--	--	--	--	--	--	--
10	25850.00	--	--	--	--	--	--	--	--

Note: 1. The other Spurious RF Radiated emissions level is no more than noise floor.
2. The worst emission was found in the antenna is Horizontal position.



LTE Band 41 QPSK 5MHz CH-Middle, RB 1

Harmonic	Frequency (MHz)	SG (dBm)	Cable Loss (dB)	Gain (dBi)	Antenna Polarization	EIRP Level (dBm)	Limit (dBm)	Margin (dB)	Azimuth (deg)
2	5163.30	-62.50	3.20	12.50	Horizontal	-53.20	-25.00	28.20	90
3	7744.95	-56.93	4.40	12.30	Horizontal	-49.03	-25.00	24.03	135
4	10326.60	-52.13	4.70	11.80	Horizontal	-45.03	-25.00	20.03	0
5	12908.25	-52.50	5.40	14.00	Horizontal	-43.90	-25.00	18.90	135
6	15489.90	-53.05	6.10	16.80	Horizontal	-42.35	-25.00	17.35	0
7	18071.55	--	--	--	--	--	--	--	--
8	20653.20	--	--	--	--	--	--	--	--
9	23234.85	--	--	--	--	--	--	--	--
10	25816.50	--	--	--	--	--	--	--	--

Note: 1.The other Spurious RF Radiated emissions level is no more than noise floor.
2. The worst emission was found in the antenna is Horizontal position.

LTE Band 41 QPSK 20MHz CH-Middle, RB 1

Harmonic	Frequency (MHz)	SG (dBm)	Cable Loss (dB)	Gain (dBi)	Antenna Polarization	EIRP Level (dBm)	Limit (dBm)	Margin (dB)	Azimuth (deg)
2	5149.60	-61.16	3.20	12.50	Horizontal	-51.86	-25.00	26.86	135
3	7724.40	-58.14	4.40	12.30	Horizontal	-50.24	-25.00	25.24	90
4	10299.20	-52.77	4.70	11.80	Horizontal	-45.67	-25.00	20.67	225
5	12874.00	-51.94	5.40	14.00	Horizontal	-43.34	-25.00	18.34	0
6	15448.80	-52.52	6.10	16.80	Horizontal	-41.82	-25.00	16.82	45
7	18023.60	--	--	--	--	--	--	--	--
8	20598.40	--	--	--	--	--	--	--	--
9	23173.20	--	--	--	--	--	--	--	--
10	25748.00	--	--	--	--	--	--	--	--

Note: 1.The other Spurious RF Radiated emissions level is no more than noise floor.
2. The worst emission was found in the antenna is Horizontal position.



7 Main Test Instruments

Name	Manufacturer	Type	Serial Number	Calibration Date	Expiration Date
Base Station Simulator	R&S	CMW500	113824	2022-05-14	2023-05-13
Spectrum Analyzer	Keysight	N9020A	MY50510203	2021-12-12	2022-12-11
Universal Radio Communication Tester	Agilent	E5515C	GB44400275	2021-12-12	2022-12-11
Signal Analyzer	R&S	FSV3030	101411	2021-12-12	2022-12-11
Climatic Chamber	ESPEC	SU-242	93000506	2021-12-12	2022-12-11
Radiates Spurious Emission					
Signal Analyzer	R&S	FSV30	100815	2021-12-12	2022-12-11
Loop Antenna	SCHWARZBECK	FMZB1519	1519-047	2020-04-02	2023-04-01
TRILOG Broadband Antenna	SCHWARZBECK	VULB 9163	391	2019-12-16	2022-12-15
Horn Antenna	R&S	HF907	102723	2020-08-11	2023-08-10
Horn Antenna	ETS-Lindgren	3160-09	00102643	2021-10-10	2024-10-09
Horn Antenna	STEATITE	QSH-SL-26-40-K-15	16779	2019-12-24	2022-12-23
Software	R&S	EMC32	10.35.10	/	/

*****END OF REPORT *****



ANNEX A: The EUT Appearance

The EUT Appearance are submitted separately.



ANNEX B: Test Setup Photos

The Test Setup Photos are submitted separately.



ANNEX C: Product Change Description (Variant 1)

The Product Change Description are submitted separately.



ANNEX D: Product Change Description (Variant 2)

The Product Change Description are submitted separately.