

FCC SAR Test Report

APPLICANT : Xiaomi Communications Co., Ltd.
EQUIPMENT : Mobile Phone
BRAND NAME : POCO
MODEL NAME : 2201116PG
FCC ID : 2AFZZ16PG
STANDARD : FCC 47 CFR Part 2 (2.1093)

We, Sporton International (Kunshan) Inc., would like to declare that the tested sample has been evaluated in accordance with the test procedures and has been in compliance with the applicable technical standards.

The test results in this report apply exclusively to the tested model / sample. Without written approval of Sporton International (Kunshan) Inc., the test report shall not be reproduced except in full.

Tony Zhang

Reviewed by: Tong Zhang / Supervisor

Kat Yin

Approved by: Kat Yin / Manager



Sporton International (Kunshan) Inc.
No. 1098, Pengxi North Road, Kunshan Economic Development Zone Jiangsu Province 215300
People's Republic of China



Table of Contents

1. Statement of Compliance 4
2. Administration Data 6
3. Guidance Applied 6
4. Equipment Under Test (EUT) Information 7
4.1 General Information 7
4.2 General LTE SAR Test and Reporting Considerations 9
4.3 General 5G NR SAR Test and Reporting Considerations 12
5. Proximity Sensor Triggering Test 14
5.1 Proximity sensor triggering distances(Per KDB616217\$6.2) 14
6. RF Exposure Limits 16
6.1 Uncontrolled Environment 16
6.2 Controlled Environment 16
7. Specific Absorption Rate (SAR) 17
7.1 Introduction 17
7.2 SAR Definition 17
8. System Description and Setup 18
8.1 E-Field Probe 19
8.2 Data Acquisition Electronics (DAE) 19
8.3 Phantom 20
8.4 Device Holder 21
9. Measurement Procedures 22
9.1 Spatial Peak SAR Evaluation 22
9.2 Power Reference Measurement 23
9.3 Area Scan 23
9.4 Zoom Scan 24
9.5 Volume Scan Procedures 24
9.6 Power Drift Monitoring 24
10. Test Equipment List 25
11. System Verification 26
11.1 Tissue Simulating Liquids 26
11.2 Tissue Verification 27
11.3 System Performance Check Results 28
12. RF Exposure Positions 29
12.1 Ear and handset reference point 29
12.2 Definition of the cheek position 30
12.3 Definition of the tilt position 31
12.4 Body Worn Accessory 32
12.5 Product Specific 10g SAR Exposure 33
12.6 Wireless Router 33
13. Conducted RF Output Power (Unit: dBm) 34
14. Antenna Location 49
15. SAR Test Results 50
15.1 Head SAR 53
15.2 Hotspot SAR 60
15.3 Body Worn Accessory SAR 68
15.4 Product Specific SAR 72
15.5 Repeated SAR Measurement 73
16. Simultaneous Transmission Analysis 74
16.1 Head Exposure Conditions 75
16.2 Hotspot Exposure Conditions 77
16.3 Body-Worn Accessory Exposure Conditions 82
17. Uncertainty Assessment 85
18. References 86
Appendix A. Plots of System Performance Check
Appendix B. Plots of High SAR Measurement
Appendix C. DASy Calibration Certificate
Appendix D. Test Setup Photos
Appendix E. Conducted RF Output Power Table

1. Statement of Compliance

The maximum results of Specific Absorption Rate (SAR) found during testing for **Xiaomi Communications Co., Ltd., Mobile Phone, 2201116PG**, are as follows.

Highest 1g SAR Summary						
Equipment Class	Frequency Band		Head (Separation 0mm)	Hotspot (Separation 10mm)	Body-worn (Separation 10mm)	Highest Simultaneous Transmission 1g SAR (W/kg)
			1g SAR (W/kg)			
Licensed	GSM	GSM850	0.92	0.51	0.51	1.59
		GSM1900	0.82	0.74	0.74	
	WCDMA	Band II	0.99	0.91	0.79	
		Band IV	0.49	1.09	1.09	
		Band V	1.06	0.56	0.56	
	LTE	Band 4	0.33	0.77	0.79	
		Band 2	0.65	0.79	0.68	
		Band 7	0.85	0.55	0.38	
		Band 12/Band 17	0.45	0.30	0.27	
		Band 26/Band 5	0.92	0.46	0.46	
		Band 41/Band 38	0.87	0.57	0.52	
	5G NR	n5	0.77	0.54	0.54	
		n7	0.95	0.79	0.39	
		n41/ n38	1.05	0.60	0.55	
n77/ n78		0.79	0.43	0.39		
DTS	WLAN	2.4GHz WLAN	0.28	0.24	0.24	1.26
NII		5GHz WLAN	0.55	0.69	0.69	1.59
DSS	Bluetooth	2.4GHz Bluetooth	0.10	<0.10	<0.10	1.59
Highest 10g SAR Summary						
Equipment Class	Frequency Band		Product Specific 10g SAR (W/kg) (Separation 0mm)			
NII	WLAN	5GHz WLAN	1.70			
Date of Testing:			2021/12/6 ~ 2021/12/23			
Remark:						
1. This device supports LTE B5 / B17 / B38 and B26 / B12 / B41. Since the supported frequency span for LTE B5 / B17 / B38 falls completely within the supports frequency span for LTE B26 / B12 / B41, both LTE bands have the same target power, and both LTE bands share the same transmission path; therefore, SAR was only assessed for LTE B26 / B12 / B41.						
2. This device supports 5G NR n38/ n78 and 5G NR n41/ n77. Since the supported frequency span for 5G NR n38 / n78 falls completely within the supports frequency span for 5G NR n41/ n77, both LTE bands have the same target power, and both LTE bands share the same transmission path; therefore, SAR was only assessed for 5G NR n41/ n77.						



Declaration of Conformity:

The test results with all measurement uncertainty excluded are presented in accordance with the regulation limits or requirements declared by manufacturers.

Comments and Explanations:

The declared of product specification for EUT presented in the report are provided by the manufacturer, and the manufacturer takes all the responsibilities for the accuracy of product specification.

This device is in compliance with Specific Absorption Rate (SAR) for general population/uncontrolled exposure limits (1.6 W/kg for Partial-Body 1g SAR, 4.0 W/kg for Product Specific 10g SAR) specified in FCC 47 CFR part 2 (2.1093) and ANSI/IEEE C95.1-1992, and had been tested in accordance with the measurement methods and procedures specified in IEEE 1528-2013 and FCC KDB publications.



2. Administration Data

Sporton International (Kunshan) Inc. is accredited to ISO/IEC 17025:2017 by American Association for Laboratory Accreditation with Certificate Number 5145.02.

Testing Laboratory			
Test Firm	Sporton International (Kunshan) Inc.		
Test Site Location	No. 1098, Pengxi North Road, Kunshan Economic Development Zone Jiangsu Province 215300 People's Republic of China TEL : +86-512-57900158 FAX : +86-512-57900958		
Test Site No.	Sporton Site No.	FCC Designation No.	FCC Test Firm Registration No.
	SAR01-KS	CN1257	314309

Applicant	
Company Name	Xiaomi Communications Co., Ltd.
Address	#019, 9th Floor, Building 6, 33 Xi'erqi Middle Road, Haidian District, Beijing, China, 100085

Manufacturer	
Company Name	Xiaomi Communications Co., Ltd.
Address	#019, 9th Floor, Building 6, 33 Xi'erqi Middle Road, Haidian District, Beijing, China, 100085

3. Guidance Applied

The Specific Absorption Rate (SAR) testing specification, method, and procedure for this device is in accordance with the following standards:

- FCC 47 CFR Part 2 (2.1093)
- ANSI/IEEE C95.1-1992
- IEEE 1528-2013
- FCC KDB 865664 D01 SAR Measurement 100 MHz to 6 GHz v01r04
- FCC KDB 865664 D02 SAR Reporting v01r02
- FCC KDB 447498 D01 General RF Exposure Guidance v06
- FCC KDB 648474 D04 SAR Evaluation Considerations for Wireless Handsets v01r03
- FCC KDB 248227 D01 802.11 Wi-Fi SAR v02r02
- FCC KDB 616217 D04 SAR for laptop and tablets v01r02
- FCC KDB 941225 D01 3G SAR Procedures v03r01
- FCC KDB 941225 D05 SAR for LTE Devices v02r05
- FCC KDB 941225 D05A Rel.10 LTE SAR Test Guidance v01r02
- FCC KDB 941225 D06 Hotspot Mode SAR v02r01

4. Equipment Under Test (EUT) Information

4.1 General Information

Product Feature & Specification	
Equipment Name	Mobile Phone
Brand Name	POCO
Model Name	2201116PG
FCC ID	2AFZZ16PG
IMEI Code	SIM1: 864654050012102 SIM2: 864654050012110
Wireless Technology and Frequency Range	GSM850: 824 MHz ~ 849 MHz GSM1900: 1850 MHz ~ 1910 MHz WCDMA Band II: 1850 MHz ~ 1910 MHz WCDMA Band IV: 1710 MHz ~ 1755 MHz WCDMA Band V: 824 MHz ~ 849 MHz LTE Band 2: 1850 MHz ~ 1910 MHz LTE Band 4: 1710 MHz ~ 1755 MHz LTE Band 5: 824 MHz ~ 849 MHz LTE Band 7: 2500 MHz ~ 2570 MHz LTE Band 12: 699 MHz ~ 716 MHz LTE Band 17: 704 MHz ~ 716 MHz LTE Band 26: 814 MHz ~ 849 MHz LTE Band 38: 2570 MHz ~ 2620 MHz LTE Band 41: 2496 MHz ~ 2690 MHz 5G NR n5: 824 MHz ~ 849 MHz 5G NR n7: 2500 MHz ~ 2570 MHz 5G NR n38 : 2570 MHz ~ 2620 MHz 5G NR n41: 2496 MHz ~ 2690 MHz 5G NR n77: 3450 MHz ~ 3550 MHz, 3700 MHz ~ 3980 MHz 5G NR n78: 3450 MHz ~ 3550 MHz, 3700 MHz ~ 3800 MHz WLAN 2.4GHz Band: 2412 MHz ~ 2462 MHz WLAN 5.2GHz Band: 5180 MHz ~ 5240 MHz WLAN 5.3GHz Band: 5260 MHz ~ 5320 MHz WLAN 5.5GHz Band: 5500 MHz ~ 5720 MHz WLAN 5.8GHz Band: 5745 MHz ~ 5825 MHz Bluetooth: 2402 MHz ~ 2480 MHz NFC: 13.56 MHz
Mode	GSM/GPRS/EGPRS RMC/AMR 12.2Kbps HSDPA HSUPA DC-HSDPA HSPA+(16QAM uplink is not supported) LTE: QPSK, 16QAM, 64QAM LTE: 256QAM(Downlink Only) 5G NR : CP-OFDM / DFT-s-OFDM, PI/2 BPSK, QPSK, 16QAM, 64QAM, 256QAM WLAN 2.4GHz 802.11b/g/n HT20/HT40 WLAN 5GHz 802.11a/n HT20/HT40 WLAN 5GHz 802.11ac VHT20/VHT40/VHT80 Bluetooth BR/EDR/LE NFC:ASK
HW Version	P1.1
SW Version	MIUI 13
GSM / (E)GPRS Transfer mode	Class B – EUT cannot support Packet Switched and Circuit Switched Network simultaneously but can automatically switch between Packet and Circuit Switched Network.
EUT Stage	Identical Prototype
Remark:	
1. This device supports VoIP in GPRS, EGPRS, WCDMA and LTE (e.g. for 3rd-party VoIP), LTE supports VoLTE operation.	



2. This device 2.4GHz WLAN support hotspot operation and Bluetooth support tethering applications.
3. This device 2.4GHz WLAN/5.2GHz WLAN/5.8GHz WLAN support hotspot operation, and 5.2GHz WLAN/5.8GHz WLAN supports WiFi Direct (GC/GO), and 5.3GHz / 5.5GHz supports WiFi Direct (GC only).
4. This device does not support DTM operation and supports GPRS/EGPRS mode up to multi-slot class 12.
5. For dual SIM card mobile has two SIM slots and supports dual SIM dual standby. The WWAN radio transmission will be enabled by either one SIM at a time (single active). After pre-scan two SIM cards power, we found test result of the SIM1 was the worse, so we chose SIM1 slot to perform all tests.
6. There are three types of EUT. The difference is that different memory capacity. According to the differences, we choose sample 1 to perform full test.
7. The device implements Proximity sensors/receiver detect mechanism/hotspot trigger reduced power for the power management for SAR compliance at different exposure conditions (head, body-worn, hotspot, extremity). The device will invoke corresponding work scenarios power level base on frequency bands/antennas, which can refer to appendix E. power table. Full power table and reduced power table (DS1 1: receiver on reduced power for head; DS1 4: P-sensor on for hotspot/ handheld; DS1 2: receiver off/P-sensor off).
8. For 5G NR test, using FTM (Factory Test Mode) to perform SAR with default 100% transmission.
9. NSA and SA mode should perform SAR separately. For the maximum power of NSA mode is the same as SA total power level, so SA SAR can represent NSA mode SAR.
10. 5G NR NSA mode, the power level is the same as 5G NR SA mode, so 5G NR NSA mode and SA mode power table only show one time.
11. 5G NR supports CP-OFDM and DFT-s-OFDM modulation, for DFT-s-OFDM power is higher than CP-OFDM, so only show DFT-s-OFDM power table and chose DFT-s-OFDM to perform SAR testing.
12. For DFT-s-OFDM and CP-OFDM output power measurement reduction, according to 38.101 maximum power reduction for the CP-OFDM mode will not higher than DFT-s-OFDM mode, therefore, CP-OFDM measurement is unnecessary.
13. 5G NR n41/n77/n78 supports HPUE, HPUE power and SAR testing performed separately.
14. 5G NR n41/n77/n78 HPUE with higher power, n41/n77/n78 HPUE SAR can represent power class 3 level SAR.
15. For 5G NR EN-DC mode, standalone SAR performed for 5G NR band with the maximum power, EN-DC SAR summed 5G NR standalone SAR and LTE standalone SAR, the result of EN-DC SAR is more conservatively.
16. This device supports 5G NR FR1 bands as following table, including NSA mode and SA mode.

<5G NR>

Mode	Band	Duplex	SCS(KHz)	Bandwidths(BW)
NSA	n5	FDD	15	5, 10, 15, 20
	n7	FDD	15	5, 10, 15, 20
	n77	TDD	30	20, 30, 40, 50, 60, 80, 100
	n78	TDD	30	20, 30, 40, 50, 60, 80, 100
SA	n5	FDD	15	5, 10, 15, 20
	n7	FDD	15	5, 10, 15, 20
	n38	TDD	30	20, 30, 40
	n41	TDD	30	20, 30, 40, 60, 80, 100
	n77	TDD	30	20, 30, 40, 50, 60, 80, 100
	n78	TDD	30	20, 30, 40, 50, 60, 80, 100



4.2 General LTE SAR Test and Reporting Considerations

Summarized necessary items addressed in KDB 941225 D05 v02r05																																																															
FCC ID	2AFZZ16PG																																																														
Equipment Name	Mobile Phone																																																														
Operating Frequency Range of each LTE transmission band	LTE Band 2: 1850 MHz ~ 1910 MHz LTE Band 4: 1710 MHz ~ 1755 MHz LTE Band 5: 824 MHz ~ 849 MHz LTE Band 7: 2500 MHz ~ 2570 MHz LTE Band 12: 699 MHz ~ 716 MHz LTE Band 17: 704 MHz ~ 716 MHz LTE Band 26: 814 MHz ~ 849 MHz LTE Band 38: 2570 MHz ~ 2620 MHz LTE Band 41: 2496 MHz ~ 2690 MHz																																																														
Channel Bandwidth	LTE Band 2: 1.4MHz, 3MHz, 5MHz, 10MHz, 15MHz, 20MHz LTE Band 4: 1.4MHz, 3MHz, 5MHz, 10MHz, 15MHz, 20MHz LTE Band 5: 1.4MHz, 3MHz, 5MHz, 10MHz LTE Band 7: 5MHz, 10MHz, 15MHz, 20MHz LTE Band 12: 1.4MHz, 3MHz, 5MHz, 10MHz LTE Band 17: 5MHz, 10MHz LTE Band 26: 1.4MHz, 3MHz, 5MHz, 10MHz, 15MHz LTE Band 38: 5MHz, 10MHz, 15MHz, 20MHz LTE Band 41: 5MHz, 10MHz, 15MHz, 20MHz																																																														
uplink modulations used	QPSK / 16QAM / 64QAM																																																														
LTE Voice / Data requirements	Voice and Data																																																														
LTE Release Version	R15, Cat13																																																														
CA Support	Supported, Uplink and Downlink																																																														
LTE MPR permanently built-in by design	<p>Table 6.2.3-1: Maximum Power Reduction (MPR) for Power Class 1, 2 and 3</p> <table border="1"> <thead> <tr> <th rowspan="2">Modulation</th> <th colspan="6">Channel bandwidth / Transmission bandwidth (N_{RB})</th> <th rowspan="2">MPR (dB)</th> </tr> <tr> <th>1.4 MHz</th> <th>3.0 MHz</th> <th>5 MHz</th> <th>10 MHz</th> <th>15 MHz</th> <th>20 MHz</th> </tr> </thead> <tbody> <tr> <td>QPSK</td> <td>> 5</td> <td>> 4</td> <td>> 8</td> <td>> 12</td> <td>> 16</td> <td>> 18</td> <td>≤ 1</td> </tr> <tr> <td>16 QAM</td> <td>≤ 5</td> <td>≤ 4</td> <td>≤ 8</td> <td>≤ 12</td> <td>≤ 16</td> <td>≤ 18</td> <td>≤ 1</td> </tr> <tr> <td>16 QAM</td> <td>> 5</td> <td>> 4</td> <td>> 8</td> <td>> 12</td> <td>> 16</td> <td>> 18</td> <td>≤ 2</td> </tr> <tr> <td>64 QAM</td> <td>≤ 5</td> <td>≤ 4</td> <td>≤ 8</td> <td>≤ 12</td> <td>≤ 16</td> <td>≤ 18</td> <td>≤ 2</td> </tr> <tr> <td>64 QAM</td> <td>> 5</td> <td>> 4</td> <td>> 8</td> <td>> 12</td> <td>> 16</td> <td>> 18</td> <td>≤ 3</td> </tr> <tr> <td>256 QAM</td> <td colspan="6">≥ 1</td> <td>≤ 5</td> </tr> </tbody> </table>	Modulation	Channel bandwidth / Transmission bandwidth (N _{RB})						MPR (dB)	1.4 MHz	3.0 MHz	5 MHz	10 MHz	15 MHz	20 MHz	QPSK	> 5	> 4	> 8	> 12	> 16	> 18	≤ 1	16 QAM	≤ 5	≤ 4	≤ 8	≤ 12	≤ 16	≤ 18	≤ 1	16 QAM	> 5	> 4	> 8	> 12	> 16	> 18	≤ 2	64 QAM	≤ 5	≤ 4	≤ 8	≤ 12	≤ 16	≤ 18	≤ 2	64 QAM	> 5	> 4	> 8	> 12	> 16	> 18	≤ 3	256 QAM	≥ 1						≤ 5
Modulation	Channel bandwidth / Transmission bandwidth (N _{RB})						MPR (dB)																																																								
	1.4 MHz	3.0 MHz	5 MHz	10 MHz	15 MHz	20 MHz																																																									
QPSK	> 5	> 4	> 8	> 12	> 16	> 18	≤ 1																																																								
16 QAM	≤ 5	≤ 4	≤ 8	≤ 12	≤ 16	≤ 18	≤ 1																																																								
16 QAM	> 5	> 4	> 8	> 12	> 16	> 18	≤ 2																																																								
64 QAM	≤ 5	≤ 4	≤ 8	≤ 12	≤ 16	≤ 18	≤ 2																																																								
64 QAM	> 5	> 4	> 8	> 12	> 16	> 18	≤ 3																																																								
256 QAM	≥ 1						≤ 5																																																								
LTE A-MPR	In the base station simulator configuration, Network Setting value is set to NS_01 to disable A-MPR during SAR testing and the LTE SAR tests was transmitting on all TTI frames (Maximum TTI)																																																														
Spectrum plots for RB configuration	A properly configured base station simulator was used for the SAR and power measurement; therefore, spectrum plots for each RB allocation and offset configuration are not included in the SAR report.																																																														
Power reduction applied to satisfy SAR compliance	Yes, head/body-worn/ hotspot/extremity will trigger reduced power for some bands, the detail please referred to section 13.																																																														
LTE Carrier Aggregation Combinations	Inter-Band and Intra-Band possible combinations and the detail power verification please referred to section 13.																																																														
LTE Carrier Aggregation Additional Information	1. This device supports LTE Carrier Aggregation (CA) in the uplink for intra-band and inter-band with two component carriers in the uplink. SAR Measurements and conducted powers were evaluated per FCC Guidance. 2. This device supports maximum of 3 carriers in the downlink and 2 carriers in the uplink.																																																														



Transmission (H, M, L) channel numbers and frequencies in each LTE band													
LTE Band 2													
	Bandwidth 1.4 MHz		Bandwidth 3 MHz		Bandwidth 5 MHz		Bandwidth 10 MHz		Bandwidth 15 MHz		Bandwidth 20 MHz		
	Ch. #	Freq. (MHz)	Ch. #	Freq. (MHz)	Ch. #	Freq. (MHz)	Ch. #	Freq. (MHz)	Ch. #	Freq. (MHz)	Ch. #	Freq. (MHz)	
L	18607	1850.7	18615	1851.5	18625	1852.5	18650	1855	18675	1857.5	18700	1860	
M	18900	1880	18900	1880	18900	1880	18900	1880	18900	1880	18900	1880	
H	19193	1909.3	19185	1908.5	19175	1907.5	19150	1905	19125	1902.5	19100	1900	
LTE Band 4													
	Bandwidth 1.4 MHz		Bandwidth 3 MHz		Bandwidth 5 MHz		Bandwidth 10 MHz		Bandwidth 15 MHz		Bandwidth 20 MHz		
	Ch. #	Freq. (MHz)	Ch. #	Freq. (MHz)	Ch. #	Freq. (MHz)	Ch. #	Freq. (MHz)	Ch. #	Freq. (MHz)	Ch. #	Freq. (MHz)	
L	19957	1710.7	19965	1711.5	19975	1712.5	20000	1715	20025	1717.5	20050	1720	
M	20175	1732.5	20175	1732.5	20175	1732.5	20175	1732.5	20175	1732.5	20175	1732.5	
H	20393	1754.3	20385	1753.5	20375	1752.5	20350	1750	20325	1747.5	20300	1745	
LTE Band 5													
	Bandwidth 1.4 MHz		Bandwidth 3 MHz		Bandwidth 5 MHz		Bandwidth 10 MHz		Bandwidth 15 MHz		Bandwidth 20 MHz		
	Ch. #	Freq. (MHz)	Ch. #	Freq. (MHz)	Ch. #	Freq. (MHz)	Ch. #	Freq. (MHz)	Ch. #	Freq. (MHz)	Ch. #	Freq. (MHz)	
L	20407	824.7	20415	825.5	20425	826.5	20450	829	20450	829	20450	829	
M	20525	836.5	20525	836.5	20525	836.5	20525	836.5	20525	836.5	20525	836.5	
H	20643	848.3	20635	847.5	20625	846.5	20600	844	20600	844	20600	844	
LTE Band 7													
	Bandwidth 5 MHz		Bandwidth 10 MHz		Bandwidth 15 MHz		Bandwidth 20 MHz		Bandwidth 15 MHz		Bandwidth 20 MHz		
	Ch. #	Freq. (MHz)	Ch. #	Freq. (MHz)	Ch. #	Freq. (MHz)	Ch. #	Freq. (MHz)	Ch. #	Freq. (MHz)	Ch. #	Freq. (MHz)	
L	20775	2502.5	20800	2505	20825	2507.5	20850	2510	20850	2510	20850	2510	
M	21100	2535	21100	2535	21100	2535	21100	2535	21100	2535	21100	2535	
H	21425	2567.5	21400	2565	21375	2562.5	21350	2560	21350	2560	21350	2560	
LTE Band 12													
	Bandwidth 1.4 MHz		Bandwidth 3 MHz		Bandwidth 5 MHz		Bandwidth 10 MHz		Bandwidth 15 MHz		Bandwidth 20 MHz		
	Ch. #	Freq. (MHz)	Ch. #	Freq. (MHz)	Ch. #	Freq. (MHz)	Ch. #	Freq. (MHz)	Ch. #	Freq. (MHz)	Ch. #	Freq. (MHz)	
L	23017	699.7	23025	700.5	23035	701.5	23060	704	23060	704	23060	704	
M	23095	707.5	23095	707.5	23095	707.5	23095	707.5	23095	707.5	23095	707.5	
H	23173	715.3	23165	714.5	23155	713.5	23130	711	23130	711	23130	711	
LTE Band 17													
	Bandwidth 5 MHz				Bandwidth 10 MHz				Bandwidth 15 MHz				Bandwidth 20 MHz
	Channel #		Freq.(MHz)		Channel #		Freq. (MHz)		Channel #		Freq. (MHz)		Channel #
L	23755		706.5		23780		709		23780		709		23780
M	23790		710		23790		710		23790		710		23790
H	23825		713.5		23800		711		23800		711		23800
LTE Band 26													
	Bandwidth 1.4 MHz		Bandwidth 3 MHz		Bandwidth 5 MHz		Bandwidth 10 MHz		Bandwidth 15 MHz		Bandwidth 20 MHz		
	Ch. #	Freq. (MHz)	Ch. #	Freq. (MHz)	Ch. #	Freq. (MHz)	Ch. #	Freq. (MHz)	Ch. #	Freq. (MHz)	Ch. #	Freq. (MHz)	
L	26697	814.7	26705	815.5	26715	816.5	26740	819	26740	819	26765	821.5	
M	26865	831.5	26865	831.5	26865	831.5	26865	831.5	26865	831.5	26865	831.5	
H	27033	848.3	27025	847.5	27015	846.5	26990	844	26990	844	26965	841.5	



LTE Band 38								
	Bandwidth 5 MHz		Bandwidth 10 MHz		Bandwidth 15 MHz		Bandwidth 20 MHz	
	Ch. #	Freq. (MHz)	Ch. #	Freq. (MHz)	Ch. #	Freq. (MHz)	Ch. #	Freq. (MHz)
L	37775	2572.5	37800	2575	37825	2577.5	37850	2580
M	38000	2595	38000	2595	38000	2595	38000	2595
H	38225	2617.5	38200	2615	38175	2612.5	38150	2610
LTE Band 41								
	Bandwidth 5 MHz		Bandwidth 10 MHz		Bandwidth 15 MHz		Bandwidth 20 MHz	
	Ch. #	Freq. (MHz)	Ch. #	Freq. (MHz)	Ch. #	Freq. (MHz)	Ch. #	Freq. (MHz)
L	39675	2498.5	39700	2501	39725	2503.5	39750	2506
LM	40148	2545.8	40160	2547	40173	2548.3	40185	2549.5
M	40620	2593	40620	2593	40620	2593	40620	2593
HM	41093	2640.3	41080	2639	41068	2637.8	41055	2636.5
H	41565	2687.5	41540	2685	41515	2682.5	41490	2680



4.3 General 5G NR SAR Test and Reporting Considerations

5G NR Information	
Operating Frequency Range of each 5G NR transmission band	5G NR n5: 824 MHz ~ 849 MHz 5G NR n7: 2500 MHz ~ 2570 MHz 5G NR n38 : 2570 MHz ~ 2620 MHz 5G NR n41: 2496 MHz ~ 2690 MHz 5G NR n77: 3450 MHz ~ 3550 MHz, 3700 MHz ~ 3980 MHz 5G NR n78: 3450 MHz ~ 3550 MHz, 3700 MHz ~ 3800 MHz
Channel Bandwidth	5G NR n5: 5MHz, 10MHz, 15MHz, 20MHz 5G NR n7: 5MHz, 10MHz, 15MHz, 20MHz 5G NR n38: 20MHz, 30MHz, 40MHz 5G NR n41: 20MHz, 30MHz, 40MHz, 60MHz, 80MHz, 100MHz 5G NR n77: 20MHz, 30MHz, 40MHz, 50MHz, 60MHz, 80MHz, 100MHz 5G NR n78: 20MHz, 30MHz, 40MHz, 50MHz, 60MHz, 80MHz, 100MHz
SCS	FDD: SCS15KHz, TDD: SCS30KHz
uplink modulations used	DFT-s-OFDM: PI/2 BPSK / QPSK / 16QAM / 64QAM / 256QAM CP-OFDM: QPSK / 16QAM / 64QAM / 256QAM
A-MPR (Additional MPR) disabled for SAR Testing?	Yes
LTE Anchor Bands for n5	LTE B7
LTE Anchor Bands for n7	LTE B5
LTE Anchor Bands for n77	LTE B2
LTE Anchor Bands for n78	LTE B2/5/7/38/41

NR Band 5 SCS15KHz												
	Bandwidth 5MHz		Bandwidth 10MHz		Bandwidth 15MHz		Bandwidth 20MHz					
	Ch. #	Freq. (MHz)	Ch. #	Freq. (MHz)	Ch. #	Freq. (MHz)	Ch. #	Freq. (MHz)				
L	165300	826.5	165800	829	166300	831.5	166800	834				
M	167300	836.5	167300	836.5	167300	836.5	167300	836.5				
H	169300	846.5	168800	844	168300	841.5	167800	839				
NR Band 7 SCS15KHz												
	Bandwidth 5MHz		Bandwidth 10MHz		Bandwidth 15MHz		Bandwidth 20MHz					
	Ch. #	Freq. (MHz)	Ch. #	Freq. (MHz)	Ch. #	Freq. (MHz)	Ch. #	Freq. (MHz)				
L	500500	2502.5	501000	2505	501500	2507.5	502000	2510				
M	507000	2535	507000	2535	507000	2535	507000	2535				
H	513500	2567.5	513000	2565	512500	2562.5	512000	2560				
NR Band 38 SCS30KHz												
	Bandwidth 20MHz		Bandwidth 30MHz		Bandwidth 40MHz							
	Ch. #	Freq. (MHz)	Ch. #	Freq. (MHz)	Ch. #	Freq. (MHz)	Ch. #	Freq. (MHz)				
L	516000	2580	517002	2585.01	518004	2590.02						
M	519000	2595	519000	2595	519000	2595						
H	522000	2610	520998	2604.99	519996	2599.98						
NR Band 41 SCS30KHz												
	Bandwidth 20MHz		Bandwidth 30MHz		Bandwidth 40MHz		Bandwidth 60MHz		Bandwidth 80MHz		Bandwidth 100MHz	
	Ch. #	Freq. (MHz)	Ch. #	Freq. (MHz)	Ch. #	Freq. (MHz)	Ch. #	Freq. (MHz)	Ch. #	Freq. (MHz)	Ch. #	Freq. (MHz)
L	501204	2506.02	502200	2511	503202	2516.01	505200	2526	507204	2536.02	509202	2546.01
M	518598	2592.99	518598	2592.99	518598	2592.99	518598	2592.99	518598	2592.99	518598	2592.99
H	535998	2679.99	534996	2674.98	534000	2670	531996	2659.98	529998	2649.99	528000	2640



<3700 MHz ~ 3980 MHz>

NR Band 77														
Bandwidth 20MHz		Bandwidth 30MHz		Bandwidth 40MHz		Bandwidth 50MHz		Bandwidth 60MHz		Bandwidth 80MHz		Bandwidth 100MHz		
Ch. #	Freq. (MHz)	Ch. #	Freq. (MHz)	Ch. #	Freq. (MHz)	Ch. #	Freq. (MHz)	Ch. #	Freq. (MHz)	Ch. #	Freq. (MHz)	Ch. #	Freq. (MHz)	
L	647334	3710.01	647668	3715.02	648000	3720	648334	3725.01	648668	3730.02	649334	3740.01	650000	3750
M	656000	3840	656000	3840	656000	3840	656000	3840	656000	3840	656000	3840	656000	3840
H	664668	3970.02	664334	3965.01	664000	3960	663668	3955.02	663334	3950.01	662668	3940.02	662000	3930

NR Band 78														
Bandwidth 20MHz		Bandwidth 30MHz		Bandwidth 40MHz		Bandwidth 50MHz		Bandwidth 60MHz		Bandwidth 80MHz		Bandwidth 100MHz		
Ch. #	Freq. (MHz)	Ch. #	Freq. (MHz)	Ch. #	Freq. (MHz)	Ch. #	Freq. (MHz)	Ch. #	Freq. (MHz)	Ch. #	Freq. (MHz)	Ch. #	Freq. (MHz)	
L	647334	3710.01	647668	3715.02	648000	3720	648334	3725.01	648668	3730.02	649334	3740.01		
M	650000	3750	650000	3750	650000	3750	650000	3750	650000	3750	650000	3750	650000	3750
H	652668	3790.02	652334	3785.01	652000	3780	651668	3775.02	651334	3770.01	650668	3760.02		

<3450 MHz ~ 3550 MHz>

NR Band 77														
Bandwidth 20MHz		Bandwidth 30MHz		Bandwidth 40MHz		Bandwidth 50MHz		Bandwidth 60MHz		Bandwidth 80MHz		Bandwidth 100MHz		
Ch. #	Freq. (MHz)	Ch. #	Freq. (MHz)	Ch. #	Freq. (MHz)	Ch. #	Freq. (MHz)	Ch. #	Freq. (MHz)	Ch. #	Freq. (MHz)	Ch. #	Freq. (MHz)	
L	630668	3460.02	631000	3465	631334	3470.01	631668	3475.02	632000	3480	632668	3490.02		
M	633334	3500.01	633334	3500.01	633334	3500.01	633334	3500.01	633334	3500.01	633334	3500.01	633334	3500.01
H	636000	3540	635668	3535.02	635334	3530.01	635000	3525	634668	3520.02	634000	3510		

NR Band 78														
Bandwidth 20MHz		Bandwidth 30MHz		Bandwidth 40MHz		Bandwidth 50MHz		Bandwidth 60MHz		Bandwidth 80MHz		Bandwidth 100MHz		
Ch. #	Freq. (MHz)	Ch. #	Freq. (MHz)	Ch. #	Freq. (MHz)	Ch. #	Freq. (MHz)	Ch. #	Freq. (MHz)	Ch. #	Freq. (MHz)	Ch. #	Freq. (MHz)	
L	630668	3460.02	631000	3465	631334	3470.01	631668	3475.02	632000	3480	632668	3490.02		
M	633334	3500.01	633334	3500.01	633334	3500.01	633334	3500.01	633334	3500.01	633334	3500.01	633334	3500.01
H	636000	3540	635668	3535.02	635334	3530.01	635000	3525	634668	3520.02	634000	3510		

5. Proximity Sensor Triggering Test

5.1 Proximity sensor triggering distances(Per KDB616217§6.2)

1. Proximity sensor triggering distance testing was performed according to the procedures outlined in KDB 616217 D04 section 6.2, and EUT moving further away from the flat phantom and EUT moving toward the flat phantom were both assessed.
2. Proximity sensor triggering distance testing was performed according and EUT moving further away from the flat phantom and EUT moving toward the flat phantom were both assessed and the tissue-equivalent medium for highest frequency (3980MHz) and lowest (1750MHz) frequency was used for proximity sensor triggering testing.
3. Capacitive proximity sensor placed coincident with antenna elements at the top/bottom end of the phone are utilized to determine when the device comes in proximity of the user's body or finger or hand at the front or back or bottom or left or right or top side of the device. There is no need to do sensor coverage testing for the proximity sensor is designed to support sufficient detection range and sensitivity to cover regions of the sensors in all applicable directions since the proximity sensor entirely covers the antenna.
4. The sensors can use to detect the proximity of the user's body or handheld states at the front or back or bottom or top or left side of the device use a detection threshold distance. When front/back/left/top/bottom sides of body or handheld condition is detected reduced power will be active. The trigger distance shown in the sections below.
5. For verification of compliance of power reduction scheme, additional SAR testing with EUT transmitting at full RF power at a conservative trigger distance -1mm was performed.

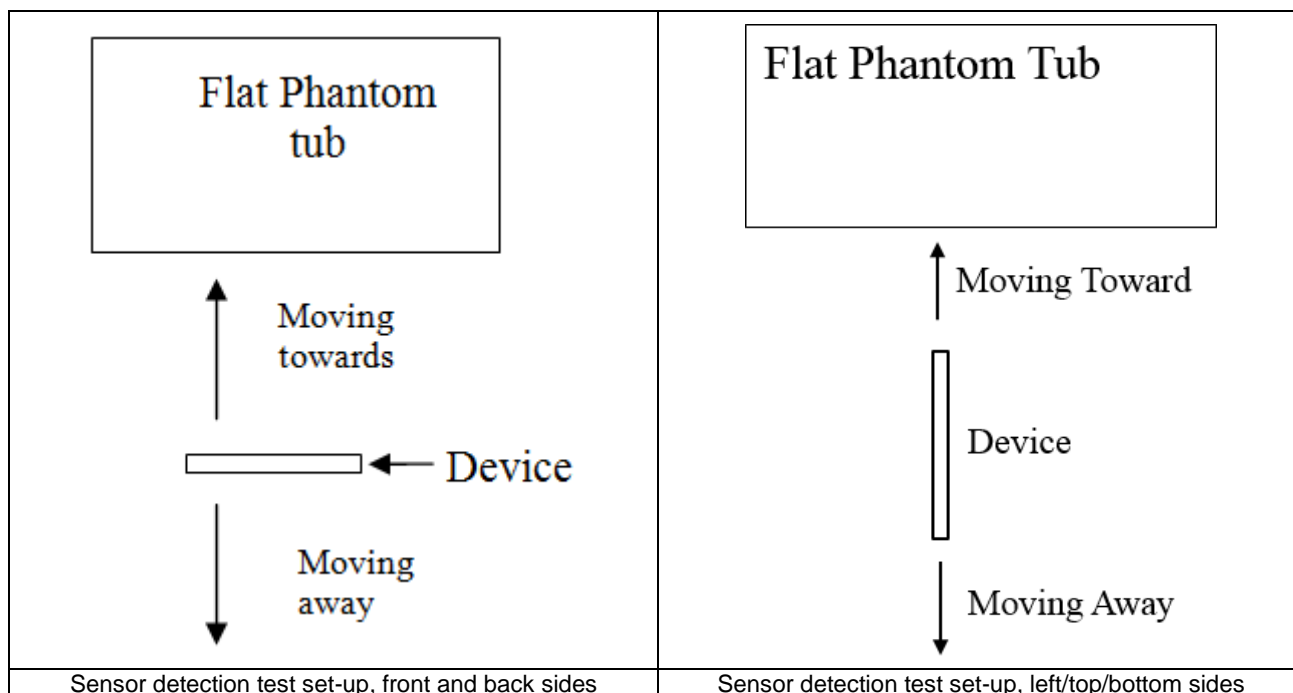

<P-Sensor>

<Sensor pad1 for Ant0 >

(Declared by manufacturer)

Proximity Sensor Triggering Distance (mm)								
Position	Front		Back		Bottom Side		Left Side	
	Moving towards	Moving away	Moving towards	Moving away	Moving towards	Moving away	Moving towards	Moving away
Minimum	16	16	21	21	16	16	6	6

<Sensor pad2 for Ant3/Ant4/ant5>

(Declared by manufacturer)

Proximity Sensor Triggering Distance (mm)								
Position	Front		Back		Top Side		Left Side	
	Moving towards	Moving away	Moving towards	Moving away	Moving towards	Moving away	Moving towards	Moving away
Minimum	16	16	21	21	16	16	6	6

6. RF Exposure Limits

6.1 Uncontrolled Environment

Uncontrolled Environments are defined as locations where there is the exposure of individuals who have no knowledge or control of their exposure. The general population/uncontrolled exposure limits are applicable to situations in which the general public may be exposed or in which persons who are exposed as a consequence of their employment may not be made fully aware of the potential for exposure or cannot exercise control over their exposure. Members of the general public would come under this category when exposure is not employment-related; for example, in the case of a wireless transmitter that exposes persons in its vicinity.

6.2 Controlled Environment

Controlled Environments are defined as locations where there is exposure that may be incurred by persons who are aware of the potential for exposure, (i.e. as a result of employment or occupation). In general, occupational/controlled exposure limits are applicable to situations in which persons are exposed as a consequence of their employment, who have been made fully aware of the potential for exposure and can exercise control over their exposure. The exposure category is also applicable when the exposure is of a transient nature due to incidental passage through a location where the exposure levels may be higher than the general population/uncontrolled limits, but the exposed person is fully aware of the potential for exposure and can exercise control over his or her exposure by leaving the area or by some other appropriate means.

Limits for Occupational/Controlled Exposure (W/kg)

Whole-Body	Partial-Body	Hands, Wrists, Feet and Ankles
0.4	8.0	20.0

Limits for General Population/Uncontrolled Exposure (W/kg)

Whole-Body	Partial-Body	Hands, Wrists, Feet and Ankles
0.08	1.6	4.0

Whole-Body SAR is averaged over the entire body, partial-body SAR is averaged over any 1gram of tissue defined as a tissue volume in the shape of a cube. SAR for hands, wrists, feet and ankles is averaged over any 10 grams of tissue defined as a tissue volume in the shape of a cube.

7. Specific Absorption Rate (SAR)

7.1 Introduction

SAR is related to the rate at which energy is absorbed per unit mass in an object exposed to a radio field. The SAR distribution in a biological body is complicated and is usually carried out by experimental techniques or numerical modeling. The standard recommends limits for two tiers of groups, occupational/controlled and general population/uncontrolled, based on a person's awareness and ability to exercise control over his or her exposure. In general, occupational/controlled exposure limits are higher than the limits for general population/uncontrolled.

7.2 SAR Definition

The SAR definition is the time derivative (rate) of the incremental energy (dW) absorbed by (dissipated in) an incremental mass (dm) contained in a volume element (dv) of a given density (ρ). The equation description is as below:

$$\text{SAR} = \frac{d}{dt} \left(\frac{dW}{dm} \right) = \frac{d}{dt} \left(\frac{dW}{\rho dv} \right)$$

SAR is expressed in units of Watts per kilogram (W/kg)

$$\text{SAR} = \frac{\sigma |E|^2}{\rho}$$

Where: σ is the conductivity of the tissue, ρ is the mass density of the tissue and E is the RMS electrical field strength.

8. System Description and Setup

The DASY system used for performing compliance tests consists of the following items:

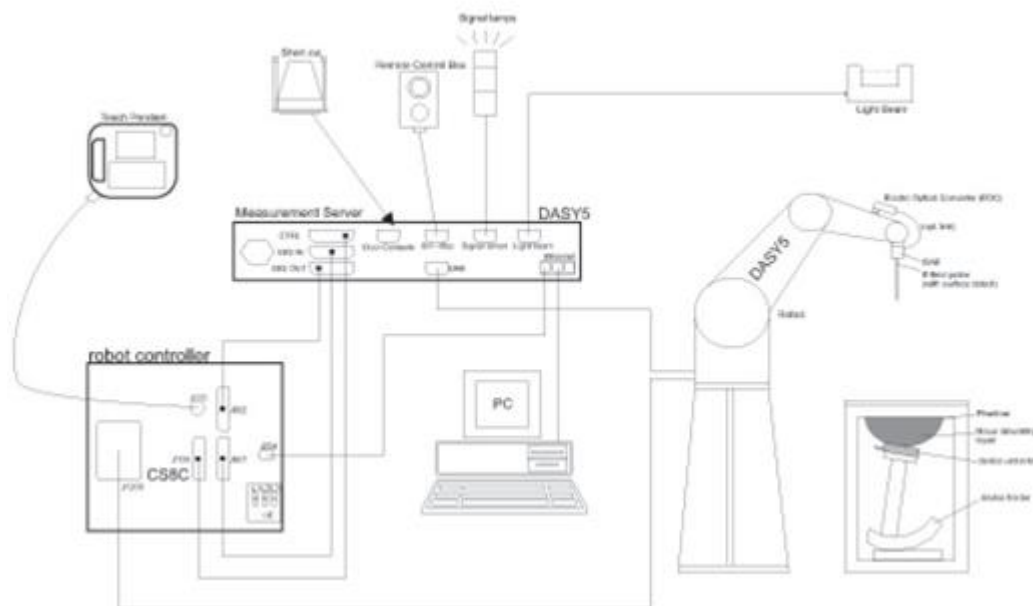

- A standard high precision 6-axis robot with controller, teach pendant and software. An arm extension for accommodating the data acquisition electronics (DAE).
- An isotropic Field probe optimized and calibrated for the targeted measurement.
- A data acquisition electronics (DAE) which performs the signal amplification, signal multiplexing, AD-conversion, offset measurements, mechanical surface detection, collision detection, etc. The unit is battery powered with standard or rechargeable batteries. The signal is optically transmitted to the EOC.
- The Electro-optical converter (EOC) performs the conversion from optical to electrical signals for the digital communication to the DAE. To use optical surface detection, a special version of the EOC is required. The EOC signal is transmitted to the measurement server.
- The function of the measurement server is to perform the time critical tasks such as signal filtering, control of the robot operation and fast movement interrupts.
- The Light Beam used is for probe alignment. This improves the (absolute) accuracy of the probe positioning.
- A computer running WinXP or Win7 and the DASY5 software.
- Remote control and teach pendant as well as additional circuitry for robot safety such as warning lamps, etc.
- The phantom, the device holder and other accessories according to the targeted measurement.

8.1 E-Field Probe

The SAR measurement is conducted with the dosimetric probe (manufactured by SPEAG).The probe is specially designed and calibrated for use in liquid with high permittivity. The dosimetric probe has special calibration in liquid at different frequency. This probe has a built in optical surface detection system to prevent from collision with phantom.

<EX3DV4 Probe>

Construction	Symmetric design with triangular core Built-in shielding against static charges PEEK enclosure material (resistant to organic solvents, e.g., DGBE)	
Frequency	10 MHz – >6 GHz Linearity: ±0.2 dB (30 MHz – 6 GHz)	
Directivity	±0.3 dB in TSL (rotation around probe axis) ±0.5 dB in TSL (rotation normal to probe axis)	
Dynamic Range	10 µW/g – >100 mW/g Linearity: ±0.2 dB (noise: typically <1 µW/g)	
Dimensions	Overall length: 337 mm (tip: 20 mm) Tip diameter: 2.5 mm (body: 12 mm) Typical distance from probe tip to dipole centers: 1 mm	

8.2 Data Acquisition Electronics (DAE)

The data acquisition electronics (DAE) consists of a highly sensitive electrometer-grade preamplifier with auto-zeroing, a channel and gain-switching multiplexer, a fast 16 bit AD-converter and a command decoder and control logic unit. Transmission to the measurement server is accomplished through an optical downlink for data and status information as well as an optical uplink for commands and the clock.

The input impedance of the DAE is 200 MOhm; the inputs are symmetrical and floating. Common mode rejection is above 80 dB.



Photo of DAE

8.3 Phantom

<SAM Twin Phantom>

Shell Thickness	2 ± 0.2 mm; Center ear point: 6 ± 0.2 mm	
Filling Volume	Approx. 25 liters	
Dimensions	Length: 1000 mm; Width: 500 mm; Height: adjustable feet	
Measurement Areas	Left Hand, Right Hand, Flat Phantom	

The bottom plate contains three pair of bolts for locking the device holder. The device holder positions are adjusted to the standard measurement positions in the three sections. A white cover is provided to tap the phantom during off-periods to prevent water evaporation and changes in the liquid parameters. On the phantom top, three reference markers are provided to identify the phantom position with respect to the robot.

<ELI Phantom>

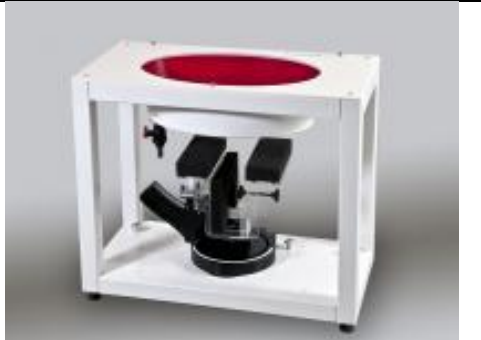
Shell Thickness	2 ± 0.2 mm (sagging: <1%)	
Filling Volume	Approx. 30 liters	
Dimensions	Major ellipse axis: 600 mm Minor axis: 400 mm	

The ELI phantom is intended for compliance testing of handheld and body-mounted wireless devices in the frequency range of 30 MHz to 6 GHz. ELI4 is fully compatible with standard and all known tissue simulating liquids.

8.4 Device Holder

<Mounting Device for Hand-Held Transmitter>

In combination with the Twin SAM V5.0/V5.0c or ELI phantoms, the Mounting Device for Hand-Held Transmitters enables rotation of the mounted transmitter device to specified spherical coordinates. At the heads, the rotation axis is at the ear opening. Transmitter devices can be easily and accurately positioned according to IEC 62209-1, IEEE 1528, FCC, or other specifications. The device holder can be locked for positioning at different phantom sections (left head, right head, flat). And upgrade kit to Mounting Device to enable easy mounting of wider devices like big smart-phones, e-books, small tablets, etc. It holds devices with width up to 140 mm.



Mounting Device for Hand-Held Transmitters



Mounting Device Adaptor for Wide-Phones

<Mounting Device for Laptops and other Body-Worn Transmitters>

The extension is lightweight and made of POM, acrylic glass and foam. It fits easily on the upper part of the mounting device in place of the phone positioned. The extension is fully compatible with the SAM Twin and ELI phantoms.



Mounting Device for Laptops

9. Measurement Procedures

The measurement procedures are as follows:

<Conducted power measurement>

- (a) For WWAN power measurement, use base station simulator to configure EUT WWAN transmission in conducted connection with RF cable, at maximum power in each supported wireless interface and frequency band.
- (b) Read the WWAN RF power level from the base station simulator.
- (c) For WLAN/BT power measurement, use engineering software to configure EUT WLAN/BT continuously transmission, at maximum RF power in each supported wireless interface and frequency band
- (d) Connect EUT RF port through RF cable to the power meter, and measure WLAN/BT output power

<SAR measurement>

- (a) Use base station simulator to configure EUT WWAN transmission in radiated connection, and engineering software to configure EUT WLAN/BT continuously transmission, at maximum RF power, in the highest power channel.
- (b) Place the EUT in the positions as Appendix D demonstrates.
- (c) Set scan area, grid size and other setting on the DASY software.
- (d) Measure SAR results for the highest power channel on each testing position.
- (e) Find out the largest SAR result on these testing positions of each band
- (f) Measure SAR results for other channels in worst SAR testing position if the reported SAR of highest power channel is larger than 0.8 W/kg

According to the test standard, the recommended procedure for assessing the peak spatial-average SAR value consists of the following steps:

- (a) Power reference measurement
- (b) Area scan
- (c) Zoom scan
- (d) Power drift measurement

9.1 Spatial Peak SAR Evaluation

The procedure for spatial peak SAR evaluation has been implemented according to the test standard. It can be conducted for 1g and 10g, as well as for user-specific masses. The DASY software includes all numerical procedures necessary to evaluate the spatial peak SAR value.

The base for the evaluation is a "cube" measurement. The measured volume must include the 1g and 10g cubes with the highest averaged SAR values. For that purpose, the center of the measured volume is aligned to the interpolated peak SAR value of a previously performed area scan.

The entire evaluation of the spatial peak values is performed within the post-processing engine (SEMCAD). The system always gives the maximum values for the 1g and 10g cubes. The algorithm to find the cube with highest averaged SAR is divided into the following stages:

- (a) Extraction of the measured data (grid and values) from the Zoom Scan
- (b) Calculation of the SAR value at every measurement point based on all stored data (A/D values and measurement parameters)
- (c) Generation of a high-resolution mesh within the measured volume
- (d) Interpolation of all measured values from the measurement grid to the high-resolution grid
- (e) Extrapolation of the entire 3-D field distribution to the phantom surface over the distance from sensor to surface
- (f) Calculation of the averaged SAR within masses of 1g and 10g

9.2 Power Reference Measurement

The Power Reference Measurement and Power Drift Measurements are for monitoring the power drift of the device under test in the batch process. The minimum distance of probe sensors to surface determines the closest measurement point to phantom surface. This distance cannot be smaller than the distance of sensor calibration points to probe tip as defined in the probe properties.

9.3 Area Scan

The area scan is used as a fast scan in two dimensions to find the area of high field values, before doing a fine measurement around the hot spot. The sophisticated interpolation routines implemented in DASY software can find the maximum found in the scanned area, within a range of the global maximum. The range (in dB0 is specified in the standards for compliance testing. For example, a 2 dB range is required in IEEE standard 1528 and IEC 62209 standards, whereby 3 dB is a requirement when compliance is assessed in accordance with the ARIB standard (Japan), if only one zoom scan follows the area scan, then only the absolute maximum will be taken as reference. For cases where multiple maximums are detected, the number of zoom scans has to be increased accordingly.

Area scan parameters extracted from FCC KDB 865664 D01v01r04 SAR measurement 100 MHz to 6 GHz.

	≤ 3 GHz	> 3 GHz
Maximum distance from closest measurement point (geometric center of probe sensors) to phantom surface	5 ± 1 mm	$\frac{1}{2} \cdot \delta \cdot \ln(2) \pm 0.5$ mm
Maximum probe angle from probe axis to phantom surface normal at the measurement location	$30^\circ \pm 1^\circ$	$20^\circ \pm 1^\circ$
Maximum area scan spatial resolution: $\Delta x_{Area}, \Delta y_{Area}$	≤ 2 GHz: ≤ 15 mm $2 - 3$ GHz: ≤ 12 mm	$3 - 4$ GHz: ≤ 12 mm $4 - 6$ GHz: ≤ 10 mm
	When the x or y dimension of the test device, in the measurement plane orientation, is smaller than the above, the measurement resolution must be \leq the corresponding x or y dimension of the test device with at least one measurement point on the test device.	

9.4 Zoom Scan

Zoom scans are used to assess the peak spatial SAR values within a cubic averaging volume containing 1 gram and 10 gram of simulated tissue. The zoom scan measures points (refer to table below) within a cube whose base faces are centered on the maxima found in a preceding area scan job within the same procedure. When the measurement is done, the zoom scan evaluates the averaged SAR for 1 gram and 10 gram and displays these values next to the job's label.

Zoom scan parameters extracted from FCC KDB 865664 D01v01r04 SAR measurement 100 MHz to 6 GHz.

			≤ 3 GHz	> 3 GHz
Maximum zoom scan spatial resolution: Δx_{Zoom} , Δy_{Zoom}			≤ 2 GHz: ≤ 8 mm 2 – 3 GHz: ≤ 5 mm*	3 – 4 GHz: ≤ 5 mm* 4 – 6 GHz: ≤ 4 mm*
Maximum zoom scan spatial resolution, normal to phantom surface	uniform grid: $\Delta z_{Zoom}(n)$		≤ 5 mm	3 – 4 GHz: ≤ 4 mm 4 – 5 GHz: ≤ 3 mm 5 – 6 GHz: ≤ 2 mm
	graded grid	$\Delta z_{Zoom}(1)$: between 1 st two points closest to phantom surface	≤ 4 mm	3 – 4 GHz: ≤ 3 mm 4 – 5 GHz: ≤ 2.5 mm 5 – 6 GHz: ≤ 2 mm
		$\Delta z_{Zoom}(n>1)$: between subsequent points	$\leq 1.5 \cdot \Delta z_{Zoom}(n-1)$	
Minimum zoom scan volume	x, y, z	≥ 30 mm	3 – 4 GHz: ≥ 28 mm 4 – 5 GHz: ≥ 25 mm 5 – 6 GHz: ≥ 22 mm	
Note: δ is the penetration depth of a plane-wave at normal incidence to the tissue medium; see draft standard IEEE P1528-2011 for details. * When zoom scan is required and the <i>reported</i> SAR from the <i>area scan based 1-g SAR estimation</i> procedures of KDB 447498 is ≤ 1.4 W/kg, ≤ 8 mm, ≤ 7 mm and ≤ 5 mm zoom scan resolution may be applied, respectively, for 2 GHz to 3 GHz, 3 GHz to 4 GHz and 4 GHz to 6 GHz.				

9.5 Volume Scan Procedures

The volume scan is used to assess overlapping SAR distributions for antennas transmitting in different frequency bands. It is equivalent to an oversized zoom scan used in standalone measurements. The measurement volume will be used to enclose all the simultaneous transmitting antennas. For antennas transmitting simultaneously in different frequency bands, the volume scan is measured separately in each frequency band. In order to sum correctly to compute the 1g aggregate SAR, the EUT remain in the same test position for all measurements and all volume scan use the same spatial resolution and grid spacing. When all volume scan were completed, the software, SEMCAD postprocessor can combine and subsequently superpose these measurement data to calculating the multiband SAR.

9.6 Power Drift Monitoring

All SAR testing is under the EUT install full charged battery and transmit maximum output power. In DASy measurement software, the power reference measurement and power drift measurement procedures are used for monitoring the power drift of EUT during SAR test. Both these procedures measure the field at a specified reference position before and after the SAR testing. The software will calculate the field difference in dB. If the power drifts more than 5%, the SAR will be retested.



10. Test Equipment List

Manufacturer	Name of Equipment	Type/Model	Serial Number	Calibration	
				Last Cal.	Due Date
SPEAG	750MHz System Validation Kit	D750V3	1087	2019/3/27	2022/3/24
SPEAG	835MHz System Validation Kit	D835V2	4d258	2020/5/7	2023/5/6
SPEAG	1750MHz System Validation Kit	D1750V2	1090	2019/3/27	2022/3/25
SPEAG	1900MHz System Validation Kit	D1900V2	5d170	2019/3/26	2022/3/24
SPEAG	2450MHz System Validation Kit	D2450V2	908	2019/3/25	2022/3/23
SPEAG	2600MHz System Validation Kit	D2600V2	1061	2020/11/26	2023/11/25
SPEAG	3500MHz System Validation Kit	D3500V2	1037	2020/11/25	2023/11/24
SPEAG	3700MHz System Validation Kit	D3700V2	1008	2020/11/25	2023/11/24
SPEAG	3900MHz System Validation Kit	D3900V2	1048	2020/5/14	2023/5/13
SPEAG	5000MHz System Validation Kit	D5GHzV2	1113	2019/9/24	2022/9/22
SPEAG	Data Acquisition Electronics	DAE4	1649	2021/2/3	2022/2/2
SPEAG	Dosimetric E-Field Probe	EX3DV4	3857	2021/11/24	2022/11/23
SPEAG	SAM Twin Phantom	SAM Twin	TP-1754	NCR	NCR
Testo	Thermo-Hygrometer	608-H1	1241332102	2021/1/7	2022/1/6
SPEAG	Phone Positioner	N/A	N/A	NCR	NCR
Anritsu	Radio Communication Analyzer	MT8821C	6201432831	2021/4/13	2022/4/12
Agilent	ENA Series Network Analyzer	E5071C	MY46106933	2021/7/31	2022/7/30
SPEAG	Dielectric Probe Kit	DAK-3.5	1138	2021/6/9	2022/6/8
Anritsu	Vector Signal Generator	MG3710A	6201682672	2021/1/7	2022/1/6
Rohde & Schwarz	Power Meter	NRVD	102081	2021/8/12	2022/8/11
Rohde & Schwarz	Power Sensor	NRV-Z5	100538	2021/8/12	2022/8/11
Rohde & Schwarz	Power Sensor	NRV-Z5	100539	2021/8/12	2022/8/11
R&S	CBT BLUETOOTH TESTER	CBT	101246	2021/4/12	2022/4/11
EXA	Spectrum Analyzer	FSV7	101632	2021/1/7	2022/1/6
FLUKE	DIGITAC THERMOMETER	51II	97240029	2021/8/13	2022/8/12
BONN	POWER AMPLIFIER	BLMA 0830-3	087193A	Note 1	
BONN	POWER AMPLIFIER	BLMA 2060-2	087193B	Note 1	
Agilent	Dual Directional Coupler	778D	20500	Note 1	
Agilent	Dual Directional Coupler	11691D	MY48151020	Note 1	
ARRA	Power Divider	A3200-2	N/A	Note 1	
MCL	Attenuation1	BW-S10W5+	N/A	Note 1	
MCL	Attenuation2	BW-S10W5+	N/A	Note 1	
MCL	Attenuation3	BW-S10W5+	N/A	Note 1	

Note:

1. Prior to system verification and validation, the path loss from the signal generator to the system check source and the power meter, which includes the amplifier, cable, attenuator and directional coupler, was measured by the network analyzer. The reading of the power meter was offset by the path loss difference between the path to the power meter and the path to the system check source to monitor the actual power level fed to the system check
2. Referring to KDB 865664 D01v01r04, the dipole calibration interval can be extended to 3 years with justification. The dipoles are also not physically damaged, or repaired during the interval.
3. The justification data of dipole can be found in appendix C. The return loss is < -20dB, within 20% of prior calibration, the impedance is within 5 ohm of prior calibration.

11. System Verification

11.1 Tissue Simulating Liquids

For the measurement of the field distribution inside the SAM phantom with DASY, the phantom must be filled with around 25 liters of homogeneous body tissue simulating liquid. For head SAR testing, the liquid height from the ear reference point (ERP) of the phantom to the liquid top surface is larger than 15 cm, which is shown in Fig. 11.1. For body SAR testing, the liquid height from the center of the flat phantom to the liquid top surface is larger than 15 cm, which is shown in Fig. 11.2.

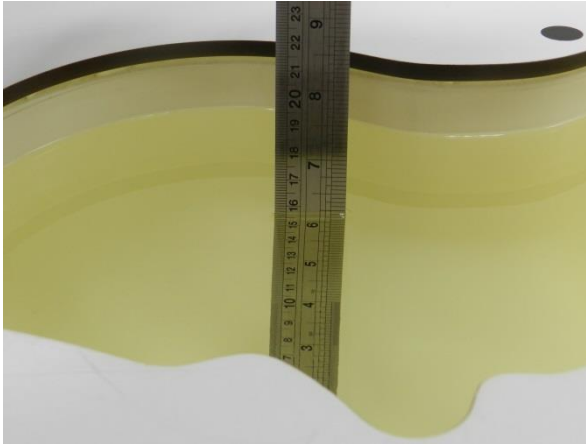

Fig 11.1 Photo of Liquid Height for Head SAR

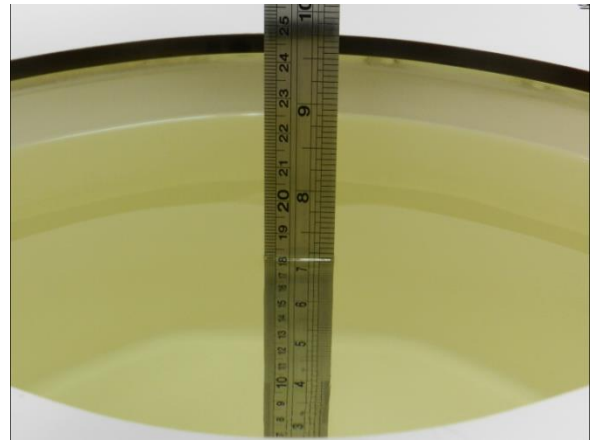

Fig 11.2 Photo of Liquid Height for Body SAR



11.2 Tissue Verification

The following tissue formulations are provided for reference only as some of the parameters have not been thoroughly verified. The composition of ingredients may be modified accordingly to achieve the desired target tissue parameters required for routine SAR evaluation.

Frequency (MHz)	Water (%)	Sugar (%)	Cellulose (%)	Salt (%)	Preventol (%)	DGBE (%)	Conductivity (σ)	Permittivity (ε _r)
For Head								
750	41.1	57.0	0.2	1.4	0.2	0	0.89	41.9
835	40.3	57.9	0.2	1.4	0.2	0	0.90	41.5
1800, 1900, 2000	55.2	0	0	0.3	0	44.5	1.40	40.0
2450	55.0	0	0	0	0	45.0	1.80	39.2
2600	54.8	0	0	0.1	0	45.1	1.96	39.0

Simulating Liquid for 5GHz, Manufactured by SPEAG

Ingredients	(% by weight)
Water	64~78%
Mineral oil	11~18%
Emulsifiers	9~15%
Additives and Salt	2~3%

<Tissue Dielectric Parameter Check Results>

Frequency (MHz)	Head	Liquid Temp. (°C)	Conductivity (σ)	Permittivity (ε _r)	Conductivity Target (σ)	Permittivity Target (ε _r)	Delta (σ) (%)	Delta (ε _r) (%)	Limit (%)	Date
750	Head	22.7	0.915	41.844	0.89	41.90	2.81	-0.13	±5	2021/12/6
835	Head	22.7	0.938	42.440	0.90	41.50	4.22	2.27	±5	2021/12/7
1750	Head	22.6	1.394	40.496	1.37	40.10	1.75	0.99	±5	2021/12/8
1900	Head	22.6	1.458	39.790	1.40	40.00	4.14	-0.53	±5	2021/12/9
2600	Head	22.6	1.975	40.602	1.96	39.00	0.77	4.11	±5	2021/12/10
3500	Head	22.7	2.785	38.983	2.91	37.90	-4.30	2.86	±5	2021/12/11
3700	Head	22.7	2.984	38.787	3.12	37.70	-4.36	2.88	±5	2021/12/11
3900	Head	22.7	3.310	38.758	3.32	37.50	-0.30	3.35	±5	2021/12/12
750	Head	22.8	0.913	41.756	0.89	41.90	2.58	-0.34	±5	2021/12/13
835	Head	22.8	0.929	40.938	0.90	41.50	3.22	-1.35	±5	2021/12/14
1750	Head	22.8	1.410	40.677	1.37	40.10	2.92	1.44	±5	2021/12/15
1900	Head	22.7	1.453	39.680	1.40	40.00	3.79	-0.80	±5	2021/12/16
2600	Head	22.7	1.922	38.215	1.96	39.00	-1.94	-2.01	±5	2021/12/17
3500	Head	22.8	2.781	39.191	2.91	37.90	-4.43	3.41	±5	2021/12/18
3700	Head	22.6	2.981	38.645	3.12	37.70	-4.46	2.51	±5	2021/12/18
3900	Head	22.7	3.280	37.613	3.32	37.50	-1.20	0.30	±5	2021/12/19
2450	Head	22.6	1.824	39.207	1.80	39.20	1.33	0.02	±5	2021/12/20
5250	Head	22.8	4.552	36.094	4.71	35.90	-3.35	0.54	±5	2021/12/21
5600	Head	22.7	4.926	35.565	5.07	35.50	-2.84	0.18	±5	2021/12/22
5750	Head	22.8	5.100	35.380	5.22	35.40	-2.30	-0.06	±5	2021/12/23

11.3 System Performance Check Results

Comparing to the original SAR value provided by SPEAG, the verification data should be within its specification of 10 %. Below table shows the target SAR and measured SAR after normalized to 1W input power. The table below indicates the system performance check can meet the variation criterion and the plots can be referred to Appendix A of this report.

<1g SAR>

Date	Frequency (MHz)	Head	Input Power (mW)	Dipole S/N	Probe S/N	DAE S/N	Measured 1g SAR (W/kg)	Targeted 1g SAR (W/kg)	Normalized 1g SAR (W/kg)	Deviation (%)
2021/12/6	750	Head	50	1087	3857	1649	0.429	8.36	8.58	2.63
2021/12/7	835	Head	50	4d258	3857	1649	0.508	9.44	10.16	7.63
2021/12/8	1750	Head	50	1090	3857	1649	1.900	36.40	38	4.40
2021/12/9	1900	Head	50	5d170	3857	1649	2.100	39.00	42	7.69
2021/12/10	2600	Head	50	1061	3857	1649	2.770	56.60	55.4	-2.12
2021/12/11	3500	Head	50	1037	3857	1649	3.260	68.00	65.2	-4.12
2021/12/11	3700	Head	50	1048	3857	1649	3.290	67.60	65.8	-2.66
2021/12/12	3900	Head	50	1048	3857	1649	3.350	70.20	67	-4.56
2021/12/13	750	Head	50	1087	3857	1649	0.416	8.36	8.32	-0.48
2021/12/14	835	Head	50	4d258	3857	1649	0.505	9.44	10.1	6.99
2021/12/15	1750	Head	50	1090	3857	1649	1.960	36.40	39.2	7.69
2021/12/16	1900	Head	50	5d170	3857	1649	2.090	39.00	41.8	7.18
2021/12/17	2600	Head	50	1061	3857	1649	2.710	56.60	54.2	-4.24
2021/12/18	3500	Head	50	1037	3857	1649	3.150	68.00	63	-7.35
2021/12/18	3700	Head	50	1008	3857	1649	3.210	67.60	64.2	-5.03
2021/12/19	3900	Head	50	1048	3857	1649	3.280	70.20	65.6	-6.55
2021/12/20	2450	Head	50	908	3857	1649	2.500	52.80	50	-5.30
2021/12/21	5250	Head	50	1113	3857	1649	4.160	80.50	83.2	3.35
2021/12/22	5600	Head	50	1113	3857	1649	4.240	83.40	84.8	1.68
2021/12/23	5750	Head	50	1113	3857	1649	3.920	80.00	78.4	-2.00

<10g SAR>

Date	Frequency (MHz)	Head	Input Power (mW)	Dipole S/N	Probe S/N	DAE S/N	Measured 10g SAR (W/kg)	Targeted 10g SAR (W/kg)	Normalized 10g SAR (W/kg)	Deviation (%)
2021/12/21	5250	Head	50	1113	3857	1649	1.190	23.10	23.8	3.03
2021/12/22	5600	Head	50	1113	3857	1649	1.200	23.80	24	0.84
2021/12/23	5750	Head	50	1113	3857	1649	1.120	22.80	22.4	-1.75

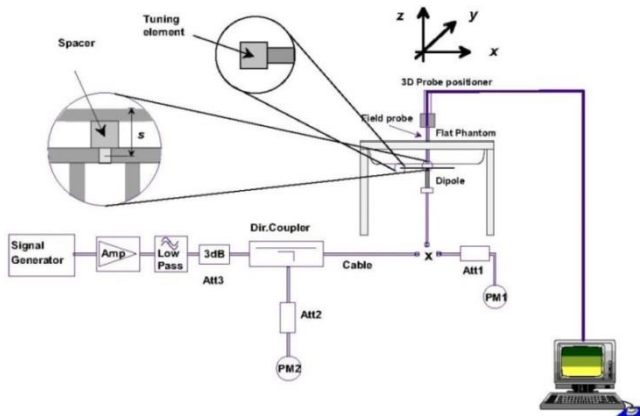

Fig 11.3.1 System Performance Check Setup



Fig 11.3.2 Setup Photo

12. RF Exposure Positions

12.1 Ear and handset reference point

Figure 12.1.1 shows the front, back, and side views of the SAM phantom. The center-of-mouth reference point is labeled “M,” the left ear reference point (ERP) is marked “LE,” and the right ERP is marked “RE.” Each ERP is 15 mm along the B-M (back-mouth) line behind the entrance-to-ear-canal (EEC) point, as shown in Figure 12.1.2 The Reference Plane is defined as passing through the two ear reference points and point M. The line N-F (neck-front), also called the reference pivoting line, is normal to the Reference Plane and perpendicular to both a line passing through RE and LE and the B-M line (see Figure 12.1.3). Both N-F and B-M lines should be marked on the exterior of the phantom shell to facilitate handset positioning. Posterior to the N-F line the ear shape is a flat surface with 6 mm thickness at each ERP, and forward of the N-F line the ear is truncated, as illustrated in Figure 12.1.2. The ear truncation is introduced to preclude the ear lobe from interfering with handset tilt, which could lead to unstable positioning at the cheek.

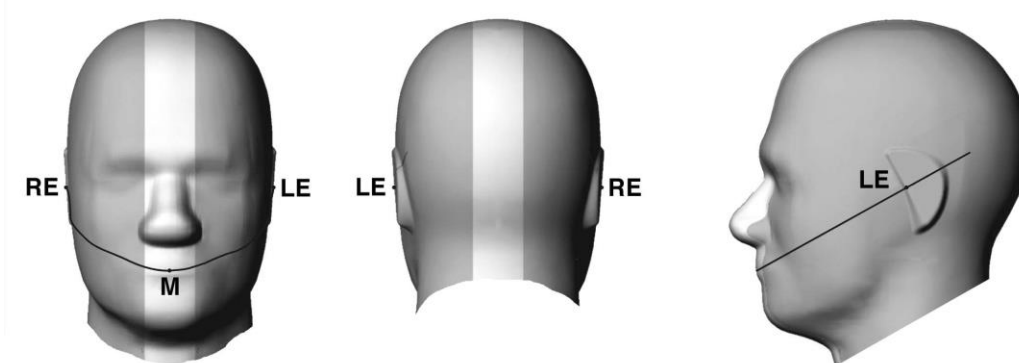

Fig 12.1.1 Front, back, and side views of SAM twin phantom

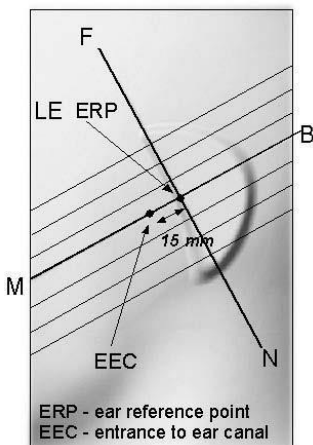

Fig 12.1.2 Close-up side view of phantom showing the ear region.

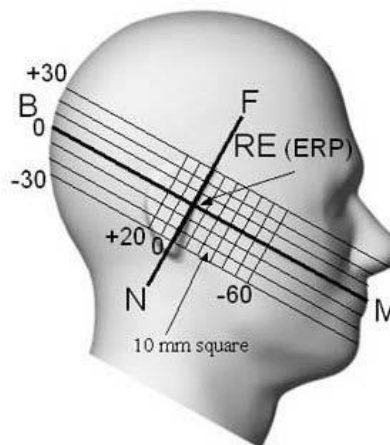

Fig 12.1.3 Side view of the phantom showing relevant markings and seven cross-sectional plane locations

12.2 Definition of the cheek position

1. Ready the handset for talk operation, if necessary. For example, for handsets with a cover piece (flip cover), open the cover. If the handset can transmit with the cover closed, both configurations must be tested.
2. Define two imaginary lines on the handset—the vertical centerline and the horizontal line. The vertical centerline passes through two points on the front side of the handset—the midpoint of the width w_t of the handset at the level of the acoustic output (point A in Figure 12.2.1 and Figure 12.2.2), and the midpoint of the width w_b of the bottom of the handset (point B). The horizontal line is perpendicular to the vertical centerline and passes through the center of the acoustic output (see Figure 12.2.1). The two lines intersect at point A. Note that for many handsets, point A coincides with the center of the acoustic output; however, the acoustic output may be located elsewhere on the horizontal line. Also note that the vertical centerline is not necessarily parallel to the front face of the handset (see Figure 12.2.2), especially for clamshell handsets, handsets with flip covers, and other irregularly-shaped handsets.
3. Position the handset close to the surface of the phantom such that point A is on the (virtual) extension of the line passing through points RE and LE on the phantom (see Figure 12.2.3), such that the plane defined by the vertical centerline and the horizontal line of the handset is approximately parallel to the sagittal plane of the phantom.
4. Translate the handset towards the phantom along the line passing through RE and LE until handset point A touches the pinna at the ERP.
5. While maintaining the handset in this plane, rotate it around the LE-RE line until the vertical centerline is in the plane normal to the plane containing B-M and N-F lines, i.e., the Reference Plane.
6. Rotate the handset around the vertical centerline until the handset (horizontal line) is parallel to the N-F line.
7. While maintaining the vertical centerline in the Reference Plane, keeping point A on the line passing through RE and LE, and maintaining the handset contact with the pinna, rotate the handset about the N-F line until any point on the handset is in contact with a phantom point below the pinna on the cheek. See Figure 12.2.3. The actual rotation angles should be documented in the test report.

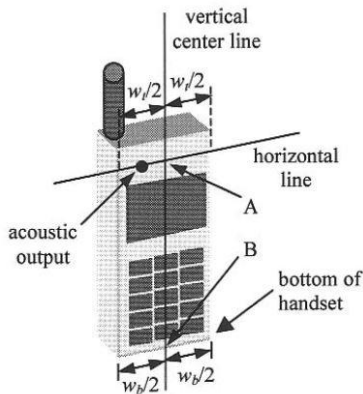

Fig 12.2.1 Handset vertical and horizontal reference lines—“fixed case”

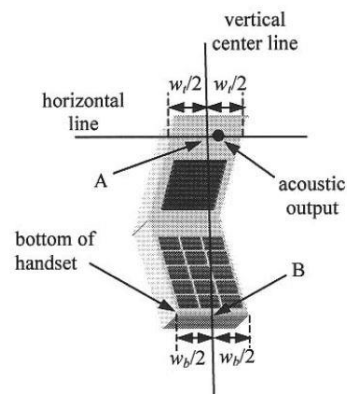

Fig 12.2.2 Handset vertical and horizontal reference lines—“clam-shell case”

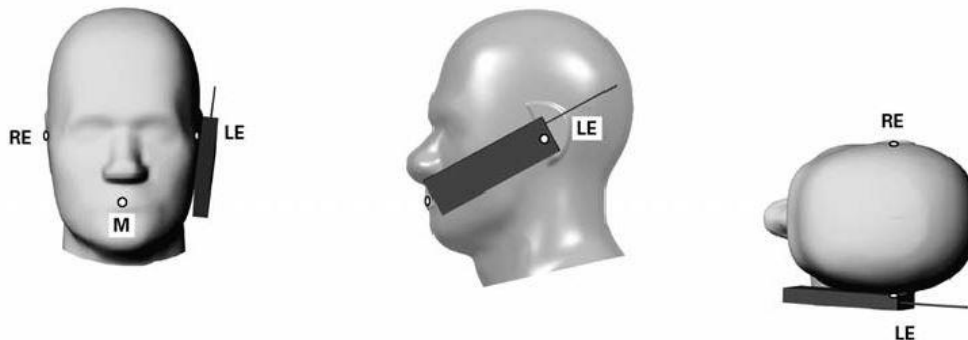

Fig 12.2.3 cheek or touch position. The reference points for the right ear (RE), left ear (LE), and mouth (M), which establish the Reference Plane for handset positioning, are indicated.

12.3 Definition of the tilt position

1. Ready the handset for talk operation, if necessary. For example, for handsets with a cover piece (flip cover), open the cover. If the handset can transmit with the cover closed, both configurations must be tested.
2. While maintaining the orientation of the handset, move the handset away from the pinna along the line passing through RE and LE far enough to allow a rotation of the handset away from the cheek by 15°.
3. Rotate the handset around the horizontal line by 15°.
4. While maintaining the orientation of the handset, move the handset towards the phantom on the line passing through RE and LE until any part of the handset touches the ear. The tilt position is obtained when the contact point is on the pinna. See Figure 12.3.1. If contact occurs at any location other than the pinna, e.g., the antenna at the back of the phantom head, the angle of the handset should be reduced. In this case, the tilt position is obtained if any point on the handset is in contact with the pinna and a second point

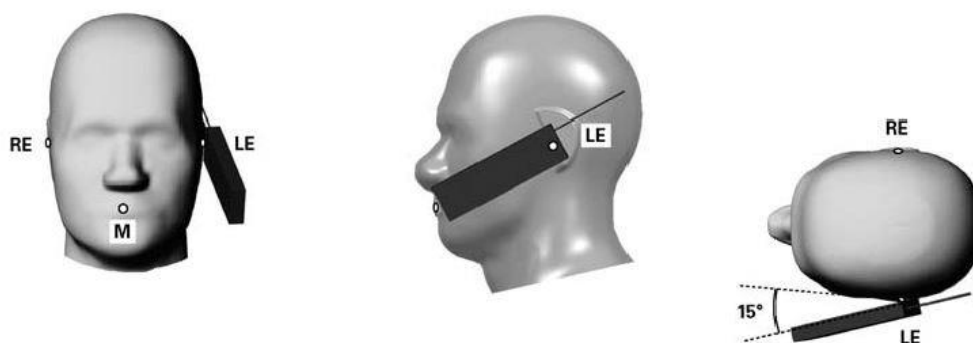

Fig 12.3.1 Tilt position. The reference points for the right ear (RE), left ear (LE), and mouth (M), which define the Reference Plane for handset positioning, are indicated.

12.4 Body Worn Accessory

Body-worn operating configurations are tested with the belt-clips and holsters attached to the device and positioned against a flat phantom in a normal use configuration (see Figure 12.4). Per KDB648474 D04v01r03, body-worn accessory exposure is typically related to voice mode operations when handsets are carried in body-worn accessories. The body-worn accessory procedures in FCC KDB 447498 D01v06 should be used to test for body-worn accessory SAR compliance, without a headset connected to it. This enables the test results for such configuration to be compatible with that required for hotspot mode when the body-worn accessory test separation distance is greater than or equal to that required for hotspot mode, when applicable. When the reported SAR for body-worn accessory, measured without a headset connected to the handset is $> 1.2 \text{ W/kg}$, the highest reported SAR configuration for that wireless mode and frequency band should be repeated for that body-worn accessory with a headset attached to the handset.

Accessories for body-worn operation configurations are divided into two categories: those that do not contain metallic components and those that do contain metallic components. When multiple accessories that do not contain metallic components are supplied with the device, the device is tested with only the accessory that dictates the closest spacing to the body. Then multiple accessories that contain metallic components are tested with the device with each accessory. If multiple accessories share an identical metallic component (i.e. the same metallic belt-clip used with different holsters with no other metallic components) only the accessory that dictates the closest spacing to the body is tested.

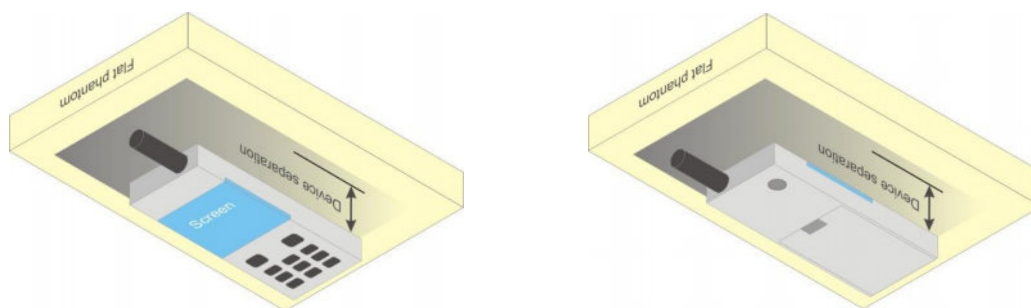

Fig 12.4 Body Worn Position



12.5 Product Specific 10g SAR Exposure

For smart phones with a display diagonal dimension > 15.0 cm or an overall diagonal dimension > 16.0 cm that provide similar mobile web access and multimedia support found in mini-tablets or UMPC mini-tablets that support voice calls next to the ear, According to KDB648474 D04v01r03, the following phablet procedures should be applied to evaluate SAR compliance for each applicable wireless modes and frequency band. Devices marketed as phablets, regardless of form factors and operating characteristics must be tested as a phablet to determine SAR compliance

1. The normally required head and body-worn accessory SAR test procedures for handsets, including hotspot mode, must be applied.
2. The UMPC mini-tablet procedures must also be applied to test the SAR of all surfaces and edges with an antenna located at ≤ 25 mm from that surface or edge, in direct contact with a flat phantom, for 10-g extremity SAR according to the body-equivalent tissue dielectric parameters in KDB 865664 to address interactive hand use exposure conditions.6 The UMPC mini-tablet 1-g SAR at 5 mm is not required. When hotspot mode applies, 10-g extremity SAR is required only for the surfaces and edges with hotspot mode 1-g reported SAR > 1.2 W/kg.

12.6 Wireless Router

Some battery-operated handsets have the capability to transmit and receive user through simultaneous transmission of WIFI simultaneously with a separate licensed transmitter. The FCC has provided guidance in FCC KDB Publication 941225 D06 v02r01 where SAR test considerations for handsets ($L \times W \geq 9$ cm x 5 cm) are based on a composite test separation distance of 10mm from the front, back and edges of the device containing transmitting antennas within 2.5cm of their edges, determined from general mixed use conditions for this type of devices. Since the hotspot SAR results may overlap with the body-worn accessory SAR requirements, the more conservative configurations can be considered, thus excluding some body-worn accessory SAR tests.

When the user enables the personal wireless router functions for the handset, actual operations include simultaneous transmission of both the WIFI transmitter and another licensed transmitter. Both transmitters often do not transmit at the same transmitting frequency and thus cannot be evaluated for SAR under actual use conditions due to the limitations of the SAR assessment probes. Therefore, SAR must be evaluated for each frequency transmission and mode separately and spatially summed with the WIFI transmitter according to FCC KDB Publication 447498 D01v06 publication procedures. The "Portable Hotspot" feature on the handset was NOT activated during SAR assessments, to ensure the SAR measurements were evaluated for a single transmission frequency RF signal at a time.

13. Conducted RF Output Power (Unit: dBm)

The detailed conducted power table can refer to Appendix E.

<GSM Conducted Power>

1. Per KDB 447498 D01v06, the maximum output power channel is used for SAR testing and for further SAR test reduction.
2. Per KDB 941225 D01v03r01, for SAR test reduction for GSM / GPRS / EDGE modes is determined by the source-based time-averaged output power including tune-up tolerance. The mode with highest specified time-averaged output power should be tested for SAR compliance in the applicable exposure conditions. For modes with the same specified maximum output power and tolerance, the higher number time-slot configuration should be tested.
3. Other configurations of GSM / GPRS / EDGE are considered as secondary modes. The 3G SAR test reduction procedure is applied, when the maximum output power and tune-up tolerance specified for production units in a secondary mode is $\leq 1/4$ dB higher than the primary mode, SAR measurement is not required for the secondary mode.

<WCDMA Conducted Power>

1. The following tests were conducted according to the test requirements outlines in 3GPP TS 34.121 specification.
2. The procedures in KDB 941225 D01v03r01 are applied for 3GPP Rel. 6 HSPA to configure the device in the required sub-test mode(s) to determine SAR test exclusion.
3. For DC-HSDPA, the device was configured according to the H-Set 12, Fixed Reference Channel (FRC) configuration in Table C.8.1.12 of 3GPP TS 34.121-1, with the primary and the secondary serving HS-DSCH Cell enabled during the power measurement.

A summary of these settings are illustrated below:

HSDPA Setup Configuration:

- a. The EUT was connected to Base Station Agilent E5515C referred to the Setup Configuration.
- b. The RF path losses were compensated into the measurements.
- c. A call was established between EUT and Base Station with following setting:
 - i. Set Gain Factors (β_c and β_d) and parameters were set according to each
 - ii. Specific sub-test in the following table, C10.1.4, quoted from the TS 34.121
 - iii. Set RMC 12.2Kbps + HSDPA mode.
 - iv. Set Cell Power = -86 dBm
 - v. Set HS-DSCH Configuration Type to FRC (H-set 1, QPSK)
 - vi. Select HSDPA Uplink Parameters
 - vii. Set Delta ACK, Delta NACK and Delta CQI = 8
 - viii. Set Ack-Nack Repetition Factor to 3
 - ix. Set CQI Feedback Cycle (k) to 4 ms
 - x. Set CQI Repetition Factor to 2
 - xi. Power Ctrl Mode = All Up bits
- d. The transmitted maximum output power was recorded.

Table C.10.1.4: β values for transmitter characteristics tests with HS-DPCCH

Sub-test	β_c	β_d	β_d (SF)	β_o/β_d	β_{HS} (Note 1, Note 2)	CM (dB) (Note 3)	MPR (dB) (Note 3)
1	2/15	15/15	64	2/15	4/15	0.0	0.0
2	12/15 (Note 4)	15/15 (Note 4)	64	12/15 (Note 4)	24/15	1.0	0.0
3	15/15	8/15	64	15/8	30/15	1.5	0.5
4	15/15	4/15	64	15/4	30/15	1.5	0.5

Note 1: Δ_{ACK} , Δ_{NACK} and $\Delta_{CQI} = 30/15$ with $\beta_{HS} = 30/15 * \beta_c$.

Note 2: For the HS-DPCCH power mask requirement test in clause 5.2C, 5.7A, and the Error Vector Magnitude (EVM) with HS-DPCCH test in clause 5.13.1A, and HSDPA EVM with phase discontinuity in clause 5.13.1AA, Δ_{ACK} and $\Delta_{NACK} = 30/15$ with $\beta_{HS} = 30/15 * \beta_c$, and $\Delta_{CQI} = 24/15$ with $\beta_{HS} = 24/15 * \beta_c$.

Note 3: CM = 1 for $\beta_o/\beta_d = 12/15$, $\beta_{HS}/\beta_c = 24/15$. For all other combinations of DPDCH, DPCCH and HS-DPCCH the MPR is based on the relative CM difference. This is applicable for only UEs that support HSDPA in release 6 and later releases.

Note 4: For subtest 2 the β_o/β_d ratio of 12/15 for the TFC during the measurement period (TF1, TF0) is achieved by setting the signalled gain factors for the reference TFC (TF1, TF1) to $\beta_c = 11/15$ and $\beta_d = 15/15$.

Setup Configuration

HSUPA Setup Configuration:

- a. The EUT was connected to Base Station Agilent E5515C referred to the Setup Configuration.
- b. The RF path losses were compensated into the measurements.
- c. A call was established between EUT and Base Station with following setting * :
 - i. Call Configs = 5.2B, 5.9B, 5.10B, and 5.13.2B with QPSK
 - ii. Set the Gain Factors (β_c and β_d) and parameters (AG Index) were set according to each specific sub-test in the following table, C11.1.3, quoted from the TS 34.121
 - iii. Set Cell Power = -86 dBm
 - iv. Set Channel Type = 12.2k + HSPA
 - v. Set UE Target Power
 - vi. Power Ctrl Mode= Alternating bits
 - vii. Set and observe the E-TFCI
 - viii. Confirm that E-TFCI is equal to the target E-TFCI of 75 for sub-test 1, and other subtest's E-TFCI
- d. The transmitted maximum output power was recorded.

Table C.11.1.3: β values for transmitter characteristics tests with HS-DPCCH and E-DCH

Sub-test	β_c	β_d	β_d (SF)	β_c/β_d	β_{HS} (Note1)	β_{ec}	β_{ed} (Note 4) (Note 5)	β_{ed} (SF)	β_{ed} (Codes)	CM (dB) (Note 2)	MPR (dB) (Note 2) (Note 6)	AG Index (Note 5)	E-TFCI
1	11/15 (Note 3)	15/15 (Note 3)	64	11/15 (Note 3)	22/15	209/25	1309/225	4	1	1.0	0.0	20	75
2	6/15	15/15	64	6/15	12/15	12/15	94/75	4	1	3.0	2.0	12	67
3	15/15	9/15	64	15/9	30/15	30/15	β_{ed1} : 47/15 β_{ed2} : 47/15	4 4	2	2.0	1.0	15	92
4	2/15	15/15	64	2/15	4/15	2/15	56/75	4	1	3.0	2.0	17	71
5	15/15	0	-	-	5/15	5/15	47/15	4	1	1.0	0.0	12	67

Note 1: For sub-test 1 to 4, Δ_{ACK} , Δ_{NACK} and $\Delta_{CQI} = 30/15$ with $\beta_{hs} = 30/15 * \beta_c$. For sub-test 5, Δ_{ACK} , Δ_{NACK} and $\Delta_{CQI} = 5/15$ with $\beta_{hs} = 5/15 * \beta_c$.

Note 2: CM = 1 for $\beta_c/\beta_d = 12/15$, $\beta_{hs}/\beta_c = 24/15$. For all other combinations of DPDCH, DPCCH, HS- DPCCH, E-DPDCH and E-DPCCH the MPR is based on the relative CM difference.

Note 3: For subtest 1 the β_c/β_d ratio of 11/15 for the TFC during the measurement period (TF1, TF0) is achieved by setting the signalled gain factors for the reference TFC (TF1, TF0) to $\beta_c = 10/15$ and $\beta_d = 15/15$.

Note 4: In case of testing by UE using E-DPDCH Physical Layer category 1, Sub-test 3 is omitted according to TS25.306 Table 5.1g.

Note 5: β_{ed} can not be set directly; it is set by Absolute Grant Value.

Note 6: For subtests 2, 3 and 4, UE may perform E-DPDCH power scaling at max power which could results in slightly smaller MPR values.

Setup Configuration

DC-HSDPA 3GPP release 8 Setup Configuration:

- a. The EUT was connected to Base Station referred to the Setup Configuration below
- b. The RF path losses were compensated into the measurements.
- c. A call was established between EUT and Base Station with following setting:
 - i. Set RMC 12.2Kbps + HSDPA mode.
 - ii. Set Cell Power = -25 dBm
 - iii. Set HS-DSCH Configuration Type to FRC (H-set 12, QPSK)
 - iv. Select HSDPA Uplink Parameters
 - v. Set Gain Factors (β_c and β_d) and parameters were set according to each Specific sub-test in the following table, C10.1.4, quoted from the TS 34.121
 - a). Subtest 1: $\beta_c/\beta_d=2/15$
 - b). Subtest 2: $\beta_c/\beta_d=12/15$
 - c). Subtest 3: $\beta_c/\beta_d=15/8$
 - d). Subtest 4: $\beta_c/\beta_d=15/4$
 - vi. Set Delta ACK, Delta NACK and Delta CQI = 8
 - vii. Set Ack-Nack Repetition Factor to 3
 - viii. Set CQI Feedback Cycle (k) to 4 ms
 - ix. Set CQI Repetition Factor to 2
 - x. Power Ctrl Mode = All Up bits
- d. The transmitted maximum output power was recorded.

The following tests were conducted according to the test requirements outlines in 3GPP TS 34.121 specification. A summary of these settings are illustrated below:

C.8.1.12 Fixed Reference Channel Definition H-Set 12

Table C.8.1.12: Fixed Reference Channel H-Set 12

Parameter	Unit	Value
Nominal Avg. Inf. Bit Rate	kbps	60
Inter-TTI Distance	TTI's	1
Number of HARQ Processes	Processes	6
Information Bit Payload (N_{INF})	Bits	120
Number Code Blocks	Blocks	1
Binary Channel Bits Per TTI	Bits	960
Total Available SML's in UE	SML's	19200
Number of SML's per HARQ Proc.	SML's	3200
Coding Rate		0.15
Number of Physical Channel Codes	Codes	1
Modulation		QPSK
Note 1: The RMC is intended to be used for DC-HSDPA mode and both cells shall transmit with identical parameters as listed in the table. Note 2: Maximum number of transmission is limited to 1, i.e., retransmission is not allowed. The redundancy and constellation version 0 shall be used.		

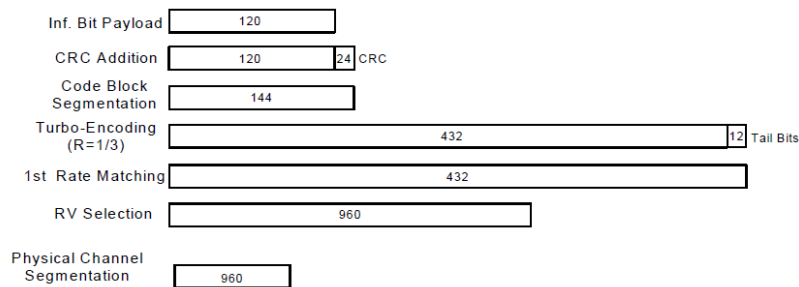

Figure C.8.19: Coding rate for Fixed reference Channel H-Set 12 (QPSK)

Setup Configuration



<WCDMA Conducted Power>

General Note:

1. Per KDB 941225 D01v03r01, for SAR testing is measured using a 12.2 kbps RMC with TPC bits configured to all "1's".
2. Per KDB 941225 D01v03r01, RMC 12.2kbps setting is used to evaluate SAR. The maximum output power and tune-up tolerance specified for production units in HSDPA / HSUPA / DC-HSDPA is $\leq \frac{1}{4}$ dB higher than RMC 12.2Kbps or when the highest reported SAR of the RMC12.2Kbps is scaled by the ratio of specified maximum output power and tune-up tolerance of HSDPA / HSUPA / DC-HSDPA to RMC12.2Kbps and the adjusted SAR is ≤ 1.2 W/kg, SAR measurement is not required for HSDPA / HSUPA / DC-HSDPA, and according to the following RF output power, the output power results of the secondary modes (HSDPA / HSUPA / DC-HSDPA) are less than $\frac{1}{4}$ dB higher than the primary modes; therefore, SAR measurement is not required for HSDPA / HSUPA / DC-HSDPA.

<LTE Conducted Power>

General Note:

1. Anritsu MT8820C base station simulator was used to setup the connection with EUT; the frequency band, channel bandwidth, RB allocation configuration, modulation type are set in the base station simulator to configure EUT transmitting at maximum power and at different configurations which are requested to be reported to FCC, for conducted power measurement and SAR testing.
2. Per KDB 941225 D05v02r05, when a properly configured base station simulator is used for the SAR and power measurements, spectrum plots for each RB allocation and offset configuration is not required.
3. Per KDB 941225 D05v02r05, start with the largest channel bandwidth and measure SAR for QPSK with 1 RB allocation, using the RB offset and required test channel combination with the highest maximum output power for RB offsets at the upper edge, middle and lower edge of each required test channel.
4. Per KDB 941225 D05v02r05, 50% RB allocation for QPSK SAR testing follows 1RB QPSK allocation procedure.
5. Per KDB 941225 D05v02r05, for QPSK with 100% RB allocation, SAR is not required when the highest maximum output power for 100 % RB allocation is less than the highest maximum output power in 50% and 1 RB allocations and the highest reported SAR for 1 RB and 50% RB allocation are ≤ 0.8 W/kg. Otherwise, SAR is measured for the highest output power channel; and if the reported SAR is > 1.45 W/kg, the remaining required test channels must also be tested.
6. Per KDB 941225 D05v02r05, 16QAM/64QAM output power for each RB allocation configuration is $>$ not $\frac{1}{2}$ dB higher than the same configuration in QPSK and the reported SAR for the QPSK configuration is ≤ 1.45 W/kg; Per KDB 941225 D05v02r05, 16QAM/64QAM SAR testing is not required.
7. Per KDB 941225 D05v02r05, smaller bandwidth output power for each RB allocation configuration is $>$ not $\frac{1}{2}$ dB higher than the same configuration in the largest supported bandwidth, and the reported SAR for the largest supported bandwidth is ≤ 1.45 W/kg; Per KDB 941225 D05v02r05, smaller bandwidth SAR testing is not required.
8. For LTE B4 / B5 / B12 / B17 / B26 / B38 the maximum bandwidth does not support three non-overlapping channels, per KDB 941225 D05v02r05, when a device supports overlapping channel assignment in a channel bandwidth configuration, the middle channel of the group of overlapping channels should be selected for testing.
9. LTE B5 / B17 / B38 SAR test was covered by B26 / B12 / B41; according to April 2015 TCB workshop, SAR test for overlapping LTE bands can be reduced if
 - a. the maximum output power, including tolerance, for the smaller band is \leq the larger band to qualify for the SAR test exclusion
 - b. the channel bandwidth and other operating parameters for the smaller band are fully supported by the larger band
10. According to 2017 TCB workshop, for 64 QAM and 16 QAM should be verified by checking the signal constellation with a call box to avoid incorrect maximum power levels due to MPR and other requirements associated with signal modulation, and the following figure is taken from the "Fundamental Measurement >> Modulation Analysis >> constellation" mode of the device connect to the MT8821C base station, therefore, the device 64QAM and 16QAM signal modulation are correct.

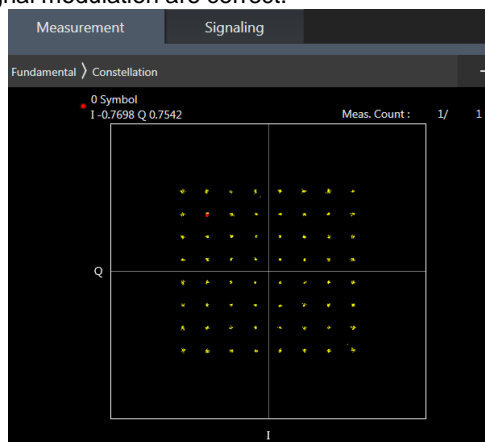

64QAM



16QAM

Special subframe (30720·T_s): Normal cyclic prefix in downlink (UpPTS)			
	Special subframe configuration	Normal cyclic prefix in uplink	Extended cyclic prefix in uplink
Uplink duty factor in one special subframe	0~4	7.13%	8.33%
	5~9	14.3%	16.7%

Special subframe(30720·T_s): Extended cyclic prefix in downlink (UpPTS)			
	Special subframe configuration	Normal cyclic prefix in uplink	Extended cyclic prefix in uplink
Uplink duty factor in one special subframe	0~3	7.13%	8.33%
	4~7	14.3%	16.7%

The highest duty factor is resulted from:

- i. Uplink-downlink configuration: 0. In a half-frame consisted of 5 subframes, uplink operation is in 3 uplink subframes and 1 special subframe.
- ii. special subframe configuration: 5-9 for normal cyclic prefix in downlink, 4-7 for extended cyclic prefix in downlink
- iii. for special subframe with extended cyclic prefix in uplink, the total uplink duty factor in one half-frame is: $(3+0.167)/5 = 63.3\%$
- iv. for special subframe with normal cyclic prefix in uplink, the total uplink duty factor in one half-frame is: $(3+0.143)/5 = 62.9\%$
- v. For TDD LTE SAR measurement, the duty cycle 1:1.59 (62.9 %) was used perform testing and considering the theoretical duty cycle of 63.3% for extended cyclic prefix in the uplink, and the theoretical duty cycle of 62.9% for normal cyclic prefix in uplink, a scaling factor of extended cyclic prefix $63.3\%/62.9\% = 1.006$ is applied to scale-up the measured SAR result. The scaled TDD LTE SAR = measured SAR (W/kg)* Tune-up Scaling Factor* scaling factor for extended cyclic prefix.



<LTE Carrier Aggregation>

General Note:

1. This device supports Carrier Aggregation on downlink for inter and intra band. For the device supports bands and bandwidths and configurations are provided as follow table was according to 3GPP.
2. In applying the existing power measurement procedures of KDB 941225 D05A for DL CA SAR test exclusion, only the subset with the largest number of combinations of frequency bands and CCs in each row need combination, and for this device that all the configurations were choose to power measurement.
3. The gray color table is covered by other combinations and no need to verify power.
4. All permutations exist. No restrictions on Pcell & Scell combinations.

2CC Downlink Carrier Aggregation			3CC Downlink Carrier Aggregation		
Number	Combination	Covered by Measurement Superset	Number	Combination	Covered by Measurement Superset
2CC #1	CA_2C		3CC #1	CA_2A-4A-5A	
2CC #2	CA_7C		3CC #2	CA_2A-4A-7A	
2CC #3	CA_38C		3CC #3	CA_2A-7A-7A	
2CC #4	CA_41C		3CC #4	CA_2A-4A-12A	
2CC #5	CA_2A-4A	3CC #1	3CC #5	CA_2A-7C	
2CC #6	CA_2A-5A	3CC #1	3CC #6	CA_41D	
2CC #7	CA_2A-7A	3CC #2	3CC #7	CA_41A-41A-41A	
2CC #8	CA_41A-41A	3CC #7	3CC #8	CA_4A-7C	
2CC #9	CA_4A-5A	3CC #1	3CC #9	CA_5A-7A-7A	
2CC #10	CA_4A-7A	3CC #2	3CC #10	CA_5A-7C	
2CC #11	CA_5A-41A		3CC #11		
2CC #12	CA_5A-7A	3CC #9	3CC #12		
2CC #13	CA_7A-26A		3CC #13		
2CC #14	CA_7A-7A	3CC #9	3CC #14		
2CC #15	CA_2A-12A	3CC #4	3CC #15		
2CC #16	CA_4A-12A	3CC #4	3CC #16		
2CC #17	CA_4A-17A		3CC #17		

LTE Carrier Aggregation Conducted Power (Downlink)

- i. According to KDB941225 D05A v01r02, Uplink maximum output power measurement with downlink carrier aggregation active should be measured, using the highest output channel measured without downlink carrier aggregation, to confirm that uplink maximum output power with downlink carrier aggregation active remains within the specified tune-up tolerance limits and not more than ¼ dB higher than the maximum output measured without downlink carrier aggregation active.
- ii. Uplink maximum output power with downlink carrier aggregation active does not show more than ¼ dB higher than the maximum output power without downlink carrier aggregation active, therefore SAR evaluation with downlink carrier aggregation active can be excluded.
- iii. The device supports downlink three carrier aggregation. For power measurement were control and acknowledge data is sent on uplink channels that operate identical to specifications when downlink carrier aggregation is inactive.
- iv. Selected highest measured power when downlink carrier aggregation is inactive for conducted power comparison with downlink carrier aggregation is active, to confirm that when downlink carrier aggregation is active uplink maximum output power remains within the specified tune-up tolerance limits and not more than ¼ dB higher than the maximum output power measured when downlink carrier aggregation inactive.
- v. For inter-band CA, the SCC selected highest bandwidth and near the middle of its transmission band. For SCC DL RB size and offset will base on the PCC corresponding RB allocation.
- vi. For non-contiguous intra-band CA, the SCC selected to provide maximum separation from the PCC and must remain fully within the downlink transmission band.
- vii. For Intra-band, contiguous CA, the downlink channels selected to perform the uplink power measurement must satisfy 3GPP channel spacing (5.4.1A of 3GPP TS 36.521 or equivalent) and channel bandwidth (5.4.2A) requirements.

$$\text{Nominal channel spacing} = \left\lceil \frac{BW_{\text{Channel}(1)} + BW_{\text{Channel}(2)} - 0.1|BW_{\text{Channel}(1)} - BW_{\text{Channel}(2)}|}{0.6} \right\rceil 0.3 \text{ [MHz]}$$

LTE 4x4 MIMO (Downlink)

This device supports downlink 4x4 MIMO operations for LTE Bands 4/7/38/41 only. Uplink transmission is limited to a single output stream. Power measurements were performed with downlink 4x4 MIMO active for the configuration with highest measured maximum conducted power with 4x4 downlink MIMO inactive measured among the channel bandwidth, modulation, and RB combinations in each frequency band.

Per FCC Guidance, SAR for downlink 4x4 MIMO was not needed since the maximum average output power in 4x4 downlink MIMO mode was not > 0.25 dB higher than the maximum output power with downlink 4x4 MIMO inactive. When carrier aggregation is applicable, power measurements were performed with the downlink carrier aggregation and 4x4 DL MIMO active for the configuration with highest measured maximum conducted power with downlink carrier aggregation inactive measured among the channel bandwidth, modulation, and RB combinations in each frequency band.

4X4 MIMO	WWAN Band
	LTE Band: B4/B7/B38/B41



LTE Carrier Aggregation Conducted Power (Uplink)

<Intra-band>

2CC Uplink Carrier Aggregation	
Number	Combination
1	7C
2	38C
3	41C

General Note:

- i. The device supports intra-band uplink carrier aggregation for LTE B7/B38/B41 with a maximum of two 20MHz component carriers. For intra band contiguous carrier aggregation scenarios, 3GPP 36.101 table 6.2.2A-1 specifies that the aggregate maximum allowed output power is equivalent to the single carrier scenario. 3GPP 36.101 6.2.3A allows for several dB of MPR to be applied when not-contiguous RB allocation is implemented. The conducted power and MPR setting in this device are permanently implemented pre 3GPP requirement.
- ii. The device supports uplink carrier aggregation with a maximum of two 20MHz component carriers. For intra band contiguous carrier aggregation scenarios, 3GPP 36.101 table 6.2.2A-1 specifies that the aggregate maximum allowed output power is equivalent to the single carrier scenario. 3GPP 36.101 6.2.3A allows for several dB of MPR to be applied when not-contiguous RB allocation is implemented. The conducted power and MPR setting in this device are permanently implemented pre the 3GPP requirement.
- iii. According TCB workshop, the output power with uplink CA active was measured for the configuration with the highest reported SAR with single carrier for each exposure condition. The power was measured with wideband signal integration over both component carriers.
- iv. According TCB workshop, the output power with uplink CA active was measured for the configuration with the highest reported SAR with single carrier for each exposure condition. The power was measured with wideband signal integration over both component carriers.
- v. Additional SAR measurement for LTE UL CA whit other DL CA combinations active were not required since the maximum output power for this configuration was not > 0.25dB higher than the maximum output power for UL CA active.

<Inter-band uplink carrier aggregation consideration>

LTE Uplink CA	2CC Uplink Carrier Aggregation	
Combination	Band&Ant No.	Band&Ant No.
4A-7A	LTE B4: Ant0/Ant4	LTE B7: Ant0/Ant4

General Note:

The single carrier of inter band CA uplink power level is the same as Non-CA standalone LTE power level. For Inter-band CA co-located SAR analysis is performed using standalone SAR summed together and they are more conservatively for inter band CA.

5G NR Output Power (Unit: dBm)

General Note:

1. 5G NR n5, n7, n38, n41, n77, n78 supports SA operation.
2. 5G NR n5, n7, n77, n78 supports NSA.
3. For 5G NR test procedure was following step similar FCC KDB 941225 D05:
 - a. For DFT-OFDM and CP-OFDM output power measurement reduction, according to 38.101 maximum power reduction for power class2 and 3, the CP-OFDM mode will not higher than DFT-OFDM mode, therefore, similar FCC KDB 941225 D05 procedure for other modulation output power for each RB allocation configuration is > not ½ dB higher than the same configuration in DFT-QPSK and the reported SAR for the DFT-QPSK configuration is ≤ 1.45 W/kg; CP-OFDM testing is not required.
 - b. For DFT-OFDM output power measurement reduction, according to 38.101 maximum power reduction for power class2 and 3, for 16QAM/64QAM/256QAM and smaller bandwidth output power will spot check largest channel bandwidth worst RB configuration to ensure the 16QAM/64QAM/256QAM and smaller bandwidth output power will not ½ dB higher than the same configuration in the largest supported bandwidth.
 - c. SAR testing start with the largest channel bandwidth and measure SAR for QPSK with 1 RB allocation, using the RB offset and required test channel combination with the highest maximum output power for RB offsets at the upper edge, middle and lower edge of each required test channel
 - d. 50% RB allocation for QPSK SAR testing follows 1RB QPSK allocation procedure
 - e. QPSK with 100% RB allocation, SAR is not required when the highest maximum output power for 100 % RB allocation is less than the highest maximum output power in 50% and 1 RB allocations and the highest reported SAR for 1 RB and 50% RB allocation are ≤ 0.8 W/kg. Otherwise, SAR is measured for the highest output power channel; and if the reported SAR is > 1.45 W/kg, the remaining required test channels must also be tested
 - f. PI/2 BPSK/16QAM/64QAM/256QAM output powers according to 3GPP MPR will not ½ dB higher than the same configuration in QPSK, also reported SAR for the QPSK configuration is less than 1.45 W/kg, PI/2 BPSK /16QAM/64QAM/256QAM AM SAR testing are not required.
 - g. Smaller bandwidth output power for each RB allocation configuration for this device will not ½ dB higher than the same configuration in the largest supported bandwidth, and the reported SAR for the largest supported bandwidth is ≤ 1.45 W/kg, smaller bandwidth SAR testing is not required for this device
4. Due to test setup limitations, SAR testing for NR was performed using Factory Test Mode software to establish the connection and perform SAR with 100% transmission.
5. For DFT-s-OFDM and CP-OFDM output power measurement reduction, according to 38.101 maximum power reduction for the CP-OFDM mode will not higher than DFT-s-OFDM mode, therefore, CP-OFDM measurement is unnecessary.
6. NSA and SA mode should perform SAR separately. For the maximum power of NSA mode is the same as SA total power level, so SA SAR can represent NSA mode SAR.
7. 5G NR NSA mode, the power level is the same as 5G NR SA mode, so 5G NR NSA mode and SA mode power table only show one time.
8. 5G NR supports CP-OFDM and DFT-s-OFDM modulation, for DFT-s-OFDM power is higher than CP-OFDM, so only show DFT-s-OFDM power table and chose DFT-s-OFDM to perform SAR testing.
9. For DFT-s-OFDM and CP-OFDM output power measurement reduction, according to 38.101 maximum power reduction for the CP-OFDM mode will not higher than DFT-s-OFDM mode, therefore, CP-OFDM measurement is unnecessary.
10. 5G NR n41/n77/n78 supports HPUE, HPUE power and SAR testing performed separately.
11. 5G NR n41/n77/n78 HPUE with higher power, n41/n77/n78 HPUE SAR can represent power class 3 level SAR.
12. For 5G NR EN-DC mode, standalone SAR performed for 5G NR band with the maximum power, EN-DC SAR summed 5G NR standalone SAR and LTE standalone SAR, the result of EN-DC SAR is more conservatively.

<3GPP 38.101 MPR for EN-DC>

Table 6.2.2-1 Maximum power reduction (MPR) for power class 3

Modulation		MPR (dB)		
		Edge RB allocations	Outer RB allocations	Inner RB allocations
DFT-s-OFDM	Pi/2 BPSK	$\leq 3.5^1$	$\leq 1.2^1$	$\leq 0.2^1$
		$\leq 0.5^2$	$\leq 0.5^2$	0 ²
	QPSK		≤ 1	0
	16 QAM		≤ 2	≤ 1
	64 QAM			
CP-OFDM	256 QAM		≤ 2.5	
	QPSK		≤ 4.5	
	16 QAM	≤ 3		≤ 1.5
	64 QAM	≤ 3		≤ 2
	256 QAM		≤ 3.5	
			≤ 6.5	

NOTE 1: Applicable for UE operating in TDD mode with Pi/2 BPSK modulation and UE indicates support for UE capability *powerBoosting-pi2BPSK* and if the IE *powerBoostPi2BPSK* is set to 1 and 40 % or less slots in radio frame are used for UL transmission for bands n40, n41, n77, n78 and n79. The reference power of 0 dB MPR is 26 dBm.

NOTE 2: Applicable for UE operating in FDD mode, or in TDD mode in bands other than n40, n41, n77, n78 and n79 with Pi/2 BPSK modulation and if the IE *powerBoostPi2BPSK* is set to 0 and if more than 40 % of slots in radio frame are used for UL transmission for bands n40, n41, n77, n78 and n79.

Table 6.2.2-2 Maximum power reduction (MPR) for power class 2

Modulation		MPR (dB)		
		Edge RB allocations	Outer RB allocations	Inner RB allocations
DFT-s-OFDM	Pi/2 BPSK	≤ 3.5	≤ 0.5	0
	QPSK	≤ 3.5	≤ 1	0
	16 QAM	≤ 3.5	≤ 2	≤ 1
	64 QAM	≤ 3.5		≤ 2.5
	256 QAM		≤ 4.5	
CP-OFDM	QPSK	≤ 3.5	≤ 3	≤ 1.5
	16 QAM	≤ 3.5	≤ 3	≤ 2
	64 QAM		≤ 3.5	
	256 QAM		≤ 6.5	

ENDC List	LTE Ant No.	NR Ant No.
DC_7A_n5A	Ant0&4	Ant4&0
DC_5A_n7A	Ant0&4	Ant4&0
DC_2A_n77A	Ant0&4	Ant3&5
DC_2A_n78A	Ant0&4	Ant3&5
DC_5A_n78A	Ant0&4	Ant3&5
DC_7A_n78A	Ant0&4	Ant3&5
DC_38A_n78A	Ant0&4	Ant3&5
DC_41A_n78A	Ant0&4	Ant3&5



<WLAN Conducted Power>

General Note:

1. Per KDB 248227 D01v02r02, SAR test reduction is determined according to 802.11 transmission mode configurations and certain exposure conditions with multiple test positions. In the 2.4 GHz band, separate SAR procedures are applied to DSSS and OFDM configurations to simplify DSSS test requirements. For OFDM, in both 2.4 and 5 GHz bands, an initial test configuration must be determined for each standalone and aggregated frequency band, according to the transmission mode configuration with the highest maximum output power specified for production units to perform SAR measurements. If the same highest maximum output power applies to different combinations of channel bandwidths, modulations and data rates, additional procedures are applied to determine which test configurations require SAR measurement. When applicable, an initial test position may be applied to reduce the number of SAR measurements required for next to the ear, UMPC mini-tablet or hotspot mode configurations with multiple test positions.
2. For 2.4 GHz 802.11b DSSS, either the initial test position procedure for multiple exposure test positions or the DSSS procedure for fixed exposure position is applied; these are mutually exclusive. For 2.4 GHz and 5 GHz OFDM configurations, the initial test configuration is applied to measure SAR using either the initial test position procedure for multiple exposure test position configurations or the initial test configuration procedures for fixed exposure test conditions. Based on the reported SAR of the measured configurations and maximum output power of the transmission mode configurations that are not included in the initial test configuration, the subsequent test configuration and initial test position procedures are applied to determine if SAR measurements are required for the remaining OFDM transmission configurations. In general, the number of test channels that require SAR measurement is minimized based on maximum output power measured for the test sample(s).
3. For OFDM transmission configurations in the 2.4 GHz and 5 GHz bands, When the same maximum power is specified for multiple transmission modes in a frequency band, the largest channel bandwidth, lowest order modulation, lowest data rate and lowest order 802.11a/g/n/ac mode is used for SAR measurement, on the highest measured output power channel for each frequency band.
4. DSSS and OFDM configurations are considered separately according to the required SAR procedures. SAR is measured in the initial test position using the 802.11 transmission mode configuration required by the DSSS procedure or initial test configuration and subsequent test configuration(s) according to the OFDM procedures.18 The initial test position procedure is described in the following:
 - a. When the reported SAR of the initial test position is ≤ 0.4 W/kg, further SAR measurement is not required for the other test positions in that exposure configuration and 802.11 transmission mode combinations within the frequency band or aggregated band.
 - b. When the reported SAR of the test position is > 0.4 W/kg, SAR is repeated for the 802.11 transmission mode configuration tested in the initial test position to measure the subsequent next closet/smallest test separation distance and maximum coupling test position on the highest maximum output power channel, until the report SAR is ≤ 0.8 W/kg or all required test position are tested.
 - c. For all positions/configurations, when the reported SAR is > 0.8 W/kg, SAR is measured for these test positions/configurations on the subsequent next highest measured output power channel(s) until the reported SAR is ≤ 1.2 W/kg or all required channels are tested.



<2.4GHz Bluetooth>

General Note:

1. For 2.4GHz Bluetooth SAR testing was selected 1Mbps, due to its highest average power.
2. The Bluetooth duty cycle is 77.38 % as following figure, according to 2016 Oct. TCB workshop for Bluetooth SAR scaling need further consideration and the maximum duty cycle is 100%, therefore the actual duty cycle will be scaled up to 100% for Bluetooth reported SAR calculation

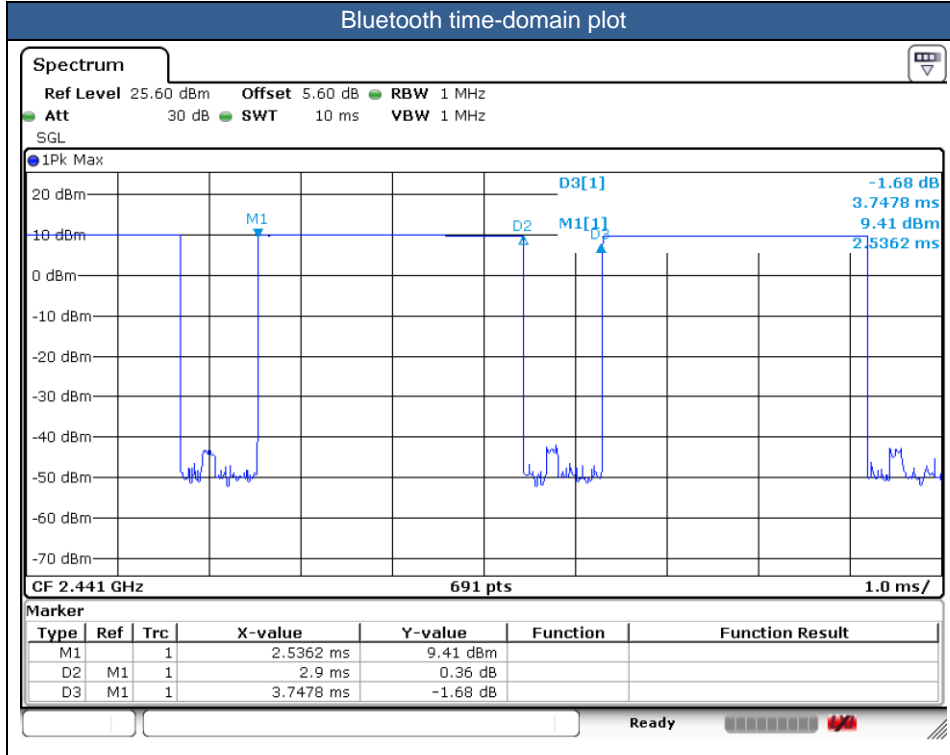



14. Antenna Location

The detailed antenna location information can refer to SAR Test Setup Photos.

15. SAR Test Results

General Note:

1. Per KDB 447498 D01v06, the reported SAR is the measured SAR value adjusted for maximum tune-up tolerance.
 - a. Tune-up scaling Factor = tune-up limit power (mW) / EUT RF power (mW), where tune-up limit is the maximum rated power among all production units.
 - b. For SAR testing of BT/WLAN signal with non-100% duty cycle, the measured SAR is scaled-up by the duty cycle scaling factor which is equal to "1/(duty cycle)"
 - c. For WWAN: Reported SAR(W/kg)= Measured SAR(W/kg)*Tune-up Scaling Factor
 - d. For BT/WLAN: Reported SAR(W/kg)= Measured SAR(W/kg)* Duty Cycle scaling factor * Tune-up scaling factor
 - e. For TDD LTE SAR measurement, the duty cycle 1:1.59 (62.9 %) was used perform testing and considering the theoretical duty cycle of 63.3% for extended cyclic prefix in the uplink, and the theoretical duty cycle of 62.9% for normal cyclic prefix in uplink, a scaling factor of extended cyclic prefix $63.3\%/62.9\% = 1.006$ is applied to scale-up the measured SAR result. The Reported TDD LTE SAR = measured SAR (W/kg)* Tune-up Scaling Factor* scaling factor for extended cyclic prefix.
2. Per KDB 447498 D01v06, for each exposure position, testing of other required channels within the operating mode of a frequency band is not required when the *reported* 1-g or 10-g SAR for the mid-band or highest output power channel is:
 - ≤ 0.8 W/kg or 2.0 W/kg, for 1-g or 10-g respectively, when the transmission band is ≤ 100 MHz
 - ≤ 0.6 W/kg or 1.5 W/kg, for 1-g or 10-g respectively, when the transmission band is between 100 MHz and 200 MHz
 - ≤ 0.4 W/kg or 1.0 W/kg, for 1-g or 10-g respectively, when the transmission band is ≥ 200 MHz
3. Per KDB 865664 D01v01r04, for each frequency band, repeated SAR measurement is required when the measured SAR is ≥ 0.8 W/kg. Per KDB 865664 D01v01r04, if the extremity repeated SAR is necessary, the same procedures should be adapted for measurements according to extremity and occupational exposure limits by applying a factor of 2.5 for extremity exposure and a factor of 5 for occupational exposure to the corresponding SAR thresholds.
4. For dual SIM card mobile has two SIM slots and supports dual SIM dual standby. The WWAN radio transmission will be enabled by either one SIM at a time (single active). After pre-scan two SIM cards power, we found test result of the SIM1 was the worse, so we chose SIM1 slot to perform all tests.
5. The device implements Proximity sensors/receiver detect mechanism/hotspot trigger reduced power for the power management for SAR compliance at different exposure conditions (head, body-worn, hotspot, extremity). The device will invoke corresponding work scenarios power level base on frequency bands/antennas, which can refer to appendix E. power table. Full power table and reduced power table (DSI 1: receiver on reduced power for head; DSI 4: P-sensor on for hotspot/ handheld; DSI 2: P-sensor off).
6. For 5G NR test, using FTM (Factory Test Mode) to perform SAR with default 100% transmission.
7. 5G NR n41/n77/n78 supports HPUE, HPUE power and SAR testing performed separately.
8. 5G NR n41/n77/n78 HPUE with higher power, n41/n77/n78 HPUE SAR can represent power class 3 level SAR.
9. For 5G NR EN-DC mode, standalone SAR performed for 5G NR band with the maximum power, EN-DC SAR summed 5G NR standalone SAR and LTE standalone SAR, the result of EN-DC SAR is more conservatively.
10. NSA and SA mode should perform SAR separately. For the maximum power of NSA mode is the same as SA total power level, so SA SAR can represent NSA mode SAR.
11. 5G NR NSA mode, the power level is the same as 5G NR SA mode, so 5G NR NSA mode and SA mode power table only show one time.
12. 5G NR supports CP-OFDM and DFT-s-OFDM modulation, for DFT-s-OFDM power is higher than CP-OFDM, so only show DFT-s-OFDM power table and chose DFT-s-OFDM to perform SAR testing.
13. For DFT-s-OFDM and CP-OFDM output power measurement reduction, according to 38.101 maximum power reduction for the CP-OFDM mode will not higher than DFT-s-OFDM mode, therefore, CP-OFDM measurement is unnecessary.
14. Per KDB648474 D04v01r03, for smart phones with a display diagonal dimension > 15.0 cm or an overall diagonal dimension > 16.0 cm, when hotspot mode applies, 10-g extremity SAR is required only for the surfaces and edges with hotspot mode 1-g reported SAR > 1.2 W/kg, however, when power reduction applies to hotspot mode the measured SAR must be scaled to the maximum output power, including tolerance, allowed for phablet modes to compare with the 1.2 W/kg SAR test reduction threshold,
 - a. WLAN 5.3/5.5GHz tested the product specific 10g SAR since it has no hotspot mode.
 - b. When 10-g product specific 10g SAR is considered, SAR thresholds is specified in the procedures for SAR test reduction and exclusion should be multiplied by 2.5.
15. For different distance SAR always chose higher SAR at the same position to do co-located analysis.

GSM Note:

1. Per KDB 941225 D01v03r01, for SAR test reduction for GSM / GPRS / EDGE modes is determined by the source-based time-averaged output power including tune-up tolerance. The mode with highest specified time-averaged output power should be tested for SAR compliance in the applicable exposure conditions. For modes with the same specified maximum output power and tolerance, the higher number time-slot configuration should be tested.
2. Other configurations of GSM / GPRS / EDGE are considered as secondary modes. The 3G SAR test reduction procedure is applied, when the maximum output power and tune-up tolerance specified for production units in a secondary mode is \leq ¼ dB higher than the primary mode, SAR measurement is not required for the secondary mode.

WCDMA Note:

1. Per KDB 941225 D01v03r01, for SAR testing is measured using a 12.2 kbps RMC with TPC bits configured to all "1's".
2. Per KDB 941225 D01v03r01, RMC 12.2kbps setting is used to evaluate SAR. The maximum output power and tune-up tolerance specified for production units in HSDPA / HSUPA / DC-HSDPA is \leq ¼ dB higher than RMC 12.2Kbps or when the highest reported SAR of the RMC12.2Kbps is scaled by the ratio of specified maximum output power and tune-up tolerance of HSDPA / HSUPA / DC-HSDPA to RMC12.2Kbps and the adjusted SAR is \leq 1.2 W/kg, SAR measurement is not required for HSDPA / HSUPA / DC-HSDPA, and according to the following RF output power, the output power results of the secondary modes (HSDPA / HSUPA / DC-HSDPA) are less than ¼ dB higher than the primary modes; therefore, SAR measurement is not required for HSDPA / HSUPA / DC-HSDPA.

LTE Note:

1. Per KDB 941225 D05v02r05, start with the largest channel bandwidth and measure SAR for QPSK with 1 RB allocation, using the RB offset and required test channel combination with the highest maximum output power for RB offsets at the upper edge, middle and lower edge of each required test channel.
2. Per KDB 941225 D05v02r05, 50% RB allocation for QPSK SAR testing follows 1RB QPSK allocation procedure.
3. Per KDB 941225 D05v02r05, for QPSK with 100% RB allocation, SAR is not required when the highest maximum output power for 100 % RB allocation is less than the highest maximum output power in 50% and 1 RB allocations and the highest reported SAR for 1 RB and 50% RB allocation are \leq 0.8 W/kg. Otherwise, SAR is measured for the highest output power channel; and if the reported SAR is $>$ 1.45 W/kg, the remaining required test channels must also be tested.
4. Per KDB 941225 D05v02r05, 16QAM/64QAM output power for each RB allocation configuration is $>$ not ½ dB higher than the same configuration in QPSK and the reported SAR for the QPSK configuration is \leq 1.45 W/kg; Per KDB 941225 D05v02r05, 16QAM/64QAM SAR testing is not required.
5. Per KDB 941225 D05v02r05, smaller bandwidth output power for each RB allocation configuration is $>$ not ½ dB higher than the same configuration in the largest supported bandwidth, and the reported SAR for the largest supported bandwidth is \leq 1.45 W/kg; Per KDB 941225 D05v02r05, smaller bandwidth SAR testing is not required.
6. For LTE B4 / B5 / B12 / B17 / B26/ B38 the maximum bandwidth does not support three non-overlapping channels, per KDB 941225 D05v02r05, when a device supports overlapping channel assignment in a channel bandwidth configuration, the middle channel of the group of overlapping channels should be selected for testing.
7. LTE B5 / B17 / B38 SAR test was covered by B26 / B12 / B41; according to April 2015 TCB workshop, SAR test for overlapping LTE bands can be reduced if
 - a. the maximum output power, including tolerance, for the smaller band is \leq the larger band to qualify for the SAR test exclusion
 - b. the channel bandwidth and other operating parameters for the smaller band are fully supported by the larger band

5G NR Note:

1. For 5G NR test procedure was following step similar FCC KDB 941225 D05:
 - a. SAR testing start with the largest channel bandwidth and measure SAR for QPSK with 1 RB allocation, using the RB offset and required test channel combination with the highest maximum output power for RB offsets at the upper edge, middle and lower edge of each required test channel.
 - b. 50% RB allocation for QPSK SAR testing follows 1RB QPSK allocation procedure
 - c. QPSK with 100% RB allocation, SAR is not required when the highest maximum output power for 100 % RB allocation is less than the highest maximum output power in 50% and 1 RB allocations and the highest reported SAR for 1 RB and 50% RB allocation are ≤ 0.8 W/kg. Otherwise, SAR is measured for the highest output power channel; and if the reported SAR is > 1.45 W/kg, the remaining required test channels must also be tested.
 - d. PI/2 BPSK/16QAM/64QAM/256QAM output powers according to 3GPP MPR will not $\frac{1}{2}$ dB higher than the same configuration in QPSK, also reported SAR for the QPSK configuration is less than 1.45 W/kg, PI/2 BPSK/16QAM /64QAM/256QAM SAR testing are not required.
 - e. Smaller bandwidth output power for each RB allocation configuration for this device will not $\frac{1}{2}$ dB higher than the same configuration in the largest supported bandwidth, and the reported SAR for the largest supported bandwidth is ≤ 1.45 W/kg, smaller bandwidth SAR testing is not required for this device.
 - f. For 5G FR1 n38/n41/n77/n78 the maximum bandwidth does not support three non-overlapping channels, when a device supports overlapping channel assignment in a channel bandwidth configuration, the middle channel of the group of overlapping channels should be selected for testing.

WLAN Note:

1. Per KDB 248227 D01v02r02, for 2.4GHz 802.11g/n SAR testing is not required when the highest reported SAR for DSSS is adjusted by the ratio of OFDM to DSSS specified maximum output power and the adjusted SAR is ≤ 1.2 W/kg.
2. Per KDB 248227 D01v02r02, U-NII-1 SAR testing is not required when the U-NII-2A band highest reported SAR for a test configuration is ≤ 1.2 W/kg, SAR is not required for U-NII-1 band.
3. When the reported SAR of the test position is > 0.4 W/kg, SAR is repeated for the 802.11 transmission mode configuration tested in the initial test position to measure the subsequent next closet/smallest test separation distance and maximum coupling test position on the highest maximum output power channel, until the report SAR is ≤ 0.8 W/kg or all required test position are tested.
4. For all positions / configurations, when the reported SAR is > 0.8 W/kg, SAR is measured for these test positions / configurations on the subsequent next highest measured output power channel(s) until the reported SAR is ≤ 1.2 W/kg or all required channels are tested.
5. During SAR testing the WLAN transmission was verified using a spectrum analyzer.
6. Based on WLAN 2.4GHz and Bluetooth share the same, so Bluetooth RF exposure evaluation chose the worst position of WLAN 2.4GHz to perform Bluetooth SAR test, and used this Bluetooth SAR value conservatively represent other position do co-located analysis with WWAN.



15.1 Head SAR

Plot No.	Band	BW (MHz)	Modulation	RB Size	RB offset	Mode	Test Position	Gap (mm)	Antenna	Power State	Ch.	Freq. (MHz)	Average Power (dBm)	Tune-Up Limit (dBm)	Tune-up Scaling Factor	Power Drift (dB)	Measured 1g SAR (W/kg)	Reported 1g SAR (W/kg)	
750MHz																			
	LTE Band 12	10M	QPSK	1	0	-	Right Cheek	0mm	Ant0	DSI 1	23095	707.5	24.69	25.50	1.205	-0.05	0.099	0.119	
	LTE Band 12	10M	QPSK	25	0	-	Right Cheek	0mm	Ant0	DSI 1	23095	707.5	23.89	24.50	1.151	0.02	0.081	0.093	
	LTE Band 12	10M	QPSK	1	0	-	Right Tilted	0mm	Ant0	DSI 1	23095	707.5	24.69	25.50	1.205	0.03	0.065	0.078	
	LTE Band 12	10M	QPSK	25	0	-	Right Tilted	0mm	Ant0	DSI 1	23095	707.5	23.89	24.50	1.151	0.09	0.051	0.059	
	LTE Band 12	10M	QPSK	1	0	-	Left Cheek	0mm	Ant0	DSI 1	23095	707.5	24.69	25.50	1.205	-0.18	0.094	0.113	
	LTE Band 12	10M	QPSK	25	0	-	Left Cheek	0mm	Ant0	DSI 1	23095	707.5	23.89	24.50	1.151	-0.14	0.077	0.089	
	LTE Band 12	10M	QPSK	1	0	-	Left Tilted	0mm	Ant0	DSI 1	23095	707.5	24.69	25.50	1.205	-0.02	0.056	0.067	
	LTE Band 12	10M	QPSK	25	0	-	Left Tilted	0mm	Ant0	DSI 1	23095	707.5	23.89	24.50	1.151	0.01	0.045	0.052	
01	LTE Band 12	10M	QPSK	1	0	-	Right Cheek	0mm	Ant4	DSI 1	23095	707.5	24.76	25.50	1.186	-0.07	0.379	0.449	
	LTE Band 12	10M	QPSK	25	0	-	Right Cheek	0mm	Ant4	DSI 1	23095	707.5	23.78	24.50	1.180	0.14	0.309	0.365	
	LTE Band 12	10M	QPSK	1	0	-	Right Tilted	0mm	Ant4	DSI 1	23095	707.5	24.76	25.50	1.186	-0.16	0.301	0.357	
	LTE Band 12	10M	QPSK	25	0	-	Right Tilted	0mm	Ant4	DSI 1	23095	707.5	23.78	24.50	1.180	0.14	0.249	0.294	
	LTE Band 12	10M	QPSK	1	0	-	Left Cheek	0mm	Ant4	DSI 1	23095	707.5	24.76	25.50	1.186	-0.06	0.318	0.377	
	LTE Band 12	10M	QPSK	25	0	-	Left Cheek	0mm	Ant4	DSI 1	23095	707.5	23.78	24.50	1.180	-0.03	0.263	0.310	
	LTE Band 12	10M	QPSK	1	0	-	Left Tilted	0mm	Ant4	DSI 1	23095	707.5	24.76	25.50	1.186	-0.04	0.292	0.346	
	LTE Band 12	10M	QPSK	25	0	-	Left Tilted	0mm	Ant4	DSI 1	23095	707.5	23.78	24.50	1.180	-0.08	0.234	0.276	
835MHz																			
	GSM850	-	-	-	-	GPRS (4 Tx slots)	Right Cheek	0mm	Ant0	DSI 1	189	836.4	26.32	27.50	1.312	0.02	0.213	0.279	
	GSM850	-	-	-	-	GPRS (4 Tx slots)	Right Tilted	0mm	Ant0	DSI 1	189	836.4	26.32	27.50	1.312	-0.02	0.113	0.148	
	GSM850	-	-	-	-	GPRS (4 Tx slots)	Left Cheek	0mm	Ant0	DSI 1	189	836.4	26.32	27.50	1.312	-0.07	0.223	0.293	
	GSM850	-	-	-	-	GPRS (4 Tx slots)	Left Tilted	0mm	Ant0	DSI 1	189	836.4	26.32	27.50	1.312	0.05	0.127	0.167	
02	GSM850	-	-	-	-	GPRS (4 Tx slots)	Right Cheek	0mm	Ant4	DSI 1	189	836.4	26.54	27.50	1.247	-0.05	0.737	0.919	
	GSM850	-	-	-	-	GPRS (4 Tx slots)	Right Cheek	0mm	Ant4	DSI 1	128	824.2	26.48	27.50	1.265	0.18	0.546	0.691	
	GSM850	-	-	-	-	GPRS (4 Tx slots)	Right Cheek	0mm	Ant4	DSI 1	251	848.8	26.45	27.50	1.274	0.08	0.621	0.791	
	GSM850	-	-	-	-	GPRS (4 Tx slots)	Right Tilted	0mm	Ant4	DSI 1	189	836.4	26.54	27.50	1.247	-0.12	0.453	0.565	
	GSM850	-	-	-	-	GPRS (4 Tx slots)	Left Cheek	0mm	Ant4	DSI 1	189	836.4	26.54	27.50	1.247	0.05	0.690	0.861	
	GSM850	-	-	-	-	GPRS (4 Tx slots)	Left Cheek	0mm	Ant4	DSI 1	128	824.2	26.48	27.50	1.265	-0.09	0.538	0.680	
	GSM850	-	-	-	-	GPRS (4 Tx slots)	Left Cheek	0mm	Ant4	DSI 1	251	848.8	26.45	27.50	1.274	-0.08	0.581	0.740	
	GSM850	-	-	-	-	GPRS (4 Tx slots)	Left Tilted	0mm	Ant4	DSI 1	189	836.4	26.54	27.50	1.247	0.01	0.643	0.802	
	GSM850	-	-	-	-	GPRS (4 Tx slots)	Left Tilted	0mm	Ant4	DSI 1	128	824.2	26.48	27.50	1.265	0.08	0.486	0.615	
	GSM850	-	-	-	-	GPRS (4 Tx slots)	Left Tilted	0mm	Ant4	DSI 1	251	848.8	26.45	27.50	1.274	-0.17	0.541	0.689	
	WCDMA V	-	-	-	-	RMC 12.2Kbps	Right Cheek	0mm	Ant0	DSI 1	4182	836.4	24.78	25.50	1.180	-0.01	0.260	0.307	
	WCDMA V	-	-	-	-	RMC 12.2Kbps	Right Tilted	0mm	Ant0	DSI 1	4182	836.4	24.78	25.50	1.180	0.03	0.137	0.162	
	WCDMA V	-	-	-	-	RMC 12.2Kbps	Left Cheek	0mm	Ant0	DSI 1	4182	836.4	24.78	25.50	1.180	0.06	0.240	0.283	
	WCDMA V	-	-	-	-	RMC 12.2Kbps	Left Tilted	0mm	Ant0	DSI 1	4182	836.4	24.78	25.50	1.180	0.06	0.112	0.132	
03	WCDMA V	-	-	-	-	RMC 12.2Kbps	Right Cheek	0mm	Ant4	DSI 1	4182	836.4	23.62	24.50	1.225	0.01	0.868	1.063	
	WCDMA V	-	-	-	-	RMC 12.2Kbps	Right Cheek	0mm	Ant4	DSI 1	4132	826.4	23.56	24.50	1.242	0.05	0.832	1.033	
	WCDMA V	-	-	-	-	RMC 12.2Kbps	Right Cheek	0mm	Ant4	DSI 1	4233	846.6	23.48	24.50	1.265	0.06	0.831	1.051	
	WCDMA V	-	-	-	-	RMC 12.2Kbps	Right Tilted	0mm	Ant4	DSI 1	4182	836.4	23.62	24.50	1.225	0.18	0.703	0.861	
	WCDMA V	-	-	-	-	RMC 12.2Kbps	Right Tilted	0mm	Ant4	DSI 1	4132	826.4	23.56	24.50	1.242	-0.12	0.654	0.812	
	WCDMA V	-	-	-	-	RMC 12.2Kbps	Right Tilted	0mm	Ant4	DSI 1	4233	846.6	23.48	24.50	1.265	0.05	0.708	0.895	
	WCDMA V	-	-	-	-	RMC 12.2Kbps	Left Cheek	0mm	Ant4	DSI 1	4182	836.4	23.62	24.50	1.225	0.02	0.752	0.921	
	WCDMA V	-	-	-	-	RMC 12.2Kbps	Left Cheek	0mm	Ant4	DSI 1	4132	826.4	23.56	24.50	1.242	-0.18	0.716	0.889	
	WCDMA V	-	-	-	-	RMC 12.2Kbps	Left Cheek	0mm	Ant4	DSI 1	4233	846.6	23.48	24.50	1.265	0.03	0.738	0.933	
	WCDMA V	-	-	-	-	RMC 12.2Kbps	Left Tilted	0mm	Ant4	DSI 1	4182	836.4	23.62	24.50	1.225	-0.18	0.685	0.839	
	WCDMA V	-	-	-	-	RMC 12.2Kbps	Left Tilted	0mm	Ant4	DSI 1	4132	826.4	23.56	24.50	1.242	0.03	0.652	0.810	
	WCDMA V	-	-	-	-	RMC 12.2Kbps	Left Tilted	0mm	Ant4	DSI 1	4233	846.6	23.48	24.50	1.265	0.04	0.672	0.850	
	LTE Band 26	15M	QPSK	1	0	-	Right Cheek	0mm	Ant0	DSI 1	26865	831.5	24.44	25.50	1.276	0.14	0.165	0.211	
	LTE Band 26	15M	QPSK	36	0	-	Right Cheek	0mm	Ant0	DSI 1	26865	831.5	23.50	24.50	1.259	0.02	0.136	0.171	
	LTE Band 26	15M	QPSK	1	0	-	Right Tilted	0mm	Ant0	DSI 1	26865	831.5	24.44	25.50	1.276	0.18	0.093	0.119	



FCC SAR Test Report

Report No. : FA1N1013-01

	LTE Band 26	15M	QPSK	36	0	-	Right Tilted	0mm	Ant0	DSI 1	26865	831.5	23.50	24.50	1.259	-0.08	0.075	0.094
	LTE Band 26	15M	QPSK	1	0	-	Left Cheek	0mm	Ant0	DSI 1	26865	831.5	24.44	25.50	1.276	0.07	0.146	0.186
	LTE Band 26	15M	QPSK	36	0	-	Left Cheek	0mm	Ant0	DSI 1	26865	831.5	23.50	24.50	1.259	0.16	0.119	0.150
	LTE Band 26	15M	QPSK	1	0	-	Left Tilted	0mm	Ant0	DSI 1	26865	831.5	24.44	25.50	1.276	0.05	0.077	0.098
	LTE Band 26	15M	QPSK	36	0	-	Left Tilted	0mm	Ant0	DSI 1	26865	831.5	23.50	24.50	1.259	0.02	0.063	0.079
04	LTE Band 26	15M	QPSK	1	0	-	Right Cheek	0mm	Ant4	DSI 1	26865	831.5	24.48	25.50	1.265	-0.15	0.727	0.919
	LTE Band 26-ENDC	15M	QPSK	1	0	-	Right Cheek	0mm	Ant4	DSI 1	26865	831.5	21.59	22.50	1.233	-0.15	0.202	0.249
	LTE Band 26	15M	QPSK	36	0	-	Right Cheek	0mm	Ant4	DSI 1	26865	831.5	23.54	24.50	1.247	0.08	0.590	0.736
	LTE Band 26	15M	QPSK	75	0	-	Right Cheek	0mm	Ant4	DSI 1	26865	831.5	23.49	24.50	1.262	0.17	0.580	0.732
	LTE Band 26	15M	QPSK	1	0	-	Right Tilted	0mm	Ant4	DSI 1	26865	831.5	24.48	25.50	1.265	0.02	0.526	0.665
	LTE Band 26	15M	QPSK	36	0	-	Right Tilted	0mm	Ant4	DSI 1	26865	831.5	23.54	24.50	1.247	0.07	0.425	0.530
	LTE Band 26	15M	QPSK	1	0	-	Left Cheek	0mm	Ant4	DSI 1	26865	831.5	24.48	25.50	1.265	0.09	0.691	0.874
	LTE Band 26	15M	QPSK	36	0	-	Left Cheek	0mm	Ant4	DSI 1	26865	831.5	23.54	24.50	1.247	-0.02	0.562	0.701
	LTE Band 26	15M	QPSK	75	0	-	Left Cheek	0mm	Ant4	DSI 1	26865	831.5	23.49	24.50	1.262	0.02	0.549	0.693
	LTE Band 26	15M	QPSK	1	0	-	Left Tilted	0mm	Ant4	DSI 1	26865	831.5	24.48	25.50	1.265	0.02	0.618	0.782
	LTE Band 26	15M	QPSK	36	0	-	Left Tilted	0mm	Ant4	DSI 1	26865	831.5	23.54	24.50	1.247	0.04	0.497	0.620
	LTE Band 26	15M	QPSK	75	0	-	Left Tilted	0mm	Ant4	DSI 1	26865	831.5	23.49	24.50	1.262	0.07	0.492	0.621
	FR1 n5	20M	QPSK	1	1	DFT-15	Right Cheek	0mm	Ant0	DSI 1	167300	836.5	24.97	25.50	1.130	0.15	0.216	0.244
	FR1 n5	20M	QPSK	50	28	DFT-15	Right Cheek	0mm	Ant0	DSI 1	167300	836.5	24.94	25.50	1.138	0.06	0.223	0.254
	FR1 n5	20M	QPSK	1	1	DFT-15	Right Tilted	0mm	Ant0	DSI 1	167300	836.5	24.97	25.50	1.130	0.04	0.121	0.137
	FR1 n5	20M	QPSK	50	28	DFT-15	Right Tilted	0mm	Ant0	DSI 1	167300	836.5	24.94	25.50	1.138	0.06	0.108	0.123
	FR1 n5	20M	QPSK	1	1	DFT-15	Left Cheek	0mm	Ant0	DSI 1	167300	836.5	24.97	25.50	1.130	0.12	0.202	0.228
	FR1 n5	20M	QPSK	50	28	DFT-15	Left Cheek	0mm	Ant0	DSI 1	167300	836.5	24.94	25.50	1.138	-0.01	0.199	0.226
	FR1 n5	20M	QPSK	1	1	DFT-15	Left Tilted	0mm	Ant0	DSI 1	167300	836.5	24.97	25.50	1.130	-0.15	0.106	0.120
	FR1 n5	20M	QPSK	50	28	DFT-15	Left Tilted	0mm	Ant0	DSI 1	167300	836.5	24.94	25.50	1.138	0.09	0.102	0.116
05	FR1 n5	20M	QPSK	1	1	DFT-15	Right Cheek	0mm	Ant4	DSI 1	167300	836.5	24.27	24.50	1.054	-0.01	0.731	0.771
	FR1 n5	20M	QPSK	50	28	DFT-15	Right Cheek	0mm	Ant4	DSI 1	167300	836.5	24.13	24.50	1.089	0.06	0.696	0.758
	FR1 n5	20M	QPSK	1	1	DFT-15	Right Tilted	0mm	Ant4	DSI 1	167300	836.5	24.27	24.50	1.054	0.08	0.566	0.597
	FR1 n5	20M	QPSK	50	28	DFT-15	Right Tilted	0mm	Ant4	DSI 1	167300	836.5	24.13	24.50	1.089	0.04	0.557	0.607
	FR1 n5	20M	QPSK	1	1	DFT-15	Left Cheek	0mm	Ant4	DSI 1	167300	836.5	24.27	24.50	1.054	0.03	0.703	0.741
	FR1 n5	20M	QPSK	50	28	DFT-15	Left Cheek	0mm	Ant4	DSI 1	167300	836.5	24.13	24.50	1.089	-0.17	0.689	0.750
	FR1 n5	20M	QPSK	1	1	DFT-15	Left Tilted	0mm	Ant4	DSI 1	167300	836.5	24.27	24.50	1.054	-0.08	0.615	0.648
	FR1 n5	20M	QPSK	50	28	DFT-15	Left Tilted	0mm	Ant4	DSI 1	167300	836.5	24.13	24.50	1.089	0.07	0.600	0.653



Plot No.	Band	BW (MHz)	Modulation	RB Size	RB offset	Mode	Test Position	Gap (mm)	Antenna	Power State	Ch.	Freq. (MHz)	Average Power (dBm)	Tune-Up Limit (dBm)	Tune-up Scaling Factor	Power Drift (dB)	Measured 1g SAR (W/kg)	Reported 1g SAR (W/kg)	
1750MHz																			
	WCDMA IV	-	-	-	-	RMC 12.2Kbps	Right Cheek	0mm	Ant0	DSI 1	1413	1732.6	24.52	25.50	1.253	0.09	0.131	0.164	
	WCDMA IV	-	-	-	-	RMC 12.2Kbps	Right Tilted	0mm	Ant0	DSI 1	1413	1732.6	24.52	25.50	1.253	-0.02	0.091	0.114	
	WCDMA IV	-	-	-	-	RMC 12.2Kbps	Left Cheek	0mm	Ant0	DSI 1	1413	1732.6	24.52	25.50	1.253	-0.01	0.114	0.143	
	WCDMA IV	-	-	-	-	RMC 12.2Kbps	Left Tilted	0mm	Ant0	DSI 1	1413	1732.6	24.52	25.50	1.253	0.09	0.082	0.103	
06	WCDMA IV	-	-	-	-	RMC 12.2Kbps	Right Cheek	0mm	Ant4	DSI 1	1413	1732.6	20.90	21.50	1.148	0.18	0.428	0.491	
	WCDMA IV	-	-	-	-	RMC 12.2Kbps	Right Tilted	0mm	Ant4	DSI 1	1413	1732.6	20.90	21.50	1.148	-0.04	0.388	0.445	
	WCDMA IV	-	-	-	-	RMC 12.2Kbps	Left Cheek	0mm	Ant4	DSI 1	1413	1732.6	20.90	21.50	1.148	-0.13	0.292	0.335	
	WCDMA IV	-	-	-	-	RMC 12.2Kbps	Left Tilted	0mm	Ant4	DSI 1	1413	1732.6	20.90	21.50	1.148	0.02	0.408	0.468	
	LTE Band 4	20M	QPSK	1	0	-	Right Cheek	0mm	Ant0	DSI 1	20175	1732.5	24.25	25.50	1.334	-0.02	0.099	0.132	
	LTE Band 4	20M	QPSK	50	0	-	Right Cheek	0mm	Ant0	DSI 1	20175	1732.5	23.20	24.50	1.349	0.02	0.079	0.107	
	LTE Band 4	20M	QPSK	1	0	-	Right Tilted	0mm	Ant0	DSI 1	20175	1732.5	24.25	25.50	1.334	0.06	0.067	0.089	
	LTE Band 4	20M	QPSK	50	0	-	Right Tilted	0mm	Ant0	DSI 1	20175	1732.5	23.20	24.50	1.349	0.04	0.054	0.073	
	LTE Band 4	20M	QPSK	1	0	-	Left Cheek	0mm	Ant0	DSI 1	20175	1732.5	24.25	25.50	1.334	-0.13	0.083	0.111	
	LTE Band 4	20M	QPSK	50	0	-	Left Cheek	0mm	Ant0	DSI 1	20175	1732.5	23.20	24.50	1.349	0.01	0.073	0.098	
	LTE Band 4	20M	QPSK	1	0	-	Left Tilted	0mm	Ant0	DSI 1	20175	1732.5	24.25	25.50	1.334	0.04	0.073	0.097	
	LTE Band 4	20M	QPSK	50	0	-	Left Tilted	0mm	Ant0	DSI 1	20175	1732.5	23.20	24.50	1.349	-0.08	0.058	0.078	
	LTE Band 4	20M	QPSK	1	0	-	Right Cheek	0mm	Ant4	DSI 1	20175	1732.5	18.46	19.50	1.271	0.04	0.253	0.321	
07	LTE Band 4	20M	QPSK	50	0	-	Right Cheek	0mm	Ant4	DSI 1	20175	1732.5	18.39	19.50	1.291	0.11	0.257	0.332	
	LTE Band 4	20M	QPSK	1	0	-	Right Tilted	0mm	Ant4	DSI 1	20175	1732.5	18.46	19.50	1.271	0.03	0.222	0.282	
	LTE Band 4	20M	QPSK	50	0	-	Right Tilted	0mm	Ant4	DSI 1	20175	1732.5	18.39	19.50	1.291	-0.13	0.221	0.285	
	LTE Band 4	20M	QPSK	1	0	-	Left Cheek	0mm	Ant4	DSI 1	20175	1732.5	18.46	19.50	1.271	-0.12	0.167	0.212	
	LTE Band 4	20M	QPSK	50	0	-	Left Cheek	0mm	Ant4	DSI 1	20175	1732.5	18.39	19.50	1.291	0.19	0.169	0.218	
	LTE Band 4	20M	QPSK	1	0	-	Left Tilted	0mm	Ant4	DSI 1	20175	1732.5	18.46	19.50	1.271	-0.14	0.226	0.287	
	LTE Band 4	20M	QPSK	50	0	-	Left Tilted	0mm	Ant4	DSI 1	20175	1732.5	18.39	19.50	1.291	-0.05	0.237	0.306	
1900MHz																			
	GSM1900	-	-	-	-	GPRS (4 Tx slots)	Right Cheek	0mm	Ant0	DSI 1	661	1880	23.52	24.50	1.253	0.09	0.080	0.100	
	GSM1900	-	-	-	-	GPRS (4 Tx slots)	Right Tilted	0mm	Ant0	DSI 1	661	1880	23.52	24.50	1.253	0.02	0.080	0.100	
	GSM1900	-	-	-	-	GPRS (4 Tx slots)	Left Cheek	0mm	Ant0	DSI 1	661	1880	23.52	24.50	1.253	0.06	0.081	0.102	
	GSM1900	-	-	-	-	GPRS (4 Tx slots)	Left Tilted	0mm	Ant0	DSI 1	661	1880	23.52	24.50	1.253	0.03	0.067	0.084	
	GSM1900	-	-	-	-	GPRS (4 Tx slots)	Right Cheek	0mm	Ant4	DSI 1	661	1880	23.10	24.50	1.380	0.03	0.450	0.621	
	GSM1900	-	-	-	-	GPRS (4 Tx slots)	Right Tilted	0mm	Ant4	DSI 1	661	1880	23.10	24.50	1.380	0.06	0.415	0.573	
	GSM1900	-	-	-	-	GPRS (4 Tx slots)	Left Cheek	0mm	Ant4	DSI 1	661	1880	23.10	24.50	1.380	-0.16	0.416	0.574	
	GSM1900	-	-	-	-	GPRS (4 Tx slots)	Left Tilted	0mm	Ant4	DSI 1	661	1880	23.10	24.50	1.380	-0.02	0.582	0.803	
	GSM1900	-	-	-	-	GPRS (4 Tx slots)	Left Tilted	0mm	Ant4	DSI 1	512	1850.2	22.87	24.50	1.455	0.03	0.411	0.598	
08	GSM1900	-	-	-	-	GPRS (4 Tx slots)	Left Tilted	0mm	Ant4	DSI 1	810	1909.8	22.81	24.50	1.476	0.02	0.552	0.815	
	WCDMA II	-	-	-	-	RMC 12.2Kbps	Right Cheek	0mm	Ant0	DSI 1	9400	1880	24.43	25.50	1.279	-0.03	0.146	0.187	
	WCDMA II	-	-	-	-	RMC 12.2Kbps	Right Tilted	0mm	Ant0	DSI 1	9400	1880	24.43	25.50	1.279	0.03	0.108	0.138	
	WCDMA II	-	-	-	-	RMC 12.2Kbps	Left Cheek	0mm	Ant0	DSI 1	9400	1880	24.43	25.50	1.279	-0.1	0.145	0.186	
	WCDMA II	-	-	-	-	RMC 12.2Kbps	Left Tilted	0mm	Ant0	DSI 1	9400	1880	24.43	25.50	1.279	-0.11	0.142	0.182	
	WCDMA II	-	-	-	-	RMC 12.2Kbps	Right Cheek	0mm	Ant4	DSI 1	9400	1880	19.57	20.50	1.239	0.03	0.631	0.782	
	WCDMA II	-	-	-	-	RMC 12.2Kbps	Right Tilted	0mm	Ant4	DSI 1	9400	1880	19.57	20.50	1.239	0.03	0.680	0.842	
	WCDMA II	-	-	-	-	RMC 12.2Kbps	Right Tilted	0mm	Ant4	DSI 1	9262	1852.4	19.51	20.50	1.256	0.02	0.611	0.767	
09	WCDMA II	-	-	-	-	RMC 12.2Kbps	Right Tilted	0mm	Ant4	DSI 1	9538	1907.6	19.42	20.50	1.282	0.06	0.772	0.990	
	WCDMA II	-	-	-	-	RMC 12.2Kbps	Left Cheek	0mm	Ant4	DSI 1	9400	1880	19.57	20.50	1.239	0.08	0.436	0.540	
	WCDMA II	-	-	-	-	RMC 12.2Kbps	Left Tilted	0mm	Ant4	DSI 1	9400	1880	19.57	20.50	1.239	0.08	0.572	0.709	
	LTE Band 2	20M	QPSK	1	0	-	Right Cheek	0mm	Ant0	DSI 1	18900	1880	23.31	24.50	1.315	-0.18	0.106	0.139	
	LTE Band 2	20M	QPSK	50	0	-	Right Cheek	0mm	Ant0	DSI 1	18900	1880	22.29	23.50	1.321	0.17	0.084	0.111	
	LTE Band 2	20M	QPSK	1	0	-	Right Tilted	0mm	Ant0	DSI 1	18900	1880	23.31	24.50	1.315	0.11	0.082	0.108	
	LTE Band 2	20M	QPSK	50	0	-	Right Tilted	0mm	Ant0	DSI 1	18900	1880	22.29	23.50	1.321	0.05	0.067	0.089	
	LTE Band 2	20M	QPSK	1	0	-	Left Cheek	0mm	Ant0	DSI 1	18900	1880	23.31	24.50	1.315	-0.03	0.110	0.145	
	LTE Band 2	20M	QPSK	50	0	-	Left Cheek	0mm	Ant0	DSI 1	18900	1880	22.29	23.50	1.321	0.03	0.087	0.115	
	LTE Band 2	20M	QPSK	1	0	-	Left Tilted	0mm	Ant0	DSI 1	18900	1880	23.31	24.50	1.315	0.11	0.103	0.135	



FCC SAR Test Report

Report No. : FA1N1013-01

	LTE Band 2	20M	QPSK	50	0	-	Left Tilted	0mm	Ant0	DSI 1	18900	1880	22.29	23.50	1.321	-0.17	0.084	0.111
	LTE Band 2	20M	QPSK	1	0	-	Right Cheek	0mm	Ant4	DSI 1	18900	1880	18.68	19.50	1.208	0.1	0.529	0.639
10	LTE Band 2	20M	QPSK	50	0	-	Right Cheek	0mm	Ant4	DSI 1	18900	1880	18.62	19.50	1.225	0.14	0.533	0.653
	LTE Band 2-ENDC	20M	QPSK	50	0	-	Right Cheek	0mm	Ant4	DSI 1	18900	1880	15.46	16.50	1.271	0.16	0.197	0.250
	LTE Band 2	20M	QPSK	1	0	-	Right Tilted	0mm	Ant4	DSI 1	18900	1880	18.68	19.50	1.208	0.08	0.463	0.559
	LTE Band 2	20M	QPSK	50	0	-	Right Tilted	0mm	Ant4	DSI 1	18900	1880	18.62	19.50	1.225	0.07	0.470	0.576
	LTE Band 2	20M	QPSK	1	0	-	Left Cheek	0mm	Ant4	DSI 1	18900	1880	18.68	19.50	1.208	0.16	0.362	0.437
	LTE Band 2	20M	QPSK	50	0	-	Left Cheek	0mm	Ant4	DSI 1	18900	1880	18.62	19.50	1.225	-0.17	0.359	0.440
	LTE Band 2	20M	QPSK	1	0	-	Left Tilted	0mm	Ant4	DSI 1	18900	1880	18.68	19.50	1.208	-0.15	0.469	0.566
	LTE Band 2	20M	QPSK	50	0	-	Left Tilted	0mm	Ant4	DSI 1	18900	1880	18.62	19.50	1.225	0.06	0.474	0.580

Plot No.	Band	BW (MHz)	Modulation	RB Size	RB offset	Mode	Test Position	Gap (mm)	Antenna	Power State	Ch.	Freq. (MHz)	Average Power (dBm)	Tune-Up Limit (dBm)	Tune-up Scaling Factor	Duty Cycle %	Duty Cycle Scaling Factor	Power Drift (dB)	Measured 1g SAR (W/kg)	Reported 1g SAR (W/kg)
2600MHz																				
	LTE Band 7	20M	QPSK	1	0	-	Right Cheek	0mm	Ant0	DSI 1	21100	2535	24.39	25.50	1.291	-	-	0.13	0.070	0.090
	LTE Band 7	20M	QPSK	50	0	-	Right Cheek	0mm	Ant0	DSI 1	21100	2535	23.56	24.50	1.242	-	-	0.04	0.055	0.068
	LTE Band 7	20M	QPSK	1	0	-	Right Tilted	0mm	Ant0	DSI 1	21100	2535	24.39	25.50	1.291	-	-	-0.08	0.038	0.049
	LTE Band 7	20M	QPSK	50	0	-	Right Tilted	0mm	Ant0	DSI 1	21100	2535	23.56	24.50	1.242	-	-	0.09	0.031	0.038
	LTE Band 7	20M	QPSK	1	0	-	Left Cheek	0mm	Ant0	DSI 1	21100	2535	24.39	25.50	1.291	-	-	-0.11	0.123	0.159
	LTE Band 7C	20M	QPSK	1	0	-	Left Cheek	0mm	Ant0	DSI 1	21100+21298	2535+2554.8	24.27	25.50	1.327	-	-	0.05	0.089	0.118
	LTE Band 7	20M	QPSK	50	0	-	Left Cheek	0mm	Ant0	DSI 1	21100	2535	23.56	24.50	1.242	-	-	0.04	0.098	0.122
	LTE Band 7	20M	QPSK	1	0	-	Left Tilted	0mm	Ant0	DSI 1	21100	2535	24.39	25.50	1.291	-	-	0.06	0.070	0.090
	LTE Band 7	20M	QPSK	50	0	-	Left Tilted	0mm	Ant0	DSI 1	21100	2535	23.56	24.50	1.242	-	-	-0.1	0.058	0.072
	LTE Band 7	20M	QPSK	1	0	-	Right Cheek	0mm	Ant4	DSI 1	21100	2535	18.30	19.00	1.175	-	-	0.08	0.697	0.819
	LTE Band 7	20M	QPSK	1	0	-	Right Cheek	0mm	Ant4	DSI 1	20850	2510	18.23	19.00	1.194	-	-	0.04	0.671	0.801
	LTE Band 7	20M	QPSK	1	0	-	Right Cheek	0mm	Ant4	DSI 1	21350	2560	18.05	19.00	1.245	-	-	0.05	0.656	0.816
11	LTE Band 7	20M	QPSK	50	0	-	Right Cheek	0mm	Ant4	DSI 1	21100	2535	18.22	19.00	1.197	-	-	0.04	0.714	0.854
	LTE Band 7C	20M	QPSK	50	0	-	Right Cheek	0mm	Ant4	DSI 1	21100+21298	2535+2554.8	18.11	19.00	1.227	-	-	0.05	0.678	0.832
	LTE Band 7-ENDC	20M	QPSK	50	0	-	Right Cheek	0mm	Ant4	DSI 1	21100	2535	15.58	16.00	1.102	-	-	0.04	0.218	0.240
	LTE Band 7	20M	QPSK	50	0	-	Right Cheek	0mm	Ant4	DSI 1	20850	2510	18.09	19.00	1.233	-	-	-0.16	0.672	0.829
	LTE Band 7	20M	QPSK	50	0	-	Right Cheek	0mm	Ant4	DSI 1	21350	2560	18.15	19.00	1.216	-	-	-0.05	0.683	0.831
	LTE Band 7	20M	QPSK	100	0	-	Right Cheek	0mm	Ant4	DSI 1	21100	2535	18.20	19.00	1.202	-	-	-0.06	0.685	0.824
	LTE Band 7	20M	QPSK	1	0	-	Right Tilted	0mm	Ant4	DSI 1	21100	2535	18.30	19.00	1.175	-	-	0.03	0.548	0.644
	LTE Band 7	20M	QPSK	50	0	-	Right Tilted	0mm	Ant4	DSI 1	21100	2535	18.22	19.00	1.197	-	-	-0.08	0.567	0.679
	LTE Band 7	20M	QPSK	1	0	-	Left Cheek	0mm	Ant4	DSI 1	21100	2535	18.30	19.00	1.175	-	-	-0.06	0.401	0.471
	LTE Band 7	20M	QPSK	50	0	-	Left Cheek	0mm	Ant4	DSI 1	21100	2535	18.22	19.00	1.197	-	-	-0.07	0.411	0.492
	LTE Band 7	20M	QPSK	1	0	-	Left Tilted	0mm	Ant4	DSI 1	21100	2535	18.30	19.00	1.175	-	-	-0.04	0.493	0.579
	LTE Band 7	20M	QPSK	50	0	-	Left Tilted	0mm	Ant4	DSI 1	21100	2535	18.22	19.00	1.197	-	-	0.04	0.492	0.589
	FR1 n7	20M	QPSK	1	1	DFT-15	Right Cheek	0mm	Ant0	DSI 1	507000	2535	24.85	25.50	1.161	-	-	0.15	0.000	0.000
	FR1 n7	20M	QPSK	50	28	DFT-15	Right Cheek	0mm	Ant0	DSI 1	507000	2535	24.84	25.50	1.164	-	-	-0.12	0.000	0.000
	FR1 n7	20M	QPSK	1	1	DFT-15	Right Tilted	0mm	Ant0	DSI 1	507000	2535	24.85	25.50	1.161	-	-	0.18	0.000	0.000
	FR1 n7	20M	QPSK	50	28	DFT-15	Right Tilted	0mm	Ant0	DSI 1	507000	2535	24.84	25.50	1.164	-	-	0.02	0.000	0.000
	FR1 n7	20M	QPSK	1	1	DFT-15	Left Cheek	0mm	Ant0	DSI 1	507000	2535	24.85	25.50	1.161	-	-	-0.19	0.086	0.100
	FR1 n7	20M	QPSK	50	28	DFT-15	Left Cheek	0mm	Ant0	DSI 1	507000	2535	24.84	25.50	1.164	-	-	0.08	0.091	0.106
	FR1 n7	20M	QPSK	1	1	DFT-15	Left Tilted	0mm	Ant0	DSI 1	507000	2535	24.85	25.50	1.161	-	-	0.03	0.000	0.000
	FR1 n7	20M	QPSK	50	28	DFT-15	Left Tilted	0mm	Ant0	DSI 1	507000	2535	24.84	25.50	1.164	-	-	0.09	0.000	0.000
	FR1 n7	20M	QPSK	1	1	DFT-15	Right Cheek	0mm	Ant4	DSI 1	507000	2535	18.93	20.00	1.279	-	-	0.05	0.666	0.852
	FR1 n7	20M	QPSK	1	1	DFT-15	Right Cheek	0mm	Ant4	DSI 1	502000	2510	18.87	20.00	1.297	-	-	-0.08	0.709	0.920
12	FR1 n7	20M	QPSK	1	1	DFT-15	Right Cheek	0mm	Ant4	DSI 1	512000	2560	18.86	20.00	1.300	-	-	0.08	0.731	0.950
	FR1 n7	20M	QPSK	50	28	DFT-15	Right Cheek	0mm	Ant4	DSI 1	507000	2535	18.86	20.00	1.300	-	-	-0.16	0.677	0.880
	FR1 n7	20M	QPSK	50	28	DFT-15	Right Cheek	0mm	Ant4	DSI 1	502000	2510	18.64	20.00	1.368	-	-	-0.01	0.671	0.918
	FR1 n7	20M	QPSK	50	28	DFT-15	Right Cheek	0mm	Ant4	DSI 1	512000	2560	18.72	20.00	1.343	-	-	0.07	0.704	0.945
	FR1 n7	20M	QPSK	100	0	DFT-15	Right Cheek	0mm	Ant4	DSI 1	507000	2535	18.85	19.00	1.035	-	-	-0.13	0.523	0.541
	FR1 n7	20M	QPSK	1	1	DFT-15	Right Tilted	0mm	Ant4	DSI 1	507000	2535	18.93	20.00	1.279	-	-	-0.12	0.551	0.705
	FR1 n7	20M	QPSK	50	28	DFT-15	Right Tilted	0mm	Ant4	DSI 1	507000	2535	18.86	20.00	1.300	-	-	0.08	0.573	0.745



FCC SAR Test Report

Report No. : FA1N1013-01

	FR1 n7	20M	QPSK	1	1	DFT-15	Left Cheek	0mm	Ant4	DSI 1	507000	2535	18.93	20.00	1.279	-	-	0.03	0.423	0.541
	FR1 n7	20M	QPSK	50	28	DFT-15	Left Cheek	0mm	Ant4	DSI 1	507000	2535	18.86	20.00	1.300	-	-	0.07	0.422	0.549
	FR1 n7	20M	QPSK	1	1	DFT-15	Left Tilted	0mm	Ant4	DSI 1	507000	2535	18.93	20.00	1.279	-	-	-0.04	0.496	0.635
	FR1 n7	20M	QPSK	50	28	DFT-15	Left Tilted	0mm	Ant4	DSI 1	507000	2535	18.86	20.00	1.300	-	-	0.12	0.508	0.660
	LTE Band 41	20M	QPSK	1	0	-	Right Cheek	0mm	Ant0	DSI 1	40620	2593	24.68	25.50	1.208	62.9	1.006	0.03	0.055	0.067
	LTE Band 41	20M	QPSK	50	0	-	Right Cheek	0mm	Ant0	DSI 1	40620	2593	23.81	24.50	1.172	62.9	1.006	0.07	0.045	0.053
	LTE Band 41	20M	QPSK	1	0	-	Right Tilted	0mm	Ant0	DSI 1	40620	2593	24.68	25.50	1.208	62.9	1.006	-0.17	0.044	0.053
	LTE Band 41	20M	QPSK	50	0	-	Right Tilted	0mm	Ant0	DSI 1	40620	2593	23.81	24.50	1.172	62.9	1.006	0.03	0.034	0.040
	LTE Band 41	20M	QPSK	1	0	-	Left Cheek	0mm	Ant0	DSI 1	40620	2593	24.68	25.50	1.208	62.9	1.006	0.05	0.102	0.124
	LTE Band 41C	20M	QPSK	1	0	-	Left Cheek	0mm	Ant0	DSI 1	40620+40818	2593+2612.8	24.65	25.50	1.216	62.9	1.006	0.11	0.088	0.108
	LTE Band 41	20M	QPSK	50	0	-	Left Cheek	0mm	Ant0	DSI 1	40620	2593	23.81	24.50	1.172	62.9	1.006	0.05	0.095	0.112
	LTE Band 41	20M	QPSK	1	0	-	Left Tilted	0mm	Ant0	DSI 1	40620	2593	24.68	25.50	1.208	62.9	1.006	0.04	0.049	0.060
	LTE Band 41	20M	QPSK	50	0	-	Left Tilted	0mm	Ant0	DSI 1	40620	2593	23.81	24.50	1.172	62.9	1.006	0.13	0.039	0.046
	LTE Band 41	20M	QPSK	1	0	-	Right Cheek	0mm	Ant4	DSI 1	40620	2593	20.92	21.50	1.143	62.9	1.006	-0.15	0.697	0.801
	LTE Band 41	20M	QPSK	1	0	-	Right Cheek	0mm	Ant4	DSI 1	39750	2506	20.58	21.50	1.236	62.9	1.006	0.16	0.682	0.848
	LTE Band 41	20M	QPSK	1	0	-	Right Cheek	0mm	Ant4	DSI 1	40185	2549.5	20.61	21.50	1.227	62.9	1.006	0.08	0.697	0.861
	LTE Band 41	20M	QPSK	1	0	-	Right Cheek	0mm	Ant4	DSI 1	41055	2636.5	20.73	21.50	1.194	62.9	1.006	0.05	0.474	0.569
	LTE Band 41	20M	QPSK	1	0	-	Right Cheek	0mm	Ant4	DSI 1	41490	2680	20.80	21.50	1.175	62.9	1.006	0.12	0.412	0.487
	LTE Band 41	20M	QPSK	50	0	-	Right Cheek	0mm	Ant4	DSI 1	40620	2593	20.90	21.50	1.148	62.9	1.006	-0.07	0.701	0.810
	LTE Band 41	20M	QPSK	50	0	-	Right Cheek	0mm	Ant4	DSI 1	39750	2506	20.72	21.50	1.197	62.9	1.006	0.03	0.718	0.864
13	LTE Band 41	20M	QPSK	50	0	-	Right Cheek	0mm	Ant4	DSI 1	40185	2549.5	20.77	21.50	1.183	62.9	1.006	-0.05	0.728	0.866
	LTE Band 41C	20M	QPSK	50	0	-	Right Cheek	0mm	Ant4	DSI 1	40185+40383	2549.5+2569.3	20.72	21.50	1.197	62.9	1.006	-0.13	0.694	0.836
	LTE Band 41-ENDC	20M	QPSK	50	0	-	Right Cheek	0mm	Ant4	DSI 1	40185	2549.5	17.90	18.50	1.148	62.9	1.006	0.15	0.212	0.245
	LTE Band 41	20M	QPSK	50	0	-	Right Cheek	0mm	Ant4	DSI 1	41055	2636.5	20.80	21.50	1.175	62.9	1.006	0.04	0.487	0.576
	LTE Band 41	20M	QPSK	50	0	-	Right Cheek	0mm	Ant4	DSI 1	41490	2680	20.83	21.50	1.167	62.9	1.006	0.08	0.434	0.509
	LTE Band 41	20M	QPSK	100	0	-	Right Cheek	0mm	Ant4	DSI 1	40620	2593	20.88	21.50	1.153	62.9	1.006	0.06	0.606	0.703
	LTE Band 41	20M	QPSK	1	0	-	Right Tilted	0mm	Ant4	DSI 1	40620	2593	20.92	21.50	1.143	62.9	1.006	0.04	0.495	0.569
	LTE Band 41	20M	QPSK	50	0	-	Right Tilted	0mm	Ant4	DSI 1	40620	2593	20.90	21.50	1.148	62.9	1.006	-0.03	0.519	0.599
	LTE Band 41	20M	QPSK	1	0	-	Left Cheek	0mm	Ant4	DSI 1	40620	2593	20.92	21.50	1.143	62.9	1.006	0.01	0.328	0.377
	LTE Band 41	20M	QPSK	50	0	-	Left Cheek	0mm	Ant4	DSI 1	40620	2593	20.90	21.50	1.148	62.9	1.006	0.17	0.349	0.403
	LTE Band 41	20M	QPSK	1	0	-	Left Tilted	0mm	Ant4	DSI 1	40620	2593	20.92	21.50	1.143	62.9	1.006	0.06	0.395	0.454
	LTE Band 41	20M	QPSK	50	0	-	Left Tilted	0mm	Ant4	DSI 1	40620	2593	20.90	21.50	1.148	62.9	1.006	0.02	0.404	0.467
	FR1 n41	100M	QPSK	1	1	DFT-30	Right Cheek	0mm	Ant0	DSI 1	518598	2592.99	26.16	27.00	1.213	-	-	0.14	0.074	0.090
	FR1 n41	100M	QPSK	135	69	DFT-30	Right Cheek	0mm	Ant0	DSI 1	518598	2592.99	26.02	27.00	1.253	-	-	0.06	0.083	0.104
	FR1 n41	100M	QPSK	1	1	DFT-30	Right Tilted	0mm	Ant0	DSI 1	518598	2592.99	26.16	27.00	1.213	-	-	-0.14	0.042	0.051
	FR1 n41	100M	QPSK	135	69	DFT-30	Right Tilted	0mm	Ant0	DSI 1	518598	2592.99	26.02	27.00	1.253	-	-	0.18	0.066	0.083
	FR1 n41	100M	QPSK	1	1	DFT-30	Left Cheek	0mm	Ant0	DSI 1	518598	2592.99	26.16	27.00	1.213	-	-	0.02	0.144	0.175
	FR1 n41	100M	QPSK	135	69	DFT-30	Left Cheek	0mm	Ant0	DSI 1	518598	2592.99	26.02	27.00	1.253	-	-	-0.04	0.181	0.227
	FR1 n41	100M	QPSK	1	1	DFT-30	Left Tilted	0mm	Ant0	DSI 1	518598	2592.99	26.16	27.00	1.213	-	-	0.08	0.077	0.093
	FR1 n41	100M	QPSK	135	69	DFT-30	Left Tilted	0mm	Ant0	DSI 1	518598	2592.99	26.02	27.00	1.253	-	-	-0.05	0.083	0.104
14	FR1 n41	100M	QPSK	1	1	DFT-30	Right Cheek	0mm	Ant4	DSI 1	518598	2592.99	18.63	20.00	1.371	-	-	0.03	0.769	1.054
	FR1 n41	100M	QPSK	135	69	DFT-30	Right Cheek	0mm	Ant4	DSI 1	518598	2592.99	18.29	20.00	1.483	-	-	-0.08	0.679	1.007
	FR1 n41	100M	QPSK	270	0	DFT-30	Right Cheek	0mm	Ant4	DSI 1	518598	2592.99	18.32	20.00	1.472	-	-	0.13	0.535	0.788
	FR1 n41	100M	QPSK	1	1	DFT-30	Right Tilted	0mm	Ant4	DSI 1	518598	2592.99	18.63	20.00	1.371	-	-	0.17	0.662	0.908
	FR1 n41	100M	QPSK	135	69	DFT-30	Right Tilted	0mm	Ant4	DSI 1	518598	2592.99	18.29	20.00	1.483	-	-	-0.08	0.523	0.775
	FR1 n41	100M	QPSK	270	0	DFT-30	Right Tilted	0mm	Ant4	DSI 1	518598	2592.99	18.32	20.00	1.472	-	-	0.16	0.439	0.646
	FR1 n41	100M	QPSK	1	1	DFT-30	Left Cheek	0mm	Ant4	DSI 1	518598	2592.99	18.63	20.00	1.371	-	-	-0.17	0.528	0.724
	FR1 n41	100M	QPSK	135	69	DFT-30	Left Cheek	0mm	Ant4	DSI 1	518598	2592.99	18.29	20.00	1.483	-	-	0.06	0.407	0.603
	FR1 n41	100M	QPSK	1	1	DFT-30	Left Tilted	0mm	Ant4	DSI 1	518598	2592.99	18.63	20.00	1.371	-	-	0.08	0.609	0.835
	FR1 n41	100M	QPSK	135	69	DFT-30	Left Tilted	0mm	Ant4	DSI 1	518598	2592.99	18.29	20.00	1.483	-	-	-0.08	0.452	0.670
	FR1 n41	100M	QPSK	270	0	DFT-30	Left Tilted	0mm	Ant4	DSI 1	518598	2592.99	18.32	20.00	1.472	-	-	0.08	0.389	0.573



Plot No.	Band	BW (MHz)	Modulation	RB Size	RB offset	Mode	Test Position	Gap (mm)	Antenna	Power State	Ch.	Freq. (MHz)	Average Power (dBm)	Tune-Up Limit (dBm)	Tune-up Scaling Factor	Power Drift (dB)	Measured 1g SAR (W/kg)	Reported 1g SAR (W/kg)	
3500MHz																			
	FR1 n77	100M	QPSK	1	1	DFT-30	Right Cheek	0mm	Ant3	DSI 1	656000	3840	15.72	17.00	1.343	0.03	0.573	0.769	
	FR1 n77	100M	QPSK	135	69	DFT-30	Right Cheek	0mm	Ant3	DSI 1	656000	3840	15.66	17.00	1.361	0.04	0.544	0.741	
	FR1 n77	100M	QPSK	1	1	DFT-30	Right Tilted	0mm	Ant3	DSI 1	656000	3840	15.72	17.00	1.343	-0.17	0.300	0.403	
	FR1 n77	100M	QPSK	135	69	DFT-30	Right Tilted	0mm	Ant3	DSI 1	656000	3840	15.66	17.00	1.361	-0.12	0.297	0.404	
	FR1 n77	100M	QPSK	1	1	DFT-30	Left Cheek	0mm	Ant3	DSI 1	656000	3840	15.72	17.00	1.343	0.02	0.154	0.207	
	FR1 n77	100M	QPSK	135	69	DFT-30	Left Cheek	0mm	Ant3	DSI 1	656000	3840	15.66	17.00	1.361	0.03	0.144	0.196	
	FR1 n77	100M	QPSK	1	1	DFT-30	Left Tilted	0mm	Ant3	DSI 1	656000	3840	15.72	17.00	1.343	0.02	0.138	0.185	
	FR1 n77	100M	QPSK	135	69	DFT-30	Left Tilted	0mm	Ant3	DSI 1	656000	3840	15.66	17.00	1.361	-0.13	0.128	0.174	
	FR1 n77	100M	QPSK	1	1	DFT-30	Right Cheek	0mm	Ant3	DSI 1	633334	3500.01	15.62	17.00	1.374	0.05	0.560	0.769	
15	FR1 n77	100M	QPSK	135	69	DFT-30	Right Cheek	0mm	Ant3	DSI 1	633334	3500.01	15.52	17.00	1.406	0.11	0.564	0.793	
	FR1 n77	100M	QPSK	1	1	DFT-30	Right Tilted	0mm	Ant3	DSI 1	633334	3500.01	15.62	17.00	1.374	0.07	0.279	0.383	
	FR1 n77	100M	QPSK	135	69	DFT-30	Right Tilted	0mm	Ant3	DSI 1	633334	3500.01	15.52	17.00	1.406	0.03	0.289	0.406	
	FR1 n77	100M	QPSK	1	1	DFT-30	Left Cheek	0mm	Ant3	DSI 1	633334	3500.01	15.62	17.00	1.374	0.09	0.164	0.225	
	FR1 n77	100M	QPSK	135	69	DFT-30	Left Cheek	0mm	Ant3	DSI 1	633334	3500.01	15.52	17.00	1.406	0.11	0.158	0.222	
	FR1 n77	100M	QPSK	1	1	DFT-30	Left Tilted	0mm	Ant3	DSI 1	633334	3500.01	15.62	17.00	1.374	0.13	0.136	0.187	
	FR1 n77	100M	QPSK	135	69	DFT-30	Left Tilted	0mm	Ant3	DSI 1	633334	3500.01	15.52	17.00	1.406	0.04	0.133	0.187	
	FR1 n77	100M	QPSK	1	1	DFT-30	Right Cheek	0mm	Ant5	DSI 1	656000	3840	16.71	17.00	1.069	-0.11	0.360	0.385	
	FR1 n77	100M	QPSK	135	69	DFT-30	Right Cheek	0mm	Ant5	DSI 1	656000	3840	16.61	17.00	1.094	-0.12	0.393	0.430	
	FR1 n77	100M	QPSK	1	1	DFT-30	Right Tilted	0mm	Ant5	DSI 1	656000	3840	16.71	17.00	1.069	0.07	0.404	0.432	
	FR1 n77	100M	QPSK	135	69	DFT-30	Right Tilted	0mm	Ant5	DSI 1	656000	3840	16.61	17.00	1.094	-0.06	0.432	0.473	
	FR1 n77	100M	QPSK	1	1	DFT-30	Left Cheek	0mm	Ant5	DSI 1	656000	3840	16.71	17.00	1.069	-0.08	0.623	0.666	
	FR1 n77	100M	QPSK	135	69	DFT-30	Left Cheek	0mm	Ant5	DSI 1	656000	3840	16.61	17.00	1.094	0.18	0.636	0.696	
	FR1 n77	100M	QPSK	1	1	DFT-30	Left Tilted	0mm	Ant5	DSI 1	656000	3840	16.71	17.00	1.069	-0.17	0.654	0.699	
	FR1 n77	100M	QPSK	135	69	DFT-30	Left Tilted	0mm	Ant5	DSI 1	656000	3840	16.61	17.00	1.094	-0.05	0.637	0.697	
	FR1 n77	100M	QPSK	1	1	DFT-30	Right Cheek	0mm	Ant5	DSI 1	633334	3500.01	16.59	17.00	1.099	0.03	0.305	0.335	
	FR1 n77	100M	QPSK	135	69	DFT-30	Right Cheek	0mm	Ant5	DSI 1	633334	3500.01	16.53	17.00	1.114	-0.1	0.236	0.263	
	FR1 n77	100M	QPSK	1	1	DFT-30	Right Tilted	0mm	Ant5	DSI 1	633334	3500.01	16.59	17.00	1.099	0.13	0.288	0.317	
	FR1 n77	100M	QPSK	135	69	DFT-30	Right Tilted	0mm	Ant5	DSI 1	633334	3500.01	16.53	17.00	1.114	0.18	0.236	0.263	
	FR1 n77	100M	QPSK	1	1	DFT-30	Left Cheek	0mm	Ant5	DSI 1	633334	3500.01	16.59	17.00	1.099	0.05	0.453	0.498	
	FR1 n77	100M	QPSK	135	69	DFT-30	Left Cheek	0mm	Ant5	DSI 1	633334	3500.01	16.53	17.00	1.114	-0.16	0.516	0.575	
	FR1 n77	100M	QPSK	1	1	DFT-30	Left Tilted	0mm	Ant5	DSI 1	633334	3500.01	16.59	17.00	1.099	0.07	0.620	0.681	
	FR1 n77	100M	QPSK	135	69	DFT-30	Left Tilted	0mm	Ant5	DSI 1	633334	3500.01	16.53	17.00	1.114	0.01	0.490	0.546	



Plot No.	Band	Mode	Test Position	Gap (mm)	Antenna	Power State	Ch.	Freq. (MHz)	Average Power (dBm)	Tune-Up Limit (dBm)	Tune-up Scaling Factor	Duty Cycle %	Duty Cycle Scaling Factor	Power Drift (dB)	Measured 1g SAR (W/kg)	Reported 1g SAR (W/kg)
2450MHZ																
	WLAN2.4GHz	802.11b 1Mbps	Right Cheek	0mm	ANT 6	Reduced	6	2437	12.73	14.00	1.340	99.3	1.007	0.18	0.075	0.101
	WLAN2.4GHz	802.11b 1Mbps	Right Tilted	0mm	ANT 6	Reduced	6	2437	12.73	14.00	1.340	99.3	1.007	-0.09	0.058	0.078
16	WLAN2.4GHz	802.11b 1Mbps	Left Cheek	0mm	ANT 6	Reduced	6	2437	12.73	14.00	1.340	99.3	1.007	0.01	0.207	0.279
	WLAN2.4GHz	802.11b 1Mbps	Left Tilted	0mm	ANT 6	Reduced	6	2437	12.73	14.00	1.340	99.3	1.007	0.07	0.153	0.206
17	Bluetooth	1Mbps	Left Cheek	0mm	ANT 6	Full Power	39	2441	9.81	11.00	1.315	77.38	1.292	-0.11	0.058	0.099
5000MHZ																
	WLAN5.3GHz	802.11ac-VHT80 MCS0	Right Cheek	0mm	ANT 6	Reduced	58	5290	11.35	12.50	1.303	90.1	1.110	0.03	0.172	0.249
	WLAN5.3GHz	802.11ac-VHT80 MCS0	Right Tilted	0mm	ANT 6	Reduced	58	5290	11.35	12.50	1.303	90.1	1.110	0.14	0.202	0.292
	WLAN5.3GHz	802.11ac-VHT80 MCS0	Left Cheek	0mm	ANT 6	Reduced	58	5290	11.35	12.50	1.303	90.1	1.110	0.04	0.342	0.495
18	WLAN5.3GHz	802.11ac-VHT80 MCS0	Left Tilted	0mm	ANT 6	Reduced	58	5290	11.35	12.50	1.303	90.1	1.110	0.02	0.372	0.538
	WLAN5.5GHz	802.11ac-VHT80 MCS0	Right Cheek	0mm	ANT 6	Reduced	122	5610	11.08	12.00	1.236	90.1	1.110	0.03	0.242	0.332
	WLAN5.5GHz	802.11ac-VHT80 MCS0	Right Tilted	0mm	ANT 6	Reduced	122	5610	11.08	12.00	1.236	90.1	1.110	0.03	0.278	0.381
	WLAN5.5GHz	802.11ac-VHT80 MCS0	Left Cheek	0mm	ANT 6	Reduced	122	5610	11.08	12.00	1.236	90.1	1.110	0.02	0.378	0.519
19	WLAN5.5GHz	802.11ac-VHT80 MCS0	Left Tilted	0mm	ANT 6	Reduced	122	5610	11.08	12.00	1.236	90.1	1.110	0.02	0.397	0.545
	WLAN5.8GHz	802.11ac-VHT80 MCS0	Right Cheek	0mm	ANT 6	Reduced	155	5775	10.35	11.50	1.303	90.1	1.110	-0.08	0.115	0.166
	WLAN5.8GHz	802.11ac-VHT80 MCS0	Right Tilted	0mm	ANT 6	Reduced	155	5775	10.35	11.50	1.303	90.1	1.110	0.05	0.134	0.194
	WLAN5.8GHz	802.11ac-VHT80 MCS0	Left Cheek	0mm	ANT 6	Reduced	155	5775	10.35	11.50	1.303	90.1	1.110	0.08	0.215	0.311
20	WLAN5.8GHz	802.11ac-VHT80 MCS0	Left Tilted	0mm	ANT 6	Reduced	155	5775	10.35	11.50	1.303	90.1	1.110	0.02	0.220	0.318



15.2 Hotspot SAR

Plot No.	Band	BW (MHz)	Modulation	RB Size	RB offset	Mode	Test Position	Gap (mm)	Antenna	Power State	Ch.	Freq. (MHz)	Average Power (dBm)	Tune-Up Limit (dBm)	Tune-up Scaling Factor	Power Drift (dB)	Measured 1g SAR (W/kg)	Reported 1g SAR (W/kg)	
750MHz																			
	LTE Band 12	10M	QPSK	1	0	-	Front	10mm	Ant 0	DSI 4	23095	707.5	24.69	25.50	1.205	0.05	0.127	0.153	
	LTE Band 12	10M	QPSK	25	0	-	Front	10mm	Ant 0	DSI 4	23095	707.5	23.89	24.50	1.151	-0.07	0.105	0.121	
	LTE Band 12	10M	QPSK	1	0	-	Back	10mm	Ant 0	DSI 4	23095	707.5	24.69	25.50	1.205	0.15	0.220	0.265	
	LTE Band 12	10M	QPSK	25	0	-	Back	10mm	Ant 0	DSI 4	23095	707.5	23.89	24.50	1.151	0.1	0.174	0.200	
	LTE Band 12	10M	QPSK	1	0	-	Left Side	10mm	Ant 0	DSI 2	23095	707.5	24.69	25.50	1.205	0.02	0.145	0.175	
	LTE Band 12	10M	QPSK	25	0	-	Left Side	10mm	Ant 0	DSI 2	23095	707.5	23.89	24.50	1.151	-0.07	0.121	0.139	
21	LTE Band 12	10M	QPSK	1	0	-	Right Side	10mm	Ant 0	DSI 2	23095	707.5	24.69	25.50	1.205	-0.01	0.252	0.304	
	LTE Band 12	10M	QPSK	25	0	-	Right Side	10mm	Ant 0	DSI 2	23095	707.5	23.89	24.50	1.151	-0.03	0.208	0.239	
	LTE Band 12	10M	QPSK	1	0	-	Bottom Side	10mm	Ant 0	DSI 4	23095	707.5	24.69	25.50	1.205	0.01	0.185	0.223	
	LTE Band 12	10M	QPSK	25	0	-	Bottom Side	10mm	Ant 0	DSI 4	23095	707.5	23.89	24.50	1.151	0.07	0.149	0.171	
	LTE Band 12	10M	QPSK	1	0	-	Front	10mm	Ant 4	DSI 4	23095	707.5	24.76	25.50	1.186	-0.15	0.099	0.117	
	LTE Band 12	10M	QPSK	25	0	-	Front	10mm	Ant 4	DSI 4	23095	707.5	23.78	24.50	1.180	-0.1	0.082	0.097	
	LTE Band 12	10M	QPSK	1	0	-	Back	10mm	Ant 4	DSI 4	23095	707.5	24.76	25.50	1.186	0.01	0.176	0.209	
	LTE Band 12	10M	QPSK	25	0	-	Back	10mm	Ant 4	DSI 4	23095	707.5	23.78	24.50	1.180	-0.16	0.140	0.165	
	LTE Band 12	10M	QPSK	1	0	-	Left Side	10mm	Ant 4	DSI 2	23095	707.5	24.76	25.50	1.186	0.08	0.147	0.174	
	LTE Band 12	10M	QPSK	25	0	-	Left Side	10mm	Ant 4	DSI 2	23095	707.5	23.78	24.50	1.180	-0.02	0.124	0.146	
	LTE Band 12	10M	QPSK	1	0	-	Right Side	10mm	Ant 4	DSI 2	23095	707.5	24.76	25.50	1.186	0.1	0.100	0.119	
	LTE Band 12	10M	QPSK	25	0	-	Right Side	10mm	Ant 4	DSI 2	23095	707.5	23.78	24.50	1.180	-0.14	0.083	0.098	
	LTE Band 12	10M	QPSK	1	0	-	Top Side	10mm	Ant 4	DSI 4	23095	707.5	24.76	25.50	1.186	0.04	0.074	0.088	
	LTE Band 12	10M	QPSK	25	0	-	Top Side	10mm	Ant 4	DSI 4	23095	707.5	23.78	24.50	1.180	-0.02	0.059	0.070	
835MHz																			
	GSM850	-	-	-	-	GPRS (4 Tx slots)	Front	10mm	Ant 0	DSI 4	189	836.4	26.32	27.50	1.312	0.06	0.229	0.300	
22	GSM850	-	-	-	-	GPRS (4 Tx slots)	Back	10mm	Ant 0	DSI 4	189	836.4	26.32	27.50	1.312	-0.04	0.388	0.509	
	GSM850	-	-	-	-	GPRS (4 Tx slots)	Left Side	10mm	Ant 0	DSI 2	189	836.4	26.32	27.50	1.312	-0.03	0.121	0.159	
	GSM850	-	-	-	-	GPRS (4 Tx slots)	Right Side	10mm	Ant 0	DSI 2	189	836.4	26.32	27.50	1.312	-0.02	0.256	0.336	
	GSM850	-	-	-	-	GPRS (4 Tx slots)	Bottom Side	10mm	Ant 0	DSI 4	189	836.4	26.32	27.50	1.312	0.15	0.320	0.420	
	GSM850	-	-	-	-	GPRS (4 Tx slots)	Front	10mm	Ant 4	DSI 4	189	836.4	26.54	27.50	1.247	0.07	0.205	0.256	
	GSM850	-	-	-	-	GPRS (4 Tx slots)	Back	10mm	Ant 4	DSI 4	189	836.4	26.54	27.50	1.247	0.03	0.352	0.439	
	GSM850	-	-	-	-	GPRS (4 Tx slots)	Left Side	10mm	Ant 4	DSI 2	189	836.4	26.54	27.50	1.247	0.08	0.127	0.158	
	GSM850	-	-	-	-	GPRS (4 Tx slots)	Right Side	10mm	Ant 4	DSI 2	189	836.4	26.54	27.50	1.247	0.04	0.143	0.178	
	GSM850	-	-	-	-	GPRS (4 Tx slots)	Top Side	10mm	Ant 4	DSI 4	189	836.4	26.54	27.50	1.247	0.07	0.198	0.247	
	WCDMA V	-	-	-	-	RMC 12.2Kbps	Front	10mm	Ant 0	DSI 4	4182	836.4	24.78	25.50	1.180	-0.1	0.261	0.308	
23	WCDMA V	-	-	-	-	RMC 12.2Kbps	Back	10mm	Ant 0	DSI 4	4182	836.4	24.78	25.50	1.180	-0.09	0.473	0.558	
	WCDMA V	-	-	-	-	RMC 12.2Kbps	Left Side	10mm	Ant 0	DSI 2	4182	836.4	24.78	25.50	1.180	-0.08	0.122	0.144	
	WCDMA V	-	-	-	-	RMC 12.2Kbps	Right Side	10mm	Ant 0	DSI 2	4182	836.4	24.78	25.50	1.180	0.03	0.220	0.260	
	WCDMA V	-	-	-	-	RMC 12.2Kbps	Bottom Side	10mm	Ant 0	DSI 4	4182	836.4	24.78	25.50	1.180	0.15	0.388	0.458	
	WCDMA V	-	-	-	-	RMC 12.2Kbps	Front	10mm	Ant 4	DSI 4	4182	836.4	24.73	25.50	1.194	0.07	0.251	0.300	
	WCDMA V	-	-	-	-	RMC 12.2Kbps	Back	10mm	Ant 4	DSI 4	4182	836.4	24.73	25.50	1.194	-0.13	0.413	0.493	
	WCDMA V	-	-	-	-	RMC 12.2Kbps	Left Side	10mm	Ant 4	DSI 2	4182	836.4	24.73	25.50	1.194	0.11	0.117	0.140	
	WCDMA V	-	-	-	-	RMC 12.2Kbps	Right Side	10mm	Ant 4	DSI 2	4182	836.4	24.73	25.50	1.194	0.08	0.119	0.142	
	WCDMA V	-	-	-	-	RMC 12.2Kbps	Top Side	10mm	Ant 4	DSI 4	4182	836.4	24.73	25.50	1.194	0.08	0.216	0.258	
	LTE Band 26	15M	QPSK	1	0	-	Front	10mm	Ant 0	DSI 4	26865	831.5	24.44	25.50	1.276	-0.14	0.208	0.265	
	LTE Band 26	15M	QPSK	36	0	-	Front	10mm	Ant 0	DSI 4	26865	831.5	23.50	24.50	1.259	0.12	0.171	0.215	
24	LTE Band 26	15M	QPSK	1	0	-	Back	10mm	Ant 0	DSI 4	26865	831.5	24.44	25.50	1.276	-0.08	0.357	0.456	
	LTE Band 26	15M	QPSK	36	0	-	Back	10mm	Ant 0	DSI 4	26865	831.5	23.50	24.50	1.259	0.18	0.293	0.369	
	LTE Band 26	15M	QPSK	1	0	-	Left Side	10mm	Ant 0	DSI 2	26865	831.5	24.44	25.50	1.276	0.04	0.105	0.134	
	LTE Band 26	15M	QPSK	36	0	-	Left Side	10mm	Ant 0	DSI 2	26865	831.5	23.50	24.50	1.259	-0.16	0.085	0.107	
	LTE Band 26	15M	QPSK	1	0	-	Right Side	10mm	Ant 0	DSI 2	26865	831.5	24.44	25.50	1.276	-0.17	0.173	0.221	
	LTE Band 26	15M	QPSK	36	0	-	Right Side	10mm	Ant 0	DSI 2	26865	831.5	23.50	24.50	1.259	-0.08	0.142	0.179	
	LTE Band 26	15M	QPSK	1	0	-	Bottom Side	10mm	Ant 0	DSI 4	26865	831.5	24.44	25.50	1.276	0.11	0.303	0.387	



FCC SAR Test Report

Report No. : FA1N1013-01

	LTE Band 26	15M	QPSK	36	0	-	Bottom Side	10mm	Ant 0	DSI 4	26865	831.5	23.50	24.50	1.259	-0.06	0.249	0.313
	LTE Band 26	15M	QPSK	1	0	-	Front	10mm	Ant 4	DSI 4	26865	831.5	24.48	25.50	1.265	-0.09	0.177	0.224
	LTE Band 26	15M	QPSK	36	0	-	Front	10mm	Ant 4	DSI 4	26865	831.5	23.54	24.50	1.247	0.03	0.146	0.182
	LTE Band 26	15M	QPSK	1	0	-	Back	10mm	Ant 4	DSI 4	26865	831.5	24.48	25.50	1.265	-0.1	0.314	0.397
	LTE Band 26	15M	QPSK	36	0	-	Back	10mm	Ant 4	DSI 4	26865	831.5	23.54	24.50	1.247	0.04	0.259	0.323
	LTE Band 26	15M	QPSK	1	0	-	Left Side	10mm	Ant 4	DSI 2	26865	831.5	24.48	25.50	1.265	0.07	0.076	0.096
	LTE Band 26	15M	QPSK	36	0	-	Left Side	10mm	Ant 4	DSI 2	26865	831.5	23.54	24.50	1.247	0.03	0.065	0.081
	LTE Band 26	15M	QPSK	1	0	-	Right Side	10mm	Ant 4	DSI 2	26865	831.5	24.48	25.50	1.265	0.12	0.087	0.110
	LTE Band 26	15M	QPSK	36	0	-	Right Side	10mm	Ant 4	DSI 2	26865	831.5	23.54	24.50	1.247	0.06	0.071	0.089
	LTE Band 26	15M	QPSK	1	0	-	Top Side	10mm	Ant 4	DSI 4	26865	831.5	24.48	25.50	1.265	-0.14	0.168	0.212
	LTE Band 26	15M	QPSK	36	0	-	Top Side	10mm	Ant 4	DSI 4	26865	831.5	23.54	24.50	1.247	0.03	0.135	0.168
	FR1 n5	20M	QPSK	1	1	DFT-15	Front	10mm	Ant 0	DSI 4	167300	836.5	24.97	25.50	1.130	-0.1	0.254	0.287
	FR1 n5	20M	QPSK	50	28	DFT-15	Front	10mm	Ant 0	DSI 4	167300	836.5	24.94	25.50	1.138	0.07	0.259	0.295
	FR1 n5	20M	QPSK	1	1	DFT-15	Back	10mm	Ant 0	DSI 4	167300	836.5	24.97	25.50	1.130	-0.18	0.434	0.490
25	FR1 n5	20M	QPSK	50	28	DFT-15	Back	10mm	Ant 0	DSI 4	167300	836.5	24.94	25.50	1.138	-0.09	0.471	0.536
	FR1 n5	20M	QPSK	1	1	DFT-15	Left Side	10mm	Ant 0	DSI 2	167300	836.5	24.97	25.50	1.130	-0.09	0.135	0.153
	FR1 n5	20M	QPSK	50	28	DFT-15	Left Side	10mm	Ant 0	DSI 2	167300	836.5	24.94	25.50	1.138	0.16	0.128	0.146
	FR1 n5	20M	QPSK	1	1	DFT-15	Right Side	10mm	Ant 0	DSI 2	167300	836.5	24.97	25.50	1.130	0.08	0.204	0.230
	FR1 n5	20M	QPSK	50	28	DFT-15	Right Side	10mm	Ant 0	DSI 2	167300	836.5	24.94	25.50	1.138	-0.02	0.221	0.251
	FR1 n5	20M	QPSK	1	1	DFT-15	Bottom Side	10mm	Ant 0	DSI 4	167300	836.5	24.97	25.50	1.130	0.02	0.354	0.400
	FR1 n5	20M	QPSK	50	28	DFT-15	Bottom Side	10mm	Ant 0	DSI 4	167300	836.5	24.94	25.50	1.138	0.07	0.419	0.477
	FR1 n5	20M	QPSK	1	1	DFT-15	Front	10mm	Ant 4	DSI 4	167300	836.5	25.17	25.50	1.079	0.19	0.186	0.201
	FR1 n5	20M	QPSK	50	28	DFT-15	Front	10mm	Ant 4	DSI 4	167300	836.5	25.07	25.50	1.104	-0.02	0.184	0.203
	FR1 n5	20M	QPSK	1	1	DFT-15	Back	10mm	Ant 4	DSI 4	167300	836.5	25.17	25.50	1.079	-0.08	0.359	0.387
	FR1 n5	20M	QPSK	50	28	DFT-15	Back	10mm	Ant 4	DSI 4	167300	836.5	25.07	25.50	1.104	-0.09	0.326	0.360
	FR1 n5	20M	QPSK	1	1	DFT-15	Left Side	10mm	Ant 4	DSI 2	167300	836.5	25.17	25.50	1.079	0.06	0.081	0.087
	FR1 n5	20M	QPSK	50	28	DFT-15	Left Side	10mm	Ant 4	DSI 2	167300	836.5	25.07	25.50	1.104	0.04	0.079	0.087
	FR1 n5	20M	QPSK	1	1	DFT-15	Right Side	10mm	Ant 4	DSI 2	167300	836.5	25.17	25.50	1.079	0.06	0.096	0.104
	FR1 n5	20M	QPSK	50	28	DFT-15	Right Side	10mm	Ant 4	DSI 2	167300	836.5	25.07	25.50	1.104	-0.07	0.091	0.100
	FR1 n5	20M	QPSK	1	1	DFT-15	Top Side	10mm	Ant 4	DSI 4	167300	836.5	25.17	25.50	1.079	0.07	0.205	0.221
	FR1 n5	20M	QPSK	50	28	DFT-15	Top Side	10mm	Ant 4	DSI 4	167300	836.5	25.07	25.50	1.104	-0.05	0.168	0.185



Plot No.	Band	BW (MHz)	Modulation	RB Size	RB offset	Mode	Test Position	Gap (mm)	Antenna	Power State	Ch.	Freq. (MHz)	Average Power (dBm)	Tune-Up Limit (dBm)	Tune-up Scaling Factor	Power Drift (dB)	Measure d 1g SAR (W/kg)	Reported 1g SAR (W/kg)	
1750MHz																			
	WCDMA IV	-	-	-	-	RMC 12.2Kbps	Front	10mm	Ant 0	DSI 4	1413	1732.6	22.56	23.50	1.242	-0.02	0.262	0.325	
	WCDMA IV	-	-	-	-	RMC 12.2Kbps	Back	10mm	Ant 0	DSI 4	1413	1732.6	22.56	23.50	1.242	0.06	0.704	0.874	
	WCDMA IV	-	-	-	-	RMC 12.2Kbps	Back	10mm	Ant 0	DSI 4	1312	1712.4	22.40	23.50	1.288	0.16	0.665	0.857	
	WCDMA IV	-	-	-	-	RMC 12.2Kbps	Back	10mm	Ant 0	DSI 4	1513	1752.6	22.51	23.50	1.256	0.08	0.671	0.843	
	WCDMA IV	-	-	-	-	RMC 12.2Kbps	Left Side	10mm	Ant 0	DSI 2	1413	1732.6	24.52	25.50	1.253	-0.12	0.139	0.174	
	WCDMA IV	-	-	-	-	RMC 12.2Kbps	Right Side	10mm	Ant 0	DSI 2	1413	1732.6	24.52	25.50	1.253	0.01	0.130	0.163	
26	WCDMA IV	-	-	-	-	RMC 12.2Kbps	Bottom Side	10mm	Ant 0	DSI 4	1413	1732.6	22.56	23.50	1.242	-0.09	0.876	1.088	
	WCDMA IV	-	-	-	-	RMC 12.2Kbps	Bottom Side	10mm	Ant 0	DSI 4	1312	1712.4	22.40	23.50	1.288	0.16	0.813	1.047	
	WCDMA IV	-	-	-	-	RMC 12.2Kbps	Bottom Side	10mm	Ant 0	DSI 4	1513	1752.6	22.51	23.50	1.256	0.08	0.821	1.031	
	WCDMA IV	-	-	-	-	RMC 12.2Kbps	Front	15mm	Ant 0	DSI 2	1413	1732.6	24.52	25.50	1.253	0.08	0.242	0.303	
	WCDMA IV	-	-	-	-	RMC 12.2Kbps	Back	20mm	Ant 0	DSI 2	1413	1732.6	24.52	25.50	1.253	0.07	0.697	0.873	
	WCDMA IV	-	-	-	-	RMC 12.2Kbps	Back	20mm	Ant 0	DSI 2	1312	1712.4	24.13	25.50	1.371	0.06	0.625	0.857	
	WCDMA IV	-	-	-	-	RMC 12.2Kbps	Back	20mm	Ant 0	DSI 2	1513	1752.6	24.44	25.50	1.276	0.01	0.643	0.821	
	WCDMA IV	-	-	-	-	RMC 12.2Kbps	Bottom Side	15mm	Ant 0	DSI 2	1413	1732.6	24.52	25.50	1.253	-0.11	0.625	0.783	
	WCDMA IV	-	-	-	-	RMC 12.2Kbps	Front	10mm	Ant 4	DSI 4	1413	1732.6	22.51	23.50	1.256	-0.17	0.145	0.182	
	WCDMA IV	-	-	-	-	RMC 12.2Kbps	Back	10mm	Ant 4	DSI 4	1413	1732.6	22.51	23.50	1.256	-0.07	0.188	0.236	
	WCDMA IV	-	-	-	-	RMC 12.2Kbps	Left Side	10mm	Ant 4	DSI 2	1413	1732.6	23.83	24.50	1.167	0.03	0.160	0.187	
	WCDMA IV	-	-	-	-	RMC 12.2Kbps	Right Side	10mm	Ant 4	DSI 2	1413	1732.6	23.83	24.50	1.167	0.09	0.062	0.072	
	WCDMA IV	-	-	-	-	RMC 12.2Kbps	Top Side	10mm	Ant 4	DSI 4	1413	1732.6	22.51	23.50	1.256	-0.01	0.270	0.339	
	WCDMA IV	-	-	-	-	RMC 12.2Kbps	Front	15mm	Ant 4	DSI 2	1413	1732.6	23.83	24.50	1.167	-0.11	0.114	0.133	
	WCDMA IV	-	-	-	-	RMC 12.2Kbps	Back	20mm	Ant 4	DSI 2	1413	1732.6	23.83	24.50	1.167	0.02	0.075	0.088	
	WCDMA IV	-	-	-	-	RMC 12.2Kbps	Top Side	15mm	Ant 4	DSI 2	1413	1732.6	23.83	24.50	1.167	-0.02	0.173	0.202	
	LTE Band 4	20M	QPSK	1	0	-	Front	10mm	Ant 0	DSI 4	20175	1732.5	21.69	22.50	1.205	0.05	0.157	0.189	
	LTE Band 4	20M	QPSK	50	0	-	Front	10mm	Ant 0	DSI 4	20175	1732.5	21.32	22.50	1.312	-0.18	0.165	0.217	
	LTE Band 4	20M	QPSK	1	0	-	Back	10mm	Ant 0	DSI 4	20175	1732.5	21.69	22.50	1.205	-0.18	0.444	0.535	
	LTE Band 4	20M	QPSK	50	0	-	Back	10mm	Ant 0	DSI 4	20175	1732.5	21.32	22.50	1.312	0.01	0.425	0.558	
	LTE Band 4	20M	QPSK	1	0	-	Left Side	10mm	Ant 0	DSI 2	20175	1732.5	24.25	25.50	1.334	0.08	0.116	0.155	
	LTE Band 4	20M	QPSK	50	0	-	Left Side	10mm	Ant 0	DSI 2	20175	1732.5	23.20	24.50	1.349	0.05	0.094	0.127	
	LTE Band 4	20M	QPSK	1	0	-	Right Side	10mm	Ant 0	DSI 2	20175	1732.5	24.25	25.50	1.334	0.03	0.110	0.147	
	LTE Band 4	20M	QPSK	50	0	-	Right Side	10mm	Ant 0	DSI 2	20175	1732.5	23.20	24.50	1.349	0.08	0.094	0.127	
	LTE Band 4	20M	QPSK	1	0	-	Bottom Side	10mm	Ant 0	DSI 4	20175	1732.5	21.69	22.50	1.205	0.01	0.560	0.675	
	LTE Band 4	20M	QPSK	50	0	-	Bottom Side	10mm	Ant 0	DSI 4	20175	1732.5	21.32	22.50	1.312	-0.09	0.563	0.739	
	LTE Band 4	20M	QPSK	1	0	-	Front	15mm	Ant 0	DSI 2	20175	1732.5	24.25	25.50	1.334	-0.15	0.178	0.237	
	LTE Band 4	20M	QPSK	1	0	-	Back	20mm	Ant 0	DSI 2	20175	1732.5	24.25	25.50	1.334	-0.06	0.318	0.424	
27	LTE Band 4	20M	QPSK	1	0	-	Bottom Side	15mm	Ant 0	DSI 2	20175	1732.5	24.25	25.50	1.334	0.11	0.580	0.773	
	LTE Band 4	20M	QPSK	1	0	-	Front	10mm	Ant 4	DSI 4	20175	1732.5	22.32	23.50	1.312	-0.16	0.088	0.115	
	LTE Band 4	20M	QPSK	50	0	-	Front	10mm	Ant 4	DSI 4	20175	1732.5	22.27	23.50	1.327	-0.1	0.088	0.117	
	LTE Band 4	20M	QPSK	1	0	-	Back	10mm	Ant 4	DSI 4	20175	1732.5	22.32	23.50	1.312	0.05	0.103	0.135	
	LTE Band 4	20M	QPSK	50	0	-	Back	10mm	Ant 4	DSI 4	20175	1732.5	22.27	23.50	1.327	-0.06	0.105	0.139	
	LTE Band 4	20M	QPSK	1	0	-	Left Side	10mm	Ant 4	DSI 2	20175	1732.5	23.46	24.50	1.271	0.16	0.130	0.165	
	LTE Band 4	20M	QPSK	50	0	-	Left Side	10mm	Ant 4	DSI 2	20175	1732.5	22.39	23.50	1.291	0.02	0.105	0.136	
	LTE Band 4	20M	QPSK	1	0	-	Right Side	10mm	Ant 4	DSI 2	20175	1732.5	23.46	24.50	1.271	-0.02	0.047	0.060	
	LTE Band 4	20M	QPSK	50	0	-	Right Side	10mm	Ant 4	DSI 2	20175	1732.5	22.39	23.50	1.291	0.1	0.000	0.000	
	LTE Band 4	20M	QPSK	1	0	-	Top Side	10mm	Ant 4	DSI 4	20175	1732.5	22.32	23.50	1.312	0.04	0.146	0.192	
	LTE Band 4	20M	QPSK	50	0	-	Top Side	10mm	Ant 4	DSI 4	20175	1732.5	22.27	23.50	1.327	-0.13	0.152	0.202	
	LTE Band 4	20M	QPSK	1	0	-	Front	15mm	Ant 4	DSI 2	20175	1732.5	23.46	24.50	1.271	0.03	0.106	0.135	
	LTE Band 4	20M	QPSK	1	0	-	Back	20mm	Ant 4	DSI 2	20175	1732.5	23.46	24.50	1.271	0.07	0.067	0.085	
	LTE Band 4	20M	QPSK	1	0	-	Top Side	15mm	Ant 4	DSI 2	20175	1732.5	23.46	24.50	1.271	-0.09	0.134	0.170	
1900MHz																			
	GSM1900	-	-	-	-	GPRS (4 Tx slots)	Front	10mm	Ant 0	DSI 4	661	1880	23.15	24.50	1.365	0.07	0.265	0.362	
28	GSM1900	-	-	-	-	GPRS (4 Tx slots)	Back	10mm	Ant 0	DSI 4	661	1880	23.15	24.50	1.365	-0.06	0.543	0.741	
	GSM1900	-	-	-	-	GPRS (4 Tx slots)	Left Side	10mm	Ant 0	DSI 2	661	1880	23.52	24.50	1.253	0.19	0.085	0.107	



FCC SAR Test Report

Report No. : FA1N1013-01

	GSM1900	-	-	-	-	GPRS (4 Tx slots)	Right Side	10mm	Ant 0	DSI 2	661	1880	23.52	24.50	1.253	0.09	0.044	0.055
	GSM1900	-	-	-	-	GPRS (4 Tx slots)	Bottom Side	10mm	Ant 0	DSI 4	661	1880	23.15	24.50	1.365	-0.04	0.453	0.618
	GSM1900	-	-	-	-	GPRS (4 Tx slots)	Front	10mm	Ant 4	DSI 4	661	1880	23.17	24.50	1.358	0.02	0.162	0.220
	GSM1900	-	-	-	-	GPRS (4 Tx slots)	Back	10mm	Ant 4	DSI 4	661	1880	23.17	24.50	1.358	0.01	0.213	0.289
	GSM1900	-	-	-	-	GPRS (4 Tx slots)	Left Side	10mm	Ant 4	DSI 2	661	1880	23.10	24.50	1.380	-0.03	0.148	0.204
	GSM1900	-	-	-	-	GPRS (4 Tx slots)	Right Side	10mm	Ant 4	DSI 2	661	1880	23.10	24.50	1.380	0.03	0.065	0.090
	GSM1900	-	-	-	-	GPRS (4 Tx slots)	Top Side	10mm	Ant 4	DSI 4	661	1880	23.17	24.50	1.358	0.04	0.397	0.539
	WCDMA II	-	-	-	-	RMC 12.2Kbps	Front	10mm	Ant 0	DSI 4	9400	1880	21.33	22.50	1.309	-0.14	0.269	0.352
	WCDMA II	-	-	-	-	RMC 12.2Kbps	Back	10mm	Ant 0	DSI 4	9400	1880	21.33	22.50	1.309	0.03	0.546	0.715
	WCDMA II	-	-	-	-	RMC 12.2Kbps	Left Side	10mm	Ant 0	DSI 2	9400	1880	24.43	25.50	1.279	0.09	0.200	0.256
	WCDMA II	-	-	-	-	RMC 12.2Kbps	Right Side	10mm	Ant 0	DSI 2	9400	1880	24.43	25.50	1.279	-0.15	0.097	0.124
29	WCDMA II	-	-	-	-	RMC 12.2Kbps	Bottom Side	10mm	Ant 0	DSI 4	9400	1880	21.33	22.50	1.309	-0.11	0.695	0.910
	WCDMA II	-	-	-	-	RMC 12.2Kbps	Bottom Side	10mm	Ant 0	DSI 4	9262	1852.4	21.30	22.50	1.318	0.16	0.628	0.828
	WCDMA II	-	-	-	-	RMC 12.2Kbps	Bottom Side	10mm	Ant 0	DSI 4	9538	1907.6	21.14	22.50	1.368	0.05	0.643	0.879
	WCDMA II	-	-	-	-	RMC 12.2Kbps	Front	15mm	Ant 0	DSI 2	9400	1880	24.43	25.50	1.279	0.15	0.317	0.406
	WCDMA II	-	-	-	-	RMC 12.2Kbps	Back	20mm	Ant 0	DSI 2	9400	1880	24.43	25.50	1.279	0.06	0.428	0.548
	WCDMA II	-	-	-	-	RMC 12.2Kbps	Bottom Side	15mm	Ant 0	DSI 2	9400	1880	24.43	25.50	1.279	-0.11	0.612	0.783
	WCDMA II	-	-	-	-	RMC 12.2Kbps	Front	10mm	Ant 4	DSI 4	9400	1880	21.42	22.50	1.282	0.07	0.200	0.256
	WCDMA II	-	-	-	-	RMC 12.2Kbps	Back	10mm	Ant 4	DSI 4	9400	1880	21.42	22.50	1.282	0.07	0.275	0.353
	WCDMA II	-	-	-	-	RMC 12.2Kbps	Left Side	10mm	Ant 4	DSI 2	9400	1880	23.36	24.50	1.300	0.08	0.253	0.329
	WCDMA II	-	-	-	-	RMC 12.2Kbps	Right Side	10mm	Ant 4	DSI 2	9400	1880	23.36	24.50	1.300	-0.15	0.112	0.146
	WCDMA II	-	-	-	-	RMC 12.2Kbps	Top Side	10mm	Ant 4	DSI 4	9400	1880	21.42	22.50	1.282	0.02	0.438	0.562
	WCDMA II	-	-	-	-	RMC 12.2Kbps	Front	15mm	Ant 4	DSI 2	9400	1880	23.36	24.50	1.300	0.19	0.177	0.230
	WCDMA II	-	-	-	-	RMC 12.2Kbps	Back	20mm	Ant 4	DSI 2	9400	1880	23.36	24.50	1.300	-0.09	0.165	0.215
	WCDMA II	-	-	-	-	RMC 12.2Kbps	Top Side	15mm	Ant 4	DSI 2	9400	1880	23.36	24.50	1.300	0.16	0.389	0.506
	LTE Band 2	20M	QPSK	1	0	-	Front	10mm	Ant 0	DSI 4	18900	1880	19.66	20.50	1.213	-0.04	0.190	0.231
	LTE Band 2	20M	QPSK	50	0	-	Front	10mm	Ant 0	DSI 4	18900	1880	19.46	20.50	1.271	-0.15	0.197	0.250
	LTE Band 2	20M	QPSK	1	0	-	Back	10mm	Ant 0	DSI 4	18900	1880	19.66	20.50	1.213	-0.17	0.412	0.500
	LTE Band 2	20M	QPSK	50	0	-	Back	10mm	Ant 0	DSI 4	18900	1880	19.46	20.50	1.271	0.06	0.420	0.534
	LTE Band 2	20M	QPSK	1	0	-	Left Side	10mm	Ant 0	DSI 2	18900	1880	23.31	24.50	1.315	0.03	0.186	0.245
	LTE Band 2	20M	QPSK	50	0	-	Left Side	10mm	Ant 0	DSI 2	18900	1880	22.29	23.50	1.321	0.17	0.148	0.196
	LTE Band 2	20M	QPSK	1	0	-	Right Side	10mm	Ant 0	DSI 2	18900	1880	23.31	24.50	1.315	-0.09	0.096	0.126
	LTE Band 2	20M	QPSK	50	0	-	Right Side	10mm	Ant 0	DSI 2	18900	1880	22.29	23.50	1.321	0.02	0.077	0.102
	LTE Band 2	20M	QPSK	1	0	-	Bottom Side	10mm	Ant 0	DSI 4	18900	1880	19.66	20.50	1.213	0.05	0.498	0.604
	LTE Band 2	20M	QPSK	50	0	-	Bottom Side	10mm	Ant 0	DSI 4	18900	1880	19.46	20.50	1.271	0.03	0.498	0.633
	LTE Band 2	20M	QPSK	1	0	-	Front	15mm	Ant 0	DSI 2	18900	1880	23.31	24.50	1.315	0.03	0.257	0.338
	LTE Band 2	20M	QPSK	1	0	-	Back	20mm	Ant 0	DSI 2	18900	1880	23.31	24.50	1.315	0.07	0.405	0.533
30	LTE Band 2	20M	QPSK	1	0	-	Bottom Side	15mm	Ant 0	DSI 2	18900	1880	23.31	24.50	1.315	0.05	0.604	0.794
	LTE Band 2	20M	QPSK	1	0	-	Front	10mm	Ant 4	DSI 4	18900	1880	20.22	21.00	1.197	0.07	0.156	0.187
	LTE Band 2	20M	QPSK	50	0	-	Front	10mm	Ant 4	DSI 4	18900	1880	20.19	21.00	1.205	-0.09	0.156	0.188
	LTE Band 2	20M	QPSK	1	0	-	Back	10mm	Ant 4	DSI 4	18900	1880	20.22	21.00	1.197	-0.04	0.202	0.242
	LTE Band 2	20M	QPSK	50	0	-	Back	10mm	Ant 4	DSI 4	18900	1880	20.19	21.00	1.205	0.1	0.208	0.251
	LTE Band 2	20M	QPSK	1	0	-	Left Side	10mm	Ant 4	DSI 2	18900	1880	22.53	23.50	1.250	0.03	0.182	0.228
	LTE Band 2	20M	QPSK	50	0	-	Left Side	10mm	Ant 4	DSI 2	18900	1880	21.38	22.50	1.294	-0.02	0.171	0.221
	LTE Band 2	20M	QPSK	1	0	-	Right Side	10mm	Ant 4	DSI 2	18900	1880	22.53	23.50	1.250	0.07	0.091	0.114
	LTE Band 2	20M	QPSK	50	0	-	Right Side	10mm	Ant 4	DSI 2	18900	1880	21.38	22.50	1.294	0.06	0.137	0.177
	LTE Band 2	20M	QPSK	1	0	-	Top Side	10mm	Ant 4	DSI 4	18900	1880	20.22	21.00	1.197	0.03	0.297	0.355
	LTE Band 2	20M	QPSK	50	0	-	Top Side	10mm	Ant 4	DSI 4	18900	1880	20.19	21.00	1.205	-0.02	0.310	0.374
	LTE Band 2	20M	QPSK	1	0	-	Front	15mm	Ant 4	DSI 2	18900	1880	22.53	23.50	1.250	0.05	0.152	0.190
	LTE Band 2	20M	QPSK	1	0	-	Back	20mm	Ant 4	DSI 2	18900	1880	22.53	23.50	1.250	-0.16	0.103	0.129
	LTE Band 2	20M	QPSK	1	0	-	Top Side	15mm	Ant 4	DSI 2	18900	1880	22.53	23.50	1.250	0.06	0.273	0.341



FCC SAR Test Report

Report No. : FA1N1013-01

Plot No.	Band	BW (MHz)	Modulation	RB Size	RB offset	Mode	Test Position	Gap (mm)	Antenna	Power State	Ch.	Freq. (MHz)	Average Power (dBm)	Tune-Up Limit (dBm)	Tune-up Scaling Factor	Duty Cycle %	Duty Cycle Scaling Factor	Power Drift (dB)	Measured 1g SAR (W/kg)	Reported 1g SAR (W/kg)
2600MHz																				
	LTE Band 7	20M	QPSK	1	0	-	Front	10mm	Ant 0	DSI 4	21100	2535	20.19	21.00	1.205	-	-	-0.14	0.099	0.119
	LTE Band 7	20M	QPSK	50	0	-	Front	10mm	Ant 0	DSI 4	21100	2535	20.17	21.00	1.211	-	-	0.07	0.104	0.126
	LTE Band 7	20M	QPSK	1	0	-	Back	10mm	Ant 0	DSI 4	21100	2535	20.19	21.00	1.205	-	-	0.05	0.243	0.293
	LTE Band 7	20M	QPSK	50	0	-	Back	10mm	Ant 0	DSI 4	21100	2535	20.17	21.00	1.211	-	-	-0.15	0.243	0.294
	LTE Band 7	20M	QPSK	1	0	-	Left Side	10mm	Ant 0	DSI 2	21100	2535	24.39	25.50	1.291	-	-	-0.14	0.118	0.152
	LTE Band 7	20M	QPSK	50	0	-	Left Side	10mm	Ant 0	DSI 2	21100	2535	23.56	24.50	1.242	-	-	0.1	0.100	0.124
	LTE Band 7	20M	QPSK	1	0	-	Right Side	10mm	Ant 0	DSI 2	21100	2535	24.39	25.50	1.291	-	-	0.06	0.087	0.112
	LTE Band 7	20M	QPSK	50	0	-	Right Side	10mm	Ant 0	DSI 2	21100	2535	23.56	24.50	1.242	-	-	0.18	0.070	0.087
	LTE Band 7	20M	QPSK	1	0	-	Bottom Side	10mm	Ant 0	DSI 4	21100	2535	20.19	21.00	1.205	-	-	-0.02	0.174	0.210
	LTE Band 7	20M	QPSK	50	0	-	Bottom Side	10mm	Ant 0	DSI 4	21100	2535	20.17	21.00	1.211	-	-	0.09	0.182	0.220
	LTE Band 7	20M	QPSK	1	0	-	Front	15mm	Ant 0	DSI 2	21100	2535	24.39	25.50	1.291	-	-	0.06	0.154	0.199
	LTE Band 7	20M	QPSK	1	0	-	Back	20mm	Ant 0	DSI 2	21100	2535	24.39	25.50	1.291	-	-	0.14	0.161	0.208
	LTE Band 7	20M	QPSK	1	0	-	Bottom Side	15mm	Ant 0	DSI 2	21100	2535	24.39	25.50	1.291	-	-	-0.01	0.281	0.363
	LTE Band 7C	20M	QPSK	1	0	-	Bottom Side	15mm	Ant 0	DSI 2	21100+21298	2535+2554.8	24.27	25.50	1.327	-	-	0.03	0.245	0.325
	LTE Band 7	20M	QPSK	1	0	-	Front	10mm	Ant 4	DSI 4	21100	2535	19.77	20.50	1.183	-	-	0.03	0.155	0.183
	LTE Band 7	20M	QPSK	50	0	-	Front	10mm	Ant 4	DSI 4	21100	2535	19.74	20.50	1.191	-	-	0.08	0.161	0.192
	LTE Band 7	20M	QPSK	1	0	-	Back	10mm	Ant 4	DSI 4	21100	2535	19.77	20.50	1.183	-	-	-0.05	0.225	0.266
	LTE Band 7	20M	QPSK	50	0	-	Back	10mm	Ant 4	DSI 4	21100	2535	19.74	20.50	1.191	-	-	0.03	0.233	0.278
	LTE Band 7	20M	QPSK	1	0	-	Left Side	10mm	Ant 4	DSI 2	21100	2535	22.67	23.50	1.211	-	-	-0.07	0.354	0.429
	LTE Band 7	20M	QPSK	50	0	-	Left Side	10mm	Ant 4	DSI 2	21100	2535	21.65	22.50	1.216	-	-	-0.04	0.290	0.353
	LTE Band 7	20M	QPSK	1	0	-	Right Side	10mm	Ant 4	DSI 2	21100	2535	22.67	23.50	1.211	-	-	-0.13	0.087	0.105
	LTE Band 7	20M	QPSK	50	0	-	Right Side	10mm	Ant 4	DSI 2	21100	2535	21.65	22.50	1.216	-	-	0.09	0.071	0.086
	LTE Band 7	20M	QPSK	1	0	-	Top Side	10mm	Ant 4	DSI 4	21100	2535	19.77	20.50	1.183	-	-	-0.06	0.407	0.481
	LTE Band 7	20M	QPSK	50	0	-	Top Side	10mm	Ant 4	DSI 4	21100	2535	19.74	20.50	1.191	-	-	0.06	0.413	0.492
	LTE Band 7	20M	QPSK	1	0	-	Front	15mm	Ant 4	DSI 2	21100	2535	22.67	23.50	1.211	-	-	0.07	0.155	0.188
	LTE Band 7	20M	QPSK	1	0	-	Back	20mm	Ant 4	DSI 2	21100	2535	22.67	23.50	1.211	-	-	0.14	0.123	0.149
31	LTE Band 7	20M	QPSK	1	0	-	Top Side	15mm	Ant 4	DSI 2	21100	2535	22.67	23.50	1.211	-	-	-0.05	0.457	0.553
	LTE Band 7C	20M	QPSK	1	0	-	Top Side	15mm	Ant 4	DSI 2	21100+21298	2535+2554.8	22.58	23.50	1.236	-	-	0.03	0.425	0.525
	LTE Band 41	20M	QPSK	1	0	-	Front	10mm	Ant 0	DSI 4	40620	2593	22.15	23.00	1.216	62.9	1.006	0.1	0.190	0.232
	LTE Band 41	20M	QPSK	50	0	-	Front	10mm	Ant 0	DSI 4	40620	2593	22.01	23.00	1.256	62.9	1.006	0.19	0.193	0.244
	LTE Band 41	20M	QPSK	1	0	-	Back	10mm	Ant 0	DSI 4	40620	2593	22.15	23.00	1.216	62.9	1.006	0.04	0.403	0.493
	LTE Band 41	20M	QPSK	50	0	-	Back	10mm	Ant 0	DSI 4	40620	2593	22.01	23.00	1.256	62.9	1.006	-0.16	0.410	0.518
	LTE Band 41C	20M	QPSK	50	0	-	Back	10mm	Ant 0	DSI 4	40620+40818	2593+2612.8	21.89	23.00	1.291	62.9	1.006	0.04	0.375	0.487
	LTE Band 41	20M	QPSK	1	0	-	Left Side	10mm	Ant 0	DSI 2	40620	2593	24.68	25.50	1.208	62.9	1.006	0.03	0.099	0.120
	LTE Band 41	20M	QPSK	50	0	-	Left Side	10mm	Ant 0	DSI 2	40620	2593	23.81	24.50	1.172	62.9	1.006	-0.09	0.074	0.087
	LTE Band 41	20M	QPSK	1	0	-	Right Side	10mm	Ant 0	DSI 2	40620	2593	24.68	25.50	1.208	62.9	1.006	0.04	0.065	0.079
	LTE Band 41	20M	QPSK	50	0	-	Right Side	10mm	Ant 0	DSI 2	40620	2593	23.81	24.50	1.172	62.9	1.006	0.02	0.057	0.067
	LTE Band 41	20M	QPSK	1	0	-	Bottom Side	10mm	Ant 0	DSI 4	40620	2593	22.15	23.00	1.216	62.9	1.006	0.03	0.297	0.363
	LTE Band 41	20M	QPSK	50	0	-	Bottom Side	10mm	Ant 0	DSI 4	40620	2593	22.01	23.00	1.256	62.9	1.006	0.02	0.309	0.390
	LTE Band 41	20M	QPSK	1	0	-	Front	15mm	Ant 0	DSI 2	40620	2593	24.68	25.50	1.208	62.9	1.006	-0.11	0.128	0.156
	LTE Band 41	20M	QPSK	1	0	-	Back	20mm	Ant 0	DSI 2	40620	2593	24.68	25.50	1.208	62.9	1.006	0.18	0.105	0.128
	LTE Band 41	20M	QPSK	1	0	-	Bottom Side	15mm	Ant 0	DSI 2	40620	2593	24.68	25.50	1.208	62.9	1.006	0.06	0.219	0.266
	LTE Band 41	20M	QPSK	1	0	-	Front	10mm	Ant 4	DSI 4	40620	2593	21.62	22.00	1.091	62.9	1.006	0.06	0.189	0.208
	LTE Band 41	20M	QPSK	50	0	-	Front	10mm	Ant 4	DSI 4	40620	2593	20.68	22.00	1.355	62.9	1.006	0.07	0.158	0.215
	LTE Band 41	20M	QPSK	1	0	-	Back	10mm	Ant 4	DSI 4	40620	2593	21.62	22.00	1.091	62.9	1.006	0.03	0.314	0.345
	LTE Band 41	20M	QPSK	50	0	-	Back	10mm	Ant 4	DSI 4	40620	2593	20.68	22.00	1.355	62.9	1.006	0.15	0.260	0.354
	LTE Band 41	20M	QPSK	1	0	-	Left Side	10mm	Ant 4	DSI 2	40620	2593	22.89	23.50	1.151	62.9	1.006	-0.03	0.195	0.226
	LTE Band 41	20M	QPSK	50	0	-	Left Side	10mm	Ant 4	DSI 2	40620	2593	21.88	22.50	1.153	62.9	1.006	-0.16	0.164	0.190
	LTE Band 41	20M	QPSK	1	0	-	Right Side	10mm	Ant 4	DSI 2	40620	2593	22.89	23.50	1.151	62.9	1.006	0.11	0.048	0.056
	LTE Band 41	20M	QPSK	50	0	-	Right Side	10mm	Ant 4	DSI 2	40620	2593	21.88	22.50	1.153	62.9	1.006	0.01	0.000	0.000
32	LTE Band 41	20M	QPSK	1	0	-	Top Side	10mm	Ant 4	DSI 4	40620	2593	21.62	22.00	1.091	62.9	1.006	-0.06	0.520	0.571
	LTE Band 41C	20M	QPSK	1	0	-	Top Side	10mm	Ant 4	DSI 4	40620+40818	2593+2612.8	21.44	22.00	1.138	62.9	1.006	0.13	0.497	0.569

Sporton International (Kunshan) Inc.

TEL : 86-512-57900158 / FAX : 86-512-57900958

FCC ID : 2AFZZ16PG

Issued Date : Jan. 05, 2022

Form version. : 200414



FCC SAR Test Report

Report No. : FA1N1013-01

	LTE Band 41	20M	QPSK	50	0	-	Top Side	10mm	Ant 4	DSI 4	40620	2593	20.68	22.00	1.355	62.9	1.006	0.06	0.411	0.560
	LTE Band 41	20M	QPSK	1	0	-	Front	15mm	Ant 4	DSI 2	40620	2593	22.89	23.50	1.151	62.9	1.006	-0.02	0.098	0.113
	LTE Band 41	20M	QPSK	1	0	-	Back	20mm	Ant 4	DSI 2	40620	2593	22.89	23.50	1.151	62.9	1.006	-0.1	0.103	0.119
	LTE Band 41	20M	QPSK	1	0	-	Top Side	15mm	Ant 4	DSI 2	40620	2593	22.89	23.50	1.151	62.9	1.006	0.04	0.268	0.310
	FR1 n7	20M	QPSK	1	1	DFT-15	Front	10mm	Ant 0	DSI 4	507000	2535	18.83	19.50	1.167	-	-	0.03	0.056	0.065
	FR1 n7	20M	QPSK	50	28	DFT-15	Front	10mm	Ant 0	DSI 4	507000	2535	18.59	19.50	1.233	-	-	-0.1	0.056	0.069
	FR1 n7	20M	QPSK	1	1	DFT-15	Back	10mm	Ant 0	DSI 4	507000	2535	18.83	19.50	1.167	-	-	-0.06	0.131	0.153
	FR1 n7	20M	QPSK	50	28	DFT-15	Back	10mm	Ant 0	DSI 4	507000	2535	18.59	19.50	1.233	-	-	0.13	0.122	0.150
	FR1 n7	20M	QPSK	1	1	DFT-15	Left Side	10mm	Ant 0	DSI 2	507000	2535	24.85	25.50	1.161	-	-	0.11	0.025	0.029
	FR1 n7	20M	QPSK	50	28	DFT-15	Left Side	10mm	Ant 0	DSI 2	507000	2535	24.84	25.50	1.164	-	-	-0.09	0.023	0.027
	FR1 n7	20M	QPSK	1	1	DFT-15	Right Side	10mm	Ant 0	DSI 2	507000	2535	24.85	25.50	1.161	-	-	-0.05	0.000	0.000
	FR1 n7	20M	QPSK	50	28	DFT-15	Right Side	10mm	Ant 0	DSI 2	507000	2535	24.84	25.50	1.164	-	-	0.15	0.000	0.000
	FR1 n7	20M	QPSK	1	1	DFT-15	Bottom Side	10mm	Ant 0	DSI 4	507000	2535	18.83	19.50	1.167	-	-	-0.12	0.093	0.109
	FR1 n7	20M	QPSK	50	28	DFT-15	Bottom Side	10mm	Ant 0	DSI 4	507000	2535	18.59	19.50	1.233	-	-	0.18	0.088	0.109
	FR1 n7	20M	QPSK	1	1	DFT-15	Front	15mm	Ant 0	DSI 2	507000	2535	24.85	25.50	1.161	-	-	0.02	0.029	0.034
	FR1 n7	20M	QPSK	1	1	DFT-15	Back	20mm	Ant 0	DSI 2	507000	2535	24.85	25.50	1.161	-	-	-0.03	0.061	0.071
	FR1 n7	20M	QPSK	1	1	DFT-15	Bottom Side	15mm	Ant 0	DSI 2	507000	2535	24.85	25.50	1.161	-	-	-0.02	0.049	0.057
	FR1 n7	20M	QPSK	1	1	DFT-15	Front	10mm	Ant 4	DSI 4	507000	2535	19.64	21.00	1.368	-	-	0.17	0.200	0.274
	FR1 n7	20M	QPSK	50	28	DFT-15	Front	10mm	Ant 4	DSI 4	507000	2535	19.49	21.00	1.416	-	-	0.04	0.193	0.273
	FR1 n7	20M	QPSK	1	1	DFT-15	Back	10mm	Ant 4	DSI 4	507000	2535	19.64	21.00	1.368	-	-	-0.09	0.275	0.376
	FR1 n7	20M	QPSK	50	28	DFT-15	Back	10mm	Ant 4	DSI 4	507000	2535	19.49	21.00	1.416	-	-	0.14	0.278	0.394
	FR1 n7	20M	QPSK	1	1	DFT-15	Left Side	10mm	Ant 4	DSI 2	507000	2535	23.34	24.50	1.306	-	-	0.08	0.230	0.300
	FR1 n7	20M	QPSK	50	28	DFT-15	Left Side	10mm	Ant 4	DSI 2	507000	2535	23.28	24.50	1.324	-	-	0.18	0.234	0.310
	FR1 n7	20M	QPSK	1	1	DFT-15	Right Side	10mm	Ant 4	DSI 2	507000	2535	23.34	24.50	1.306	-	-	0.08	0.000	0.000
	FR1 n7	20M	QPSK	50	28	DFT-15	Right Side	10mm	Ant 4	DSI 2	507000	2535	23.28	24.50	1.324	-	-	0.18	0.000	0.000
33	FR1 n7	20M	QPSK	1	1	DFT-15	Top Side	10mm	Ant 4	DSI 4	507000	2535	19.64	21.00	1.368	-	-	0.02	0.578	0.791
	FR1 n7	20M	QPSK	50	28	DFT-15	Top Side	10mm	Ant 4	DSI 4	507000	2535	19.49	21.00	1.416	-	-	0.02	0.549	0.777
	FR1 n7	20M	QPSK	1	1	DFT-15	Front	15mm	Ant 4	DSI 2	507000	2535	23.34	24.50	1.306	-	-	0.15	0.102	0.133
	FR1 n7	20M	QPSK	1	1	DFT-15	Back	20mm	Ant 4	DSI 2	507000	2535	23.34	24.50	1.306	-	-	0.08	0.095	0.124
	FR1 n7	20M	QPSK	1	1	DFT-15	Top Side	15mm	Ant 4	DSI 2	507000	2535	23.34	24.50	1.306	-	-	0.05	0.333	0.435
	FR1 n41	100M	QPSK	1	1	DFT-30	Front	10mm	Ant 0	DSI 4	518598	2592.99	18.65	19.50	1.216	-	-	0.06	0.066	0.080
	FR1 n41	100M	QPSK	135	69	DFT-30	Front	10mm	Ant 0	DSI 4	518598	2592.99	18.53	19.50	1.250	-	-	0.08	0.063	0.079
	FR1 n41	100M	QPSK	1	1	DFT-30	Back	10mm	Ant 0	DSI 4	518598	2592.99	18.65	19.50	1.216	-	-	0.16	0.143	0.174
	FR1 n41	100M	QPSK	135	69	DFT-30	Back	10mm	Ant 0	DSI 4	518598	2592.99	18.53	19.50	1.250	-	-	0.05	0.139	0.174
	FR1 n41	100M	QPSK	1	1	DFT-30	Left Side	10mm	Ant 0	DSI 2	518598	2592.99	26.16	27.00	1.213	-	-	-0.06	0.182	0.221
	FR1 n41	100M	QPSK	135	69	DFT-30	Left Side	10mm	Ant 0	DSI 2	518598	2592.99	26.02	27.00	1.253	-	-	0.19	0.185	0.232
	FR1 n41	100M	QPSK	1	1	DFT-30	Right Side	10mm	Ant 0	DSI 2	518598	2592.99	26.16	27.00	1.213	-	-	0.07	0.112	0.136
	FR1 n41	100M	QPSK	135	69	DFT-30	Right Side	10mm	Ant 0	DSI 2	518598	2592.99	26.02	27.00	1.253	-	-	0.13	0.097	0.122
	FR1 n41	100M	QPSK	1	1	DFT-30	Bottom Side	10mm	Ant 0	DSI 4	518598	2592.99	18.65	19.50	1.216	-	-	0.02	0.113	0.137
	FR1 n41	100M	QPSK	135	69	DFT-30	Bottom Side	10mm	Ant 0	DSI 4	518598	2592.99	18.53	19.50	1.250	-	-	-0.12	0.093	0.116
	FR1 n41	100M	QPSK	1	1	DFT-30	Front	15mm	Ant 0	DSI 2	518598	2592.99	26.16	27.00	1.213	-	-	0.04	0.262	0.318
	FR1 n41	100M	QPSK	1	1	DFT-30	Back	20mm	Ant 0	DSI 2	518598	2592.99	26.16	27.00	1.213	-	-	-0.09	0.258	0.313
	FR1 n41	100M	QPSK	1	1	DFT-30	Bottom Side	15mm	Ant 0	DSI 2	518598	2592.99	26.16	27.00	1.213	-	-	0.13	0.402	0.488
	FR1 n41	100M	QPSK	1	1	DFT-30	Front	10mm	Ant 4	DSI 4	518598	2592.99	19.64	21.00	1.368	-	-	-0.1	0.187	0.256
	FR1 n41	100M	QPSK	135	69	DFT-30	Front	10mm	Ant 4	DSI 4	518598	2592.99	19.62	21.00	1.374	-	-	-0.13	0.156	0.214
	FR1 n41	100M	QPSK	1	1	DFT-30	Back	10mm	Ant 4	DSI 4	518598	2592.99	19.64	21.00	1.368	-	-	-0.12	0.262	0.358
	FR1 n41	100M	QPSK	135	69	DFT-30	Back	10mm	Ant 4	DSI 4	518598	2592.99	19.62	21.00	1.374	-	-	-0.09	0.241	0.331
	FR1 n41	100M	QPSK	1	1	DFT-30	Left Side	10mm	Ant 4	DSI 2	518598	2592.99	24.44	26.00	1.432	-	-	0.16	0.326	0.467
	FR1 n41	100M	QPSK	135	69	DFT-30	Left Side	10mm	Ant 4	DSI 2	518598	2592.99	24.39	25.00	1.151	-	-	0.04	0.313	0.360
	FR1 n41	100M	QPSK	1	1	DFT-30	Right Side	10mm	Ant 4	DSI 2	518598	2592.99	24.44	26.00	1.432	-	-	0.16	0.066	0.095
	FR1 n41	100M	QPSK	135	69	DFT-30	Right Side	10mm	Ant 4	DSI 2	518598	2592.99	24.39	25.00	1.151	-	-	-0.17	0.068	0.078
	FR1 n41	100M	QPSK	1	1	DFT-30	Top Side	10mm	Ant 4	DSI 4	518598	2592.99	19.64	21.00	1.368	-	-	-0.12	0.430	0.588
34	FR1 n41	100M	QPSK	135	69	DFT-30	Top Side	10mm	Ant 4	DSI 4	518598	2592.99	19.62	21.00	1.374	-	-	0.06	0.433	0.595
	FR1 n41	100M	QPSK	1	1	DFT-30	Front	15mm	Ant 4	DSI 2	518598	2592.99	24.44	26.00	1.432	-	-	-0.13	0.170	0.243
	FR1 n41	100M	QPSK	1	1	DFT-30	Back	20mm	Ant 4	DSI 2	518598	2592.99	24.44	26.00	1.432	-	-	-0.13	0.155	0.222
	FR1 n41	100M	QPSK	1	1	DFT-30	Top Side	15mm	Ant 4	DSI 2	518598	2592.99	24.44	26.00	1.432	-	-	0.11	0.407	0.583



Plot No.	Band	BW (MHz)	Modulation	RB Size	RB offset	Mode	Test Position	Gap (mm)	Antenna	Power State	Ch.	Freq. (MHz)	Average Power (dBm)	Tune-Up Limit (dBm)	Tune-up Scaling Factor	Power Drift (dB)	Measured 1g SAR (W/kg)	Reported 1g SAR (W/kg)
3500MHz																		
	FR1 n77	100M	QPSK	1	1	DFT-30	Front	10mm	Ant 3	DSI 4	656000	3840	15.72	17.00	1.343	0.02	0.153	0.205
	FR1 n77	100M	QPSK	135	69	DFT-30	Front	10mm	Ant 3	DSI 4	656000	3840	15.66	17.00	1.361	0.11	0.147	0.200
	FR1 n77	100M	QPSK	1	1	DFT-30	Back	10mm	Ant 3	DSI 4	656000	3840	15.72	17.00	1.343	-0.03	0.245	0.329
	FR1 n77	100M	QPSK	135	69	DFT-30	Back	10mm	Ant 3	DSI 4	656000	3840	15.66	17.00	1.361	0.09	0.233	0.317
	FR1 n77	100M	QPSK	1	1	DFT-30	Left Side	10mm	Ant 3	DSI 2	656000	3840	15.72	17.00	1.343	-0.1	0.213	0.286
	FR1 n77	100M	QPSK	135	69	DFT-30	Left Side	10mm	Ant 3	DSI 2	656000	3840	15.66	17.00	1.361	0.17	0.222	0.302
	FR1 n77	100M	QPSK	1	1	DFT-30	Right Side	10mm	Ant 3	DSI 2	656000	3840	15.72	17.00	1.343	0.15	0.008	0.011
	FR1 n77	100M	QPSK	135	69	DFT-30	Right Side	10mm	Ant 3	DSI 2	656000	3840	15.66	17.00	1.361	-0.09	0.008	0.011
	FR1 n77	100M	QPSK	1	1	DFT-30	Top Side	10mm	Ant 3	DSI 4	656000	3840	15.72	17.00	1.343	-0.18	0.076	0.102
	FR1 n77	100M	QPSK	135	69	DFT-30	Top Side	10mm	Ant 3	DSI 4	656000	3840	15.66	17.00	1.361	0.04	0.054	0.074
	FR1 n77	100M	QPSK	1	1	DFT-30	Front	10mm	Ant 3	DSI 4	633334	3500.01	15.62	17.00	1.374	0.01	0.163	0.224
	FR1 n77	100M	QPSK	135	69	DFT-30	Front	10mm	Ant 3	DSI 4	633334	3500.01	15.52	17.00	1.406	-0.15	0.169	0.238
	FR1 n77	100M	QPSK	1	1	DFT-30	Back	10mm	Ant 3	DSI 4	633334	3500.01	15.62	17.00	1.374	-0.1	0.181	0.249
	FR1 n77	100M	QPSK	135	69	DFT-30	Back	10mm	Ant 3	DSI 4	633334	3500.01	15.52	17.00	1.406	0.12	0.192	0.270
	FR1 n77	100M	QPSK	1	1	DFT-30	Left Side	10mm	Ant 3	DSI 2	633334	3500.01	15.62	17.00	1.374	-0.02	0.298	0.409
35	FR1 n77	100M	QPSK	135	69	DFT-30	Left Side	10mm	Ant 3	DSI 2	633334	3500.01	15.52	17.00	1.406	0.07	0.306	0.430
	FR1 n77	100M	QPSK	1	1	DFT-30	Right Side	10mm	Ant 3	DSI 2	633334	3500.01	15.62	17.00	1.374	0.03	0.002	0.003
	FR1 n77	100M	QPSK	135	69	DFT-30	Right Side	10mm	Ant 3	DSI 2	633334	3500.01	15.52	17.00	1.406	-0.19	0.002	0.003
	FR1 n77	100M	QPSK	1	1	DFT-30	Top Side	10mm	Ant 3	DSI 4	633334	3500.01	15.62	17.00	1.374	0.12	0.016	0.022
	FR1 n77	100M	QPSK	135	69	DFT-30	Top Side	10mm	Ant 3	DSI 4	633334	3500.01	15.52	17.00	1.406	0.02	0.020	0.028
	FR1 n77	100M	QPSK	1	1	DFT-30	Front	10mm	Ant 5	DSI 4	656000	3840	16.71	17.00	1.069	0.04	0.103	0.110
	FR1 n77	100M	QPSK	135	69	DFT-30	Front	10mm	Ant 5	DSI 4	656000	3840	16.61	17.00	1.094	-0.01	0.103	0.113
	FR1 n77	100M	QPSK	1	1	DFT-30	Back	10mm	Ant 5	DSI 4	656000	3840	16.71	17.00	1.069	0.02	0.149	0.159
	FR1 n77	100M	QPSK	135	69	DFT-30	Back	10mm	Ant 5	DSI 4	656000	3840	16.61	17.00	1.094	-0.03	0.153	0.167
	FR1 n77	100M	QPSK	1	1	DFT-30	Left Side	10mm	Ant 5	DSI 2	656000	3840	23.61	24.00	1.094	0.05	0.019	0.021
	FR1 n77	100M	QPSK	135	69	DFT-30	Left Side	10mm	Ant 5	DSI 2	656000	3840	23.25	24.00	1.189	0.09	0.026	0.031
	FR1 n77	100M	QPSK	1	1	DFT-30	Right Side	10mm	Ant 5	DSI 2	656000	3840	23.61	24.00	1.094	-0.17	0.054	0.059
	FR1 n77	100M	QPSK	135	69	DFT-30	Right Side	10mm	Ant 5	DSI 2	656000	3840	23.25	24.00	1.189	-0.17	0.061	0.072
	FR1 n77	100M	QPSK	1	1	DFT-30	Top Side	10mm	Ant 5	DSI 4	656000	3840	16.71	17.00	1.069	0.09	0.155	0.166
	FR1 n77	100M	QPSK	135	69	DFT-30	Top Side	10mm	Ant 5	DSI 4	656000	3840	16.61	17.00	1.094	0.02	0.152	0.166
	FR1 n77	100M	QPSK	1	1	DFT-30	Front	15mm	Ant 5	DSI 2	656000	3840	23.61	24.00	1.094	0.07	0.054	0.059
	FR1 n77	100M	QPSK	1	1	DFT-30	Back	20mm	Ant 5	DSI 2	656000	3840	23.61	24.00	1.094	-0.06	0.195	0.213
	FR1 n77	100M	QPSK	1	1	DFT-30	Top Side	15mm	Ant 5	DSI 2	656000	3840	23.61	24.00	1.094	-0.05	0.081	0.089
	FR1 n77	100M	QPSK	1	1	DFT-30	Front	10mm	Ant 5	DSI 4	633334	3500.01	16.59	17.00	1.099	0.14	0.118	0.130
	FR1 n77	100M	QPSK	135	69	DFT-30	Front	10mm	Ant 5	DSI 4	633334	3500.01	16.53	17.00	1.114	0.09	0.133	0.148
	FR1 n77	100M	QPSK	1	1	DFT-30	Back	10mm	Ant 5	DSI 4	633334	3500.01	16.59	17.00	1.099	0.08	0.208	0.229
	FR1 n77	100M	QPSK	135	69	DFT-30	Back	10mm	Ant 5	DSI 4	633334	3500.01	16.53	17.00	1.114	-0.01	0.214	0.238
	FR1 n77	100M	QPSK	1	1	DFT-30	Left Side	10mm	Ant 5	DSI 2	633334	3500.01	23.52	24.00	1.117	0.02	0.000	0.000
	FR1 n77	100M	QPSK	135	69	DFT-30	Left Side	10mm	Ant 5	DSI 2	633334	3500.01	23.16	24.00	1.213	-0.11	0.000	0.000
	FR1 n77	100M	QPSK	1	1	DFT-30	Right Side	10mm	Ant 5	DSI 2	633334	3500.01	23.52	24.00	1.117	0.04	0.098	0.109
	FR1 n77	100M	QPSK	135	69	DFT-30	Right Side	10mm	Ant 5	DSI 2	633334	3500.01	23.16	24.00	1.213	-0.18	0.096	0.116
	FR1 n77	100M	QPSK	1	1	DFT-30	Top Side	10mm	Ant 5	DSI 4	633334	3500.01	16.59	17.00	1.099	0.05	0.178	0.196
	FR1 n77	100M	QPSK	135	69	DFT-30	Top Side	10mm	Ant 5	DSI 4	633334	3500.01	16.53	17.00	1.114	-0.02	0.207	0.231
	FR1 n77	100M	QPSK	1	1	DFT-30	Front	15mm	Ant 5	DSI 2	633334	3500.01	23.52	24.00	1.117	-0.14	0.063	0.070
	FR1 n77	100M	QPSK	1	1	DFT-30	Back	20mm	Ant 5	DSI 2	633334	3500.01	23.52	24.00	1.117	0.07	0.257	0.287
	FR1 n77	100M	QPSK	1	1	DFT-30	Top Side	15mm	Ant 5	DSI 2	633334	3500.01	23.52	24.00	1.117	-0.14	0.091	0.102



Plot No.	Band	Mode	Test Position	Gap (mm)	Antenna	Power State	Ch.	Freq. (MHz)	Average Power (dBm)	Tune-Up Limit (dBm)	Tune-up Scaling Factor	Duty Cycle %	Duty Cycle Scaling Factor	Power Drift (dB)	Measured 1g SAR (W/kg)	Reported 1g SAR (W/kg)
2450MHz																
	WLAN 2.4GHz	802.11b 1Mbps	Front	10mm	ANT 6	Full power	6	2437	19.09	20.50	1.384	99.3	1.007	0.08	0.155	0.216
36	WLAN 2.4GHz	802.11b 1Mbps	Back	10mm	ANT 6	Full power	6	2437	19.09	20.50	1.384	99.3	1.007	0.1	0.175	0.244
	WLAN 2.4GHz	802.11b 1Mbps	Right Side	10mm	ANT 6	Full power	6	2437	19.09	20.50	1.384	99.3	1.007	0.02	0.165	0.230
	WLAN 2.4GHz	802.11b 1Mbps	Top Side	10mm	ANT 6	Full power	6	2437	19.09	20.50	1.384	99.3	1.007	0.18	0.142	0.198
37	Bluetooth	1Mbps	Back	10mm	ANT 6	Full power	39	2441	9.81	11.00	1.315	77.38	1.292	-0.04	0.015	0.025
5000MHz																
	WLAN5.2GHz	802.11a 6Mbps	Front	10mm	ANT 6	Full power	48	5240	18.11	18.50	1.094	97.6	1.025	0.07	0.226	0.253
38	WLAN5.2GHz	802.11a 6Mbps	Back	10mm	ANT 6	Full power	48	5240	18.11	18.50	1.094	97.6	1.025	0.09	0.525	0.589
	WLAN5.2GHz	802.11a 6Mbps	Right Side	10mm	ANT 6	Full power	48	5240	18.11	18.50	1.094	97.6	1.025	0.18	0.268	0.301
	WLAN5.2GHz	802.11a 6Mbps	Top Side	10mm	ANT 6	Full power	48	5240	18.11	18.50	1.094	97.6	1.025	-0.09	0.516	0.579
	WLAN5.8GHz	802.11a 6Mbps	Front	10mm	ANT 6	Full power	149	5745	16.51	18.00	1.409	97.6	1.025	-0.16	0.294	0.425
39	WLAN5.8GHz	802.11a 6Mbps	Back	10mm	ANT 6	Full power	149	5745	16.51	18.00	1.409	97.6	1.025	-0.08	0.475	0.686
	WLAN5.8GHz	802.11a 6Mbps	Right Side	10mm	ANT 6	Full power	149	5745	16.51	18.00	1.409	97.6	1.025	0.08	0.270	0.390
	WLAN5.8GHz	802.11a 6Mbps	Top Side	10mm	ANT 6	Full power	149	5745	16.51	18.00	1.409	97.6	1.025	0.04	0.474	0.685



15.3 Body Worn Accessory SAR

Plot No.	Band	BW (MHz)	Modulation	RB Size	RB offset	Mode	Test Position	Gap (mm)	Antenna	Power State	Ch.	Freq. (MHz)	Average Power (dBm)	Tune-Up Limit (dBm)	Tune-up Scaling Factor	Power Drift (dB)	Measured 1g SAR (W/kg)	Reported 1g SAR (W/kg)	
750MHz																			
	LTE Band 12	10M	QPSK	1	0	-	Front	10mm	Ant 0	DSI 4	23095	707.5	24.69	25.50	1.205	0.05	0.127	0.153	
	LTE Band 12	10M	QPSK	25	0	-	Front	10mm	Ant 0	DSI 4	23095	707.5	23.89	24.50	1.151	-0.07	0.105	0.121	
40	LTE Band 12	10M	QPSK	1	0	-	Back	10mm	Ant 0	DSI 4	23095	707.5	24.69	25.50	1.205	0.15	0.220	0.265	
	LTE Band 12	10M	QPSK	25	0	-	Back	10mm	Ant 0	DSI 4	23095	707.5	23.89	24.50	1.151	0.1	0.174	0.200	
	LTE Band 12	10M	QPSK	1	0	-	Front	10mm	Ant 4	DSI 4	23095	707.5	24.76	25.50	1.186	-0.15	0.099	0.117	
	LTE Band 12	10M	QPSK	25	0	-	Front	10mm	Ant 4	DSI 4	23095	707.5	23.78	24.50	1.180	-0.1	0.082	0.097	
	LTE Band 12	10M	QPSK	1	0	-	Back	10mm	Ant 4	DSI 4	23095	707.5	24.76	25.50	1.186	0.01	0.176	0.209	
	LTE Band 12	10M	QPSK	25	0	-	Back	10mm	Ant 4	DSI 4	23095	707.5	23.78	24.50	1.180	-0.16	0.140	0.165	
835MHz																			
	GSM850	-	-	-	-	GPRS (4 Tx slots)	Front	10mm	Ant 0	DSI 4	189	836.4	26.32	27.50	1.312	0.06	0.229	0.300	
41	GSM850	-	-	-	-	GPRS (4 Tx slots)	Back	10mm	Ant 0	DSI 4	189	836.4	26.32	27.50	1.312	-0.04	0.388	0.509	
	GSM850	-	-	-	-	GPRS (4 Tx slots)	Front	10mm	Ant 4	DSI 4	189	836.4	26.54	27.50	1.247	0.07	0.205	0.256	
	GSM850	-	-	-	-	GPRS (4 Tx slots)	Back	10mm	Ant 4	DSI 4	189	836.4	26.54	27.50	1.247	0.03	0.352	0.439	
	WCDMA V	-	-	-	-	RMC 12.2Kbps	Front	10mm	Ant 0	DSI 4	4182	836.4	24.78	25.50	1.180	-0.1	0.261	0.308	
42	WCDMA V	-	-	-	-	RMC 12.2Kbps	Back	10mm	Ant 0	DSI 4	4182	836.4	24.78	25.50	1.180	-0.09	0.473	0.558	
	WCDMA V	-	-	-	-	RMC 12.2Kbps	Front	10mm	Ant 4	DSI 4	4182	836.4	24.73	25.50	1.194	0.07	0.251	0.300	
	WCDMA V	-	-	-	-	RMC 12.2Kbps	Back	10mm	Ant 4	DSI 4	4182	836.4	24.73	25.50	1.194	-0.13	0.413	0.493	
	LTE Band 26	15M	QPSK	1	0	-	Front	10mm	Ant 0	DSI 4	26865	831.5	24.44	25.50	1.276	-0.14	0.208	0.265	
	LTE Band 26	15M	QPSK	36	0	-	Front	10mm	Ant 0	DSI 4	26865	831.5	23.50	24.50	1.259	0.12	0.171	0.215	
43	LTE Band 26	15M	QPSK	1	0	-	Back	10mm	Ant 0	DSI 4	26865	831.5	24.44	25.50	1.276	-0.08	0.357	0.456	
	LTE Band 26	15M	QPSK	36	0	-	Back	10mm	Ant 0	DSI 4	26865	831.5	23.50	24.50	1.259	0.18	0.293	0.369	
	LTE Band 26	15M	QPSK	1	0	-	Front	10mm	Ant 4	DSI 4	26865	831.5	24.48	25.50	1.265	-0.09	0.177	0.224	
	LTE Band 26	15M	QPSK	36	0	-	Front	10mm	Ant 4	DSI 4	26865	831.5	23.54	24.50	1.247	0.03	0.146	0.182	
	LTE Band 26	15M	QPSK	1	0	-	Back	10mm	Ant 4	DSI 4	26865	831.5	24.48	25.50	1.265	-0.1	0.314	0.397	
	LTE Band 26	15M	QPSK	36	0	-	Back	10mm	Ant 4	DSI 4	26865	831.5	23.54	24.50	1.247	0.04	0.259	0.323	
	FR1 n5	20M	QPSK	1	1	DFT-15	Front	10mm	Ant 0	DSI 4	167300	836.5	24.97	25.50	1.130	-0.1	0.254	0.287	
	FR1 n5	20M	QPSK	50	28	DFT-15	Front	10mm	Ant 0	DSI 4	167300	836.5	24.94	25.50	1.138	0.07	0.259	0.295	
	FR1 n5	20M	QPSK	1	1	DFT-15	Back	10mm	Ant 0	DSI 4	167300	836.5	24.97	25.50	1.130	-0.18	0.434	0.490	
44	FR1 n5	20M	QPSK	50	28	DFT-15	Back	10mm	Ant 0	DSI 4	167300	836.5	24.94	25.50	1.138	-0.09	0.471	0.536	
	FR1 n5	20M	QPSK	1	1	DFT-15	Front	10mm	Ant 4	DSI 4	167300	836.5	25.17	25.50	1.079	0.19	0.186	0.201	
	FR1 n5	20M	QPSK	50	28	DFT-15	Front	10mm	Ant 4	DSI 4	167300	836.5	25.07	25.50	1.104	-0.02	0.184	0.203	
	FR1 n5	20M	QPSK	1	1	DFT-15	Back	10mm	Ant 4	DSI 4	167300	836.5	25.17	25.50	1.079	-0.08	0.359	0.387	
	FR1 n5	20M	QPSK	50	28	DFT-15	Back	10mm	Ant 4	DSI 4	167300	836.5	25.07	25.50	1.104	-0.09	0.326	0.360	
1750MHz																			
	WCDMA IV	-	-	-	-	RMC 12.2Kbps	Front	10mm	Ant 0	DSI 4	1413	1732.6	22.56	23.50	1.242	-0.02	0.262	0.325	
	WCDMA IV	-	-	-	-	RMC 12.2Kbps	Back	10mm	Ant 0	DSI 4	1413	1732.6	22.56	23.50	1.242	0.06	0.704	0.874	
	WCDMA IV	-	-	-	-	RMC 12.2Kbps	Back	10mm	Ant 0	DSI 4	1312	1712.4	22.40	23.50	1.288	0.16	0.665	0.857	
	WCDMA IV	-	-	-	-	RMC 12.2Kbps	Back	10mm	Ant 0	DSI 4	1513	1752.6	22.51	23.50	1.256	0.08	0.671	0.843	
	WCDMA IV	-	-	-	-	RMC 12.2Kbps	Front	15mm	Ant 0	DSI 2	1413	1732.6	24.52	25.50	1.253	0.08	0.242	0.303	
45	WCDMA IV	-	-	-	-	RMC 12.2Kbps	Back	15mm	Ant 0	DSI 2	1413	1732.6	24.52	25.50	1.253	0.05	0.866	1.085	
	WCDMA IV	-	-	-	-	RMC 12.2Kbps	Back	15mm	Ant 0	DSI 2	1312	1712.4	24.13	25.50	1.371	0.13	0.786	1.078	
	WCDMA IV	-	-	-	-	RMC 12.2Kbps	Back	15mm	Ant 0	DSI 2	1513	1752.6	24.44	25.50	1.276	0.08	0.811	1.035	
	WCDMA IV	-	-	-	-	RMC 12.2Kbps	Front	10mm	Ant 4	DSI 4	1413	1732.6	22.51	23.50	1.256	-0.17	0.145	0.182	
	WCDMA IV	-	-	-	-	RMC 12.2Kbps	Back	10mm	Ant 4	DSI 4	1413	1732.6	22.51	23.50	1.256	-0.07	0.188	0.236	
	WCDMA IV	-	-	-	-	RMC 12.2Kbps	Front	15mm	Ant 4	DSI 2	1413	1732.6	23.83	24.50	1.167	-0.11	0.114	0.133	
	WCDMA IV	-	-	-	-	RMC 12.2Kbps	Back	15mm	Ant 4	DSI 2	1413	1732.6	23.83	24.50	1.167	-0.09	0.124	0.145	
	LTE Band 4	20M	QPSK	1	0	-	Front	10mm	Ant 0	DSI 4	20175	1732.5	21.69	22.50	1.205	0.05	0.157	0.189	
	LTE Band 4	20M	QPSK	50	0	-	Front	10mm	Ant 0	DSI 4	20175	1732.5	21.32	22.50	1.312	-0.18	0.165	0.217	
	LTE Band 4	20M	QPSK	1	0	-	Back	10mm	Ant 0	DSI 4	20175	1732.5	21.69	22.50	1.205	-0.18	0.444	0.535	
	LTE Band 4	20M	QPSK	50	0	-	Back	10mm	Ant 0	DSI 4	20175	1732.5	21.32	22.50	1.312	0.01	0.425	0.558	



FCC SAR Test Report

Report No. : FA1N1013-01

	LTE Band 4	20M	QPSK	1	0	-	Front	15mm	Ant 0	DSI 2	20175	1732.5	24.25	25.50	1.334	-0.15	0.178	0.237
46	LTE Band 4	20M	QPSK	1	0	-	Back	15mm	Ant 0	DSI 2	20175	1732.5	24.25	25.50	1.334	-0.09	0.595	0.793
	LTE Band 4	20M	QPSK	1	0	-	Front	10mm	Ant 4	DSI 4	20175	1732.5	22.32	23.50	1.312	-0.16	0.088	0.115
	LTE Band 4	20M	QPSK	50	0	-	Front	10mm	Ant 4	DSI 4	20175	1732.5	22.27	23.50	1.327	-0.1	0.088	0.117
	LTE Band 4	20M	QPSK	1	0	-	Back	10mm	Ant 4	DSI 4	20175	1732.5	22.32	23.50	1.312	0.05	0.103	0.135
	LTE Band 4	20M	QPSK	50	0	-	Back	10mm	Ant 4	DSI 4	20175	1732.5	22.27	23.50	1.327	-0.06	0.105	0.139
	LTE Band 4	20M	QPSK	1	0	-	Front	15mm	Ant 4	DSI 2	20175	1732.5	23.46	24.50	1.271	0.03	0.106	0.135
	LTE Band 4	20M	QPSK	1	0	-	Back	15mm	Ant 4	DSI 2	20175	1732.5	23.46	24.50	1.271	-0.07	0.096	0.122

Plot No.	Band	BW (MHz)	Modulation	RB Size	RB offset	Mode	Test Position	Gap (mm)	Antenna	Power State	Ch.	Freq. (MHz)	Average Power (dBm)	Tune-Up Limit (dBm)	Tune-up Scaling Factor	Duty Cycle %	Duty Cycle Scaling Factor	Power Drift (dB)	Measured 1g SAR (W/kg)	Reported 1g SAR (W/kg)
1900MHz																				
	GSM1900	-	-	-	-	GPRS (4 Tx slots)	Front	10mm	Ant 0	DSI 4	661	1880	23.15	24.50	1.365	-	-	0.07	0.265	0.362
47	GSM1900	-	-	-	-	GPRS (4 Tx slots)	Back	10mm	Ant 0	DSI 4	661	1880	23.15	24.50	1.365	-	-	-0.06	0.543	0.741
	GSM1900	-	-	-	-	GPRS (4 Tx slots)	Front	10mm	Ant 4	DSI 4	661	1880	23.17	24.50	1.358	-	-	0.02	0.162	0.220
	GSM1900	-	-	-	-	GPRS (4 Tx slots)	Back	10mm	Ant 4	DSI 4	661	1880	23.17	24.50	1.358	-	-	0.01	0.213	0.289
	WCDMA II	-	-	-	-	RMC 12.2Kbps	Front	10mm	Ant 0	DSI 4	9400	1880	21.33	22.50	1.309	-	-	-0.14	0.269	0.352
	WCDMA II	-	-	-	-	RMC 12.2Kbps	Back	10mm	Ant 0	DSI 4	9400	1880	21.33	22.50	1.309	-	-	0.03	0.546	0.715
	WCDMA II	-	-	-	-	RMC 12.2Kbps	Front	15mm	Ant 0	DSI 2	9400	1880	24.43	25.50	1.279	-	-	0.15	0.317	0.406
48	WCDMA II	-	-	-	-	RMC 12.2Kbps	Back	15mm	Ant 0	DSI 2	9400	1880	24.43	25.50	1.279	-	-	-0.04	0.621	0.794
	WCDMA II	-	-	-	-	RMC 12.2Kbps	Front	10mm	Ant 4	DSI 4	9400	1880	21.42	22.50	1.282	-	-	0.07	0.200	0.256
	WCDMA II	-	-	-	-	RMC 12.2Kbps	Back	10mm	Ant 4	DSI 4	9400	1880	21.42	22.50	1.282	-	-	0.07	0.275	0.353
	WCDMA II	-	-	-	-	RMC 12.2Kbps	Front	15mm	Ant 4	DSI 2	9400	1880	23.36	24.50	1.300	-	-	0.19	0.177	0.230
	WCDMA II	-	-	-	-	RMC 12.2Kbps	Back	15mm	Ant 4	DSI 2	9400	1880	23.36	24.50	1.300	-	-	0.18	0.216	0.281
	LTE Band 2	20M	QPSK	1	0	-	Front	10mm	Ant 0	DSI 4	18900	1880	19.66	20.50	1.213	-	-	-0.04	0.190	0.231
	LTE Band 2	20M	QPSK	50	0	-	Front	10mm	Ant 0	DSI 4	18900	1880	19.46	20.50	1.271	-	-	-0.15	0.197	0.250
	LTE Band 2	20M	QPSK	1	0	-	Back	10mm	Ant 0	DSI 4	18900	1880	19.66	20.50	1.213	-	-	-0.17	0.412	0.500
	LTE Band 2	20M	QPSK	50	0	-	Back	10mm	Ant 0	DSI 4	18900	1880	19.46	20.50	1.271	-	-	0.06	0.420	0.534
	LTE Band 2	20M	QPSK	1	0	-	Front	15mm	Ant 0	DSI 2	18900	1880	23.31	24.50	1.315	-	-	0.03	0.257	0.338
49	LTE Band 2	20M	QPSK	1	0	-	Back	15mm	Ant 0	DSI 2	18900	1880	23.31	24.50	1.315	-	-	0.01	0.516	0.679
	LTE Band 2	20M	QPSK	1	0	-	Front	10mm	Ant 4	DSI 4	18900	1880	20.22	21.00	1.197	-	-	0.07	0.156	0.187
	LTE Band 2	20M	QPSK	50	0	-	Front	10mm	Ant 4	DSI 4	18900	1880	20.19	21.00	1.205	-	-	-0.09	0.156	0.188
	LTE Band 2	20M	QPSK	1	0	-	Back	10mm	Ant 4	DSI 4	18900	1880	20.22	21.00	1.197	-	-	-0.04	0.202	0.242
	LTE Band 2	20M	QPSK	50	0	-	Back	10mm	Ant 4	DSI 4	18900	1880	20.19	21.00	1.205	-	-	0.1	0.208	0.251
	LTE Band 2	20M	QPSK	1	0	-	Front	15mm	Ant 4	DSI 2	18900	1880	22.53	23.50	1.250	-	-	0.05	0.152	0.190
	LTE Band 2	20M	QPSK	1	0	-	Back	15mm	Ant 4	DSI 2	18900	1880	22.53	23.50	1.250	-	-	0.02	0.179	0.224
2600MHz																				
	LTE Band 7	20M	QPSK	1	0	-	Front	10mm	Ant 0	DSI 4	21100	2535	20.19	21.00	1.205	-	-	-0.14	0.099	0.119
	LTE Band 7	20M	QPSK	50	0	-	Front	10mm	Ant 0	DSI 4	21100	2535	20.17	21.00	1.211	-	-	0.07	0.104	0.126
	LTE Band 7	20M	QPSK	1	0	-	Back	10mm	Ant 0	DSI 4	21100	2535	20.19	21.00	1.205	-	-	0.05	0.243	0.293
	LTE Band 7	20M	QPSK	50	0	-	Back	10mm	Ant 0	DSI 4	21100	2535	20.17	21.00	1.211	-	-	-0.15	0.243	0.294
	LTE Band 7	20M	QPSK	1	0	-	Front	15mm	Ant 0	DSI 2	21100	2535	24.39	25.50	1.291	-	-	0.06	0.154	0.199
50	LTE Band 7	20M	QPSK	50	0	-	Back	15mm	Ant 0	DSI 2	21100	2535	23.56	24.50	1.242	-	-	0.14	0.308	0.382
	LTE Band 7C	20M	QPSK	50	0	-	Back	15mm	Ant 0	DSI 2	21100+21298	2535+2554.8	23.34	24.50	1.306	-	-	0.13	0.278	0.363
	LTE Band 7	20M	QPSK	1	0	-	Front	10mm	Ant 4	DSI 4	21100	2535	19.77	20.50	1.183	-	-	0.03	0.155	0.183
	LTE Band 7	20M	QPSK	50	0	-	Front	10mm	Ant 4	DSI 4	21100	2535	19.74	20.50	1.191	-	-	0.08	0.161	0.192
	LTE Band 7	20M	QPSK	1	0	-	Back	10mm	Ant 4	DSI 4	21100	2535	19.77	20.50	1.183	-	-	-0.05	0.225	0.266
	LTE Band 7	20M	QPSK	50	0	-	Back	10mm	Ant 4	DSI 4	21100	2535	19.74	20.50	1.191	-	-	0.03	0.233	0.278
	LTE Band 7C	20M	QPSK	50	0	-	Back	10mm	Ant 4	DSI 4	21100+21298	2535+2554.8	19.67	20.50	1.211	-	-	0.13	0.210	0.254
	LTE Band 7	20M	QPSK	1	0	-	Front	15mm	Ant 4	DSI 2	21100	2535	22.67	23.50	1.211	-	-	0.07	0.155	0.188
	LTE Band 7	20M	QPSK	1	0	-	Back	15mm	Ant 4	DSI 2	21100	2535	22.67	23.50	1.211	-	-	-0.11	0.213	0.258
	LTE Band 41	20M	QPSK	1	0	-	Front	10mm	Ant 0	DSI 4	40620	2593	22.15	23.00	1.216	62.9	1.006	0.1	0.190	0.232
	LTE Band 41	20M	QPSK	50	0	-	Front	10mm	Ant 0	DSI 4	40620	2593	22.01	23.00	1.256	62.9	1.006	0.19	0.193	0.244
	LTE Band 41	20M	QPSK	1	0	-	Back	10mm	Ant 0	DSI 4	40620	2593	22.15	23.00	1.216	62.9	1.006	0.04	0.403	0.493
51	LTE Band 41	20M	QPSK	50	0	-	Back	10mm	Ant 0	DSI 4	40620	2593	22.01	23.00	1.256	62.9	1.006	-0.16	0.410	0.518

Sporton International (Kunshan) Inc.

TEL : 86-512-57900158 / FAX : 86-512-57900958

FCC ID : 2AFZZ16PG

Issued Date : Jan. 05, 2022

Form version. : 200414



FCC SAR Test Report

Report No. : FA1N1013-01

	LTE Band 41C	20M	QPSK	50	0	-	Back	10mm	Ant 0	DSI 4	40620+40818	2593+2612.8	21.89	23.00	1.291	62.9	1.006	0.04	0.375	0.487
	LTE Band 41	20M	QPSK	1	0	-	Front	15mm	Ant 0	DSI 2	40620	2593	24.68	25.50	1.208	62.9	1.006	-0.11	0.128	0.156
	LTE Band 41	20M	QPSK	1	0	-	Back	15mm	Ant 0	DSI 2	40620	2593	24.68	25.50	1.208	62.9	1.006	0.06	0.234	0.284
	LTE Band 41	20M	QPSK	1	0	-	Front	10mm	Ant 4	DSI 4	40620	2593	21.62	22.00	1.091	62.9	1.006	0.06	0.189	0.208
	LTE Band 41	20M	QPSK	50	0	-	Front	10mm	Ant 4	DSI 4	40620	2593	20.68	22.00	1.355	62.9	1.006	0.07	0.158	0.215
	LTE Band 41	20M	QPSK	1	0	-	Back	10mm	Ant 4	DSI 4	40620	2593	21.62	22.00	1.091	62.9	1.006	0.03	0.314	0.345
	LTE Band 41	20M	QPSK	50	0	-	Back	10mm	Ant 4	DSI 4	40620	2593	20.68	22.00	1.355	62.9	1.006	0.15	0.260	0.354
	LTE Band 41C	20M	QPSK	50	0	-	Back	10mm	Ant 4	DSI 4	40620+40818	2593+2612.8	20.58	22.00	1.387	62.9	1.006	0.03	0.235	0.328
	LTE Band 41	20M	QPSK	1	0	-	Front	15mm	Ant 4	DSI 2	40620	2593	22.89	23.50	1.151	62.9	1.006	-0.02	0.098	0.113
	LTE Band 41	20M	QPSK	1	0	-	Back	15mm	Ant 4	DSI 2	40620	2593	22.89	23.50	1.151	62.9	1.006	0.03	0.154	0.178
	FR1 n7	20M	QPSK	1	1	DFT-15	Front	10mm	Ant 0	DSI 4	507000	2535	18.83	19.50	1.167	-	-	0.03	0.056	0.065
	FR1 n7	20M	QPSK	50	28	DFT-15	Front	10mm	Ant 0	DSI 4	507000	2535	18.59	19.50	1.233	-	-	-0.1	0.056	0.069
	FR1 n7	20M	QPSK	1	1	DFT-15	Back	10mm	Ant 0	DSI 4	507000	2535	18.83	19.50	1.167	-	-	-0.06	0.131	0.153
	FR1 n7	20M	QPSK	50	28	DFT-15	Back	10mm	Ant 0	DSI 4	507000	2535	18.59	19.50	1.233	-	-	0.13	0.122	0.150
	FR1 n7	20M	QPSK	1	1	DFT-15	Front	15mm	Ant 0	DSI 2	507000	2535	24.85	25.50	1.161	-	-	0.02	0.029	0.034
	FR1 n7	20M	QPSK	1	1	DFT-15	Back	15mm	Ant 0	DSI 2	507000	2535	24.85	25.50	1.161	-	-	-0.01	0.110	0.128
	FR1 n7	20M	QPSK	1	1	DFT-15	Front	10mm	Ant 4	DSI 4	507000	2535	19.64	21.00	1.368	-	-	0.17	0.200	0.274
	FR1 n7	20M	QPSK	50	28	DFT-15	Front	10mm	Ant 4	DSI 4	507000	2535	19.49	21.00	1.416	-	-	0.04	0.193	0.273
	FR1 n7	20M	QPSK	1	1	DFT-15	Back	10mm	Ant 4	DSI 4	507000	2535	19.64	21.00	1.368	-	-	-0.09	0.275	0.376
52	FR1 n7	20M	QPSK	50	28	DFT-15	Back	10mm	Ant 4	DSI 4	507000	2535	19.49	21.00	1.416	-	-	0.14	0.278	0.394
	FR1 n7	20M	QPSK	1	1	DFT-15	Front	15mm	Ant 4	DSI 2	507000	2535	23.34	24.50	1.306	-	-	0.15	0.102	0.133
	FR1 n7	20M	QPSK	1	1	DFT-15	Back	15mm	Ant 4	DSI 2	507000	2535	23.34	24.50	1.306	-	-	-0.16	0.145	0.189
	FR1 n41	100M	QPSK	1	1	DFT-30	Front	10mm	Ant 0	DSI 4	518598	2592.99	18.65	19.50	1.216	-	-	0.06	0.066	0.080
	FR1 n41	100M	QPSK	135	69	DFT-30	Front	10mm	Ant 0	DSI 4	518598	2592.99	18.53	19.50	1.250	-	-	0.08	0.063	0.079
	FR1 n41	100M	QPSK	1	1	DFT-30	Back	10mm	Ant 0	DSI 4	518598	2592.99	18.65	19.50	1.216	-	-	0.16	0.143	0.174
	FR1 n41	100M	QPSK	135	69	DFT-30	Back	10mm	Ant 0	DSI 4	518598	2592.99	18.53	19.50	1.250	-	-	0.05	0.139	0.174
	FR1 n41	100M	QPSK	1	1	DFT-30	Front	15mm	Ant 0	DSI 2	518598	2592.99	26.16	27.00	1.213	-	-	0.04	0.262	0.318
53	FR1 n41	100M	QPSK	1	1	DFT-30	Back	15mm	Ant 0	DSI 2	518598	2592.99	26.16	27.00	1.213	-	-	-0.09	0.450	0.546
	FR1 n41	100M	QPSK	1	1	DFT-30	Front	10mm	Ant 4	DSI 4	518598	2592.99	19.64	21.00	1.368	-	-	-0.1	0.187	0.256
	FR1 n41	100M	QPSK	135	69	DFT-30	Front	10mm	Ant 4	DSI 4	518598	2592.99	19.62	21.00	1.374	-	-	-0.13	0.156	0.214
	FR1 n41	100M	QPSK	1	1	DFT-30	Back	10mm	Ant 4	DSI 4	518598	2592.99	19.64	21.00	1.368	-	-	-0.12	0.262	0.358
	FR1 n41	100M	QPSK	135	69	DFT-30	Back	10mm	Ant 4	DSI 4	518598	2592.99	19.62	21.00	1.374	-	-	-0.09	0.241	0.331
	FR1 n41	100M	QPSK	1	1	DFT-30	Front	15mm	Ant 4	DSI 2	518598	2592.99	24.44	26.00	1.432	-	-	-0.13	0.170	0.243
	FR1 n41	100M	QPSK	1	1	DFT-30	Back	15mm	Ant 4	DSI 2	518598	2592.99	24.44	26.00	1.432	-	-	0.06	0.233	0.334



Plot No.	Band	BW (MHz)	Modulation	RB Size	RB offset	Mode	Test Position	Gap (mm)	Antenna	Power State	Ch.	Freq. (MHz)	Average Power (dBm)	Tune-Up Limit (dBm)	Tune-up Scaling Factor	Power Drift (dB)	Measured 1g SAR (W/kg)	Reported 1g SAR (W/kg)	
3500MHz																			
	FR1 n77	100M	QPSK	1	1	DFT-30	Front	10mm	Ant 3	DSI 4	656000	3840	15.72	17.00	1.343	0.02	0.153	0.205	
	FR1 n77	100M	QPSK	135	69	DFT-30	Front	10mm	Ant 3	DSI 4	656000	3840	15.66	17.00	1.361	0.11	0.147	0.200	
	FR1 n77	100M	QPSK	1	1	DFT-30	Back	10mm	Ant 3	DSI 4	656000	3840	15.72	17.00	1.343	-0.03	0.245	0.329	
	FR1 n77	100M	QPSK	135	69	DFT-30	Back	10mm	Ant 3	DSI 4	656000	3840	15.66	17.00	1.361	0.09	0.233	0.317	
	FR1 n77	100M	QPSK	1	1	DFT-30	Front	10mm	Ant 3	DSI 4	633334	3500.01	15.62	17.00	1.374	0.01	0.163	0.224	
	FR1 n77	100M	QPSK	135	69	DFT-30	Front	10mm	Ant 3	DSI 4	633334	3500.01	15.52	17.00	1.406	-0.15	0.169	0.238	
	FR1 n77	100M	QPSK	1	1	DFT-30	Back	10mm	Ant 3	DSI 4	633334	3500.01	15.62	17.00	1.374	-0.1	0.181	0.249	
	FR1 n77	100M	QPSK	135	69	DFT-30	Back	10mm	Ant 3	DSI 4	633334	3500.01	15.52	17.00	1.406	0.12	0.192	0.270	
	FR1 n77	100M	QPSK	1	1	DFT-30	Front	10mm	Ant 5	DSI 4	656000	3840	16.71	17.00	1.069	0.04	0.103	0.110	
	FR1 n77	100M	QPSK	135	69	DFT-30	Front	10mm	Ant 5	DSI 4	656000	3840	16.61	17.00	1.094	-0.01	0.103	0.113	
	FR1 n77	100M	QPSK	1	1	DFT-30	Back	10mm	Ant 5	DSI 4	656000	3840	16.71	17.00	1.069	0.02	0.149	0.159	
	FR1 n77	100M	QPSK	135	69	DFT-30	Back	10mm	Ant 5	DSI 4	656000	3840	16.61	17.00	1.094	-0.03	0.153	0.167	
	FR1 n77	100M	QPSK	1	1	DFT-30	Front	15mm	Ant 5	DSI 2	656000	3840	23.61	24.00	1.094	0.07	0.054	0.059	
	FR1 n77	100M	QPSK	1	1	DFT-30	Back	15mm	Ant 5	DSI 2	656000	3840	23.61	24.00	1.094	-0.06	0.325	0.356	
	FR1 n77	100M	QPSK	1	1	DFT-30	Front	10mm	Ant 5	DSI 4	633334	3500.01	16.59	17.00	1.099	0.14	0.118	0.130	
	FR1 n77	100M	QPSK	135	69	DFT-30	Front	10mm	Ant 5	DSI 4	633334	3500.01	16.53	17.00	1.114	0.09	0.133	0.148	
	FR1 n77	100M	QPSK	1	1	DFT-30	Back	10mm	Ant 5	DSI 4	633334	3500.01	16.59	17.00	1.099	0.08	0.208	0.229	
	FR1 n77	100M	QPSK	135	69	DFT-30	Back	10mm	Ant 5	DSI 4	633334	3500.01	16.53	17.00	1.114	-0.01	0.214	0.238	
	FR1 n77	100M	QPSK	1	1	DFT-30	Front	15mm	Ant 5	DSI 2	633334	3500.01	23.52	24.00	1.117	-0.14	0.063	0.070	
54	FR1 n77	100M	QPSK	1	1	DFT-30	Back	15mm	Ant 5	DSI 2	633334	3500.01	23.52	24.00	1.117	0.04	0.346	0.386	

Plot No.	Band	Mode	Test Position	Gap (mm)	Antenna	Power State	Ch.	Freq. (MHz)	Average Power (dBm)	Tune-Up Limit (dBm)	Tune-up Scaling Factor	Duty Cycle %	Duty Cycle Scaling Factor	Power Drift (dB)	Measured 1g SAR (W/kg)	Reported 1g SAR (W/kg)
2450MHz																
	WLAN 2.4GHz	802.11b 1Mbps	Front	10mm	ANT 6	Full power	6	2437	19.09	20.50	1.384	99.3	1.007	0.08	0.155	0.216
55	WLAN 2.4GHz	802.11b 1Mbps	Back	10mm	ANT 6	Full power	6	2437	19.09	20.50	1.384	99.3	1.007	0.1	0.175	0.244
	WLAN 2.4GHz	802.11b 1Mbps	Back	15mm	ANT 6	Full power	6	2437	19.09	20.50	1.384	99.3	1.007	0.03	0.101	0.141
56	Bluetooth	1Mbps	Back	10mm	ANT 6	Full power	39	2441	9.81	11.00	1.315	77.38	1.292	-0.04	0.015	0.025
	Bluetooth	1Mbps	Back	15mm	ANT 6	Full power	39	2441	9.81	11.00	1.315	77.38	1.292	0.05	0.003	0.005
5000MHz																
	WLAN5.3GHz	802.11a 6Mbps	Front	10mm	ANT 6	Full power	64	5320	18.21	18.50	1.069	97.6	1.025	0.09	0.228	0.250
57	WLAN5.3GHz	802.11a 6Mbps	Back	10mm	ANT 6	Full power	64	5320	18.21	18.50	1.069	97.6	1.025	0.01	0.524	0.574
	WLAN5.3GHz	802.11a 6Mbps	Back	15mm	ANT 6	Full power	64	5320	18.21	18.50	1.069	97.6	1.025	0.08	0.312	0.342
	WLAN5.5GHz	802.11a 6Mbps	Front	10mm	ANT 6	Full power	124	5620	18.15	18.50	1.084	97.6	1.025	0.06	0.291	0.323
58	WLAN5.5GHz	802.11a 6Mbps	Back	10mm	ANT 6	Full power	124	5620	18.15	18.50	1.084	97.6	1.025	-0.07	0.515	0.572
	WLAN5.5GHz	802.11a 6Mbps	Back	15mm	ANT 6	Full power	124	5620	18.15	18.50	1.084	97.6	1.025	0.06	0.324	0.360
	WLAN5.8GHz	802.11a 6Mbps	Front	10mm	ANT 6	Full power	149	5745	16.51	18.00	1.409	97.6	1.025	-0.16	0.294	0.425
59	WLAN5.8GHz	802.11a 6Mbps	Back	10mm	ANT 6	Full power	149	5745	16.51	18.00	1.409	97.6	1.025	-0.08	0.475	0.686
	WLAN5.8GHz	802.11a 6Mbps	Back	15mm	ANT 6	Full power	149	5745	16.51	18.00	1.409	97.6	1.025	-0.16	0.321	0.464



15.4 Product Specific SAR

Plot No.	Band	Mode	Test Position	Gap (mm)	Antenna	Power State	Ch.	Freq. (MHz)	Average Power (dBm)	Tune-Up Limit (dBm)	Tune-up Scaling Factor	Duty Cycle %	Duty Cycle Scaling Factor	Power Drift (dB)	Measured 10g SAR (W/kg)	Reported 10g SAR (W/kg)
5000MHz																
	WLAN5.3GHz	802.11a 6Mbps	Front	0mm	ANT 6	Full power	64	5320	18.21	18.50	1.069	97.6	1.025	0.06	0.687	0.753
	WLAN5.3GHz	802.11a 6Mbps	Back	0mm	ANT 6	Full power	64	5320	18.21	18.50	1.069	97.6	1.025	-0.14	0.767	0.840
	WLAN5.3GHz	802.11a 6Mbps	Right Side	0mm	ANT 6	Full power	64	5320	18.21	18.50	1.069	97.6	1.025	-0.09	0.442	0.484
60	WLAN5.3GHz	802.11a 6Mbps	Top Side	0mm	ANT 6	Full power	64	5320	18.21	18.50	1.069	97.6	1.025	0.05	1.430	1.567
	WLAN5.5GHz	802.11a 6Mbps	Front	0mm	ANT 6	Full power	124	5620	18.15	18.50	1.084	97.6	1.025	0.06	0.997	1.108
	WLAN5.5GHz	802.11a 6Mbps	Back	0mm	ANT 6	Full power	124	5620	18.15	18.50	1.084	97.6	1.025	0.16	1.075	1.194
	WLAN5.5GHz	802.11a 6Mbps	Right Side	0mm	ANT 6	Full power	124	5620	18.15	18.50	1.084	97.6	1.025	-0.08	0.770	0.855
61	WLAN5.5GHz	802.11a 6Mbps	Top Side	0mm	ANT 6	Full power	124	5620	18.15	18.50	1.084	97.6	1.025	-0.02	1.530	1.700



15.5 Repeated SAR Measurement

<1g>

Plot No.	Band	Mode	Test Position	Gap (mm)	Antenna	Power State	Ch.	Freq. (MHz)	Average Power (dBm)	Tune-Up Limit (dBm)	Tune-up Scaling Factor	Power Drift (dB)	Measured 1g SAR (W/kg)	Ratio	Reported 1g SAR (W/kg)
1st	WCDMA V	RMC 12.2Kbps	Right Cheek	0mm	Ant4	DSI 1	4182	836.4	23.62	24.50	1.225	0.01	0.868	1	1.063
2nd	WCDMA V	RMC 12.2Kbps	Right Cheek	0mm	Ant4	DSI 1	4182	836.4	23.62	24.50	1.225	0.16	0.843	1.030	1.032
1st	WCDMA IV	RMC 12.2Kbps	Bottom Side	10mm	Ant 0	DSI 4	1413	1732.6	22.56	23.50	1.242	-0.09	0.876	1	1.088
2nd	WCDMA IV	RMC 12.2Kbps	Bottom Side	10mm	Ant 0	DSI 4	1413	1732.6	22.56	23.50	1.242	0.11	0.862	1.016	1.070

General Note:

1. Per KDB 865664 D01v01r04, for each frequency band, repeated SAR measurement is required only when the measured SAR is $\geq 0.8W/kg$.
2. Per KDB 865664 D01v01r04, if the ratio among the repeated measurement is ≤ 1.2 and the measured SAR $< 1.45W/kg$, only one repeated measurement is required.
3. The ratio is the difference in percentage between original and repeated *measured SAR*.
4. All measurement SAR result is scaled-up to account for tune-up tolerance and is compliant.

16. Simultaneous Transmission Analysis

NO.	Simultaneous Transmission Configurations	Portable Handset			
		Head	Body-worn	Hotspot	Product Specific
1.	WWAN + WLAN2.4GHz	Yes	Yes	Yes	Yes
2.	WWAN + WLAN5GHz	Yes	Yes	Yes	Yes
3.	WWAN + Bluetooth	Yes	Yes	Yes	Yes
4.	Bluetooth + WLAN5GHz	Yes	Yes	Yes	Yes
5.	WWAN + Bluetooth + WLAN5GHz	Yes	Yes	Yes	Yes

General Note:

1. This device supports VoIP in GPRS, EGPRS, WCDMA and LTE (e.g. for 3rd-party VoIP) and LTE supports VoLTE operation.
2. WWAN above includes 5G NR bands.
3. EN-DC SAR summed the standalone 5G NR SAR and LTE standalone SAR more conservatively.
4. EUT will choose each GSM, WCDMA, LTE and 5G NR according to the network signal condition; therefore, they will not operate simultaneously at any moment.
5. This device 2.4GHz WLAN support hotspot operation and Bluetooth support tethering applications.
6. This device 2.4GHz WLAN/ 5.2GHz WLAN/5.8GHz WLAN support hotspot operation, and 5.2GHz WLAN/5.8GHz WLAN supports WLAN Direct (GC/GO), and 5.3GHz / 5.5GHz supports WLAN Direct (GC only).
7. WLAN2.4GHz and Bluetooth share the same antenna, so can't transmit simultaneously.
8. According to the characteristic of EUT, WLAN5GHz and Bluetooth can transmit simultaneously.
9. According to the EUT character, WLAN 2.4GHz and WLAN 5GHz cannot transmit simultaneously.
10. For simultaneously analysis, since the SAR summation of 3 transmitters can cover others combination of 2 transmitters, therefore in this section did not additional to evaluate 2TX combination of simultaneously transmission.
11. The worst case 5 GHz WLAN SAR for each configuration was used for SAR summation.
12. Chose the worst zoom scan SAR of WLAN correspondingly for co-located with WWAN analysis.
13. The reported SAR summation is calculated based on the same configuration and test position.
14. WWAN antenna always chose the worst position SAR among all WWAN bands base on head and body to do co-located with WLAN/Bluetooth. It is the most conservatively evaluation.
15. Per KDB 447498 D01v06, simultaneous transmission SAR is compliant if,
 - i) 1g Scalar SAR summation < 1.6W/kg and 10g Scalar SAR summation < 4.0W/kg.
 - ii) $SPLSR = (SAR1 + SAR2)^{1.5} / (\text{min. separation distance, mm})$, and the peak separation distance is determined from the square root of $[(x1-x2)^2 + (y1-y2)^2 + (z1-z2)^2]$, where (x1, y1, z1) and (x2, y2, z2) are the coordinates of the extrapolated peak SAR locations in the zoom scan.
 - iii) If $SPLSR \leq 0.04$ for 1g SAR and $SPLSR \leq 0.10$ for 10g SAR, simultaneously transmission SAR measurement is not necessary.
 - iv) Simultaneously transmission SAR measurement, and the reported multi-band 1g SAR < 1.6W/kg and 10g SAR < 4.0W/kg.



16.1 Head Exposure Conditions

WWAN Band	Exposure Position	1	2	3	4	1+2 Summed 1g SAR (W/kg)	1+3+4 Summed 1g SAR (W/kg)
		WWAN	WLAN2.4GHz Ant 6	WLAN5GHz Ant 6	Bluetooth Ant 6		
		1g SAR (W/kg)	1g SAR (W/kg)	1g SAR (W/kg)	1g SAR (W/kg)		
WWAN All Bands	Right Cheek	1.063	0.101	0.332	0.099	1.16	1.49
	Right Tilted	0.990	0.078	0.381	0.099	1.07	1.47
	Left Cheek	0.933	0.279	0.519	0.099	1.21	1.55
	Left Tilted	0.850	0.206	0.545	0.099	1.06	1.49

<5G NR ENDC>

WWAN Band	FR1 Band	Exposure Position	1	2	3	4	5	1+2+3 Summed 1g SAR (W/kg)	1+2+4+5 Summed 1g SAR (W/kg)
			WWAN	FR1	WLAN2.4GHz Ant 6	WLAN5GHz Ant 6	Bluetooth Ant 6		
			1g SAR (W/kg)	1g SAR (W/kg)	1g SAR (W/kg)	1g SAR (W/kg)	1g SAR (W/kg)		
LTE Band 2 ANT0	FR1 n77(78) ANT 3	Right Cheek	0.139	0.793	0.101	0.332	0.099	1.03	1.36
		Right Tilted	0.108	0.443	0.078	0.381	0.099	0.63	1.03
		Left Cheek	0.145	0.246	0.279	0.519	0.099	0.67	1.01
		Left Tilted	0.135	0.204	0.206	0.545	0.099	0.55	0.98
LTE Band 2 ANT0	FR1 n77(78) ANT 5	Right Cheek	0.139	0.430	0.101	0.332	0.099	0.67	1.00
		Right Tilted	0.108	0.473	0.078	0.381	0.099	0.66	1.06
		Left Cheek	0.145	0.696	0.279	0.519	0.099	1.12	1.46
		Left Tilted	0.135	0.699	0.206	0.545	0.099	1.04	1.48
LTE Band 2 ANT4	FR1 n77(78) ANT 3	Right Cheek	0.250	0.793	0.101	0.332	0.099	1.14	1.47
		Right Tilted	0.250	0.443	0.078	0.381	0.099	0.77	1.17
		Left Cheek	0.250	0.246	0.279	0.519	0.099	0.78	1.11
		Left Tilted	0.250	0.204	0.206	0.545	0.099	0.66	1.10
LTE Band 2 ANT 4	FR1 n77(78) ANT 5	Right Cheek	0.250	0.430	0.101	0.332	0.099	0.78	1.11
		Right Tilted	0.250	0.473	0.078	0.381	0.099	0.80	1.20
		Left Cheek	0.250	0.696	0.279	0.519	0.099	1.23	1.56
		Left Tilted	0.250	0.699	0.206	0.545	0.099	1.16	1.59
LTE Band 5(26) ANT 0	FR1 n7 ANT 4	Right Cheek	0.211	0.950	0.101	0.332	0.099	1.26	1.59
		Right Tilted	0.119	0.745	0.078	0.381	0.099	0.94	1.34
		Left Cheek	0.186	0.549	0.279	0.519	0.099	1.01	1.35
		Left Tilted	0.098	0.660	0.206	0.545	0.099	0.96	1.40
LTE Band 5(26) ANT 4	FR1 n7 ANT 0	Right Cheek	0.376		0.101	0.332	0.099	0.48	0.81
		Right Tilted	0.376		0.078	0.381	0.099	0.45	0.86
		Left Cheek	0.376	0.106	0.279	0.519	0.099	0.76	1.10
		Left Tilted	0.376		0.206	0.545	0.099	0.58	1.02
LTE Band 7 ANT 0	FR1 n5 ANT 4	Right Cheek	0.090	0.771	0.101	0.332	0.099	0.96	1.29
		Right Tilted	0.049	0.607	0.078	0.381	0.099	0.73	1.14
		Left Cheek	0.159	0.750	0.279	0.519	0.099	1.19	1.53
		Left Tilted	0.090	0.653	0.206	0.545	0.099	0.95	1.39
LTE Band 7 ANT 4	FR1 n5 ANT 0	Right Cheek	0.343	0.254	0.101	0.332	0.099	0.70	1.03
		Right Tilted	0.343	0.137	0.078	0.381	0.099	0.56	0.96
		Left Cheek	0.343	0.228	0.279	0.519	0.099	0.85	1.19
		Left Tilted	0.343	0.120	0.206	0.545	0.099	0.67	1.11
LTE Band 5(26) ANT 0	FR1 n78(77) ANT 3	Right Cheek	0.211	0.793	0.101	0.332	0.099	1.11	1.44
		Right Tilted	0.119	0.443	0.078	0.381	0.099	0.64	1.04
		Left Cheek	0.186	0.246	0.279	0.519	0.099	0.71	1.05
		Left Tilted	0.098	0.204	0.206	0.545	0.099	0.51	0.95
LTE Band 5(26) ANT 0	FR1 n78(77) ANT 5	Right Cheek	0.211	0.430	0.101	0.332	0.099	0.74	1.07
		Right Tilted	0.119	0.473	0.078	0.381	0.099	0.67	1.07
		Left Cheek	0.186	0.696	0.279	0.519	0.099	1.16	1.50



LTE Band 5(26) ANT 4	FR1 n78(77) ANT 3	Left Tilted	0.098	0.699	0.206	0.545	0.099	1.00	1.44
		Right Cheek	0.249	0.793	0.101	0.332	0.099	1.14	1.47
		Right Tilted	0.249	0.443	0.078	0.381	0.099	0.77	1.17
		Left Cheek	0.249	0.246	0.279	0.519	0.099	0.77	1.11
		Left Tilted	0.249	0.204	0.206	0.545	0.099	0.66	1.10
LTE Band 5(26) ANT 4	FR1 n78(77) ANT 5	Right Cheek	0.249	0.430	0.101	0.332	0.099	0.78	1.11
		Right Tilted	0.249	0.473	0.078	0.381	0.099	0.80	1.20
		Left Cheek	0.249	0.696	0.279	0.519	0.099	1.22	1.56
		Left Tilted	0.249	0.699	0.206	0.545	0.099	1.15	1.59
LTE Band 7 ANT 0	FR1 n78(77) ANT 3	Right Cheek	0.090	0.793	0.101	0.332	0.099	0.98	1.31
		Right Tilted	0.049	0.443	0.078	0.381	0.099	0.57	0.97
		Left Cheek	0.159	0.246	0.279	0.519	0.099	0.68	1.02
		Left Tilted	0.090	0.204	0.206	0.545	0.099	0.50	0.94
LTE Band 7 ANT 0	FR1 n78(77) ANT 5	Right Cheek	0.090	0.430	0.101	0.332	0.099	0.62	0.95
		Right Tilted	0.049	0.473	0.078	0.381	0.099	0.60	1.00
		Left Cheek	0.159	0.696	0.279	0.519	0.099	1.13	1.47
		Left Tilted	0.090	0.699	0.206	0.545	0.099	1.00	1.43
LTE Band 7 ANT 4	FR1 n78(77) ANT 3	Right Cheek	0.240	0.793	0.101	0.332	0.099	1.13	1.46
		Right Tilted	0.240	0.443	0.078	0.381	0.099	0.76	1.16
		Left Cheek	0.240	0.246	0.279	0.519	0.099	0.77	1.10
		Left Tilted	0.240	0.204	0.206	0.545	0.099	0.65	1.09
LTE Band 7 ANT 4	FR1 n78(77) ANT 5	Right Cheek	0.240	0.430	0.101	0.332	0.099	0.77	1.10
		Right Tilted	0.240	0.473	0.078	0.381	0.099	0.79	1.19
		Left Cheek	0.240	0.696	0.279	0.519	0.099	1.22	1.55
		Left Tilted	0.240	0.699	0.206	0.545	0.099	1.15	1.58
LTE Band 41(38) ANT 0	FR1 n78(77) ANT 3	Right Cheek	0.067	0.793	0.101	0.332	0.099	0.96	1.29
		Right Tilted	0.053	0.443	0.078	0.381	0.099	0.57	0.98
		Left Cheek	0.124	0.246	0.279	0.519	0.099	0.65	0.99
		Left Tilted	0.060	0.204	0.206	0.545	0.099	0.47	0.91
LTE Band 41(38) ANT 0	FR1 n78(77) ANT 5	Right Cheek	0.067	0.430	0.101	0.332	0.099	0.60	0.93
		Right Tilted	0.053	0.473	0.078	0.381	0.099	0.60	1.01
		Left Cheek	0.124	0.696	0.279	0.519	0.099	1.10	1.44
		Left Tilted	0.060	0.699	0.206	0.545	0.099	0.97	1.40
LTE Band 41(38) ANT 4	FR1 n78(77) ANT 3	Right Cheek	0.245	0.793	0.101	0.332	0.099	1.14	1.47
		Right Tilted	0.245	0.443	0.078	0.381	0.099	0.77	1.17
		Left Cheek	0.245	0.246	0.279	0.519	0.099	0.77	1.11
		Left Tilted	0.245	0.204	0.206	0.545	0.099	0.66	1.09
LTE Band 41(38) ANT 4	FR1 n78(77) ANT 5	Right Cheek	0.245	0.430	0.101	0.332	0.099	0.78	1.11
		Right Tilted	0.245	0.473	0.078	0.381	0.099	0.80	1.20
		Left Cheek	0.245	0.696	0.279	0.519	0.099	1.22	1.56
		Left Tilted	0.245	0.699	0.206	0.545	0.099	1.15	1.59

<Inter-Band UL CA>

WWAN Band	WWAN Band	Exposure Position	1	2	3	4	5	1+2+3	1+2+4+5
			WWAN	WWAN	WLAN2.4GHz	WLAN5GHz	Bluetooth	Summed	Summed
			1g SAR (W/kg)	1g SAR (W/kg)	1g SAR (W/kg)	1g SAR (W/kg)	1g SAR (W/kg)		
LTE Band 4 ANT 0	LTE Band 7 ANT 4	Right Cheek	0.132	0.854	0.101	0.332	0.099	1.09	1.42
		Right Tilted	0.089	0.679	0.078	0.381	0.099	0.85	1.25
		Left Cheek	0.111	0.492	0.279	0.519	0.099	0.88	1.22
		Left Tilted	0.097	0.589	0.206	0.545	0.099	0.89	1.33
LTE Band 4 ANT 4	LTE Band 7 ANT 0	Right Cheek	0.332	0.090	0.101	0.332	0.099	0.52	0.85
		Right Tilted	0.285	0.049	0.078	0.381	0.099	0.41	0.81
		Left Cheek	0.218	0.159	0.279	0.519	0.099	0.66	1.00
		Left Tilted	0.306	0.090	0.206	0.545	0.099	0.60	1.04



16.2 Hotspot Exposure Conditions

WWAN Band	Exposure Position	1	2	3	4	1+2 Summed 1g SAR (W/kg)	1+3+4 Summed 1g SAR (W/kg)
		WWAN	WLAN2.4GHz Ant 6	WLAN5GHz Ant 6	Bluetooth Ant 6		
		1g SAR (W/kg)	1g SAR (W/kg)	1g SAR (W/kg)	1g SAR (W/kg)		
WWAN ALL BAND	Front	0.406	0.216	0.425	0.025	0.62	0.86
	Back	0.874	0.244	0.686	0.025	1.12	1.59
	Left side	0.467			0.025	0.47	0.49
	Right side	0.336	0.230	0.390	0.025	0.57	0.75
	Top side	0.791	0.198	0.685	0.025	0.99	1.50
	Bottom side	1.088			0.025	1.09	1.11

<5G NR ENDC>

WWAN Band	FR1 Band	Exposure Position	1	2	3	4	5	1+2+3 Summed 1g SAR (W/kg)	1+2+4+5 Summed 1g SAR (W/kg)
			WWAN	FR1	WLAN2.4GHz Ant 6	WLAN5GHz Ant 6	Bluetooth Ant 6		
			1g SAR (W/kg)	1g SAR (W/kg)	1g SAR (W/kg)	1g SAR (W/kg)	1g SAR (W/kg)		
LTE Band 2 ANT0	FR1 n77(78) ANT 3	Front	0.250	0.238	0.216	0.425	0.025	0.70	0.94
		Back	0.534	0.329	0.244	0.686	0.025	1.11	1.57
		Left side	0.245	0.430			0.025	0.68	0.70
		Right side	0.126	0.011	0.230	0.390	0.025	0.37	0.55
		Top side		0.102	0.198	0.685	0.025	0.30	0.81
		Bottom side	0.633				0.025	0.63	0.66
LTE Band 2 ANT0	FR1 n77(78) ANT 5	Front	0.250	0.148	0.216	0.425	0.025	0.61	0.85
		Back	0.534	0.238	0.244	0.686	0.025	1.02	1.48
		Left side	0.245	0.031			0.025	0.28	0.30
		Right side	0.126	0.116	0.230	0.390	0.025	0.47	0.66
		Top side		0.231	0.198	0.685	0.025	0.43	0.94
		Bottom side	0.633				0.025	0.63	0.66
LTE Band 2 ANT4	FR1 n77(78) ANT 3	Front	0.188	0.238	0.216	0.425	0.025	0.64	0.88
		Back	0.251	0.329	0.244	0.686	0.025	0.82	1.29
		Left side	0.228	0.430			0.025	0.66	0.68
		Right side	0.177	0.011	0.230	0.390	0.025	0.42	0.60
		Top side	0.374	0.102	0.198	0.685	0.025	0.67	1.19
		Bottom side					0.025	0.00	0.03
LTE Band 2 ANT 4	FR1 n77(78) ANT 5	Front	0.188	0.148	0.216	0.425	0.025	0.55	0.79
		Back	0.251	0.238	0.244	0.686	0.025	0.73	1.20
		Left side	0.228	0.031			0.025	0.26	0.28
		Right side	0.177	0.116	0.230	0.390	0.025	0.52	0.71
		Top side	0.374	0.231	0.198	0.685	0.025	0.80	1.32
		Bottom side					0.025	0.00	0.03
LTE Band 5(26) ANT 0	FR1 n7 ANT 4	Front	0.265	0.274	0.216	0.425	0.025	0.76	0.99
		Back	0.456	0.394	0.244	0.686	0.025	1.09	1.56
		Left side	0.134	0.310			0.025	0.44	0.47
		Right side	0.221		0.230	0.390	0.025	0.45	0.64
		Top side		0.791	0.198	0.685	0.025	0.99	1.50
		Bottom side	0.387				0.025	0.39	0.41
LTE Band 5(26) ANT 4	FR1 n7 ANT 0	Front	0.224	0.069	0.216	0.425	0.025	0.51	0.74
		Back	0.397	0.153	0.244	0.686	0.025	0.79	1.26
		Left side	0.096	0.029			0.025	0.13	0.15
		Right side	0.110		0.230	0.390	0.025	0.34	0.53
		Top side	0.212		0.198	0.685	0.025	0.41	0.92
		Bottom side		0.109			0.025	0.11	0.13



FCC SAR Test Report

Report No. : FA1N1013-01

LTE Band 7 ANT 0	FR1 n5 ANT 4	Front	0.126	0.203	0.216	0.425	0.025	0.55	0.78
		Back	0.294	0.387	0.244	0.686	0.025	0.93	1.39
		Left side	0.152	0.087			0.025	0.24	0.26
		Right side	0.112	0.104	0.230	0.390	0.025	0.45	0.63
		Top side		0.221	0.198	0.685	0.025	0.42	0.93
		Bottom side	0.220				0.025	0.22	0.25
LTE Band 7 ANT 4	FR1 n5 ANT 0	Front	0.192	0.295	0.216	0.425	0.025	0.70	0.94
		Back	0.278	0.536	0.244	0.686	0.025	1.06	1.53
		Left side	0.429	0.153			0.025	0.58	0.61
		Right side	0.105	0.251	0.230	0.390	0.025	0.59	0.77
		Top side	0.492		0.198	0.685	0.025	0.69	1.20
		Bottom side		0.477			0.025	0.48	0.50
LTE Band 5(26) ANT 0	FR1 n78(77) ANT 3	Front	0.265	0.238	0.216	0.425	0.025	0.72	0.95
		Back	0.456	0.329	0.244	0.686	0.025	1.03	1.50
		Left side	0.134	0.430			0.025	0.56	0.59
		Right side	0.221	0.011	0.230	0.390	0.025	0.46	0.65
		Top side		0.102	0.198	0.685	0.025	0.30	0.81
		Bottom side	0.387				0.025	0.39	0.41
LTE Band 5(26) ANT 0	FR1 n78(77) ANT 5	Front	0.265	0.148	0.216	0.425	0.025	0.63	0.86
		Back	0.456	0.238	0.244	0.686	0.025	0.94	1.41
		Left side	0.134	0.031			0.025	0.17	0.19
		Right side	0.221	0.116	0.230	0.390	0.025	0.57	0.75
		Top side		0.231	0.198	0.685	0.025	0.43	0.94
		Bottom side	0.387				0.025	0.39	0.41
LTE Band 5(26) ANT 4	FR1 n78(77) ANT 3	Front	0.224	0.238	0.216	0.425	0.025	0.68	0.91
		Back	0.397	0.329	0.244	0.686	0.025	0.97	1.44
		Left side	0.096	0.430			0.025	0.53	0.55
		Right side	0.110	0.011	0.230	0.390	0.025	0.35	0.54
		Top side	0.212	0.102	0.198	0.685	0.025	0.51	1.02
		Bottom side					0.025	0.00	0.03
LTE Band 5(26) ANT 4	FR1 n78(77) ANT 5	Front	0.224	0.148	0.216	0.425	0.025	0.59	0.82
		Back	0.397	0.238	0.244	0.686	0.025	0.88	1.35
		Left side	0.096	0.031			0.025	0.13	0.15
		Right side	0.110	0.116	0.230	0.390	0.025	0.46	0.64
		Top side	0.212	0.231	0.198	0.685	0.025	0.64	1.15
		Bottom side					0.025	0.00	0.03
LTE Band 7 ANT 0	FR1 n78(77) ANT 3	Front	0.126	0.238	0.216	0.425	0.025	0.58	0.81
		Back	0.294	0.329	0.244	0.686	0.025	0.87	1.33
		Left side	0.152	0.430			0.025	0.58	0.61
		Right side	0.112	0.011	0.230	0.390	0.025	0.35	0.54
		Top side		0.102	0.198	0.685	0.025	0.30	0.81
		Bottom side	0.220				0.025	0.22	0.25
LTE Band 7 ANT 0	FR1 n78(77) ANT 5	Front	0.126	0.148	0.216	0.425	0.025	0.49	0.72
		Back	0.294	0.238	0.244	0.686	0.025	0.78	1.24
		Left side	0.152	0.031			0.025	0.18	0.21
		Right side	0.112	0.116	0.230	0.390	0.025	0.46	0.64
		Top side		0.231	0.198	0.685	0.025	0.43	0.94
		Bottom side	0.220				0.025	0.22	0.25
LTE Band 7 ANT 4	FR1 n78(77) ANT 3	Front	0.192	0.238	0.216	0.425	0.025	0.65	0.88
		Back	0.278	0.329	0.244	0.686	0.025	0.85	1.32
		Left side	0.429	0.430			0.025	0.86	0.88
		Right side	0.105	0.011	0.230	0.390	0.025	0.35	0.53
		Top side	0.492	0.102	0.198	0.685	0.025	0.79	1.30
		Bottom side					0.025	0.00	0.03
LTE Band 7 ANT 4	FR1 n78(77) ANT 5	Front	0.192	0.148	0.216	0.425	0.025	0.56	0.79
		Back	0.278	0.238	0.244	0.686	0.025	0.76	1.23



FCC SAR Test Report

Report No. : FA1N1013-01

		Left side	0.429	0.031			0.025	0.46	0.49
		Right side	0.105	0.116	0.230	0.390	0.025	0.45	0.64
		Top side	0.492	0.231	0.198	0.685	0.025	0.92	1.43
		Bottom side					0.025	0.00	0.03
LTE Band 41(38) ANT 0	FR1 n78(77) ANT 3	Front	0.244	0.238	0.216	0.425	0.025	0.70	0.93
		Back	0.518	0.329	0.244	0.686	0.025	1.09	1.56
		Left side	0.120	0.430			0.025	0.55	0.58
		Right side	0.079	0.011	0.230	0.390	0.025	0.32	0.51
		Top side		0.102	0.198	0.685	0.025	0.30	0.81
		Bottom side	0.390				0.025	0.39	0.42
LTE Band 41(38) ANT 0	FR1 n78(77) ANT 5	Front	0.244	0.148	0.216	0.425	0.025	0.61	0.84
		Back	0.518	0.238	0.244	0.686	0.025	1.00	1.47
		Left side	0.120	0.031			0.025	0.15	0.18
		Right side	0.079	0.116	0.230	0.390	0.025	0.43	0.61
		Top side		0.231	0.198	0.685	0.025	0.43	0.94
		Bottom side	0.390				0.025	0.39	0.42
LTE Band 41(38) ANT 4	FR1 n78(77) ANT 3	Front	0.215	0.238	0.216	0.425	0.025	0.67	0.90
		Back	0.354	0.329	0.244	0.686	0.025	0.93	1.39
		Left side	0.226	0.430			0.025	0.66	0.68
		Right side	0.056	0.011	0.230	0.390	0.025	0.30	0.48
		Top side	0.571	0.102	0.198	0.685	0.025	0.87	1.38
		Bottom side					0.025	0.00	0.03
LTE Band 41(38) ANT 4	FR1 n78(77) ANT 5	Front	0.215	0.148	0.216	0.425	0.025	0.58	0.81
		Back	0.354	0.238	0.244	0.686	0.025	0.84	1.30
		Left side	0.226	0.031			0.025	0.26	0.28
		Right side	0.056	0.116	0.230	0.390	0.025	0.40	0.59
		Top side	0.571	0.231	0.198	0.685	0.025	1.00	1.51
		Bottom side					0.025	0.00	0.03



Sensor off:

WWAN Band	FR1 Band	Exposure Position	1	2	3	4	5	1+2+3	1+2+4+5
			WWAN	FR1	WLAN2.4GHz Ant 6	WLAN5GHz Ant 6	Bluetooth Ant 6	Summed	Summed
			1g SAR (W/kg)	1g SAR (W/kg)	1g SAR (W/kg)	1g SAR (W/kg)	1g SAR (W/kg)	1g SAR (W/kg)	1g SAR (W/kg)
LTE Band 2 ANT0	FR1 n77(78) ANT 3	Front	0.338		0.216	0.425	0.025	0.55	0.79
		Back	0.533		0.244	0.686	0.025	0.78	1.24
		Left side					0.025	0.00	0.03
		Right side			0.230	0.390	0.025	0.23	0.42
		Top side			0.198	0.685	0.025	0.20	0.71
		Bottom side	0.794				0.025	0.79	0.82
LTE Band 2 ANT0	FR1 n77(78) ANT 5	Front	0.338	0.070	0.216	0.425	0.025	0.62	0.86
		Back	0.533	0.287	0.244	0.686	0.025	1.06	1.53
		Left side					0.025	0.00	0.03
		Right side			0.230	0.390	0.025	0.23	0.42
		Top side		0.102	0.198	0.685	0.025	0.30	0.81
		Bottom side	0.794				0.025	0.79	0.82
LTE Band 2 ANT4	FR1 n77(78) ANT 3	Front	0.190		0.216	0.425	0.025	0.41	0.64
		Back	0.129		0.244	0.686	0.025	0.37	0.84
		Left side					0.025	0.00	0.03
		Right side			0.230	0.390	0.025	0.23	0.42
		Top side	0.341		0.198	0.685	0.025	0.54	1.05
		Bottom side					0.025	0.00	0.03
LTE Band 2 ANT 4	FR1 n77(78) ANT 5	Front	0.190	0.070	0.216	0.425	0.025	0.48	0.71
		Back	0.129	0.287	0.244	0.686	0.025	0.66	1.13
		Left side					0.025	0.00	0.03
		Right side			0.230	0.390	0.025	0.23	0.42
		Top side	0.341	0.102	0.198	0.685	0.025	0.64	1.15
		Bottom side					0.025	0.00	0.03
LTE Band 7 ANT 0	FR1 n5 ANT 4	Front	0.199		0.216	0.425	0.025	0.42	0.65
		Back	0.208		0.244	0.686	0.025	0.45	0.92
		Left side					0.025	0.00	0.03
		Right side			0.230	0.390	0.025	0.23	0.42
		Top side			0.198	0.685	0.025	0.20	0.71
		Bottom side	0.363				0.025	0.36	0.39
LTE Band 7 ANT 4	FR1 n5 ANT 0	Front	0.188		0.216	0.425	0.025	0.40	0.64
		Back	0.149		0.244	0.686	0.025	0.39	0.86
		Left side					0.025	0.00	0.03
		Right side			0.230	0.390	0.025	0.23	0.42
		Top side	0.553		0.198	0.685	0.025	0.75	1.26
		Bottom side					0.025	0.00	0.03
LTE Band 7 ANT 0	FR1 n78(77) ANT 3	Front	0.199		0.216	0.425	0.025	0.42	0.65
		Back	0.208		0.244	0.686	0.025	0.45	0.92
		Left side					0.025	0.00	0.03
		Right side			0.230	0.390	0.025	0.23	0.42
		Top side			0.198	0.685	0.025	0.20	0.71
		Bottom side	0.363				0.025	0.36	0.39
LTE Band 7 ANT 0	FR1 n78(77) ANT 5	Front	0.199	0.070	0.216	0.425	0.025	0.49	0.72
		Back	0.208	0.287	0.244	0.686	0.025	0.74	1.21
		Left side					0.025	0.00	0.03
		Right side			0.230	0.390	0.025	0.23	0.42
		Top side		0.102	0.198	0.685	0.025	0.30	0.81
		Bottom side	0.363				0.025	0.36	0.39
LTE Band 7 ANT 4	FR1 n78(77) ANT 3	Front	0.188		0.216	0.425	0.025	0.40	0.64
		Back	0.149		0.244	0.686	0.025	0.39	0.86



		Left side					0.025	0.00	0.03
		Right side			0.230	0.390	0.025	0.23	0.42
		Top side	0.553		0.198	0.685	0.025	0.75	1.26
		Bottom side					0.025	0.00	0.03
LTE Band 7 ANT 4	FR1 n78(77) ANT 5	Front	0.188	0.070	0.216	0.425	0.025	0.47	0.71
		Back	0.149	0.287	0.244	0.686	0.025	0.68	1.15
		Left side					0.025	0.00	0.03
		Right side			0.230	0.390	0.025	0.23	0.42
		Top side	0.553	0.102	0.198	0.685	0.025	0.85	1.37
		Bottom side					0.025	0.00	0.03
LTE Band 41(38) ANT 0	FR1 n78(77) ANT 3	Front	0.156		0.216	0.425	0.025	0.37	0.61
		Back	0.128		0.244	0.686	0.025	0.37	0.84
		Left side					0.025	0.00	0.03
		Right side			0.230	0.390	0.025	0.23	0.42
		Top side			0.198	0.685	0.025	0.20	0.71
		Bottom side	0.266				0.025	0.27	0.29
LTE Band 41(38) ANT 0	FR1 n78(77) ANT 5	Front	0.156	0.070	0.216	0.425	0.025	0.44	0.68
		Back	0.128	0.287	0.244	0.686	0.025	0.66	1.13
		Left side					0.025	0.00	0.03
		Right side			0.230	0.390	0.025	0.23	0.42
		Top side		0.102	0.198	0.685	0.025	0.30	0.81
		Bottom side	0.266				0.025	0.27	0.29
LTE Band 41(38) ANT 4	FR1 n78(77) ANT 3	Front	0.113		0.216	0.425	0.025	0.33	0.56
		Back	0.119		0.244	0.686	0.025	0.36	0.83
		Left side					0.025	0.00	0.03
		Right side			0.230	0.390	0.025	0.23	0.42
		Top side	0.310		0.198	0.685	0.025	0.51	1.02
		Bottom side					0.025	0.00	0.03
LTE Band 41(38) ANT 4	FR1 n78(77) ANT 5	Front	0.113	0.070	0.216	0.425	0.025	0.40	0.63
		Back	0.119	0.287	0.244	0.686	0.025	0.65	1.12
		Left side					0.025	0.00	0.03
		Right side			0.230	0.390	0.025	0.23	0.42
		Top side	0.310	0.102	0.198	0.685	0.025	0.61	1.12
		Bottom side					0.025	0.00	0.03

<Inter-Band UL CA>

WWAN Band	WWAN Band	Exposure Position	1	2	3	4	5	1+2+3	1+2+4+5
			WWAN 1g SAR (W/kg)	WWAN 1g SAR (W/kg)	WLAN2.4GHz Ant 6 1g SAR (W/kg)	WLAN5GHz Ant 6 1g SAR (W/kg)	Bluetooth Ant 6 1g SAR (W/kg)	Summed 1g SAR (W/kg)	Summed 1g SAR (W/kg)
LTE Band 4 ANT 0	LTE Band 7 ANT 4	Front	0.237	0.192	0.216	0.425	0.025	0.65	0.88
		Back	0.558	0.278	0.244	0.686	0.025	1.08	1.55
		Left side	0.155	0.429			0.025	0.58	0.61
		Right side	0.147	0.105	0.230	0.390	0.025	0.48	0.67
		Top side		0.553	0.198	0.685	0.025	0.75	1.26
		Bottom side	0.773				0.025	0.77	0.80
LTE Band 4 ANT 4	LTE Band 7 ANT 0	Front	0.135	0.199	0.216	0.425	0.025	0.55	0.78
		Back	0.139	0.294	0.244	0.686	0.025	0.68	1.14
		Left side	0.165	0.152			0.025	0.32	0.34
		Right side	0.060	0.112	0.230	0.390	0.025	0.40	0.59
		Top side	0.202		0.198	0.685	0.025	0.40	0.91
		Bottom side		0.363			0.025	0.36	0.39



16.3 Body-Worn Accessory Exposure Conditions

WWAN Band	Exposure Position	1	2	3	4	1+2	1+3+4
		WWAN	WLAN2.4GHz Ant 6	WLAN5GHz Ant 6	Bluetooth Ant 6	Summed	Summed
		1g SAR (W/kg)	1g SAR (W/kg)	1g SAR (W/kg)	1g SAR (W/kg)	1g SAR (W/kg)	1g SAR (W/kg)
WWAN ALL bands	Front	0.362	0.216	0.425	0.025	0.58	0.81
	Back	0.874	0.244	0.686	0.025	1.12	1.59

<5G NR ENDC>

WWAN Band	FR1 Band	Exposure Position	1	2	3	4	5	1+2+3	1+2+4+5
			WWAN	FR1	WLAN2.4GHz Ant 6	WLAN5GHz Ant 6	Bluetooth Ant 6	Summed	Summed
			1g SAR (W/kg)	1g SAR (W/kg)	1g SAR (W/kg)	1g SAR (W/kg)	1g SAR (W/kg)	1g SAR (W/kg)	1g SAR (W/kg)
LTE Band 2 ANT0	FR1 n77(78) ANT 3	Front	0.250	0.238	0.216	0.425	0.025	0.70	0.94
		Back	0.534	0.329	0.244	0.686	0.025	1.11	1.57
LTE Band 2 ANT0	FR1 n77(78) ANT 5	Front	0.250	0.148	0.216	0.425	0.025	0.61	0.85
		Back	0.534	0.238	0.244	0.686	0.025	1.02	1.48
LTE Band 2 ANT4	FR1 n77(78) ANT 3	Front	0.188	0.238	0.216	0.425	0.025	0.64	0.88
		Back	0.251	0.329	0.244	0.686	0.025	0.82	1.29
LTE Band 2 ANT 4	FR1 n77(78) ANT 5	Front	0.188	0.148	0.216	0.425	0.025	0.55	0.79
		Back	0.251	0.238	0.244	0.686	0.025	0.73	1.20
LTE Band 5(26) ANT 0	FR1 n7 ANT 4	Front	0.265	0.274	0.216	0.425	0.025	0.76	0.99
		Back	0.456	0.394	0.244	0.686	0.025	1.09	1.56
LTE Band 5(26) ANT 4	FR1 n7 ANT 0	Front	0.224	0.069	0.216	0.425	0.025	0.51	0.74
		Back	0.397	0.153	0.244	0.686	0.025	0.79	1.26
LTE Band 7 ANT 0	FR1 n5 ANT 4	Front	0.126	0.203	0.216	0.425	0.025	0.55	0.78
		Back	0.294	0.387	0.244	0.686	0.025	0.93	1.39
LTE Band 7 ANT 4	FR1 n5 ANT 0	Front	0.192	0.295	0.216	0.425	0.025	0.70	0.94
		Back	0.278	0.536	0.244	0.686	0.025	1.06	1.53
LTE Band 5(26) ANT 0	FR1 n78(77) ANT 3	Front	0.265	0.238	0.216	0.425	0.025	0.72	0.95
		Back	0.456	0.329	0.244	0.686	0.025	1.03	1.50
LTE Band 5(26) ANT 0	FR1 n78(77) ANT 5	Front	0.265	0.148	0.216	0.425	0.025	0.63	0.86
		Back	0.456	0.238	0.244	0.686	0.025	0.94	1.41
LTE Band 5(26) ANT 4	FR1 n78(77) ANT 3	Front	0.224	0.238	0.216	0.425	0.025	0.68	0.91
		Back	0.397	0.329	0.244	0.686	0.025	0.97	1.44
LTE Band 5(26) ANT 4	FR1 n78(77) ANT 5	Front	0.224	0.148	0.216	0.425	0.025	0.59	0.82
		Back	0.397	0.238	0.244	0.686	0.025	0.88	1.35
LTE Band 7 ANT 0	FR1 n78(77) ANT 3	Front	0.126	0.238	0.216	0.425	0.025	0.58	0.81
		Back	0.294	0.329	0.244	0.686	0.025	0.87	1.33
LTE Band 7 ANT 0	FR1 n78(77) ANT 5	Front	0.126	0.148	0.216	0.425	0.025	0.49	0.72
		Back	0.294	0.238	0.244	0.686	0.025	0.78	1.24
LTE Band 7 ANT 4	FR1 n78(77) ANT 3	Front	0.192	0.238	0.216	0.425	0.025	0.65	0.88
		Back	0.278	0.329	0.244	0.686	0.025	0.85	1.32
LTE Band 7 ANT 4	FR1 n78(77) ANT 5	Front	0.192	0.148	0.216	0.425	0.025	0.56	0.79
		Back	0.278	0.238	0.244	0.686	0.025	0.76	1.23
LTE Band 41(38) ANT 0	FR1 n78(77) ANT 3	Front	0.244	0.238	0.216	0.425	0.025	0.70	0.93
		Back	0.518	0.329	0.244	0.686	0.025	1.09	1.56
LTE Band 41(38) ANT 0	FR1 n78(77) ANT 5	Front	0.244	0.148	0.216	0.425	0.025	0.61	0.84
		Back	0.518	0.238	0.244	0.686	0.025	1.00	1.47
LTE Band 41(38) ANT 4	FR1 n78(77) ANT 3	Front	0.215	0.238	0.216	0.425	0.025	0.67	0.90
		Back	0.354	0.329	0.244	0.686	0.025	0.93	1.39
LTE Band 41(38) ANT 4	FR1 n78(77) ANT 5	Front	0.215	0.148	0.216	0.425	0.025	0.58	0.81
		Back	0.354	0.238	0.244	0.686	0.025	0.84	1.30



<Inter-Band UL CA>

WWAN Band	WWAN BAND	Exposure Position	1	2	2	3	4	1+2+3	1+2+4+5
			WWAN	WWAN	WLAN2.4GHz Ant 6	WLAN5GHz Ant 6	Bluetooth Ant 6	Summed	Summed
			1g SAR (W/kg)	1g SAR (W/kg)	1g SAR (W/kg)	1g SAR (W/kg)	1g SAR (W/kg)	1g SAR (W/kg)	1g SAR (W/kg)
LTE Band 4 ANT 0	LTE Band 7 ANT 4	Front	0.217	0.192	0.216	0.425	0.025	0.63	0.86
		Back	0.558	0.278	0.244	0.686	0.025	1.08	1.55
LTE Band 4 ANT 4	LTE Band 7 ANT 0	Front	0.117	0.126	0.216	0.425	0.025	0.46	0.69
		Back	0.139	0.294	0.244	0.686	0.025	0.68	1.14

Sensor off:

WWAN Band	Exposure Position	1	2	3	4	1+2	1+3+4
		WWAN	WLAN2.4GHz Ant 6	WLAN5GHz Ant 6	Bluetooth Ant 6	Summed	Summed
		1g SAR (W/kg)	1g SAR (W/kg)	1g SAR (W/kg)	1g SAR (W/kg)	1g SAR (W/kg)	1g SAR (W/kg)
WWAN ALL bands	Front	0.406	0.141	0.464	0.005	0.55	0.88
	Back	1.085	0.141	0.464	0.005	1.23	1.55

WWAN Band	FR1 Band	Exposure Position	1	2	3	4	5	1+2+3	1+2+4+5
			WWAN	FR1	WLAN2.4GHz Ant 6	WLAN5GHz Ant 6	Bluetooth Ant 6	Summed	Summed
			1g SAR (W/kg)	1g SAR (W/kg)	1g SAR (W/kg)	1g SAR (W/kg)	1g SAR (W/kg)	1g SAR (W/kg)	1g SAR (W/kg)
LTE Band 2 ANT0	FR1 n77(78) ANT 3	Front	0.338		0.141	0.464	0.005	0.48	0.81
		Back	0.679		0.141	0.464	0.005	0.82	1.15
LTE Band 2 ANT0	FR1 n77(78) ANT 5	Front	0.338	0.070	0.141	0.464	0.005	0.55	0.88
		Back	0.679	0.386	0.141	0.464	0.005	1.21	1.53
LTE Band 2 ANT4	FR1 n77(78) ANT 3	Front	0.190		0.141	0.464	0.005	0.33	0.66
		Back	0.224		0.141	0.464	0.005	0.37	0.69
LTE Band 2 ANT 4	FR1 n77(78) ANT 5	Front	0.190	0.070	0.141	0.464	0.005	0.40	0.73
		Back	0.224	0.386	0.141	0.464	0.005	0.75	1.08
LTE Band 7 ANT 0	FR1 n5 ANT 4	Front	0.199		0.141	0.464	0.005	0.34	0.67
		Back	0.382		0.141	0.464	0.005	0.52	0.85
LTE Band 7 ANT 4	FR1 n5 ANT 0	Front	0.188		0.141	0.464	0.005	0.33	0.66
		Back	0.258		0.141	0.464	0.005	0.40	0.73
LTE Band 5(26) ANT 0	FR1 n78(77) ANT 3	Front			0.141	0.464	0.005	0.14	0.47
		Back			0.141	0.464	0.005	0.14	0.47
LTE Band 5(26) ANT 0	FR1 n78(77) ANT 5	Front		0.070	0.141	0.464	0.005	0.21	0.54
		Back		0.386	0.141	0.464	0.005	0.53	0.86
LTE Band 5(26) ANT 4	FR1 n78(77) ANT 3	Front			0.141	0.464	0.005	0.14	0.47
		Back			0.141	0.464	0.005	0.14	0.47
LTE Band 5(26) ANT 4	FR1 n78(77) ANT 5	Front		0.070	0.141	0.464	0.005	0.21	0.54
		Back		0.386	0.141	0.464	0.005	0.53	0.86
LTE Band 7 ANT 0	FR1 n78(77) ANT 3	Front	0.199		0.141	0.464	0.005	0.34	0.67
		Back	0.382		0.141	0.464	0.005	0.52	0.85
LTE Band 7 ANT 0	FR1 n78(77) ANT 5	Front	0.199	0.070	0.141	0.464	0.005	0.41	0.74
		Back	0.382	0.386	0.141	0.464	0.005	0.91	1.24
LTE Band 7 ANT 4	FR1 n78(77) ANT 3	Front	0.188		0.141	0.464	0.005	0.33	0.66
		Back	0.258		0.141	0.464	0.005	0.40	0.73
LTE Band 7 ANT 4	FR1 n78(77) ANT 5	Front	0.188	0.070	0.141	0.464	0.005	0.40	0.73
		Back	0.258	0.386	0.141	0.464	0.005	0.79	1.11
LTE Band 41(38) ANT 0	FR1 n78(77) ANT 3	Front	0.156		0.141	0.464	0.005	0.30	0.63
		Back	0.284		0.141	0.464	0.005	0.43	0.75
LTE Band 41(38) ANT 0	FR1 n78(77) ANT 5	Front	0.156	0.070	0.141	0.464	0.005	0.37	0.70
		Back	0.284	0.386	0.141	0.464	0.005	0.81	1.14



LTE Band 41(38) ANT 4	FR1 n78(77) ANT 3	Front	0.113		0.141	0.464	0.005	0.25	0.58
		Back	0.178		0.141	0.464	0.005	0.32	0.65
LTE Band 41(38) ANT 4	FR1 n78(77) ANT 5	Front	0.113	0.070	0.141	0.464	0.005	0.32	0.65
		Back	0.178	0.386	0.141	0.464	0.005	0.71	1.03

<Inter-Band UL CA>

WWAN Band	WWAN BAND	Exposure Position	1	2	2	3	4	1+2+3	1+2+4+5
			WWAN	WWAN	WLAN2.4GHz Ant 6	WLAN5GHz Ant 6	Bluetooth Ant 6	Summed	Summed
			1g SAR (W/kg)	1g SAR (W/kg)	1g SAR (W/kg)	1g SAR (W/kg)	1g SAR (W/kg)	1g SAR (W/kg)	1g SAR (W/kg)
LTE Band 4 ANT 0	LTE Band 7 ANT 4	Front	0.237	0.188	0.141	0.464	0.005	0.57	0.89
		Back	0.793	0.258	0.141	0.464	0.005	1.19	1.52
LTE Band 4 ANT 4	LTE Band 7 ANT 0	Front	0.135	0.199	0.141	0.464	0.005	0.48	0.80
		Back	0.122	0.382	0.141	0.464	0.005	0.65	0.97

Test Engineer : Bruce Li, Martin Li, Ricky Gu



17. Uncertainty Assessment

Per KDB 865664 D01 SAR measurement 100MHz to 6GHz, when the highest measured 1-g SAR within a frequency band is < 1.5 W/kg and the measured 10-g SAR within a frequency band is < 3.75 W/kg. The expanded SAR measurement uncertainty must be $\leq 30\%$, for a confidence interval of $k = 2$. If these conditions are met, extensive SAR measurement uncertainty analysis described in IEEE Std 1528-2013 is not required in SAR reports submitted for equipment approval. For this device, the highest measured 1-g SAR is less 1.5W/kg and highest measured 10-g SAR is less 3.75W/kg. Therefore, the measurement uncertainty table is not required in this report.

18. References

- [1] FCC 47 CFR Part 2 "Frequency Allocations and Radio Treaty Matters; General Rules and Regulations"
- [2] ANSI/IEEE Std. C95.1-1992, "IEEE Standard for Safety Levels with Respect to Human Exposure to Radio Frequency Electromagnetic Fields, 3 kHz to 300 GHz", September 1992
- [3] IEEE Std. 1528-2013, "IEEE Recommended Practice for Determining the Peak Spatial-Average Specific Absorption Rate (SAR) in the Human Head from Wireless Communications Devices: Measurement Techniques", Sep 2013
- [4] SPEAG DASY System Handbook
- [5] FCC KDB 865664 D01 v01r04, "SAR Measurement Requirements for 100 MHz to 6 GHz", Aug 2015.
- [6] FCC KDB 865664 D02 v01r02, "RF Exposure Compliance Reporting and Documentation Considerations" Oct 2015.
- [7] FCC KDB 447498 D01 v06, "Mobile and Portable Device RF Exposure Procedures and Equipment Authorization Policies", Oct 2015
- [8] FCC KDB 648474 D04 v01r03, "SAR Evaluation Considerations for Wireless Handsets", Oct 2015.
- [9] FCC KDB 248227 D01 v02r02, "SAR Guidance for IEEE 802.11 (WiFi) Transmitters", Oct 2015.
- [10] FCC KDB 616217 D04 v01r02, "SAR Evaluation Considerations for Laptop, Notebook, Netbook and Tablet Computers", Oct 2015
- [11] FCC KDB 941225 D01 v03r01, "3G SAR MEAUREMENT PROCEDURES", Oct 2015
- [12] FCC KDB 941225 D05 v02r05, "SAR Evaluation Considerations for LTE Devices", Dec 2015
- [13] FCC KDB 941225 D05A v01r02, "Rel. 10 LTE SAR Test Guidance and KDB Inquiries", Oct 2015
- [14] FCC KDB 941225 D06 v02r01, "SAR Evaluation Procedures for Portable Devices with Wireless Router Capabilities", Oct 2015.

-----THE END-----



Appendix A. Plots of System Performance Check

The plots are shown as follows.

System Check_Head_750MHz

DUT: D750V3 - SN:1087

Communication System: UID 0, CW (0); Frequency: 750 MHz; Duty Cycle: 1:1
Medium: HSL_750 Medium parameters used: $f = 750 \text{ MHz}$; $\sigma = 0.915 \text{ S/m}$; $\epsilon_r = 41.844$; $\rho = 1000 \text{ kg/m}^3$

Ambient Temperature : 23.1 °C; Liquid Temperature : 22.7 °C

DASY5 Configuration:

- Probe: EX3DV4 - SN3857; ConvF(9.42, 9.42, 9.42); Calibrated: 2021.11.24
- Sensor-Surface: 1.4mm (Mechanical Surface Detection)
- Electronics: DAE4 Sn1649; Calibrated: 2021.2.3
- Phantom: SAM Twin Phantom; Type: SAM Twin; Serial: TP-1754
- Measurement SW: DASY52, Version 52.10 (4); SEMCAD X Version 14.6.14 (7483)

Pin=50mW/Area Scan (61x61x1): Interpolated grid: $dx=1.500 \text{ mm}$, $dy=1.500 \text{ mm}$
Maximum value of SAR (interpolated) = 0.572 W/kg

Pin=50mW/Zoom Scan (5x5x7)/Cube 0: Measurement grid: $dx=8\text{mm}$, $dy=8\text{mm}$, $dz=5\text{mm}$
Reference Value = 25.90 V/m; Power Drift = 0.09 dB
Peak SAR (extrapolated) = 0.649 W/kg
SAR(1 g) = 0.429 W/kg; SAR(10 g) = 0.282 W/kg
Maximum value of SAR (measured) = 0.576 W/kg

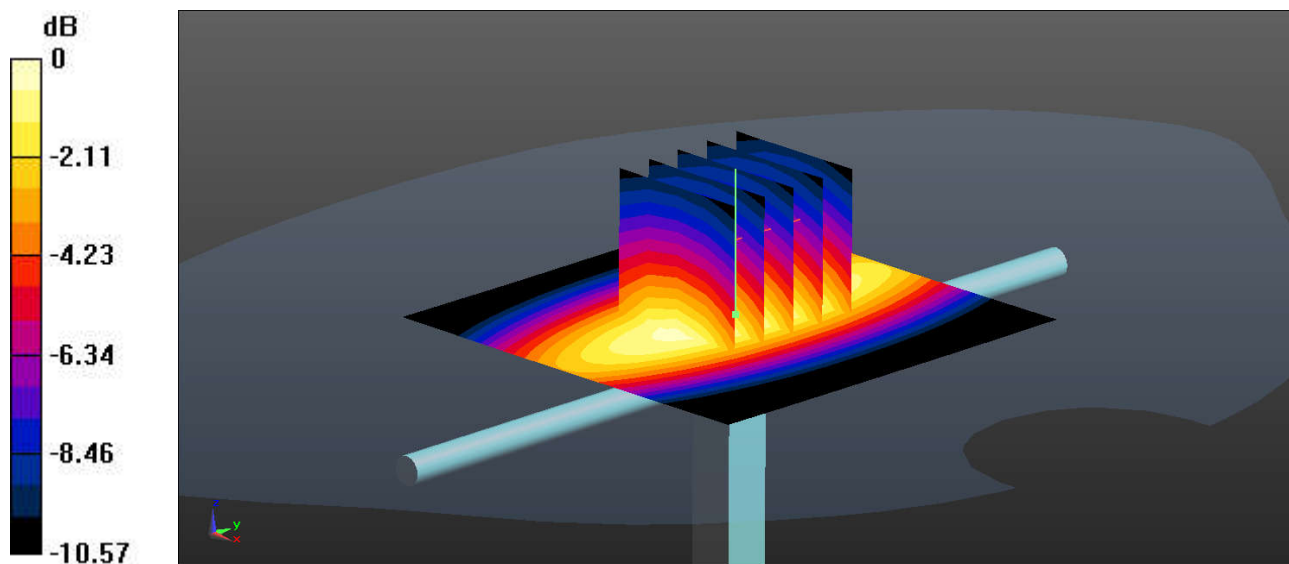

0 dB = 0.576 W/kg = -2.40 dBW/kg

System Check_Head_835MHz

DUT: D835V2 - SN:4d258

Communication System: UID 0, CW (0); Frequency: 835 MHz; Duty Cycle: 1:1
Medium: HSL_835 Medium parameters used: $f = 835 \text{ MHz}$; $\sigma = 0.938 \text{ S/m}$; $\epsilon_r = 42.44$; $\rho = 1000 \text{ kg/m}^3$

Ambient Temperature : 23.2 °C; Liquid Temperature : 22.7 °C

DASY5 Configuration:

- Probe: EX3DV4 - SN3857; ConvF(9.18, 9.18, 9.18); Calibrated: 2021.11.24
- Sensor-Surface: 1.4mm (Mechanical Surface Detection)
- Electronics: DAE4 Sn1649; Calibrated: 2021.2.3
- Phantom: SAM Twin Phantom; Type: SAM Twin; Serial: TP-1754
- Measurement SW: DASY52, Version 52.10 (4); SEMCAD X Version 14.6.14 (7483)

Pin=50mW/Area Scan (61x61x1): Interpolated grid: $dx=1.500 \text{ mm}$, $dy=1.500 \text{ mm}$
Maximum value of SAR (interpolated) = 0.689 W/kg

Pin=50mW/Zoom Scan (5x5x7)/Cube 0: Measurement grid: $dx=8\text{mm}$, $dy=8\text{mm}$, $dz=5\text{mm}$
Reference Value = 28.08 V/m; Power Drift = -0.03 dB
Peak SAR (extrapolated) = 0.780 W/kg
SAR(1 g) = 0.508 W/kg; SAR(10 g) = 0.331 W/kg
Maximum value of SAR (measured) = 0.688 W/kg

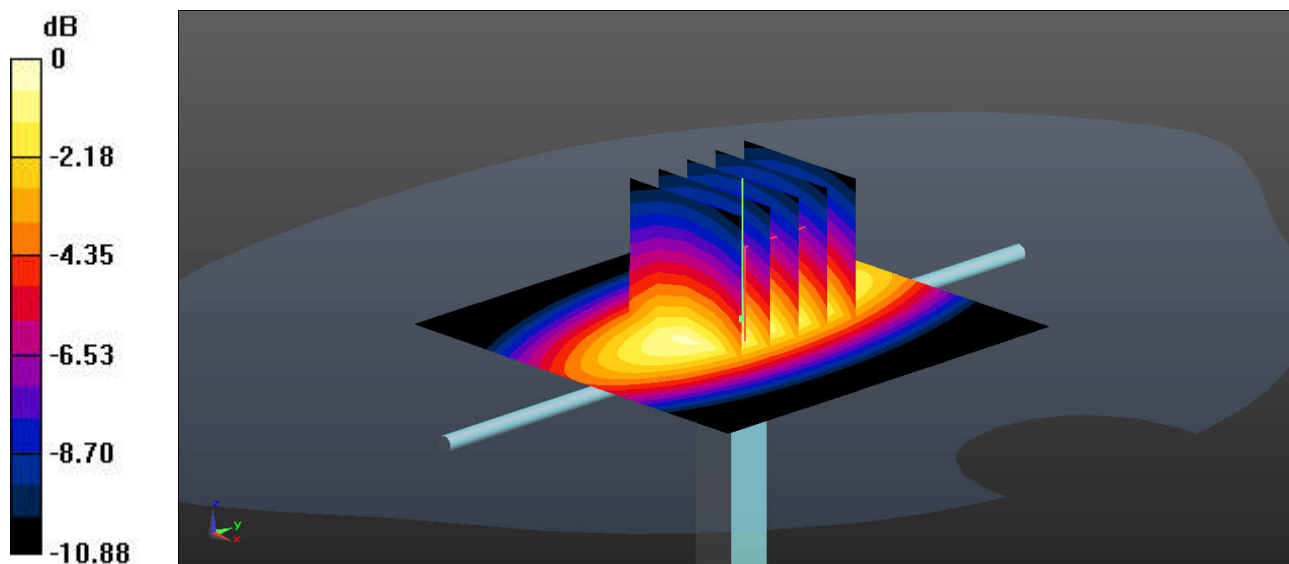

0 dB = 0.688 W/kg = -1.62 dBW/kg

System Check_Head_1750MHz

DUT: D1750V2 - SN:1090

Communication System: UID 0, CW (0); Frequency: 1750 MHz; Duty Cycle: 1:1
Medium: HSL_1750 Medium parameters used: $f = 1750$ MHz; $\sigma = 1.394$ S/m; $\epsilon_r = 40.496$; $\rho = 1000$ kg/m³

Ambient Temperature : 23.2 °C; Liquid Temperature : 22.6 °C

DASY5 Configuration:

- Probe: EX3DV4 - SN3857; ConvF(8.13, 8.13, 8.13); Calibrated: 2021.11.24
- Sensor-Surface: 1.4mm (Mechanical Surface Detection)
- Electronics: DAE4 Sn1649; Calibrated: 2021.2.3
- Phantom: SAM Twin Phantom; Type: SAM Twin; Serial: TP-1754
- Measurement SW: DASY52, Version 52.10 (4); SEMCAD X Version 14.6.14 (7483)

Pin=50mW/Area Scan (61x61x1): Interpolated grid: dx=1.500 mm, dy=1.500 mm
Maximum value of SAR (interpolated) = 3.00 W/kg

Pin=50mW/Zoom Scan (5x5x7)/Cube 0: Measurement grid: dx=8mm, dy=8mm, dz=5mm
Reference Value = 44.46 V/m; Power Drift = 0.11 dB
Peak SAR (extrapolated) = 3.54 W/kg
SAR(1 g) = 1.9 W/kg; SAR(10 g) = 0.999 W/kg
Maximum value of SAR (measured) = 2.96 W/kg

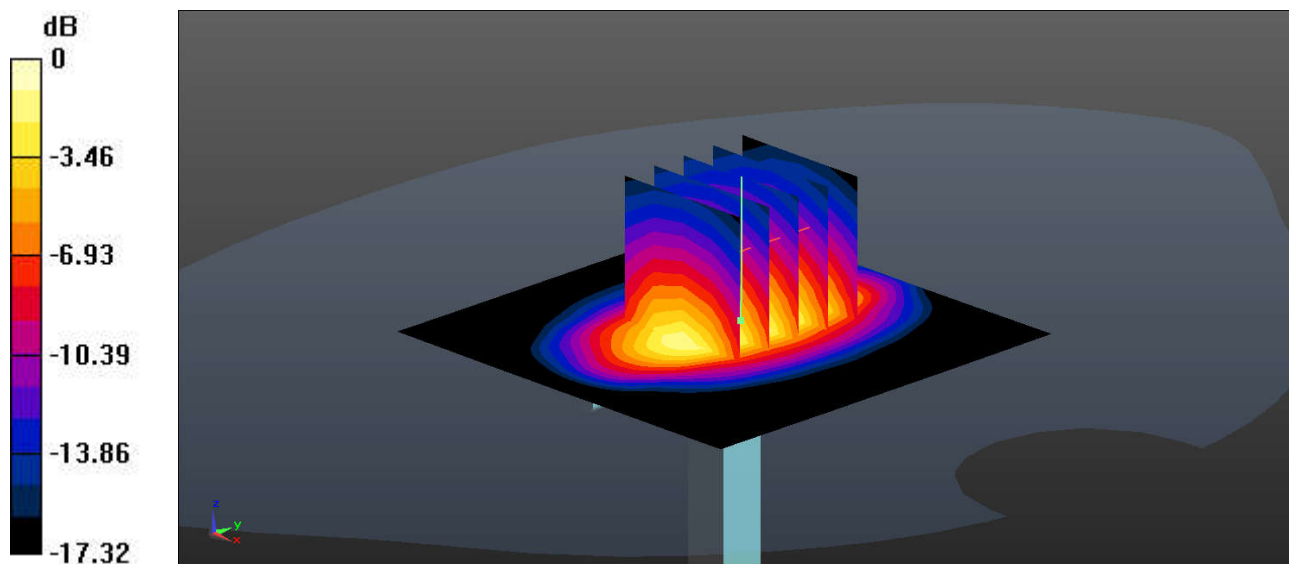

0 dB = 2.96 W/kg = 4.71 dBW/kg

System Check_Head_1900MHz

DUT: D1900V2 - SN:5d170

Communication System: UID 0, CW (0); Frequency: 1900 MHz; Duty Cycle: 1:1
Medium: HSL_1900 Medium parameters used: $f = 1900$ MHz; $\sigma = 1.458$ S/m; $\epsilon_r = 39.79$; $\rho = 1000$ kg/m³

Ambient Temperature : 23.3 °C; Liquid Temperature : 22.6 °C

DASY5 Configuration:

- Probe: EX3DV4 - SN3857; ConvF(7.86, 7.86, 7.86); Calibrated: 2021.11.24
- Sensor-Surface: 1.4mm (Mechanical Surface Detection)
- Electronics: DAE4 Sn1649; Calibrated: 2021.2.3
- Phantom: SAM Twin Phantom; Type: SAM Twin; Serial: TP-1754
- Measurement SW: DASY52, Version 52.10 (4); SEMCAD X Version 14.6.14 (7483)

Pin=50mW/Area Scan (61x61x1): Interpolated grid: dx=1.500 mm, dy=1.500 mm
Maximum value of SAR (interpolated) = 3.31 W/kg

Pin=50mW/Zoom Scan (5x5x7)/Cube 0: Measurement grid: dx=8mm, dy=8mm, dz=5mm
Reference Value = 48.93 V/m; Power Drift = -0.06 dB
Peak SAR (extrapolated) = 4.03 W/kg
SAR(1 g) = 2.1 W/kg; SAR(10 g) = 1.09 W/kg
Maximum value of SAR (measured) = 3.36 W/kg

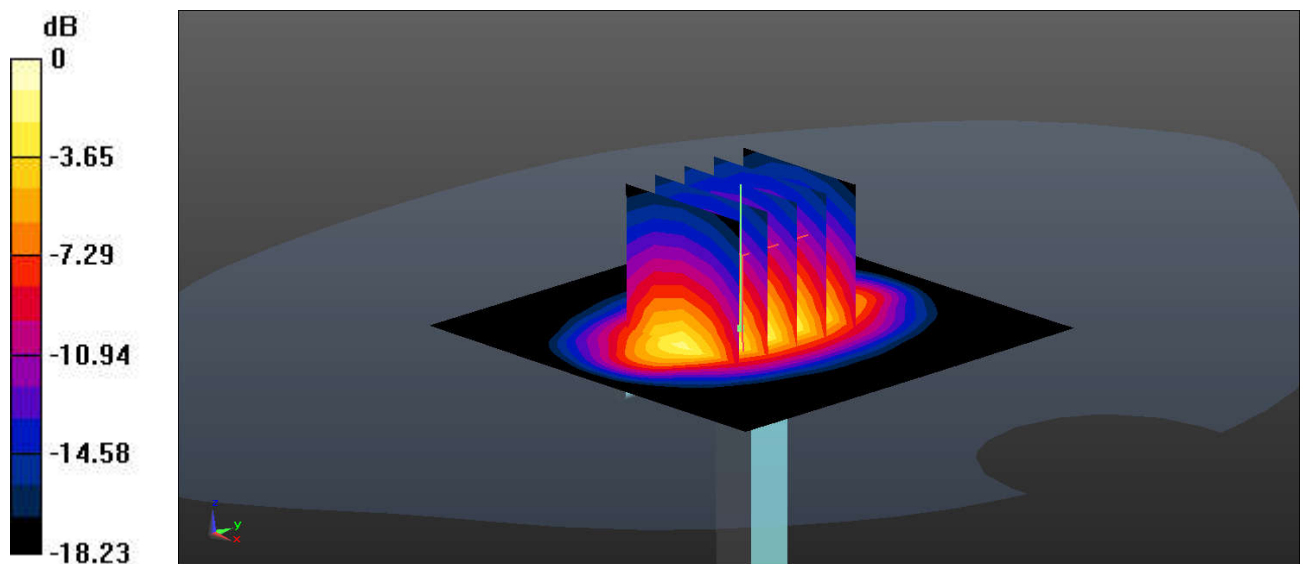

0 dB = 3.36 W/kg = 5.26 dBW/kg

System Check_Head_2600MHz

DUT: D2600V2 - SN:1061

Communication System: UID 0, CW (0); Frequency: 2600 MHz; Duty Cycle: 1:1
Medium: HSL_2600 Medium parameters used: $f = 2600$ MHz; $\sigma = 1.975$ S/m; $\epsilon_r = 40.602$; $\rho = 1000$ kg/m³

Ambient Temperature : 23.4 °C; Liquid Temperature : 22.6 °C

DASY5 Configuration:

- Probe: EX3DV4 - SN3857; ConvF(7.28, 7.28, 7.28); Calibrated: 2021.11.24
- Sensor-Surface: 1.4mm (Mechanical Surface Detection)
- Electronics: DAE4 Sn1649; Calibrated: 2021.2.3
- Phantom: SAM Twin Phantom; Type: SAM Twin; Serial: TP-1754
- Measurement SW: DASY52, Version 52.10 (4); SEMCAD X Version 14.6.14 (7483)

Pin=50mW/Area Scan (71x71x1): Interpolated grid: dx=1.200 mm, dy=1.200 mm
Maximum value of SAR (interpolated) = 4.82 W/kg

Pin=50mW/Zoom Scan (7x7x7)/Cube 0: Measurement grid: dx=5mm, dy=5mm, dz=5mm
Reference Value = 48.88 V/m; Power Drift = 0.03 dB
Peak SAR (extrapolated) = 5.94 W/kg
SAR(1 g) = 2.77 W/kg; SAR(10 g) = 1.24 W/kg
Maximum value of SAR (measured) = 4.78 W/kg

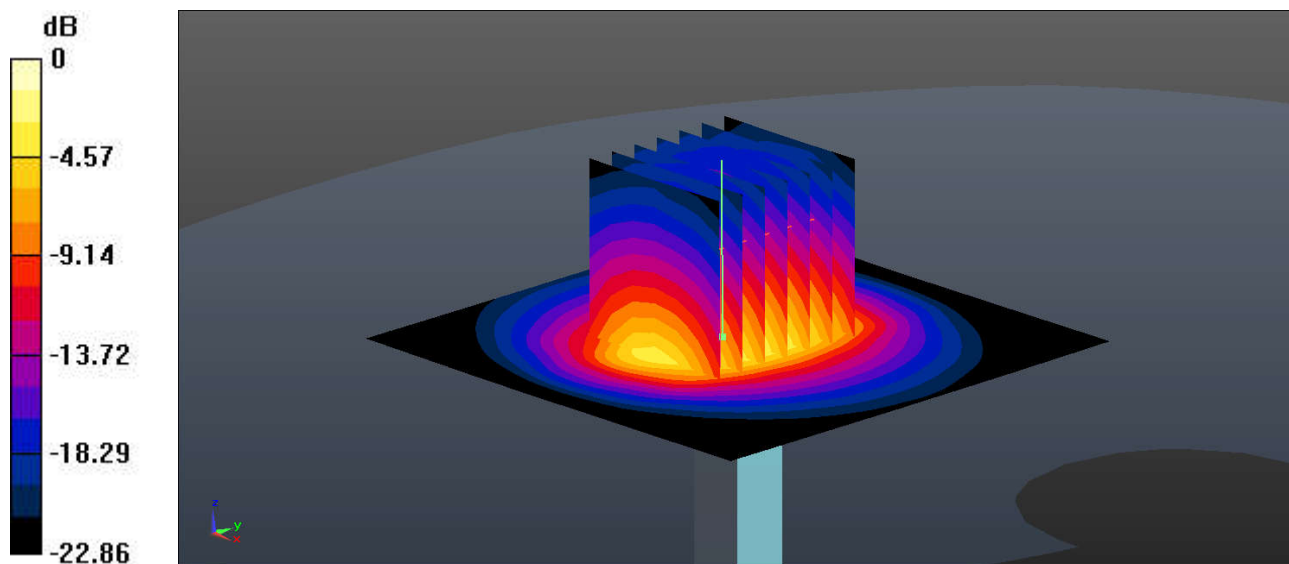

0 dB = 4.78 W/kg = 6.79 dBW/kg

System Check_Head_3500MHz

DUT: D3500V2 - SN:1037

Communication System: UID 0, CW (0); Frequency: 3500 MHz; Duty Cycle: 1:1
Medium: HSL_3500 Medium parameters used: $f = 3500$ MHz; $\sigma = 2.785$ S/m; $\epsilon_r = 38.983$; $\rho = 1000$ kg/m³

Ambient Temperature : 23.1 °C; Liquid Temperature : 22.7 °C

DASY5 Configuration:

- Probe: EX3DV4 - SN3857; ConvF(6.65, 6.65, 6.65); Calibrated: 2021.11.24
- Sensor-Surface: 1.4mm (Mechanical Surface Detection)
- Electronics: DAE4 Sn1649; Calibrated: 2021.2.3
- Phantom: SAM Twin Phantom; Type: SAM Twin; Serial: TP-1754
- Measurement SW: DASY52, Version 52.10 (4); SEMCAD X Version 14.6.14 (7483)

Pin=50mW/Area Scan (91x91x1): Interpolated grid: dx=1.000 mm, dy=1.000 mm
Maximum value of SAR (interpolated) = 6.31 W/kg

Pin=50mW/Zoom Scan (7x7x7)/Cube 0: Measurement grid: dx=4mm, dy=4mm, dz=1.4mm
Reference Value = 50.65 V/m; Power Drift = 0.14 dB
Peak SAR (extrapolated) = 8.10 W/kg
SAR(1 g) = 3.26 W/kg; SAR(10 g) = 1.25 W/kg
Maximum value of SAR (measured) = 6.24 W/kg

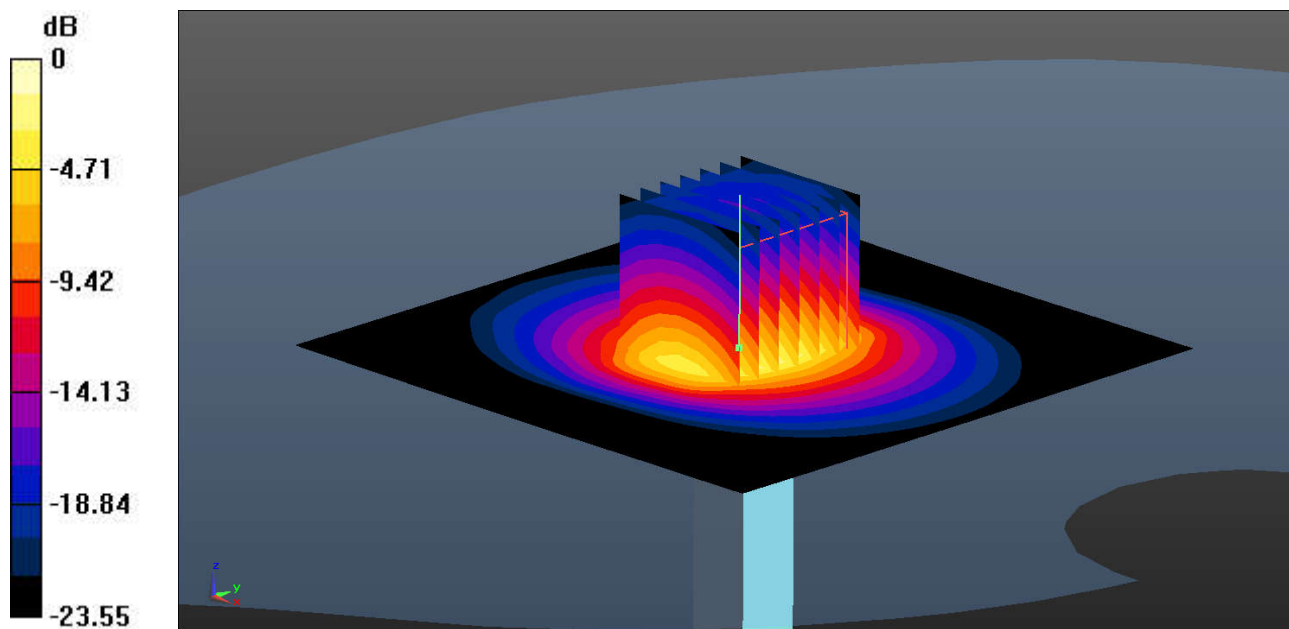

0 dB = 6.24 W/kg = 7.95 dBW/kg

System Check_Head_3700MHz

DUT: D3700V2 - SN:1008

Communication System: UID 0, CW (0); Frequency: 3700 MHz; Duty Cycle: 1:1
Medium: HSL_3700 Medium parameters used: $f = 3700 \text{ MHz}$; $\sigma = 2.984 \text{ S/m}$; $\epsilon_r = 38.787$; $\rho = 1000 \text{ kg/m}^3$

Ambient Temperature : 23.3 °C; Liquid Temperature : 22.7 °C

DASY5 Configuration:

- Probe: EX3DV4 - SN3857; ConvF(6.6, 6.6, 6.6); Calibrated: 2021.11.24
- Sensor-Surface: 1.4mm (Mechanical Surface Detection)
- Electronics: DAE4 Sn1649; Calibrated: 2021.2.3
- Phantom: SAM Twin Phantom; Type: SAM Twin; Serial: TP-1754
- Measurement SW: DASY52, Version 52.10 (4); SEMCAD X Version 14.6.14 (7483)

Pin=50mW/Area Scan (91x91x1): Interpolated grid: $dx=1.000 \text{ mm}$, $dy=1.000 \text{ mm}$
Maximum value of SAR (interpolated) = 6.35 W/kg

Pin=50mW/Zoom Scan (9x9x7)/Cube 0: Measurement grid: $dx=4\text{mm}$, $dy=4\text{mm}$, $dz=1.4\text{mm}$
Reference Value = 47.75 V/m; Power Drift = 0.07 dB
Peak SAR (extrapolated) = 8.22 W/kg
SAR(1 g) = 3.29 W/kg; SAR(10 g) = 1.22 W/kg
Maximum value of SAR (measured) = 5.28 W/kg

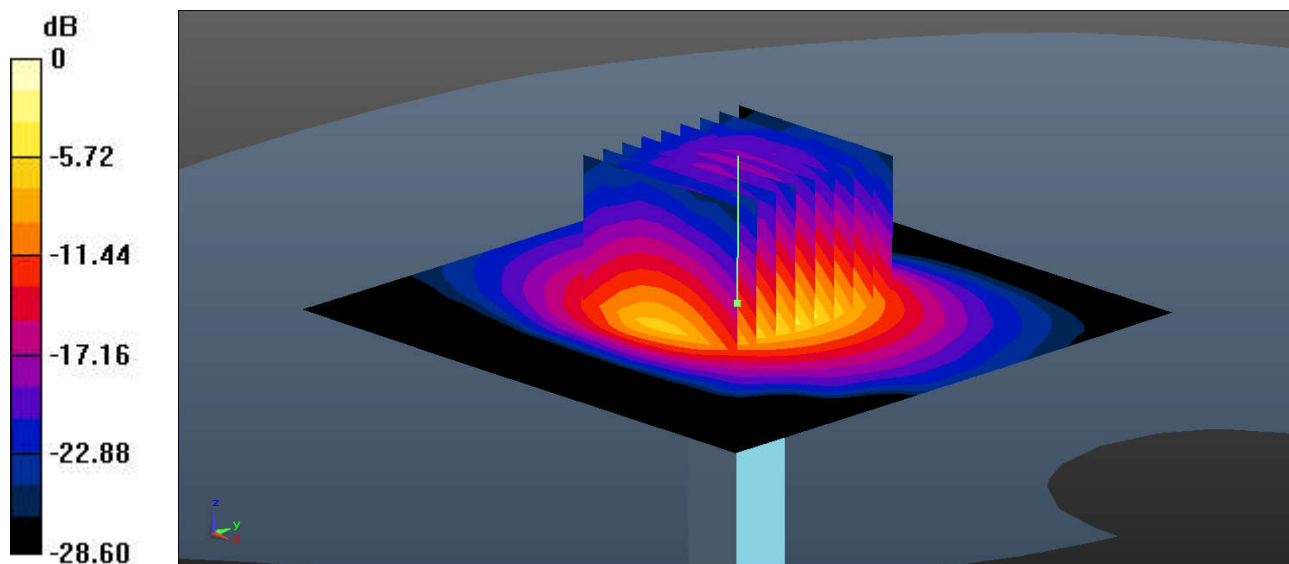

0 dB = 5.28 W/kg = 7.23 dBW/kg

System Check_Head_3900MHz

DUT: D3900V2 - SN:1048

Communication System: UID 0, CW (0); Frequency: 3900 MHz; Duty Cycle: 1:1
 Medium: HSL_3900 Medium parameters used: $f = 3900 \text{ MHz}$; $\sigma = 3.31 \text{ S/m}$; $\epsilon_r = 38.758$; $\rho = 1000 \text{ kg/m}^3$

Ambient Temperature : 23.2 °C; Liquid Temperature : 22.7 °C

DASY5 Configuration:

- Probe: EX3DV4 - SN3857; ConvF(6.58, 6.58, 6.58); Calibrated: 2021.11.24
- Sensor-Surface: 1.4mm (Mechanical Surface Detection)
- Electronics: DAE4 Sn1649; Calibrated: 2021.2.3
- Phantom: SAM Twin Phantom; Type: SAM Twin; Serial: TP-1754
- Measurement SW: DASY52, Version 52.10 (4); SEMCAD X Version 14.6.14 (7483)

Pin=50mW/Area Scan (91x91x1): Interpolated grid: $dx=1.000 \text{ mm}$, $dy=1.000 \text{ mm}$
 Maximum value of SAR (interpolated) = 6.79 W/kg

Pin=50mW/Zoom Scan (7x7x7)/Cube 0: Measurement grid: $dx=4\text{mm}$, $dy=4\text{mm}$, $dz=1.4\text{mm}$
 Reference Value = 48.94 V/m; Power Drift = 0.09 dB
 Peak SAR (extrapolated) = 8.96 W/kg
SAR(1 g) = 3.35 W/kg; SAR(10 g) = 1.19 W/kg
 Maximum value of SAR (measured) = 6.76 W/kg

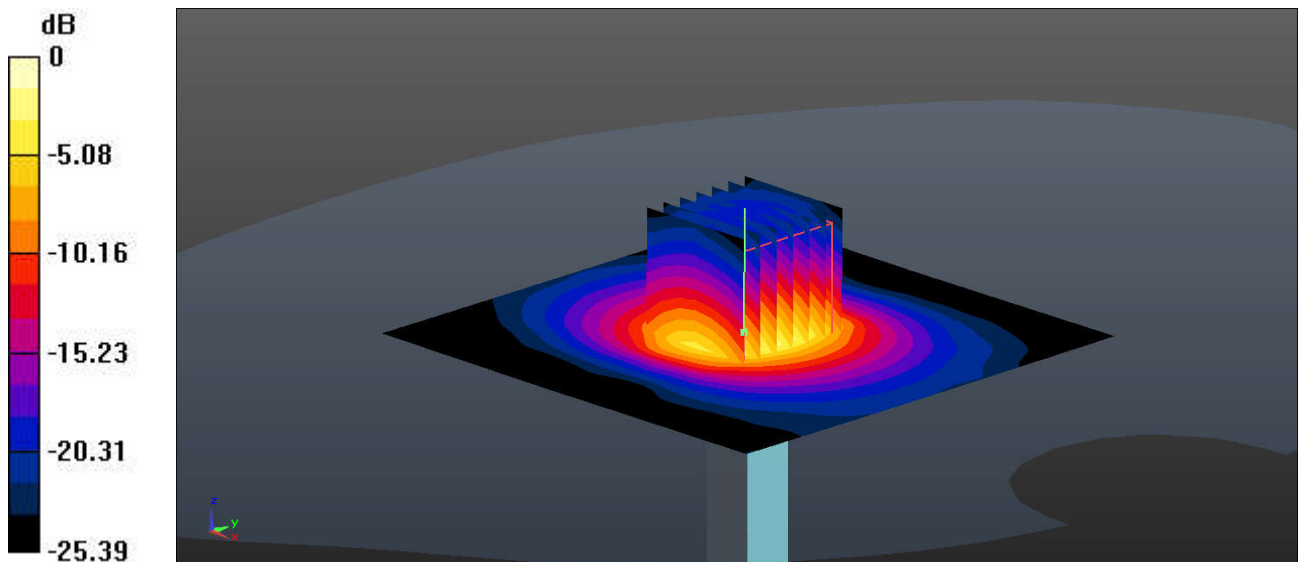

0 dB = 6.76 W/kg = 8.30 dBW/kg

System Check_Head_750MHz

DUT: D750V3 - SN:1087

Communication System: UID 0, CW (0); Frequency: 750 MHz; Duty Cycle: 1:1
Medium: HSL_750 Medium parameters used: $f = 750 \text{ MHz}$; $\sigma = 0.913 \text{ S/m}$; $\epsilon_r = 41.756$; $\rho = 1000 \text{ kg/m}^3$

Ambient Temperature : 23.1 °C; Liquid Temperature : 22.8 °C

DASY5 Configuration:

- Probe: EX3DV4 - SN3857; ConvF(9.42, 9.42, 9.42); Calibrated: 2021.11.24
- Sensor-Surface: 1.4mm (Mechanical Surface Detection)
- Electronics: DAE4 Sn1649; Calibrated: 2021.2.3
- Phantom: SAM Twin Phantom; Type: SAM Twin; Serial: TP-1754
- Measurement SW: DASY52, Version 52.10 (4); SEMCAD X Version 14.6.14 (7483)

Pin=50mW/Area Scan (61x61x1): Interpolated grid: $dx=1.500 \text{ mm}$, $dy=1.500 \text{ mm}$
Maximum value of SAR (interpolated) = 0.551 W/kg

Pin=50mW/Zoom Scan (5x5x7)/Cube 0: Measurement grid: $dx=8\text{mm}$, $dy=8\text{mm}$, $dz=5\text{mm}$
Reference Value = 25.48 V/m; Power Drift = 0.07 dB
Peak SAR (extrapolated) = 0.628 W/kg
SAR(1 g) = 0.416 W/kg; SAR(10 g) = 0.273 W/kg
Maximum value of SAR (measured) = 0.557 W/kg

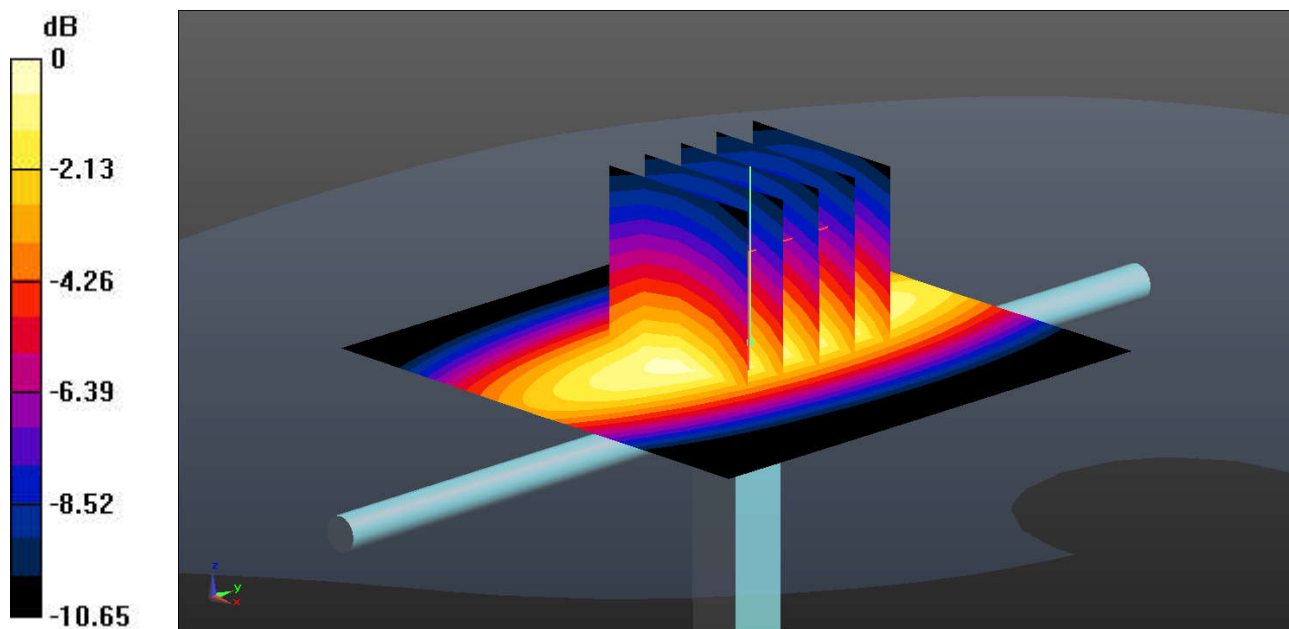

0 dB = 0.557 W/kg = -2.54 dBW/kg

System Check_Head_835MHz

DUT: D835V2 - SN:4d258

Communication System: UID 0, CW (0); Frequency: 835 MHz; Duty Cycle: 1:1
Medium: HSL_835 Medium parameters used: $f = 835 \text{ MHz}$; $\sigma = 0.929 \text{ S/m}$; $\epsilon_r = 40.938$; $\rho = 1000 \text{ kg/m}^3$
Ambient Temperature : 23.3 °C; Liquid Temperature : 22.8 °C

DASY5 Configuration:

- Probe: EX3DV4 - SN3857; ConvF(9.18, 9.18, 9.18); Calibrated: 2021.11.24
- Sensor-Surface: 1.4mm (Mechanical Surface Detection)
- Electronics: DAE4 Sn1649; Calibrated: 2021.2.3
- Phantom: SAM Twin Phantom; Type: SAM Twin; Serial: TP-1754
- Measurement SW: DASY52, Version 52.10 (4); SEMCAD X Version 14.6.14 (7483)

Pin=50mW/Area Scan (61x61x1): Interpolated grid: $dx=1.500 \text{ mm}$, $dy=1.500 \text{ mm}$
Maximum value of SAR (interpolated) = 0.706 W/kg

Pin=50mW/Zoom Scan (5x5x7)/Cube 0: Measurement grid: $dx=8\text{mm}$, $dy=8\text{mm}$, $dz=5\text{mm}$
Reference Value = 28.96 V/m; Power Drift = -0.08 dB
Peak SAR (extrapolated) = 0.801 W/kg
SAR(1 g) = 0.505 W/kg; SAR(10 g) = 0.328 W/kg
Maximum value of SAR (measured) = 0.709 W/kg

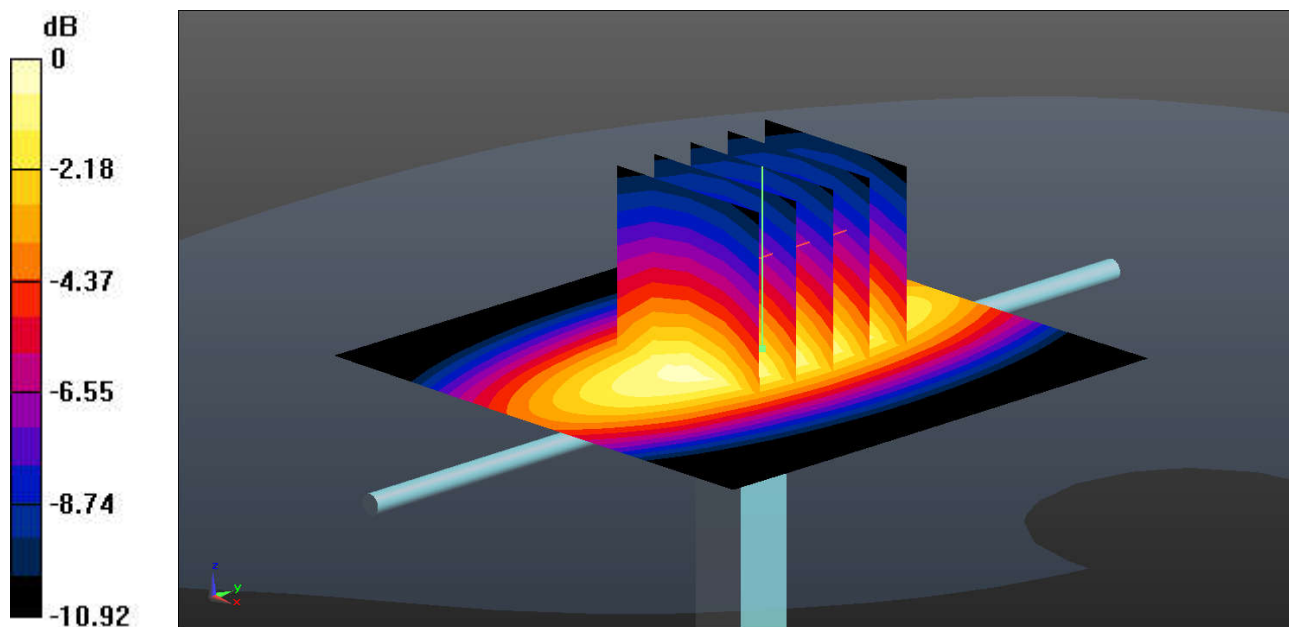

0 dB = 0.709 W/kg = -1.49 dBW/kg

System Check_Head_1750MHz

DUT: D1750V2 - SN:1090

Communication System: UID 0, CW (0); Frequency: 1750 MHz; Duty Cycle: 1:1
Medium: HSL_1750 Medium parameters used: $f = 1750$ MHz; $\sigma = 1.41$ S/m; $\epsilon_r = 40.677$; $\rho = 1000$ kg/m³

Ambient Temperature : 23.2 °C; Liquid Temperature : 22.8 °C

DASY5 Configuration:

- Probe: EX3DV4 - SN3857; ConvF(8.13, 8.13, 8.13); Calibrated: 2021.11.24
- Sensor-Surface: 1.4mm (Mechanical Surface Detection)
- Electronics: DAE4 Sn1649; Calibrated: 2021.2.3
- Phantom: SAM Twin Phantom; Type: SAM Twin; Serial: TP-1754
- Measurement SW: DASY52, Version 52.10 (4); SEMCAD X Version 14.6.14 (7483)

Pin=50mW/Area Scan (61x61x1): Interpolated grid: dx=1.500 mm, dy=1.500 mm
Maximum value of SAR (interpolated) = 3.08 W/kg

Pin=50mW/Zoom Scan (5x5x7)/Cube 0: Measurement grid: dx=8mm, dy=8mm, dz=5mm
Reference Value = 47.83 V/m; Power Drift = -0.04 dB
Peak SAR (extrapolated) = 3.71 W/kg
SAR(1 g) = 1.96 W/kg; SAR(10 g) = 1.03 W/kg
Maximum value of SAR (measured) = 3.11 W/kg

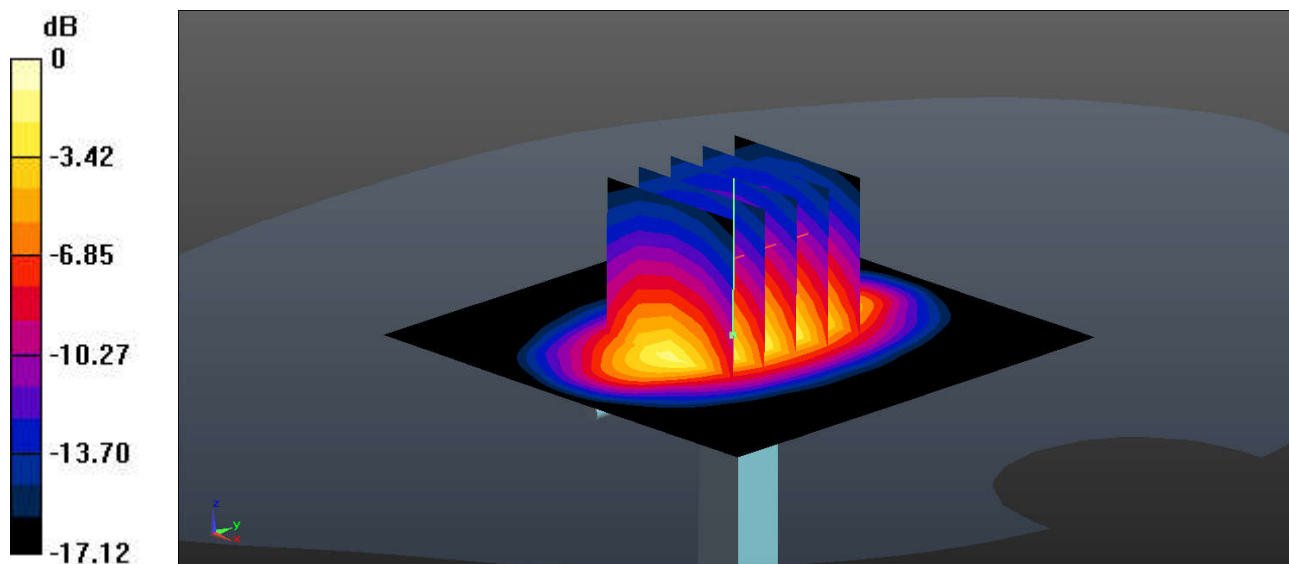

0 dB = 3.11 W/kg = 4.93 dBW/kg

System Check_Head_1900MHz

DUT: D1900V2 - SN:5d170

Communication System: UID 0, CW (0); Frequency: 1900 MHz; Duty Cycle: 1:1
Medium: HSL_1900 Medium parameters used: $f = 1900$ MHz; $\sigma = 1.453$ S/m; $\epsilon_r = 39.68$; $\rho = 1000$ kg/m³

Ambient Temperature : 23.3 °C; Liquid Temperature : 22.7 °C

DASY5 Configuration:

- Probe: EX3DV4 - SN3857; ConvF(7.86, 7.86, 7.86); Calibrated: 2021.11.24
- Sensor-Surface: 1.4mm (Mechanical Surface Detection)
- Electronics: DAE4 Sn1649; Calibrated: 2021.2.3
- Phantom: SAM Twin Phantom; Type: SAM Twin; Serial: TP-1754
- Measurement SW: DASY52, Version 52.10 (4); SEMCAD X Version 14.6.14 (7483)

Pin=50mW/Area Scan (61x61x1): Interpolated grid: dx=1.500 mm, dy=1.500 mm
Maximum value of SAR (interpolated) = 3.32 W/kg

Pin=50mW/Zoom Scan (5x5x7)/Cube 0: Measurement grid: dx=8mm, dy=8mm, dz=5mm
Reference Value = 49.16 V/m; Power Drift = -0.03 dB
Peak SAR (extrapolated) = 4.04 W/kg
SAR(1 g) = 2.09 W/kg; SAR(10 g) = 1.08 W/kg
Maximum value of SAR (measured) = 3.36 W/kg

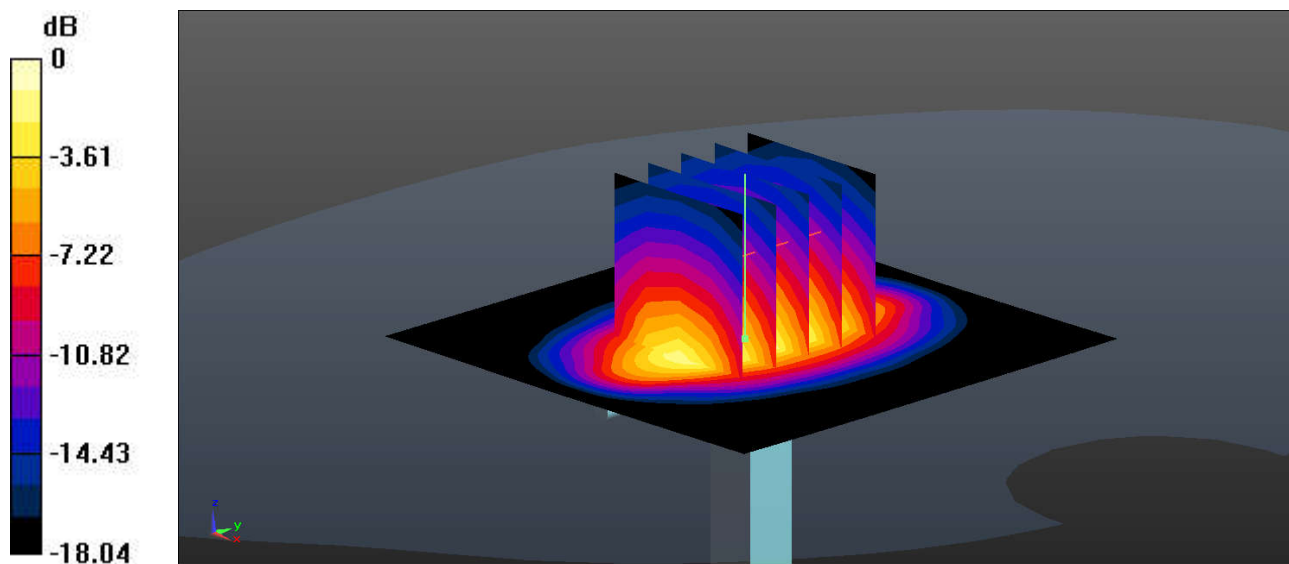

0 dB = 3.36 W/kg = 5.26 dBW/kg

System Check_Head_2600MHz

DUT: D2600V2 - SN:1061

Communication System: UID 0, CW (0); Frequency: 2600 MHz; Duty Cycle: 1:1
 Medium: HSL_2600 Medium parameters used: $f = 2600$ MHz; $\sigma = 1.922$ S/m; $\epsilon_r = 38.215$; $\rho = 1000$ kg/m³

Ambient Temperature : 23.2 °C; Liquid Temperature : 22.7 °C

DASY5 Configuration:

- Probe: EX3DV4 - SN3857; ConvF(7.28, 7.28, 7.28); Calibrated: 2021.11.24
- Sensor-Surface: 1.4mm (Mechanical Surface Detection)
- Electronics: DAE4 Sn1649; Calibrated: 2021.2.3
- Phantom: SAM Twin Phantom; Type: SAM Twin; Serial: TP-1754
- Measurement SW: DASY52, Version 52.10 (4); SEMCAD X Version 14.6.14 (7483)

Pin=50mW/Area Scan (71x71x1): Interpolated grid: dx=1.200 mm, dy=1.200 mm
 Maximum value of SAR (interpolated) = 4.69 W/kg

Pin=50mW/Zoom Scan (7x7x7)/Cube 0: Measurement grid: dx=5mm, dy=5mm, dz=5mm
 Reference Value = 49.56 V/m; Power Drift = 0.09 dB
 Peak SAR (extrapolated) = 5.81 W/kg
SAR(1 g) = 2.71 W/kg; SAR(10 g) = 1.21 W/kg
 Maximum value of SAR (measured) = 4.66 W/kg

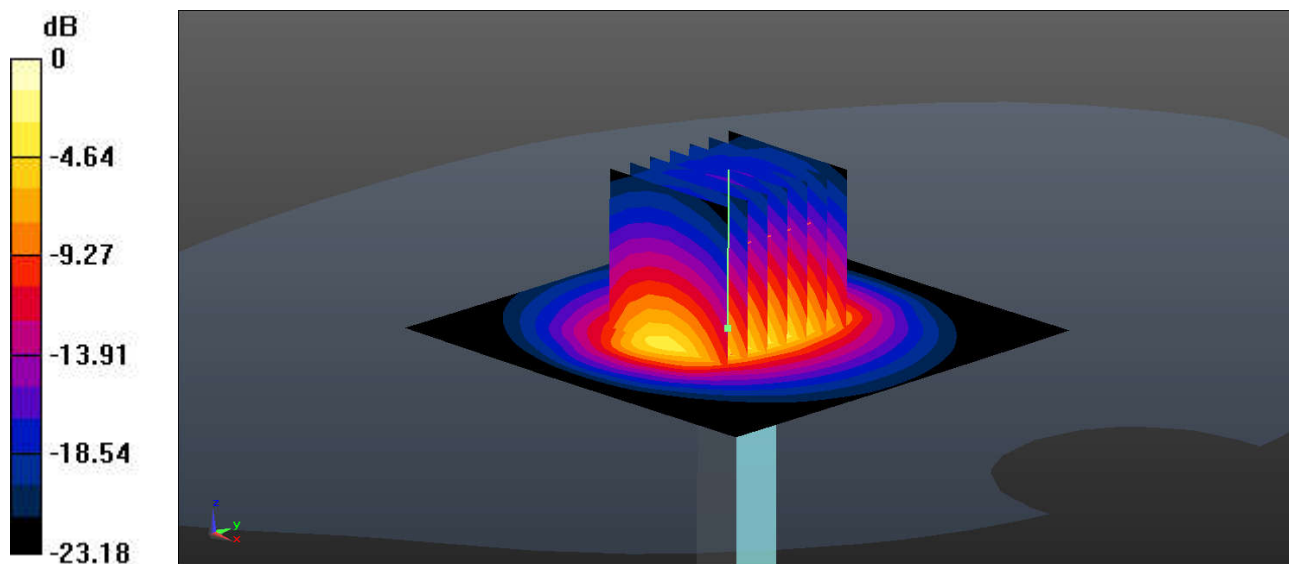

0 dB = 4.66 W/kg = 6.68 dBW/kg

System Check_Head_3500MHz

DUT: D3500V2 - SN:1037

Communication System: UID 0, CW (0); Frequency: 3500 MHz; Duty Cycle: 1:1
 Medium: HSL_3500 Medium parameters used: $f = 3500$ MHz; $\sigma = 2.781$ S/m; $\epsilon_r = 39.191$; $\rho = 1000$ kg/m³

Ambient Temperature : 23.3 °C; Liquid Temperature : 22.8 °C

DASY5 Configuration:

- Probe: EX3DV4 - SN3857; ConvF(6.65, 6.65, 6.65); Calibrated: 2021.11.24
- Sensor-Surface: 1.4mm (Mechanical Surface Detection)
- Electronics: DAE4 Sn1649; Calibrated: 2021.2.3
- Phantom: SAM Twin Phantom; Type: SAM Twin; Serial: TP-1754
- Measurement SW: DASY52, Version 52.10 (4); SEMCAD X Version 14.6.14 (7483)

Pin=50mW/Area Scan (91x91x1): Interpolated grid: dx=1.000 mm, dy=1.000 mm
 Maximum value of SAR (interpolated) = 5.33 W/kg

Pin=50mW/Zoom Scan (8x8x7)/Cube 0: Measurement grid: dx=4mm, dy=4mm, dz=1.4mm
 Reference Value = 45.43 V/m; Power Drift = 0.02 dB
 Peak SAR (extrapolated) = 7.12 W/kg
SAR(1 g) = 3.15 W/kg; SAR(10 g) = 1.18 W/kg
 Maximum value of SAR (measured) = 5.33 W/kg

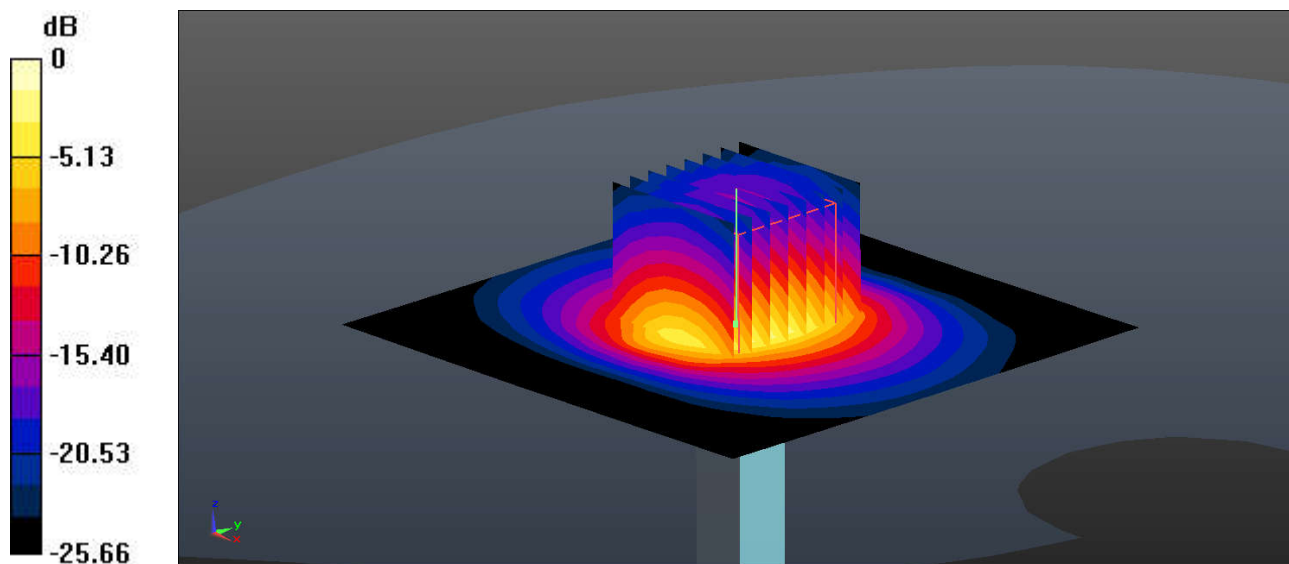

0 dB = 5.33 W/kg = 7.27 dBW/kg

System Check_Head_3700MHz

DUT: D3700V2 - SN:1008

Communication System: UID 0, CW (0); Frequency: 3700 MHz; Duty Cycle: 1:1

Medium: HSL_3700 Medium parameters used: $f = 3700$ MHz; $\sigma = 2.981$ S/m; $\epsilon_r = 38.645$; $\rho = 1000$ kg/m³

Ambient Temperature : 23.2 °C; Liquid Temperature : 22.6 °C

DASY5 Configuration:

- Probe: EX3DV4 - SN3857; ConvF(6.6, 6.6, 6.6); Calibrated: 2021.11.24
- Sensor-Surface: 1.4mm (Mechanical Surface Detection)
- Electronics: DAE4 Sn1649; Calibrated: 2021.2.3
- Phantom: SAM Twin Phantom; Type: SAM Twin; Serial: TP-1754
- Measurement SW: DASY52, Version 52.10 (4); SEMCAD X Version 14.6.14 (7483)

Pin=50mW/Area Scan (91x91x1): Interpolated grid: dx=1.000 mm, dy=1.000 mm
Maximum value of SAR (interpolated) = 5.79 W/kg

Pin=50mW/Zoom Scan (9x9x7)/Cube 0: Measurement grid: dx=4mm, dy=4mm, dz=1.4mm
Reference Value = 46.75 V/m; Power Drift = 0.08 dB
Peak SAR (extrapolated) = 7.82 W/kg
SAR(1 g) = 3.21 W/kg; SAR(10 g) = 1.16 W/kg
Maximum value of SAR (measured) = 5.32 W/kg

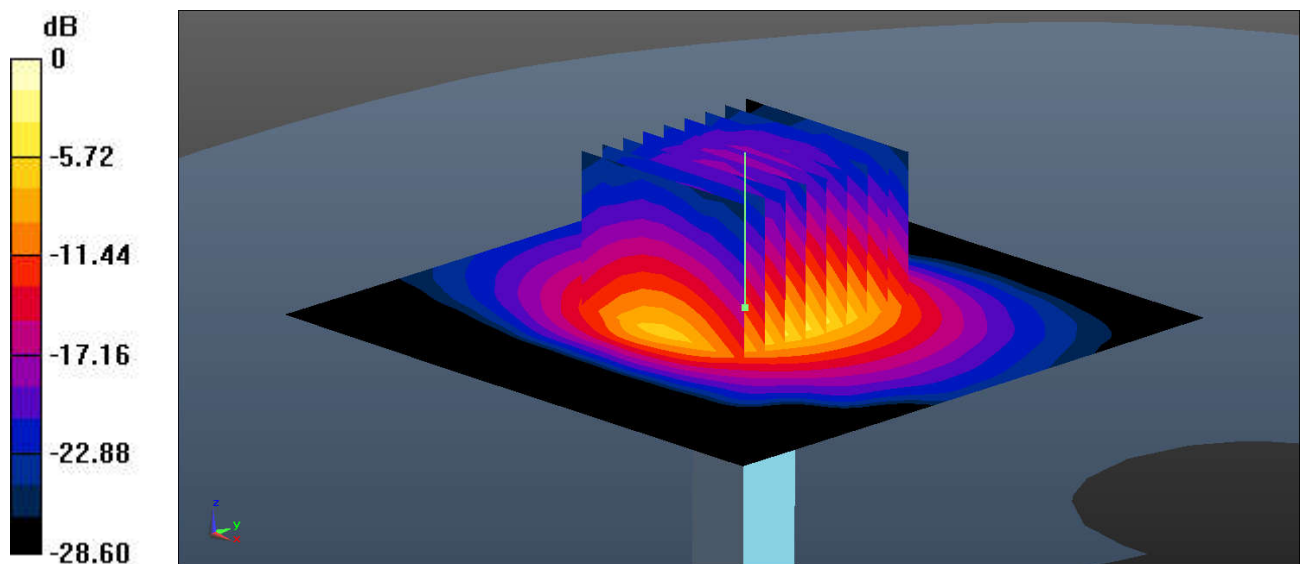

0 dB = 5.32 W/kg = 7.26 dBW/kg

System Check_Head_3900MHz

DUT: D3900V2 - SN:1048

Communication System: UID 0, CW (0); Frequency: 3900 MHz;Duty Cycle: 1:1
Medium: HSL_3900 Medium parameters used: $f = 3900$ MHz; $\sigma = 3.28$ S/m; $\epsilon_r = 37.613$; $\rho = 1000$ kg/m³

Ambient Temperature : 23.2 °C; Liquid Temperature : 22.7 °C

DASY5 Configuration:

- Probe: EX3DV4 - SN3857; ConvF(6.58, 6.58, 6.58); Calibrated: 2021.11.24
- Sensor-Surface: 1.4mm (Mechanical Surface Detection)
- Electronics: DAE4 Sn1649; Calibrated: 2021.2.3
- Phantom: SAM Twin Phantom; Type: SAM Twin; Serial: TP-1754
- Measurement SW: DASY52, Version 52.10 (4); SEMCAD X Version 14.6.14 (7483)

Pin=50mW/Area Scan (91x91x1): Interpolated grid: dx=1.000 mm, dy=1.000 mm
Maximum value of SAR (interpolated) = 6.58 W/kg

Pin=50mW/Zoom Scan (9x9x7)/Cube 0: Measurement grid: dx=4mm, dy=4mm, dz=1.4mm
Reference Value = 47.31 V/m; Power Drift = 0.13 dB
Peak SAR (extrapolated) = 8.78 W/kg
SAR(1 g) = 3.28 W/kg; SAR(10 g) = 1.17 W/kg
Maximum value of SAR (measured) = 6.58 W/kg

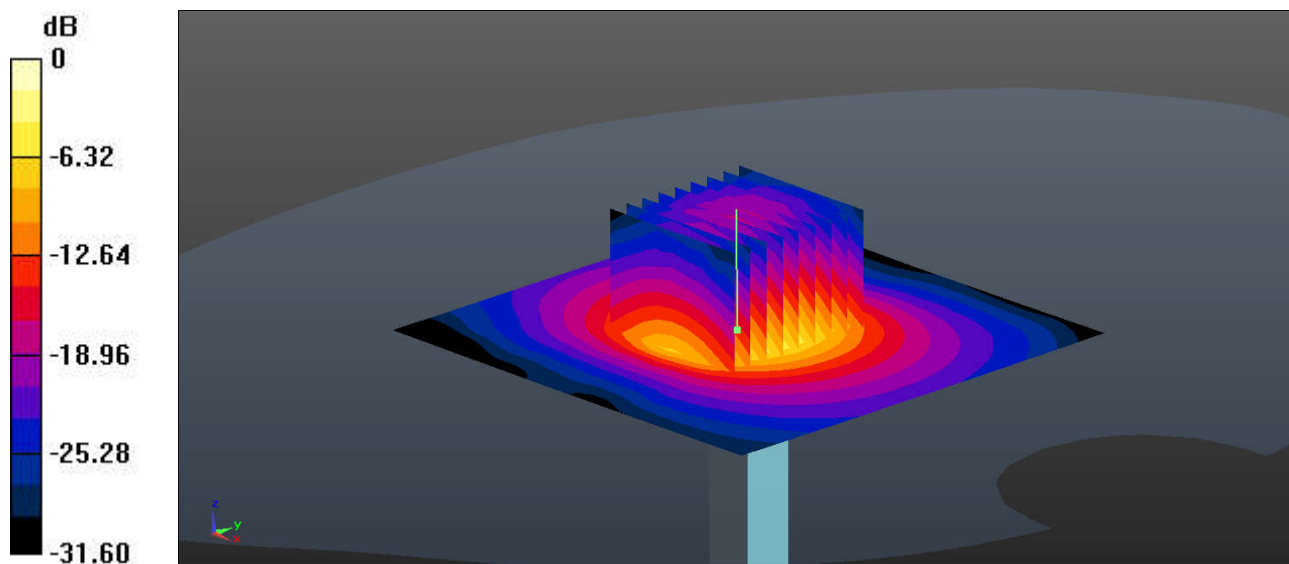

0 dB = 6.58 W/kg = 8.18 dBW/kg

System Check_Head_2450MHz

DUT: D2450V2 - SN:908

Communication System: UID 0, CW (0); Frequency: 2450 MHz; Duty Cycle: 1:1
Medium: HSL_2450 Medium parameters used: $f = 2450$ MHz; $\sigma = 1.824$ S/m; $\epsilon_r = 39.207$; $\rho = 1000$ kg/m³

Ambient Temperature : 23.2 °C; Liquid Temperature : 22.6 °C

DASY5 Configuration:

- Probe: EX3DV4 - SN3857; ConvF(7.53, 7.53, 7.53); Calibrated: 2021.11.24
- Sensor-Surface: 1.4mm (Mechanical Surface Detection)
- Electronics: DAE4 Sn1649; Calibrated: 2021.2.3
- Phantom: SAM Twin Phantom; Type: SAM Twin; Serial: TP-1754
- Measurement SW: DASY52, Version 52.10 (4); SEMCAD X Version 14.6.14 (7483)

Pin=50mW/Area Scan (71x71x1): Interpolated grid: dx=1.200 mm, dy=1.200 mm
Maximum value of SAR (interpolated) = 4.10 W/kg

Pin=50mW/Zoom Scan (7x7x7)/Cube 0: Measurement grid: dx=5mm, dy=5mm, dz=5mm
Reference Value = 48.99 V/m; Power Drift = 0.10 dB
Peak SAR (extrapolated) = 5.04 W/kg
SAR(1 g) = 2.5 W/kg; SAR(10 g) = 1.17 W/kg
Maximum value of SAR (measured) = 4.11 W/kg

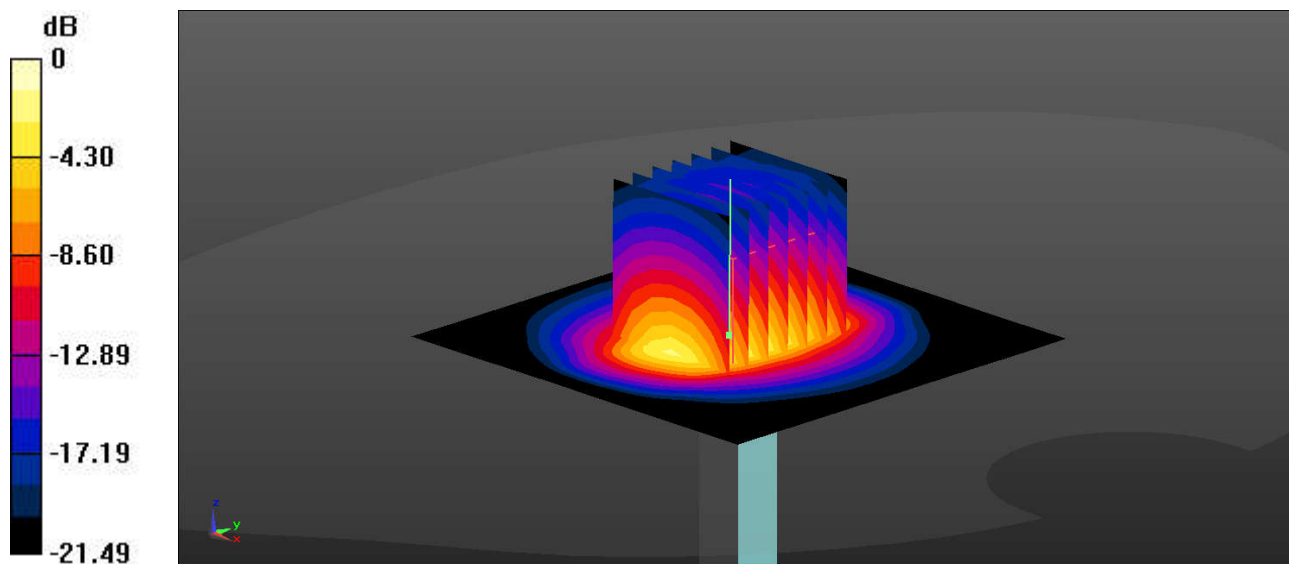

0 dB = 4.11 W/kg = 6.14 dBW/kg

System Check_Head_5250MHz

DUT: D5GHzV2 - SN:1113

Communication System: UID 0, CW (0); Frequency: 5250 MHz; Duty Cycle: 1:1
Medium: HSL_5000 Medium parameters used: $f = 5250$ MHz; $\sigma = 4.552$ S/m; $\epsilon_r = 36.094$; $\rho = 1000$ kg/m³

Ambient Temperature : 23.1 °C; Liquid Temperature : 22.8 °C

DASY5 Configuration:

- Probe: EX3DV4 - SN3857; ConvF(5.05, 5.05, 5.05); Calibrated: 2021.11.24
- Sensor-Surface: 1.4mm (Mechanical Surface Detection)
- Electronics: DAE4 Sn1649; Calibrated: 2021.2.3
- Phantom: SAM Twin Phantom; Type: SAM Twin; Serial: TP-1754
- Measurement SW: DASY52, Version 52.10 (4); SEMCAD X Version 14.6.14 (7483)

Pin=50mW/Area Scan (91x91x1): Interpolated grid: dx=1.000 mm, dy=1.000 mm
Maximum value of SAR (interpolated) = 9.50 W/kg

Pin=50mW/Zoom Scan (9x9x7)/Cube 0: Measurement grid: dx=4mm, dy=4mm, dz=1.4mm
Reference Value = 49.45 V/m; Power Drift = -0.08 dB
Peak SAR (extrapolated) = 16.4 W/kg
SAR(1 g) = 4.16 W/kg; SAR(10 g) = 1.19 W/kg
Maximum value of SAR (measured) = 10.4 W/kg

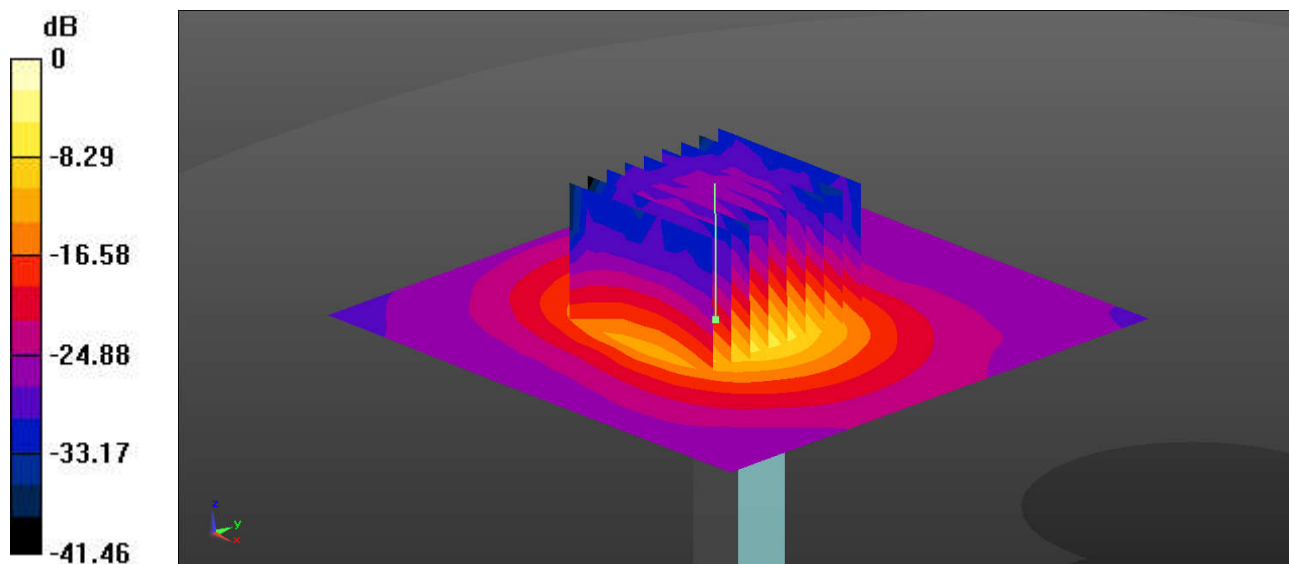

0 dB = 10.4 W/kg = 10.17 dBW/kg

System Check_Head_5600MHz

DUT: D5GHzV2 - SN:1113

Communication System: UID 0, CW (0); Frequency: 5600 MHz;Duty Cycle: 1:1

Medium: HSL_5000 Medium parameters used: $f = 5600$ MHz; $\sigma = 4.926$ S/m; $\epsilon_r = 35.565$; $\rho = 1000$ kg/m³

Ambient Temperature : 23.4 °C; Liquid Temperature : 22.7 °C

DASY5 Configuration:

- Probe: EX3DV4 - SN3857; ConvF(4.69, 4.69, 4.69); Calibrated: 2021.11.24
- Sensor-Surface: 1.4mm (Mechanical Surface Detection)
- Electronics: DAE4 Sn1649; Calibrated: 2021.2.3
- Phantom: SAM Twin Phantom; Type: SAM Twin; Serial: TP-1754
- Measurement SW: DASY52, Version 52.10 (4); SEMCAD X Version 14.6.14 (7483)

Pin=50mW/Area Scan (91x91x1): Interpolated grid: dx=1.000 mm, dy=1.000 mm
Maximum value of SAR (interpolated) = 10.1 W/kg

Pin=50mW/Zoom Scan (7x7x7)/Cube 0: Measurement grid: dx=4mm, dy=4mm, dz=1.4mm

Reference Value = 49.05 V/m; Power Drift = -0.03 dB

Peak SAR (extrapolated) = 18.0 W/kg

SAR(1 g) = 4.24 W/kg; SAR(10 g) = 1.2 W/kg

Maximum value of SAR (measured) = 10.9 W/kg

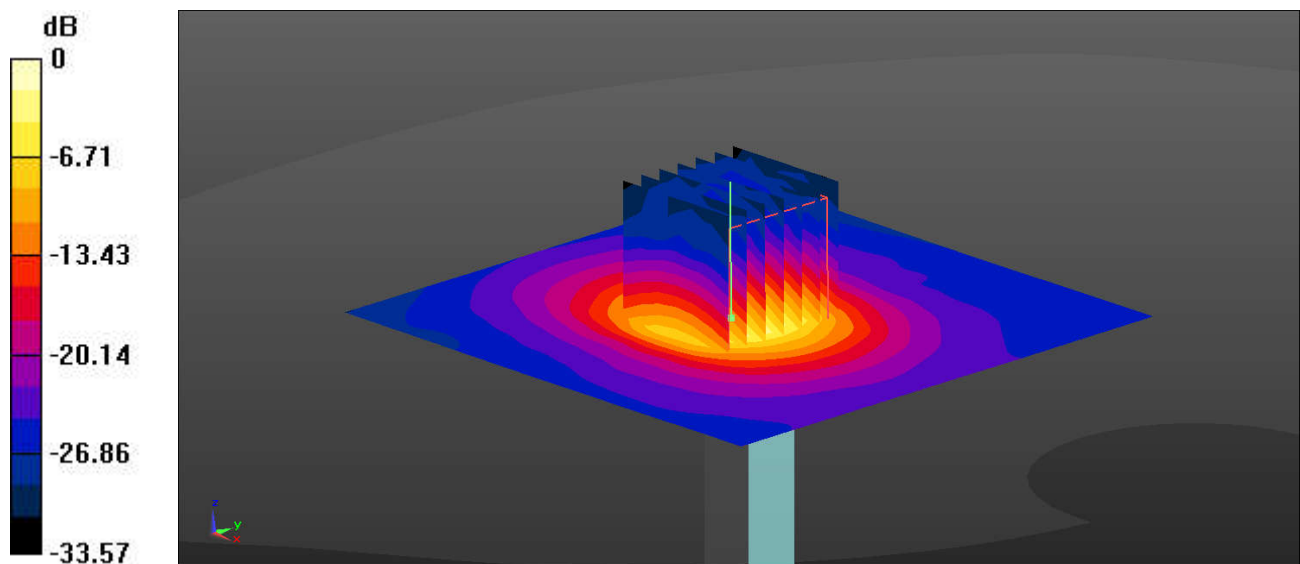

0 dB = 10.9 W/kg = 10.37 dBW/kg

System Check_Head_5750MHz

DUT: D5GHzV2 - SN:1113

Communication System: UID 0, CW (0); Frequency: 5750 MHz; Duty Cycle: 1:1
Medium: HSL_5000 Medium parameters used: $f = 5750 \text{ MHz}$; $\sigma = 5.1 \text{ S/m}$; $\epsilon_r = 35.38$; $\rho = 1000 \text{ kg/m}^3$

Ambient Temperature : 23.3 °C; Liquid Temperature : 22.8 °C

DASY5 Configuration:

- Probe: EX3DV4 - SN3857; ConvF(4.92, 4.92, 4.92); Calibrated: 2021.11.24
- Sensor-Surface: 1.4mm (Mechanical Surface Detection)
- Electronics: DAE4 Sn1649; Calibrated: 2021.2.3
- Phantom: SAM Twin Phantom; Type: SAM Twin; Serial: TP-1754
- Measurement SW: DASY52, Version 52.10 (4); SEMCAD X Version 14.6.14 (7483)

Pin=50mW/Area Scan (91x91x1): Interpolated grid: $dx=1.000 \text{ mm}$, $dy=1.000 \text{ mm}$
Maximum value of SAR (interpolated) = 9.31 W/kg

Pin=50mW/Zoom Scan (9x9x7)/Cube 0: Measurement grid: $dx=4\text{mm}$, $dy=4\text{mm}$, $dz=1.4\text{mm}$
Reference Value = 46.53 V/m; Power Drift = -0.02 dB
Peak SAR (extrapolated) = 17.7 W/kg
SAR(1 g) = 3.92 W/kg; SAR(10 g) = 1.12 W/kg
Maximum value of SAR (measured) = 10.2 W/kg

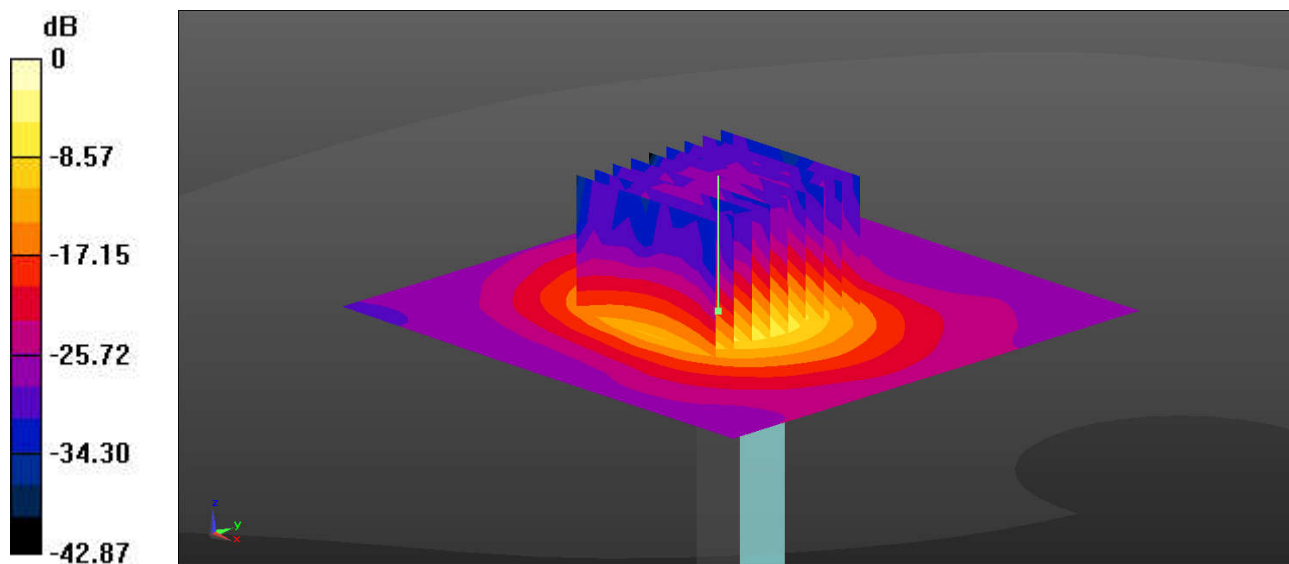

0 dB = 10.2 W/kg = 10.09 dBW/kg



Appendix B. Plots of High SAR Measurement

The plots are shown as follows.