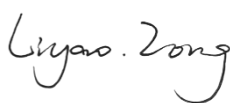

# TEST REPORT

**Applicant:** Xiaomi Communications Co., Ltd.  
**Address:** #019, 9th Floor, Building 6, 33 Xi'erqi Middle Road,  
Haidian District, Beijing, China, 100085  
**Equipment Type:** Mobile Phone  
**Model Name:** 22111317G  
**Brand Name:** Redmi  
**FCC ID:** 2AFZZ1317G  
**Test Standard:** FCC 47 CFR Part 2.1093  
(refer section 3.1)  
**Maximum SAR:** Head (1 g@0mm): 1.09 W/kg  
Body-worn (1 g@10mm): 1.05 W/kg  
Hotspot (1 g@10mm): 1.05 W/kg  
Specific (10 g@0mm): 2.40 W/kg  
**Test Date:** Oct. 01, 2022 – Oct. 24, 2022  
**Date of Issue:** Nov. 07, 2022

**ISSUED BY:**

Shenzhen BALUN Technology Co., Ltd.

**Tested by:** Ruan Zhaoyi**Checked by:** Zong Liyao**Approved by:** Wei Yanquan  
(Chief Engineer)

### Revision History

Version	Issue Date	Revisions Content
<u>Rev. 01</u>	<u>Nov. 07, 2022</u>	<u>Initial Issue</u>

## TABLE OF CONTENTS

1	GENERAL INFORMATION.....	5
1.1	Test Laboratory .....	5
1.2	Test Location.....	5
1.3	Test Environment Condition.....	5
2	PRODUCT INFORMATION .....	6
2.1	Applicant Information .....	6
2.2	Manufacturer Information.....	6
2.3	Factory Information.....	6
2.4	General Description for Equipment under Test (EUT).....	6
2.5	Ancillary Equipment.....	6
2.6	Technical Information .....	7
3	SUMMARY OF TEST RESULT .....	10
3.1	Test Standards .....	10
3.2	Device Category and SAR Limit .....	11
3.3	Test Result Summary .....	12
3.4	Test Uncertainty .....	14
4	MEASUREMENT SYSTEM .....	15
4.1	Specific Absorption Rate (SAR) Definition .....	15
4.2	DASY SAR System .....	16
5	SYSTEM VERIFICATION .....	24
5.1	Purpose of System Check .....	24
5.2	System Check Setup .....	24
6	TEST POSITION CONFIGURATIONS .....	25
6.1	Head Exposure Conditions .....	25
6.2	Body-worn Position Conditions .....	27

6.3	Hotspot Mode Exposure Position Conditions .....	28
6.4	Product Specific 10g Exposure Consideration .....	28
7	MEASUREMENT PROCEDURE .....	29
7.1	Measurement Process Diagram .....	29
7.2	SAR Scan General Requirement .....	30
7.3	Measurement Procedure .....	31
7.4	Area & Zoom Scan Procedure .....	31
8	CONDUCTED RF OUPUT POWER .....	32
8.1	GSM.....	32
8.2	WCDMA .....	32
8.3	LTE.....	32
8.4	Intra-Band Uplink CA Power .....	32
8.5	NR 5G .....	32
8.6	WIFI.....	33
8.7	Bluetooth .....	39
8.8	Power Reduction List.....	40
9	PROXIMITY SENSOR TRIGGERING TEST.....	49
9.1	Sensor layout .....	49
9.2	Introduction.....	49
9.3	The Antenna Location.....	50
9.4	Power reduction for RF exposure consideration .....	50
9.5	Proximity Sensor Introduction .....	52
10	TEST EXCLUSION CONSIDERATION .....	60
11	TEST RESULT .....	61
11.1	GSM 850 .....	61
11.2	GSM 1900 .....	62
11.3	WCDMA Band 2 .....	64
11.4	WCDMA Band 4 .....	66
11.5	WCDMA Band 5 .....	68
11.6	LTE Band 2 (20MHz Bandwidth) .....	69

11.7	LTE Band 4 (20MHz Bandwidth) .....	72
11.8	LTE Band 5 (10MHz Bandwidth) .....	74
11.9	LTE Band 7 (20MHz Bandwidth) .....	76
11.10	LTE Band 7 Worse case for CA Test .....	78
11.11	LTE Band 38 (20MHz Bandwidth).....	79
11.12	LTE Band 38 Worse case for CA Test .....	81
11.13	LTE Band 41 (20MHz Bandwidth).....	82
11.14	n5 (20MHz Bandwidth) .....	85
11.15	n7 (20MHz Bandwidth) .....	87
11.16	n38 (40MHz Bandwidth) .....	89
11.17	n41 (100MHz Bandwidth) .....	91
11.18	n77 (3450-3550MHz) (100MHz Bandwidth).....	93
11.19	n77 (3700-3980MHz) (100MHz Bandwidth).....	96
11.20	n78 (3450-3550MHz) (100MHz Bandwidth).....	99
11.21	n78 (3700-3980MHz) (100MHz Bandwidth).....	102
11.22	WIFI 2.4GHz.....	105
11.23	WIFI 5GHz.....	106
11.24	Bluetooth .....	108
12	SAR Measurement Variability .....	109
13	SIMULTANEOUS TRANSMISSION.....	110
13.1	Simultaneous Transmission Mode Consider .....	110
13.2	Sum SAR of Simultaneous Transmission .....	111
14	TEST EQUIPMENTS LIST .....	127
ANNEX A	SIMULATING LIQUID VERIFICATION RESULT .....	128
ANNEX B	SYSTEM CHECK RESULT .....	129
ANNEX C	TEST DATA.....	155
ANNEX D	EUT EXTERNAL PHOTOS.....	223
ANNEX E	SAR TEST SETUP PHOTOS .....	223
ANNEX F	CALIBRATION REPORT .....	223

# 1 GENERAL INFORMATION

## 1.1 Test Laboratory

Name	Shenzhen BALUN Technology Co., Ltd.
Address	Block B, 1/F, Baisha Science and Technology Park, Shahe Xi Road, Nanshan District, Shenzhen, Guangdong Province, P. R. China
Phone Number	+86 755 6685 0100

## 1.2 Test Location

Name	Shenzhen BALUN Technology Co., Ltd.
Location	<input checked="" type="checkbox"/> Block B, 1/F, Baisha Science and Technology Park, Shahe Xi Road, Nanshan District, Shenzhen, Guangdong Province, P. R. China
	<input type="checkbox"/> 1/F, Building B, Ganghongji High-tech Intelligent Industrial Park, No. 1008, Songbai Road, Yangguang Community, Xili Sub-district, Nanshan District, Shenzhen, Guangdong Province, P. R. China
Accreditation Certificate	The laboratory is a testing organization accredited by FCC as a accredited testing laboratory. The designation number is CN1196.

## 1.3 Test Environment Condition

Ambient Temperature	18°C to 25°C
Ambient Relative Humidity	30% to 70%

## 2 PRODUCT INFORMATION

### 2.1 Applicant Information

Applicant	Xiaomi Communications Co., Ltd.
Address	#019, 9th Floor, Building 6, 33 Xi'erqi Middle Road, Haidian District, Beijing, China, 100085

### 2.2 Manufacturer Information

Manufacturer	Xiaomi Communications Co., Ltd.
Address	#019, 9th Floor, Building 6, 33 Xi'erqi Middle Road, Haidian District, Beijing, China, 100085

### 2.3 Factory Information

Factory	N/A
Address	N/A

### 2.4 General Description for Equipment under Test (EUT)

EUT Name	Mobile Phone
Model Name Under Test	22111317G
Series Model Name	N/A
Description of Model name differentiation	N/A
Hardware Version	P2
Software Version	MIUI 13
Dimensions (Approx.)	N/A
Weight (Approx.)	N/A

### 2.5 Ancillary Equipment

Please refer the document "BL-SZ2290497-AW EUT external photo.pdf".

## 2.6 Technical Information

Network and Wireless connectivity	<p>2G Network GSM/GPRS/EDGE 850/900/1800/1900 MHz</p> <p>3G Network WCDMA/HSDPA/HSUPA/DC-HSDPA Band 1/2/4/5/8</p> <p>4G Network FDD LTE Band 1/2/3/4/5/7/8/20/28/32 TDD LTE Band 38/40/41</p> <p>LTE CA Uplink (UL): CA_3C, CA_7C, CA_38C, CA_40C, CA_1A-3A, CA_1A-7A, CA_3A-7A, CA_1A-20A, CA_3A-20A, CA_4A-7A, CA_7A-28A, CA_7A-20A</p> <p>LTE CA Downlink (DL): CA_20A-32A</p> <p>5G Network</p> <p>SA: NR n1/n3/n5/n7/n8/n20/n28/38/n40/n41/n77/n78</p> <p>NSA(EN-DC): DC_1A_n3A, DC_1A_n5A, DC_1A_n7A, DC_1A_n8A, DC_1A_n20A, DC_1A_n28A, DC_1A_n38A, DC_1A_n40A, DC_1A_n41A, DC_1A_n77A, DC_1A_n78A, DC_2A_n78A, DC_3A_n1A, DC_3A_n5A, DC_3A_n7A, DC_3A_n20A, DC_3A_n28A, DC_3A_n38A, DC_3A_n40A, DC_3A_n41A, DC_3A_n77A, DC_3A_n78A, DC_5A_n40A, DC_5A_n78A, DC_7A_n1A, DC_7A_n3A, DC_7A_n5A, DC_7A_n8A, DC_7A_n20A, DC_7A_n28A, DC_7A_n78A, DC_8A_n1A, DC_8A_n3A, DC_8A_n7A, DC_8A_n40A, DC_8A_n41A, DC_8A_n77A, DC_8A_n78A, DC_20A_n1A, DC_20A_n3A, DC_20A_n7A, DC_20A_n28A, DC_20A_n38A, DC_20A_n78A, DC_28A_n1A, DC_28A_n3A, DC_28A_n7A, DC_28A_n40A, DC_28A_n41A, DC_28A_n77A, DC_28A_n78A, DC_38A_n3A, DC_38A_n78A, DC_40A_n1A, DC_40A_n78A, DC_41A_n78A</p> <p>Bluetooth (BR+EDR+BLE)</p> <p>2.4G WIFI 802.11b, 802.11g, 802.11n(HT20/40)</p> <p>5G WIFI 802.11a, 802.11n(HT20/40) and 802.11ac(VHT20/40/80)</p> <p>U-NII-1/2A/2C/3, GPS, GLONASS, Galileo, BDS, NFC, FM receiver</p>
EUT ID	S30; S53; S54; S57; S66
IMEI Number	<p>S30: 864010060081563(71)/01</p> <p>S53: 864010060071580(98)/01</p> <p>S54: 864010060074907(15)/01</p> <p>S57: 864010060076662(70)/01</p> <p>S66: 864010060080680(98)/01</p>
<p>Note:</p> <p>1: EUT ID is used to identify the test sample in the lab internally.</p> <p>2: It is performed to test SAR with the EUT S53&amp;S54&amp;S57 and S66 and conducted power with the EUT S30.</p> <p>3: The EUT is a mobile phone, which supports dual SIM card under the same transceiver. Each SIM supports GSM, WCDMA, LTE and NR, and both SIM share the same transmitting electro circuit, NV parameters, so only SIM1 was tested in this report.</p>	

The requirement for the following technical information of the EUT was tested in this report:

Operating Mode	GSM, WCDMA, LTE, NR, 2.4G WLAN, 5G WLAN, Bluetooth		
Frequency Range	GSM 850	TX: 824 ~ 849 MHz	RX: 869 ~ 894 MHz
	GSM 1900	TX: 1850 ~ 1910 MHz	RX: 1930 ~ 1990 MHz
	WCDMA Band 2	TX: 1850 ~ 1910 MHz	RX: 1930 ~ 1990 MHz
	WCDMA Band 4	TX: 1710 ~ 1755 MHz	RX: 2110 ~ 2155 MHz
	WCDMA Band 5	TX: 824 ~ 849 MHz	RX: 869 ~ 894 MHz
	LTE Band 2	TX: 1850 ~ 1910 MHz	RX: 1930 ~ 1990 MHz
	LTE Band 4	TX: 1710 ~ 1755 MHz	RX: 2110 ~ 2155 MHz
	LTE Band 5	TX: 824 ~ 849 MHz	RX: 869 ~ 894 MHz
	LTE Band 7	TX: 2500 ~ 2570 MHz	RX: 2620 ~ 2690 MHz
	LTE Band 38	TX: 2570 ~ 2620 MHz	RX: 2570 ~ 2620 MHz
	LTE Band 41	TX: 2496 ~ 2690 MHz	RX: 2496 ~ 2690 MHz
	NR n5	TX: 824 ~ 849 MHz	RX: 869 ~ 894 MHz
	NR n7	TX: 2500 ~ 2570 MHz	RX: 2620 ~ 2690 MHz
	NR n38	TX: 2570 ~ 2620 MHz	RX: 2570 ~ 2620 MHz
	NR n41	TX: 2496 ~ 2690 MHz	RX: 2496 ~ 2690 MHz
	NR n77	TX: 3450 ~ 3550 MHz	RX: 3450 ~ 3550 MHz
		TX: 3700 ~ 3980 MHz	RX: 3700 ~ 3980 MHz
	NR n78	TX: 3450 ~ 3550 MHz	RX: 3450 ~ 3550 MHz
		TX: 3700 ~ 3800 MHz	RX: 3700 ~ 3800 MHz
	802.11b/g /n(HT20/HT40)	2412 ~ 2462 MHz	
802.11a/ /n(HT20/HT40) /ac(VHT20/VHT40 /VHT80)	5150 ~ 5250 MHz		
	5250 ~ 5350 MHz		
	5470 ~ 5725 MHz		
	5725 ~ 5850 MHz		
Bluetooth	2402 ~ 2480 MHz		
Antenna Type	WWAN: PIFA Antenna WLAN: PIFA Antenna Bluetooth: PIFA Antenna		
DTM	N/A		
Hotspot Function	Support		
Power Reduction	Support		
Exposure Category	General Population/Uncontrolled exposure		
EUT Stage	Portable Device		
Product	Type		
	<input checked="" type="checkbox"/> Production unit	<input type="checkbox"/> Identical prototype	
Note:	<p>1. The device utilizes independent power reduction mechanisms for SAR compliance for the 2/3/4/5G transmitter for held-to-ear exposure conditions.</p> <p>2. The device utilizes independent power reduction mechanisms for SAR compliance for the 2/3/4/5G transmitter for near to body exposure conditions.</p>		



3. The reduction power details please refer section 8.7.

### 3 SUMMARY OF TEST RESULT

#### 3.1 Test Standards

No.	Identity	Document Title
1	47 CFR Part 2.1093	Radiofrequency radiation exposure evaluation: portable devices
2	ANSI C95.1-1992	IEEE Standard for Safety Levels with Respect to Human Exposure to Radio Frequency Electromagnetic Fields, 3 kHz to 300 GHz
3	IEEE Std. 1528-2013	Recommended Practice for Determining the Peak Spatial-Average Specific Absorption Rate (SAR) in the Human Head from Wireless Communications Devices: Measurement Techniques
4	FCC KDB 447498 D04 v01	447498 D04 Interim General RF Exposure Guidance v01
5	FCC KDB 941225 D01 v03r01	3G SAR MEAUREMENT PROCEDURES
6	FCC KDB 941225 D05 v02r05	SAR Evaluation Considerations for LTE Devices
7	FCC KDB 941225 D05A v01	REL. 10 LTE SAR TEST GUIDANCE AND KDB INQUIRIES
8	FCC KDB 941225 D06 v02r01	SAR Evaluation Procedures for Portable Devices with Wireless Router Capabilities
9	FCC KDB 865664 D01 v01r04	SAR Measurement 100 MHz to 6 GHz
10	FCC KDB 865664 D02 v01r02	RF Exposure Reporting
11	FCC KDB 648474 D04 v01r03	SAR Evaluation Considerations for Wireless Handsets
12	KDB 248227 D01 v02r02	SAR Guidance for IEEE 802.11 (Wi-Fi) Transmitters

### 3.2 Device Category and SAR Limit

This device belongs to portable device category because its radiating structure is allowed to be used within 20 centimeters of the body of the user.

Limit for General Population/Uncontrolled exposure should be applied for this device, it is 1.6 W/kg as averaged over any 1 gram of tissue.

Table of Exposure Limits:

Body Position	SAR Value (W/Kg)	
	General Population/ Uncontrolled Exposure	Occupational/ Controlled Exposure
Whole-Body SAR (averaged over the entire body)	0.08	0.4
Partial-Body SAR (averaged over any 1 gram of tissue)	1.60	8.0
SAR for hands, wrists, feet and ankles (averaged over any 10 grams of tissue)	4.0	20.0

**NOTE:**

**General Population/Uncontrolled Exposure:** Locations where there is the exposure of individuals who have no knowledge or control of their exposure. General population/uncontrolled exposure limits are applicable to situations in which the general public may be exposed or in which persons who are exposed as a consequence of their employment may not be made fully aware of the potential for exposure or cannot exercise control over their exposure. Members of the general public would come under this category when exposure is not employment-related; for example, in the case of a wireless transmitter that exposes persons in its vicinity.

**Occupational/Controlled Exposure:** Locations where there is exposure that may be incurred by persons who are aware of the potential for exposure, In general, occupational/controlled exposure limits are applicable to situations in which persons are exposed as a consequence of their employment, who have been made fully aware of the potential for exposure and can exercise control over their exposure. This exposure category is also applicable when the exposure is of a transient nature due to incidental passage through a location where the exposure levels may be higher than the general population/uncontrolled limits, but the exposed person is fully aware of the potential for exposure and can exercise control over his or her exposure by leaving the area or by some other appropriate means.

### 3.3 Test Result Summary

#### 3.3.1 Highest SAR Values

Equipment Class	Band	Maximum Scaled SAR (W/kg)				Maximum Report SAR (W/kg)			
		Head (0mm)	Body-worn (10mm)	Hotspot (10mm)	Specific (0mm)	Head (0mm)	Body-worn (10mm)	Hotspot (10mm)	Specific (0mm)
		1g SAR			10g SAR	1g SAR			10g SAR
PCE	GSM 850	0.56	0.24	0.24	/	1.09	1.05	1.05	2.40
	GSM 1900	0.46	0.43	0.43	0.67				
	WCDMA Band 2	0.25	0.62	0.62	1.28				
	WCDMA Band 4	0.31	0.78	0.78	1.08				
	WCDMA Band 5	0.18	0.27	0.27	/				
	LTE Band 2	0.57	0.63	0.63	1.39				
	LTE Band 4	0.72	0.57	0.57	0.81				
	LTE Band 5	0.54	0.29	0.29	/				
	LTE Band 7	0.67	0.23	0.23	/				
	LTE Band 38	<b>1.09</b>	0.50	0.50	0.93				
	LTE Band 41	0.97	0.49	0.49	0.92				
	NR n5	0.40	0.27	0.27	/				
	NR n7	0.94	0.36	0.36	0.60				
	NR n38	0.76	0.41	0.41	/				
	NR n41	0.66	0.38	0.38	/				
	NR n77	0.87	<b>1.05</b>	<b>1.05</b>	1.85				
	NR n78	0.79	0.83	0.83	<b>2.40</b>				
	B2	0.57	0.41	0.41	/				
	B7	0.63	0.22	0.22	/				
	B38	0.37	0.23	0.23	/				
B41	0.41	0.26	0.26	/					
DTS	2.4G WLAN	0.50	0.11	0.11	/				
NII	5.2G WLAN	/	/	0.53	/				
	5.3G WLAN	0.50	0.59	/	1.46				
	5.6G WLAN	0.32	0.33	/	1.05				
	5.8G WLAN	0.10	/	0.12	/				
DSS	Bluetooth	0.17	0.04	0.04	/				
Limit (W/kg)		1.6			3.8	1.6			3.8
Verdict		PASS							

## 3.3.2 Highest Simultaneous Transmission SAR Values

Equipment Class	Maximum Scaled SAR (W/kg)			
	Head 1g (0mm)	Body-worn 1g (0mm)	Hotspot 1g (10mm)	Specific 10g (0mm)
PCE	<b>1.58</b>	<b>1.58</b>	<b>1.58</b>	<b>3.52</b>
DTS	1.41	1.10	1.10	/
NII	<b>1.58</b>	<b>1.58</b>	<b>1.58</b>	<b>3.52</b>
DSS	<b>1.58</b>	<b>1.58</b>	<b>1.58</b>	/
Limit (W/Kg)	1.60	1.60	1.60	4.00
Verdict	Pass			
Note: The highest simultaneous SAR please refer section 13.2				

### 3.4 Test Uncertainty

According to KDB 865664 D01, When the highest measured 1 g SAR within a frequency band is  $< 1.5$  W/kg, the extensive SAR measurement uncertainty analysis is not required in SAR reports submitted for equipment approval.

The maximum 1 g SAR for the EUT in this report is 1.093 W/kg, which is lower than 1.5 W/kg, so the extensive SAR measurement uncertainty analysis is not required in this report.

The maximum 10 g SAR for the EUT in this report is 2.401 W/kg, which is lower than 3.75 W/kg, so the extensive SAR measurement uncertainty analysis is not required in this report.

## 4 MEASUREMENT SYSTEM

### 4.1 Specific Absorption Rate (SAR) Definition

SAR is related to the rate at which energy is absorbed per unit mass in an object exposed to a radio field. The SAR distribution in a biological body is complicated and is usually carried out by experimental techniques or numerical modeling. The standard recommends limits for two tiers of groups, occupational/controlled and general population/uncontrolled, based on a person's awareness and ability to exercise control over his or her exposure. In general, occupational/controlled exposure limits are higher than the limits for general population/uncontrolled.

The SAR definition is the time derivative (rate) of the incremental energy ( $dW$ ) absorbed by (dissipated in) an incremental mass ( $dm$ ) contained in a volume element ( $dv$ ) of a given density ( $\rho$ ). The equation description is as below:

$$\mathbf{SAR} = \frac{d}{dt} \left( \frac{dW}{dm} \right) = \frac{d}{dt} \left( \frac{dW}{\rho dv} \right)$$

SAR is expressed in units of Watts per kilogram (W/kg) SAR measurement can be related to the electrical field in the tissue by

$$\mathbf{SAR} = \frac{\sigma E^2}{\rho}$$

Where:  $\sigma$  is the conductivity of the tissue,  $\rho$  is the mass density of the tissue and  $E$  is the RMS electrical field strength.

## 4.2 DASY SAR System

### 4.2.1 DASY SAR System Diagram

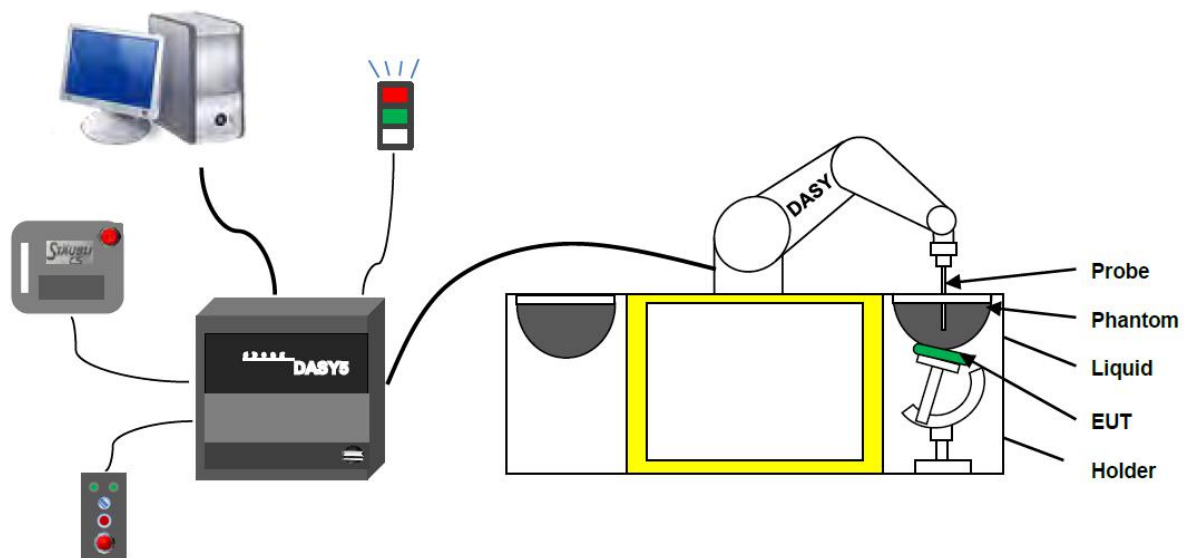

The DASY5 system for performing compliance tests consists of the following items:

1. A standard high precision 6-axis robot (Stäubli RX family) with controller and software. An arm extension for accommodating the data acquisition electronics (DAE).
2. A dosimetric probe, i.e. an isotropic E-field probe optimized and calibrated for usage in tissue simulating liquid. The probe is equipped with an optical surface detector system.
3. A data acquisition electronic (DAE) which performs the signal amplification, signal multiplexing, AD-conversion, offset measurements, mechanical surface detection, collision detection, etc. The unit is battery powered with standard or rechargeable batteries. The signal is optically transmitted to the EOC.
4. A unit to operate the optical surface detector which is connected to the EOC.
5. The Electro-Optical Coupler (EOC) performs the conversion from the optical into a digital electric signal of the DAE. The EOC is connected to the DASYS measurement server.
6. The DASYS measurement server, which performs all real-time data evaluation for field measurements and surface detection, controls robot movements and handles safety operation.
7. DASYS software and SEMCAD data evaluation software.
8. Remote control with teach panel and additional circuitry for robot safety such as warning lamps, etc.
9. The generic twin phantom enabling the testing of left-hand and right-hand usage.
10. The device holder for handheld mobile phones.
11. Tissue simulating liquid mixed according to the given recipes.
12. System validation dipoles allowing to validate the proper functioning of the system.



## 4.2.2 Robot

The Dasy SAR system uses the high precision robots. Symmetrical design with triangular core Built-in optical fiber for surface detection system For the 6-axis controller system, Built-in shielding against static charges PEEK enclosure material (resistant to organic solvents). The robot series have many features that are important for our application:



- **High precision**  
(repeatability  $\pm 0.02$  mm)
- **High reliability**  
(industrial design)
- **Low maintenance costs**  
(virtually maintenance free due to direct drive gears; no belt drives)
- **Jerk-free straight movements**  
(brush less synchron motors; no stepper motors)
- **Low ELF interference**  
(motor control fields shielded via the closed metallic construction shields)

### 4.2.3 E-Field Probe

The probe is specially designed and calibrated for use in liquids with high permittivities for the measurements the Specific Dosimetric E-Field Probe EX3DV4-SN: 7607 with following specifications is used.

Construction	Symmetrical design with triangular core Built-in optical fiber for surface detection system Built-in shielding against static charges PEEK enclosure material (resistant to organic solvents, e.g., glycolether)
Calibration	ISO/IEC 17025 calibration service available
Frequency	10 MHz to 6 GHz; Linearity: $\pm 0.2$ dB (30 MHz to 6 GHz)
Directivity	$\pm 0.2$ dB in HSL (rotation around probe axis) ; $\pm 0.4$ dB in HSL (rotation normal to probe axis)
Dynamic range	5 $\mu$ W/g to > 100 mW/g; Linearity: $\pm 0.2$ dB
Dimensions	Overall length: 337 mm (Tip: 9 mm) Tip diameter: 2.5 mm (Body: 10 mm) Distance from probe tip to dipole centers: 1.0 mm
Application	General dosimetry up to 3 GHz Compliance tests of mobile phones Fast automatic scanning in arbitrary phantoms (EX3DV4)

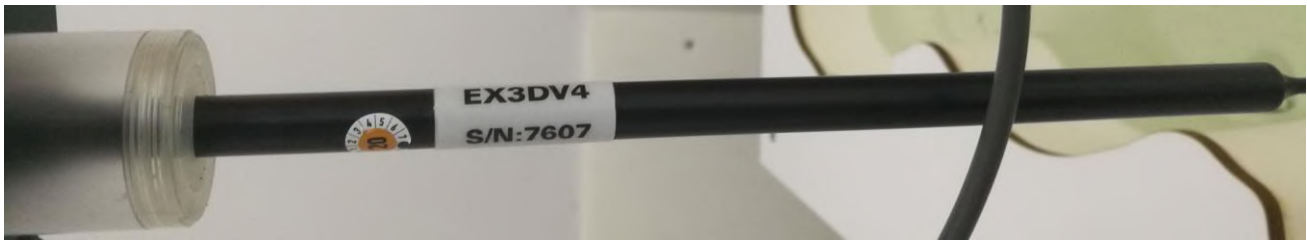

#### E-Field Probe Calibration Process

Probe calibration is realized, in compliance with CENELEC EN 62209-1/-2 and IEEE 1528 std, with CALISAR, Antennassa proprietary calibration system. The calibration is performed with the EN 62209-1/2 annexe technique using reference guide at the five frequencies.

#### 4.2.4 Data Acquisition Electronics

The data acquisition electronics (DAE) consist of a highly sensitive electrometer-grade preamplifier with auto-zeroing, a channel and gain-switching multiplexer, a fast 16 bit AD-converte and a command decoder with a control logic unit. Transmission to the measurement server is accomplished through an optical downlink for data and status information, as well as an optical uplink for commands and the clock.



- Input Impedance: 200M $\Omega$ m
- The Inputs: Symmetrical and Floating
- Commom Mode Rejection: Above 80dB

### 4.2.5 Phantoms

For the measurements the Specific Anthropomorphic Mannequin (SAM) defined by the IEEE SCC-34/SC2 group is used. The phantom is a polyurethane shell integrated in a wooden table. The thickness of the phantom amounts to 2mm +/- 0.2mm. It enables the dosimetric evaluation of left and right phone usage and includes an additional flat phantom part for the simplified performance check. The phantom set-up includes a cover, which prevents the evaporation of the liquid.

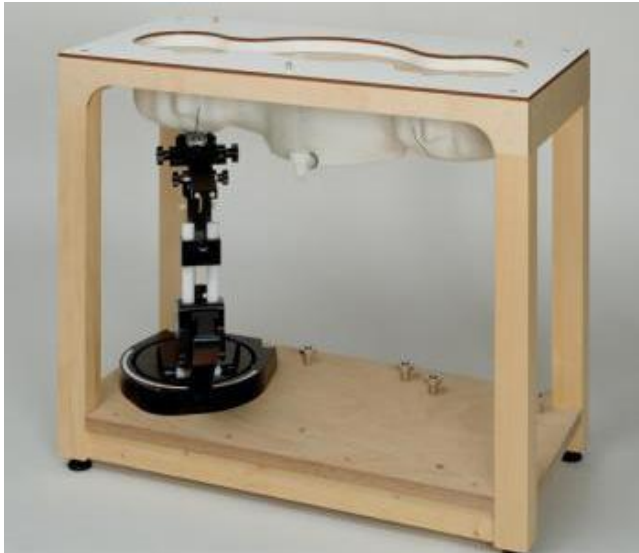

- Left hand
- Right hand
- Flat phantom

**Photo of Phantom SN1576**



Serial Number	Material	Length	Height
SN 1576 SAM1	Vinylester, glass fiber reinforced	1000	500

#### 4.2.6 Device Holder

The DASY5 device holder has two scales for device rotation (with respect to the body axis) and the device inclination (with respect to the line between the ear openings). The plane between the ear openings and the mouth tip has a rotation angle of  $65^\circ$ . The bottom plate contains three pair of bolts for locking the device holder. The device holder positions are adjusted to the standard measurement positions in the three sections. This device holder is used for standard mobile phones or PDA"s only. If necessary an additional support of polystyrene material is used. Larger DUT"s (e.g. notebooks) cannot be tested using this device holder. Instead a support of bigger polystyrene cubes and thin polystyrene plates is used to position the DUT in all relevant positions to find and measure spots with maximum SAR values. Therefore those devices are normally only tested at the flat part of the SAM.



The positioning system allows obtaining cheek and tilting position with a very good accuracy. Incompliance with CENELEC, the tilt angle uncertainty is lower than  $1^\circ$ .

### 4.2.7 Simulating Liquid

For SAR measurement of the field distribution inside the phantom, the phantom must be filled with homogeneous tissue simulating liquid to a depth of at least 15 cm. For head SAR testing, the liquid height from the ear reference point (ERP) of the phantom to the liquid top surface is larger than 15 cm. For body SAR testing, the liquid height from the center of the flat phantom to the liquid top surface is larger than 15 cm. The nominal dielectric values of the tissue simulating liquids in the phantom and the tolerance of 5%.

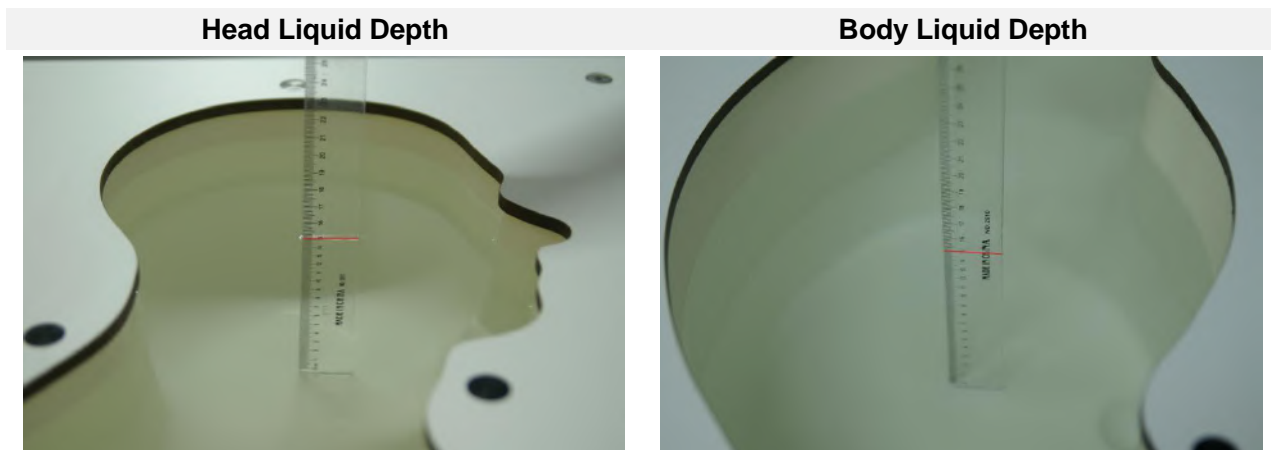

The following table gives the recipes for tissue simulating liquid and the theoretical Conductivity/Permittivity.

Head (Reference IEEE1528)								
Frequency (MHz)	Water (%)	Sugar (%)	Cellulose (%)	Salt (%)	Preventol (%)	DGBE (%)	Conductivity $\sigma$ (S/m)	Permittivity $\epsilon$
750	41.1	57.0	0.2	1.4	0.2	0	0.89	41.9
835	40.3	57.9	0.2	1.4	0.2	0	0.90	41.5
900	40.3	57.9	0.2	1.4	0.2	0	0.97	41.5
1800, 1900, 2000	55.2	0	0	0.3	0	44.5	1.4	40.0
2450	55.0	0	0	0.1	0	44.9	1.80	39.2
2600	54.9	0	0	0.1	0	45.0	1.96	39.0
Frequency (MHz)	Water (%)	Hexyl Carbitol (%)			Triton X-100 (%)		Conductivity $\sigma$ (S/m)	Permittivity $\epsilon$
5200	62.52	17.24			17.24		4.66	36.0
5800	62.52	17.24			17.24		5.27	35.3
Body (From instrument manufacturer)								
Frequency (MHz)	Water (%)	Sugar (%)	Cellulose (%)	Salt (%)	Preventol (%)	DGBE (%)	Conductivity $\sigma$ (S/m)	Permittivity $\epsilon$
750	51.7	47.2	0	0.9	0.1	0	0.96	55.5
835	50.8	48.2	0	0.9	0.1	0	0.97	55.2
900	50.8	48.2	0	0.9	0.1	0	1.05	55.0
1800, 1900, 2000	70.2	0	0	0.4	0	29.4	1.52	53.3
2450	68.6	0	0	0.1	0	31.3	1.95	52.7
2600	68.2	0	0	0.1	0	31.7	2.16	52.5
Frequency(MHz)	Water	DGBE			Salt		Conductivity	Permittivity

		(%)	(%)	$\sigma$ (S/m)	$\epsilon$
5200	78.60	21.40	/	5.54	47.86
5800	78.50	21.40	0.1	6.0	48.20

## 5 SYSTEM VERIFICATION

### 5.1 Purpose of System Check

The system performance check verifies that the system operates within its specifications. System and operator errors can be detected and corrected. It is recommended that the system performance check be performed prior to any usage of the system in order to guarantee reproducible results. The system performance check uses normal SAR measurements in a simplified setup with a well characterized source. This setup was selected to give a high sensitivity to all parameters that might fail or vary over time. The system check does not intend to replace the calibration of the components, but indicates situations where the system uncertainty is exceeded due to drift or failure.

### 5.2 System Check Setup

In the simplified setup for system evaluation, the EUT is replaced by a calibrated dipole and the power source is replaced by a continuous wave that comes from a signal generator. The calibrated dipole must be placed beneath the flat phantom section of the SAM twin phantom with the correct distance holder. The distance holder should touch the phantom surface with a light pressure at the reference marking and be oriented parallel to the long side of the phantom. The equipment setup is shown below:

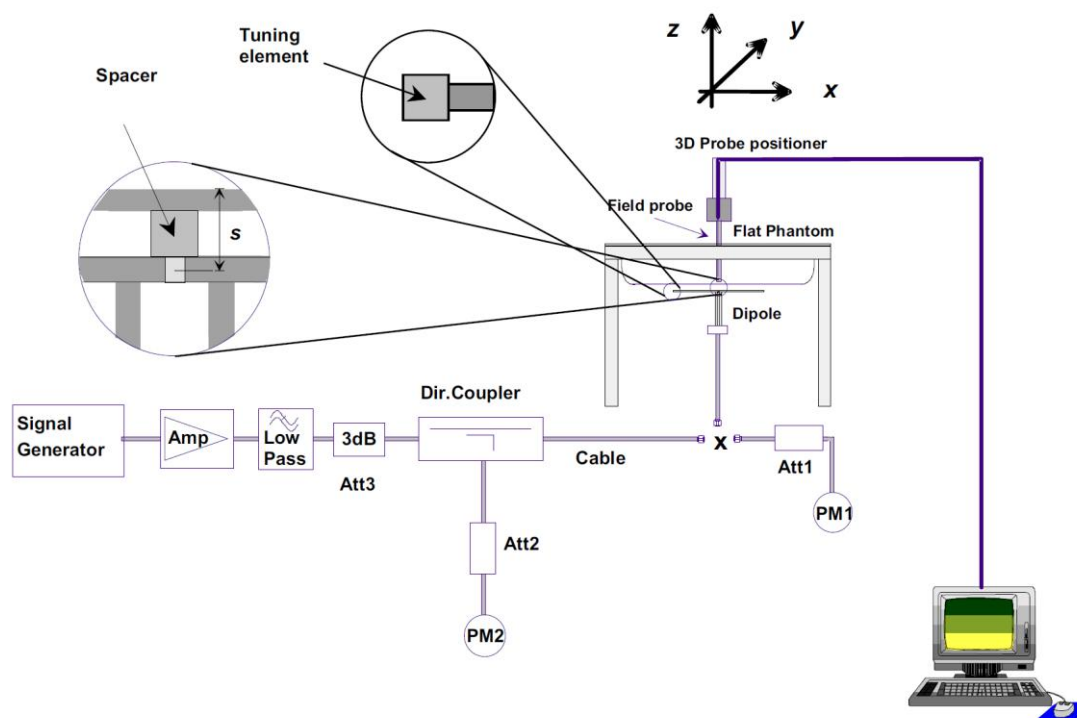



## 6 TEST POSITION CONFIGURATIONS

According to KDB 648474 D04 Handset, handsets are tested for SAR compliance in head, body-worn accessory and other use configurations described in the following subsections.

### 6.1 Head Exposure Conditions

Head exposure is limited to next to the ear voice mode operations. Head SAR compliance is tested according to the test positions defined in IEEE Std 1528-2013 using the SAM phantom illustrated as below.

#### 6.1.1 Two Imaginary Lines on the Handset

- The vertical center line passes through two points on the front side of the handset - the midpoint of the width  $w_t$  of the handset at the level of the acoustic output, and the midpoint of the width  $w_b$  of the bottom of the handset.
- The horizontal line is perpendicular to the vertical centerline and passes through the center of the acoustic output. The horizontal line is also tangential to the face of the handset at point A.
- The two lines intersect at point A. Note that for many handsets, point A coincides with the center of the acoustic output; however, the acoustic output may be located elsewhere on the horizontal line. Also note that the vertical center line is not necessarily parallel to the front face of the handset, especially for clamshell handsets, handsets with flip covers, and other irregularly shaped handsets.

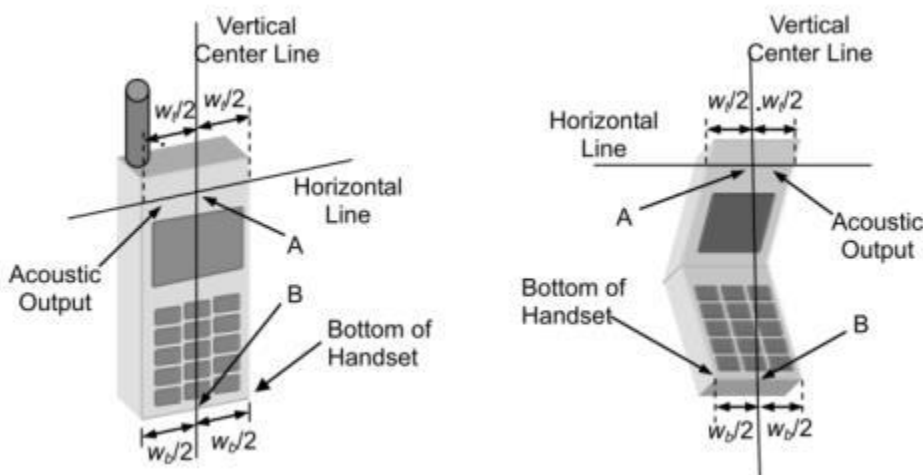

#### 6.1.2 Cheek Position

- To position the device with the vertical center line of the body of the device and the horizontal line crossing the center piece in a plane parallel to the sagittal plane of the phantom. While maintaining the device in this plane, align the vertical center line with the reference plane containing the three ear and mouth reference point (M: Mouth, RE: Right Ear, and LE: Left Ear) and align the center of the ear piece with the line RE-LE.
- To move the device towards the phantom with the ear piece aligned with the line LE-RE until the phone touched the ear. While maintaining the device in the reference plane and maintaining the phone contact with the ear, move the bottom of the phone until any point on the front side is in contact with the cheek of the phantom or until contact with the ear is lost.

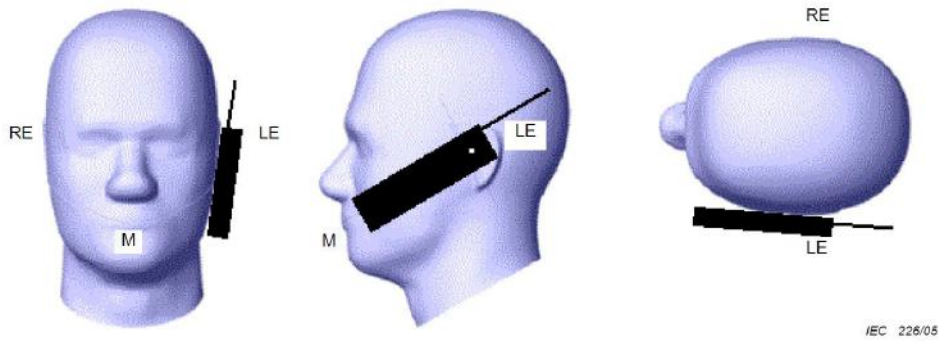

### 6.1.3 Tilted Position

- (a) To position the device in the “cheek” position described above.
- (b) While maintaining the device the reference plane described above and pivoting against the ear, moves it outward away from the mouth by an angle of 15 degrees or until contact with the ear is lost.



## 6.2 Body-worn Position Conditions

Body-worn accessory exposure is typically related to voice mode operations when handsets are carried in body-worn accessories. The body-worn accessory procedures in KDB 447498 are used to test for body-worn accessory SAR compliance, without a headset connected to it. This enables the test results for such configuration to be compatible with that required for hotspot mode when the body-worn accessory test separation distance is greater than or equal to that required for hotspot mode. When the reported SAR for a body-worn accessory.

Body-worn accessories that do not contain metallic or conductive components may be tested according to worst-case exposure configurations, typically according to the smallest test separation distance required for the group of body-worn accessories with similar operating and exposure characteristics. All body-worn accessories containing metallic components are tested in conjunction with the host device.

Body-worn accessory SAR compliance is based on a single minimum test separation distance for all wireless and operating modes applicable to each body-worn accessory used by the host, and according to the relevant voice and/or data mode transmissions and operations. If a body-worn accessory supports voice only operations in its normal and expected use conditions, testing of data mode for body-worn compliance is not required. A conservative minimum test separation distance for supporting off-the-shelf body-worn accessories that may be acquired by users of consumer handsets is used to test for body-worn accessory SAR compliance. This distance is determined by the handset manufacturer, according to the requirements of Supplement C 01-01. Devices that are designed to operate on the body of users using lanyards and straps, or without requiring additional body-worn accessories, will be tested using a conservative minimum test separation distance  $\leq 5$  mm to support compliance.

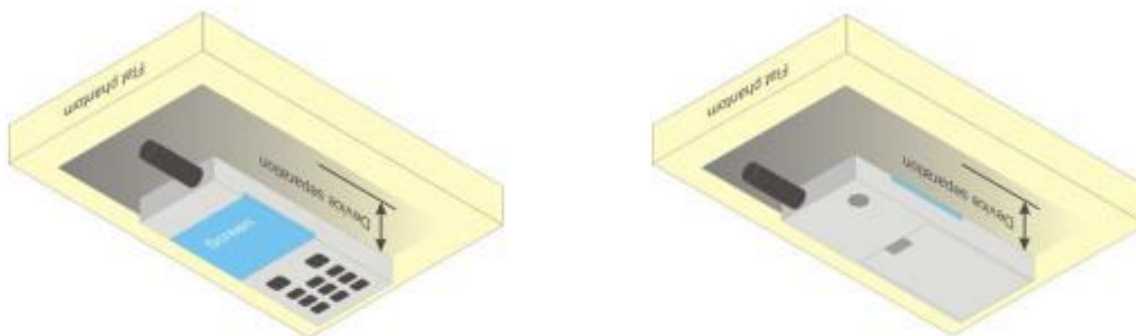

### 6.3 Hotspot Mode Exposure Position Conditions

For handsets that support hotspot mode operations, with wireless router capabilities and various web browsing functions, the relevant hand and body exposure conditions are tested according to the hotspot SAR procedures in KDB 941225. A test separation distance of 10 mm is required between the phantom and all surfaces and edges with a transmitting antenna located within 25 mm from that surface or edge. When the form factor of a handset is smaller than 9 cm x 5 cm, a test separation distance of 5 mm (instead of 10 mm) is required for testing hotspot mode. When the separation distance required for body-worn accessory testing is larger than or equal to that tested for hotspot mode, in the same wireless mode and for the same surface of the phone, the hotspot mode SAR data may be used to support body-worn accessory SAR compliance for that particular configuration (surface).

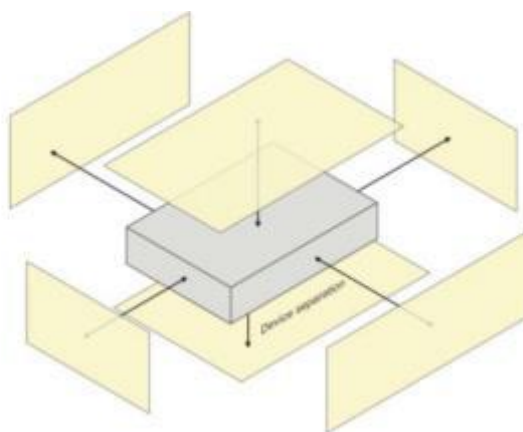

### 6.4 Product Specific 10g Exposure Consideration

According with FCC KDB 648474 D04, for smart phones with a display diagonal dimension > 15.0 cm or an overall diagonal dimension > 16.0 cm that provide similar mobile web access and multimedia support found in mini-tablets or UMPC mini-tablets that support voice calls next to the ear, unless it is confirmed otherwise through KDB inquiries, the following phablet procedures should be applied to evaluate SAR compliance for each applicable wireless modes and frequency band. Devices marketed as phablets, regardless of form factors and operating characteristics must be tested as a phablet to determine SAR compliance;

The UMPC mini-tablet procedures must also be applied to test the SAR of all surfaces and edges with an antenna located at  $\leq 25$  mm from that surface or edge, in direct contact with a flat phantom, for 10-g extremity SAR according to the body-equivalent tissue dielectric parameters in KDB 865664 to address interactive hand use exposure conditions. The UMPC mini-tablet 1-g SAR at 5 mm is not required. When hotspot mode applies, 10-g extremity SAR is required only for the surfaces and edges with hotspot mode 1-g reported SAR > 1.2 W/kg.

## 7 MEASUREMENT PROCEDURE

### 7.1 Measurement Process Diagram

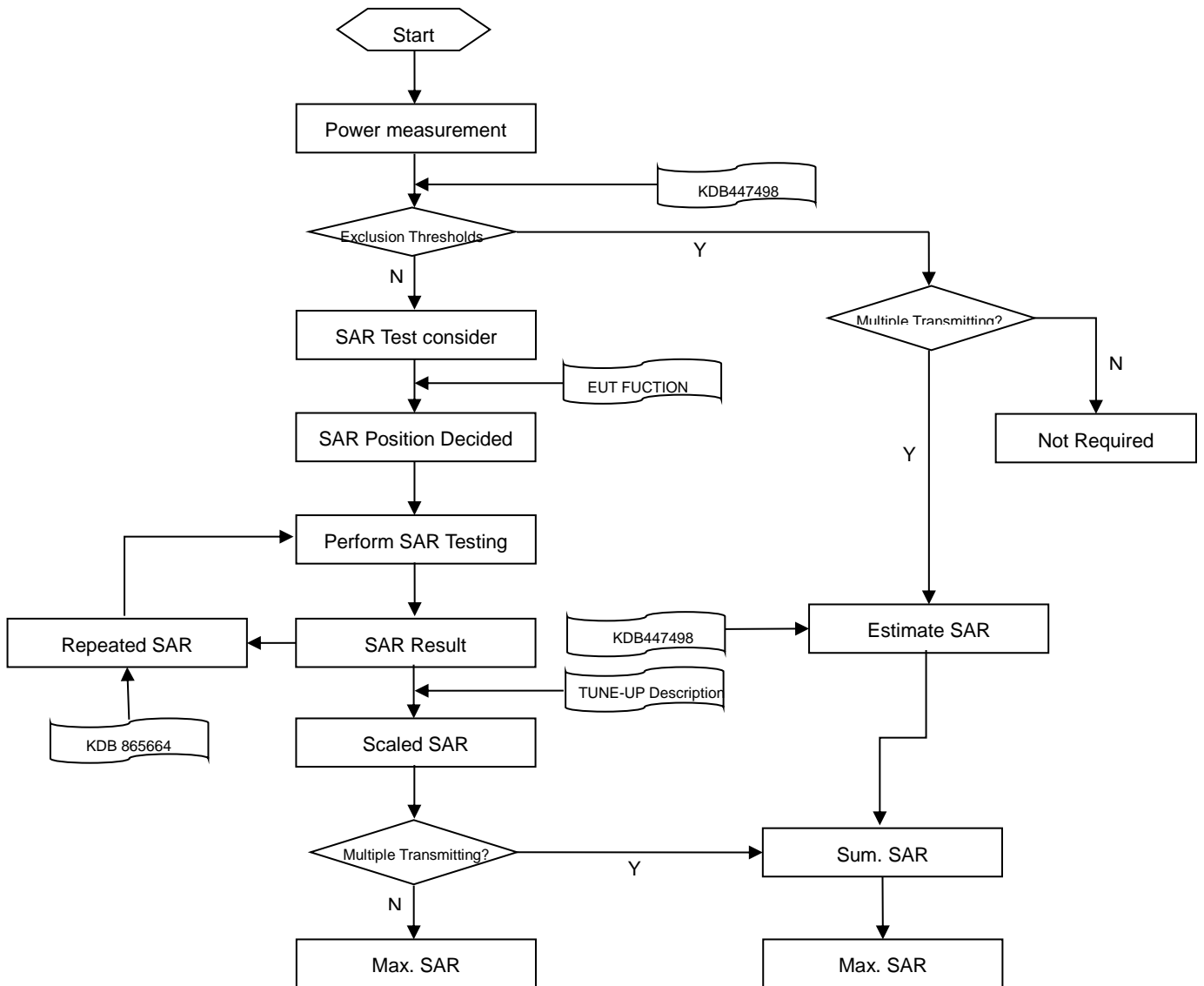

## 7.2 SAR Scan General Requirement

Probe boundary effect error compensation is required for measurements with the probe tip closer than half a probe tip diameter to the phantom surface. Both the probe tip diameter and sensor offset distance must satisfy measurement protocols; to ensure probe boundary effect errors are minimized and the higher fields closest to the phantom surface can be correctly measured and extrapolated to the phantom surface for computing 1 g SAR. Tolerances of the post-processing algorithms must be verified by the test laboratory for the scan resolutions used in the SAR measurements, according to the reference distribution functions specified in IEEE Std 1528-2013.

		≤3GHz	>3GHz
Maximum distance from closest measurement point (geometric center of probe sensors) to phantom surface		5±1 mm	$\frac{1}{2} \cdot \delta \cdot \ln(2) \pm 0.5$ mm
Maximum probe angle from probe axis to phantom surface normal at the measurement location		30°±1°	20°±1°
Maximum area scan spatial resolution: $\Delta x$ Area , $\Delta y$ Area		≤ 2 GHz: ≤ 15 mm 2 – 3 GHz: ≤ 12 mm	3–4 GHz: ≤ 12 mm 4 – 6 GHz: ≤ 10 mm
		When the x or y dimension of the test device, in the measurement plane orientation, is smaller than the above, the measurement resolution must be ≤ the corresponding x or y dimension of the test device with at least one measurement point on the test device.	
Maximum zoom scan spatial resolution: $\Delta x$ Zoom , $\Delta y$ Zoom		≤ 2 GHz: ≤ 8 mm 2 – 3 GHz: ≤ 5 mm*	3–4 GHz: ≤ 5 mm* 4 – 6 GHz: ≤ 4 mm*
Maximum zoom scan spatial resolution, normal to phantom surface	uniform grid: $\Delta z$ Zoom (n)	≤ 5 mm	3–4 GHz: ≤ 4 mm
			4–5 GHz: ≤ 3 mm
			5–6 GHz: ≤ 2 mm
	graded grid	$\Delta z$ Zoom (1): between 1st two points closest to phantom surface	≤ 4 mm
4–5 GHz: ≤ 2.5 mm			
	$\Delta z$ Zoom (n>1): between subsequent points	≤ 1.5· $\Delta z$ Zoom (n-1)	
Minimum zoom scan volume	x, y, z	≥30 mm	3–4 GHz: ≥ 28 mm
			4–5 GHz: ≥ 25 mm
			5–6 GHz: ≥ 22 mm

### Note:

1.  $\delta$  is the penetration depth of a plane-wave at normal incidence to the tissue medium; see draft standard IEEE P1528-2011 for details.
2. \* When zoom scan is required and the reported SAR from the area scan based 1 g SAR estimation procedures of KDB 447498 is ≤ 1.4 W/kg, ≤ 8 mm, ≤ 7 mm and ≤ 5 mm zoom scan resolution may be applied, respectively, for 2 GHz to 3GHz, 3 GHz to 4 GHz and 4 GHz to 6 GHz.

### 7.3 Measurement Procedure

The following steps are used for each test position

- a. Establish a call with the maximum output power with a base station simulator. The connection between the mobile and the base station simulator is established via air interface
- b. Measurement of the local E-field value at a fixed location. This value serves as a reference value for calculating a possible power drift.
- c. Measurement of the SAR distribution with a grid of 8 to 16mm \* 8 to 16 mm and a constant distance to the inner surface of the phantom. Since the sensors cannot directly measure at the inner phantom surface, the values between the sensors and the inner phantom surface are extrapolated. With these values the area of the maximum SAR is calculated by an interpolation scheme.
- d. Around this point, a cube of 30 \* 30 \* 30 mm or 32 \* 32 \* 32 mm is assessed by measuring 5 or 8 \* 5 or 8\*4 or 5 mm. With these data, the peak spatial-average SAR value can be calculated.

### 7.4 Area & Zoom Scan Procedure

First Area Scan is used to locate the approximate location(s) of the local peak SAR value(s). The measurement grid within an Area Scan is defined by the grid extent, grid step size and grid offset. Next, in order to determine the EM field distribution in a three-dimensional spatial extension, Zoom Scan is required. The Zoom Scan is performed around the highest E-field value to determine the averaged SAR-distribution over 10 g. Area scan and zoom scan resolution setting follows KDB 865664 D01v01r04 quoted below.

When the 1 g SAR of the highest peak is within 2 dB of the SAR limit, additional zoom scans are required for other peaks within 2 dB of the highest peak that have not been included in any zoom scan to ensure there is no increase in SAR.

## 8 CONDUCTED RF OUPUT POWER

### 8.1 GSM

Please refer the document “Conducted RF Output Power List.pdf”.

### 8.2 WCDMA

Please refer the document “Conducted RF Output Power List.pdf”.

### 8.3 LTE

Please refer the document “Conducted RF Output Power List.pdf”.

### 8.4 Uplink CA Power

Note:

1. This devices supports intra-band uplink CA of 7C/38C, inter-band uplink CA of 4A+7A.
2. For intra-band uplink carrier aggregation power verification and measurement is selected highest PCC and SCC bandwidth combination to do and was according to 3GPP 36.52101 sectino6.2.2A.1 and section 6.2.2A.2 test procedure.
3. For intra-band uplink CA output power was measured high / middle / low channel combination, and for SAR verification is selected highest output power combination with each exposure condition in each frequency band using the highest SAR configuration test in standalone LTE mode.

Please refer the document “Conducted RF Output Power List.pdf”.

### 8.5 NR 5G

Please refer the document “Conducted RF Output Power List.pdf”.



## 8.6 WIFI

### 8.6.1 2.4G WIFI Full Power&DSI4

Band (GHz)	Mode	Channel	Freq. (MHz)	Average Power (dBm)	Tune-up Limit (dBm)	SAR Test Require.
2.4 (2.4~2.4835)	802.11b	1	2412	14.62	15.50	Yes
		6	2437	14.89	15.50	Yes
		11	2462	<b>15.09</b>	15.50	Yes
	802.11g	1	2412	12.87	14.00	No
		6	2437	13.06	14.00	No
		11	2462	13.38	14.00	No
	802.11n(HT20)	1	2412	12.92	14.00	No
		6	2437	12.84	14.00	No
		11	2462	13.08	14.00	No
	802.11n(HT40)	3	2422	11.46	12.00	No
		6	2437	11.48	12.00	No
		9	2452	11.65	12.00	No

Note: When multiple channel bandwidth configurations in a frequency band have the same maximum tune-up output power, the test configuration is determined by applying the following steps sequentially.

- 1) The largest channel bandwidth configuration is selected between the multiple configurations in a frequency band with the same maximum tune-up output power.
- 2) When multiple transmission modes (802.11b/g/n) have the same maximum tune-up output power, largest channel bandwidth, lowest order modulation and lowest data rate, the lowest order 802.11 mode is selected; i.e., 802.11b is chosen over 802.11g, and 802.11g chosen over 802.11n.
- 3) According KDB 247228, when the highest reported SAR for DSSS is adjusted by the ratio of OFDM to DSSS specified maximum output power and the adjusted SAR is  $\leq 1.2$  W/kg, OFDM SAR test is not required.  
Adjusted SAR =  $0.504 * (25.12\text{mW}/35.48\text{mW}) = 0.357$  W/Kg, so 2.4G OFDM SAR test is not required.

## 8.6.2 2.4G WIFI DS11

Band (GHz)	Mode	Channel	Freq. (MHz)	Average Power (dBm)	Tune-up Limit (dBm)	SAR Test Require.
2.4 (2.4~2.4835)	802.11b	1	2412	14.62	15.50	Yes
		6	2437	14.89	15.50	Yes
		11	2462	<b>15.09</b>	15.50	Yes
	802.11g	1	2412	12.87	14.00	No
		6	2437	13.06	14.00	No
		11	2462	13.38	14.00	No
	802.11n(HT20)	1	2412	12.92	14.00	No
		6	2437	12.84	14.00	No
		11	2462	13.08	14.00	No
	802.11n(HT40)	3	2422	11.46	12.00	No
		6	2437	11.48	12.00	No
		9	2452	11.65	12.00	No

Note: When multiple channel bandwidth configurations in a frequency band have the same maximum tune-up output power, the test configuration is determined by applying the following steps sequentially.

- 1) The largest channel bandwidth configuration is selected between the multiple configurations in a frequency band with the same maximum tune-up output power.
- 2) When multiple transmission modes (802.11b/g/n) have the same maximum tune-up output power, largest channel bandwidth, lowest order modulation and lowest data rate, the lowest order 802.11 mode is selected; i.e., 802.11b is chosen over 802.11g, and 802.11g chosen over 802.11n.
- 3) According KDB 247228, when the highest reported SAR for DSSS is adjusted by the ratio of OFDM to DSSS specified maximum output power and the adjusted SAR is  $\leq 1.2$  W/kg, OFDM SAR test is not required.  
Adjusted SAR =  $0.504 * (25.12\text{mW}/35.48\text{mW}) = 0.357$  W/Kg, so 2.4G OFDM SAR test is not required.

## 8.6.3 5G WIFI Full Power&amp;DSI4

Band (GHz)	Mode	Channel	Freq. (MHz)	Average Power (dBm)	Tune-up Limit (dBm)	SAR Test Require.
5.2 (5.15~5.25)	802.11a	36	5180	13.62	15.00	No
		44	5220	13.57	15.00	No
		48	5240	13.71	15.00	No
	802.11n(HT20)	36	5180	15.65	17.50	No
		44	5220	16.70	17.50	No
		48	5240	15.65	17.50	No
	802.11n(HT40)	38	5190	15.25	16.50	No
		46	5230	15.32	16.50	No
	802.11ac(VHT20)	36	5180	15.76	17.50	No
		44	5220	15.75	17.50	No
		48	5240	15.83	17.50	No
	802.11ac(VHT40)	38	5190	16.27	17.50	Yes
		46	5230	<b>16.55</b>	17.50	Yes
802.11ac(VHT80)	42	5210	13.91	15.50	No	
5.3 (5.25~5.35)	802.11a	52	5260	13.70	15.00	No
		60	5300	13.76	15.00	No
		64	5320	13.76	15.00	No
	802.11n(HT20)	52	5260	15.59	17.50	Yes
		60	5300	<b>15.86</b>	17.50	Yes
		64	5320	16.16	17.50	Yes
	802.11n(HT40)	54	5270	13.02	14.50	No
		62	5310	13.26	14.50	No
	802.11ac(VHT20)	52	5260	15.71	17.50	No
		60	5300	15.94	17.50	No
		64	5320	16.12	17.50	No
	802.11ac(VHT40)	54	5270	13.46	15.00	No
		62	5310	13.76	15.00	No
	802.11ac(VHT80)	58	5290	13.95	15.50	No
	5.6 (5.47~5.725)	802.11a	100	5500	16.54	17.50
116			5580	16.68	17.50	No
120			5600	16.77	17.50	No
140			5700	16.91	17.50	No
144			5720	16.63	17.50	No
802.11n(HT20)		100	5500	15.60	17.50	No
		116	5580	15.86	17.50	No
		140	5700	16.30	17.50	No

		144	5720	16.00	17.50	No
	802.11n(HT40)	102	5510	15.01	16.50	No
		118	5590	15.59	16.50	No
		134	5670	15.86	16.50	No
		142	5710	15.61	16.50	No
		100	5500	15.81	17.50	No
	802.11ac(VHT20)	116	5580	16.15	17.50	No
		140	5700	16.58	17.50	No
		144	5720	16.37	17.50	No
		102	5510	16.07	17.50	Yes
	802.11ac(VHT40)	118	5590	16.57	17.50	Yes
		134	5670	16.56	17.50	Yes
		142	5710	<b>16.86</b>	17.50	Yes
		106	5530	13.76	15.50	No
	802.11ac(VHT80)	122	5610	14.59	15.50	No
		138	5690	14.60	15.50	No
		149	5745	13.23	13.50	No
5.8 (5.725~5.850)	802.11a	157	5785	12.95	13.50	No
		165	5825	12.56	13.50	No
		149	5745	13.47	13.50	No
	802.11n(HT20)	157	5785	13.31	13.50	No
		165	5825	13.11	13.50	No
		151	5755	13.25	13.50	No
	802.11n(HT40)	159	5795	12.64	13.50	No
		149	5745	13.25	13.50	No
		157	5785	13.14	13.50	No
	802.11ac(VHT20)	165	5825	13.08	13.50	No
		151	5755	13.48	13.50	No
		159	5795	13.09	13.50	No
	802.11ac(VHT40)	155	5775	<b>11.95</b>	13.50	Yes

Note: When the same maximum output power is specified for both bands, begin SAR measurement in U-NII-2A band by applying the OFDM SAR requirements. If the highest reported SAR for a test configuration is  $\leq 1.2$  W/kg, SAR is not required for U-NII-1 band for that configuration (802.11 mode and exposure condition); otherwise, each band is tested independently for SAR.

## 8.6.4 5G WIFI DSI1

Band (GHz)	Mode	Channel	Freq. (MHz)	Average Power (dBm)	Tune-up Limit (dBm)	SAR Test Require.
5.2 (5.15~5.25)	802.11a	36	5180	10.29	11.50	No
		44	5220	10.18	11.50	No
		48	5240	10.32	11.50	No
	802.11n(HT20)	36	5180	12.05	14.00	No
		44	5220	12.18	14.00	No
		48	5240	12.07	14.00	No
	802.11n(HT40)	38	5190	11.77	13.00	No
		46	5230	12.07	13.00	No
	802.11ac(VHT20)	36	5180	12.24	14.00	No
		44	5220	12.20	14.00	No
		48	5240	12.33	14.00	No
	802.11ac(VHT40)	38	5190	12.61	14.00	Yes
		46	5230	<b>12.84</b>	14.00	Yes
802.11ac(VHT80)	42	5210	10.60	12.00	No	
5.3 (5.25~5.35)	802.11a	52	5260	10.14	11.50	No
		60	5300	10.22	11.50	No
		64	5320	10.34	11.50	No
	802.11n(HT20)	52	5260	12.02	14.00	Yes
		60	5300	12.18	14.00	Yes
		64	5320	<b>12.65</b>	14.00	Yes
	802.11n(HT40)	54	5270	9.34	11.00	No
		62	5310	9.90	11.00	No
	802.11ac(VHT20)	52	5260	12.39	14.00	No
		60	5300	12.34	14.00	No
		64	5320	12.52	14.00	No
	802.11ac(VHT40)	54	5270	10.14	11.50	No
		62	5310	10.37	11.50	No
	802.11ac(VHT80)	58	5290	10.57	12.00	No
	5.6 (5.47~5.725)	802.11a	100	5500	13.18	14.00
116			5580	12.99	14.00	No
120			5600	13.08	14.00	No
140			5700	13.48	14.00	No
144			5720	13.00	14.00	No
802.11n(HT20)		100	5500	12.30	14.00	No
		116	5580	12.48	14.00	No
		140	5700	12.91	14.00	No

		144	5720	12.64	14.00	No
	802.11n(HT40)	102	5510	11.32	13.00	No
		118	5590	11.22	13.00	No
		134	5670	12.38	13.00	No
		142	5710	12.11	13.00	No
		100	5500	12.17	14.00	No
	802.11ac(VHT20)	116	5580	12.83	14.00	No
		140	5700	13.03	14.00	No
		144	5720	12.99	14.00	No
		102	5510	12.25	14.00	Yes
	802.11ac(VHT40)	118	5590	12.38	14.00	Yes
		134	5670	12.36	14.00	Yes
		142	5710	<b>12.44</b>	14.00	Yes
		106	5530	10.13	12.00	No
	802.11ac(VHT80)	122	5610	11.11	12.00	No
		138	5690	11.05	12.00	No
149		5745	9.53	10.00	No	
5.8 (5.725~5.850)	802.11a	157	5785	9.48	10.00	No
		165	5825	9.05	10.00	No
		149	5745	9.81	10.00	No
	802.11n(HT20)	157	5785	9.79	10.00	No
		165	5825	9.44	10.00	No
		151	5755	9.94	10.00	No
	802.11n(HT40)	159	5795	9.15	10.00	No
		149	5745	9.66	10.00	No
		157	5785	9.59	10.00	No
	802.11ac(VHT20)	165	5825	9.61	10.00	No
		151	5755	9.91	10.00	No
		159	5795	9.60	10.00	No
	802.11ac(VHT40)	155	5775	<b>9.50</b>	10.00	Yes

Note: When the same maximum output power is specified for both bands, begin SAR measurement in U-NII-2A band by applying the OFDM SAR requirements. If the highest reported SAR for a test configuration is  $\leq 1.2$  W/kg, SAR is not required for U-NII-1 band for that configuration (802.11 mode and exposure condition); otherwise, each band is tested independently for SAR.

## 8.7 Bluetooth

Mode	GFSK			π/4-DQPSK		
Channel	0	39	78	0	39	78
Frequency (MHz)	2402	2441	2480	2402	2441	2480
Average Power (dBm)	8.08	7.91	7.48	4.54	4.46	4.02
Tune-Up Limit (dBm)	10.00	9.00	9.00	6.50	6.00	6.00
Mode	8-DPSK			/		
Channel	0	39	78	/	/	/
Frequency (MHz)	2402	2441	2480	/	/	/
Average Power (dBm)	4.50	4.43	3.91	/	/	/
Tune-Up Limit (dBm)	6.50	6.00	5.50	/		
Mode	BLE-1Mbps			BLE-2Mbps		
Channel	0	19	39	0	19	39
Frequency (MHz)	2402	2440	2480	2402	2440	2480
Average Power (dBm)	8.05	7.73	7.45	8.00	8.02	7.66
Tune-Up Limit (dBm)	10.00	9.00	9.00	10.00	10.00	9.00

Note: The Bluetooth duty cycle is 76.88 % as following figure, according to 2016 Oct. TCB workshop for Bluetooth SAR scaling need further consideration and the maximum duty cycle is 100%, therefore the actual duty cycle will be scaled up to 100% for Bluetooth reported SAR calculation.

### Duty Cycle

#### GFSK

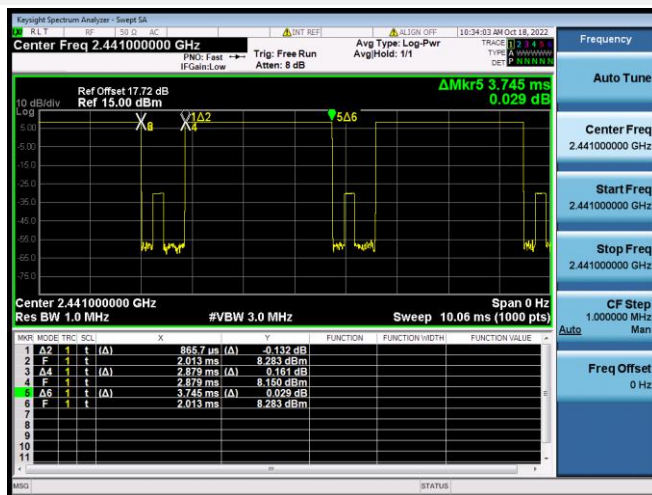

## 8.8 Power Reduction List

1. This mobile phone device supports the receiver detection mechanism. This device uses the receiver to indicate whether the user is making a call in head.
2. When device is making call in head, the power reduction will applied for SAR compliance.
3. This device uses the P-sensor to detect handheld state.

**WWAN Antenna Power table**

DSI	Position	Receiver	SAR sensor_1	SAR sensor_2	SAR sensor_3	Antenna	Dist. (mm)
DSI1	Head	ON	NA	NA	NA	Ant.1/2/3/4/5/6	0
DSI2	Body-worn/Hotspot/Specific	OFF	OFF	OFF	OFF	Ant.1	>16
			OFF	OFF	OFF	Ant.2	>6
			OFF	OFF	OFF	Ant.4	>16
			NA	NA	NA	Ant.3/5/6	N/A
DSI3		OFF	ON	ON	ON	Ant.1	≤16
			OFF	OFF	OFF	Ant.2	N/A
			OFF	OFF	OFF	Ant.4	N/A
			NA	NA	NA	Ant.3/5/6	N/A
DSI4		OFF	OFF	OFF	OFF	Ant.1	N/A
			ON	ON	ON	Ant.2	≤6
			ON	ON	ON	Ant.4	≤16
			NA	NA	NA	Ant.3/5/6	unlimited



Mode	Antenna	WWAN Antenna				
		Full Power	Receiver on	Receiver off		
			Head	Body&Limbs		
			DSI1	DSI2	DSI3	DSI4
GSM 850	Ant.4	33.50	30.50	33.50	33.50	31.50
GPRS850 1 Tx Slot	Ant.4	33.50	30.50	33.50	33.50	31.50
GPRS850 2 Tx Slots	Ant.4	27.50	24.50	27.50	27.50	25.50
GPRS850 3 Tx Slots	Ant.4	31.50	28.50	31.50	31.50	29.50
GPRS850 4 Tx Slots	Ant.4	24.50	21.50	24.50	24.50	22.50
EGPRS850 1 Tx Slot	Ant.4	29.50	26.50	29.50	29.50	27.50
EGPRS850 2 Tx Slots	Ant.4	22.70	19.70	22.70	22.70	20.70
EGPRS850 3 Tx Slots	Ant.4	27.00	24.00	27.00	27.00	25.00
EGPRS850 4 Tx Slots	Ant.4	21.50	18.50	21.50	21.50	19.50
GSM 850	Ant.1	33.50	33.50	33.50	33.50	33.50
GPRS850 1 Tx Slot	Ant.1	33.50	33.50	33.50	33.50	33.50
GPRS850 2 Tx Slots	Ant.1	27.50	27.50	27.50	27.50	27.50
GPRS850 3 Tx Slots	Ant.1	31.50	31.50	31.50	31.50	31.50
GPRS850 4 Tx Slots	Ant.1	24.50	24.50	24.50	24.50	24.50
EGPRS850 1 Tx Slot	Ant.1	29.50	29.50	29.50	29.50	29.50
EGPRS850 2 Tx Slots	Ant.1	22.70	22.70	22.70	22.70	22.70
EGPRS850 3 Tx Slots	Ant.1	27.00	27.00	27.00	27.00	27.00
EGPRS850 4 Tx Slots	Ant.1	21.50	21.50	21.50	21.50	21.50
GSM 1900	Ant.4	30.50	24.00	30.50	30.50	26.00
GPRS1900 1 Tx Slot	Ant.4	30.50	24.00	30.50	30.50	26.00
GPRS1900 2 Tx Slots	Ant.4	27.00	20.50	27.00	27.00	22.50
GPRS1900 3 Tx Slots	Ant.4	28.50	22.00	28.50	28.50	23.00
GPRS1900 4 Tx Slots	Ant.4	24.00	17.50	24.00	24.00	20.00
EGPRS1900 1 Tx Slot	Ant.4	26.50	20.00	26.50	26.50	21.50
EGPRS1900 2 Tx Slots	Ant.4	22.20	15.70	22.20	22.20	18.50
EGPRS1900 3 Tx Slots	Ant.4	24.50	18.00	24.50	24.50	20.00
EGPRS1900 4 Tx Slots	Ant.4	21.00	14.50	21.00	21.00	16.50
GSM 1900	Ant.1	30.50	30.50	30.50	26.00	26.00
GPRS1900 1 Tx Slot	Ant.1	30.50	30.50	30.50	26.00	26.00
GPRS1900 2 Tx Slots	Ant.1	27.00	27.00	27.00	22.50	22.50

GPRS1900 3 Tx Slots	Ant.1	28.50	28.50	28.50	24.00	24.00
GPRS1900 4 Tx Slots	Ant.1	24.00	24.00	24.00	19.50	19.50
EGPRS1900 1 Tx Slot	Ant.1	26.50	26.50	26.50	22.00	22.00
EGPRS1900 2 Tx Slots	Ant.1	22.20	22.20	22.20	17.70	17.70
EGPRS1900 3 Tx Slots	Ant.1	24.50	24.50	24.50	20.00	20.00
EGPRS1900 4 Tx Slots	Ant.1	21.00	21.00	21.00	16.50	16.50
WCDMA Band2 AMR	Ant.4	26.00	19.00	26.00	26.00	21.00
WCDMA Band2 RMC	Ant.4	26.00	19.00	26.00	26.00	21.00
HSDPA Subtest-1	Ant.4	25.00	18.00	25.00	25.00	20.00
HSDPA Subtest-2	Ant.4	25.00	18.00	25.00	25.00	20.00
HSDPA Subtest-3	Ant.4	24.50	17.50	24.50	24.50	19.50
HSDPA Subtest-4	Ant.4	24.50	17.50	24.50	24.50	19.50
DC-HSDPA Subtest-1	Ant.4	25.00	18.00	25.00	25.00	20.00
DC-HSDPA Subtest-2	Ant.4	25.00	18.00	25.00	25.00	20.00
DC-HSDPA Subtest-3	Ant.4	24.50	17.50	24.50	24.50	19.50
DC-HSDPA Subtest-4	Ant.4	24.50	17.50	24.50	24.50	19.50
HSUPA Subtest-1	Ant.4	25.50	18.50	25.50	25.50	20.50
HSUPA Subtest-2	Ant.4	23.50	16.50	23.50	23.50	18.50
HSUPA Subtest-3	Ant.4	24.50	17.50	24.50	24.50	19.50
HSUPA Subtest-4	Ant.4	23.50	16.50	23.50	23.50	18.50
HSUPA Subtest-5	Ant.4	25.50	18.50	25.50	25.50	20.50
WCDMA Band2 AMR	Ant.1	26.00	26.00	22.50	19.50	19.50
WCDMA Band2 RMC	Ant.1	26.00	26.00	22.50	19.50	19.50
HSDPA Subtest-1	Ant.1	25.00	25.00	21.50	18.50	18.50
HSDPA Subtest-2	Ant.1	25.00	25.00	21.50	18.50	18.50
HSDPA Subtest-3	Ant.1	24.50	24.50	21.00	18.00	18.00
HSDPA Subtest-4	Ant.1	24.50	24.50	21.00	18.00	18.00
DC-HSDPA Subtest-1	Ant.1	25.00	25.00	21.50	18.50	18.50
DC-HSDPA Subtest-2	Ant.1	25.00	25.00	21.50	18.50	18.50
DC-HSDPA Subtest-3	Ant.1	24.50	24.50	21.00	18.00	18.00
DC-HSDPA Subtest-4	Ant.1	24.50	24.50	21.00	18.00	18.00
HSUPA Subtest-1	Ant.1	25.50	25.50	22.00	19.00	19.00
HSUPA Subtest-2	Ant.1	23.50	23.50	20.00	17.00	17.00
HSUPA Subtest-3	Ant.1	24.50	24.50	21.00	18.00	18.00

HSUPA Subtest-4	Ant.1	23.50	23.50	20.00	17.00	17.00
HSUPA Subtest-5	Ant.1	25.50	25.50	22.00	19.00	19.00
WCDMA Band4 AMR	Ant.4	25.50	22.50	25.50	25.50	21.50
WCDMA Band4 RMC	Ant.4	25.50	22.50	25.50	25.50	21.50
HSDPA Subtest-1	Ant.4	24.50	21.50	24.50	24.50	20.50
HSDPA Subtest-2	Ant.4	24.50	21.50	24.50	24.50	20.50
HSDPA Subtest-3	Ant.4	24.00	21.00	24.00	24.00	20.00
HSDPA Subtest-4	Ant.4	24.00	21.00	24.00	24.00	20.00
DC-HSDPA Subtest-1	Ant.4	24.50	21.50	24.50	24.50	20.50
DC-HSDPA Subtest-2	Ant.4	24.50	21.50	24.50	24.50	20.50
DC-HSDPA Subtest-3	Ant.4	24.00	21.00	24.00	24.00	20.00
DC-HSDPA Subtest-4	Ant.4	24.00	21.00	24.00	24.00	20.00
HSUPA Subtest-1	Ant.4	25.00	22.00	25.00	25.00	21.00
HSUPA Subtest-2	Ant.4	23.00	20.00	23.00	23.00	19.00
HSUPA Subtest-3	Ant.4	24.00	21.00	24.00	24.00	20.00
HSUPA Subtest-4	Ant.4	23.00	20.00	23.00	23.00	19.00
HSUPA Subtest-5	Ant.4	25.00	22.00	25.00	25.00	21.00
WCDMA Band4 AMR	Ant.1	26.50	26.50	23.50	19.50	19.50
WCDMA Band4 RMC	Ant.1	26.50	26.50	23.50	19.50	19.50
HSDPA Subtest-1	Ant.1	25.50	25.50	22.50	18.50	18.50
HSDPA Subtest-2	Ant.1	25.50	25.50	22.50	18.50	18.50
HSDPA Subtest-3	Ant.1	25.00	25.00	22.00	18.00	18.00
HSDPA Subtest-4	Ant.1	25.00	25.00	22.00	18.00	18.00
DC-HSDPA Subtest-1	Ant.1	25.50	25.50	22.50	18.50	18.50
DC-HSDPA Subtest-2	Ant.1	25.50	25.50	22.50	18.50	18.50
DC-HSDPA Subtest-3	Ant.1	25.00	25.00	22.00	18.00	18.00
DC-HSDPA Subtest-4	Ant.1	25.00	25.00	22.00	18.00	18.00
HSUPA Subtest-1	Ant.1	26.00	26.00	23.00	19.00	19.00
HSUPA Subtest-2	Ant.1	24.00	24.00	21.00	17.00	17.00
HSUPA Subtest-3	Ant.1	25.00	25.00	22.00	18.00	18.00
HSUPA Subtest-4	Ant.1	24.00	24.00	21.00	17.00	17.00
HSUPA Subtest-5	Ant.1	26.00	26.00	23.00	19.00	19.00
WCDMA Band5 AMR	Ant.4	26.00	22.00	26.00	26.00	25.00
WCDMA Band5 RMC	Ant.4	26.00	22.00	26.00	26.00	25.00

HSDPA Subtest-1	Ant.4	25.00	21.00	25.00	25.00	24.00
HSDPA Subtest-2	Ant.4	25.00	21.00	25.00	25.00	24.00
HSDPA Subtest-3	Ant.4	24.50	20.50	24.50	24.50	23.50
HSDPA Subtest-4	Ant.4	24.50	20.50	24.50	24.50	23.50
DC-HSDPA Subtest-1	Ant.4	25.00	21.00	25.00	25.00	24.00
DC-HSDPA Subtest-2	Ant.4	25.00	21.00	25.00	25.00	24.00
DC-HSDPA Subtest-3	Ant.4	24.50	20.50	24.50	24.50	23.50
DC-HSDPA Subtest-4	Ant.4	24.50	20.50	24.50	24.50	23.50
HSUPA Subtest-1	Ant.4	25.50	21.50	25.50	25.50	24.50
HSUPA Subtest-2	Ant.4	23.50	19.50	23.50	23.50	22.50
HSUPA Subtest-3	Ant.4	24.50	20.50	24.50	24.50	23.50
HSUPA Subtest-4	Ant.4	23.50	19.50	23.50	23.50	22.50
HSUPA Subtest-5	Ant.4	25.50	21.50	25.50	25.50	24.50
WCDMA Band5 AMR	Ant.1	26.00	26.00	26.00	26.00	26.00
WCDMA Band5 RMC	Ant.1	26.00	26.00	26.00	26.00	26.00
HSDPA Subtest-1	Ant.1	25.00	25.00	25.00	25.00	25.00
HSDPA Subtest-2	Ant.1	25.00	25.00	25.00	25.00	25.00
HSDPA Subtest-3	Ant.1	24.50	24.50	24.50	24.50	24.50
HSDPA Subtest-4	Ant.1	24.50	24.50	24.50	24.50	24.50
DC-HSDPA Subtest-1	Ant.1	25.00	25.00	25.00	25.00	25.00
DC-HSDPA Subtest-2	Ant.1	25.00	25.00	25.00	25.00	25.00
DC-HSDPA Subtest-3	Ant.1	24.50	24.50	24.50	24.50	24.50
DC-HSDPA Subtest-4	Ant.1	24.50	24.50	24.50	24.50	24.50
HSUPA Subtest-1	Ant.1	25.50	25.50	25.50	25.50	25.50
HSUPA Subtest-2	Ant.1	23.50	23.50	23.50	23.50	23.50
HSUPA Subtest-3	Ant.1	24.50	24.50	24.50	24.50	24.50
HSUPA Subtest-4	Ant.1	23.50	23.50	23.50	23.50	23.50
HSUPA Subtest-5	Ant.1	25.50	25.50	25.50	25.50	25.50
LTE Band 2	Ant.4	25.00	18.50	25.00	25.00	19.50
LTE Band 2	Ant.1	25.00	25.00	22.00	19.00	19.00
LTE Band 4	Ant.4	25.50	21.00	25.50	25.50	20.00
LTE Band 4	Ant.1	25.50	25.50	22.50	18.00	18.00
LTE Band 5	Ant.4	25.00	21.00	25.00	25.00	25.00
LTE Band 5	Ant.1	25.00	25.00	25.00	25.00	25.00

LTE Band 7	Ant.4	25.00	18.00	25.00	25.00	18.00
LTE Band 7	Ant.1	25.00	25.00	22.50	20.00	20.00
LTE Band 38	Ant.4	25.50	21.50	25.50	25.50	21.50
LTE Band 38	Ant.1	25.50	25.50	24.50	23.50	23.50
LTE Band 41	Ant.4	25.50	20.50	25.50	25.50	21.50
LTE Band 41	Ant.1	25.50	25.50	24.50	23.50	23.50
N5	Ant.4	25.00	22.00	25.00	25.00	25.00
N5	Ant.1	25.00	25.00	25.00	25.00	25.00
N7	Ant.4	25.00	19.00	25.00	23.00	17.00
N7	Ant.1	25.00	25.00	22.50	21.00	21.00
N38	Ant.4	25.50	16.50	25.50	23.00	17.50
N38	Ant.1	25.50	25.50	24.50	20.00	20.00
N41	Ant.4	25.50	16.50	25.50	23.50	17.50
N41	Ant.1	25.50	25.50	24.50	20.00	20.00
N77	Ant.2	17.00	17.00	17.00	17.00	17.00
N77	Ant.3	21.00	15.00	21.00	21.00	21.00
N77	Ant.5	18.00	13.00	18.00	18.00	18.00
N77	Ant.6	24.00	24.00	20.00	20.00	20.00
N78	Ant.2	16.50	16.50	16.50	16.50	16.50
N78	Ant.3	17.00	15.00	17.00	17.00	17.00
N78	Ant.5	20.00	15.00	20.00	20.00	20.00
N78	Ant.6	24.00	24.00	20.00	20.00	20.00

Mode	Band	Antenna	ENDC Antenna					Band	Antenna	ENDC Antenna				
			Full Power	Head	Body					Full Power	Head	Body		
				Receiver on	Receiver off						Receiver on	Receiver off		
				DSI1	DSI2	DSI3	DSI4				DSI1	DSI2	DSI3	DSI4
DC_2A_n78A	LTE B2	ANT2	25.0	22.0	25.0	25.0	25.0	N78	ANT3	17.0	15.0	17.0	17.0	17.0
DC_41A_n78A	LTE B41	ANT2	25.0	25.0	25.0	25.0	25.0	N78	ANT3	17.0	15.0	17.0	17.0	17.0
DC_5A_n78A	LTE B5	ANT4	25.0	21.0	25.0	25.0	25.0	N78	ANT3	17.0	15.0	17.0	17.0	17.0
DC_7A_n78A	LTE B7	ANT2	24.0	24.0	22.0	22.0	22.0	N78	ANT3	17.0	15.0	17.0	17.0	17.0
DC_7A_n5A	LTE B7	ANT2	24.0	24.0	22.0	22.0	22.0	N5	ANT4	25.0	22.0	25.0	25.0	25.0

**WLAN Reduced power level table**

Reduced level	Position	Receiver	Antenna
DSI1	Head	ON	Ant.7
DSI4	Body&Limbs	OFF	Ant.7

Band	Mode	WLAN Antenna		
		Full Power	Receiver on	Receiver off
			Head	Body&Limbs
			DSI1	DSI4
WLAN 2.4G	802.11b	15.50	15.50	15.50
WLAN 2.4G	802.11g	14.00	14.00	14.00
WLAN 2.4G	802.11n20	14.00	14.00	14.00
WLAN 2.4G	802.11n40	12.00	12.00	12.00
WLAN 5.2G	802.11a	15.00	11.50	15.00
WLAN 5.2G	802.11n20	17.50	14.00	17.50
WLAN 5.2G	802.11n40	16.50	13.00	16.50
WLAN 5.2G	802.11ac20	17.50	14.00	17.50
WLAN 5.2G	802.11ac40	17.50	14.00	17.50
WLAN 5.2G	802.11ac80	15.50	12.00	15.50
WLAN 5.3G	802.11a	15.00	11.50	15.00
WLAN 5.3G	802.11n20	17.50	14.00	17.50
WLAN 5.3G	802.11n40	14.50	11.00	14.50
WLAN 5.3G	802.11ac20	17.50	14.00	17.50
WLAN 5.3G	802.11ac40	15.00	11.50	15.00
WLAN 5.3G	802.11ac80	15.50	12.00	15.50
WLAN 5.6G	802.11a	17.50	14.00	17.50
WLAN 5.6G	802.11n20	17.50	14.00	17.50
WLAN 5.6G	802.11n40	16.50	13.00	16.50
WLAN 5.6G	802.11ac20	17.50	14.00	17.50
WLAN 5.6G	802.11ac40	17.50	14.00	17.50
WLAN 5.6G	802.11ac80	15.50	12.00	15.50
WLAN 5.8G	802.11a	13.50	10.00	13.50

WLAN 5.8G	802.11n20	13.50	10.00	13.50
WLAN 5.8G	802.11n40	13.50	10.00	13.50
WLAN 5.8G	802.11ac20	13.50	10.00	13.50
WLAN 5.8G	802.11ac40	13.50	10.00	13.50
WLAN 5.8G	802.11ac80	13.50	10.00	13.50



## 9 PROXIMITY SENSOR TRIGGERING TEST

### 9.1 Sensor layout

Please refer the document “BL-SZ2290497-AA.pdf”.

### 9.2 Introduction

This device is a mobile phone with WLAN function, it has embedded a proximity sensor to reduce power for the compliance with FCC SAR test. When the body gets close to the sensor pad area, the sensor will be triggered and reduce the TX power.

#### 9.2.1 Product Spec for wireless technology and operation frequency

Wireless Technology	Frequency Range
WLAN 2.4GHz 802.11b/g/n HT20/n HT40 WLAN 5GHz 802.11a/n HT20/HT40 WLAN 5GHz 802.11ac VHT20/VHT40/VHT80	ISM 2400MHz ~ 2483.5MHz WLAN Band1: 2412 MHz ~ 2472 MHz WLAN Band2: 5150 MHz ~ 5250 MHz WLAN Band3: 5250 MHz ~ 5350 MHz WLAN Band4: 5470 MHz ~ 5725 MHz WLAN 5.8GHz Band: 5725 MHz ~ 5825 MHz
Bluetooth v3.0+EDR, Bluetooth v4.0 LE, Bluetooth v4.1 LE, Bluetooth v4.2 LE, Bluetooth v5.0 LE	Bluetooth: 2400 MHz ~ 2483.5 MHz
GSM	GSM850: 824.2 ~ 848.8 MHz GSM900: 880.2 ~ 914.8 MHz DCS1800: 1710.2 ~ 1784.8 MHz PCS1900: 1850.2 ~ 1909.8 MHz
WCDMA	WCDMA Band1:1920 ~ 1980 MHz WCDMA Band2:1850 ~ 1910 MHz WCDMA Band4:1710 ~ 1755 MHz WCDMA Band5:824 ~ 849 MHz WCDMA Band8: 880 ~ 915 MHz
LTE	LTE Band1: 1920 ~ 1980 MHz LTE Band2: 1850 ~ 1910 MHz LTE Band3: 1710 ~ 1785 MHz LTE Band4: 1710 ~ 1755 MHz LTE Band5: 824 ~ 849 MHz LTE Band7: 2500 ~ 2570 MHz LTE Band8: 880 ~ 915 MHz LTE Band20: 832 ~ 862 MHz LTE Band28: 703 ~ 748 MHz LTE Band38: 2570 ~ 2620 MHz LTE Band40: 2300 ~ 2400 MHz LTE Band41: 2496 ~ 2690 MHz

5G NR	N1: 1920 ~ 1980 MHz N3: 1710 ~ 1785 MHz N5: 824 ~ 849 MHz N7: 2500 ~ 2570 MHz N8: 880 ~ 915 MHz N20: 832 ~ 862 MHz N28: 703 ~ 748 MHz N38: 2570 ~ 2620 MHz N40: 2300 ~ 2400 MHz N41: 2496 ~ 2690
-------	---

### 9.3 The Antenna Location

The Detailed Antenna Locations are shown in the enclosure.

There are 7 antennas embedded in the phone. We use Qualcomm's Asdiv technology to switch WWAN cellular and Sub6G antennas. It can transmit from either Top Antenna (UAT) or Bottom Antenna (LAT) or Side antenna, but they can't transmit simultaneously. It has embedded three capacitive proximity sensors for the power reduction of both bottom antenna (LAT) and top antenna (UAT) and Side antenna in order to comply with SAR requirement.

### 9.4 Power reduction for RF exposure consideration

#### 9.4.1 The Methods For scenario detection

The Methods For scenario detection are shown in the following figure.

- a. Audio receiver detection
- b. Capacitive proximity sensor
- c. Hotspot Mode detection
- d. Dynamic antenna switching (for 2G/3G/4G/5G)
- e. Country Code Detection

#### 9.4.2 The detect condition of each scenarios

##### WWAN scenarios:

DSI	Receiver state	WWAN scenarios		
		SAR sensor_1	SAR sensor_2	SAR sensor_3
		ANT1	ANT4	ANT2
DSI1	1	Head		
DSI2	0	Distance>16mm	Distance>16mm	Distance>6mm
DSI3	0	Distance≤16mm (The sensor trigger for the front/Back/Bottom side)	N/A	N/A

DSI4	0	N/A	Distance≤16mm (The sensor trigger for the front/Back/Top side)	Distance≤6mm (The sensor trigger for the front/Back/Left/Top side)
------	---	-----	---	---

Remark:

a. When operating at WWAN Antenna for 4G, it can transmit from either Top Antenna (ANT4) or Bottom Antenna ANT1) (LTE 1/3/7/38/40/41 support 4Tx), but can't transmit simultaneously. There are several power tables of WWAN Antenna. The power tables selected during radiated operation are known as At-Head power table, Body-worn Power table and Hotspot power table.

b. Above table, "0" means function is inactive, "1" means function is active.

**WLAN scenarios:**

DSI	Test Scenarios	Receiver	Remarks
DSI-1	Head SAR	1	
DSI-2	Body SAR	0	

**Notice:** Single/ union mode is not distinguished in all scenes, and max value of single/ union mode is required for fallback.

Remark:

a. When operating at WLAN Antenna, there are several power tables of WLAN Antenna. The power tables selected during radiated operation are known as At-Head for FCC power table, Body-Worn and Handheld for FCC power table, and Hotspot power table.

b. Above table, "0" means function is inactive, "1" means function is active.

**9.4.3 The scenario detection**

**WWAN:**

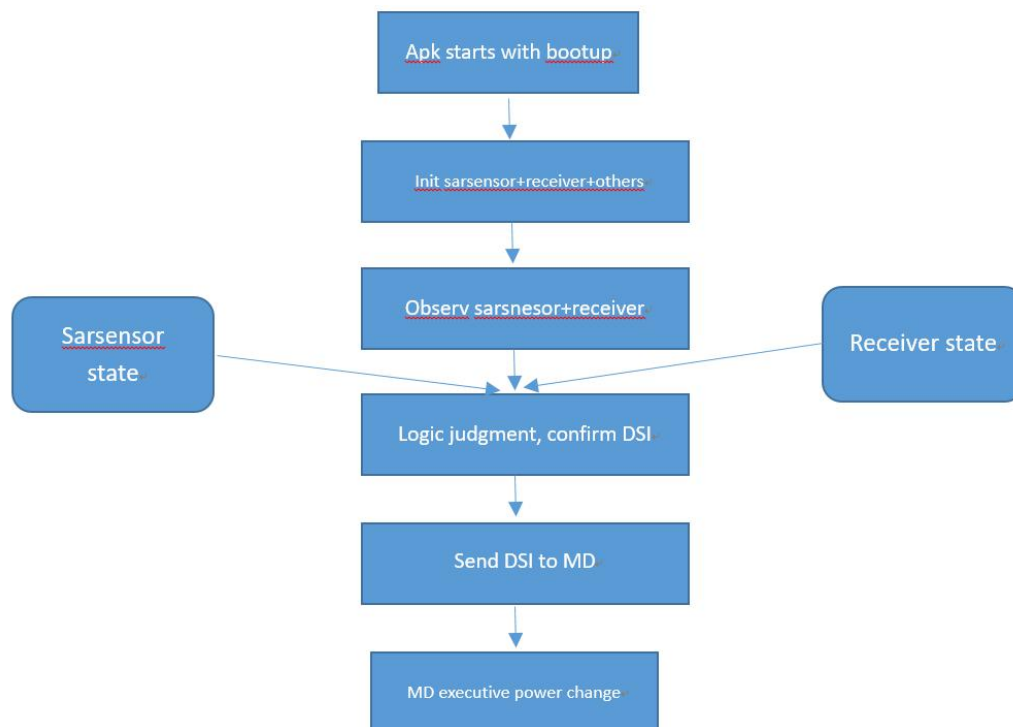

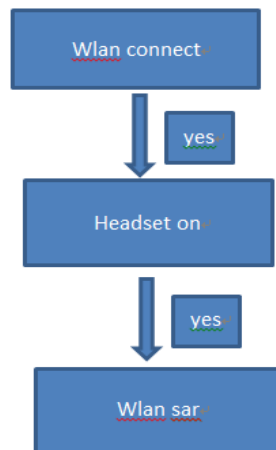
**WLAN:****9.4.4 Sensor pad location**

There are three sensors pad in this device.

**9.5 Proximity Sensor Introduction**

The device uses one sensors chip to reduce the maximum output power in selected wireless mode and operating configurations to ensure SAR compliance. The sensor implementation can identify and facilitate triggering different max power levels for different scenarios including different exposure test positions(Back side/ Top side) when the device is closed to a user's body. The main purpose for the implementation is to distinguish the scenarios of Body and triggered power reduction for body worn state and provide enhanced user experience.

a. When operating in a handheld condition, the WLAN Antenna will be enter to fix Power Level. The purpose of the proximity sensing interface is to detect when a conductive object (usually a body part i.e. finger, palm, face, etc.) is in the proximity of the system. Note that proximity sensing can be done through the air or through a solid (typically plastic) overlay (also called "touch" sensing). The chip's proximity sensing interface is based on capacitive sensing technology. An overview is given the in figure below.

- a. The sensor can be a simple copper area on a PCB or FPC for example. Its capacitance (to ground) will vary when a conductive object is moving in its proximity.
- b. The optional shield can also be a simple copper area on a PCB or FPC below/under/around the sensor. It is used to protect the sensor against potential surrounding noise sources and improve its global performance. It also brings directivity to the sensing, for example sensing objects approaching from top only.
- c. The analog front-end (AFE) performs the raw sensor's capacitance measurement and converts it into a digital value. It also controls the shield.
- d. The digital processing block computes the raw capacitance measurement from the AFE and extracts a binary information PROXSTAT corresponding to the proximity status, i.e. object is "Far"

or “Close”. It also triggers AFE operations (compensation, etc.).

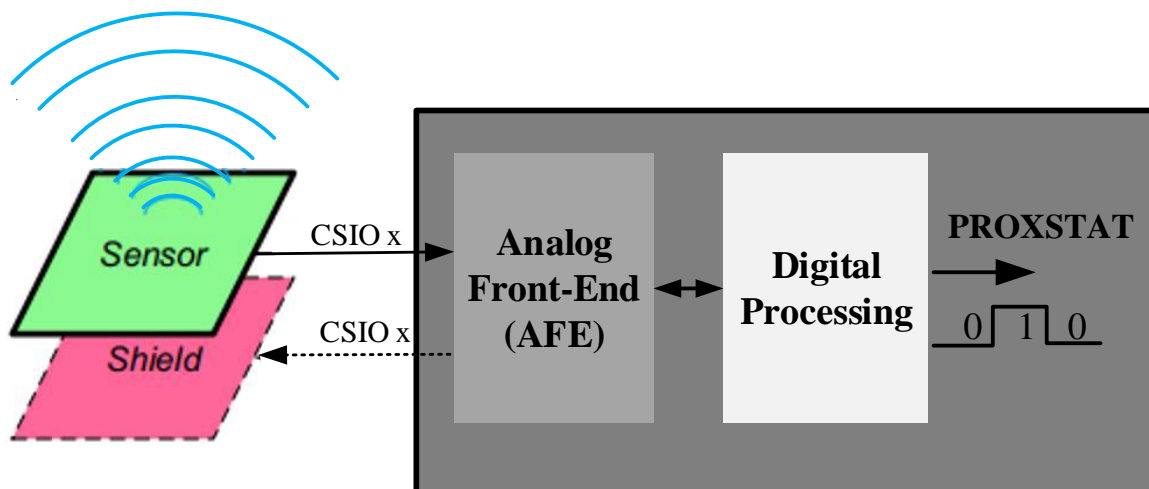

Proximity Sensing Interface Overview

9.5.1 Flowchart:

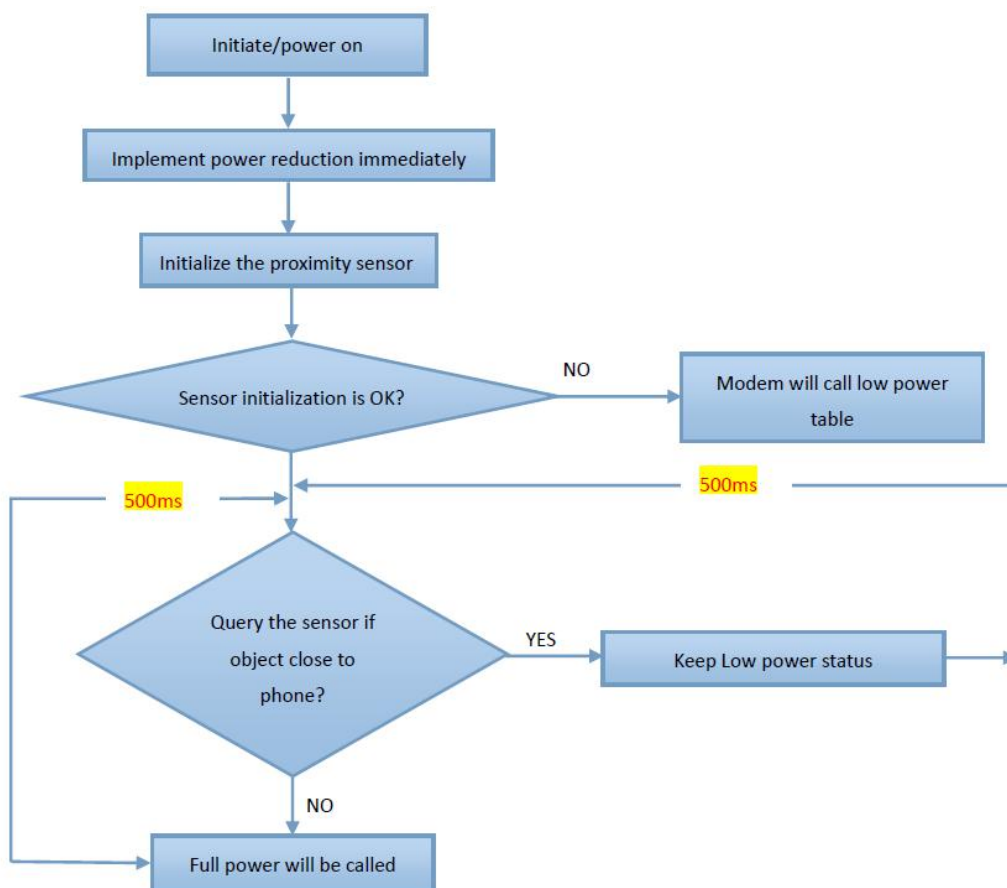

### 9.5.2 Trigger distance of SAR sensor pad

#### ANT1

Position	SAR sensor trigger	Trigger distance
Back	Y	16mm
front	Y	16mm
bottom	Y	16mm
top	Y	/
right	/	/
left	Y	/

#### ANT4

Position	SAR sensor trigger	Trigger distance
Back	Y	16mm
front	Y	16mm
bottom	Y	/
top	Y	16mm
right	/	/
left	Y	/

#### ANT2

Position	SAR sensor trigger	Trigger distance
Back	Y	6mm
front	Y	6mm
bottom	Y	/
top	Y	/
right	/	/
left	Y	6mm

### 9.5.3 SAR sensor failure scenario

If the phone system determines that the SAR sensor is in a failure state, the phone will operate at the minimum power

#### 9.5.1.1 Process:

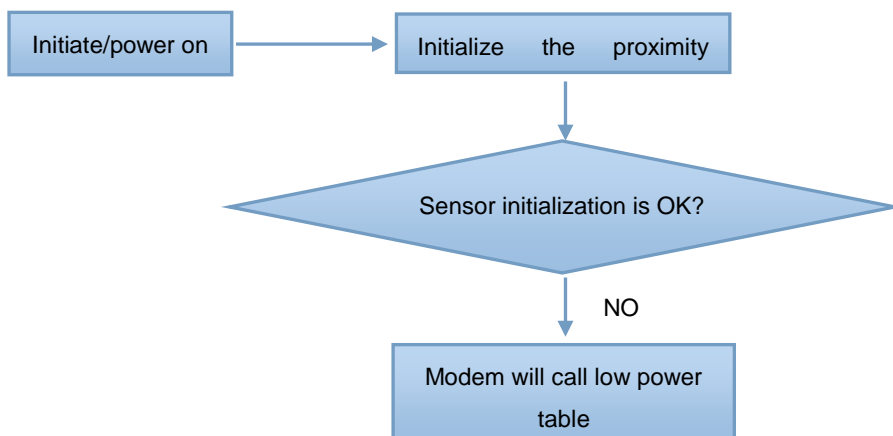

### 9.5.4 Sensor detection capability test

Following procedures to verify this cap sensor detection capability

- a. The Front surface is moved toward the flat phantom in 3 mm steps until the sensor triggers.
- b. The Front surface is then moved back (further away) from the phantom by at least 5 mm until sensor off.
- c. The Front surface is again moved toward the phantom, but in 1 mm steps, until it is at least 5mm past the triggering point or touching the phantom.
- d. If the device is not touching the phantom, it is moved in 3 mm steps until it touches the phantom to confirm that the sensor remains triggered.
- e. The process is then reversed by moving the DUT away from the phantom according to steps a) to d), to determine triggering release.
- f. Steps a) to e) need be repeated at front side, back side, right side, bottom face.

### 9.5.5 proximity sensor 1

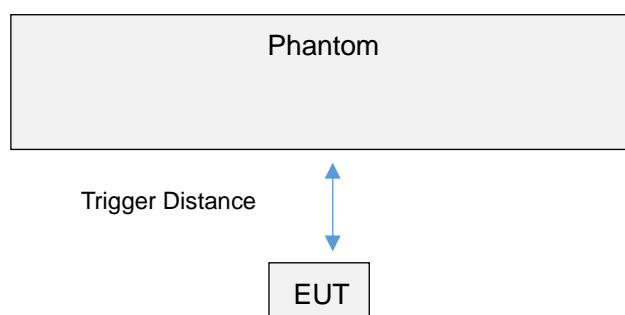

Distance in mm	1~10	11	12	13	14	15	16	17	18	19	20~25
Front Side	On	On	On	On	On	On	On	Off	Off	Off	Off
Back Side	On	On	On	On	On	On	On	Off	Off	Off	Off
Bottom Edge	On	On	On	On	On	On	On	Off	Off	Off	Off

Note: Power reduction is only applicable for Ant.1

### 9.5.6 Procedures for determining EUT tilt angle influences to proximity sensor triggering

The influence of EUT tilt angles to proximity sensor 1 triggering was determined by positioning each EUT edge that contains a transmitting antenna 1, perpendicular to the flat phantom, at 16 mm separation for the front side, 16 mm separation for the back side, 16 mm separation for the bottom edge.

Rotating the tablet around the edge next to the phantom in  $\leq 10^\circ$  increments until the tablet is  $\pm 45^\circ$  from the vertical position at  $0^\circ$ , and the maximum output power remains in the reduced mode.

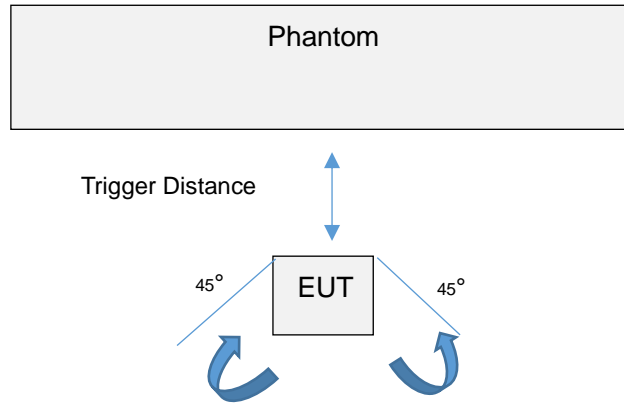

Table: Summary of Phone Tilt Angle Influence to Proximity Sensor Triggering

Antenna	Position	Minimum trigger distance at which power reduction was maintained over $\pm 45^\circ$	Power Reduction Status											
			-45°	-35°	-25°	-15°	-5°	0°	5°	15°	25°	35°	45°	
Ant.1	Bottom Edge	16mm	on	on	on	on	on	on	on	on	on	on	on	on

**For verification of compliance of power reduction scheme, additional SAR test with EUT transmitting at full RF power at a separation of “the triggering distance – 1 mm”**

Ant.1 of proximity sensor 1

EUT Sides	Additional SAR test Distance in mm
Front Side	15
Back Side	15
Bottom Edge	15

9.5.7 Proximity sensor 2

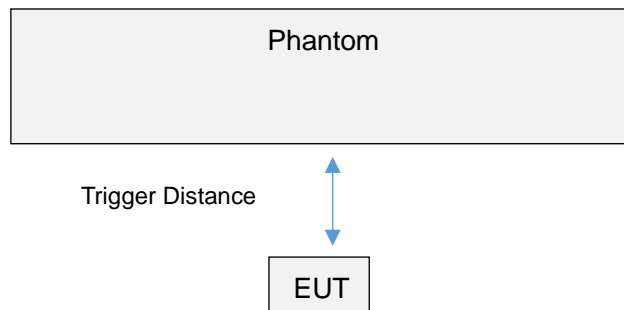

Distance in mm	1~10	11	12	13	14	15	16	17	18	19	20~25
Front Side	On	On	On	On	On	On	On	Off	Off	Off	Off
Back Side	On	On	On	On	On	On	On	Off	Off	Off	Off



Top Edge	On	On	On	On	On	On	On	Off	Off	Off	Off
Note: Power reduction is only applicable for Ant.4											

### 9.5.8 Procedures for determining EUT tilt angle influences to proximity sensor triggering

The influence of EUT tilt angles to proximity sensor 2 triggering was determined by positioning each EUT edge that contains a transmitting antenna 1, perpendicular to the flat phantom, at 16 mm separation for the front side, 16 mm separation for the back side, 16 mm separation for the bottom edge.

Rotating the tablet around the edge next to the phantom in  $\leq 10^\circ$  increments until the tablet is  $\pm 45^\circ$  from the vertical position at  $0^\circ$ , and the maximum output power remains in the reduced mode.

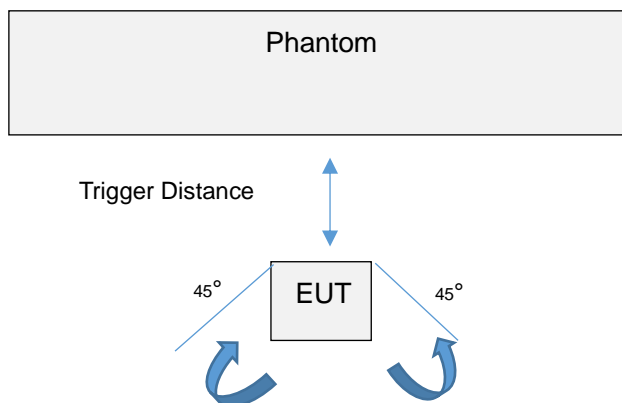

Table: Summary of Phone Tilt Angle Influence to Proximity Sensor Triggering

Antenna	Position	Minimum trigger distance at which power reduction was maintained over $\pm 45^\circ$	Power Reduction Status											
			-45°	-35°	-25°	-15°	-5°	0°	5°	15°	25°	35°	45°	
Ant.4	Top Edge	16mm	on	on	on	on	on	on	on	on	on	on	on	on

**For verification of compliance of power reduction scheme, additional SAR test with EUT transmitting at full RF power at a separation of “the triggering distance – 1 mm”**

Ant.4 of proximity sensor 2

EUT Sides	Additional SAR test Distance in mm
Front Side	15
Back Side	15
Bottom Edge	15

### 9.5.9 Proximity sensor 3

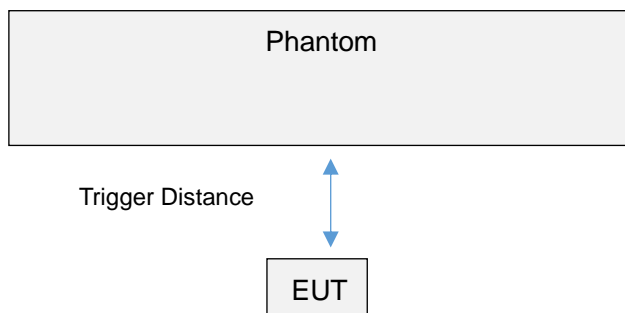

Distance in mm	1	2	3	4	5	6	7	8	9	10	11
Front Side	On	On	On	On	On	On	Off	Off	Off	Off	Off
Back Side	On	On	On	On	On	On	Off	Off	Off	Off	Off
Right Edge	On	On	On	On	On	On	Off	Off	Off	Off	Off

Note: Power reduction is only applicable for Ant.2

### 9.5.10 Procedures for determining EUT tilt angle influences to proximity sensor triggering

The influence of EUT tilt angles to proximity sensor 3 triggering was determined by positioning each EUT edge that contains a transmitting antenna 1, perpendicular to the flat phantom, at 16 mm separation for the front side, 16 mm separation for the back side, 16 mm separation for the bottom edge. Rotating the tablet around the edge next to the phantom in  $\leq 10^\circ$  increments until the tablet is  $\pm 45^\circ$  from the vertical position at  $0^\circ$ , and the maximum output power remains in the reduced mode.

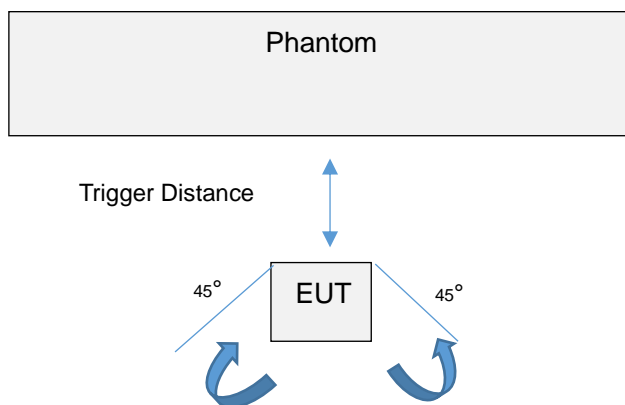

Table: Summary of Phone Tilt Angle Influence to Proximity Sensor Triggering

Antenna	Position	Minimum trigger distance at which power reduction was maintained over $\pm 45^\circ$	Power Reduction Status											
			-45°	-35°	-25°	-15°	-5°	0°	5°	15°	25°	35°	45°	
Ant.2	Right Edge	6mm	on	on	on	on	on	on	on	on	on	on	on	

**For verification of compliance of power reduction scheme, additional SAR test with EUT transmitting at full RF power at a separation of “the triggering distance – 1 mm”**

Ant.1 of proximity sensor 1

EUT Sides	Additional SAR test Distance in mm
Front Side	5
Back Side	5
Bottom Edge	5

### 9.5.11 Hotspot Mode detection

The device supports the Hotspot Mode detection mechanism. The Hotspot Mode is used to determine Hotspot scenario. The relevant power levels are set for WWAN and Wi-Fi antennas accordingly.

### 9.5.12 Dynamic antenna switching specification (for 2G/3G/4G/5G)

We use MTK's Asdiv technology to switch between the primary receiver antenna (Bottom Antenna) and the diversity receiver antenna (Top Antenna). Antenna switching diversity (ASDiv) switches antennas according to the DL/UL signal strength in the field. ASDiv helps the phone pick up better signal strength for receiving and transmitting.

Hardware structure is as follows.

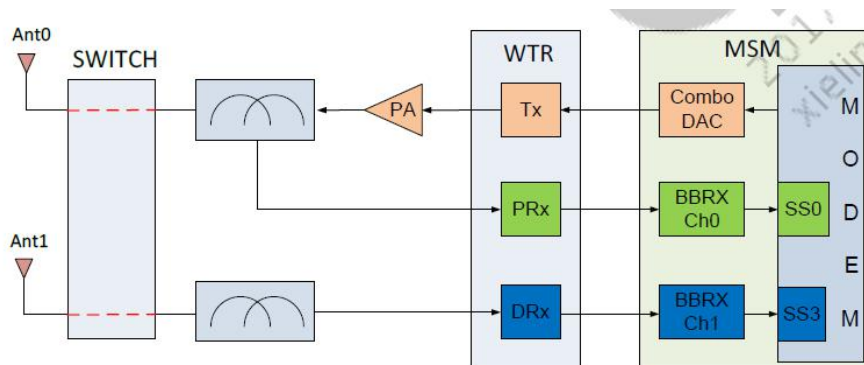

Hardware structure with Asdiv switch

### 9.5.13 Country Code Detection Mechanism

This device uses the mobile country code (MCC) to indicate whether the users in CE countries or FCC countries. The selection between CE countries and FCC countries power levels is based on the country code detection mechanism. It can determine the countries where users are and set the relevant power level.

## 10 TEST EXCLUSION CONSIDERATION

Please refer the document “BL-SZ2290497-AA.pdf”.

# 11 TEST RESULT

## 11.1 GSM 850

Antenna	DSI State	Mode	Position	Dist. (mm)	Ch.	Freq. (MHz)	Power Drift (dB)	1 g Meas SAR (W/kg)	Meas. Power (dBm)	Max. tune-up power (dBm)	Scaling Factor	1g Report SAR (W/kg)	Meas. No.
<b>Head</b>													
ANT4	DSI1	GPRS	Left Cheek	0	190	836.6	-0.07	0.371	27.92	28.50	1.143	0.424	/
	DSI1		Left Tilt	0	190	836.6	-0.17	0.322	27.92	28.50	1.143	0.368	/
	DSI1	2slots	Right Cheek	0	190	836.6	0.17	0.454	27.92	28.50	1.143	0.519	/
	DSI1		Right Tilt	0	190	836.6	0.13	0.490	27.92	28.50	1.143	<b>0.560</b>	1#
ANT1	DSI1	GPRS	Left Cheek	0	190	836.6	-0.14	0.129	30.57	31.50	1.239	0.160	/
	DSI1		Left Tilt	0	190	836.6	0.03	0.070	30.57	31.50	1.239	0.087	/
	DSI1	2slots	Right Cheek	0	190	836.6	0.15	0.130	30.57	31.50	1.239	0.161	/
	DSI1		Right Tilt	0	190	836.6	0.00	0.072	30.57	31.50	1.239	0.089	/
<b>Body-worn&amp;Hotspot</b>													
ANT4	DSI4	GPRS	Front Side	10	190	836.6	-0.09	0.115	28.24	29.50	1.337	0.154	/
	DSI4		Back Side	10	190	836.6	0.15	0.152	28.24	29.50	1.337	0.203	/
	DSI4	2slots	Left Edge	10	190	836.6	-0.05	0.097	28.24	29.50	1.337	0.130	/
	DSI4		Top Edge	10	190	836.6	-0.05	0.113	28.24	29.50	1.337	0.151	/
ANT1	DSI3	GPRS	Front Side	10	190	836.6	-0.09	0.126	30.57	31.50	1.239	0.156	/
	DSI3		Back Side	10	190	836.6	-0.14	0.192	30.57	31.50	1.239	<b>0.238</b>	2#
	DSI3	2slots	Left Edge	10	190	836.6	-0.04	0.105	30.57	31.50	1.239	0.130	/
	DSI3		Right Edge	10	190	836.6	0.01	0.094	30.57	31.50	1.239	0.116	/
	DSI3		Bottom Edge	10	190	836.6	-0.17	0.137	30.57	31.50	1.239	0.170	/
Note: Refer to ANNEX C for the detailed test data for each test configuration.													

Antenna	DSI State	Mode	Position	Dist. (mm)	Ch.	Freq. (MHz)	Power Drift (dB)	1 g Meas SAR (W/kg)	Meas. Power (dBm)	Max. tune-up power (dBm)	Scaling Factor	1g Report SAR (W/kg)	Meas. No.
<b>Body N-1</b>													
ANT4	DSI2	GPRS	Front Side	15	251	848.8	0.10	0.060	30.19	31.50	1.352	0.081	/
	DSI2		Back Side	15	251	848.8	-0.12	0.091	30.19	31.50	1.352	0.123	/
	DSI2	2slots	Top Edge	15	251	848.8	0.16	0.064	30.19	31.50	1.352	0.087	/
ANT1	DSI2	GPRS	Front Side	15	128	824.2	-0.18	0.102	30.60	31.50	1.230	0.125	/
	DSI2		Back Side	15	128	824.2	0.13	0.128	30.60	31.50	1.230	0.157	/
	DSI2	2slots	Bottom Edge	15	128	824.2	0.15	0.055	30.60	31.50	1.230	0.068	/
Note: Refer to ANNEX C for the detailed test data for each test configuration.													

### 11.2GSM 1900

Antenna	DSI State	Mode	Position	Dist. (mm)	Ch.	Freq. (MHz)	Power Drift (dB)	1 g Meas SAR (W/kg)	Meas. Power (dBm)	Max. tune-up power (dBm)	Scaling Factor	1g Report SAR (W/kg)	Meas. No.	
<b>Head</b>														
ANT4	DSI1	GPRS	Left Cheek	0	661	1880.0	0.12	0.183	20.19	22.00	1.517	0.278	/	
	DSI1		Left Tilt	0	661	1880.0	-0.15	0.148	20.19	22.00	1.517	0.225	/	
	DSI1	2slots	Right Cheek	0	661	1880.0	-0.02	0.306	20.19	22.00	1.517	<b>0.464</b>	3#	
	DSI1		Right Tilt	0	661	1880.0	0.19	0.221	20.19	22.00	1.517	0.335	/	
ANT1	DSI1	GPRS	Left Cheek	0	661	1880.0	-0.08	0.032	26.91	28.50	1.442	0.046	/	
	DSI1		Left Tilt	0	661	1880.0	0.10	0.018	26.91	28.50	1.442	0.026	/	
	DSI1	2slots	Right Cheek	0	661	1880.0	-0.11	0.027	26.91	28.50	1.442	0.039	/	
	DSI1		Right Tilt	0	661	1880.0	-0.04	0.016	26.91	28.50	1.442	0.023	/	
<b>Body</b>														
ANT4	DSI4	GPRS	Front Side	10	661	1880.0	0.07	0.045	22.05	24.00	1.567	0.071	/	
	DSI4		Back Side	10	661	1880.0	0.08	0.077	22.05	24.00	1.567	0.121	/	
	DSI4	2slots	Left Edge	10	661	1880.0	-0.05	0.063	26.61	28.50	1.545	0.097	/	
	DSI4		Top Edge	10	661	1880.0	0.02	0.055	22.05	24.00	1.567	0.086	/	
ANT1	DSI3	GPRS	Front Side	10	661	1880.0	-0.15	0.136	23.84	24.00	1.038	0.141	/	
	DSI3		Back Side	10	661	1880.0	0.13	0.296	23.84	24.00	1.038	0.307	/	
	DSI3		2slots	Left Edge	10	661	1880.0	0.01	0.048	23.84	24.00	1.038	0.050	/
	DSI3			Right Edge	10	661	1880.0	0.19	0.059	23.84	24.00	1.038	0.061	/
	DSI3			Bottom Edge	10	661	1880.0	0.19	0.410	23.84	24.00	1.038	<b>0.426</b>	4#

Note: Refer to ANNEX C for the detailed test data for each test configuration.

Antenna	DSI State	Mode	Position	Dist. (mm)	Ch.	Freq. (MHz)	Power Drift (dB)	10 g Meas SAR (W/kg)	Meas. Power (dBm)	Max. tune-up power (dBm)	Scaling Factor	10g Report SAR (W/kg)	Meas. No.
<b>Specific</b>													
ANT1	DSI3	GPRS 2slots	Bottom Edge	0	661	1880.0	-0.15	0.650	23.84	24.00	1.038	<b>0.675</b>	5#

Note: Refer to ANNEX C for the detailed test data for each test configuration.

Antenna	DSI State	Mode	Position	Dist. (mm)	Ch.	Freq. (MHz)	Power Drift (dB)	1 g Meas SAR (W/kg)	Meas. Power (dBm)	Max. tune-up power (dBm)	Scaling Factor	1g Report SAR (W/kg)	Meas. No.
<b>Body N-1</b>													
ANT4	DSI2	GPRS 2slots	Front Side	15	661	1880.0	0.05	0.107	26.61	28.50	1.545	0.165	/
	DSI2		Back Side	15	661	1880.0	-0.07	0.197	26.61	28.50	1.545	0.304	/
	DSI2		Top Edge	15	661	1880.0	0.14	0.166	26.61	28.50	1.545	0.256	/
ANT1	DSI2	GPRS 2slots	Front Side	15	512	1850.5	0.06	0.155	27.27	28.50	1.327	0.206	/
	DSI2		Back Side	15	512	1850.5	-0.12	0.330	27.27	28.50	1.327	0.438	/
	DSI2		Bottom Edge	15	512	1850.5	-0.01	0.516	27.27	28.50	1.327	0.685	/
Note: Refer to ANNEX C for the detailed test data for each test configuration.													

### 11.3WCDMA Band 2

Antenna	DSI State	Mode	Position	Dist. (mm)	Ch.	Freq. (MHz)	Power Drift (dB)	1 g Meas SAR (W/kg)	Meas. Power (dBm)	Max. tune-up power (dBm)	Scaling Factor	1g Report SAR (W/kg)	Meas. No.
<b>Head</b>													
ANT4	DSI1	RMC	Left Cheek	0	9400	1880.0	-0.08	0.110	16.66	18.00	1.361	0.150	/
	DSI1		Left Tilt	0	9400	1880.0	-0.13	0.106	16.66	18.00	1.361	0.144	/
	DSI1		Right Cheek	0	9400	1880.0	0.07	0.184	16.66	18.00	1.361	<b>0.250</b>	6#
	DSI1		Right Tilt	0	9400	1880.0	0.04	0.152	16.66	18.00	1.361	0.207	/
ANT1	DSI1	RMC	Left Cheek	0	9262	1852.4	0.02	0.047	24.36	25.00	1.159	0.054	/
	DSI1		Left Tilt	0	9262	1852.4	0.15	0.037	24.36	25.00	1.159	0.043	/
	DSI1		Right Cheek	0	9262	1852.4	0.05	0.025	24.36	25.00	1.159	0.029	/
	DSI1		Right Tilt	0	9262	1852.4	0.14	0.016	24.36	25.00	1.159	0.019	/
<b>Body-worn&amp;Hotspot</b>													
ANT4	DSI4	RMC	Front Side	10	9400	1880.0	-0.14	0.125	18.61	20.00	1.377	0.172	/
	DSI4		Back Side	10	9400	1880.0	0.09	0.196	18.61	20.00	1.377	0.270	/
	DSI4		Left Edge	10	9400	1880.0	0.15	0.201	18.61	20.00	1.377	0.277	/
	DSI4		Top Edge	10	9400	1880.0	0.14	0.166	18.61	20.00	1.377	0.229	/
ANT1	DSI3	RMC	Front Side	10	9262	1852.4	0.05	0.129	18.00	18.50	1.122	0.145	/
	DSI3		Back Side	10	9262	1852.4	-0.12	0.339	18.00	18.50	1.122	0.380	/
	DSI3		Left Edge	10	9262	1852.4	-0.19	0.056	18.00	18.50	1.122	0.063	/
	DSI3		Right Edge	10	9262	1852.4	0.12	0.049	18.00	18.50	1.122	0.055	/
	DSI3		Bottom Edge	10	9262	1852.4	0.06	0.552	18.00	18.50	1.122	<b>0.619</b>	7#

Note: Refer to ANNEX C for the detailed test data for each test configuration.

<b>Specific</b>													
Antenna	DSI State	Mode	Position	Dist. (mm)	Ch.	Freq. (MHz)	Power Drift (dB)	10 g Meas SAR (W/kg)	Meas. Power (dBm)	Max. tune-up power (dBm)	Scaling Factor	10g Report SAR (W/kg)	Meas. No.
ANT1	DSI3	RMC	Bottom Edge	0	9262	1852.4	0.16	1.040	18.10	19.00	1.230	<b>1.279</b>	8#

Note: Refer to ANNEX C for the detailed test data for each test configuration.



Antenna	DSI State	Mode	Position	Dist. (mm)	Ch.	Freq. (MHz)	Power Drift (dB)	1 g Meas SAR (W/kg)	Meas. Power (dBm)	Max. tune-up power (dBm)	Scaling Factor	1g Report SAR (W/kg)	Meas. No.
<b>Body N-1</b>													
ANT4	DSI2	RMC	Front Side	15	9400	1880.0	0.04	0.038	23.97	25.00	1.268	0.048	/
	DSI2		Back Side	15	9400	1880.0	0.05	0.137	23.97	25.00	1.268	0.174	/
	DSI2		Top Edge	15	9400	1880.0	0.03	0.129	23.97	25.00	1.268	0.164	/
ANT1	DSI2	RMC	Front Side	15	9400	1880.0	-0.01	0.159	20.50	21.50	1.259	0.200	/
	DSI2		Back Side	15	9400	1880.0	0.05	0.344	20.50	21.50	1.259	0.433	/
	DSI2		Bottom Edge	15	9400	1880.0	-0.14	0.547	20.50	21.50	1.259	0.689	/
Note: Refer to ANNEX C for the detailed test data for each test configuration.													

### 11.4WCDMA Band 4

Antenna	DSI State	Mode	Position	Dist. (mm)	Ch.	Freq. (MHz)	Power Drift (dB)	1 g Meas SAR (W/kg)	Meas. Power (dBm)	Max. tune-up power (dBm)	Scaling Factor	1g Report SAR (W/kg)	Meas. No.
<b>Head</b>													
ANT4	DSI1	RMC	Left Cheek	0	1412	1732.4	0.17	0.128	19.76	21.50	1.493	0.191	/
	DSI1		Left Tilt	0	1412	1732.4	-0.12	0.097	19.76	21.50	1.493	0.145	/
	DSI1		Right Cheek	0	1412	1732.4	-0.01	0.207	19.76	21.50	1.493	<b>0.309</b>	9#
	DSI1		Right Tilt	0	1412	1732.4	0.17	0.141	19.76	21.50	1.493	0.211	/
ANT1	DSI1	RMC	Left Cheek	0	1412	1732.4	0.01	0.017	25.01	25.50	1.119	0.019	/
	DSI1		Left Tilt	0	1412	1732.4	0.01	0.011	25.01	25.50	1.119	0.012	/
	DSI1		Right Cheek	0	1412	1732.4	-0.08	0.015	25.01	25.50	1.119	0.017	/
	DSI1		Right Tilt	0	1412	1732.4	0.03	0.009	25.01	25.50	1.119	0.010	/
<b>Body-worn&amp;Hotspot</b>													
ANT4	DSI4	RMC	Front Side	10	1412	1732.4	0.17	0.096	18.69	20.50	1.517	0.146	/
	DSI4		Back Side	10	1412	1732.4	0.02	0.136	18.69	20.50	1.517	0.206	/
	DSI2		Left Edge	10	1412	1732.4	0.12	0.047	18.69	20.50	1.517	0.071	/
	DSI4		Top Edge	10	1412	1732.4	0.19	0.114	18.69	20.50	1.517	0.173	/
ANT1	DSI3	RMC	Front Side	10	1412	1732.4	-0.09	0.197	17.47	18.50	1.268	0.250	/
	DSI3		Back Side	10	1412	1732.4	-0.07	0.455	17.47	18.50	1.268	0.577	/
	DSI3		Left Edge	10	1412	1732.4	0.15	0.048	17.47	18.50	1.268	0.061	/
	DSI3		Right Edge	10	1412	1732.4	0.05	0.042	17.47	18.50	1.268	0.053	/
	DSI3		Bottom Edge	10	1412	1732.4	-0.04	0.611	17.47	18.50	1.268	<b>0.775</b>	10#
Note: Refer to ANNEX C for the detailed test data for each test configuration.													

Antenna	DSI State	Mode	Position	Dist. (mm)	Ch.	Freq. (MHz)	Power Drift (dB)	10 g Meas SAR (W/kg)	Meas. Power (dBm)	Max. tune-up power (dBm)	Scaling Factor	10g Report SAR (W/kg)	Meas. No.
<b>Specific</b>													
ANT1	DSI3	RMC	Bottom Edge	0	1412	1732.4	0.11	0.849	17.47	18.50	1.268	<b>1.077</b>	11#
Note: Refer to ANNEX C for the detailed test data for each test configuration.													

Antenna	DSI State	Mode	Position	Dist. (mm)	Ch.	Freq. (MHz)	Power Drift (dB)	1 g Meas SAR (W/kg)	Meas. Power (dBm)	Max. tune-up power (dBm)	Scaling Factor	1g Report SAR (W/kg)	Meas. No.
<b>Body N-1</b>													
ANT4	DSI2	RMC	Front Side	15	1513	1752.6	-0.11	0.090	22.78	24.50	1.486	0.134	/
	DSI2		Back Side	15	1513	1752.6	-0.05	0.116	22.78	24.50	1.486	0.172	/
	DSI2		Top Edge	15	1513	1752.6	-0.05	0.087	22.78	24.50	1.486	0.129	/
ANT1	DSI2	RMC	Front Side	15	1412	1732.4	0.09	0.292	21.65	22.50	1.216	0.355	/
	DSI2		Back Side	15	1412	1732.4	0.15	0.598	21.65	22.50	1.216	0.727	/
	DSI2		Bottom Edge	15	1412	1732.4	-0.01	0.889	21.65	22.50	1.216	1.081	/
Note: Refer to ANNEX C for the detailed test data for each test configuration.													

### 11.5WCDMA Band 5

Antenna	DSI State	Mode	Position	Dist. (mm)	Ch.	Freq. (MHz)	Power Drift (dB)	1 g Meas SAR (W/kg)	Meas. Power (dBm)	Max. tune-up power (dBm)	Scaling Factor	1g Report SAR (W/kg)	Meas. No.
<b>Head</b>													
ANT4	DSI1	RMC	Left Cheek	0	4182	836.4	-0.16	0.108	19.56	21.00	1.393	0.150	/
	DSI1		Left Tilt	0	4182	836.4	0.14	0.088	19.56	21.00	1.393	0.123	/
	DSI1		Right Cheek	0	4182	836.4	0.14	0.126	19.56	21.00	1.393	<b>0.176</b>	12#
	DSI1		Right Tilt	0	4182	836.4	-0.07	0.103	19.56	21.00	1.393	0.143	/
ANT1	DSI1	RMC	Left Cheek	0	4182	836.4	-0.19	0.072	24.12	25.00	1.225	0.088	/
	DSI1		Left Tilt	0	4182	836.4	-0.11	0.041	24.12	25.00	1.225	0.050	/
	DSI1		Right Cheek	0	4182	836.4	0.14	0.065	24.12	25.00	1.225	0.080	/
	DSI1		Right Tilt	0	4182	836.4	-0.11	0.033	24.12	25.00	1.225	0.040	/
<b>Body</b>													
ANT4	DSI4	RMC	Front Side	10	4182	836.4	0.13	0.051	22.61	24.00	1.377	0.070	/
	DSI4		Back Side	10	4182	836.4	-0.13	0.077	22.61	24.00	1.377	0.106	/
	DSI4		Left Edge	10	4182	836.4	0.11	0.067	22.61	24.00	1.377	0.092	/
	DSI4		Top Edge	10	4182	836.4	0.04	0.144	22.61	24.00	1.377	0.198	/
ANT1	DSI3	RMC	Front Side	10	4182	836.4	-0.06	0.136	24.12	25.00	1.225	0.167	/
	DSI3		Back Side	10	4182	836.4	-0.11	0.219	24.12	25.00	1.225	<b>0.268</b>	13#
	DSI2		Left Edge	10	4182	836.4	0.06	0.124	24.12	25.00	1.225	0.152	/
	DSI2		Right Edge	10	4182	836.4	-0.16	0.089	24.12	25.00	1.225	0.109	/
	DSI3		Bottom Edge	10	4182	836.4	0.03	0.140	24.12	25.00	1.225	0.172	/
Note: Refer to ANNEX C for the detailed test data for each test configuration.													

Antenna	DSI State	Mode	Position	Dist. (mm)	Ch.	Freq. (MHz)	Power Drift (dB)	1 g Meas SAR (W/kg)	Meas. Power (dBm)	Max. tune-up power (dBm)	Scaling Factor	1g Report SAR (W/kg)	Meas. No.
<b>Body N-1</b>													
ANT4	DSI2	RMC	Front Side	15	4182	836.4	-0.03	0.033	23.87	25.00	1.297	0.043	/
	DSI2		Back Side	15	4182	836.4	-0.08	0.050	23.87	25.00	1.297	0.065	/
	DSI2		Top Edge	15	4182	836.4	0.05	0.074	23.87	25.00	1.297	0.096	/
ANT1	DSI2	RMC	Front Side	15	4182	836.4	-0.01	0.127	24.12	25.00	1.225	0.156	/
	DSI2		Back Side	15	4182	836.4	0.15	0.176	24.12	25.00	1.225	0.216	/
	DSI2		Bottom Edge	15	4182	836.4	-0.16	0.063	24.12	25.00	1.225	0.077	/
Note: Refer to ANNEX C for the detailed test data for each test configuration.													

### 11.6LTE Band 2 (20MHz Bandwidth)

Antenna	DSI State	Mode	Position	Dist. (mm)	Ch.	Freq. (MHz)	RB Num.	RB Start	Power Drift (dB)	1 g Meas SAR (W/kg)	Meas. Power (dBm)	Max. tune power (dBm)	Scaling Factor	1g Report SAR (W/kg)	Meas. No.
<b>Head</b>															
ANT4	DSI1	QPSK	Left Cheek	0	18700	1860	1	MID	-0.1	0.247	17.28	18.50	1.324	0.327	/
	DSI1			0	19100	1900	50	LOW	0.12	0.252	17.29	18.50	1.321	0.333	/
	DSI1		Left Tilt	0	18700	1860	1	MID	0.07	0.206	17.28	18.50	1.324	0.273	/
	DSI1			0	19100	1900	50	LOW	-0.03	0.217	17.29	18.50	1.321	0.287	/
	DSI1		Right Cheek	0	18700	1860	1	MID	-0.04	0.382	17.28	18.50	1.324	0.506	/
	DSI1			0	19100	1900	50	LOW	-0.17	0.401	17.29	18.50	1.321	0.530	/
	DSI1		Right Tilt	0	18700	1860	1	MID	0.15	0.305	17.28	18.50	1.324	0.404	/
	DSI1			0	19100	1900	50	LOW	0.13	0.323	17.29	18.50	1.321	0.427	/
ANT1	DSI1	QPSK	Left Cheek	0	18700	1860	1	MID	0.13	0.072	23.89	25.00	1.291	0.093	/
	DSI1			0	18700	1860	50	HIGH	-0.18	0.071	22.87	24.00	1.297	0.092	/
	DSI1		Left Tilt	0	18700	1860	1	MID	0.19	0.031	23.89	25.00	1.291	0.040	/
	DSI1			0	18700	1860	50	HIGH	0.04	0.029	22.87	24.00	1.297	0.038	/
	DSI1		Right Cheek	0	18700	1860	1	MID	-0.01	0.046	23.89	25.00	1.291	0.059	/
	DSI1			0	18700	1860	50	HIGH	-0.01	0.043	22.87	24.00	1.297	0.056	/
	DSI1		Right Tilt	0	18700	1860	1	MID	0.15	0.026	23.89	25.00	1.291	0.034	/
	DSI1			0	18700	1860	50	HIGH	0.03	0.023	22.87	24.00	1.297	0.030	/
ANT2	DSI1	QPSK	Left Cheek	0	18700	1860	1	MID	0.08	0.239	20.60	22.00	1.380	0.330	/
	DSI1			0	18700	1860	50	MID	-0.01	0.210	20.53	22.00	1.403	0.295	/
	DSI1		Left Tilt	0	18700	1860	1	MID	0.1	0.159	20.60	22.00	1.380	0.219	/
	DSI1			0	18700	1860	50	MID	0.05	0.145	20.53	22.00	1.403	0.203	/
	DSI1		Right Cheek	0	18700	1860	1	MID	-0.16	0.412	20.60	22.00	1.380	<b>0.569</b>	14#
	DSI1			0	18700	1860	50	MID	0.09	0.392	20.53	22.00	1.403	0.550	/
	DSI1		Right Tilt	0	18700	1860	1	MID	0.02	0.177	20.60	22.00	1.380	0.244	/
	DSI1			0	18700	1860	50	MID	-0.02	0.171	20.53	22.00	1.403	0.240	/
<b>Body-worn&amp;Hotspot</b>															
ANT4	DSI4	QPSK	Front Side	10	18700	1860	1	MID	-0.02	0.103	17.84	19.50	1.466	0.151	/
	DSI4			10	18700	1860	50	MID	-0.03	0.108	17.82	19.50	1.472	0.159	/
	DSI4		Back Side	10	18700	1860	1	MID	-0.18	0.221	17.84	19.50	1.466	0.324	/
	DSI4			10	18700	1860	50	MID	-0.07	0.231	17.82	19.50	1.472	0.340	/
	DSI4		Left Edge	10	18700	1860	1	MID	0.06	0.197	17.84	19.50	1.466	0.289	/
	DSI4			10	18700	1860	50	MID	0.03	0.183	17.82	19.50	1.472	0.269	/
	DSI4		Top Edge	10	18700	1860	1	MID	0.18	0.186	17.84	19.50	1.466	0.273	/
	DSI4			10	18700	1860	50	MID	-0.08	0.193	17.82	19.50	1.472	0.284	/
ANT1	DSI3	QPSK	Front Side	10	18700	1860	1	MID	0.07	0.170	18.26	19.00	1.186	0.202	/
	DSI3			10	19100	1900	50	MID	-0.04	0.241	18.26	19.00	1.186	0.286	/
	DSI3		Back Side	10	18700	1860	1	MID	-0.19	0.490	18.26	19.00	1.186	0.581	/
	DSI3			10	19100	1900	50	MID	-0.09	0.512	18.26	19.00	1.186	0.607	/

	DSI3		Left Edge	10	18700	1860	1	MID	0.15	0.039	18.26	19.00	1.186	0.046	/
	DSI3			10	19100	1900	50	MID	-0.05	0.042	18.26	19.00	1.186	0.050	/
	DSI3		Right Edge	10	18700	1860	1	MID	-0.08	0.125	18.26	19.00	1.186	0.148	/
	DSI3			10	19100	1900	50	MID	-0.15	0.133	18.26	19.00	1.186	0.158	/
	DSI3		Bottom Edge	10	18700	1860	1	MID	-0.15	0.532	18.26	19.00	1.186	<b>0.631</b>	15#
	DSI3			10	19100	1900	50	MID	-0.04	0.530	18.26	19.00	1.186	0.629	/
ANT2	DSI4	QPSK	Front Side	10	18700	1860	1	MID	-0.13	0.226	23.48	25.00	1.419	0.321	/
	DSI4			10	18700	1860	50	MID	0.11	0.198	23.48	25.00	1.419	0.281	/
	DSI4		Back Side	10	18700	1860	1	MID	-0.13	0.286	23.48	25.00	1.419	0.406	/
	DSI4			10	18700	1860	50	MID	-0.05	0.269	23.48	25.00	1.419	0.382	/
	DSI4		Left Edge	10	18700	1860	1	MID	0.02	0.233	23.48	25.00	1.419	0.331	/
	DSI4			10	18700	1860	50	MID	0.19	0.228	23.48	25.00	1.419	0.324	/
	DSI4		Top Edge	10	18700	1860	1	MID	-0.19	0.144	23.48	25.00	1.419	0.204	/
	DSI4			10	18700	1860	50	MID	-0.07	0.124	23.48	25.00	1.419	0.176	/

Note: Refer to ANNEX C for the detailed test data for each test configuration.

Antenna	DSI State	Mode	Position	Dist. (mm)	Ch.	Freq. (MHz)	RB Num.	RB Start	Power Drift (dB)	10g Meas SAR (W/kg)	Meas. Power (dBm)	Max. tune power (dBm)	Scaling Factor	10g Report SAR (W/kg)	Meas. No.
<b>Specific</b>															
ANT1	DSI3	QPSK	Bottom Edge	0	18700	1860	1	MID	-0.08	0.997	18.26	19.00	1.186	<b>1.182</b>	16#

Note: Refer to ANNEX C for the detailed test data for each test configuration.

Antenna	DSI State	Mode	Position	Dist. (mm)	Ch.	Freq. (MHz)	RB Num.	RB Start	Power Drift (dB)	1 g Meas SAR (W/kg)	Meas. Power (dBm)	Max. tune power (dBm)	Scaling Factor	1g Report SAR (W/kg)	Meas. No.
<b>Body N-1</b>															
ANT4	DSI2	QPSK	Front Side	15	18700	1860	1	MID	-0.02	0.112	22.41	24.00	1.442	0.162	/
	DSI2			15	18700	1860	50	MID	-0.08	0.105	22.39	24.00	1.449	0.152	/
	DSI2		Back Side	15	18700	1860	1	MID	-0.18	0.206	22.41	24.00	1.442	0.297	/
	DSI2			15	18700	1860	50	MID	0.19	0.192	22.39	24.00	1.449	0.278	/
	DSI2		Top Edge	15	18700	1860	1	MID	-0.01	0.182	22.41	24.00	1.442	0.262	/
	DSI2			15	18700	1860	50	MID	-0.07	0.171	22.39	24.00	1.449	0.248	/
ANT1	DSI2	QPSK	Front Side	15	18700	1860	1	MID	0.10	0.175	20.64	22.00	1.368	0.239	/
	DSI2			15	18700	1860	50	HIGH	0.14	0.161	20.76	22.00	1.330	0.214	/
	DSI2		Back Side	15	18700	1860	1	MID	-0.16	0.357	20.64	22.00	1.368	0.488	/
	DSI2			15	18700	1860	50	HIGH	0.18	0.331	20.76	22.00	1.330	0.440	/
	DSI2		Bottom Edge	15	18700	1860	1	MID	-0.09	0.573	20.64	22.00	1.368	0.784	/
	DSI2			15	18900	1880	1	MID	0.03	0.558	20.64	22.00	1.368	0.763	/
	DSI2			15	19100	1900	1	MID	0.02	0.533	20.64	22.00	1.368	0.729	/
	DSI2			15	18700	1860	50	HIGH	0.05	0.533	20.64	22.00	1.368	0.729	/
	DSI2			15	18900	1880	50	HIGH	0.18	0.513	20.64	22.00	1.368	0.702	/
	DSI2			15	19100	1900	50	HIGH	-0.14	0.432	20.64	22.00	1.368	0.591	/
	DSI2		15	18700	1900	100	LOW	0.15	0.543	20.64	22.00	1.368	0.743	/	
	<b>Body N-1</b>														
Antenna	DSI State	Mode	Position	Dist. (mm)	Ch.	Freq. (MHz)	RB Num.	RB Start	Power Drift (dB)	10g Meas SAR (W/kg)	Meas. Power (dBm)	Max. tune power (dBm)	Scaling Factor	10g Report SAR (W/kg)	Meas. No.
ANT2	DSI2	QPSK	Front Side	5	18700	1860	1	MID	0.08	0.232	23.48	25.00	1.419	0.329	/
	DSI2			5	18700	1860	50	MID	0.04	0.218	23.48	24.00	1.127	0.246	/
	DSI2		Back Side	5	18700	1860	1	MID	0.18	0.390	23.48	25.00	1.419	0.553	/
	DSI2			5	18700	1860	50	MID	0.09	0.396	23.48	24.00	1.127	0.446	/
	DSI2		Left Edge	5	18700	1860	1	MID	-0.18	0.299	23.48	25.00	1.419	0.424	/
	DSI2			5	18700	1860	50	MID	-0.03	0.284	23.48	24.00	1.127	0.320	/
	DSI2		Top Edge	5	18700	1860	1	MID	-0.16	0.126	23.48	25.00	1.419	0.179	/
	DSI2			5	18700	1860	50	MID	0.03	0.120	23.48	24.00	1.127	0.135	/
Note: Refer to ANNEX C for the detailed test data for each test configuration.															

### 11.7LTE Band 4 (20MHz Bandwidth)

Antenna	DSI State	Mode	Position	Dist. (mm)	Ch.	Freq. (MHz)	RB Num.	RB Start	Power Drift (dB)	1 g Meas SAR (W/kg)	Meas. Power (dBm)	Max. tune power (dBm)	Scaling Factor	1g Report SAR (W/kg)	Meas. No.
<b>Head</b>															
ANT4	DSI1	QPSK	Left Cheek	0	20050	1720	1	MID	0.07	0.284	19.35	21.00	1.462	0.415	/
	DSI1			0	20050	1720	50	HIGH	0.13	0.316	19.39	21.00	1.449	0.458	/
	DSI1		Left Tilt	0	20050	1720	1	MID	0.19	0.227	19.35	21.00	1.462	0.332	/
	DSI1			0	20050	1720	50	HIGH	-0.15	0.255	19.39	21.00	1.449	0.369	/
	DSI1		Right Cheek	0	20050	1720	1	MID	0.04	0.472	19.35	21.00	1.462	0.690	/
	DSI1			0	20050	1720	50	HIGH	-0.19	0.497	19.39	21.00	1.449	<b>0.720</b>	17#
	DSI1		Right Tilt	0	20050	1720	1	MID	-0.19	0.387	19.35	21.00	1.462	0.566	/
	DSI1			0	20050	1720	50	HIGH	-0.15	0.401	19.39	21.00	1.449	0.581	/
ANT1	DSI1	QPSK	Left Cheek	0	20175	1732.5	1	HIGH	-0.09	0.056	24.68	25.50	1.208	0.068	/
	DSI1			0	20175	1732.5	50	HIGH	0.03	0.053	23.76	24.50	1.186	0.063	/
	DSI1		Left Tilt	0	20175	1732.5	1	HIGH	0.01	0.026	24.68	25.50	1.208	0.031	/
	DSI1			0	20175	1732.5	50	HIGH	0.02	0.022	23.76	24.50	1.186	0.026	/
	DSI1		Right Cheek	0	20175	1732.5	1	HIGH	-0.15	0.067	24.68	25.50	1.208	0.081	/
	DSI1			0	20175	1732.5	50	HIGH	-0.13	0.055	23.76	24.50	1.186	0.065	/
	DSI1		Right Tilt	0	20175	1732.5	1	HIGH	-0.11	0.031	24.68	25.50	1.208	0.037	/
	DSI1			0	20175	1732.5	50	HIGH	0.06	0.027	23.76	24.50	1.186	0.032	/
<b>Body-worn&amp;Hotspot</b>															
ANT4	DSI4	QPSK	Front Side	10	20175	1732.5	1	MID	0.18	0.081	18.41	20.00	1.442	0.117	/
	DSI4			10	20175	1732.5	50	HIGH	0.06	0.083	18.44	20.00	1.432	0.119	/
	DSI4		Back Side	10	20175	1732.5	1	MID	-0.14	0.143	18.41	20.00	1.442	0.206	/
	DSI4			10	20175	1732.5	50	HIGH	-0.01	0.150	18.44	20.00	1.432	0.215	/
	DSI4		Left Edge	10	20175	1732.5	1	MID	0.04	0.143	18.41	20.00	1.442	0.206	/
	DSI4			10	20175	1732.5	50	HIGH	0.11	0.152	18.44	20.00	1.432	0.218	/
	DSI4		Top Edge	10	20175	1732.5	1	MID	-0.13	0.091	18.41	20.00	1.442	0.131	/
	DSI4			10	20175	1732.5	50	HIGH	0.04	0.097	18.44	20.00	1.432	0.139	/
ANT1	DSI3	QPSK	Front Side	10	20175	1732.5	1	HIGH	0.12	0.147	17.31	18.00	1.172	0.172	/
	DSI3			10	20300	1745	50	MID	-0.09	0.155	17.31	18.00	1.172	0.182	/
	DSI3		Back Side	10	20175	1732.5	1	HIGH	0.1	0.280	17.31	18.00	1.172	0.328	/
	DSI3			10	20300	1745	50	MID	0.12	0.290	17.31	18.00	1.172	0.340	/
	DSI3		Left Edge	10	20175	1732.5	1	HIGH	-0.09	0.052	17.31	18.00	1.172	0.061	/
	DSI3			10	20300	1745	50	MID	0.12	0.063	17.31	18.00	1.172	0.074	/
	DSI3		Right Edge	10	20175	1732.5	1	HIGH	-0.05	0.213	17.31	18.00	1.172	0.250	/
	DSI3			10	20300	1745	50	MID	0.18	0.201	17.31	18.00	1.172	0.236	/
	DSI3		Bottom Edge	10	20175	1732.5	1	HIGH	-0.04	0.463	17.31	18.00	1.172	0.543	/
	DSI3			10	20300	1745	50	MID	-0.04	0.483	17.31	18.00	1.172	<b>0.566</b>	18#
Note: Refer to ANNEX C for the detailed test data for each test configuration.															



Antenna	DSI State	Mode	Position	Dist. (mm)	Ch.	Freq. (MHz)	RB Num.	RB Start	Power Drift (dB)	10g Meas SAR (W/kg)	Meas. Power (dBm)	Max. tune power (dBm)	Scaling Factor	10g Report SAR (W/kg)	Meas. No.
<b>Specific</b>															
ANT1	DSI3	QPSK	Bottom Edge	0	20300	1745	50	MID	-0.05	0.687	17.31	18.00	1.172	<b>0.805</b>	19#
Note: Refer to ANNEX C for the detailed test data for each test configuration.															

Antenna	Power Reduction state	Mode	Position	Dist. (mm)	Ch.	Freq. (MHz)	RB Num.	RB Start	Power Drift (dB)	1 g Meas SAR (W/kg)	Meas. Power (dBm)	Max. tune power (dBm)	Scaling Factor	1g Report SAR (W/kg)	Meas. No.
<b>Body N-1</b>															
ANT4	DSI2	QPSK	Front Side	15	20300	1745	1	LOW	0.12	0.081	24.22	25.50	1.343	0.109	/
	DSI2			15	20300	1745	50	LOW	-0.07	0.066	23.29	24.50	1.321	0.087	/
	DSI2		Back Side	15	20300	1745	1	LOW	0.08	0.147	24.22	25.50	1.343	0.197	/
	DSI2			15	20300	1745	50	LOW	-0.11	0.139	23.29	24.50	1.321	0.184	/
	DSI2		Top Edge	15	20300	1745	1	LOW	0.18	0.118	24.22	25.50	1.343	0.158	/
	DSI2			15	20300	1745	50	LOW	-0.02	0.099	23.29	24.50	1.321	0.131	/
ANT1	DSI2	QPSK	Front Side	15	20175	1732.5	1	HIGH	0.15	0.242	21.27	22.50	1.327	0.321	/
	DSI2			15	20175	1732.5	50	MID	-0.12	0.199	21.31	22.50	1.315	0.262	/
	DSI2		Back Side	15	20175	1732.5	1	HIGH	0.04	0.513	21.27	22.50	1.327	0.681	/
	DSI2			15	20175	1732.5	50	MID	-0.06	0.417	21.31	22.50	1.315	0.548	/
	DSI2		Bottom Edge	15	20175	1732.5	1	HIGH	0.10	0.759	21.27	22.50	1.327	1.007	/
	DSI2			15	20050	1720	1	HIGH	0.01	0.768	21.06	22.50	1.393	1.070	/
	DSI2			15	20300	1745	1	HIGH	-0.07	0.729	21.21	22.50	1.346	0.981	/
	DSI2			15	20175	1732.5	50	MID	0.01	0.633	21.31	22.50	1.315	0.832	/
	DSI2			15	20050	1720	50	MID	0.11	0.688	21.10	22.50	1.380	0.949	/
	DSI2			15	20300	1745	50	MID	0.19	0.658	21.24	22.50	1.337	0.880	/
	DSI2			15	20300	1745	100	LOW	-0.13	0.628	21.13	22.50	1.371	0.861	/
	DSI2			15	20050	1720	100	LOW	-0.05	0.683	21.07	22.50	1.390	0.949	/
	DSI2			15	20175	1732.5	100	LOW	0.10	0.673	21.03	22.50	1.403	0.944	/
	Note: Refer to ANNEX C for the detailed test data for each test configuration.														

### 11.8LTE Band 5 (10MHz Bandwidth)

Antenna	DSI State	Mode	Position	Dist. (mm)	Ch.	Freq. (MHz)	RB Num.	RB Start	Power Drift (dB)	1 g Meas SAR (W/kg)	Meas. Power (dBm)	Max. tune power (dBm)	Scaling Factor	1g Report SAR (W/kg)	Meas. No.
<b>Head</b>															
ANT4	DSI1	QPSK	Left Cheek	0	20600	844	1	LOW	0.08	0.251	19.68	21.00	1.355	0.340	/
				0	20600	844	25	HIGH	-0.04	0.256	19.80	21.00	1.318	0.337	/
	DSI1		Left Tilt	0	20600	844	1	LOW	-0.16	0.219	19.68	21.00	1.355	0.297	/
				0	20600	844	25	HIGH	0.16	0.221	19.80	21.00	1.318	0.291	/
	DSI1		Right Cheek	0	20600	844	1	LOW	-0.03	0.396	19.68	21.00	1.355	<b>0.537</b>	20#
				0	20600	844	25	HIGH	0.06	0.320	19.80	21.00	1.318	0.422	/
	DSI1		Right Tilt	0	20600	844	1	LOW	-0.18	0.283	19.68	21.00	1.355	0.383	/
				0	20600	844	25	HIGH	0.17	0.291	19.80	21.00	1.318	0.384	/
ANT1	DSI1	QPSK	Left Cheek	0	20525	836.5	1	MID	-0.17	0.227	24.34	25.00	1.164	0.264	/
				0	20525	836.5	25	LOW	0.18	0.230	23.46	24.00	1.132	0.260	/
	DSI1		Left Tilt	0	20525	836.5	1	MID	0.07	0.071	24.34	25.00	1.164	0.083	/
				0	20525	836.5	25	LOW	0.13	0.072	23.46	24.00	1.132	0.082	/
	DSI1		Right Cheek	0	20525	836.5	1	MID	-0.07	0.133	24.34	25.00	1.164	0.155	/
				0	20525	836.5	25	LOW	-0.15	0.135	23.46	24.00	1.132	0.153	/
	DSI1		Right Tilt	0	20525	836.5	1	MID	0.06	0.076	24.34	25.00	1.164	0.088	/
				0	20525	836.5	25	LOW	-0.09	0.073	23.46	24.00	1.132	0.083	/
<b>Body-worn&amp;Hotspot</b>															
ANT4	DSI4	QPSK	Front Side	10	20600	844	1	LOW	-0.06	0.129	24.22	25.00	1.197	0.154	/
				10	20525	836.5	25	LOW	-0.11	0.120	23.30	24.00	1.175	0.141	/
	DSI4		Back Side	10	20600	844	1	LOW	-0.1	0.197	24.22	25.00	1.197	0.236	/
				10	20525	836.5	25	LOW	-0.02	0.183	23.30	24.00	1.175	0.215	/
	DSI4		Left Edge	10	20600	844	1	MID	-0.19	0.061	24.22	25.00	1.197	0.073	/
				10	20525	836.5	25	HIGH	0.13	0.058	23.30	24.00	1.175	0.068	/
	DSI4		Top Edge	10	20600	844	1	LOW	-0.04	0.202	24.22	25.00	1.197	0.242	/
				10	20525	836.5	25	LOW	0.03	0.186	23.30	24.00	1.175	0.219	/
ANT1	DSI3	QPSK	Front Side	10	20525	836.5	1	MID	0.04	0.153	24.34	25.00	1.164	0.178	/
				10	20525	836.5	25	LOW	-0.01	0.140	23.46	24.00	1.132	0.158	/
	DSI3		Back Side	10	20525	836.5	1	MID	-0.13	0.249	24.34	25.00	1.164	<b>0.290</b>	21#
				10	20525	836.5	25	LOW	0.08	0.206	23.46	24.00	1.132	0.233	/
	DSI3		Left Edge	10	20525	836.5	1	MID	0.11	0.126	24.34	25.00	1.164	0.147	/
				10	20525	836.5	25	LOW	-0.02	0.113	23.46	24.00	1.132	0.128	/
	DSI3		Right Edge	10	20525	836.5	1	MID	0.03	0.102	24.34	25.00	1.164	0.119	/
				10	20525	836.5	25	LOW	-0.08	0.095	23.46	24.00	1.132	0.108	/
	DSI3	Bottom Edge	10	20525	836.5	1	MID	0.05	0.136	24.34	25.00	1.164	0.158	/	
			10	20525	836.5	25	LOW	0.13	0.111	23.46	24.00	1.132	0.126	/	
Note: Refer to ANNEX C for the detailed test data for each test configuration.															

Antenna	Power Reduction state	Mode	Position	Dist. (mm)	Ch.	Freq. (MHz)	RB Num.	RB Start	Power Drift (dB)	1 g Meas SAR (W/kg)	Meas. Power (dBm)	Max. tune power (dBm)	Scaling Factor	1g Report SAR (W/kg)	Meas. No.
<b>Body N-1</b>															
ANT4	DSI2	QPSK	Front Side	15	20600	844	1	LOW	0.09	0.091	24.22	25.00	1.197	0.109	/
	DSI2			15	20600	844	25	HIGH	-0.07	0.079	23.31	24.00	1.172	0.093	/
	DSI2		Back Side	15	20600	844	1	LOW	0.00	0.129	24.22	25.00	1.197	0.154	/
	DSI2			15	20600	844	25	HIGH	0.03	0.146	23.31	24.00	1.172	0.171	/
	DSI2		Top Edge	15	20600	844	1	LOW	0.18	0.089	24.22	25.00	1.197	0.107	/
	DSI2			15	20600	844	25	HIGH	0.10	0.078	23.31	24.00	1.172	0.091	/
ANT1	DSI2	QPSK	Front Side	15	20600	844	1	LOW	-0.13	0.116	24.36	25.00	1.159	0.134	/
	DSI2			15	20600	844	25	HIGH	-0.04	0.099	23.47	24.00	1.130	0.112	/
	DSI2		Back Side	15	20600	844	1	LOW	0.12	0.150	24.36	25.00	1.159	0.174	/
	DSI2			15	20600	844	25	HIGH	0.04	0.138	23.47	24.00	1.130	0.156	/
	DSI2		Bottom Edge	15	20600	844	1	LOW	-0.05	0.057	24.36	25.00	1.159	0.066	/
	DSI2			15	20600	844	25	HIGH	0.10	0.053	23.47	24.00	1.130	0.060	/

Note: Refer to ANNEX C for the detailed test data for each test configuration.

### 11.9LTE Band 7 (20MHz Bandwidth)

Antenna	DSI State	Mode	Position	Dist. (mm)	Ch.	Freq. (MHz)	RB Num.	RB Start	Power Drift (dB)	1 g Meas SAR (W/kg)	Meas. Power (dBm)	Max. tune power (dBm)	Scaling Factor	1g Report SAR (W/kg)	Meas. No.
Head															
ANT4	DSI1	QPSK	Left Cheek	0	21100	2535	1	HIGH	0.08	0.246	16.31	18.00	1.476	0.363	/
	DSI1			0	21100	2535	50	MID	0.14	0.268	16.19	18.00	1.517	0.407	/
	DSI1		Left Tilt	0	21100	2535	1	HIGH	0.18	0.233	16.31	18.00	1.476	0.344	/
	DSI1			0	21100	2535	50	MID	-0.08	0.246	16.19	18.00	1.517	0.373	/
	DSI1		Right Cheek	0	21100	2535	1	HIGH	-0.14	0.257	16.31	18.00	1.476	0.379	/
	DSI1			0	21100	2535	50	MID	-0.11	0.271	16.19	18.00	1.517	0.411	/
	DSI1		Right Tilt	0	21100	2535	1	HIGH	-0.06	0.406	16.31	18.00	1.476	0.599	/
	DSI1			0	21100	2535	50	MID	0.07	0.444	16.19	18.00	1.517	<b>0.674</b>	22#
ANT1	DSI1	QPSK	Left Cheek	0	21100	2535	1	MID	0.02	0.132	24.91	25.00	1.021	0.135	/
	DSI1			0	21100	2535	50	MID	0.05	0.125	23.98	24.00	1.005	0.126	/
	DSI1		Left Tilt	0	21100	2535	1	MID	-0.09	0.122	24.91	25.00	1.021	0.125	/
	DSI1			0	21100	2535	50	MID	0.09	0.110	23.98	24.00	1.005	0.111	/
	DSI1		Right Cheek	0	21100	2535	1	MID	0.06	0.208	24.91	25.00	1.021	0.212	/
	DSI1			0	21100	2535	50	MID	-0.05	0.198	23.98	24.00	1.005	0.199	/
	DSI1		Right Tilt	0	21100	2535	1	MID	0.17	0.115	24.91	25.00	1.021	0.117	/
	DSI1			0	21100	2535	50	MID	-0.12	0.112	23.98	24.00	1.005	0.113	/
ANT2	DSI1	QPSK	Left Cheek	0	21100	2535	1	MID	0.18	0.111	23.61	24.00	1.094	0.121	/
	DSI1			0	21100	2535	50	MID	0.04	0.095	23.61	24.00	1.094	0.104	/
	DSI1		Left Tilt	0	21100	2535	1	MID	0.05	0.091	23.61	24.00	1.094	0.100	/
	DSI1			0	21100	2535	50	MID	0.08	0.084	23.61	24.00	1.094	0.092	/
	DSI1		Right Cheek	0	21100	2535	1	MID	0.02	0.573	23.61	24.00	1.094	0.627	/
	DSI1			0	21100	2535	50	MID	0.04	0.422	23.61	24.00	1.094	0.462	/
	DSI1		Right Tilt	0	21100	2535	1	MID	-0.04	0.192	23.61	24.00	1.094	0.210	/
	DSI1			0	21100	2535	50	MID	-0.18	0.178	23.61	24.00	1.094	0.195	/
Body-worn&Hotspot															
ANT4	DSI4	QPSK	Front Side	10	21100	2535	1	HIGH	-0.15	0.090	16.31	18.00	1.476	0.133	/
	DSI4			10	21100	2535	50	MID	0.02	0.096	16.19	18.00	1.517	0.146	/
	DSI4		Back Side	10	21100	2535	1	HIGH	-0.19	0.138	16.31	18.00	1.476	0.204	/
	DSI4			10	21100	2535	50	MID	0.04	0.147	16.19	18.00	1.517	0.223	/
	DSI4		Left Edge	10	21100	2535	1	HIGH	-0.01	0.093	16.31	18.00	1.476	0.137	/
	DSI4			10	21100	2535	50	MID	-0.17	0.105	16.19	18.00	1.517	0.159	/
	DSI4		Top Edge	10	21100	2535	1	HIGH	0.07	0.124	16.31	18.00	1.476	0.183	/
	DSI4			10	21100	2535	50	MID	0.01	0.123	16.19	18.00	1.517	0.187	/
ANT1	DSI3	QPSK	Front Side	10	21100	2535	1	MID	-0.13	0.147	18.97	20.00	1.268	0.186	/
	DSI3			10	21100	2535	50	MID	0.19	0.159	18.89	20.00	1.291	0.205	/
	DSI3		Back Side	10	21100	2535	1	MID	-0.12	0.171	18.97	20.00	1.268	0.217	/
	DSI3			10	21100	2535	50	MID	-0.13	0.174	18.89	20.00	1.291	<b>0.225</b>	23#

	DSI3		Left Edge	10	21100	2560	1	MID	-0.18	0.079	18.97	20.00	1.268	0.100	/
	DSI3			10	21100	2560	50	HIGH	0.12	0.086	18.89	20.00	1.291	0.111	/
	DSI3		Right Edge	10	21100	2560	1	MID	0.01	0.136	18.97	20.00	1.268	0.172	/
	DSI3			10	21100	2560	50	HIGH	-0.19	0.131	18.89	20.00	1.291	0.169	/
	DSI3		Bottom Edge	10	21100	2535	1	MID	-0.17	0.158	18.97	20.00	1.268	0.200	/
	DSI3			10	21100	2535	50	MID	0.16	0.162	18.89	20.00	1.291	0.209	/

ANT2	DSI4	QPSK	Front Side	10	21350	2560	1	LOW	-0.08	0.062	21.42	22.00	1.143	0.071	/
	DSI4			10	21350	2560	50	HIGH	0.03	0.055	21.95	22.00	1.012	0.056	/
	DSI4		Back Side	10	21350	2560	1	LOW	-0.17	0.196	21.42	22.00	1.143	0.224	/
	DSI4			10	21350	2560	50	HIGH	0.15	0.195	21.95	22.00	1.012	0.197	/
	DSI4		Left Edge	10	21350	2560	1	LOW	-0.09	0.184	21.42	22.00	1.143	0.210	/
	DSI4			10	21350	2560	50	HIGH	0.11	0.134	21.95	22.00	1.012	0.136	/
	DSI4		Top Edge	10	21350	2560	1	LOW	-0.14	0.053	21.42	22.00	1.143	0.061	/
	DSI4			10	21350	2560	50	HIGH	0.13	0.043	21.95	22.00	1.012	0.044	/

Note: Refer to ANNEX C for the detailed test data for each test configuration.

Antenna	Power Reduction state	Mode	Position	Dist. (mm)	Ch.	Freq. (MHz)	RB Num.	RB Start	Power Drift (dB)	1 g Meas SAR (W/kg)	Meas. Power (dBm)	Max. tune power (dBm)	Scaling Factor	1g Report SAR (W/kg)	Meas. No.
<b>Body N-1</b>															
ANT4	DSI2	QPSK	Front Side	15	21350	2560	1	HIGH	-0.07	0.187	24.17	25.00	1.211	0.226	/
	DSI2			15	21350	2560	50	MID	-0.05	0.183	23.43	24.00	1.140	0.209	/
	DSI2		Back Side	15	21350	2560	1	HIGH	0.02	0.402	24.17	25.00	1.211	0.487	/
	DSI2			15	21350	2560	50	MID	0.14	0.450	23.43	24.00	1.140	0.513	/
	DSI2		Top Edge	15	21350	2560	1	HIGH	-0.03	0.450	24.17	25.00	1.211	0.545	/
	DSI2			15	21350	2560	50	MID	0.10	0.465	23.43	24.00	1.140	0.530	/

ANT1	DSI2	QPSK	Front Side	15	21350	2560	1	HIGH	0.14	0.104	21.39	22.50	1.291	0.134	/
	DSI2			15	21350	2560	50	HIGH	-0.07	0.107	21.46	22.50	1.271	0.136	/
	DSI2		Back Side	15	21350	2560	1	HIGH	0.13	0.185	21.39	22.50	1.291	0.239	/
	DSI2			15	21350	2560	50	HIGH	-0.18	0.192	21.46	22.50	1.271	0.244	/
	DSI2		Bottom Edge	15	21350	2560	1	HIGH	0.12	0.180	21.39	22.50	1.291	0.232	/
	DSI2			15	21350	2560	50	HIGH	0.04	0.191	21.46	22.50	1.271	0.243	/

Note: Refer to ANNEX C for the detailed test data for each test configuration.

### 11.10 LTE Band 7 Worse case for CA Test

Antenna	DSI State	Mode	Position	Dist. (mm)	Ch.	Freq. (MHz)	RB Num.	RB Start	Power Drift (dB)	1 g Meas SAR (W/kg)	Meas. Power (dBm)	Max. tune power (dBm)	Scaling Factor	1g Report SAR (W/kg)	Meas. No.
Head-CA															
ANT4	DSI1	QPSK	Right Tilt	0	21100+ 21298	2535+2 554.8	1+1	High+ Low	-0.02	0.402	16.86	18.00	1.300	<b>0.523</b>	30#
Body-CA															
ANT1	DSI3	QPSK	Back Side	10	21100+ 21298	2535+2 554.8	1+1	High+ Low	-0.05	0.167	19.72	20.00	1.067	0.178	31#
Note: Refer to ANNEX C for the detailed test data for each test configuration.															

### 11.11 LTE Band 38 (20MHz Bandwidth)

Antenna	Power Reduction state	Mode	Position	Dist. (mm)	Ch.	Freq. (MHz)	RB Num.	RB Start	Power Drift (dB)	1g Meas SAR (W/kg)	Meas. Power (dBm)	Max. tune power (dBm)	Scaling Factor	1g Report SAR (W/kg)	Meas. No.
<b>Head</b>															
ANT4	DSI1	QPSK	Left Cheek	0	38000	2595	1	LOW	-0.05	0.328	20.10	21.50	1.380	0.453	/
	DSI1			0	38000	2595	50	LOW	-0.07	0.340	20.13	21.50	1.371	0.466	/
	DSI1		Left Tilt	0	38000	2595	1	LOW	0.01	0.342	20.10	21.50	1.380	0.472	/
	DSI1			0	38000	2595	50	LOW	-0.06	0.360	20.13	21.50	1.371	0.494	/
	DSI1		Right Cheek	0	38000	2595	1	LOW	0.02	0.709	20.10	21.50	1.380	0.978	/
	DSI1			0	38000	2595	50	LOW	-0.09	0.717	20.13	21.50	1.371	0.983	/
	DSI1			0	37850	2580	50	LOW	-0.01	0.724	20.13	21.50	1.371	0.993	/
	DSI1		Right Tilt	0	38150	2610	50	MID	-0.15	0.739	20.01	21.50	1.409	1.041	/
	DSI1			0	38000	2595	1	LOW	-0.19	0.731	20.10	21.50	1.380	1.009	/
	DSI1			0	38000	2595	50	LOW	-0.13	0.797	20.13	21.50	1.371	<b>1.093</b>	24#
	DSI1			0	37850	2580	50	LOW	-0.19	0.776	20.13	21.50	1.371	1.064	/
	DSI1		0	38150	2610	50	MID	0.09	0.736	20.01	21.50	1.409	1.037	/	
ANT1	DSI1	QPSK	Left Cheek	0	37850	2580	1	HIGH	-0.18	0.054	24.94	25.50	1.138	0.061	/
	DSI1			0	37850	2580	50	HIGH	0.02	0.065	23.98	24.50	1.127	0.073	/
	DSI1		Left Tilt	0	37850	2580	1	HIGH	0.05	0.043	24.94	25.50	1.138	0.049	/
	DSI1			0	37850	2580	50	HIGH	-0.01	0.055	23.98	24.50	1.127	0.062	/
	DSI1		Right Cheek	0	37850	2580	1	HIGH	0.09	0.109	24.94	25.50	1.138	0.124	/
	DSI1			0	37850	2580	50	HIGH	0.06	0.091	23.98	24.50	1.127	0.103	/
	DSI1		Right Tilt	0	37850	2580	1	HIGH	-0.16	0.066	24.94	25.50	1.138	0.075	/
	DSI1			0	37850	2580	50	HIGH	-0.06	0.057	23.98	24.50	1.127	0.064	/
<b>Body-worn&amp;Hotspot</b>															
ANT4	DSI4	QPSK	Front Side	10	38000	2595	1	LOW	-0.12	0.136	19.82	21.50	1.472	0.200	/
	DSI4			10	38000	2595	50	LOW	0.11	0.136	19.85	21.50	1.462	0.199	/
	DSI4		Back Side	10	38000	2595	1	LOW	0.14	0.294	19.82	21.50	1.472	0.433	/
	DSI4			10	38000	2595	50	LOW	0.11	0.300	19.85	21.50	1.462	0.439	/
	DSI4		Left Edge	10	38000	2610	1	LOW	-0.15	0.083	19.82	21.50	1.472	0.122	/
	DSI4			10	38000	2610	50	MID	0.19	0.097	19.85	21.50	1.462	0.142	/
	DSI4		Top Edge	10	38000	2595	1	LOW	0.17	0.327	19.82	21.50	1.472	0.481	/
	DSI4			10	38000	2595	50	LOW	0.02	0.339	19.85	21.50	1.462	<b>0.496</b>	25#
ANT1	DSI3	QPSK	Front Side	10	37850	2580	1	HIGH	0.16	0.167	22.38	23.50	1.294	0.216	/
	DSI3			10	38000	2595	50	LOW	0.1	0.180	22.40	23.50	1.288	0.232	/
	DSI3		Back Side	10	37850	2580	1	HIGH	0.02	0.301	22.38	23.50	1.294	0.389	/
	DSI3			10	38000	2595	50	LOW	0.01	0.316	22.40	23.50	1.288	0.407	/
	DSI3		Left Edge	10	37850	2595	1	LOW	-0.01	0.095	22.38	23.50	1.294	0.123	/
	DSI3			10	38000	2580	50	LOW	0.03	0.106	22.40	23.50	1.288	0.137	/
	DSI3		Right Edge	10	37850	2595	1	LOW	-0.12	0.145	22.38	23.50	1.294	0.188	/
	DSI3			10	38000	2580	50	LOW	-0.17	0.158	22.40	23.50	1.288	0.204	/

	DSI3	Bottom Edge	10	37850	2580	1	HIGH	-0.03	0.294	22.38	23.50	1.294	0.380	/
	DSI3		10	38000	2595	50	LOW	-0.1	0.309	22.40	23.50	1.288	0.398	/

Note: Refer to ANNEX C for the detailed test data for each test configuration.

Antenna	Power Reduction state	Mode	Position	Dist. (mm)	Ch.	Freq. (MHz)	RB Num.	RB Start	Power Drift (dB)	10 g Meas SAR (W/kg)	Meas. Power (dBm)	Max. tune power (dBm)	Scaling Factor	10g Report SAR (W/kg)	Meas. No.
---------	-----------------------	------	----------	------------	-----	-------------	---------	----------	------------------	----------------------	-------------------	-----------------------	----------------	-----------------------	-----------

**Specific**

ANT4	DSI4	QPSK	Top Edge	0	38000	2595	50	LOW	0.03	0.633	19.85	21.50	1.462	<b>0.925</b>	26#
------	------	------	----------	---	-------	------	----	-----	------	-------	-------	-------	-------	--------------	-----

Note: Refer to ANNEX C for the detailed test data for each test configuration.

Antenna	Power Reduction state	Mode	Position	Dist. (mm)	Ch.	Freq. (MHz)	RB Num.	RB Start	Power Drift (dB)	1g Meas SAR (W/kg)	Meas. Power (dBm)	Max. tune power (dBm)	Scaling Factor	1g Report SAR (W/kg)	Meas. No.
---------	-----------------------	------	----------	------------	-----	-------------	---------	----------	------------------	--------------------	-------------------	-----------------------	----------------	----------------------	-----------

**Body N-1**

ANT4	DSI2	QPSK	Front Side	15	38150	2610	1	LOW	0.12	0.167	24.50	25.50	1.259	0.210	/
	DSI2			15	38150	2610	50	MID	0.07	0.131	23.53	24.50	1.250	0.164	/
	DSI2		Back Side	15	38150	2610	1	HIGH	-0.01	0.375	24.50	25.50	1.259	0.472	/
	DSI2			15	38150	2610	50	MID	-0.09	0.298	23.53	24.50	1.250	0.373	/
	DSI2		Top Edge	15	38150	2610	1	HIGH	0.18	0.427	24.50	25.50	1.259	0.538	/
	DSI2			15	38150	2610	50	MID	0.03	0.353	23.53	24.50	1.250	0.441	/
ANT1	DSI2	QPSK	Front Side	15	37850	2580	1	MID	0.09	0.162	23.38	24.50	1.294	0.210	/
	DSI2			15	37850	2580	50	LOW	-0.06	0.112	23.45	24.50	1.274	0.143	/
	DSI2		Back Side	15	37850	2580	1	MID	-0.03	0.276	23.38	24.50	1.294	0.357	/
	DSI2			15	37850	2580	50	LOW	0.15	0.229	23.45	24.50	1.274	0.292	/
	DSI2		Bottom Edge	15	37850	2580	1	MID	-0.01	0.267	23.38	24.50	1.294	0.345	/
	DSI2			15	37850	2580	50	LOW	0.03	0.216	23.45	24.50	1.274	0.275	/

**Body N-1**

ANT2	DSI2	QPSK	Front Side	5	38000	2595	1	MID	0.08	0.068	24.62	25.00	1.091	0.074	/
	DSI2			5	38000	2595	50	MID	-0.12	0.080	23.46	24.00	1.132	0.091	/
	DSI2		Back Side	5	38000	2595	1	MID	-0.15	0.183	24.62	25.00	1.091	0.200	/
	DSI2			5	38000	2595	50	MID	0.01	0.207	23.46	24.00	1.132	0.234	/
	DSI2		Left Edge	5	38000	2595	1	MID	0.06	0.097	24.62	25.00	1.091	0.106	/
	DSI2			5	38000	2595	50	MID	0.12	0.105	23.46	24.00	1.132	0.119	/
	DSI2		Top Edge	5	38000	2595	1	MID	0.08	0.068	24.62	25.00	1.091	0.074	/
	DSI2			5	38000	2595	50	MID	-0.10	0.079	23.46	24.00	1.132	0.089	/

Note: Refer to ANNEX C for the detailed test data for each test configuration.



### 11.12 LTE Band 38 Worse case for CA Test

Antenna	Power Reduction state	Mode	Position	Dist. (mm)	Ch.	Freq. (MHz)	RB Num.	RB Start	Power Drift (dB)	1g Meas SAR (W/kg)	Meas. Power (dBm)	Max. tune power (dBm)	Scaling Factor	1g Report SAR (W/kg)	Meas. No.
Head-CA															
ANT4	DSI1	QPSK	Right Tilt	0	38099+37901	2604.9+2624.7	1+1	Low+ High	0.02	0.784	20.39	21.50	1.291	<b>1.012</b>	32#
	DSI1	QPSK		0	37850+38048	2580+2598.8	1+1	Low+ High	-0.06	0.761	20.33	21.50	1.309	0.996	/
	DSI1	QPSK		0	38150+37952	2610+2590.2	1+1	Low+ High	-0.13	0.752	20.28	21.50	1.324	0.996	/
Body-CA															
ANT4	DSI4	QPSK	Top Edge	10	38099+37901	2604.9+2624.7	1+1	Low+ High	0.07	0.308	20.39	21.50	1.291	<b>0.398</b>	33#
Note: Refer to ANNEX C for the detailed test data for each test configuration.															

Antenna	Power Reduction state	Mode	Position	Dist. (mm)	Ch.	Freq. (MHz)	RB Num.	RB Start	Power Drift (dB)	10 g Meas SAR (W/kg)	Meas. Power (dBm)	Max. tune power (dBm)	Scaling Factor	10g Report SAR (W/kg)	Meas. No.
Specific-CA															
ANT4	DSI4	QPSK	Top Edge	0	38099+37901	2604.9+2624.7	1+1	Low+ High	0.02	0.594	20.39	21.50	1.291	<b>0.767</b>	34#
Note: Refer to ANNEX C for the detailed test data for each test configuration.															

### 11.13 LTE Band 41 (20MHz Bandwidth)

Antenna	Power Reduction state	Mode	Position	Dist. (mm)	Ch.	Freq. (MHz)	RB Num.	RB Start	Power Drift (dB)	1g Meas SAR (W/kg)	Meas. Power (dBm)	Max. tune power (dBm)	Scaling Factor	1g Report SAR (W/kg)	Meas. No.
<b>Head</b>															
ANT4	DSI1	QPSK	Left Cheek	0	41490	2680	1	HIGH	-0.11	0.367	18.69	20.50	1.517	0.557	/
	DSI1			0	41055	2636.5	50	MID	0.09	0.370	18.74	20.50	1.500	0.555	/
	DSI1		Left Tilt	0	41490	2680	1	HIGH	-0.15	0.409	18.69	20.50	1.517	0.620	/
	DSI1			0	41055	2636.5	50	MID	-0.04	0.417	18.74	20.50	1.500	0.626	/
	DSI1		Right Cheek	0	41490	2680	1	HIGH	0.12	0.553	18.69	20.50	1.517	0.839	/
	DSI1			0	41055	2636.5	50	MID	-0.05	0.579	18.74	20.50	1.500	0.869	/
	DSI1			0	39750	2506	50	HIGH	0.01	0.564	18.66	20.50	1.528	0.862	/
	DSI1			0	40185	2549.5	50	MID	0.13	0.588	18.72	20.50	1.507	0.886	/
	DSI1		Right Tilt	0	40620	2593	50	LOW	0.02	0.583	18.63	20.50	1.538	0.897	/
	DSI1			0	41490	2680	1	HIGH	-0.11	0.602	18.69	20.50	1.517	0.913	/
	DSI1			0	41055	2636.5	50	MID	0.14	0.649	18.74	20.50	1.500	<b>0.974</b>	27#
	DSI1			0	39750	2506	50	HIGH	-0.15	0.622	18.66	20.50	1.528	0.950	/
	DSI1		0	40185	2549.5	50	MID	0.18	0.605	18.72	20.50	1.507	0.912	/	
	DSI1		0	40620	2593	50	MID	-0.05	0.613	18.63	20.50	1.538	0.943	/	
ANT1	DSI1	QPSK	Left Cheek	0	40620	2593	1	LOW	-0.13	0.060	24.72	25.50	1.197	0.072	/
	DSI1			0	40620	2593	50	MID	0.08	0.048	23.75	24.50	1.189	0.057	/
	DSI1		Left Tilt	0	40620	2593	1	LOW	-0.06	0.041	24.72	25.50	1.197	0.049	/
	DSI1			0	40620	2593	50	MID	0.18	0.023	23.75	24.50	1.189	0.027	/
	DSI1		Right Cheek	0	40620	2593	1	LOW	-0.09	0.082	24.72	25.50	1.197	0.098	/
	DSI1			0	40620	2593	50	MID	0.02	0.070	23.75	24.50	1.189	0.083	/
	DSI1		Right Tilt	0	40620	2593	1	LOW	-0.06	0.042	24.72	25.50	1.197	0.050	/
	DSI1			0	40620	2593	50	MID	0.11	0.044	23.75	24.50	1.189	0.052	/
ANT2	DSI1	QPSK	Left Cheek	0	40620	2593	1	MID	-0.13	0.123	24.47	25.00	1.130	0.139	/
	DSI1			0	40620	2593	50	MID	-0.15	0.111	23.14	24.00	1.219	0.135	/
	DSI1		Left Tilt	0	40620	2593	1	MID	0.13	0.115	24.47	25.00	1.130	0.130	/
	DSI1			0	40620	2593	50	MID	-0.15	0.098	23.14	24.00	1.219	0.119	/
	DSI1		Right Cheek	0	40620	2593	1	MID	0.07	0.356	24.47	25.00	1.130	0.402	/
	DSI1			0	40620	2593	50	MID	-0.02	0.336	23.14	24.00	1.219	0.410	/
	DSI1		Right Tilt	0	40620	2593	1	MID	-0.16	0.246	24.47	25.00	1.130	0.278	/
	DSI1			0	40620	2593	50	MID	-0.08	0.229	23.14	24.00	1.219	0.279	/
<b>Body-worn&amp;Hotspot</b>															
ANT4	DSI4	QPSK	Front Side	10	41055	2636.5	1	HIGH	-0.15	0.166	19.73	21.50	1.503	0.249	/
	DSI4			10	40620	2593	50	MID	-0.04	0.170	19.86	21.50	1.459	0.248	/
	DSI4		Back Side	10	41055	2636.5	1	HIGH	-0.17	0.305	19.73	21.50	1.503	0.458	/
	DSI4			10	40620	2593	50	MID	0.16	0.307	19.86	21.50	1.459	0.448	/
	DSI4		Left Edge	10	40620	2593	1	LOW	-0.16	0.088	19.73	21.50	1.503	0.132	/
	DSI4			10	40620	2593	50	MID	0.06	0.097	19.86	21.50	1.459	0.142	/

	DSI4		Top Edge	10	41055	2636.5	1	HIGH	0.07	0.317	19.73	21.50	1.503	0.476	/
	DSI4			10	40620	2593	50	MID	0.12	0.334	19.86	21.50	1.459	<b>0.487</b>	28#
ANT1	DSI3	QPSK	Front Side	10	40620	2593	1	HIGH	-0.01	0.238	22.38	23.50	1.294	0.308	/
	DSI3			10	40185	2549.5	50	MID	0.09	0.201	22.50	23.50	1.259	0.253	/
	DSI3		Back Side	10	40620	2593	1	HIGH	0.03	0.315	22.38	23.50	1.294	0.408	/
	DSI3			10	40185	2549.5	50	MID	-0.08	0.304	22.50	23.50	1.259	0.383	/
	DSI2		Left Edge	10	40620	2636.5	1	MID	-0.06	0.128	22.38	23.50	1.294	0.166	/
	DSI2			10	40185	2636.5	50	MID	0.15	0.096	22.50	23.50	1.259	0.121	/
	DSI2		Right Edge	10	40620	2636.5	1	MID	-0.05	0.123	22.38	23.50	1.294	0.159	/
	DSI2			10	40185	2636.5	50	MID	-0.02	0.104	22.50	23.50	1.259	0.131	/
	DSI3		Bottom Edge	10	40620	2593	1	HIGH	0.17	0.340	22.38	23.50	1.294	0.440	/
	DSI3			10	40185	2549.5	50	MID	-0.05	0.282	22.50	23.50	1.259	0.355	/
ANT2	DSI4	QPSK	Front Side	10	40620	2593	1	HIGH	0.13	0.067	24.47	25.00	1.130	0.076	/
	DSI4			10	40620	2593	50	MID	-0.05	0.085	23.14	24.00	1.219	0.104	/
	DSI4		Back Side	10	40620	2593	1	HIGH	-0.16	0.160	24.47	25.00	1.130	0.181	/
	DSI4			10	40620	2593	50	MID	-0.16	0.210	23.14	24.00	1.219	0.256	/
	DSI4		Left Edge	10	40620	2593	1	HIGH	0.04	0.068	24.47	25.00	1.130	0.077	/
	DSI4			10	40620	2593	50	MID	0.05	0.069	23.14	24.00	1.219	0.084	/
	DSI4		Top Edge	10	40620	2593	1	HIGH	0.17	0.081	24.47	25.00	1.130	0.092	/
	DSI4			10	40620	2593	50	MID	-0.1	0.087	23.14	24.00	1.219	0.106	/

Note: Refer to ANNEX C for the detailed test data for each test configuration.

Antenna	Power Reduction state	Mode	Position	Dist. (mm)	Ch.	Freq. (MHz)	RB Num.	RB Start	Power Drift (dB)	10 g Meas SAR (W/kg)	Meas. Power (dBm)	Max. tune power (dBm)	Scaling Factor	1g Report SAR (W/kg)	Meas. No.
<b>Specific</b>															
ANT4	DSI4	QPSK	Top Edge	0	40620	2595	50	LOW	0.17	0.628	19.86	21.50	1.459	<b>0.916</b>	29#

Note: Refer to ANNEX C for the detailed test data for each test configuration.

LTE Band41 (20MHz Bandwidth)															
Antenna	Power Reduction state	Mode	Position	Dist. (mm)	Ch.	Freq. (MHz)	RB Num.	RB Start	Power Drift (dB)	1g Meas SAR (W/kg)	Meas. Power (dBm)	Max. tune power (dBm)	Scaling Factor	1g Report SAR (W/kg)	Meas. No.
<b>Body N-1</b>															
ANT4	DSI2	QPSK	Front Side	15	40620	2593	1	LOW	-0.11	0.133	24.42	25.50	1.282	0.171	/
				15	40620	2593	50	MID	-0.04	0.128	23.48	24.50	1.265	0.162	/
			Back Side	15	40620	2593	1	HIGH	0.05	0.311	24.42	25.50	1.282	0.399	/
				15	40620	2593	50	MID	0.01	0.287	23.48	24.50	1.265	0.363	/
			Top Edge	15	40620	2593	1	HIGH	0.09	0.405	24.42	25.50	1.282	0.519	/
				15	40620	2593	50	MID	-0.18	0.340	23.48	24.50	1.265	0.430	/
ANT1	DSI2	QPSK	Front Side	15	41055	2636.5	1	LOW	0.10	0.154	23.41	24.50	1.285	0.198	/
				15	41055	2636.5	50	LOW	-0.19	0.124	23.49	24.50	1.262	0.156	/
			Back Side	15	41055	2636.5	1	LOW	0.19	0.270	23.41	24.50	1.285	0.347	/
				15	41055	2636.5	50	LOW	0.05	0.216	23.49	24.50	1.262	0.273	/
			Bottom Edge	15	41055	2636.5	1	LOW	-0.02	0.244	23.41	24.50	1.285	0.314	/
				15	41055	2636.5	50	LOW	-0.18	0.203	23.49	24.50	1.262	0.256	/

Antenna	Power Reduction state	Mode	Position	Dist. (mm)	Ch.	Freq. (MHz)	RB Num.	RB Start	Power Drift (dB)	10g Meas SAR (W/kg)	Meas. Power (dBm)	Max. tune power (dBm)	Scaling Factor	10g Report SAR (W/kg)	Meas. No.
<b>Body N-1</b>															
ANT2	DSI2	QPSK	Front Side	5	41490	2680	1	HIGH	-0.07	0.078	24.47	25.00	1.130	0.088	/
				5	39750	2506	50	HIGH	-0.10	0.086	23.72	24.00	1.067	0.092	/
			Back Side	5	41490	2680	1	HIGH	0.03	0.198	24.47	25.00	1.130	0.224	/
				5	39750	2506	50	HIGH	-0.08	0.224	23.72	24.00	1.067	0.239	/
			Left Edge	5	41490	2680	1	HIGH	0.10	0.096	24.47	25.00	1.130	0.108	/
				5	39750	2506	50	HIGH	0.01	0.115	23.72	24.00	1.067	0.123	/
			Top Edge	5	41490	2680	1	HIGH	-0.12	0.072	24.47	25.00	1.130	0.081	/
				5	39750	2506	50	HIGH	0.02	0.085	23.72	24.00	1.067	0.091	/

Note: Refer to ANNEX C for the detailed test data for each test configuration.

### 11.14 n5 (20MHz Bandwidth)

Ant.enna	Power Reduction	Mode	Information	Position	Dist. (mm)	Ch.	Freq. (MHz)	RB UL	RB Num.	RB Start	Power Drift (dB)	1 g Meas SAR (W/kg)	Meas. Power (dBm)	Max. tune-power (dBm)	Scaling Factor	1g Scaled SAR (W/kg)	Meas. No.		
<b>Head</b>																			
Ant.4	DSI1	DFT-s-OFDM	SA	Left	0	167300	836.5	106	1	1	-0.05	0.353	21.87	22.00	1.030	0.364	/		
	DSI1			Cheek	0	167300	836.5	106	50	28	0.01	0.355	21.82	22.00	1.042	0.370	/		
	DSI1			Left Tilt	0	167300	836.5	106	1	1	-0.03	0.328	21.87	22.00	1.030	0.338	/		
	DSI1				0	167300	836.5	106	50	28	0.12	0.326	21.82	22.00	1.042	0.340	/		
	DSI1			BPSK	SA	Right	0	167300	836.5	106	1	1	-0.17	0.386	21.87	22.00	1.030	<b>0.398</b>	35#
	DSI1					Cheek	0	167300	836.5	106	50	28	0.05	0.372	21.82	22.00	1.042	0.388	/
	DSI1			Right	0	167300	836.5	106	1	1	-0.11	0.336	21.87	22.00	1.030	0.346	/		
	DSI1				Tilt	0	167300	836.5	106	50	28	-0.05	0.332	21.82	22.00	1.042	0.346	/	
Ant.1	DSI1	DFT-s-OFDM	SA	Left	0	167800	839	106	1	1	-0.05	0.061	24.99	25.00	1.002	0.061	/		
	DSI1			Cheek	0	166800	834	106	50	56	-0.01	0.047	24.93	25.00	1.016	0.048	/		
	DSI1			Left Tilt	0	167800	839	106	1	1	0.09	0.021	24.99	25.00	1.002	0.021	/		
	DSI1				0	166800	834	106	50	56	-0.02	0.016	24.93	25.00	1.016	0.016	/		
	DSI1			BPSK	SA	Right	0	167800	839	106	1	1	-0.16	0.045	24.99	25.00	1.002	0.045	/
	DSI1					Cheek	0	166800	834	106	50	56	-0.19	0.042	24.93	25.00	1.016	0.043	/
	DSI1			Right	0	167800	839	106	1	1	0.01	0.023	24.99	25.00	1.002	0.023	/		
	DSI1				Tilt	0	166800	834	106	50	56	-0.15	0.017	24.93	25.00	1.016	0.017	/	
<b>Body-worn&amp;Hotspot</b>																			
Ant.4	DSI4	DFT-s-OFDM	SA	Front	10	167800	839	106	1	1	0.09	0.153	24.99	25.00	1.002	0.153	/		
	DSI4			Side	10	166800	834	106	50	28	-0.18	0.155	24.83	25.00	1.040	0.161	/		
	DSI4			Back	10	167800	839	106	1	1	0.17	0.241	24.99	25.00	1.002	0.241	/		
	DSI4				10	166800	834	106	50	28	0.04	0.263	24.83	25.00	1.040	<b>0.274</b>	36#		
	DSI4			Left	10	167800	839	106	1	1	-0.06	0.073	24.99	25.00	1.002	0.073	/		
	DSI4				Edge	10	166800	834	106	50	28	-0.18	0.075	24.83	25.00	1.040	0.078	/	
	DSI4			Top	10	167800	839	106	1	1	-0.07	0.221	24.99	25.00	1.002	0.221	/		
	DSI4				Edge	10	166800	834	106	50	28	-0.09	0.216	24.83	25.00	1.040	0.225	/	
Ant.1	DSI3	DFT-s-OFDM	SA	Front	10	167800	839	106	1	1	-0.04	0.073	24.99	25.00	1.002	0.073	/		
	DSI3			Side	10	166800	834	106	50	56	-0.12	0.077	24.93	25.00	1.016	0.078	/		
	DSI3			Back	10	167800	839	106	1	1	0.06	0.136	24.99	25.00	1.002	0.136	/		
	DSI3				10	166800	834	106	50	56	-0.08	0.124	24.93	25.00	1.016	0.126	/		
	DSI3			Left	10	167800	839	106	1	1	0.01	0.054	24.99	25.00	1.002	0.054	/		
	DSI3				Edge	10	166800	839	106	50	56	-0.06	0.047	24.93	25.00	1.016	0.048	/	
	DSI3			Right	10	167800	839	106	1	1	0.12	0.008	24.99	25.00	1.002	0.008	/		
	DSI3				Edge	10	166800	839	106	50	56	-0.04	0.008	24.93	25.00	1.016	0.008	/	
	DSI3			Bottom	10	167800	839	106	1	1	-0.07	0.129	24.99	25.00	1.002	0.129	/		
	DSI3				Edge	10	166800	834	106	50	56	0.18	0.118	24.93	25.00	1.016	0.120	/	

Note: Refer to ANNEX C for the detailed test data for each test configuration.

Antenna	Power Reduction	Mode	Information	Position	Dist. (mm)	Ch.	Freq. (MHz)	RB Num.	RB Start	Power Drift (dB)	1 g Meas SAR (W/kg)	Meas. Power (dBm)	Max. tune-power (dBm)	Scaling Factor	1g Scaled SAR (W/kg)	Meas. No.
<b>Body N-1</b>																
Ant.4	DSI2	DFT-s-OFDM BPSK	SA	Front Side	15	167800	839	1	1	-0.19	0.111	24.99	25.00	1.002	0.111	/
	DSI2			Front Side	15	167800	839	50	28	-0.12	0.106	24.83	25.00	1.040	0.110	/
	DSI2			Back Side	15	167800	839	1	1	-0.14	0.157	24.99	25.00	1.002	0.157	/
	DSI2			Back Side	15	167800	839	50	28	0.15	0.143	24.83	25.00	1.040	0.149	/
	DSI2			Top Edge	15	167800	839	1	1	0.18	0.108	24.99	25.00	1.002	0.108	/
	DSI2			Top Edge	15	167800	839	50	28	-0.14	0.114	24.83	25.00	1.040	0.119	/
Ant.1	DSI2	DFT-s-OFDM BPSK	SA	Front Side	15	167800	839	1	1	0.01	0.054	24.99	25.00	1.002	0.054	/
	DSI2			Front Side	15	166800	834	50	56	-0.04	0.059	24.93	25.00	1.016	0.060	/
	DSI2			Back Side	15	167800	839	1	1	0.09	0.083	24.99	25.00	1.002	0.083	/
	DSI2			Back Side	15	166800	834	50	56	0.07	0.086	24.93	25.00	1.016	0.087	/
	DSI2			Bottom Edge	15	167800	839	1	1	0.09	0.069	24.99	25.00	1.002	0.069	/
	DSI2			Bottom Edge	15	166800	834	50	56	-0.07	0.070	24.93	25.00	1.016	0.071	/

Note: Refer to ANNEX C for the detailed test data for each test configuration.

### 11.15 n7 (20MHz Bandwidth)

Ant.enna	Power Reduction	Mode	Information	Position	Dist. (mm)	Ch.	Freq. (MHz)	RB UL	RB Num.	RB Start	Power Drift (dB)	1 g Meas SAR (W/kg)	Meas. Power (dBm)	Max. tune-power (dBm)	Scaling Factor	1g Scaled SAR (W/kg)	Meas. No.
<b>Head</b>																	
Ant.4	DSI1	DFT-s-OFDM BPSK	SA	Left	0	502000	2510	270	1	1	-0.16	0.461	18.90	19.00	1.023	0.472	/
	DSI1			Cheek	0	507000	2535	270	50	0	-0.10	0.483	18.50	19.00	1.122	0.542	/
	DSI1			Left Tilt	0	502000	2510	270	1	1	-0.07	0.206	18.90	19.00	1.023	0.211	/
	DSI1				0	507000	2535	270	50	0	0.09	0.518	18.50	19.00	1.122	0.581	/
	DSI1			Right Cheek	0	502000	2510	270	1	1	-0.16	0.783	18.90	19.00	1.023	0.801	/
	DSI1				0	507000	2535	270	50	0	0.03	0.774	18.50	19.00	1.122	0.868	/
	DSI1			Right Tilt	0	502000	2510	270	1	1	0.02	0.732	18.90	19.00	1.023	0.749	/
	DSI1				0	507000	2535	270	50	0	-0.06	0.756	18.50	19.00	1.122	0.848	/
	DSI1			Right Cheek	0	507000	2535	270	1	1	-0.13	0.822	18.90	19.00	1.023	0.841	/
	DSI1				0	512000	2560	270	1	1	0.11	0.791	18.79	19.00	1.050	0.831	/
	DSI1				0	502000	2510	270	50	0	-0.13	0.866	18.66	19.00	1.081	<b>0.936</b>	<b>37#</b>
	DSI1				0	512000	2560	270	50	56	0.12	0.831	18.49	19.00	1.125	0.935	/
	DSI1			Right Tilt	0	507000	2535	270	100	0	-0.06	0.811	18.84	19.00	1.038	0.842	/
	DSI1				0	502000	2510	270	50	0	-0.12	0.766	18.66	19.00	1.081	0.828	/
DSI1	0	512000	2560		270	50	56	0.11	0.741	18.49	19.00	1.125	0.834	/			
DSI1				0	507000	2535	270	100	0	0.08	0.750	18.84	19.00	1.038	0.779	/	
Ant.1	DSI1	DFT-s-OFDM BPSK	SA	Left	0	512000	2560	270	1	1	-0.07	0.209	24.98	25.00	1.005	0.210	/
	DSI1			Cheek	0	512000	2560	270	50	0	-0.17	0.202	24.97	25.00	1.007	0.203	/
	DSI1			Left Tilt	0	512000	2560	270	1	1	0.08	0.189	24.98	25.00	1.005	0.190	/
	DSI1				0	512000	2560	270	50	0	0.15	0.184	24.97	25.00	1.007	0.185	/
	DSI1			Right Cheek	0	512000	2560	270	1	1	0.00	0.274	24.98	25.00	1.005	0.275	/
	DSI1				0	512000	2560	270	50	0	0.06	0.299	24.97	25.00	1.007	0.301	/
	DSI1			Right Tilt	0	512000	2560	270	1	1	-0.13	0.107	24.98	25.00	1.005	0.108	/
	DSI1				0	512000	2560	270	50	0	0.14	0.104	24.97	25.00	1.007	0.105	/
<b>Body-worn&amp;Hotspot</b>																	
Ant.4	DSI4	DFT-s-OFDM BPSK	SA	Front	10	507000	2535	270	1	104	-0.15	0.209	16.87	17.00	1.030	0.215	/
	DSI4			Side	10	507000	2535	270	50	28	-0.12	0.202	16.93	17.00	1.016	0.205	/
	DSI4			Back Side	10	507000	2535	270	1	104	-0.15	0.189	16.87	17.00	1.030	0.195	/
	DSI4				10	507000	2535	270	50	28	0.13	0.184	16.93	17.00	1.016	0.187	/
	DSI4			Left Edge	10	507000	2560	270	1	104	0.13	0.274	16.87	17.00	1.030	0.282	/
	DSI4				10	507000	2560	270	50	28	-0.09	0.299	16.93	17.00	1.016	0.304	/
	DSI4			Top Edge	10	507000	2535	270	1	104	-0.17	0.107	16.87	17.00	1.030	0.110	/
	DSI4				10	507000	2535	270	50	28	0.07	0.104	16.93	17.00	1.016	0.106	/
Ant.1	DSI3	DFT-s-	SA	Front	10	512000	2560	270	1	53	-0.03	0.191	20.95	21.00	1.012	0.193	/
	DSI3			Side	10	507000	2535	270	50	0	0.17	0.193	20.90	21.00	1.023	0.197	/
	DSI3			10	512000	2560	270	1	53	-0.09	0.341	20.95	21.00	1.012	0.345	/	

	DSI3	OFDM BPSK		Back Side	10	507000	2535	270	50	0	0.08	0.356	20.90	21.00	1.023	<b>0.364</b>	38#
	DSI3			Left	10	512000	2560	270	1	53	-0.10	0.052	20.95	21.00	1.012	0.053	/
	DSI3			Edge	10	507000	2510	270	50	0	-0.13	0.058	20.90	21.00	1.023	0.059	/
	DSI3			Right	10	512000	2560	270	1	53	-0.02	0.211	20.95	21.00	1.012	0.214	/
	DSI3			Edge	10	507000	2510	270	50	0	0.16	0.206	20.90	21.00	1.023	0.211	/
	DSI3			Bottom	10	512000	2560	270	1	53	0.06	0.274	20.95	21.00	1.012	0.277	/
	DSI3			Edge	10	507000	2535	270	50	0	0.07	0.269	20.90	21.00	1.023	0.275	/

Note: Refer to ANNEX C for the detailed test data for each test configuration.

Ant.enna	Power Reduction	Mode	Information	Position	Dist. (mm)	Ch.	Freq. (MHz)	RB UL	RB Num.	RB Start	Power Drift (dB)	10 g Meas SAR (W/kg)	Meas. Power (dBm)	Max. tune-power (dBm)	Scaling Factor	10g Scaled SAR (W/kg)	Meas. No.
<b>Specific</b>																	
Ant.4	DSI4	DFT-s-	SA	Back	0	507000	2535	270	1	104	-0.08	0.556	16.87	17.00	1.030	0.573	/
	DSI4			Side	0	507000	2535	270	50	28	0.14	0.587	16.93	17.00	1.016	<b>0.596</b>	39#
	DSI4	OFDM		Top	0	507000	2535	270	1	104	-0.16	0.534	16.87	17.00	1.030	0.550	/
	DSI4			BPSK	Edge	0	507000	2535	270	50	28	0.08	0.541	16.93	17.00	1.016	0.550

Note: Refer to ANNEX C for the detailed test data for each test configuration.

Ant.enna	Power Reduction	Mode	Information	Position	Dist. (mm)	Ch.	Freq. (MHz)	RB Num.	RB Start	Power Drift (dB)	1 g Meas SAR (W/kg)	Meas. Power (dBm)	Max. tune-power (dBm)	Scaling Factor	1g Scaled SAR (W/kg)	Meas. No.	
<b>Body N-1</b>																	
Ant.4	DSI2	DFT-s-OFDM	SA	Front Side	15	512000	2560	1	1	-0.05	0.258	24.59	25.00	1.099	0.284	/	
	DSI2			Front Side	15	507000	2535	50	56	0.18	0.275	24.44	25.00	1.138	0.313	/	
	DSI2			Back Side	15	512000	2560	1	1	0.19	0.565	24.59	25.00	1.099	0.621	/	
	DSI2			Back Side	15	507000	2535	50	56	0.17	0.578	24.44	25.00	1.138	0.658	/	
	DSI2			Top Edge	15	512000	2560	1	1	-0.06	0.694	24.59	25.00	1.099	0.763	/	
	DSI2			Top Edge	15	507000	2535	50	56	-0.18	0.746	24.44	25.00	1.138	0.849	/	
Ant.1	DSI2	DFT-s-OFDM	SA	Front Side	15	502000	2510	1	53	0.14	0.283	22.49	22.50	1.002	0.284	/	
	DSI2			Front Side	15	507000	2535	50	0	0.15	0.312	22.07	22.50	1.104	0.344	/	
	DSI2			Back Side	15	502000	2510	1	53	0.09	0.524	22.49	22.50	1.002	0.525	/	
	DSI2			Back Side	15	507000	2535	50	0	-0.04	0.536	22.07	22.50	1.104	0.592	/	
	DSI2			Bottom Edge	15	502000	2510	1	53	-0.06	0.412	22.49	22.50	1.002	0.413	/	
	DSI2			Bottom Edge	15	507000	2535	50	0	-0.12	0.428	22.07	22.50	1.104	0.473	/	

Note: Refer to ANNEX C for the detailed test data for each test configuration.



### 11.16 n38 (40MHz Bandwidth)

Ant.enna	Power Reduction	Mode	Information	Position	Dist. (mm)	Ch.	Freq. (MHz)	RB UL	RB Num.	RB Start	Power Drift (dB)	1 g Meas SAR (W/kg)	Meas. Power (dBm)	Max. tune-power (dBm)	Scaling Factor	1g Scaled SAR (W/kg)	Meas. No.		
<b>Head</b>																			
Ant.4	DSI1	DFT-s-OFDM	SA	Left	0	519000	2595	106	1	1	0.17	0.411	16.18	16.50	1.076	0.442	/		
	DSI1			Cheek	0	518000	2590	106	50	0	-0.16	0.423	15.59	16.50	1.233	0.522	/		
	DSI1			Left Tilt	0	519000	2595	106	1	1	0.01	0.454	16.18	16.50	1.076	0.489	/		
	DSI1				0	518000	2590	106	50	0	-0.01	0.443	15.59	16.50	1.233	0.546	/		
	DSI1			BPSK	SA	Right	0	519000	2595	106	1	1	-0.10	0.533	16.18	16.50	1.076	0.574	/
	DSI1					Cheek	0	518000	2590	106	50	0	0.12	0.545	15.59	16.50	1.233	0.672	/
	DSI1			Right	0	519000	2595	106	1	1	0.01	0.623	16.18	16.50	1.076	0.670	/		
	DSI1				Tilt	0	518000	2590	106	50	0	-0.02	0.612	15.59	16.50	1.233	<b>0.755</b>	40#	
Ant.1	DSI1	DFT-s-OFDM	SA	Left	0	520000	2600	106	1	53	-0.10	0.222	25.17	25.50	1.079	0.240	/		
	DSI1			Cheek	0	520000	2590	106	50	28	-0.02	0.216	25.30	25.50	1.047	0.226	/		
	DSI1			Left Tilt	0	520000	2600	106	1	53	0.09	0.189	25.17	25.50	1.079	0.204	/		
	DSI1				0	520000	2590	106	50	28	-0.19	0.171	25.30	25.50	1.047	0.179	/		
	DSI1			BPSK	SA	Right	0	520000	2600	106	1	53	0.08	0.341	25.17	25.50	1.079	0.368	/
	DSI1					Cheek	0	520000	2590	106	50	28	0.13	0.327	25.30	25.50	1.047	0.342	/
	DSI1			Right	0	520000	2600	106	1	53	0.18	0.092	25.17	25.50	1.079	0.099	/		
	DSI1				Tilt	0	520000	2590	106	50	28	0.06	0.094	25.30	25.50	1.047	0.098	/	
<b>Body-worn&amp;Hotspot</b>																			
Ant.4	DSI4	DFT-s-OFDM	SA	Front	10	519000	2595	106	1	53	-0.17	0.161	17.32	17.50	1.042	0.168	/		
	DSI4			Side	10	519000	2595	106	50	0	-0.16	0.153	17.41	17.50	1.021	0.156	/		
	DSI4			Back	10	519000	2595	106	1	53	0.12	0.371	17.32	17.50	1.042	0.387	/		
	DSI4				10	519000	2595	106	50	0	-0.03	0.374	17.41	17.50	1.021	0.382	/		
	DSI4			BPSK	SA	Left	10	519000	2600	106	1	53	0.06	0.154	17.32	17.50	1.042	0.160	/
	DSI4					Edge	10	519000	2600	106	50	0	0.00	0.143	17.41	17.50	1.021	0.146	/
	DSI4			Top	10	519000	2595	106	1	53	0.18	0.390	17.32	17.50	1.042	<b>0.406</b>	41#		
	DSI4				Edge	10	519000	2595	106	50	0	0.08	0.388	17.41	17.50	1.021	0.396	/	
Ant.1	DSI3	DFT-s-OFDM	SA	Front	10	518000	2590	106	1	1	-0.08	0.158	19.69	20.00	1.074	0.170	/		
	DSI3			Side	10	518000	2590	106	50	28	-0.04	0.166	19.80	20.00	1.047	0.174	/		
	DSI3			Back	10	518000	2590	106	1	1	-0.06	0.331	19.69	20.00	1.074	0.355	/		
	DSI3				10	518000	2590	106	50	28	-0.12	0.311	19.80	20.00	1.047	0.326	/		
	DSI3			Left	10	518000	2595	106	1	53	0.01	0.064	19.69	20.00	1.074	0.069	/		
	DSI3				Edge	10	518000	2600	106	50	0	0.19	0.062	19.80	20.00	1.047	0.065	/	
	DSI3			BPSK	SA	Right	10	518000	2595	106	1	53	-0.13	0.264	19.69	20.00	1.074	0.284	/
	DSI3					Edge	10	518000	2600	106	50	0	-0.17	0.242	19.80	20.00	1.047	0.253	/
	DSI3			Bottom	10	518000	2590	106	1	1	0.06	0.268	19.69	20.00	1.074	0.288	/		
	DSI3				Edge	10	518000	2590	106	50	28	-0.08	0.267	19.80	20.00	1.047	0.280	/	

Note: Refer to ANNEX C for the detailed test data for each test configuration.

Antenna	Power Reduction	Mode	Information	Position	Dist. (mm)	Ch.	Freq. (MHz)	RB Num.	RB Start	Power Drift (dB)	1 g Meas SAR (W/kg)	Meas. Power (dBm)	Max. tune-power (dBm)	Scaling Factor	1g Scaled SAR (W/kg)	Meas. No.
<b>Body N-1</b>																
Ant.4	DSI2	DFT-s-OFDM BPSK	SA	Front Side	15	520000	2600	1	53	0.12	0.066	24.81	25.50	1.172	0.077	/
	DSI2			Front Side	15	520000	2600	50	25	-0.05	0.064	24.58	25.50	1.236	0.079	/
	DSI2			Back Side	15	520000	2600	1	53	0.10	0.143	24.81	25.50	1.172	0.168	/
	DSI2			Back Side	15	520000	2600	50	25	0.05	0.152	24.58	25.50	1.236	0.188	/
	DSI2			Top Edge	15	520000	2600	1	53	0.03	0.196	24.81	25.50	1.172	0.230	/
	DSI2			Top Edge	15	520000	2600	50	25	-0.11	0.199	24.58	25.50	1.236	0.246	/
Ant.1	DSI2	DFT-s-OFDM BPSK	SA	Front Side	15	519000	2595	1	53	0.09	0.192	24.44	24.50	1.014	0.195	/
	DSI2			Front Side	15	518000	2590	50	28	-0.06	0.181	24.41	24.50	1.021	0.185	/
	DSI2			Back Side	15	519000	2595	1	53	0.09	0.390	24.44	24.50	1.014	0.395	/
	DSI2			Back Side	15	518000	2590	50	28	0.05	0.371	24.41	24.50	1.021	0.379	/
	DSI2			Bottom Edge	15	519000	2595	1	53	0.11	0.318	24.44	24.50	1.014	0.322	/
	DSI2			Bottom Edge	15	518000	2590	50	28	0.01	0.300	24.41	24.50	1.021	0.306	/

Note: Refer to ANNEX C for the detailed test data for each test configuration.

### 11.17 n41 (100MHz Bandwidth)

Ant.enna	Power Reduction	Mode	Information	Position	Dist. (mm)	Ch.	Freq. (MHz)	RB UL	RB Num.	RB Start	Power Drift (dB)	1 g Meas SAR (W/kg)	Meas. Power (dBm)	Max. tune-power (dBm)	Scaling Factor	1g Scaled SAR (W/kg)	Meas. No.		
<b>Head</b>																			
Ant.4	DSI1	DFT-s-OFDM	SA	Left	0	518598	2592.99	273	1	271	-0.19	0.369	16.47	16.50	1.007	0.372	/		
	DSI1			Cheek	0	518598	2592.99	273	135	69	0.00	0.401	16.46	16.50	1.009	0.405	/		
	DSI1			Left Tilt	0	518598	2592.99	273	1	271	-0.07	0.398	16.47	16.50	1.007	0.401	/		
	DSI1				0	518598	2592.99	273	135	69	-0.16	0.485	16.46	16.50	1.009	0.489	/		
	DSI1			BPSK	SA	Right	0	518598	2592.99	273	1	271	-0.16	0.512	16.47	16.50	1.007	0.516	/
	DSI1					Cheek	0	518598	2592.99	273	135	69	-0.19	0.553	16.46	16.50	1.009	0.558	/
	DSI1			Right	0	518598	2592.99	273	1	271	0.12	0.542	16.47	16.50	1.007	0.546	/		
	DSI1				Tilt	0	518598	2592.99	273	135	69	-0.02	0.653	16.46	16.50	1.009	<b>0.659</b>	42#	
Ant.1	DSI1	DFT-s-OFDM	SA	Left	0	509202	2546.01	273	1	271	-0.03	0.200	24.33	25.50	1.309	0.262	/		
	DSI1			Cheek	0	509202	2546.01	273	135	0	0.13	0.198	24.35	25.50	1.303	0.258	/		
	DSI1			Left Tilt	0	509202	2546.01	273	1	271	0.06	0.182	24.33	25.50	1.309	0.238	/		
	DSI1				0	509202	2546.01	273	135	0	-0.01	0.161	24.35	25.50	1.303	0.210	/		
	DSI1			BPSK	SA	Right	0	509202	2546.01	273	1	271	-0.12	0.341	24.33	25.50	1.309	0.446	/
	DSI1					Cheek	0	509202	2546.01	273	135	0	0.19	0.305	24.35	25.50	1.303	0.397	/
	DSI1			Right	0	509202	2546.01	273	1	271	-0.05	0.099	24.33	25.50	1.309	0.130	/		
	DSI1				Tilt	0	509202	2546.01	273	135	0	0.12	0.092	24.35	25.50	1.303	0.120	/	
<b>Body-worn&amp;Hotspot</b>																			
Ant.4	DSI4	DFT-s-OFDM	SA	Front	10	528000	2640	273	1	1	0.18	0.144	17.43	17.50	1.016	0.146	/		
	DSI4			Side	10	518598	2592.99	273	135	0	-0.05	0.135	17.47	17.50	1.007	0.136	/		
	DSI4			Back	10	528000	2640	273	1	1	0.11	0.312	17.43	17.50	1.016	0.317	/		
	DSI4				10	518598	2592.99	273	135	0	-0.19	0.345	17.47	17.50	1.007	0.347	/		
	DSI4			BPSK	SA	Left	10	528000	2546.01	273	1	137	0.01	0.145	17.43	17.50	1.016	0.147	/
	DSI4					Edge	10	518598	2546.01	273	135	0	0.03	0.135	17.47	17.50	1.007	0.136	/
	DSI4			Top	10	528000	2640	273	1	1	0.13	0.331	17.43	17.50	1.016	0.336	/		
	DSI4				Edge	10	518598	2592.99	273	135	0	-0.09	0.377	17.47	17.50	1.007	<b>0.380</b>	43#	
Ant.1	DSI3	DFT-s-OFDM	SA	Front	10	518598	2592.99	273	1	271	-0.07	0.165	19.99	20.00	1.002	0.165	/		
	DSI3			Side	10	518598	2592.99	273	135	69	0.09	0.140	19.96	20.00	1.009	0.141	/		
	DSI3			Back	10	518598	2592.99	273	1	271	-0.17	0.308	19.99	20.00	1.002	0.309	/		
	DSI3				10	518598	2592.99	273	135	69	-0.01	0.297	19.96	20.00	1.009	0.300	/		
	DSI3			Left	10	518598	2640	273	1	271	0.19	0.053	19.99	20.00	1.002	0.053	/		
	DSI3				Edge	10	518598	2640	273	135	0	0.12	0.047	19.96	20.00	1.009	0.047	/	
	DSI3			BPSK	SA	Right	10	518598	2592.99	273	1	271	0.09	0.216	19.99	20.00	1.002	0.216	/
	DSI3					Edge	10	518598	2546.01	273	135	0	0.04	0.205	19.96	20.00	1.009	0.207	/
	DSI3			Bottom	10	518598	2592.99	273	1	271	0.10	0.235	19.99	20.00	1.002	0.235	/		
	DSI3				Edge	10	518598	2592.99	273	135	69	0.18	0.233	19.96	20.00	1.009	0.235	/	

Note: Refer to ANNEX C for the detailed test data for each test configuration.

Antenna	Power Reduction	Mode	Information	Position	Dist. (mm)	Ch.	Freq. (MHz)	RB Num.	RB Start	Power Drift (dB)	1 g Meas SAR (W/kg)	Meas. Power (dBm)	Max. tune-power (dBm)	Scaling Factor	1g Scaled SAR (W/kg)	Meas. No.
<b>Body N-1</b>																
Ant.4	DSI2	DFT-s-OFDM BPSK	SA	Front Side	15	509202	2546.01	1	137	-0.04	0.071	24.48	25.50	1.265	0.090	/
	DSI2			Front Side	15	528000	2592.99	135	0	-0.14	0.066	24.31	25.50	1.315	0.087	/
	DSI2			Back Side	15	509202	2546.01	1	137	0.11	0.165	24.48	25.50	1.265	0.209	/
	DSI2			Back Side	15	518598	2592.99	135	0	0.03	0.150	24.31	25.50	1.315	0.197	/
	DSI2			Top Edge	15	509202	2546.01	1	137	-0.08	0.225	24.48	25.50	1.265	0.285	/
	DSI2			Top Edge	15	518598	2592.99	135	0	-0.09	0.209	24.31	25.50	1.315	0.275	/
Ant.1	DSI2	DFT-s-OFDM BPSK	SA	Front Side	15	518598	2592.99	1	271	-0.02	0.244	24.33	25.50	1.309	0.319	/
	DSI2			Front Side	15	509202	2546.01	135	0	0.06	0.195	24.35	25.50	1.303	0.254	/
	DSI2			Back Side	15	518598	2592.99	1	271	-0.17	0.435	24.33	25.50	1.309	0.569	/
	DSI2			Back Side	15	509202	2546.01	135	0	0.17	0.393	24.35	25.50	1.303	0.512	/
	DSI2			Bottom Edge	15	518598	2592.99	1	271	0.17	0.339	24.33	25.50	1.309	0.444	/
	DSI2			Bottom Edge	15	509202	2546.01	135	0	-0.04	0.312	24.35	25.50	1.303	0.407	/

Note: Refer to ANNEX C for the detailed test data for each test configuration.

### 11.18 n77 (3450-3550MHz) (100MHz Bandwidth)

Ant.enna	Power Reduction	Mode	Information	Position	Dist. (mm)	Ch.	Freq. (MHz)	RB UL	RB Num.	RB Start	Power Drift (dB)	1 g Meas SAR (W/kg)	Meas. Power (dBm)	Max. tune-power (dBm)	Scaling Factor	1g Scaled SAR (W/kg)	Meas. No.		
<b>Head</b>																			
Ant.2	DSI1	DFT-s-OFDM	SA	Left	0	633334	3500.01	273	1	137	-0.13	0.152	16.49	17.00	1.125	0.171	/		
	DSI1			Cheek	0	633334	3500.01	273	135	138	0.10	0.163	16.44	17.00	1.138	0.185	/		
	DSI1			Left Tilt	0	633334	3500.01	273	1	137	0.06	0.158	16.49	17.00	1.125	0.178	/		
	DSI1				0	633334	3500.01	273	135	138	0.15	0.156	16.44	17.00	1.138	0.178	/		
	DSI1			BPSK	SA	Right	0	633334	3500.01	273	1	137	0.18	0.711	16.49	17.00	1.125	0.800	/
	DSI1					Cheek	0	633334	3500.01	273	135	138	-0.12	0.764	16.44	17.00	1.138	<b>0.869</b>	44#
	DSI1			Right	0	633334	3500.01	273	1	137	0.19	0.233	16.49	17.00	1.125	0.262	/		
	DSI1				Tilt	0	633334	3500.01	273	135	138	0.09	0.312	16.44	17.00	1.138	0.355	/	
Ant.3	DSI1	DFT-s-OFDM	SA	Left	0	633334	3500.01	273	1	137	-0.06	0.311	13.49	15.00	1.416	0.440	/		
	DSI1			Cheek	0	633334	3500.01	273	135	0	0.11	0.325	13.34	15.00	1.466	0.476	/		
	DSI1			Left Tilt	0	633334	3500.01	273	1	137	-0.06	0.271	13.49	15.00	1.416	0.384	/		
	DSI1				0	633334	3500.01	273	135	0	-0.01	0.244	13.34	15.00	1.466	0.358	/		
	DSI1			BPSK	SA	Right	0	633334	3500.01	273	1	137	-0.19	0.203	13.49	15.00	1.416	0.287	/
	DSI1					Cheek	0	633334	3500.01	273	135	0	0.00	0.195	13.34	15.00	1.466	0.286	/
	DSI1			Right	0	633334	3500.01	273	1	137	0.16	0.206	13.49	15.00	1.416	0.292	/		
	DSI1				Tilt	0	633334	3500.01	273	135	0	0.04	0.201	13.34	15.00	1.466	0.295	/	
Ant.5	DSI1	DFT-s-OFDM	SA	Left	0	633334	3500.01	273	1	1	0.05	0.173	12.37	13.00	1.156	0.200	/		
	DSI1			Cheek	0	633334	3500.01	273	135	0	0.18	0.206	12.58	13.00	1.102	0.227	/		
	DSI1			Left Tilt	0	633334	3500.01	273	1	1	-0.04	0.055	12.37	13.00	1.156	0.064	/		
	DSI1				0	633334	3500.01	273	135	0	0.09	0.074	12.58	13.00	1.102	0.082	/		
	DSI1			BPSK	SA	Right	0	633334	3500.01	273	1	1	-0.19	0.041	12.37	13.00	1.156	0.047	/
	DSI1					Cheek	0	633334	3500.01	273	135	0	-0.15	0.053	12.58	13.00	1.102	0.058	/
	DSI1			Right	0	633334	3500.01	273	1	1	-0.01	0.021	12.37	13.00	1.156	0.024	/		
	DSI1				Tilt	0	633334	3500.01	273	135	0	0.17	0.035	12.58	13.00	1.102	0.039	/	
Ant.6	DSI1	DFT-s-OFDM	SA	Left	0	633334	3500.01	273	1	1	0.19	0.223	23.51	24.00	1.119	0.250	/		
	DSI1			Cheek	0	633334	3500.01	273	135	69	0.03	0.265	23.53	24.00	1.114	0.295	/		
	DSI1			Left Tilt	0	633334	3500.01	273	1	1	0.10	0.134	23.51	24.00	1.119	0.150	/		
	DSI1				0	633334	3500.01	273	135	69	0.04	0.146	23.53	24.00	1.114	0.163	/		
	DSI1			BPSK	SA	Right	0	633334	3500.01	273	1	1	-0.08	0.141	23.51	24.00	1.119	0.158	/
	DSI1					Cheek	0	633334	3500.01	273	135	69	-0.13	0.163	23.53	24.00	1.114	0.182	/
	DSI1			Right	0	633334	3500.01	273	1	1	-0.17	0.171	23.51	24.00	1.119	0.191	/		
	DSI1				Tilt	0	633334	3500.01	273	135	69	0.02	0.234	23.53	24.00	1.114	0.261	/	
<b>Body-worn&amp;Hotspot</b>																			
Ant.2	DSI4	DFT-s-	SA	Front	10	633334	3500.01	273	1	137	-0.04	0.112	16.49	17.00	1.125	0.126	/		
	DSI4			Side	10	633334	3500.01	273	135	138	0.04	0.121	16.44	17.00	1.138	0.138	/		
	DSI4			10	633334	3500.01	273	1	137	-0.04	0.413	16.49	17.00	1.125	0.465	/			

	DSI4	OFDM BPSK		Back Side	10	633334	3500.01	273	135	138	0.02	0.374	16.44	17.00	1.138	0.426	/
	DSI4			Left	10	633334	3500.01	273	1	137	-0.14	0.422	16.49	17.00	1.125	0.475	/
	DSI4			Edge	10	633334	3500.01	273	135	138	0.12	0.474	16.44	17.00	1.138	0.539	/
	DSI4			Top	10	633334	3500.01	273	1	137	-0.04	0.113	16.49	17.00	1.125	0.127	/
	DSI4			Edge	10	633334	3500.01	273	135	138	0.01	0.121	16.44	17.00	1.138	0.138	/
Ant.3	DSI2	DFT- s- OFDM BPSK	SA	Front	10	633334	3500.01	273	1	137	-0.15	0.403	19.60	21.00	1.380	0.556	/
	DSI2			Side	10	633334	3500.01	273	135	0	0.13	0.394	19.31	21.00	1.476	0.582	/
	DSI2			Back	10	633334	3500.01	273	1	137	-0.06	0.463	19.60	21.00	1.380	0.639	/
	DSI2			Side	10	633334	3500.01	273	135	0	0.12	0.497	19.31	21.00	1.476	<b>0.734</b>	<b>45#</b>
	DSI2			Left	10	633334	3500.01	273	1	137	-0.12	0.034	19.60	21.00	1.380	0.047	/
	DSI2			Edge	10	633334	3500.01	273	135	0	0.17	0.041	19.31	21.00	1.476	0.061	/
	DSI2			Right	10	633334	3500.01	273	1	137	0.18	0.203	19.60	21.00	1.380	0.280	/
	DSI2			Edge	10	633334	3500.01	273	135	0	-0.19	0.211	19.31	21.00	1.476	0.311	/
	DSI2			Top	10	633334	3500.01	273	1	137	-0.16	0.442	19.60	21.00	1.380	0.610	/
	DSI2			Edge	10	633334	3500.01	273	135	0	0.05	0.413	19.31	21.00	1.476	0.610	/
Ant.5	DSI2	DFT- s- OFDM BPSK	SA	Front	10	633334	3500.01	273	1	137	-0.16	0.072	17.54	18.00	1.112	0.080	/
	DSI2			Side	10	633334	3500.01	273	135	0	-0.13	0.085	17.68	18.00	1.076	0.091	/
	DSI2			Back	10	633334	3500.01	273	1	137	-0.15	0.088	17.54	18.00	1.112	0.098	/
	DSI2			Side	10	633334	3500.01	273	135	0	-0.10	0.123	17.68	18.00	1.076	0.132	/
	DSI2			Right	10	633334	3500.01	273	1	137	-0.02	0.129	17.54	18.00	1.112	0.143	/
	DSI2			Edge	10	633334	3500.01	273	135	0	0.15	0.193	17.68	18.00	1.076	0.208	/
	DSI2			Top	10	633334	3500.01	273	1	137	-0.10	0.026	17.54	18.00	1.112	0.029	/
	DSI2			Edge	10	633334	3500.01	273	135	0	0.18	0.042	17.68	18.00	1.076	0.045	/
Ant.6	DSI2	DFT- s- OFDM BPSK	SA	Front	10	633334	3500.01	273	1	1	-0.10	0.068	19.36	20.00	1.159	0.079	/
	DSI2			Side	10	633334	3500.01	273	135	138	0.17	0.079	19.55	20.00	1.109	0.088	/
	DSI2			Back	10	633334	3500.01	273	1	1	-0.05	0.305	19.36	20.00	1.159	0.353	/
	DSI2			Side	10	633334	3500.01	273	135	138	-0.19	0.388	19.55	20.00	1.109	0.430	/
	DSI2			Left	10	633334	3500.01	273	1	1	-0.13	0.322	19.36	20.00	1.159	0.373	/
	DSI2			Edge	10	633334	3500.01	273	135	138	0.10	0.449	19.55	20.00	1.109	0.498	/
	DSI2			Bottom	10	633334	3500.01	273	1	1	-0.04	0.099	19.36	20.00	1.159	0.115	/
	DSI2			Edge	10	633334	3500.01	273	135	138	-0.12	0.103	19.55	20.00	1.109	0.114	/
Note: Refer to ANNEX C for the detailed test data for each test configuration.																	

Ant.enna	Power Reduction	Mode	Information	Position	Dist. (mm)	Ch.	Freq. (MHz)	RB UL	RB Num.	RB Start	Power Dirft	10g Meas SAR (W/kg)	Meas. Power (dBm)	Max. tune-power (dBm)	Scaling Factor	10g Scaled SAR (W/kg)	Meas. No.
Specific																	
Ant.2	DSI4	DFT-s-OFDM	SA	Back	0	633334	3500.01	273	1	137	0.19	1.510	16.49	17.00	1.125	1.699	/
	DSI4			Side	0	633334	3500.01	273	135	138	0.09	1.630	16.44	17.00	1.138	<b>1.855</b>	46#
	DSI4	Left		0	633334	3500.01	273	1	137	0.02	1.110	16.49	17.00	1.125	1.249	/	
	DSI4	BPSK		Edge	0	633334	3500.01	273	135	138	0.05	1.220	16.44	17.00	1.138	1.388	/
Ant.3	DSI2	DFT-s-OFDM	SA	Front	0	633334	3500.01	273	1	137	0.02	0.890	19.60	21.00	1.380	1.228	/
	DSI2			Side	0	633334	3500.01	273	135	0	0.15	0.850	19.31	21.00	1.476	1.255	/
	DSI2			Back	0	633334	3500.01	273	1	137	-0.05	1.220	19.60	21.00	1.380	1.684	/
	DSI2			Side	0	633334	3500.01	273	135	0	-0.03	1.210	19.31	21.00	1.476	1.786	/
	DSI2	BPSK		Right	0	633334	3500.01	273	1	137	0.09	0.536	19.60	21.00	1.380	0.740	/
	DSI2			Edge	0	633334	3500.01	273	135	0	0.07	0.556	19.31	21.00	1.476	0.821	/
	DSI2			Top	0	633334	3500.01	273	1	137	0.19	1.220	19.60	21.00	1.380	1.684	/
	DSI2			Edge	0	633334	3500.01	273	135	0	-0.02	1.160	19.31	21.00	1.476	1.712	/
Ant.6	DSI2	DFT-s-OFDM	SA	Back	0	633334	3500.01	273	1	1	-0.12	1.150	19.36	20.00	1.159	1.333	/
	DSI2			Side	0	633334	3500.01	273	135	138	0.01	1.250	19.55	20.00	1.109	1.386	/
	DSI2	Left		0	633334	3500.01	273	1	1	-0.14	0.900	19.36	20.00	1.159	1.043	/	
	DSI2	BPSK		Edge	0	633334	3500.01	273	135	138	-0.01	1.100	19.55	20.00	1.109	1.220	/
Note: Refer to ANNEX C for the detailed test data for each test configuration.																	

### 11.19 n77 (3700-3980MHz) (100MHz Bandwidth)

Ant.enna	Power Reduction	Mode	Information	Position	Dist. (mm)	Ch.	Freq. (MHz)	RB UL	RB Num.	RB Start	Power Dirft	1g Meas SAR (W/kg)	Meas. Power (dBm)	Max. tune-power (dBm)	Scaling Factor	1g Scaled SAR (W/kg)	Meas. No.	
<b>Head</b>																		
Ant.2	DSI1	DFT-s-OFDM	BPSK	SA	Left	0	656000	3840	273	1	1	-0.14	0.253	16.55	17.00	1.109	0.281	/
					Cheek	0	662000	3930	273	135	69	0.17	0.221	16.84	17.00	1.038	0.229	/
					Left Tilt	0	656000	3840	273	1	1	-0.01	0.206	16.55	17.00	1.109	0.228	/
						0	662000	3930	273	135	69	0.08	0.188	16.84	17.00	1.038	0.195	/
					Right	0	656000	3840	273	1	1	-0.15	0.771	16.55	17.00	1.109	<b>0.855</b>	47#
					Cheek	0	662000	3930	273	135	69	0.02	0.756	16.84	17.00	1.038	0.785	/
					Right	0	656000	3840	273	1	1	-0.18	0.423	16.55	17.00	1.109	0.469	/
					Tilt	0	662000	3930	273	135	69	-0.04	0.374	16.84	17.00	1.038	0.388	/
					Right	0	650000	3750	273	1	1	0.16	0.743	16.55	17.00	1.109	0.824	/
					Cheek	0	662000	3930	273	135	69	-0.14	0.722	16.84	17.00	1.038	0.749	/
Ant.3	DSI1	DFT-s-OFDM	BPSK	SA	Left	0	662000	3930	273	1	137	0.18	0.362	13.98	15.00	1.265	0.458	/
					Cheek	0	656000	3840	273	135	0	0.05	0.399	14.17	15.00	1.211	0.483	/
					Left Tilt	0	662000	3930	273	1	137	0.05	0.347	13.98	15.00	1.265	0.439	/
						0	656000	3840	273	135	0	0.05	0.423	14.17	15.00	1.211	0.512	/
					Right	0	662000	3930	273	1	137	0.12	0.241	13.98	15.00	1.265	0.305	/
					Cheek	0	656000	3840	273	135	0	-0.15	0.243	14.17	15.00	1.211	0.294	/
					Right	0	662000	3930	273	1	137	0.17	0.295	13.98	15.00	1.265	0.373	/
					Tilt	0	656000	3840	273	135	0	0.01	0.274	14.17	15.00	1.211	0.332	/
					Left Tilt	0	650000	3750	273	1	137	-0.13	0.385	13.98	15.00	1.265	0.487	/
						0	662000	3930	273	135	0	0.04	0.392	14.17	15.00	1.211	0.475	/
Ant.5	DSI1	DFT-s-OFDM	BPSK	SA	Left	0	656000	3840	273	1	137	0.10	0.311	12.52	13.00	1.117	0.347	/
					Cheek	0	656000	3840	273	135	138	-0.17	0.345	12.80	13.00	1.047	0.361	/
					Left Tilt	0	656000	3840	273	1	137	0.07	0.135	12.52	13.00	1.117	0.151	/
						0	656000	3840	273	135	138	0.02	0.141	12.80	13.00	1.047	0.148	/
					Right	0	656000	3840	273	1	137	-0.16	0.063	12.52	13.00	1.117	0.070	/
					Cheek	0	656000	3840	273	135	138	0.19	0.071	12.80	13.00	1.047	0.074	/
					Right	0	656000	3840	273	1	137	0.04	0.053	12.52	13.00	1.117	0.059	/
					Tilt	0	656000	3840	273	135	138	0.06	0.062	12.80	13.00	1.047	0.065	/
Ant.6	DSI1	DFT-s-OFDM	BPSK	SA	Left	0	650000	3750	273	1	1	0.10	0.121	23.55	24.00	1.109	0.134	/
					Cheek	0	656000	3840	273	135	69	0.05	0.132	23.36	24.00	1.159	0.153	/
					Left Tilt	0	650000	3750	273	1	1	-0.14	0.071	23.55	24.00	1.109	0.079	/
						0	656000	3840	273	135	69	-0.13	0.078	23.36	24.00	1.159	0.090	/
					Right	0	656000	3840	273	1	1	-0.15	0.098	23.55	24.00	1.109	0.109	/
					Cheek	0	656000	3840	273	135	69	0.09	0.101	23.36	24.00	1.159	0.117	/
					Right	0	650000	3750	273	1	1	0.08	0.073	23.55	24.00	1.109	0.081	/
					Tilt	0	656000	3840	273	135	69	0.01	0.093	23.36	24.00	1.159	0.108	/



Body-worn&Hotspot																	
Ant.2	DSI4	DFT- s- OFDM BPSK	SA	Front	10	656000	3840	273	1	1	0.17	0.121	16.55	17.00	1.109	0.134	/
	DSI4			Side	10	662000	3930	273	135	69	0.11	0.083	16.84	17.00	1.038	0.086	/
	DSI4			Back	10	656000	3840	273	1	1	-0.06	0.422	16.55	17.00	1.109	0.468	/
	DSI4			Side	10	662000	3930	273	135	69	-0.03	0.374	16.84	17.00	1.038	0.388	/
	DSI4			Left	10	656000	3840	273	1	1	-0.09	0.455	16.55	17.00	1.109	0.505	/
	DSI4			Edge	10	662000	3930	273	135	69	-0.08	0.382	16.84	17.00	1.038	0.397	/
	DSI4			Top	10	656000	3840	273	1	1	0.02	0.121	16.55	17.00	1.109	0.134	/
	DSI4			Edge	10	662000	3930	273	135	69	-0.12	0.103	16.84	17.00	1.038	0.107	/
Ant.3	DSI2	DFT- s- OFDM BPSK	SA	Front	10	662000	3930	273	1	1	0.17	0.382	20.19	21.00	1.205	0.460	/
	DSI2			Side	10	656000	3840	273	135	0	-0.05	0.341	20.15	21.00	1.216	0.415	/
	DSI2			Back	10	662000	3930	273	1	1	-0.14	0.693	20.19	21.00	1.205	0.835	/
	DSI2			Side	10	656000	3840	273	135	0	-0.12	0.655	20.15	21.00	1.216	0.796	/
	DSI2			Left	10	662000	3930	273	1	1	-0.08	0.048	20.19	21.00	1.205	0.058	/
	DSI2			Edge	10	656000	3840	273	135	0	-0.03	0.052	20.15	21.00	1.216	0.063	/
	DSI2			Right	10	662000	3930	273	1	1	-0.09	0.374	20.19	21.00	1.205	0.451	/
	DSI2			Edge	10	656000	3840	273	135	0	-0.14	0.362	20.15	21.00	1.216	0.440	/
	DSI2			Top	10	662000	3930	273	1	1	-0.10	0.871	20.19	21.00	1.205	<b>1.050</b>	<b>48#</b>
	DSI2			Edge	10	656000	3840	273	135	0	0.01	0.821	20.15	21.00	1.216	0.998	/
	DSI2			Edge	10	650000	3750	273	1	137	0.11	0.633	19.49	21.00	1.416	0.896	/
	DSI2			Edge	10	656000	3840	273	1	271	0.17	0.728	19.91	21.00	1.285	0.935	/
Ant.5	DSI2	DFT- s- OFDM BPSK	SA	Front	10	656000	3840	273	1	137	0.17	0.112	17.51	18.00	1.119	0.125	/
	DSI2			Side	10	662000	3930	273	135	69	-0.05	0.103	17.67	18.00	1.079	0.111	/
	DSI2			Back	10	656000	3840	273	1	137	0.17	0.375	17.51	18.00	1.119	0.420	/
	DSI2			Side	10	662000	3930	273	135	69	-0.10	0.363	17.67	18.00	1.079	0.392	/
	DSI2			Right	10	656000	3840	273	1	137	0.00	0.466	17.51	18.00	1.119	0.521	/
	DSI2			Edge	10	662000	3930	273	135	69	0.13	0.423	17.67	18.00	1.079	0.456	/
	DSI2			Top	10	656000	3840	273	1	137	-0.18	0.121	17.51	18.00	1.119	0.135	/
	DSI2			Edge	10	662000	3930	273	135	69	0.10	0.117	17.67	18.00	1.079	0.126	/
Ant.6	DSI2	DFT- s- OFDM BPSK	SA	Front	10	650000	3750	273	1	271	-0.15	0.046	19.53	20.00	1.114	0.051	/
	DSI2			Side	10	656000	3840	273	135	69	0.15	0.000	19.47	20.00	1.130	0.000	/
	DSI2			Back	10	650000	3750	273	1	271	0.14	0.265	19.53	20.00	1.114	0.295	/
	DSI2			Side	10	656000	3840	273	135	69	-0.03	0.224	19.47	20.00	1.130	0.253	/
	DSI2			Left	10	650000	3750	273	1	271	0.15	0.275	19.53	20.00	1.114	0.306	/
	DSI2			Edge	10	656000	3840	273	135	69	0.15	0.233	19.47	20.00	1.130	0.263	/
	DSI2			Bottom	10	650000	3750	273	1	271	-0.14	0.071	19.53	20.00	1.114	0.079	/
	DSI2			Edge	10	656000	3840	273	135	69	-0.11	0.056	19.47	20.00	1.130	0.063	/
	DSI2			Back	10	656000	3750	273	1	271	0.03	0.193	19.53	20.00	1.114	0.215	/
	DSI2			Side	10	662000	3930	273	135	69	0.12	0.221	19.47	20.00	1.130	0.250	/

Note: Refer to ANNEX C for the detailed test data for each test configuration.

Ant.enna	Power Reduction	Mode	Information	Position	Dist. (mm)	Ch.	Freq. (MHz)	RB UL	RB Num.	RB Start	Power Drift (dB)	10 g Meas SAR (W/kg)	Meas. Power (dBm)	Max. tune-power (dBm)	Scaling Factor	10g Scaled SAR (W/kg)	Meas. No.
Specific																	
Ant.2	DSI4	DFT-s-OFDM	SA	Back	0	656000	3840	273	1	1	0.06	1.060	16.55	17.00	1.109	1.176	/
	DSI4			Side	0	662000	3930	273	135	69	-0.19	1.050	16.84	17.00	1.038	1.090	/
	DSI4	Left		0	656000	3840	273	1	1	-0.03	1.100	16.55	17.00	1.109	<b>1.220</b>	49#	
	DSI4	BPSK		Edge	0	662000	3930	273	135	69	0.00	0.996	16.84	17.00	1.038	1.034	/
Ant.3	DSI2	DFT-s-OFDM	SA	Front	0	662000	3930	273	1	1	0.07	0.721	20.05	21.00	1.245	0.898	/
	DSI2			Side	0	656000	3840	273	135	0	-0.03	0.662	20.15	21.00	1.216	0.805	/
	DSI2			Back	0	662000	3930	273	1	1	0.18	0.946	20.05	21.00	1.245	1.178	/
	DSI2			Side	0	656000	3840	273	135	0	0.13	0.965	20.15	21.00	1.216	1.173	/
	DSI2	BPSK		Right	0	662000	3930	273	1	1	0.17	0.422	20.05	21.00	1.245	0.525	/
	DSI2			Edge	0	656000	3840	273	135	0	-0.07	0.422	20.15	21.00	1.216	0.513	/
	DSI2			Top	0	662000	3930	273	1	1	-0.07	0.946	20.05	21.00	1.245	1.178	/
	DSI2			Edge	0	656000	3840	273	135	0	-0.13	0.986	20.15	21.00	1.216	1.199	/
Ant.5	DSI2	DFT-s-OFDM	SA	Back	0	656000	3840	273	1	137	0.11	0.559	17.51	18.00	1.119	0.626	/
	DSI2			Side	0	656000	3840	273	135	69	0.18	0.332	17.67	18.00	1.079	0.358	/
	DSI2	Right		0	656000	3840	273	1	137	-0.12	0.995	17.51	18.00	1.119	1.113	/	
	DSI2	BPSK		Edge	0	656000	3840	273	135	69	-0.01	0.853	17.67	18.00	1.079	0.920	/
Note: Refer to ANNEX C for the detailed test data for each test configuration.																	

### 11.20 n78 (3450-3550MHz) (100MHz Bandwidth)

Ant.enna	Power Reduction	Mode	Information	Position	Dist. (mm)	Ch.	Freq. (MHz)	RB UL	RB Num.	RB Start	Power Drift (dB)	1 g Meas SAR (W/kg)	Meas. Power (dBm)	Max. tune-power (dBm)	Scaling Factor	1g Scaled SAR (W/kg)	Meas. No.	
<b>Head</b>																		
Ant.2	DSI1	DFT-s-OFDM	SA	Left	0	633334	3500.01	273	1	1	-0.10	0.148	16.39	16.50	1.026	0.152	/	
					Cheek	0	633334	3500.01	273	135	0	-0.02	0.158	16.37	16.50	1.030	0.163	/
				Left Tilt	0	633334	3500.01	273	1	1	-0.04	0.155	16.39	16.50	1.026	0.159	/	
					0	633334	3500.01	273	135	0	-0.14	0.168	16.37	16.50	1.030	0.173	/	
				Right	0	633334	3500.01	273	1	1	-0.06	0.610	16.39	16.50	1.026	0.626	/	
					Cheek	0	633334	3500.01	273	135	0	0.02	0.605	16.37	16.50	1.030	0.623	/
				Right	0	633334	3500.01	273	1	1	-0.13	0.305	16.39	16.50	1.026	0.313	/	
					Tilt	0	633334	3500.01	273	135	0	-0.14	0.335	16.37	16.50	1.030	0.345	/
Ant.3	DSI1	DFT-s-OFDM	SA	Left	0	633334	3500.01	273	1	1	0.18	0.535	14.67	15.00	1.079	0.577	/	
					Cheek	0	633334	3500.01	273	135	69	0.02	0.523	14.66	15.00	1.081	0.565	/
				Left Tilt	0	633334	3500.01	273	1	1	-0.11	0.581	14.67	15.00	1.079	<b>0.627</b>	50#	
					0	633334	3500.01	273	135	69	0.12	0.565	14.66	15.00	1.081	0.611	/	
				Right	0	633334	3500.01	273	1	1	0.07	0.352	14.67	15.00	1.079	0.380	/	
					Cheek	0	633334	3500.01	273	135	69	-0.08	0.368	14.66	15.00	1.081	0.398	/
				Right	0	633334	3500.01	273	1	1	0.07	0.425	14.67	15.00	1.079	0.459	/	
					Tilt	0	633334	3500.01	273	135	69	-0.17	0.411	14.66	15.00	1.081	0.444	/
Ant.5	DSI1	DFT-s-OFDM	SA	Left	0	633334	3500.01	273	1	1	-0.07	0.250	14.55	15.00	1.109	0.277	/	
					Cheek	0	633334	3500.01	273	135	138	0.17	0.340	14.40	15.00	1.148	0.390	/
				Left Tilt	0	633334	3500.01	273	1	1	0.00	0.093	14.55	15.00	1.109	0.103	/	
					0	633334	3500.01	273	135	138	-0.17	0.130	14.40	15.00	1.148	0.149	/	
				Right	0	633334	3500.01	273	1	1	0.00	0.057	14.55	15.00	1.109	0.063	/	
					Cheek	0	633334	3500.01	273	135	138	0.15	0.075	14.40	15.00	1.148	0.086	/
				Right	0	633334	3500.01	273	1	1	0.06	0.038	14.55	15.00	1.109	0.042	/	
					Tilt	0	633334	3500.01	273	135	138	0.05	0.051	14.40	15.00	1.148	0.059	/
Ant.6	DSI1	DFT-s-OFDM	SA	Left	0	633334	3500.01	273	1	1	0.14	0.221	23.37	24.00	1.156	0.255	/	
					Cheek	0	633334	3500.01	273	135	138	-0.02	0.248	23.38	24.00	1.153	0.286	/
				Left Tilt	0	633334	3500.01	273	1	1	-0.06	0.107	23.37	24.00	1.156	0.124	/	
					0	633334	3500.01	273	135	138	0.16	0.139	23.38	24.00	1.153	0.160	/	
				Right	0	633334	3500.01	273	1	1	0.09	0.133	23.37	24.00	1.156	0.154	/	
					Cheek	0	633334	3500.01	273	135	138	0.17	0.175	23.38	24.00	1.153	0.202	/
				Right	0	633334	3500.01	273	1	1	0.09	0.179	23.37	24.00	1.156	0.207	/	
					Tilt	0	633334	3500.01	273	135	138	-0.17	0.209	23.38	24.00	1.153	0.241	/
<b>Body-worn&amp;Hotspot</b>																		
Ant.2	DSI4	DFT-s-	SA	Front	10	633334	3500.01	273	1	1	0.16	0.079	15.39	16.50	1.291	0.102	/	
					Side	10	633334	3500.01	273	135	0	-0.09	0.080	15.61	16.50	1.227	0.098	/
					10	633334	3500.01	273	1	1	0.10	0.349	15.39	16.50	1.291	0.451	/	

	DSI4	OFDM BPSK		Back Side	10	633334	3500.01	273	135	0	-0.15	0.359	15.61	16.50	1.227	0.440	/
	DSI4			Left	10	633334	3500.01	273	1	1	0.19	0.381	15.39	16.50	1.291	0.492	/
	DSI4			Edge	10	633334	3500.01	273	135	0	0.16	0.402	15.61	16.50	1.227	0.493	/
	DSI4			Top	10	633334	3500.01	273	1	1	0.15	0.084	15.39	16.50	1.291	0.108	/
	DSI4			Edge	10	633334	3500.01	273	135	0	-0.08	0.090	15.61	16.50	1.227	0.110	/
Ant.3	DSI2	DFT- s- OFDM BPSK	SA	Front	10	633334	3500.01	273	1	137	0.08	0.146	16.82	17.00	1.042	0.152	/
	DSI2			Side	10	633334	3500.01	273	135	138	-0.17	0.218	16.77	17.00	1.054	0.230	/
	DSI2			Back	10	633334	3500.01	273	1	137	-0.02	0.521	16.82	17.00	1.042	0.543	/
	DSI2			Side	10	633334	3500.01	273	135	138	0.06	0.533	16.77	17.00	1.054	<b>0.562</b>	51#
	DSI2			Left	10	633334	3500.01	273	1	137	0.08	0.052	16.82	17.00	1.042	0.054	/
	DSI2			Edge	10	633334	3500.01	273	135	138	0.09	0.038	16.77	17.00	1.054	0.040	/
	DSI2			Right	10	633334	3500.01	273	1	137	-0.12	0.098	16.82	17.00	1.042	0.102	/
	DSI2			Edge	10	633334	3500.01	273	135	138	-0.02	0.088	16.77	17.00	1.054	0.093	/
	DSI2			Top	10	633334	3500.01	273	1	137	0.06	0.256	16.82	17.00	1.042	0.267	/
	DSI2			Edge	10	633334	3500.01	273	135	138	-0.18	0.399	16.77	17.00	1.054	0.421	/
Ant.5	DSI2	DFT- s- OFDM BPSK	SA	Front	10	633334	3500.01	273	1	137	0.12	0.101	19.52	20.00	1.117	0.113	/
	DSI2			Side	10	633334	3500.01	273	135	0	-0.10	0.134	19.64	20.00	1.086	0.146	/
	DSI2			Back	10	633334	3500.01	273	1	137	0.13	0.136	19.52	20.00	1.117	0.152	/
	DSI2			Side	10	633334	3500.01	273	135	0	-0.01	0.182	19.64	20.00	1.086	0.198	/
	DSI2			Right	10	633334	3500.01	273	1	137	-0.14	0.200	19.52	20.00	1.117	0.223	/
	DSI2			Edge	10	633334	3500.01	273	135	0	0.11	0.275	19.64	20.00	1.086	0.299	/
	DSI2			Top	10	633334	3500.01	273	1	137	-0.17	0.060	19.52	20.00	1.117	0.067	/
	DSI2			Edge	10	633334	3500.01	273	135	0	-0.11	0.068	19.64	20.00	1.086	0.074	/
Ant.6	DSI2	DFT- s- OFDM BPSK	SA	Front	10	633334	3500.01	273	1	1	0.15	0.046	19.34	20.00	1.164	0.054	/
	DSI2			Side	10	633334	3500.01	273	135	69	-0.15	0.053	19.46	20.00	1.132	0.060	/
	DSI2			Back	10	633334	3500.01	273	1	1	-0.09	0.216	19.34	20.00	1.164	0.251	/
	DSI2			Side	10	633334	3500.01	273	135	69	-0.04	0.241	19.46	20.00	1.132	0.273	/
	DSI2			Left	10	633334	3500.01	273	1	1	0.04	0.224	19.34	20.00	1.164	0.261	/
	DSI2			Edge	10	633334	3500.01	273	135	69	0.06	0.257	19.46	20.00	1.132	0.291	/
	DSI2			Bottom	10	633334	3500.01	273	1	1	0.17	0.066	19.34	20.00	1.164	0.077	/
	DSI2			Edge	10	633334	3500.01	273	135	69	0.17	0.068	19.46	20.00	1.132	0.077	/
Note: Refer to ANNEX C for the detailed test data for each test configuration.																	

Ant.enna	Power Reduction	Mode	Information	Position	Dist. (mm)	Ch.	Freq. (MHz)	RB UL	RB Num.	RB Start	Power Drift (dB)	10 g Meas SAR (W/kg)	Meas. Power (dBm)	Max. tune-power (dBm)	Scaling Factor	10g Scaled SAR (W/kg)	Meas. No.
Specific																	
Ant.2	DSI4	DFT-s-	SA	Back	0	633334	3500.01	273	1	1	0.07	1.730	15.39	16.50	1.291	2.233	/
	DSI4			Side	0	633334	3500.01	273	135	0	0.15	1.850	15.61	16.50	1.227	<b>2.270</b>	52#
	DSI4	OFDM		Left	0	633334	3500.01	273	1	1	0.03	1.280	15.39	16.50	1.291	1.652	/
	DSI4	BPSK		Edge	0	633334	3500.01	273	135	0	-0.16	1.320	15.61	16.50	1.227	1.620	/
Ant.3	DSI2	DFT-s-	SA	Front	0	633334	3500.01	273	1	137	0.00	0.943	15.60	17.00	1.380	1.301	/
	DSI2			Side	0	633334	3500.01	273	135	138	0.05	0.987	15.51	17.00	1.409	1.391	/
	DSI2	OFDM		Back	0	633334	3500.01	273	1	137	0.11	1.160	15.60	17.00	1.380	1.601	/
	DSI2			Side	0	633334	3500.01	273	135	138	0.10	1.440	15.51	17.00	1.409	2.029	/
	DSI2	BPSK		Top	0	633334	3500.01	273	1	137	-0.15	1.260	15.60	17.00	1.380	1.739	/
	DSI2			Edge	0	633334	3500.01	273	135	138	0.14	1.300	15.51	17.00	1.409	1.832	/
Note: Refer to ANNEX C for the detailed test data for each test configuration.																	

### 11.21 n78 (3700-3980MHz) (100MHz Bandwidth)

Ant.enna	Power Reduction	Mode	Information	Position	Dist. (mm)	Ch.	Freq. (MHz)	RB UL	RB Num.	RB Start	Power Drift (dB)	1 g Meas SAR (W/kg)	Meas. Power (dBm)	Max. tune-power (dBm)	Scaling Factor	1g Scaled SAR (W/kg)	Meas. No.		
<b>Head</b>																			
Ant.2	DSI1	DFT-s-OFDM	SA	Left	0	650000	3750	273	1	1	-0.13	0.166	16.28	16.50	1.052	0.175	/		
	DSI1			Cheek	0	650000	3750	273	135	69	-0.17	0.171	16.28	16.50	1.052	0.180	/		
	DSI1			Left Tilt	0	650000	3750	273	1	1	-0.06	0.199	16.28	16.50	1.052	0.209	/		
	DSI1				0	650000	3750	273	135	69	-0.10	0.181	16.28	16.50	1.052	0.190	/		
	DSI1			BPSK	SA	Right	0	650000	3750	273	1	1	0.08	0.753	16.28	16.50	1.052	<b>0.792</b>	53#
	DSI1					Cheek	0	650000	3750	273	135	69	0.13	0.702	16.28	16.50	1.052	0.739	/
	DSI1			Right	0	650000	3750	273	1	1	-0.09	0.370	16.28	16.50	1.052	0.389	/		
	DSI1				Tilt	0	650000	3750	273	135	69	0.05	0.326	16.28	16.50	1.052	0.343	/	
Ant.3	DSI1	DFT-s-OFDM	SA	Left	0	650000	3750	273	1	137	-0.17	0.276	13.62	15.00	1.374	0.379	/		
	DSI1			Cheek	0	650000	3750	273	135	69	-0.19	0.310	13.53	15.00	1.403	0.435	/		
	DSI1			Left Tilt	0	650000	3750	273	1	137	0.18	0.291	13.62	15.00	1.374	0.400	/		
	DSI1				0	650000	3750	273	135	69	0.04	0.276	13.53	15.00	1.403	0.387	/		
	DSI1			BPSK	SA	Right	0	650000	3750	273	1	137	0.10	0.178	13.62	15.00	1.374	0.245	/
	DSI1					Cheek	0	650000	3750	273	135	69	-0.13	0.177	13.53	15.00	1.403	0.248	/
	DSI1			Right	0	650000	3750	273	1	137	0.15	0.211	13.62	15.00	1.374	0.290	/		
	DSI1				Tilt	0	650000	3750	273	135	69	-0.14	0.210	13.53	15.00	1.403	0.295	/	
Ant.5	DSI1	DFT-s-OFDM	SA	Left	0	650000	3750	273	1	1	0.16	0.475	14.70	15.00	1.072	0.509	/		
	DSI1			Cheek	0	650000	3750	273	135	0	-0.01	0.473	14.77	15.00	1.054	0.499	/		
	DSI1			Left Tilt	0	650000	3750	273	1	1	0.14	0.183	14.70	15.00	1.072	0.196	/		
	DSI1				0	650000	3750	273	135	0	0.11	0.166	14.77	15.00	1.054	0.175	/		
	DSI1			BPSK	SA	Right	0	650000	3750	273	1	1	0.09	0.102	14.70	15.00	1.072	0.109	/
	DSI1					Cheek	0	650000	3750	273	135	0	0.00	0.097	14.77	15.00	1.054	0.102	/
	DSI1			Right	0	650000	3750	273	1	1	-0.18	0.086	14.70	15.00	1.072	0.092	/		
	DSI1				Tilt	0	650000	3750	273	135	0	-0.01	0.094	14.77	15.00	1.054	0.099	/	
Ant.6	DSI1	DFT-s-OFDM	SA	Left	0	650000	3750	273	1	1	0.09	0.105	23.32	24.00	1.169	0.123	/		
	DSI1			Cheek	0	650000	3750	273	135	138	0.03	0.083	23.51	24.00	1.119	0.093	/		
	DSI1			Left Tilt	0	650000	3750	273	1	1	-0.01	0.050	23.32	24.00	1.169	0.058	/		
	DSI1				0	650000	3750	273	135	138	0.12	0.047	23.51	24.00	1.119	0.053	/		
	DSI1			BPSK	SA	Right	0	650000	3750	273	1	1	-0.12	0.088	23.32	24.00	1.169	0.103	/
	DSI1					Cheek	0	650000	3750	273	135	138	-0.19	0.068	23.51	24.00	1.119	0.076	/
	DSI1			Right	0	650000	3750	273	1	1	0.19	0.096	23.32	24.00	1.169	0.112	/		
	DSI1				Tilt	0	650000	3750	273	135	138	-0.10	0.062	23.51	24.00	1.119	0.069	/	
<b>Body-worn&amp;Hotspot</b>																			
Ant.2	DSI4	DFT-s-	SA	Front	10	650000	3750	273	1	1	0.05	0.098	16.24	16.50	1.062	0.104	/		
	DSI4			Side	10	650000	3750	273	135	69	0.13	0.105	16.24	16.50	1.062	0.112	/		
	DSI4			10	650000	3750	273	1	1	-0.15	0.438	16.24	16.50	1.062	0.465	/			

	DSI4	OFDM BPSK		Back Side	10	650000	3750	273	135	69	-0.01	0.409	16.24	16.50	1.062	0.434	/
	DSI4			Left	10	650000	3750	273	1	1	0.11	0.464	16.24	16.50	1.062	0.493	/
	DSI4			Edge	10	650000	3750	273	135	69	0.19	0.430	16.24	16.50	1.062	0.457	/
	DSI4			Top	10	650000	3750	273	1	1	0.08	0.117	16.24	16.50	1.062	0.124	/
	DSI4			Edge	10	650000	3750	273	135	69	-0.19	0.104	16.24	16.50	1.062	0.110	/
Ant.3	DSI2	DFT- s- OFDM BPSK	SA	Front	10	650000	3750	273	1	137	-0.16	0.251	16.33	17.00	1.167	0.293	/
	DSI2			Side	10	650000	3750	273	135	0	0.12	0.274	16.50	17.00	1.122	0.307	/
	DSI2			Back	10	650000	3750	273	1	137	-0.16	0.472	16.33	17.00	1.167	0.551	/
	DSI2			Side	10	650000	3750	273	135	0	-0.13	0.497	16.50	17.00	1.122	0.558	/
	DSI2			Left	10	650000	3750	273	1	137	-0.12	0.033	16.33	17.00	1.167	0.039	/
	DSI2			Edge	10	650000	3750	273	135	0	0.00	0.030	16.50	17.00	1.122	0.034	/
	DSI2			Right	10	650000	3750	273	1	137	0.17	0.196	16.33	17.00	1.167	0.229	/
	DSI2			Edge	10	650000	3750	273	135	0	0.08	0.226	16.50	17.00	1.122	0.254	/
	DSI2			Top	10	650000	3750	273	1	137	-0.10	0.375	16.33	17.00	1.167	0.438	/
	DSI2			Edge	10	650000	3750	273	135	0	-0.03	0.365	16.50	17.00	1.122	0.410	/
Ant.5	DSI2	DFT- s- OFDM BPSK	SA	Front	10	650000	3750	273	1	137	0.19	0.255	19.50	20.00	1.122	0.286	/
	DSI2			Side	10	650000	3750	273	135	138	0.02	0.262	19.99	20.00	1.002	0.263	/
	DSI2			Back	10	650000	3750	273	1	137	0.10	0.443	19.50	20.00	1.122	0.497	/
	DSI2			Side	10	650000	3750	273	135	138	-0.10	0.500	19.99	20.00	1.002	0.501	/
	DSI2			Right	10	650000	3750	273	1	137	-0.19	0.730	19.50	20.00	1.122	0.819	/
	DSI2			Edge	10	650000	3750	273	135	138	0.04	0.832	19.99	20.00	1.002	0.834	54#
	DSI2			Top	10	650000	3750	273	1	137	-0.18	0.174	19.50	20.00	1.122	0.195	/
	DSI2			Edge	10	650000	3750	273	135	138	0.19	0.183	19.99	20.00	1.002	0.183	/
Ant.6	DSI2	DFT- s- OFDM BPSK	SA	Front	10	650000	3750	273	1	271	0.19	0.038	19.33	20.00	1.167	0.044	/
	DSI2			Side	10	650000	3750	273	135	0	0.06	0.031	19.61	20.00	1.094	0.034	/
	DSI2			Back	10	650000	3750	273	1	271	-0.03	0.173	19.33	20.00	1.167	0.202	/
	DSI2			Side	10	650000	3750	273	135	0	0.19	0.161	19.61	20.00	1.094	0.176	/
	DSI2			Left	10	650000	3750	273	1	271	-0.19	0.166	19.33	20.00	1.167	0.194	/
	DSI2			Edge	10	650000	3750	273	135	0	-0.02	0.165	19.61	20.00	1.094	0.181	/
	DSI2			Bottom	10	650000	3750	273	1	271	0.12	0.067	19.33	20.00	1.167	0.078	/
	DSI2			Edge	10	650000	3750	273	135	0	0.16	0.075	19.61	20.00	1.094	0.082	/
Note: Refer to ANNEX C for the detailed test data for each test configuration.																	

Antenna	Power Reduction	Mode	Information	Position	Dist. (mm)	Ch.	Freq. (MHz)	RB UL	RB Num.	RB Start	Power Drift (dB)	10 g Meas SAR (W/kg)	Meas. Power (dBm)	Max. tune-power (dBm)	Scaling Factor	10g Scaled SAR (W/kg)	Meas. No.
Specific																	
Ant.2	DSI4	DFT-s-	SA	Back	0	650000	3750	273	1	1	0.07	1.630	16.24	16.50	1.062	1.731	/
	DSI4			Side	0	650000	3750	273	135	69	-0.10	1.220	16.24	16.50	1.062	1.296	/
	DSI4	OFDM		Left	0	650000	3750	273	1	1	0.03	0.856	16.24	16.50	1.062	0.909	/
	DSI4	BPSK		Edge	0	650000	3750	273	135	69	-0.16	0.776	16.24	16.50	1.062	0.824	/
Ant.3	DSI2	DFT-s-	SA	Front	0	650000	3750	273	1	137	0.00	0.805	15.59	17.00	1.384	1.114	/
	DSI2			Side	0	650000	3750	273	135	138	0.05	0.810	15.57	17.00	1.390	1.126	/
	DSI2	OFDM		Back	0	650000	3750	273	1	137	0.11	1.290	15.59	17.00	1.384	1.785	/
	DSI2			Side	0	650000	3750	273	135	138	0.10	1.140	15.57	17.00	1.390	1.585	/
	DSI2	BPSK		Top	0	650000	3750	273	1	137	-0.15	1.480	15.59	17.00	1.384	2.048	/
	DSI2			Edge	0	650000	3750	273	135	138	0.14	1.480	15.57	17.00	1.390	2.057	/
Ant.5	DSI2	DFT-s-	SA	Back	0	650000	3750	273	1	137	-0.03	0.521	19.50	20.00	1.122	0.585	/
	DSI2			Side	0	650000	3750	273	135	138	0.05	0.516	19.91	20.00	1.021	0.527	/
	DSI2	OFDM		Right	0	650000	3750	273	1	137	-0.11	2.140	19.50	20.00	1.122	<b>2.401</b>	55#
	DSI2	BPSK		Edge	0	650000	3750	273	135	138	0.10	2.090	19.91	20.00	1.021	2.134	/

Note: Refer to ANNEX C for the detailed test data for each test configuration.



### 11.22 WIFI 2.4GHZ

Mode	Antenna	DSI State	Position	Dist. (mm)	Ch.	Freq. (MHz)	Power Setting	Power Drift (dB)	1 g Meas SAR (W/kg)	Meas. Power (dBm)	Max. tune-up power (dBm)	Scaling Factor	Duty cycle (%)	Duty cycle Factor	1g Report SAR (W/kg)	Meas. No.
<b>Head</b>																
802.11 b	ANT7	DSI1	Left Cheek	0	11	2462	14.5	0.02	0.450	15.09	15.50	1.099	98.01	1.020	<b>0.504</b>	56#
		DSI1	Left Tilt	0	11	2462	14.5	0.04	0.310	15.09	15.50	1.099	98.01	1.020	0.348	/
		DSI1	Right Cheek	0	11	2462	14.5	0.14	0.172	15.09	15.50	1.099	98.01	1.020	0.193	/
		DSI1	Right Tilt	0	11	2462	14.5	-0.1	0.158	15.09	15.50	1.099	98.01	1.020	0.177	/
<b>Body-worn&amp;Hotspot</b>																
802.11 b	ANT7	DSI4	Front Side	10	11	2462	14.5	0.03	0.067	15.09	15.50	1.099	98.01	1.020	0.075	/
		DSI4	Back Side	10	11	2462	14.5	0.11	0.094	15.09	15.50	1.099	98.01	1.020	<b>0.105</b>	57#
		DSI4	Left Edge	10	11	2462	14.5	-0.01	0.016	15.09	15.50	1.099	98.01	1.020	0.018	/
		DSI4	Right Edge	10	11	2462	14.5	0.14	0.049	15.09	15.50	1.099	98.01	1.020	0.055	/
		DSI4	Top Edge	10	11	2462	14.5	0.15	0.047	15.09	15.50	1.099	98.01	1.020	0.053	/
		DSI4	Bottom Edge	10	11	2462	14.5	-0.14	0.009	15.09	15.50	1.099	98.01	1.020	0.010	/
Note: Refer to ANNEX C for the detailed test data for each test configuration.																

### 11.23 WIFI 5GHz

Band	Mode	Antenna	DSI State	Position	Dist. (mm)	Ch.	Freq. (MHz)	Power Setting	Power Drift (dB)	1 g Meas SAR (W/kg)	Meas. Power (dBm)	Max. tune-up power (dBm)	Scaling Factor	Duty cycle (%)	Duty cycle Factor	1g Report SAR (W/kg)	Meas. No.
<b>Head</b>																	
5.3G	802.11n 20	ANT7	DSI1	Left Cheek	0	64	5320	12	0.02	0.308	12.65	14.00	1.365	97.94	1.021	0.429	/
			DSI1	Left Tilt	0	64	5320	12	0.04	0.361	12.65	14.00	1.365	97.94	1.021	<b>0.503</b>	58#
			DSI1	Right Cheek	0	64	5320	12	0.11	0.145	12.65	14.00	1.365	97.94	1.021	0.202	/
			DSI1	Right Tilt	0	64	5320	12	0.09	0.191	12.65	14.00	1.365	97.94	1.021	0.266	/
5.6G	802.11a c40	ANT7	DSI1	Left Cheek	0	142	5710	12	0.07	0.094	12.44	14.00	1.432	96.75	1.034	0.139	/
			DSI1	Left Tilt	0	142	5710	12	0.05	0.218	12.44	14.00	1.432	96.75	1.034	<b>0.323</b>	59#
			DSI1	Right Cheek	0	142	5710	12	0.02	0.077	12.44	14.00	1.432	96.75	1.034	0.114	/
			DSI1	Right Tilt	0	142	5710	12	0.03	0.096	12.44	14.00	1.432	96.75	1.034	0.142	/
5.8G	802.11a c80	ANT7	DSI1	Left Cheek	0	155	5775	10.5	-0.07	0.039	9.50	10.00	1.122	93.28	1.072	0.047	/
			DSI1	Left Tilt	0	155	5775	10.5	0.09	0.080	9.50	10.00	1.122	93.28	1.072	<b>0.096</b>	60#
			DSI1	Right Cheek	0	155	5775	10.5	0.09	0.031	9.50	10.00	1.122	93.28	1.072	0.037	/
			DSI1	Right Tilt	0	155	5775	10.5	-0.11	0.034	9.50	10.00	1.122	93.28	1.072	0.041	/
<b>Body-worn</b>																	
5.3G	802.11n 20	ANT7	DSI4	Front Side	10	64	5320	16	0.11	0.166	16.16	17.50	1.361	96.75	1.034	0.234	/
			DSI4	Back Side	10	64	5320	16	0.09	0.419	16.16	17.50	1.361	96.75	1.034	<b>0.590</b>	61#
5.6G	802.11a c40	ANT7	DSI4	Front Side	10	142	5710	16	0.08	0.112	16.86	17.50	1.159	96.75	1.034	0.134	/
			DSI4	Back Side	10	142	5710	16	-0.07	0.277	16.86	17.50	1.159	96.75	1.034	<b>0.332</b>	62#
<b>Hotspot</b>																	
5.2G	802.11a c40	ANT7	DSI4	Front Side	10	46	5230	16	0.19	0.130	16.55	17.50	1.245	96.75	1.034	0.167	/
			DSI4	Back Side	10	46	5230	16	0.04	0.352	16.55	17.50	1.245	96.75	1.034	0.453	/
			DSI4	Left Edge	10	46	5230	16	0.04	0.137	16.55	17.50	1.245	96.75	1.034	0.176	/
			DSI4	Right Edge	10	46	5230	16	0.17	0.109	16.55	17.50	1.245	96.75	1.034	0.140	/
			DSI4	Top Edge	10	46	5230	16	-0.16	0.411	16.55	17.50	1.245	96.75	1.034	<b>0.529</b>	63#
			DSI4	Bottom Edge	10	46	5230	16	0.07	0.034	16.55	17.50	1.245	96.75	1.034	0.044	/
5.8G	802.11a c80	ANT7	DSI4	Front Side	10	155	5775	12.5	-0.19	0.033	11.95	13.50	1.429	93.28	1.072	0.051	/
			DSI4	Back Side	10	155	5775	12.5	-0.08	0.077	11.95	13.50	1.429	93.28	1.072	0.118	/
			DSI4	Left Edge	10	155	5775	12.5	-0.18	0.012	11.95	13.50	1.429	93.28	1.072	0.018	/
			DSI4	Right Edge	10	155	5775	12.5	0.12	0.011	11.95	13.50	1.429	93.28	1.072	0.017	/
			DSI4	Top Edge	10	155	5775	12.5	-0.08	0.079	11.95	13.50	1.429	93.28	1.072	<b>0.121</b>	64#
			DSI4	Bottom Edge	10	155	5775	12.5	0.1	0.016	11.95	13.50	1.429	93.28	1.072	0.025	/
Note: Refer to ANNEX C for the detailed test data for each test configuration.																	

Band	Mode	Antenna	DSI State	Position	Dist. (mm)	Ch.	Freq. (MHz)	Power Setting	Power Drift (dB)	10g Meas SAR (W/kg)	Meas. Power (dBm)	Max. tune-up power (dBm)	Scaling Factor	Duty cycle (%)	Duty cycle Factor	10g Report SAR (W/kg)	Meas. No.
<b>Specific</b>																	
5.3G	802.11n 20	ANT7	DSI4	Front Side	0	64	5320	16	-0.06	0.368	16.16	17.50	1.361	97.94	1.021	0.511	/
			DSI4	Back Side	0	64	5320	16	0.04	0.536	16.16	17.50	1.361	97.94	1.021	0.745	/
			DSI4	Left Edge	0	64	5320	16	-0.08	0.076	16.16	17.50	1.361	97.94	1.021	0.106	/
			DSI4	Right Edge	0	64	5320	16	-0.04	0.194	16.16	17.50	1.361	97.94	1.021	0.270	/
			DSI4	Top Edge	0	64	5320	16	-0.01	1.050	16.16	17.50	1.361	97.94	1.021	<b>1.459</b>	65#
			DSI4	Bottom Edge	0	64	5320	16	-0.16	0.006	16.16	17.50	1.361	97.94	1.021	0.008	/
5.6G	802.11a c40	ANT7	DSI4	Front Side	0	142	5710	16	-0.09	0.173	16.86	17.50	1.159	96.75	1.034	0.207	/
			DSI4	Back Side	0	142	5710	16	0.14	0.342	16.86	17.50	1.159	96.75	1.034	0.410	/
			DSI4	Left Edge	0	142	5710	16	-0.11	0.051	16.86	17.50	1.159	96.75	1.034	0.061	/
			DSI4	Right Edge	0	142	5710	16	0.03	0.118	16.86	17.50	1.159	96.75	1.034	0.141	/
			DSI4	Top Edge	0	142	5710	16	0.03	0.879	16.86	17.50	1.159	96.75	1.034	<b>1.053</b>	66#
			DSI4	Bottom Edge	0	142	5710	16	-0.03	0.005	16.86	17.50	1.159	96.75	1.034	0.006	/

Note: Refer to ANNEX C for the detailed test data for each test configuration.

## 11.24 Bluetooth

Mode	Antenna	Position	Dist. (mm)	Ch.	Freq. (MHz)	Power Drift (dB)	1 g Meas SAR (W/kg)	Meas. Power (dBm)	Max. tune power (dBm)	Scaling Factor	Duty cycle (%)	Duty cycle Factor	1g Report SAR (W/kg)	Meas. No.
<b>Head</b>														
DH5	ANT7	Left Cheek	0	0	2402	0.03	0.086	8.08	10.00	1.556	76.88	1.301	<b>0.174</b>	67#
		Left Tilt	0	0	2402	-0.11	0.076	8.08	10.00	1.556	76.88	1.301	0.154	/
		Right Cheek	0	0	2402	0.18	0.009	8.08	10.00	1.556	76.88	1.301	0.018	/
		Right Tilt	0	0	2402	0.09	0.016	8.08	10.00	1.556	76.88	1.301	0.032	/
<b>Body-worn&amp;Hotspot</b>														
DH5	ANT7	Front Side	10	0	2402	0.11	0.008	8.08	10.00	1.556	76.88	1.301	0.016	/
		Back Side	10	0	2402	0.15	0.019	8.08	10.00	1.556	76.88	1.301	<b>0.038</b>	68#
		Left Edge	10	0	2402	0.08	0.006	8.08	10.00	1.556	76.88	1.301	0.012	/
		Right Edge	10	0	2402	0.05	0.003	8.08	10.00	1.556	76.88	1.301	0.006	/
		Top Edge	10	0	2402	-0.03	0.011	8.08	10.00	1.556	76.88	1.301	0.022	/
		Bottom Edge	10	0	2402	0.03	0.002	8.08	10.00	1.556	76.88	1.301	0.004	/
Note: Refer to ANNEX C for the detailed test data for each test configuration.														

## 12 SAR Measurement Variability

According to KDB 865664 D01, SAR measurement variability was assessed for each frequency band, which is determined by the SAR probe calibration point and tissue-equivalent medium used for the device measurements. When both head and body tissue-equivalent media are required for SAR measurements in a frequency band, the variability measurement procedures should be applied to the tissue medium with the highest measured SAR, using the highest measured SAR configuration for that tissue-equivalent medium. Alternatively, if the highest measured SAR for both head and body tissue-equivalent media are  $\leq 1.45$  W/kg and the ratio of these highest SAR values, i.e., largest divided by smallest value, is  $\leq 1.10$ , the highest SAR configuration for either head or body tissue-equivalent medium may be used to perform the repeated measurement. These additional measurements are repeated after the completion of all measurements requiring the same head or body tissue-equivalent medium in a frequency band. The test device should be returned to ambient conditions (normal room temperature) with the battery fully charged before it is re-mounted on the device holder for the repeated measurement(s) to minimize any unexpected variations in the repeated results.

SAR repeated measurement procedure:

1. When the highest measured SAR is  $< 0.80$  W/kg, repeated measurement is not required.
2. When the highest measured SAR is  $\geq 0.80$  W/kg, repeat that measurement once.
3. If the ratio of largest to smallest SAR for the original and first repeated measurements is  $> 1.20$ , or when the original or repeated measurement is  $\geq 1.45$  W/kg, perform a second repeated measurement.
4. If the ratio of largest to smallest SAR for the original, first and second repeated measurements is  $> 1.20$ , and the original, first or second repeated measurement is  $\geq 1.5$  W/kg, perform a third repeated measurement.

Frequency Band (MHz)	Wireless Band	RF Exposure Conditions	Test Position	Highest Measured SAR (W/kg)	Repeated SAR (Yes/No)	Repeated <sup>1st</sup> Measured SAR (W/kg)	Largest to Smallest SAR Ratio
2510	NR n7	Head	Right Cheek	0.866	Yes	0.844	1.03
3930	NR n77 (3700-3980MHz)	Body-worn&Hotspot	Top Edge	0.871	Yes	0.856	1.02
3750	NR n78 (3700-3980MHz)	Body-worn&Hotspot	Right Edge	0.832	Yes	0.826	1.01
3750	NR n78 (3700-3980MHz)	Specific	Right Edge	2.14	Yes	2.06	1.04

Note: The ratio of largest to smallest SAR for the original and first repeated measurements is  $< 1.20$ , the second repeated measurement. is not required.

## 13 SIMULTANEOUS TRANSMISSION

Simultaneous transmission SAR test exclusion is determined for each operating configuration and exposure condition according to the reported standalone SAR of each applicable simultaneous transmitting antenna. When the sum of SAR 1g of all simultaneously transmitting antennas in an operating mode and exposure condition combination is within the SAR limit (SAR 1g 1.6 W/kg), the simultaneous transmission SAR is not required. When the sum of SAR 1g is greater than the SAR limit (SAR 1g 1.6 W/kg), SAR test exclusion is determined by the SAR to Peak Location Ratio (SPLSR).

### 13.1 Simultaneous Transmission Mode Consider

No.	Simultaneous Tx Combination	Head	Body-worn	Hotspot	Specific
1	WWAN+2.4G WiFi	Yes	Yes	Yes	Yes
2	WWAN+5G WiFi+BT	Yes	Yes	Yes	Yes

Note:

1. Two WWAN antennas can switch automatically, but two WWAN antenna can't transmit simultaneously.
2. The maximum SAR summation is calculated based on the same configuration and test position.
3. The simultaneous transmission combinations of the more antennas contain combinations of less antennas, so only the worst simultaneous transmission combinations is shown in this report.

## 13.2 Sum SAR of Simultaneous Transmission

### 13.2.1 Head Simultaneous Transmission SAR Evaluation for WWAN Antenna with WLAN and Bluetooth

Band	Antenna	Position	Stand alone SAR				SUM SAR	
			1	2	3	4	Sum SAR (1+2)	Sum SAR (1+3+4)
			WWAN	2.4GWIFI	5GWIFI (MAX)	Bluetooth		
GSM850	ANT4	Left Cheek	0.424	0.504	0.429	0.174	0.928	1.027
	ANT4	Left Tilt	0.368	0.348	0.503	0.154	0.716	1.025
	ANT4	Right Cheek	0.519	0.193	0.202	0.018	0.712	0.739
	ANT4	Right Tilt	0.561	0.177	0.266	0.032	0.738	0.859
GSM850	ANT1	Left Cheek	0.160	0.504	0.429	0.174	0.664	0.763
	ANT1	Left Tilt	0.087	0.348	0.503	0.154	0.435	0.744
	ANT1	Right Cheek	0.161	0.193	0.202	0.018	0.354	0.381
	ANT1	Right Tilt	0.089	0.177	0.266	0.032	0.266	0.387
GSM1900	ANT4	Left Cheek	0.278	0.504	0.429	0.174	0.782	0.881
	ANT4	Left Tilt	0.225	0.348	0.503	0.154	0.573	0.882
	ANT4	Right Cheek	0.464	0.193	0.202	0.018	0.657	0.684
	ANT4	Right Tilt	0.335	0.177	0.266	0.032	0.512	0.633
GSM1900	ANT1	Left Cheek	0.046	0.504	0.429	0.174	0.550	0.649
	ANT1	Left Tilt	0.026	0.348	0.503	0.154	0.374	0.683
	ANT1	Right Cheek	0.039	0.193	0.202	0.018	0.232	0.259
	ANT1	Right Tilt	0.023	0.177	0.266	0.032	0.200	0.321
WCDMA B2	ANT4	Left Cheek	0.150	0.504	0.429	0.174	0.654	0.753
	ANT4	Left Tilt	0.144	0.348	0.503	0.154	0.492	0.801
	ANT4	Right Cheek	0.251	0.193	0.202	0.018	0.444	0.471
	ANT4	Right Tilt	0.207	0.177	0.266	0.032	0.384	0.505
WCDMA B2	ANT1	Left Cheek	0.054	0.504	0.429	0.174	0.558	0.657
	ANT1	Left Tilt	0.043	0.348	0.503	0.154	0.391	0.700
	ANT1	Right Cheek	0.029	0.193	0.202	0.018	0.222	0.249
	ANT1	Right Tilt	0.019	0.177	0.266	0.032	0.196	0.317
WCDMA B4	ANT4	Left Cheek	0.191	0.504	0.429	0.174	0.695	0.794
	ANT4	Left Tilt	0.145	0.348	0.503	0.154	0.493	0.802
	ANT4	Right Cheek	0.309	0.193	0.202	0.018	0.502	0.529
	ANT4	Right Tilt	0.210	0.177	0.266	0.032	0.387	0.508
WCDMA B4	ANT1	Left Cheek	0.019	0.504	0.429	0.174	0.523	0.622
	ANT1	Left Tilt	0.012	0.348	0.503	0.154	0.360	0.669
	ANT1	Right Cheek	0.017	0.193	0.202	0.018	0.210	0.237
	ANT1	Right Tilt	0.010	0.177	0.266	0.032	0.187	0.308
WCDMA B5	ANT4	Left Cheek	0.150	0.504	0.429	0.174	0.654	0.753

	ANT4	Left Tilt	0.123	0.348	0.503	0.154	0.471	0.780
	ANT4	Right Cheek	0.176	0.193	0.202	0.018	0.369	0.396
	ANT4	Right Tilt	0.143	0.177	0.266	0.032	0.320	0.441
WCDMA B5	ANT1	Left Cheek	0.088	0.504	0.429	0.174	0.592	0.691
	ANT1	Left Tilt	0.050	0.348	0.503	0.154	0.398	0.707
	ANT1	Right Cheek	0.080	0.193	0.202	0.018	0.273	0.300
	ANT1	Right Tilt	0.040	0.177	0.266	0.032	0.217	0.338
LTE B2	ANT4	Left Cheek	0.333	0.504	0.429	0.174	0.837	0.936
	ANT4	Left Tilt	0.287	0.348	0.503	0.154	0.635	0.944
	ANT4	Right Cheek	0.530	0.193	0.202	0.018	0.723	0.750
	ANT4	Right Tilt	0.427	0.177	0.266	0.032	0.604	0.725
LTE B2	ANT1	Left Cheek	0.093	0.504	0.429	0.174	0.597	0.696
	ANT1	Left Tilt	0.040	0.348	0.503	0.154	0.388	0.697
	ANT1	Right Cheek	0.059	0.193	0.202	0.018	0.252	0.279
	ANT1	Right Tilt	0.034	0.177	0.266	0.032	0.211	0.332
LTE B4	ANT4	Left Cheek	0.458	0.504	0.429	0.174	0.962	1.061
	ANT4	Left Tilt	0.369	0.348	0.503	0.154	0.717	1.026
	ANT4	Right Cheek	0.720	0.193	0.202	0.018	0.913	0.940
	ANT4	Right Tilt	0.581	0.177	0.266	0.032	0.758	0.879
LTE B4	ANT1	Left Cheek	0.068	0.504	0.429	0.174	0.572	0.671
	ANT1	Left Tilt	0.031	0.348	0.503	0.154	0.379	0.688
	ANT1	Right Cheek	0.081	0.193	0.202	0.018	0.274	0.301
	ANT1	Right Tilt	0.037	0.177	0.266	0.032	0.214	0.335
LTE B5	ANT4	Left Cheek	0.340	0.504	0.429	0.174	0.844	0.943
	ANT4	Left Tilt	0.297	0.348	0.503	0.154	0.645	0.954
	ANT4	Right Cheek	0.537	0.193	0.202	0.018	0.730	0.757
	ANT4	Right Tilt	0.384	0.177	0.266	0.032	0.561	0.682
LTE B5	ANT1	Left Cheek	0.264	0.504	0.429	0.174	0.768	0.867
	ANT1	Left Tilt	0.083	0.348	0.503	0.154	0.431	0.740
	ANT1	Right Cheek	0.155	0.193	0.202	0.018	0.348	0.375
	ANT1	Right Tilt	0.088	0.177	0.266	0.032	0.265	0.386
LTE B7	ANT4	Left Cheek	0.407	0.504	0.429	0.174	0.911	1.010
	ANT4	Left Tilt	0.373	0.348	0.503	0.154	0.721	1.030
	ANT4	Right Cheek	0.411	0.193	0.202	0.018	0.604	0.631
	ANT4	Right Tilt	0.674	0.177	0.266	0.032	0.851	0.972
LTE B7	ANT1	Left Cheek	0.135	0.504	0.429	0.174	0.639	0.738
	ANT1	Left Tilt	0.125	0.348	0.503	0.154	0.473	0.782
	ANT1	Right Cheek	0.212	0.193	0.202	0.018	0.405	0.432
	ANT1	Right Tilt	0.117	0.177	0.266	0.032	0.294	0.415
LTE B38	ANT4	Left Cheek	0.466	0.504	0.429	0.174	0.970	1.069
	ANT4	Left Tilt	0.494	0.348	0.503	0.154	0.842	1.151
	ANT4	Right Cheek	0.993	0.193	0.202	0.018	1.186	1.213
	ANT4	Right Tilt	1.093	0.177	0.266	0.032	1.270	<b>1.391</b>



LTE B38	ANT1	Left Cheek	0.073	0.504	0.429	0.174	0.577	0.676
	ANT1	Left Tilt	0.062	0.348	0.503	0.154	0.410	0.719
	ANT1	Right Cheek	0.124	0.193	0.202	0.018	0.317	0.344
	ANT1	Right Tilt	0.075	0.177	0.266	0.032	0.252	0.373
LTE B41	ANT4	Left Cheek	0.557	0.504	0.429	0.174	1.061	1.160
	ANT4	Left Tilt	0.625	0.348	0.503	0.154	0.973	1.282
	ANT4	Right Cheek	0.897	0.193	0.202	0.018	1.090	1.117
	ANT4	Right Tilt	0.973	0.177	0.266	0.032	1.150	1.271
LTE B41	ANT1	Left Cheek	0.072	0.504	0.429	0.174	0.576	0.675
	ANT1	Left Tilt	0.049	0.348	0.503	0.154	0.397	0.706
	ANT1	Right Cheek	0.098	0.193	0.202	0.018	0.291	0.318
	ANT1	Right Tilt	0.050	0.177	0.266	0.032	0.227	0.348
N5	ANT4	Left Cheek	0.370	0.504	0.429	0.174	0.874	0.973
	ANT4	Left Tilt	0.340	0.348	0.503	0.154	0.688	0.997
	ANT4	Right Cheek	0.398	0.193	0.202	0.018	0.591	0.618
	ANT4	Right Tilt	0.346	0.177	0.266	0.032	0.523	0.644
N5	ANT1	Left Cheek	0.061	0.504	0.429	0.174	0.565	0.664
	ANT1	Left Tilt	0.021	0.348	0.503	0.154	0.369	0.678
	ANT1	Right Cheek	0.045	0.193	0.202	0.018	0.238	0.265
	ANT1	Right Tilt	0.023	0.177	0.266	0.032	0.200	0.321
N7	ANT4	Left Cheek	0.542	0.504	0.429	0.174	1.046	1.145
	ANT4	Left Tilt	0.581	0.348	0.503	0.154	0.929	1.238
	ANT4	Right Cheek	0.936	0.193	0.202	0.018	1.129	1.156
	ANT4	Right Tilt	0.848	0.177	0.266	0.032	1.025	1.146
N7	ANT1	Left Cheek	0.203	0.504	0.429	0.174	0.707	0.806
	ANT1	Left Tilt	0.190	0.348	0.503	0.154	0.538	0.847
	ANT1	Right Cheek	0.301	0.193	0.202	0.018	0.494	0.521
	ANT1	Right Tilt	0.107	0.177	0.266	0.032	0.284	0.405
N38	ANT4	Left Cheek	0.522	0.504	0.429	0.174	1.026	1.125
	ANT4	Left Tilt	0.546	0.348	0.503	0.154	0.894	1.203
	ANT4	Right Cheek	0.672	0.193	0.202	0.018	0.865	0.892
	ANT4	Right Tilt	0.755	0.177	0.266	0.032	0.932	1.053
N38	ANT1	Left Cheek	0.240	0.504	0.429	0.174	0.744	0.843
	ANT1	Left Tilt	0.204	0.348	0.503	0.154	0.552	0.861
	ANT1	Right Cheek	0.368	0.193	0.202	0.018	0.561	0.588
	ANT1	Right Tilt	0.099	0.177	0.266	0.032	0.276	0.397
N41	ANT4	Left Cheek	0.405	0.504	0.429	0.174	0.909	1.008
	ANT4	Left Tilt	0.489	0.348	0.503	0.154	0.837	1.146
	ANT4	Right Cheek	0.558	0.193	0.202	0.018	0.751	0.778
	ANT4	Right Tilt	0.659	0.177	0.266	0.032	0.836	0.957
N41	ANT1	Left Cheek	0.262	0.504	0.429	0.174	0.766	0.865
	ANT1	Left Tilt	0.238	0.348	0.503	0.154	0.586	0.895
	ANT1	Right Cheek	0.446	0.193	0.202	0.018	0.639	0.666

	ANT1	Right Tilt	0.130	0.177	0.266	0.032	0.307	0.428
N77 (3450-3550MHz)	ANT2	Left Cheek	0.185	0.504	0.429	0.174	0.689	0.788
	ANT2	Left Tilt	0.178	0.348	0.503	0.154	0.526	0.835
	ANT2	Right Cheek	0.869	0.193	0.202	0.018	1.062	1.089
	ANT2	Right Tilt	0.355	0.177	0.266	0.032	0.532	0.653
N77 (3450-3550MHz)	ANT3	Left Cheek	0.476	0.504	0.429	0.174	0.980	1.079
	ANT3	Left Tilt	0.358	0.348	0.503	0.154	0.706	1.015
	ANT3	Right Cheek	0.287	0.193	0.202	0.018	0.480	0.507
	ANT3	Right Tilt	0.295	0.177	0.266	0.032	0.472	0.593
N77 (3450-3550MHz)	ANT5	Left Cheek	0.227	0.504	0.429	0.174	0.731	0.830
	ANT5	Left Tilt	0.082	0.348	0.503	0.154	0.430	0.739
	ANT5	Right Cheek	0.058	0.193	0.202	0.018	0.251	0.278
	ANT5	Right Tilt	0.039	0.177	0.266	0.032	0.216	0.337
N77 (3450-3550MHz)	ANT6	Left Cheek	0.295	0.504	0.429	0.174	0.799	0.898
	ANT6	Left Tilt	0.163	0.348	0.503	0.154	0.511	0.820
	ANT6	Right Cheek	0.182	0.193	0.202	0.018	0.375	0.402
	ANT6	Right Tilt	0.261	0.177	0.266	0.032	0.438	0.559
N77 (3700-3980MHz)	ANT2	Left Cheek	0.281	0.504	0.429	0.174	0.785	0.884
	ANT2	Left Tilt	0.228	0.348	0.503	0.154	0.576	0.885
	ANT2	Right Cheek	0.855	0.193	0.202	0.018	1.048	1.075
	ANT2	Right Tilt	0.469	0.177	0.266	0.032	0.646	0.767
N77 (3700-3980MHz)	ANT3	Left Cheek	0.483	0.504	0.429	0.174	0.987	1.086
	ANT3	Left Tilt	0.512	0.348	0.503	0.154	0.860	1.169
	ANT3	Right Cheek	0.305	0.193	0.202	0.018	0.498	0.525
	ANT3	Right Tilt	0.373	0.177	0.266	0.032	0.550	0.671
N77 (3700-3980MHz)	ANT5	Left Cheek	0.361	0.504	0.429	0.174	0.865	0.964
	ANT5	Left Tilt	0.151	0.348	0.503	0.154	0.499	0.808
	ANT5	Right Cheek	0.074	0.193	0.202	0.018	0.267	0.294
	ANT5	Right Tilt	0.065	0.177	0.266	0.032	0.242	0.363
N77 (3700-3980MHz)	ANT6	Left Cheek	0.153	0.504	0.429	0.174	0.657	0.756
	ANT6	Left Tilt	0.090	0.348	0.503	0.154	0.438	0.747
	ANT6	Right Cheek	0.117	0.193	0.202	0.018	0.310	0.337
	ANT6	Right Tilt	0.108	0.177	0.266	0.032	0.285	0.406
N78 (3450-3550MHz)	ANT2	Left Cheek	0.163	0.504	0.429	0.174	0.667	0.766
	ANT2	Left Tilt	0.173	0.348	0.503	0.154	0.521	0.830
	ANT2	Right Cheek	0.626	0.193	0.202	0.018	0.819	0.846
	ANT2	Right Tilt	0.345	0.177	0.266	0.032	0.522	0.643
N78 (3450-3550MHz)	ANT3	Left Cheek	0.566	0.504	0.429	0.174	1.070	1.169
	ANT3	Left Tilt	0.627	0.348	0.503	0.154	0.975	1.284
	ANT3	Right Cheek	0.398	0.193	0.202	0.018	0.591	0.618
	ANT3	Right Tilt	0.459	0.177	0.266	0.032	0.636	0.757
N78 (3450-3550MHz)	ANT5	Left Cheek	0.390	0.504	0.429	0.174	0.894	0.993
	ANT5	Left Tilt	0.149	0.348	0.503	0.154	0.497	0.806

	ANT5	Right Cheek	0.086	0.193	0.202	0.018	0.279	0.306
	ANT5	Right Tilt	0.059	0.177	0.266	0.032	0.236	0.357
N78 (3450-3550MHz)	ANT6	Left Cheek	0.286	0.504	0.429	0.174	0.790	0.889
	ANT6	Left Tilt	0.160	0.348	0.503	0.154	0.508	0.817
	ANT6	Right Cheek	0.202	0.193	0.202	0.018	0.395	0.422
	ANT6	Right Tilt	0.241	0.177	0.266	0.032	0.418	0.539
N78 (3700-3980MHz)	ANT2	Left Cheek	0.180	0.504	0.429	0.174	0.684	0.783
	ANT2	Left Tilt	0.209	0.348	0.503	0.154	0.557	0.866
	ANT2	Right Cheek	0.792	0.193	0.202	0.018	0.985	1.012
	ANT2	Right Tilt	0.389	0.177	0.266	0.032	0.566	0.687
N78 (3700-3980MHz)	ANT3	Left Cheek	0.434	0.504	0.429	0.174	0.938	1.037
	ANT3	Left Tilt	0.399	0.348	0.503	0.154	0.747	1.056
	ANT3	Right Cheek	0.248	0.193	0.202	0.018	0.441	0.468
	ANT3	Right Tilt	0.295	0.177	0.266	0.032	0.472	0.593
N78 (3700-3980MHz)	ANT5	Left Cheek	0.509	0.504	0.429	0.174	1.013	1.112
	ANT5	Left Tilt	0.196	0.348	0.503	0.154	0.544	0.853
	ANT5	Right Cheek	0.109	0.193	0.202	0.018	0.302	0.329
	ANT5	Right Tilt	0.099	0.177	0.266	0.032	0.276	0.397
N78 (3700-3980MHz)	ANT6	Left Cheek	0.123	0.504	0.429	0.174	0.627	0.726
	ANT6	Left Tilt	0.058	0.348	0.503	0.154	0.406	0.715
	ANT6	Right Cheek	0.103	0.193	0.202	0.018	0.296	0.323
	ANT6	Right Tilt	0.112	0.177	0.266	0.032	0.289	0.410

## Note:

- 1: The simultaneous transmission combinations of the three antennas contain combinations of two antennas, so only the worst simultaneous transmission combinations was shown in this table.
- 2: The highest Summed 1g SAR is 1.391 W/Kg < 1.6 W/kg, so Simultaneous Transmission SAR test is not required.

### 13.2.2 Head Simultaneous Transmission SAR Evaluation for WWAN Antenna with WLAN and Bluetooth

Band	Antenna	Band	Antenna	Position	Stand alone SAR						SUM SAR	
					1	2	3	4	5	6	Sum SAR (3+4)	Sum SAR (3+5+6)
					LTE	NR	ENDC	2.4GWIFI	5GWIFI (MAX)	Bluetooth		
LTE B7	ANT2	N5	ANT4	Left Cheek	0.121	0.370	0.491	0.504	0.429	0.174	0.995	1.094
				Left Tilt	0.100	0.340	0.440	0.348	0.503	0.154	0.788	1.097
				Right Cheek	0.627	0.398	1.025	0.193	0.202	0.018	1.218	1.245
				Right Tilt	0.210	0.346	0.556	0.177	0.266	0.032	0.733	0.854
LTE B2	ANT2	N78	ANT3	Left Cheek	0.330	0.566	0.896	0.504	0.429	0.174	1.400	1.499
				Left Tilt	0.219	0.627	0.846	0.348	0.503	0.154	1.194	1.503
				Right Cheek	0.569	0.398	0.967	0.193	0.202	0.018	1.160	1.187
				Right Tilt	0.244	0.459	0.703	0.177	0.266	0.032	0.880	1.001
LTE B5	ANT4	N78	ANT3	Left Cheek	0.340	0.566	0.906	0.504	0.429	0.174	1.410	1.509
				Left Tilt	0.297	0.627	0.924	0.348	0.503	0.154	1.272	<b>1.581</b>
				Right Cheek	0.537	0.398	0.935	0.193	0.202	0.018	1.128	1.155
				Right Tilt	0.384	0.459	0.843	0.177	0.266	0.032	1.020	1.141
LTE B7	ANT2	N78	ANT3	Left Cheek	0.121	0.566	0.687	0.504	0.429	0.174	1.191	1.290
				Left Tilt	0.100	0.627	0.727	0.348	0.503	0.154	1.075	1.384
				Right Cheek	0.627	0.398	1.025	0.193	0.202	0.018	1.218	1.245
				Right Tilt	0.210	0.459	0.669	0.177	0.266	0.032	0.846	0.967
LTE B41	ANT2	N78	ANT3	Left Cheek	0.139	0.566	0.705	0.504	0.429	0.174	1.209	1.308
				Left Tilt	0.130	0.627	0.757	0.348	0.503	0.154	1.105	1.414
				Right Cheek	0.410	0.398	0.808	0.193	0.202	0.018	1.001	1.028
				Right Tilt	0.279	0.459	0.738	0.177	0.266	0.032	0.915	1.036

Note:

1: The simultaneous transmission combinations of the three antennas contain combinations of two antennas, so only the worst simultaneous transmission combinations was shown in this table.

2: The highest Summed 1g SAR is 1.581 W/Kg < 1.6 W/kg, so Simultaneous Transmission SAR test is not required.

### 13.2.3 Head Simultaneous Transmission SAR Evaluation for WWAN Antenna with WLAN and Bluetooth

Band	Antenna	Band	Antenna	Position	Stand alone SAR						SUM SAR	
					1	2	3	4	5	6	Sum SAR (3+4)	Sum SAR (3+5+6)
					LTE PCC	LTE SCC	Intra CA	2.4GWIFI	5GWIFI (MAX)	Bluetooth		
LTE B4	ANT1	LTE B7	ANT2	Left Cheek	0.068	0.121	0.189	0.504	0.474	0.174	0.693	0.837
				Left Tilt	0.031	0.100	0.131	0.348	0.640	0.154	0.479	0.925
				Right Cheek	0.081	0.627	0.708	0.193	0.207	0.018	0.901	<b>0.933</b>
				Right Tilt	0.037	0.210	0.247	0.177	0.260	0.032	0.424	0.539

Note:

1: The simultaneous transmission combinations of the three antennas contain combinations of two antennas, so only the worst simultaneous transmission combinations was shown in this table.

2: The highest Summed 1g SAR is 0.933 W/Kg < 1.6 W/kg, so Simultaneous Transmission SAR test is not required.

### 13.2.4 Hotspot Simultaneous Transmission SAR Evaluation for WWAN Antenna with WLAN and Bluetooth

Band	Antenna	Position	Stand alone SAR				SUM SAR	
			1	2	3	4	Sum SAR (1+2)	Sum SAR (1+3+4)
			WWAN	2.4GWIFI(MAX)	5GWIFI(MAX)	Bluetooth		
GSM850	ANT4	Front Side 10mm	0.154	0.075	0.167	0.016	0.229	0.337
	ANT4	Back Side 10mm	0.203	0.106	0.453	0.039	0.309	0.695
	ANT4	Left Edge 10mm	0.130	0.018	0.176	0.012	0.148	0.318
	ANT4	Top Edge 10mm	0.151	0.053	0.529	0.022	0.204	0.702
GSM850	ANT1	Front Side 10mm	0.156	0.075	0.167	0.016	0.231	0.339
	ANT1	Back Side 10mm	0.238	0.106	0.453	0.039	0.344	0.730
	ANT1	Left Edge 10mm	0.130	0.018	0.176	0.012	0.148	0.318
	ANT1	Right Edge 10mm	0.117	0.055	0.140	0.006	0.172	0.263
	ANT1	Bottom Edge 10mm	0.170	0.010	0.044	0.004	0.180	0.218
GSM1900	ANT4	Front Side 10mm	0.071	0.075	0.167	0.016	0.146	0.254
	ANT4	Back Side 10mm	0.121	0.106	0.453	0.039	0.227	0.613
	ANT4	Left Edge 10mm	0.097	0.018	0.176	0.012	0.115	0.285
	ANT4	Top Edge 10mm	0.086	0.053	0.529	0.022	0.139	0.637
GSM1900	ANT1	Front Side 10mm	0.141	0.075	0.167	0.016	0.216	0.324
	ANT1	Back Side 10mm	0.307	0.106	0.453	0.039	0.413	0.799
	ANT1	Left Edge 10mm	0.050	0.018	0.176	0.012	0.068	0.238
	ANT1	Right Edge 10mm	0.061	0.055	0.140	0.006	0.116	0.207
	ANT1	Bottom Edge 10mm	0.425	0.010	0.044	0.004	0.435	0.473
WCDMA B2	ANT4	Front Side 10mm	0.172	0.075	0.167	0.016	0.247	0.355
	ANT4	Back Side 10mm	0.270	0.106	0.453	0.039	0.376	0.762
	ANT4	Left Edge 10mm	0.277	0.018	0.176	0.012	0.295	0.465
	ANT4	Top Edge 10mm	0.229	0.053	0.529	0.022	0.282	0.780
WCDMA B2	ANT1	Front Side 10mm	0.145	0.075	0.167	0.016	0.220	0.328
	ANT1	Back Side 10mm	0.380	0.106	0.453	0.039	0.486	0.872
	ANT1	Left Edge 10mm	0.063	0.018	0.176	0.012	0.081	0.251
	ANT1	Right Edge 10mm	0.055	0.055	0.140	0.006	0.110	0.201
	ANT1	Bottom Edge 10mm	0.619	0.010	0.044	0.004	0.629	0.667
WCDMA B4	ANT4	Front Side 10mm	0.146	0.075	0.167	0.016	0.221	0.329
	ANT4	Back Side 10mm	0.206	0.106	0.453	0.039	0.312	0.698
	ANT4	Left Edge 10mm	0.071	0.018	0.176	0.012	0.089	0.259
	ANT4	Top Edge 10mm	0.173	0.053	0.529	0.022	0.226	0.724
WCDMA B4	ANT1	Front Side 10mm	0.250	0.075	0.167	0.016	0.325	0.433
	ANT1	Back Side 10mm	0.577	0.106	0.453	0.039	0.683	1.069
	ANT1	Left Edge 10mm	0.061	0.018	0.176	0.012	0.079	0.249
	ANT1	Right Edge 10mm	0.053	0.055	0.140	0.006	0.108	0.199

	ANT1	Bottom Edge 10mm	0.775	0.010	0.044	0.004	0.785	0.823
WCDMA B5	ANT4	Front Side 10mm	0.070	0.075	0.167	0.016	0.145	0.253
	ANT4	Back Side 10mm	0.106	0.106	0.453	0.039	0.212	0.598
	ANT4	Left Edge 10mm	0.092	0.018	0.176	0.012	0.110	0.280
	ANT4	Top Edge 10mm	0.198	0.053	0.529	0.022	0.251	0.749
WCDMA B5	ANT1	Front Side 10mm	0.167	0.075	0.167	0.016	0.242	0.350
	ANT1	Back Side 10mm	0.268	0.106	0.453	0.039	0.374	0.760
	ANT1	Left Edge 10mm	0.152	0.018	0.176	0.012	0.170	0.340
	ANT1	Right Edge 10mm	0.109	0.055	0.140	0.006	0.164	0.255
LTE B2	ANT1	Bottom Edge 10mm	0.171	0.010	0.044	0.004	0.181	0.219
	ANT4	Front Side 10mm	0.159	0.075	0.167	0.016	0.234	0.342
	ANT4	Back Side 10mm	0.340	0.106	0.453	0.039	0.446	0.832
	ANT4	Left Edge 10mm	0.289	0.018	0.176	0.012	0.307	0.477
LTE B2	ANT4	Top Edge 10mm	0.284	0.053	0.529	0.022	0.337	0.835
	ANT1	Front Side 10mm	0.286	0.075	0.167	0.016	0.361	0.469
	ANT1	Back Side 10mm	0.607	0.106	0.453	0.039	0.713	1.099
	ANT1	Left Edge 10mm	0.050	0.018	0.176	0.012	0.068	0.238
LTE B2	ANT1	Right Edge 10mm	0.158	0.055	0.140	0.006	0.213	0.304
	ANT1	Bottom Edge 10mm	0.631	0.010	0.044	0.004	0.641	0.679
	ANT4	Front Side 10mm	0.119	0.075	0.167	0.016	0.194	0.302
	ANT4	Back Side 10mm	0.215	0.106	0.453	0.039	0.321	0.707
LTE B4	ANT4	Left Edge 10mm	0.218	0.018	0.176	0.012	0.236	0.406
	ANT4	Top Edge 10mm	0.139	0.053	0.529	0.022	0.192	0.690
	ANT1	Front Side 10mm	0.182	0.075	0.167	0.016	0.257	0.365
	ANT1	Back Side 10mm	0.340	0.106	0.453	0.039	0.446	0.832
LTE B4	ANT1	Left Edge 10mm	0.074	0.018	0.176	0.012	0.092	0.262
	ANT1	Right Edge 10mm	0.250	0.055	0.140	0.006	0.305	0.396
	ANT1	Bottom Edge 10mm	0.566	0.010	0.044	0.004	0.576	0.614
	ANT4	Front Side 10mm	0.154	0.075	0.167	0.016	0.229	0.337
LTE B5	ANT4	Back Side 10mm	0.236	0.106	0.453	0.039	0.342	0.728
	ANT4	Left Edge 10mm	0.073	0.018	0.176	0.012	0.091	0.261
	ANT4	Top Edge 10mm	0.242	0.053	0.529	0.022	0.295	0.793
	ANT1	Front Side 10mm	0.178	0.075	0.167	0.016	0.253	0.361
LTE B5	ANT1	Back Side 10mm	0.290	0.106	0.453	0.039	0.396	0.782
	ANT1	Left Edge 10mm	0.147	0.018	0.176	0.012	0.165	0.335
	ANT1	Right Edge 10mm	0.119	0.055	0.140	0.006	0.174	0.265
	ANT1	Bottom Edge 10mm	0.158	0.010	0.044	0.004	0.168	0.206
LTE B7	ANT4	Front Side 10mm	0.146	0.075	0.167	0.016	0.221	0.329
	ANT4	Back Side 10mm	0.223	0.106	0.453	0.039	0.329	0.715
	ANT4	Left Edge 10mm	0.159	0.018	0.176	0.012	0.177	0.347
	ANT4	Top Edge 10mm	0.187	0.053	0.529	0.022	0.240	0.738
LTE B7	ANT1	Front Side 10mm	0.186	0.075	0.167	0.016	0.261	0.369
	ANT1	Back Side 10mm	0.225	0.106	0.453	0.039	0.331	0.717

	ANT1	Left Edge 10mm	0.111	0.018	0.176	0.012	0.129	0.299
	ANT1	Right Edge 10mm	0.172	0.055	0.140	0.006	0.227	0.318
	ANT1	Bottom Edge 10mm	0.209	0.010	0.044	0.004	0.219	0.257
LTE B38	ANT4	Front Side 10mm	0.200	0.075	0.167	0.016	0.275	0.383
	ANT4	Back Side 10mm	0.439	0.106	0.453	0.039	0.545	0.931
	ANT4	Left Edge 10mm	0.142	0.018	0.176	0.012	0.160	0.330
	ANT4	Top Edge 10mm	0.496	0.053	0.529	0.022	0.549	1.047
LTE B38	ANT1	Front Side 10mm	0.232	0.075	0.167	0.016	0.307	0.415
	ANT1	Back Side 10mm	0.407	0.106	0.453	0.039	0.513	0.899
	ANT1	Left Edge 10mm	0.137	0.018	0.176	0.012	0.155	0.325
	ANT1	Right Edge 10mm	0.204	0.055	0.140	0.006	0.259	0.350
	ANT1	Bottom Edge 10mm	0.398	0.010	0.044	0.004	0.408	0.446
LTE B41	ANT4	Front Side 10mm	0.250	0.075	0.167	0.016	0.325	0.433
	ANT4	Back Side 10mm	0.458	0.106	0.453	0.039	0.564	0.950
	ANT4	Left Edge 10mm	0.142	0.018	0.176	0.012	0.160	0.330
	ANT4	Top Edge 10mm	0.487	0.053	0.529	0.022	0.540	1.038
LTE B41	ANT1	Front Side 10mm	0.308	0.075	0.167	0.016	0.383	0.491
	ANT1	Back Side 10mm	0.408	0.106	0.453	0.039	0.514	0.900
	ANT1	Left Edge 10mm	0.166	0.018	0.176	0.012	0.184	0.354
	ANT1	Right Edge 10mm	0.159	0.055	0.140	0.006	0.214	0.305
	ANT1	Bottom Edge 10mm	0.440	0.010	0.044	0.004	0.450	0.488
N5	ANT4	Front Side 10mm	0.153	0.075	0.167	0.016	0.228	0.336
	ANT4	Back Side 10mm	0.273	0.106	0.453	0.039	0.379	0.765
	ANT4	Left Edge 10mm	0.078	0.018	0.176	0.012	0.096	0.266
	ANT4	Top Edge 10mm	0.225	0.053	0.529	0.022	0.278	0.776
N5	ANT1	Front Side 10mm	0.078	0.075	0.167	0.016	0.153	0.261
	ANT1	Back Side 10mm	0.136	0.106	0.453	0.039	0.242	0.628
	ANT1	Left Edge 10mm	0.054	0.018	0.176	0.012	0.072	0.242
	ANT1	Right Edge 10mm	0.008	0.055	0.140	0.006	0.063	0.154
	ANT1	Bottom Edge 10mm	0.129	0.010	0.044	0.004	0.139	0.177
N7	ANT4	Front Side 10mm	0.215	0.075	0.167	0.016	0.290	0.398
	ANT4	Back Side 10mm	0.195	0.106	0.453	0.039	0.301	0.687
	ANT4	Left Edge 10mm	0.304	0.018	0.176	0.012	0.322	0.492
	ANT4	Top Edge 10mm	0.110	0.053	0.529	0.022	0.163	0.661
N7	ANT1	Front Side 10mm	0.197	0.075	0.167	0.016	0.272	0.380
	ANT1	Back Side 10mm	0.364	0.106	0.453	0.039	0.470	0.856
	ANT1	Left Edge 10mm	0.059	0.018	0.176	0.012	0.077	0.247
	ANT1	Right Edge 10mm	0.213	0.055	0.140	0.006	0.268	0.359
	ANT1	Bottom Edge 10mm	0.277	0.010	0.044	0.004	0.287	0.325
N38	ANT4	Front Side 10mm	0.168	0.075	0.167	0.016	0.243	0.351
	ANT4	Back Side 10mm	0.387	0.106	0.453	0.039	0.493	0.879
	ANT4	Left Edge 10mm	0.161	0.018	0.176	0.012	0.179	0.349
	ANT4	Top Edge 10mm	0.407	0.053	0.529	0.022	0.460	0.958



N38	ANT1	Front Side 10mm	0.174	0.075	0.167	0.016	0.249	0.357
	ANT1	Back Side 10mm	0.355	0.106	0.453	0.039	0.461	0.847
	ANT1	Left Edge 10mm	0.069	0.018	0.176	0.012	0.087	0.257
	ANT1	Right Edge 10mm	0.284	0.055	0.140	0.006	0.339	0.430
	ANT1	Bottom Edge 10mm	0.288	0.010	0.044	0.004	0.298	0.336
N41	ANT4	Front Side 10mm	0.146	0.075	0.167	0.016	0.221	0.329
	ANT4	Back Side 10mm	0.347	0.106	0.453	0.039	0.453	0.839
	ANT4	Left Edge 10mm	0.147	0.018	0.176	0.012	0.165	0.335
	ANT4	Top Edge 10mm	0.380	0.053	0.529	0.022	0.433	0.931
N41	ANT1	Front Side 10mm	0.165	0.075	0.167	0.016	0.240	0.348
	ANT1	Back Side 10mm	0.309	0.106	0.453	0.039	0.415	0.801
	ANT1	Left Edge 10mm	0.053	0.018	0.176	0.012	0.071	0.241
	ANT1	Right Edge 10mm	0.216	0.055	0.140	0.006	0.271	0.362
	ANT1	Bottom Edge 10mm	0.236	0.010	0.044	0.004	0.246	0.284
N77 (3450-3550MHz)	ANT2	Front Side 10mm	0.138	0.075	0.167	0.016	0.213	0.321
	ANT2	Back Side 10mm	0.464	0.106	0.453	0.039	0.570	0.956
	ANT2	Left Edge 10mm	0.539	0.018	0.176	0.012	0.557	0.727
	ANT2	Top Edge 10mm	0.138	0.053	0.529	0.022	0.191	0.689
N77 (3450-3550MHz)	ANT3	Front Side 10mm	0.581	0.075	0.167	0.016	0.656	0.764
	ANT3	Back Side 10mm	0.733	0.106	0.453	0.039	0.839	1.225
	ANT3	Left Edge 10mm	0.061	0.018	0.176	0.012	0.079	0.249
	ANT3	Right Edge 10mm	0.311	0.055	0.140	0.006	0.366	0.457
	ANT3	Top Edge 10mm	0.610	0.053	0.529	0.004	0.663	1.143
N77 (3450-3550MHz)	ANT5	Front Side 10mm	0.091	0.075	0.167	0.016	0.166	0.274
	ANT5	Back Side 10mm	0.132	0.106	0.453	0.039	0.238	0.624
	ANT5	Right Edge 10mm	0.208	0.018	0.140	0.012	0.226	0.360
	ANT5	Top Edge 10mm	0.045	0.053	0.529	0.022	0.098	0.596
N77 (3450-3550MHz)	ANT6	Front Side 10mm	0.088	0.075	0.167	0.016	0.163	0.271
	ANT6	Back Side 10mm	0.430	0.106	0.453	0.039	0.536	0.922
	ANT6	Left Edge 10mm	0.498	0.018	0.176	0.012	0.516	0.686
	ANT6	Bottom Edge 10mm	0.115	0.010	0.044	0.004	0.125	0.163
N77 (3700-3980MHz)	ANT2	Front Side 10mm	0.134	0.075	0.167	0.016	0.209	0.317
	ANT2	Back Side 10mm	0.468	0.106	0.453	0.039	0.574	0.960
	ANT2	Left Edge 10mm	0.505	0.018	0.176	0.012	0.523	0.693
	ANT2	Top Edge 10mm	0.134	0.053	0.529	0.022	0.187	0.685
N77 (3700-3980MHz)	ANT3	Front Side 10mm	0.460	0.075	0.167	0.016	0.535	0.643
	ANT3	Back Side 10mm	0.835	0.106	0.453	0.039	0.941	1.327
	ANT3	Left Edge 10mm	0.063	0.018	0.176	0.012	0.081	0.251
	ANT3	Right Edge 10mm	0.451	0.055	0.140	0.006	0.506	0.597
	ANT3	Top Edge 10mm	1.050	0.053	0.529	0.004	1.103	<b>1.583</b>
N77 (3700-3980MHz)	ANT5	Front Side 10mm	0.125	0.075	0.167	0.016	0.200	0.308
	ANT5	Back Side 10mm	0.420	0.106	0.453	0.039	0.526	0.912
	ANT5	Right Edge 10mm	0.522	0.018	0.140	0.012	0.540	0.674

	ANT5	Top Edge 10mm	0.135	0.053	0.529	0.022	0.188	0.686
N77 (3700-3980MHz)	ANT6	Front Side 10mm	0.051	0.075	0.167	0.016	0.126	0.234
	ANT6	Back Side 10mm	0.295	0.106	0.453	0.039	0.401	0.787
	ANT6	Left Edge 10mm	0.306	0.018	0.176	0.012	0.324	0.494
	ANT6	Bottom Edge 10mm	0.079	0.010	0.044	0.004	0.089	0.127
N78 (3450-3550MHz)	ANT2	Front Side 10mm	0.102	0.075	0.167	0.016	0.177	0.285
	ANT2	Back Side 10mm	0.451	0.106	0.453	0.039	0.557	0.943
	ANT2	Left Edge 10mm	0.492	0.018	0.176	0.012	0.510	0.680
	ANT2	Top Edge 10mm	0.110	0.053	0.529	0.022	0.163	0.661
N78 (3450-3550MHz)	ANT3	Front Side 10mm	0.230	0.075	0.167	0.016	0.305	0.413
	ANT3	Back Side 10mm	0.562	0.106	0.453	0.039	0.668	1.054
	ANT3	Left Edge 10mm	0.054	0.018	0.176	0.012	0.072	0.242
	ANT3	Right Edge 10mm	0.102	0.055	0.140	0.006	0.157	0.248
	ANT3	Top Edge 10mm	0.421	0.053	0.529	0.004	0.474	0.954
N78 (3450-3550MHz)	ANT5	Front Side 10mm	0.146	0.075	0.167	0.016	0.221	0.329
	ANT5	Back Side 10mm	0.198	0.106	0.453	0.039	0.304	0.690
	ANT5	Right Edge 10mm	0.299	0.018	0.140	0.012	0.317	0.451
	ANT5	Top Edge 10mm	0.074	0.053	0.529	0.022	0.127	0.625
N78 (3450-3550MHz)	ANT6	Front Side 10mm	0.060	0.075	0.167	0.016	0.135	0.243
	ANT6	Back Side 10mm	0.273	0.106	0.453	0.039	0.379	0.765
	ANT6	Left Edge 10mm	0.291	0.018	0.176	0.012	0.309	0.479
	ANT6	Bottom Edge 10mm	0.077	0.010	0.044	0.004	0.087	0.125
N78 (3700-3980MHz)	ANT2	Front Side 10mm	0.112	0.075	0.167	0.016	0.187	0.295
	ANT2	Back Side 10mm	0.465	0.106	0.453	0.039	0.571	0.957
	ANT2	Left Edge 10mm	0.493	0.018	0.176	0.012	0.511	0.681
	ANT2	Top Edge 10mm	0.124	0.053	0.529	0.022	0.177	0.675
N78 (3700-3980MHz)	ANT3	Front Side 10mm	0.307	0.075	0.167	0.016	0.382	0.490
	ANT3	Back Side 10mm	0.558	0.106	0.453	0.039	0.664	1.050
	ANT3	Left Edge 10mm	0.039	0.018	0.176	0.012	0.057	0.227
	ANT3	Right Edge 10mm	0.254	0.055	0.140	0.006	0.309	0.400
	ANT3	Top Edge 10mm	0.438	0.053	0.529	0.004	0.491	0.971
N78 (3700-3980MHz)	ANT5	Front Side 10mm	0.286	0.075	0.167	0.016	0.361	0.469
	ANT5	Back Side 10mm	0.501	0.106	0.453	0.039	0.607	0.993
	ANT5	Right Edge 10mm	0.834	0.018	0.140	0.012	0.852	0.986
	ANT5	Top Edge 10mm	0.195	0.053	0.529	0.022	0.248	0.746
N78 (3700-3980MHz)	ANT6	Front Side 10mm	0.044	0.075	0.167	0.016	0.119	0.227
	ANT6	Back Side 10mm	0.202	0.106	0.453	0.039	0.308	0.694
	ANT6	Left Edge 10mm	0.194	0.018	0.176	0.012	0.212	0.382
	ANT6	Bottom Edge 10mm	0.082	0.010	0.044	0.004	0.092	0.130

Note:  
 1: The simultaneous transmission combinations of the three antennas contain combinations of two antennas, so only the worst simultaneous transmission combinations was shown in this table.  
 2: The highest Summed 1g SAR is 1.583 W/Kg < 1.6 W/kg, so Simultaneous Transmission SAR test is not required.

### 13.2.5 Hotspot Simultaneous Transmission SAR Evaluation for WWAN Antenna with WLAN and Bluetooth

Band	Antenna	Band	Antenna	Position	Stand alone SAR						SUM SAR	
					1	2	3	4	5	6	Sum SAR (3+4)	Sum SAR (3+5+6)
					LTE	NR	ENDC	2.4GWIFI	5GWIFI (MAX)	Bluetooth		
LTE B7	ANT2	N5	ANT4	Front Side 10mm	0.071	0.153	0.224	0.075	0.167	0.016	0.299	0.407
				Back Side 10mm	0.224	0.273	0.497	0.106	0.453	0.039	0.603	0.989
				Left Edge 10mm	0.210	0.078	0.288	0.018	0.176	0.012	0.306	0.476
				Right Edge 10mm	0.000	0.000	0.000	0.055	0.140	0.006	0.055	0.146
				Top Edge 10mm	0.061	0.225	0.286	0.053	0.529	0.022	0.339	0.837
LTE B2	ANT2	N78	ANT3	Front Side 10mm	0.321	0.307	0.628	0.075	0.167	0.016	0.703	0.811
				Back Side 10mm	0.406	0.558	0.964	0.106	0.453	0.039	1.070	<b>1.456</b>
				Left Edge 10mm	0.331	0.039	0.370	0.018	0.176	0.012	0.388	0.558
				Right Edge 10mm	0.000	0.254	0.254	0.055	0.140	0.006	0.309	0.400
				Top Edge 10mm	0.204	0.438	0.642	0.053	0.529	0.022	0.695	1.193
LTE B5	ANT4	N78	ANT3	Front Side 10mm	0.154	0.307	0.461	0.075	0.167	0.016	0.536	0.644
				Back Side 10mm	0.236	0.558	0.794	0.106	0.453	0.039	0.900	1.286
				Left Edge 10mm	0.073	0.039	0.112	0.018	0.176	0.012	0.130	0.300
				Right Edge 10mm	0.000	0.254	0.254	0.055	0.140	0.006	0.309	0.400
				Top Edge 10mm	0.242	0.438	0.680	0.053	0.529	0.022	0.733	1.231
LTE B7	ANT2	N78	ANT3	Front Side 10mm	0.071	0.307	0.378	0.075	0.167	0.016	0.453	0.561
				Back Side 10mm	0.224	0.558	0.782	0.106	0.453	0.039	0.888	1.274
				Left Edge 10mm	0.210	0.039	0.249	0.018	0.176	0.012	0.267	0.437
				Right Edge 10mm	0.000	0.254	0.254	0.055	0.140	0.006	0.309	0.400
				Top Edge 10mm	0.061	0.438	0.499	0.053	0.529	0.022	0.552	1.050
LTE B41	ANT2	N78	ANT3	Front Side 10mm	0.104	0.307	0.411	0.075	0.167	0.016	0.486	0.594
				Back Side 10mm	0.256	0.558	0.814	0.106	0.453	0.039	0.920	1.306
				Left Edge 10mm	0.084	0.039	0.123	0.018	0.176	0.012	0.141	0.311
				Right Edge 10mm	0.000	0.254	0.254	0.055	0.140	0.006	0.309	0.400
				Top Edge 10mm	0.106	0.438	0.544	0.053	0.529	0.022	0.597	1.095

Note:

1: The simultaneous transmission combinations of the three antennas contain combinations of two antennas, so only the worst simultaneous transmission combinations was shown in this table.

2: The highest Summed 1g SAR is 1.456 W/Kg < 1.6 W/kg, so Simultaneous Transmission SAR test is not required.

### 13.2.6 Hotspot Simultaneous Transmission SAR Evaluation for WWAN Antenna with WLAN and Bluetooth

Band	Antenna	Band	Antenna	Position	Stand alone SAR						SUM SAR	
					1	2	3	4	5	6	Sum SAR (3+4)	Sum SAR (3+5+6)
					LTE B4	LTE B7	LTE CA	2.4GWIFI	5GWIFI (MAX)	Bluetooth		
LTE B4	ANT1	LTE B7	ANT2	Front Side 10mm	0.182	0.071	0.253	0.075	0.167	0.016	0.328	0.436
				Back Side 10mm	0.340	0.224	0.564	0.106	0.453	0.039	0.670	<b>1.056</b>
				Left Edge 10mm	0.074	0.210	0.284	0.018	0.176	0.012	0.302	0.472
				Right Edge 10mm	0.250	0.000	0.250	0.055	0.140	0.006	0.305	0.396
				Top Edge 10mm	0.000	0.061	0.061	0.053	0.529	0.022	0.114	0.612
				Bottom Edge 10mm	0.566	0.000	0.566	0.010	0.044	0.004	0.576	0.614

Note:

1: The simultaneous transmission combinations of the three antennas contain combinations of two antennas, so only the worst simultaneous transmission combinations was shown in this table.

2: The highest Summed 1g SAR is 1.056 W/Kg < 1.6 W/kg, so Simultaneous Transmission SAR test is not required.

## 13.2.7 Specific Simultaneous Transmission SAR Evaluation for WWAN Antenna with WLAN

Band	Antenna	Position	Stand alone SAR		SUM SAR
			1	2	
			WWAN	5GWIFI(MAX)	Sum SAR (1+2)
GSM1900	ANT1	Bottom Edge 0mm	0.675	0.008	0.683
WCDMA B2	ANT1	Bottom Edge 0mm	1.279	0.008	1.287
WCDMA B4	ANT1	Bottom Edge 0mm	1.077	0.008	1.085
LTE B2	ANT1	Bottom Edge 0mm	1.182	0.008	1.190
LTE B4	ANT1	Bottom Edge 0mm	0.805	0.008	0.813
LTE B38	ANT4	Top Edge 0mm	0.925	1.459	2.384
LTE B41	ANT4	Top Edge 0mm	0.916	1.459	2.375
N7	ANT4	Back Side 0mm	0.596	0.745	1.341
		Top Edge 0mm	0.550	1.459	2.009
N77 (3450-3550MHz)	ANT2	Back Side 0mm	1.855	0.745	2.600
		Left Edge 0mm	1.388	0.106	1.494
	ANT3	Front Side 0mm	1.255	0.511	1.766
		Back Side 0mm	1.786	0.745	2.531
		Right Edge 0mm	0.821	0.270	1.091
		Top Edge 0mm	1.712	1.459	3.171
	ANT6	Back Side 0mm	1.386	0.745	2.131
		Left Edge 0mm	1.220	0.106	1.326
N77 (3700-3980MHz)	ANT2	Back Side 0mm	1.176	0.745	1.921
		Left Edge 0mm	1.220	0.106	1.326
	ANT3	Front Side 0mm	0.898	0.511	1.409
		Back Side 0mm	1.178	0.745	1.923
		Right Edge 0mm	0.525	0.270	0.795
		Top Edge 0mm	1.199	1.459	2.658
	ANT5	Back Side 0mm	0.626	0.745	1.371
		Right Edge 0mm	1.113	0.270	1.383
N78 (3450-3550MHz)	ANT2	Back Side 0mm	2.270	0.745	3.015
		Left Edge 0mm	1.652	0.106	1.758
	ANT3	Front Side 0mm	1.391	0.511	1.902
		Back Side 0mm	2.029	0.745	2.774
		Top Edge 0mm	1.832	1.459	3.291
N78 (3700-3980MHz)	ANT2	Back Side 0mm	2.400	0.745	3.145
		Left Edge 0mm	1.381	0.106	1.487
	ANT3	Front Side 0mm	1.126	0.511	1.637
		Back Side 0mm	1.785	0.745	2.530
		Top Edge 0mm	2.057	1.459	<b>3.516</b>
	ANT5	Back Side 0mm	0.585	0.745	1.330

		Right Edge 0mm	2.401	0.270	2.671
--	--	----------------	-------	-------	-------

## Note:

- 1: The simultaneous transmission combinations of the three antennas contain combinations of two antennas, so only the worst simultaneous transmission combinations was shown in this table.
- 2: The highest Summed 10g SAR is 3.516 W/Kg < 3.8 W/kg, so Simultaneous Transmission SAR test is not required.

## 14 TEST EQUIPMENTS LIST

Description	Manufacturer	Model	Serial No./Version	Cal. Date	Cal. Due
PC	Dell	N/A	N/A	N/A	N/A
Test Software	Speag	DASY5	52.8.8.1222	N/A	N/A
835MHz Validation Dipole	Speag	D835V2	SN: 4d187	2021/05/17	2024/05/16
1750MHz Validation Dipole	Speag	D1750V2	SN: 1130	2021/05/17	2024/05/16
1900MHz Validation Dipole	Speag	D1900V2	SN: 5d193	2021/05/20	2024/05/19
2450MHz Validation Dipole	Speag	D2450V2	SN: 952	2021/05/19	2024/05/18
2600MHz Validation Dipole	Speag	D2600V2	SN: 1095	2021/05/19	2024/05/18
3500MHz Validation Dipole	Speag	D3500V2	SN: 1115	2020/11/11	2023/11/10
3700MHz Validation Dipole	Speag	D3700V2	SN: 1086	2020/11/12	2023/11/11
3900MHz Validation Dipole	Speag	D3900V2	SN: 1059	2020/11/13	2023/11/12
5GHz Validation Dipole	Speag	D5GHZV2	SN: 1200	2021/05/18	2024/05/17
E-Field Probe	Speag	EX3DV4	SN: 7607	2022/07/04	2023/07/03
Data Acquisition Electronicsr	Speag	DAE4	SN: 878	2022/06/13	2023/06/12
Signal Generator	R&S	SMB100A	177746	2022/05/19	2023/05/18
Power Meter	R&S	NRVD-B2	7250BJ-0112/2011	2022/09/06	2023/09/05
Power Sensor	R&S	NRV-Z4	100381	2022/09/06	2023/09/05
Power Sensor	R&S	NRV-Z2	100211	2022/09/06	2023/09/05
Wireless Communication Test Set	Anritsu	MT8820C	6201524635	2022/01/05	2023/01/04
Network Analyzer	Agilent	E5071C	MY46103472	2021/12/29	2022/12/28
Thermometer	Elitech	RC-4HC	EF7225003028	2022/08/31	2023/08/30
Thermometer	Elitech	RC-4HC	EF7216002985	2021/12/01	2022/11/30
Power Amplifier	SATIMO	6552B	22374	N/A	N/A
Dielectric Probe Kit	Speag	DAK3.5	SN: 1312	N/A	N/A
Phantom	Speag	SAM	SN: 1576	N/A	N/A
Attenuator	COM-MW	ZA-S1-31	1305003187	N/A	N/A
Directional coupler	AA-MCS	AAMCS-UDC	000272	N/A	N/A

Note: For dipole antennas, BALUN has adopted 3 years as calibration intervals, and on annual basis, every measurement dipole has been evaluated and is in compliance with the following criteria:

1. There is no physical damage on the dipole;
2. System validation with specific dipole is within 10% of calibrated value;
3. Return-loss in within 20% of calibrated measurement.
4. Impedance (real or imaginary parts) in within 5 Ohms of calibrated measurement.

## ANNEX A SIMULATING LIQUID VERIFICATION RESULT

The dielectric parameters of the liquids were verified prior to the SAR evaluation using a DAK3.5 Dielectric Probe Kit.

Head Liquid

Date	Liquid Type	Fre. (MHz)	Temp. (°C)	Meas. Conductivity ( $\sigma$ ) (S/m)	Meas. Permittivity ( $\epsilon$ )	Target Conductivity ( $\sigma$ ) (S/m)	Target Permittivity ( $\epsilon$ )	Conductivity Tolerance (%)	Permittivity Tolerance (%)
2022.10.01	Head	835	21.3	0.90	41.80	0.90	41.50	0.00	0.72
2022.10.02	Head	835	21.1	0.91	41.79	0.90	41.50	1.11	0.70
2022.10.03	Head	1750	21.5	1.39	40.16	1.37	40.08	1.46	0.20
2022.10.06	Head	1900	21.4	1.40	39.93	1.40	40.00	0.00	-0.18
2022.10.07	Head	1900	21.1	1.39	39.91	1.40	40.00	-0.71	-0.23
2022.10.08	Head	2450	21.1	1.80	39.49	1.80	39.20	0.00	0.74
2022.10.09	Head	2600	21.4	1.99	38.51	1.96	39.01	1.53	-1.28
2022.10.10	Head	2600	21.5	1.97	38.48	1.96	39.01	0.51	-1.36
2022.10.11	Head	2600	21.3	1.97	38.56	1.96	39.01	0.51	-1.15
2022.10.12	Head	2600	21.6	1.99	38.44	1.96	39.01	1.53	-1.46
2022.10.13	Head	2600	21.8	2.00	38.63	1.96	39.01	2.04	-0.97
2022.10.14	Head	2600	21.5	1.97	38.57	1.96	39.01	0.51	-1.13
2022.10.15	Head	3500	21.2	2.87	38.35	2.91	37.93	-1.37	1.11
2022.10.15	Head	3700	21.2	3.13	37.71	3.12	37.70	0.32	0.03
2022.10.15	Head	3900	21.2	3.39	37.36	3.32	37.47	2.11	-0.29
2022.10.18	Head	3500	21.5	2.88	38.33	2.91	37.93	-1.03	1.05
2022.10.19	Head	3700	21.1	3.13	37.78	3.12	37.70	0.32	0.21
2022.10.19	Head	3900	21.1	3.37	37.16	3.32	37.47	1.51	-0.83
2022.10.20	Head	3500	21.4	2.88	38.20	2.91	37.93	-1.03	0.71
2022.10.20	Head	3700	21.4	3.13	37.55	3.12	37.70	0.32	-0.40
2022.10.21	Head	3500	21.1	2.88	38.29	2.91	37.93	-1.03	0.95
2022.10.22	Head	3700	20.9	3.13	37.80	3.12	37.70	0.32	0.27
2022.10.23	Head	5250	21.3	4.70	35.99	4.71	35.93	-0.21	0.17
2022.10.24	Head	5750	21.5	5.18	35.61	5.22	35.36	-0.77	0.71

Note: The tolerance limit of Conductivity and Permittivity is  $\pm 5\%$ .



## ANNEX B SYSTEM CHECK RESULT

Comparing to the original SAR value provided by SPEAG, the validation data should be within its specification of 10 % (for 1 g).

Head liquid 1g

Date	Liquid Type	Freq. (MHz)	Power (mW)	Measured SAR (W/kg)	Normalized SAR (W/kg)	Dipole SAR (W/kg)	Tolerance (%)
2022.10.01	Head	835	100	0.95	9.53	9.76	-2.36
2022.10.02	Head	835	100	0.95	9.46	9.76	-3.07
2022.10.03	Head	1750	100	3.71	37.10	36.7	1.09
2022.10.06	Head	1900	100	3.95	39.50	40.3	-1.99
2022.10.07	Head	1900	100	4.14	41.40	40.3	2.73
2022.10.08	Head	2450	100	5.27	52.70	53.0	-0.57
2022.10.09	Head	2600	100	5.55	55.50	56.8	-2.29
2022.10.10	Head	2600	100	5.42	54.20	56.8	-4.58
2022.10.11	Head	2600	100	5.72	57.20	56.8	0.70
2022.10.12	Head	2600	100	5.67	56.70	56.8	-0.18
2022.10.13	Head	2600	100	5.82	58.20	56.8	2.46
2022.10.14	Head	2600	100	5.85	58.50	56.8	2.99
2022.10.15	Head	3500	100	6.91	69.10	66.8	3.44
2022.10.15	Head	3700	100	6.62	66.20	66.0	0.30
2022.10.15	Head	3900	100	7.11	71.10	69.2	2.75
2022.10.18	Head	3500	100	6.91	69.10	66.8	3.44
2022.10.19	Head	3700	100	6.58	65.80	66.0	-0.30
2022.10.19	Head	3900	100	7.21	72.10	69.2	4.19
2022.10.20	Head	3500	100	6.72	67.20	66.8	0.60
2022.10.20	Head	3700	100	6.68	66.80	66.0	1.21
2022.10.21	Head	3500	100	6.81	68.10	66.8	1.95
2022.10.22	Head	3700	100	6.92	69.20	66.0	4.85
2022.10.23	Head	5250	100	7.88	78.80	77.8	1.29
2022.10.24	Head	5750	100	7.91	79.10	77.2	2.46

Note: The tolerance limit of System validation  $\pm 10\%$ .

## Head liquid 10g

Date	Freq. (MHz)	Power (mW)	Measured SAR (W/kg)	Normalized SAR (W/kg)	Dipole SAR (W/kg)	Tolerance (%)
2022.10.03	1750	100	1.96	19.60	19.10	2.62
2022.10.06	1900	100	1.99	19.90	20.30	-1.97
2022.10.07	1900	100	2.11	21.10	20.30	3.94
2022.10.08	2450	100	2.43	24.30	24.10	0.83
2022.10.09	2600	100	2.41	24.10	24.80	-2.82
2022.10.10	2600	100	2.41	24.10	24.80	-2.82
2022.10.11	2600	100	2.51	25.10	24.80	1.21
2022.10.12	2600	100	2.49	24.90	24.80	0.40
2022.10.13	2600	100	2.56	25.60	24.80	3.23
2022.10.14	2600	100	2.57	25.70	24.80	3.63
2022.10.15	3500	100	2.52	25.20	25.20	0.00
2022.10.15	3700	100	2.27	22.70	23.80	-4.62
2022.10.15	3900	100	2.35	23.50	23.90	-1.67
2022.10.18	3500	100	2.46	24.60	25.20	-2.38
2022.10.19	3700	100	2.29	22.90	23.80	-3.78
2022.10.19	3900	100	2.42	24.20	23.90	1.26
2022.10.20	3500	100	2.42	24.20	25.20	-3.97
2022.10.20	3700	100	2.29	22.90	23.80	-3.78
2022.10.21	3500	100	2.47	24.70	25.20	-1.98
2022.10.22	3700	100	2.45	24.50	23.80	2.94
2022.10.23	5250	100	2.28	22.80	22.10	3.17
2022.10.24	5750	100	2.22	22.20	21.70	2.30

Note: The tolerance limit of System validation  $\pm 10\%$ .

## System Performance Check Data (835MHz Head)

Date: 2022.10.01

Communication System Band: D835 (835.0 MHz); Frequency: 835 MHz; Duty Cycle: 1:1

Medium parameters used:  $f = 835$  MHz;  $\sigma = 0899$  S/m;  $\epsilon_r = 41.803$ ;  $\rho = 1000$  kg/m<sup>3</sup>

Phantom section: Flat Section

Ambient Temperature: 22.5°C Liquid Temperature: 21.3°C

DASY5 Configuration:

- Probe: EX3DV4 - SN7607; ConvF(10.44, 10.44, 10.44); Calibrated: 2022.07.04;
- Sensor-Surface: 4mm (Mechanical Surface Detection)
- Electronics: DAE4 Sn878; Calibrated: 2022.06.13
- Phantom: SAM1; Type: QD000P40CD; Serial: TP:1576
- Measurement SW: DASY52, Version 52.8 (8); SEMCAD X Version 14.6.10 (7331)

**CW 835 100mW/Area Scan (61x81x1):** Interpolated grid:  $dx=1.500$  mm,  $dy=1.500$  mm

Maximum value of SAR (interpolated) = 1.01 W/kg

**CW 835 100mW/Zoom Scan (7x7x7)/Cube 0:** Measurement grid:  $dx=5$ mm,  $dy=5$ mm,  $dz=5$ mm

Reference Value = 33.15 V/m; Power Drift = 0.04 dB

Peak SAR (extrapolated) = 1.41 W/kg

**SAR(1 g) = 0.953 W/kg; SAR(10 g) = 0.621 W/kg**

Maximum value of SAR (measured) = 1.06 W/kg

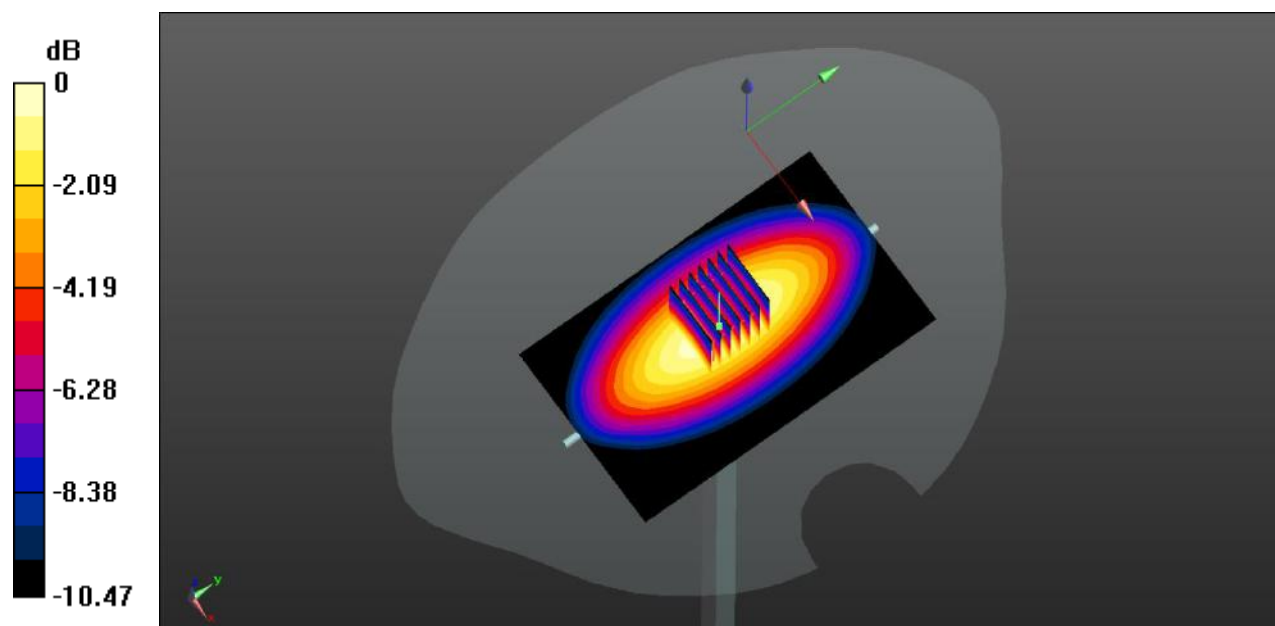

0 dB = 1.06 W/kg

## System Performance Check Data (835MHz Head)

Date: 2022.10.02

Communication System Band: D835 (835.0 MHz); Frequency: 835 MHz; Duty Cycle: 1:1

Medium parameters used:  $f = 835$  MHz;  $\sigma = 0.911$  S/m;  $\epsilon_r = 41.791$ ;  $\rho = 1000$  kg/m<sup>3</sup>

Phantom section: Flat Section

Ambient Temperature: 22.4°C Liquid Temperature: 21.1°C

DASY5 Configuration:

- Probe: EX3DV4 - SN7607; ConvF(10.44, 10.44, 10.44); Calibrated: 2022.07.04;
- Sensor-Surface: 4mm (Mechanical Surface Detection)
- Electronics: DAE4 Sn878; Calibrated: 2022.06.13
- Phantom: SAM1; Type: QD000P40CD; Serial: TP:1576
- Measurement SW: DASY52, Version 52.8 (8); SEMCAD X Version 14.6.10 (7331)

**CW 835 100mW/Area Scan (61x101x1):** Interpolated grid: dx=1.500 mm, dy=1.500 mm

Maximum value of SAR (interpolated) = 0.955 W/kg

**CW 835 100mW/Zoom Scan (7x7x7)/Cube 0:** Measurement grid: dx=5mm, dy=5mm, dz=5mm

Reference Value = 31.42 V/m; Power Drift = -0.01 dB

Peak SAR (extrapolated) = 1.28 W/kg

**SAR(1 g) = 0.946 W/kg; SAR(10 g) = 0.636 W/kg**

Maximum value of SAR (measured) = 0.978 W/kg

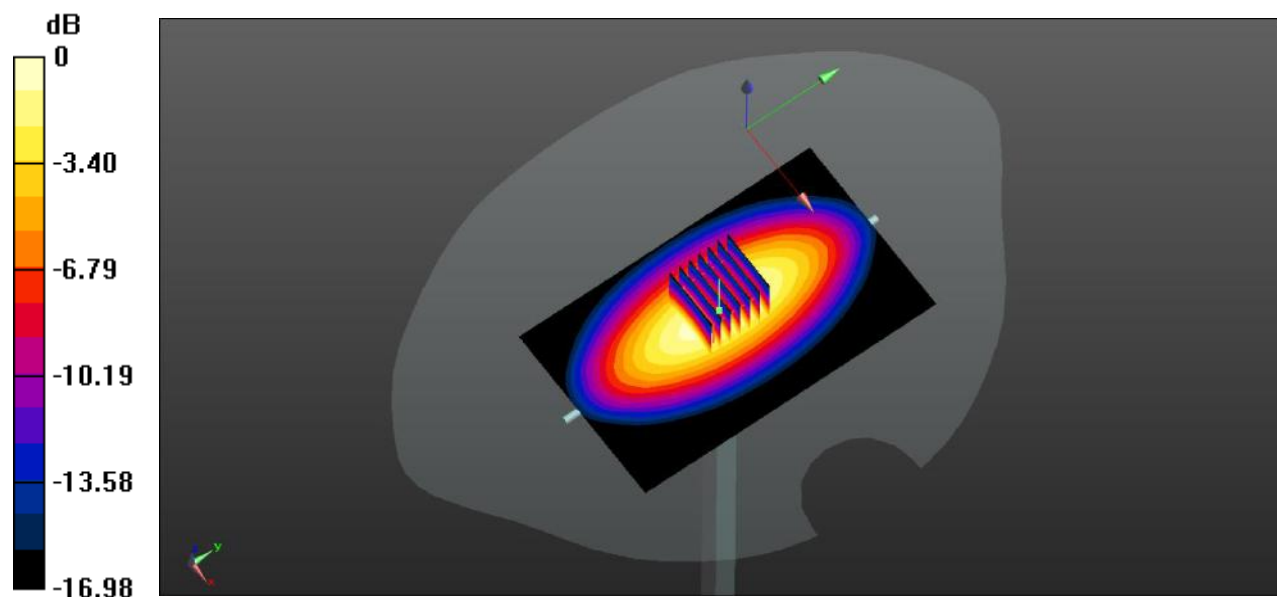

0 dB = 0.978 W/kg

## System Performance Check Data (1750MHz Head)

Date: 2022.10.03

Communication System Band: D1750 (1750.0 MHz); Frequency: 1750 MHz; Duty Cycle: 1:1

Medium parameters used:  $f = 1750$  MHz;  $\sigma = 1.389$  S/m;  $\epsilon_r = 40.158$ ;  $\rho = 1000$  kg/m<sup>3</sup>

Phantom section: Flat Section

Ambient Temperature: 22.8°C Liquid Temperature: 21.5°C

DASY5 Configuration:

- Probe: EX3DV4 - SN7607; ConvF(8.69, 8.69, 8.69); Calibrated: 2022.07.04;
- Sensor-Surface: 4mm (Mechanical Surface Detection)
- Electronics: DAE4 Sn878; Calibrated: 2022.06.13
- Phantom: SAM1; Type: QD000P40CD; Serial: TP:1576
- Measurement SW: DASY52, Version 52.8 (8); SEMCAD X Version 14.6.10 (7331)

**CW 1750 100mw/Area Scan (101x101x1):** Interpolated grid: dx=1.000 mm, dy=1.000 mm

Maximum value of SAR (interpolated) = 4.18 W/kg

**CW 1750 100mw/Zoom Scan (7x7x7)/Cube 0:** Measurement grid: dx=5mm, dy=5mm, dz=5mm

Reference Value = 56.11 V/m; Power Drift = -0.02 dB

Peak SAR (extrapolated) = 7.01 W/kg

**SAR(1 g) = 3.71 W/kg; SAR(10 g) = 1.96 W/kg**

Maximum value of SAR (measured) = 3.62 W/kg

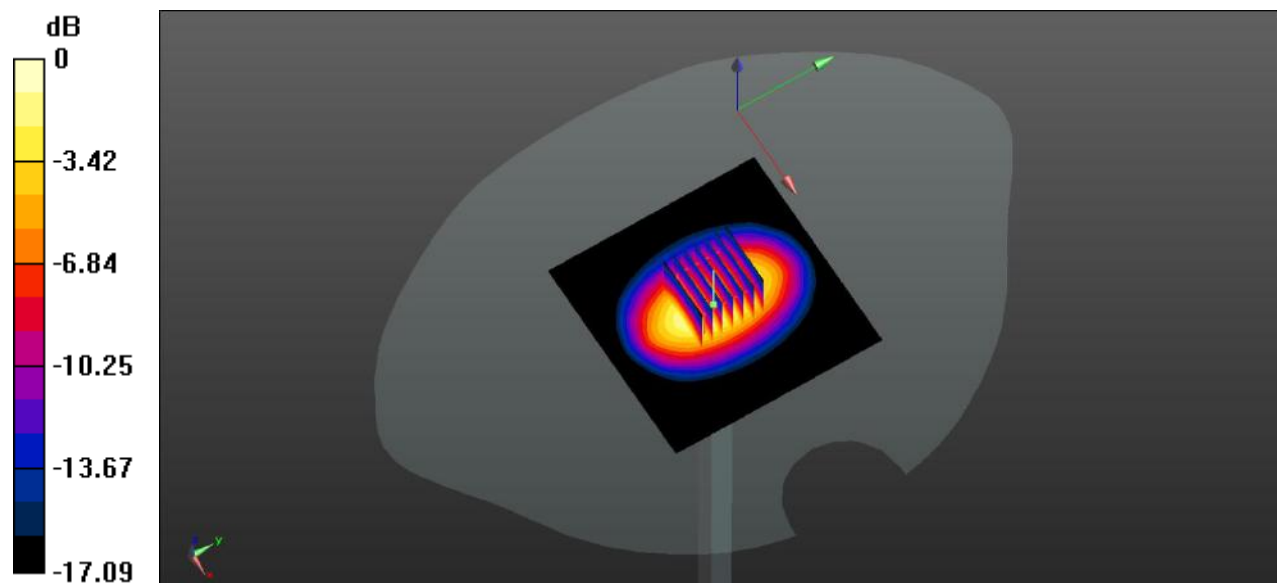

0 dB = 3.62 W/kg

## System Performance Check Data (1900MHz Head)

Date: 2022.10.06

Communication System Band: D1900 (1900.0 MHz); Frequency: 1900 MHz; Duty Cycle: 1:1

Medium parameters used:  $f = 1900$  MHz;  $\sigma = 1.396$  S/m;  $\epsilon_r = 39.932$ ;  $\rho = 1000$  kg/m<sup>3</sup>

Phantom section: Flat Section

Ambient Temperature: 22.6°C Liquid Temperature: 21.4°C

DASY5 Configuration:

- Probe: EX3DV4 - SN7607; ConvF(8.4, 8.4, 8.4); Calibrated: 2022.07.04;
- Sensor-Surface: 4mm (Mechanical Surface Detection)
- Electronics: DAE4 Sn878; Calibrated: 2022.06.13
- Phantom: SAM1; Type: QD000P40CD; Serial: TP:1576
- Measurement SW: DASY52, Version 52.8 (8); SEMCAD X Version 14.6.10 (7331)

**CW 1900 100mW/Area Scan (101x101x1):** Interpolated grid: dx=1.000 mm, dy=1.000 mm

Maximum value of SAR (interpolated) = 4.66 W/kg

**CW 1900 100mW/Zoom Scan (7x7x7)/Cube 0:** Measurement grid: dx=5mm, dy=5mm, dz=5mm

Reference Value = 55.54 V/m; Power Drift = 0.12 dB

Peak SAR (extrapolated) = 7.35 W/kg

**SAR(1 g) = 3.95 W/kg; SAR(10 g) = 1.99 W/kg**

Maximum value of SAR (measured) = 4.51 W/kg

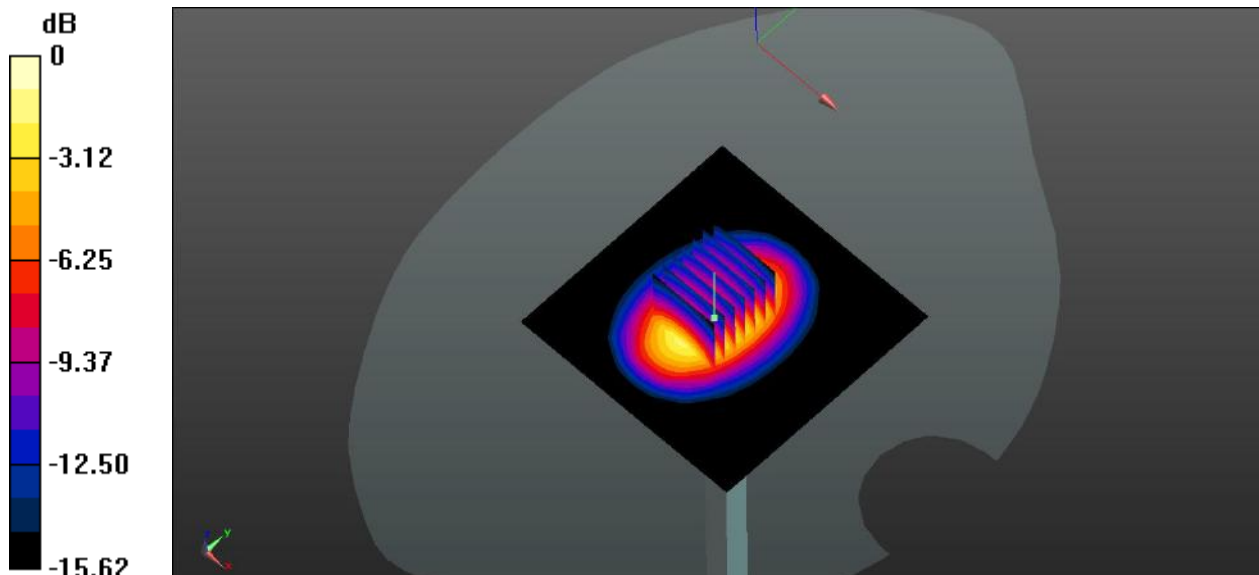

0 dB = 4.51 W/kg

## System Performance Check Data (1900MHz Head)

Date: 2022.10.07

Communication System Band: D1900 (1900.0 MHz); Frequency: 1900 MHz; Duty Cycle: 1:1

Medium parameters used:  $f = 1900$  MHz;  $\sigma = 1.388$  S/m;  $\epsilon_r = 39.907$ ;  $\rho = 1000$  kg/m<sup>3</sup>

Phantom section: Flat Section

Ambient Temperature: 22.7°C Liquid Temperature: 21.1°C

DASY5 Configuration:

- Probe: EX3DV4 - SN7607; ConvF(8.4, 8.4, 8.4); Calibrated: 2022.07.04;
- Sensor-Surface: 4mm (Mechanical Surface Detection)
- Electronics: DAE4 Sn878; Calibrated: 2022.06.13
- Phantom: SAM1; Type: QD000P40CD; Serial: TP:1576
- Measurement SW: DASY52, Version 52.8 (8); SEMCAD X Version 14.6.10 (7331)

**CW 1900 100mW/Area Scan (101x101x1):** Interpolated grid: dx=1.000 mm, dy=1.000 mm

Maximum value of SAR (interpolated) = 4.55 W/kg

**CW 1900 100mW/Zoom Scan (7x7x7)/Cube 0:** Measurement grid: dx=5mm, dy=5mm, dz=5mm

Reference Value = 55.76 V/m; Power Drift = -0.06 dB

Peak SAR (extrapolated) = 7.32 W/kg

**SAR(1 g) = 4.14 W/kg; SAR(10 g) = 2.11 W/kg**

Maximum value of SAR (measured) = 4.54 W/kg

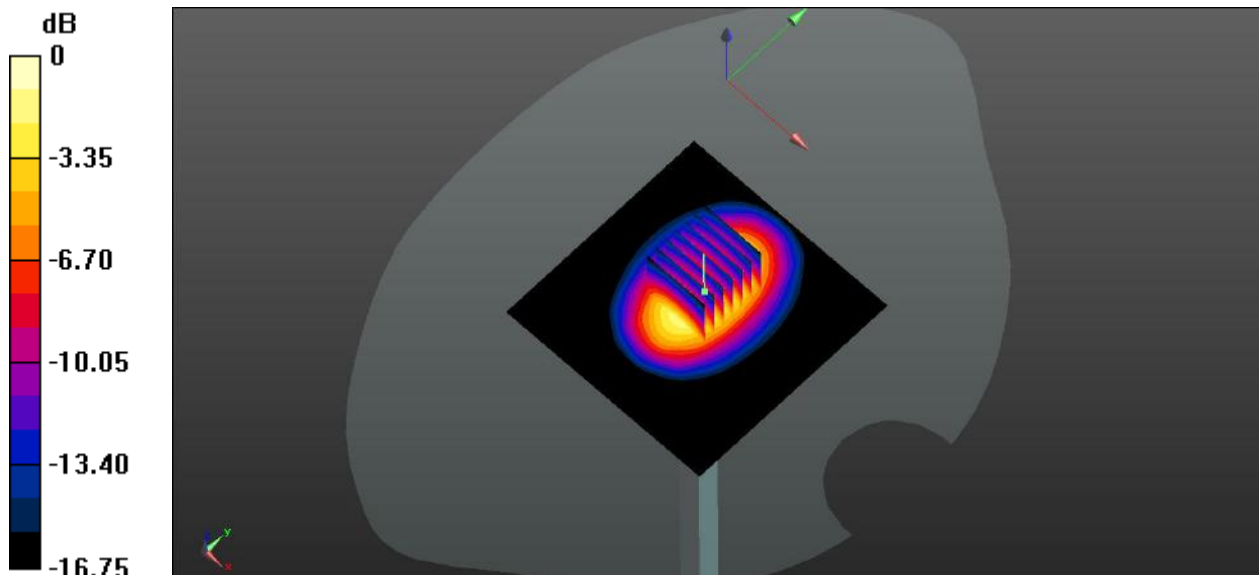

0 dB = 4.54 W/kg

## System Performance Check Data (2450MHz Head)

Date: 2022.10.08

Communication System Band: D2450 (2450.0 MHz); Frequency: 2450 MHz; Duty Cycle: 1:1

Medium parameters used:  $f = 2450$  MHz;  $\sigma = 1.803$  S/m;  $\epsilon_r = 39.49$ ;  $\rho = 1000$  kg/m<sup>3</sup>

Phantom section: Flat Section

Ambient Temperature: 22.5°C Liquid Temperature: 21.1°C

DASY5 Configuration:

- Probe: EX3DV4 - SN7607; ConvF(7.79, 7.79, 7.79); Calibrated: 2022.07.04;
- Sensor-Surface: 4mm (Mechanical Surface Detection)
- Electronics: DAE4 Sn878; Calibrated: 2022.06.13
- Phantom: SAM1; Type: QD000P40CD; Serial: TP:1576
- Measurement SW: DASY52, Version 52.8 (8); SEMCAD X Version 14.6.10 (7331)

**CW 2450 100mW/Area Scan (101x101x1):** Interpolated grid: dx=1.000 mm, dy=1.000 mm

Maximum value of SAR (interpolated) = 6.25 W/kg

**CW 2450 100mW/Zoom Scan (7x7x7)/Cube 0:** Measurement grid: dx=5mm, dy=5mm, dz=5mm

Reference Value = 50.73 V/m; Power Drift = 0.11 dB

Peak SAR (extrapolated) = 10.8 W/kg

**SAR(1 g) = 5.27 W/kg; SAR(10 g) = 2.43 W/kg**

Maximum value of SAR (measured) = 6.10 W/kg

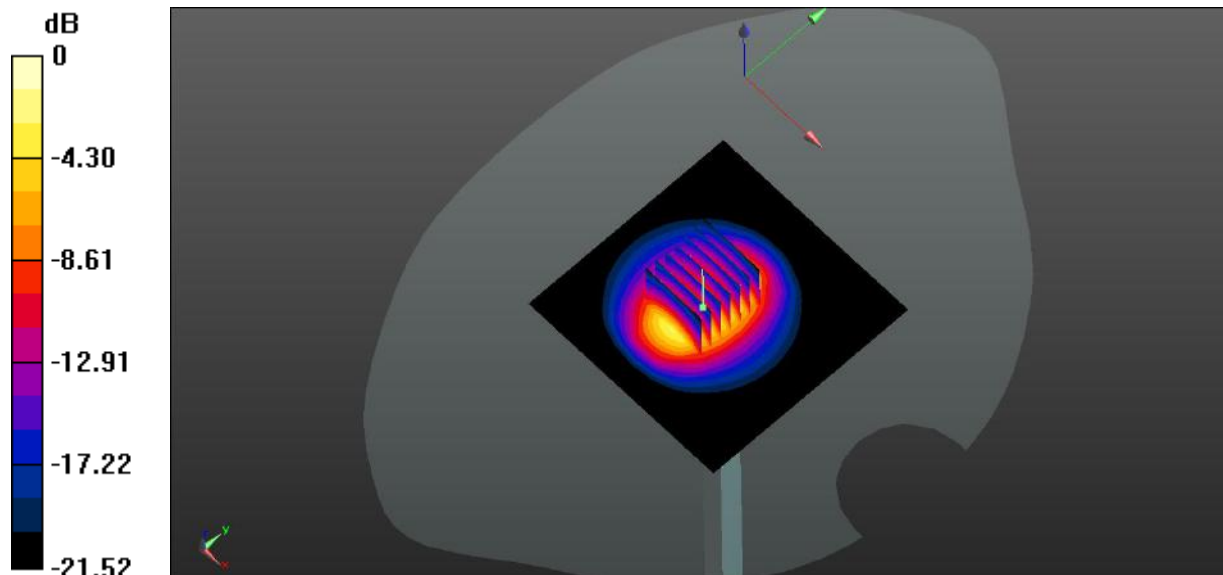

0 dB = 6.10 W/kg



## System Performance Check Data (2600MHz Head)

Date: 2022.10.09

Communication System Band: D2600 (2600.0 MHz); Frequency: 2600 MHz; Duty Cycle: 1:1

Medium parameters used (extrapolated):  $f = 2600$  MHz;  $\sigma = 1.987$  S/m;  $\epsilon_r = 38.512$ ;  $\rho = 1000$  kg/m<sup>3</sup>

Phantom section: Flat Section

Ambient Temperature: 22.4°C Liquid Temperature: 21.4°C

DASY5 Configuration:

- Probe: EX3DV4 - SN7607; ConvF(7.56, 7.56, 7.56); Calibrated: 2022.07.04;
- Sensor-Surface: 4mm (Mechanical Surface Detection)
- Electronics: DAE4 Sn878; Calibrated: 2022.06.13
- Phantom: SAM1; Type: QD000P40CD; Serial: TP:1576
- Measurement SW: DASY52, Version 52.8 (8); SEMCAD X Version 14.6.10 (7331)

**CW 2600 100mW/Area Scan (101x101x1):** Interpolated grid: dx=1.000 mm, dy=1.000 mm

Maximum value of SAR (interpolated) = 6.46 W/kg

**CW 2600 100mW/Zoom Scan (7x7x7)/Cube 0:** Measurement grid: dx=5mm, dy=5mm, dz=5mm

Reference Value = 56.55 V/m; Power Drift = -0.05 dB

Peak SAR (extrapolated) = 12.7 W/kg

**SAR(1 g) = 5.55 W/kg; SAR(10 g) = 2.41 W/kg**

Maximum value of SAR (measured) = 6.41 W/kg

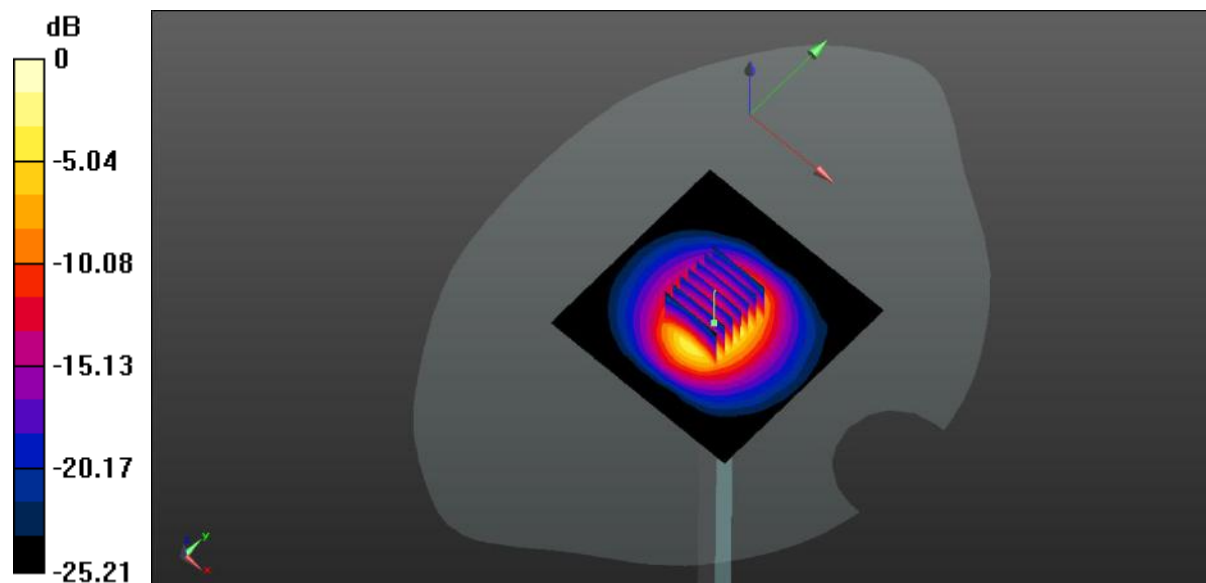

0 dB = 6.41 W/kg

# System Performance Check Data (2600MHz Head)

Date: 2022.10.10

Communication System Band: D2600 (2600.0 MHz); Frequency: 2600 MHz; Duty Cycle: 1:1

Medium parameters used:  $f = 2600$  MHz;  $\sigma = 1.971$  S/m;  $\epsilon_r = 38.484$ ;  $\rho = 1000$  kg/m<sup>3</sup>

Phantom section: Flat Section

Ambient Temperature: 22.6°C Liquid Temperature: 21.5°C

DASY5 Configuration:

- Probe: EX3DV4 - SN7607; ConvF(7.56, 7.56, 7.56); Calibrated: 2022.07.04;
- Sensor-Surface: 4mm (Mechanical Surface Detection)
- Electronics: DAE4 Sn878; Calibrated: 2022.06.13
- Phantom: SAM1; Type: QD000P40CD; Serial: TP:1576
- Measurement SW: DASY52, Version 52.8 (8); SEMCAD X Version 14.6.10 (7331)

**CW 2600 100mW/Area Scan (101x101x1):** Interpolated grid: dx=1.000 mm, dy=1.000 mm

Maximum value of SAR (interpolated) = 6.45 W/kg

**CW 2600 100mW/Zoom Scan (7x7x7)/Cube 0:** Measurement grid: dx=5mm, dy=5mm, dz=5mm

Reference Value = 50.43 V/m; Power Drift = -0.09 dB

Peak SAR (extrapolated) = 11.3 W/kg

**SAR(1 g) = 5.42 W/kg; SAR(10 g) = 2.41 W/kg**

Maximum value of SAR (measured) = 6.33 W/kg

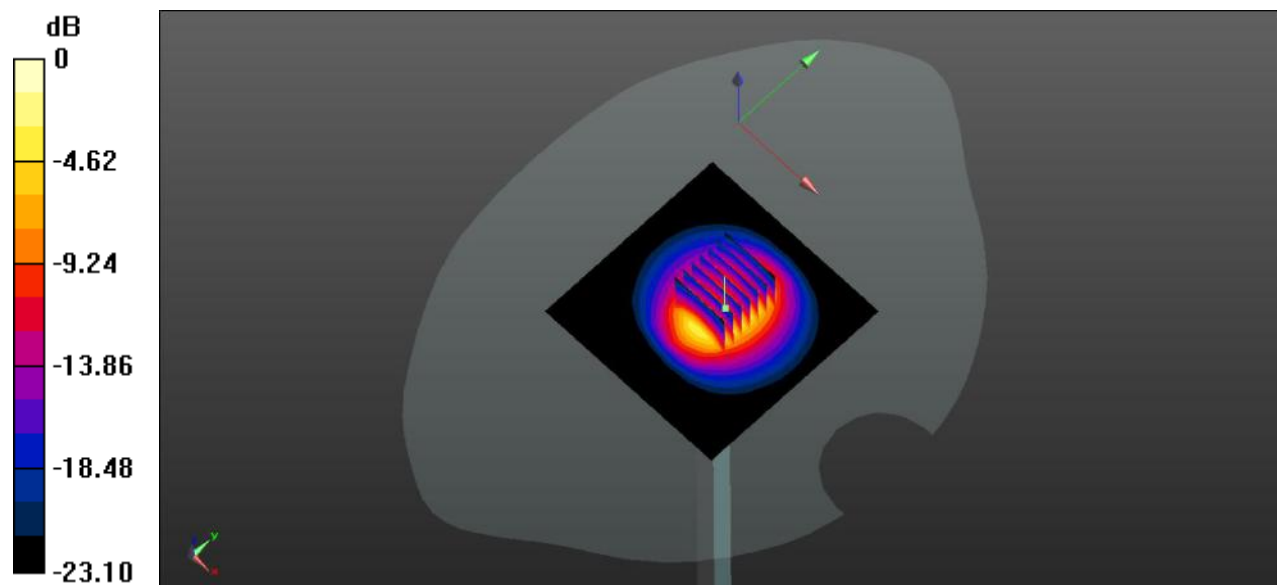

0 dB = 6.33 W/kg

## System Performance Check Data (2600MHz Head)

Date: 2022.10.11

Communication System Band: D2600 (2600.0 MHz); Frequency: 2600 MHz; Duty Cycle: 1:1

Medium parameters used (interpolated):  $f = 2600$  MHz;  $\sigma = 1.972$  S/m;  $\epsilon_r = 38.558$ ;  $\rho = 1000$  kg/m<sup>3</sup>

Phantom section: Flat Section

Ambient Temperature: 22.7°C Liquid Temperature: 21.3°C

DASY5 Configuration:

- Probe: EX3DV4 - SN7607; ConvF(7.56, 7.56, 7.56); Calibrated: 2022.07.04;
- Sensor-Surface: 4mm (Mechanical Surface Detection)
- Electronics: DAE4 Sn878; Calibrated: 2022.06.13
- Phantom: SAM1; Type: QD000P40CD; Serial: TP:1576
- Measurement SW: DASY52, Version 52.8 (8); SEMCAD X Version 14.6.10 (7331)

**CW 2600 100mW /Area Scan (101x101x1): Interpolated grid: dx=1.000 mm, dy=1.000 mm**

Maximum value of SAR (interpolated) = 6.60 W/kg

**CW 2600 100mW /Zoom Scan (7x7x7)/Cube 0: Measurement grid: dx=5mm, dy=5mm, dz=5mm**

Reference Value = 45.73 V/m; Power Drift = -0.12 dB

Peak SAR (extrapolated) = 12.5 W/kg

**SAR(1 g) = 5.72 W/kg; SAR(10 g) = 2.51 W/kg**

Maximum value of SAR (measured) = 6.47 W/kg

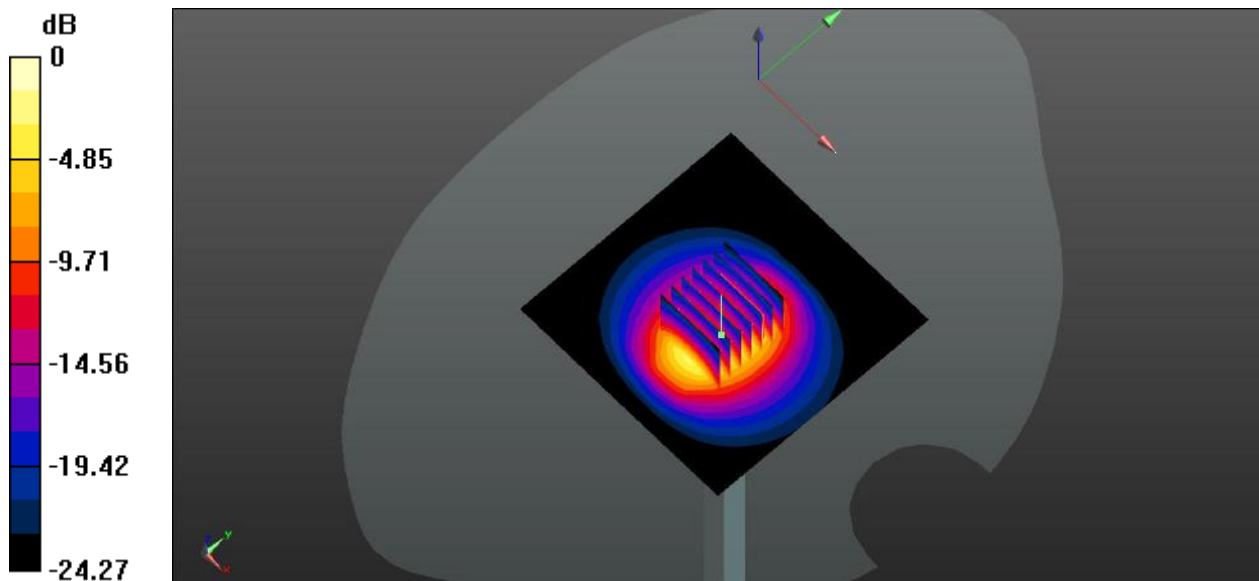

0 dB = 6.47 W/kg

## System Performance Check Data (2600MHz Head)

Date: 2022.10.12

Communication System Band: D2600 (2600.0 MHz); Frequency: 2600 MHz; Duty Cycle: 1:1

Medium parameters used:  $f = 2600$  MHz;  $\sigma = 1.988$  S/m;  $\epsilon_r = 38.443$ ;  $\rho = 1000$  kg/m<sup>3</sup>

Phantom section: Flat Section

Ambient Temperature: 22.8°C Liquid Temperature: 21.6°C

DASY5 Configuration:

- Probe: EX3DV4 - SN7607; ConvF(7.56, 7.56, 7.56); Calibrated: 2022.07.04;
- Sensor-Surface: 4mm (Mechanical Surface Detection)
- Electronics: DAE4 Sn878; Calibrated: 2022.06.13
- Phantom: SAM1; Type: QD000P40CD; Serial: TP:1576
- Measurement SW: DASY52, Version 52.8 (8); SEMCAD X Version 14.6.10 (7331)

**CW2600 HEAD 100mW/Area Scan (101x101x1):** Interpolated grid: dx=1.000 mm, dy=1.000 mm

Maximum value of SAR (interpolated) = 6.29 W/kg

**CW2600 HEAD 100mW/Zoom Scan (7x7x7)/Cube 0:** Measurement grid: dx=5mm, dy=5mm, dz=5mm

Reference Value = 56.23 V/m; Power Drift = 0.13 dB

Peak SAR (extrapolated) = 12.7 W/kg

**SAR(1 g) = 5.67 W/kg; SAR(10 g) = 2.49 W/kg**

Maximum value of SAR (measured) = 6.31 W/kg

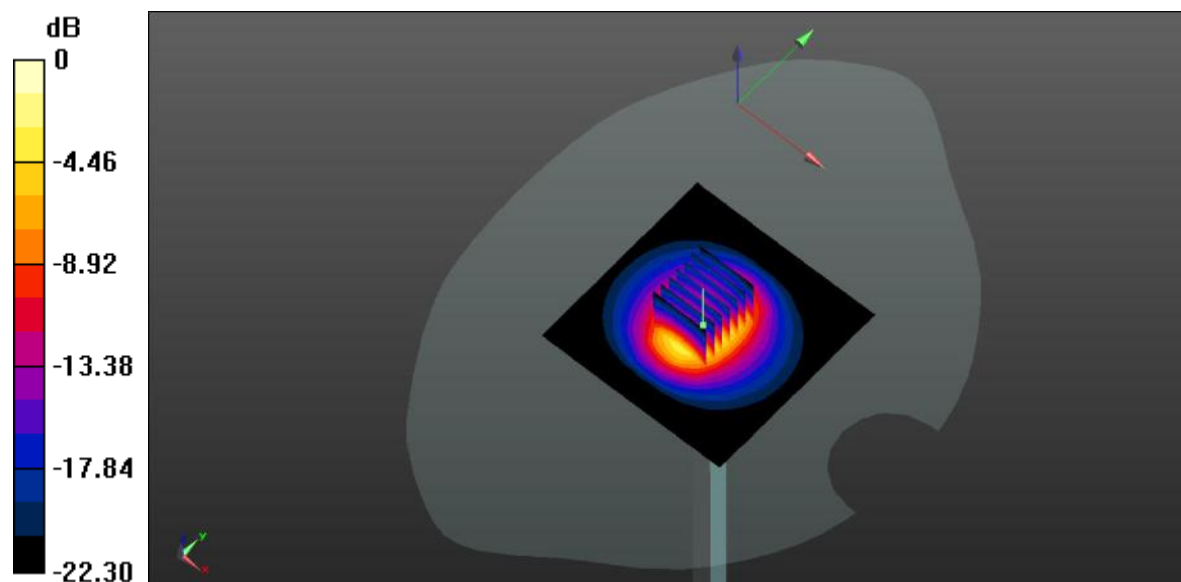

0 dB = 6.31 W/kg

## System Performance Check Data (2600MHz Head)

Date: 2022.10.13

Communication System Band: D2600 (2600.0 MHz); Frequency: 2600 MHz; Duty Cycle: 1:1

Medium parameters used:  $f = 2600$  MHz;  $\sigma = 1.998$  S/m;  $\epsilon_r = 38.631$ ;  $\rho = 1000$  kg/m<sup>3</sup>

Phantom section: Flat Section

Ambient Temperature: 22.9°C Liquid Temperature: 21.8°C

DASY5 Configuration:

- Probe: EX3DV4 - SN7607; ConvF(7.56, 7.56, 7.56); Calibrated: 2022.07.04;
- Sensor-Surface: 4mm (Mechanical Surface Detection)
- Electronics: DAE4 Sn878; Calibrated: 2022.06.13
- Phantom: SAM1; Type: QD000P40CD; Serial: TP:1576
- Measurement SW: DASY52, Version 52.8 (8); SEMCAD X Version 14.6.10 (7331)

**CW2600 Body 100mw/Area Scan (101x101x1):** Interpolated grid:  $dx=1.000$  mm,  $dy=1.000$  mm

Maximum value of SAR (interpolated) = 6.19 W/kg

**CW2600 Body 100mw/Zoom Scan (7x7x7)/Cube 0:** Measurement grid:  $dx=5$ mm,  $dy=5$ mm,  $dz=5$ mm

Reference Value = 40.20 V/m; Power Drift = 0.06 dB

Peak SAR (extrapolated) = 12.3 W/kg

**SAR(1 g) = 5.82 W/kg; SAR(10 g) = 2.56 W/kg**

Maximum value of SAR (measured) = 6.29 W/kg

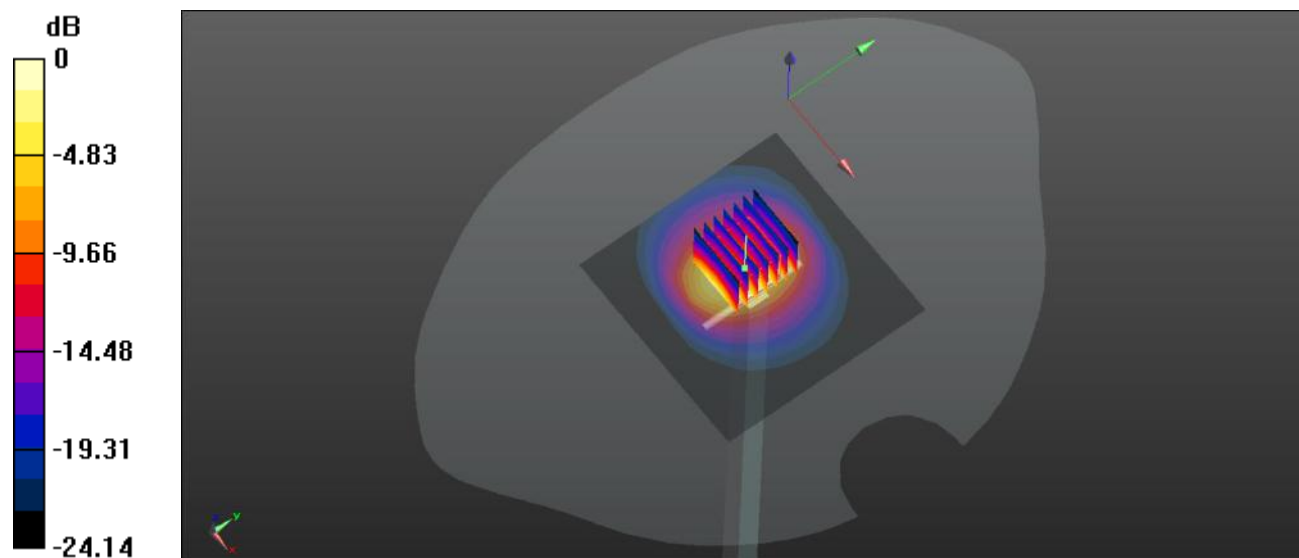

0 dB = 6.29 W/kg

## System Performance Check Data (2600MHz Head)

Date: 2022.10.14

Communication System Band: D2600 (2600.0 MHz); Frequency: 2600 MHz; Duty Cycle: 1:1

Medium parameters used:  $f = 2600$  MHz;  $\sigma = 1.969$  S/m;  $\epsilon_r = 38.571$ ;  $\rho = 1000$  kg/m<sup>3</sup>

Phantom section: Flat Section

Ambient Temperature: 22.4°C Liquid Temperature: 21.5°C

DASY5 Configuration:

- Probe: EX3DV4 - SN7607; ConvF(7.56, 7.56, 7.56); Calibrated: 2022.07.04;
- Sensor-Surface: 4mm (Mechanical Surface Detection)
- Electronics: DAE4 Sn878; Calibrated: 2022.06.13
- Phantom: SAM1; Type: QD000P40CD; Serial: TP:1576
- Measurement SW: DASY52, Version 52.8 (8); SEMCAD X Version 14.6.10 (7331)

**CW2600 Head 100mw/Area Scan (101x101x1):** Interpolated grid: dx=1.000 mm, dy=1.000 mm

Maximum value of SAR (interpolated) = 6.73 W/kg

**CW2600 Head 100mw/Zoom Scan (7x7x7)/Cube 0:** Measurement grid: dx=5mm, dy=5mm, dz=5mm

Reference Value = 48.39 V/m; Power Drift = -0.01 dB

Peak SAR (extrapolated) = 13.6 W/kg

**SAR(1 g) = 5.85 W/kg; SAR(10 g) = 2.57 W/kg**

Maximum value of SAR (measured) = 6.68 W/kg

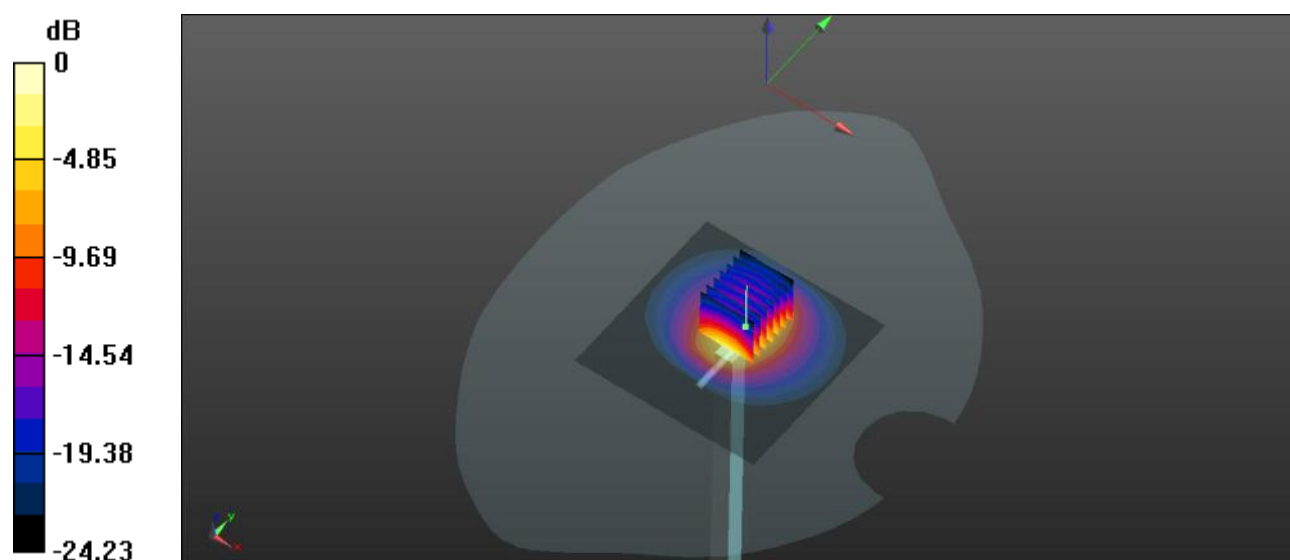

0 dB = 6.68 W/kg

# System Performance Check Data (3500MHz Head)

Date: 2022.10.15

Communication System Band: D3500 (3300.0 - 3600.0 MHz); Frequency: 3500 MHz; Duty Cycle: 1:1

Medium parameters used:  $f = 3500$  MHz;  $\sigma = 2.873$  S/m;  $\epsilon_r = 38.35$ ;  $\rho = 1000$  kg/m<sup>3</sup>

Phantom section: Flat Section

Ambient Temperature: 22.3°C Liquid Temperature: 21.2°C

DASY5 Configuration:

- Probe: EX3DV4 - SN7607; ConvF(6.9, 6.9, 6.9); Calibrated: 2022.07.04;
- Sensor-Surface: 4mm (Mechanical Surface Detection)
- Electronics: DAE4 Sn878; Calibrated: 2022.06.13
- Phantom: SAM1; Type: QD000P40CD; Serial: TP:1576
- Measurement SW: DASY52, Version 52.8 (8); SEMCAD X Version 14.6.10 (7331)

**CW 3500/Area Scan (81x81x1):** Interpolated grid: dx=1.000 mm, dy=1.000 mm

Maximum value of SAR (interpolated) = 8.35 W/kg

**CW 3500/Zoom Scan (7x7x8)/Cube 0:** Measurement grid: dx=5mm, dy=5mm, dz=4mm

Reference Value = 47.94 V/m; Power Drift = -0.17 dB

Peak SAR (extrapolated) = 20.3 W/kg

**SAR(1 g) = 6.91 W/kg; SAR(10 g) = 2.52 W/kg**

Maximum value of SAR (measured) = 12.63 W/kg

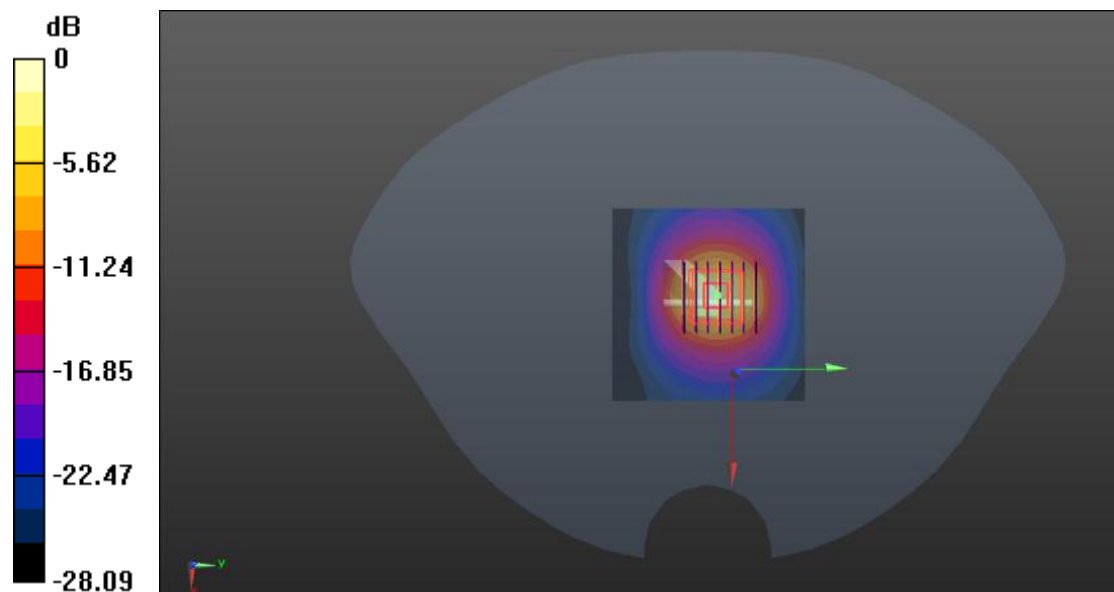

0 dB = 12.63 W/kg

## System Performance Check Data (3500MHz Head)

Date: 2022.10.18

Communication System Band: D3500 (3500.0 MHz); Frequency: 3500 MHz; Duty Cycle: 1:1

Medium parameters used:  $f = 3500$  MHz;  $\sigma = 2.875$  S/m;  $\epsilon_r = 38.332$ ;  $\rho = 1000$  kg/m<sup>3</sup>

Phantom section: Flat Section

Ambient Temperature: 22.6°C Liquid Temperature: 21.5°C

DASY5 Configuration:

- Probe: EX3DV4 - SN7607; ConvF(6.9, 6.9, 6.9); Calibrated: 2022.07.04;
- Sensor-Surface: 4mm (Mechanical Surface Detection)
- Electronics: DAE4 Sn878; Calibrated: 2022.06.13
- Phantom: SAM1; Type: QD000P40CD; Serial: TP:1576
- Measurement SW: DASY52, Version 52.8 (8); SEMCAD X Version 14.6.10 (7331)

**CW 3500/Area Scan (81x81x1):** Interpolated grid: dx=1.000 mm, dy=1.000 mm

Maximum value of SAR (interpolated) = 8.18 W/kg

**CW 3500/Zoom Scan (7x7x8)/Cube 0:** Measurement grid: dx=5mm, dy=5mm, dz=4mm

Reference Value = 46.93 V/m; Power Drift = 0.04 dB

Peak SAR (extrapolated) = 19.78 W/kg

**SAR(1 g) = 6.91 W/kg; SAR(10 g) = 2.46 W/kg**

Maximum value of SAR (measured) = 12.27 W/kg

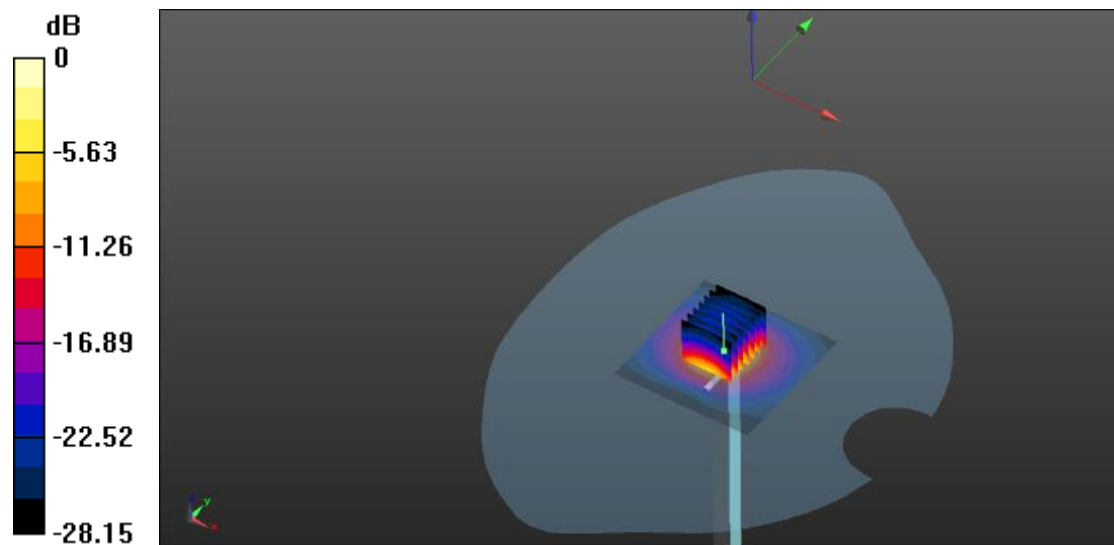

0 dB = 12.27 W/kg



## System Performance Check Data (3500MHz Head)

Date: 2022.10.20

Communication System Band: D3500 (3500.0 MHz); Frequency: 3500 MHz; Duty Cycle: 1:1

Medium parameters used:  $f = 3500$  MHz;  $\sigma = 2.875$  S/m;  $\epsilon_r = 38.198$ ;  $\rho = 1000$  kg/m<sup>3</sup>

Phantom section: Flat Section

Ambient Temperature: 22.7°C Liquid Temperature: 21.4°C

DASY5 Configuration:

- Probe: EX3DV4 - SN7607; ConvF(6.9, 6.9, 6.9); Calibrated: 2022.07.04;
- Sensor-Surface: 4mm (Mechanical Surface Detection)
- Electronics: DAE4 Sn878; Calibrated: 2022.06.13
- Phantom: SAM1; Type: QD000P40CD; Serial: TP:1576
- Measurement SW: DASY52, Version 52.8 (8); SEMCAD X Version 14.6.10 (7331)

**CW 3500/Area Scan (81x81x1):** Interpolated grid: dx=1.000 mm, dy=1.000 mm

Maximum value of SAR (interpolated) = 8.18 W/kg

**CW 3500/Zoom Scan (7x7x8)/Cube 0:** Measurement grid: dx=5mm, dy=5mm, dz=4mm

Reference Value = 46.66 V/m; Power Drift = -0.15 dB

Peak SAR (extrapolated) = 19.52 W/kg

**SAR(1 g) = 6.72 W/kg; SAR(10 g) = 2.42 W/kg**

Maximum value of SAR (measured) = 11.88 W/kg

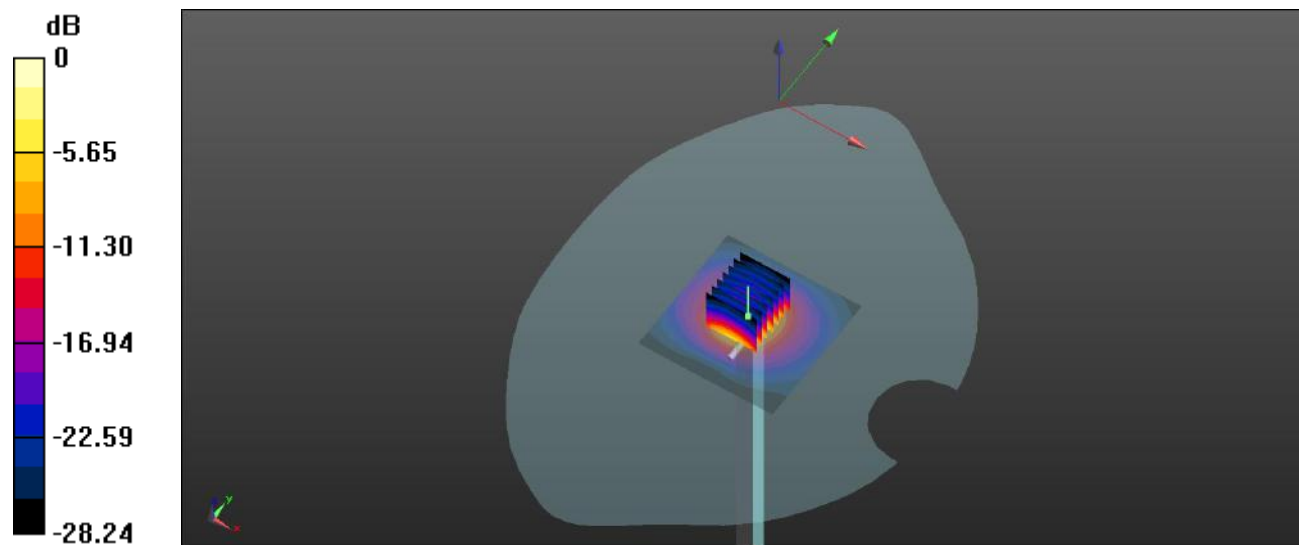

0 dB = 11.88 W/kg

## System Performance Check Data (3500MHz Head)

Date: 2022.10.21

Communication System Band: D3500 (3500.0 MHz); Frequency: 3500 MHz; Duty Cycle: 1:1

Medium parameters used:  $f = 3500$  MHz;  $\sigma = 2.877$  S/m;  $\epsilon_r = 38.289$ ;  $\rho = 1000$  kg/m<sup>3</sup>

Phantom section: Flat Section

Ambient Temperature: 22.1°C Liquid Temperature: 21.1°C

DASY5 Configuration:

- Probe: EX3DV4 - SN7607; ConvF(6.9, 6.9, 6.9); Calibrated: 2022.07.04;
- Sensor-Surface: 4mm (Mechanical Surface Detection)
- Electronics: DAE4 Sn878; Calibrated: 2022.06.13
- Phantom: SAM1; Type: QD000P40CD; Serial: TP:1576
- Measurement SW: DASY52, Version 52.8 (8); SEMCAD X Version 14.6.10 (7331)

**CW 3500/Area Scan (81x81x1):** Interpolated grid: dx=1.000 mm, dy=1.000 mm

Maximum value of SAR (interpolated) = 8.18 W/kg

**CW 3500/Zoom Scan (7x7x8)/Cube 0:** Measurement grid: dx=5mm, dy=5mm, dz=4mm

Reference Value = 46.83 V/m; Power Drift = 0.05 dB

Peak SAR (extrapolated) = 19.7 W/kg

**SAR(1 g) = 6.81 W/kg; SAR(10 g) = 2.47 W/kg**

Maximum value of SAR (measured) = 12.28 W/kg

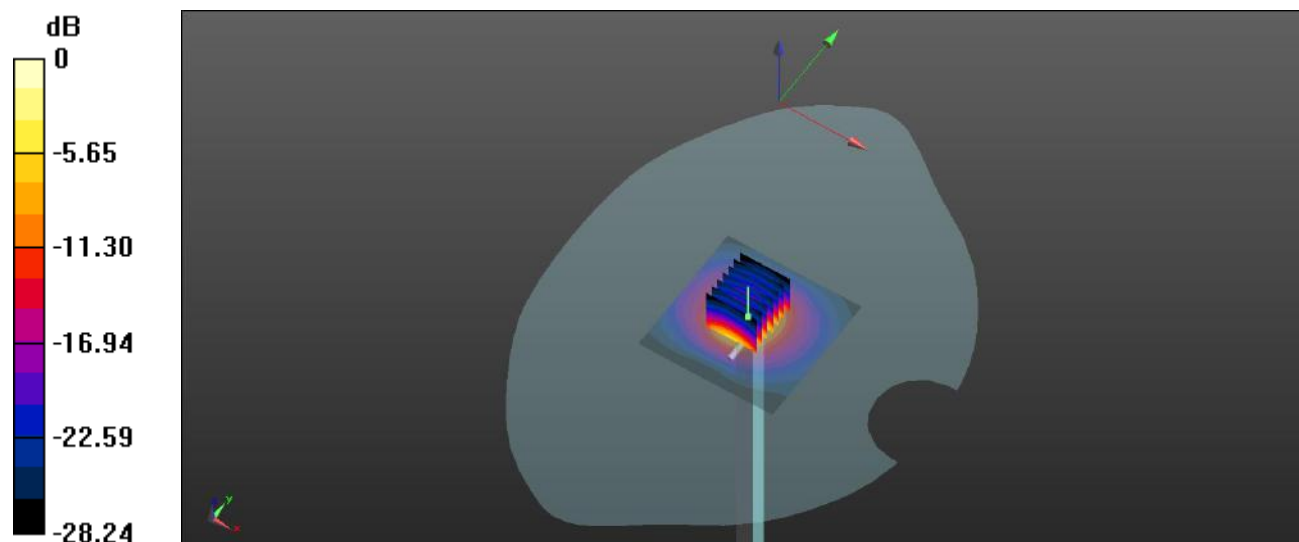

0 dB = 12.28 W/kg

## System Performance Check Data (3700MHz Head)

Date: 2022.10.15

Communication System Band: D3700 (3700.0 MHz); Frequency: 3700 MHz; Duty Cycle: 1:1

Medium parameters used:  $f = 3700$  MHz;  $\sigma = 3.129$  S/m;  $\epsilon_r = 37.713$ ;  $\rho = 1000$  kg/m<sup>3</sup>

Phantom section: Flat Section

Ambient Temperature: 22.3°C Liquid Temperature: 21.2°C

DASY5 Configuration:

- Probe: EX3DV4 - SN7607; ConvF(6.74, 6.74, 6.74); Calibrated: 2022.07.04;
- Sensor-Surface: 4mm (Mechanical Surface Detection)
- Electronics: DAE4 Sn878; Calibrated: 2022.06.13
- Phantom: SAM1; Type: QD000P40CD; Serial: TP:1576
- Measurement SW: DASY52, Version 52.8 (8); SEMCAD X Version 14.6.10 (7331)

**CW 3700/Area Scan (81x81x1):** Interpolated grid:  $dx=1.000$  mm,  $dy=1.000$  mm

Maximum value of SAR (interpolated) = 9.51 W/kg

**CW 3700/Zoom Scan (7x7x8)/Cube 0:** Measurement grid:  $dx=5$ mm,  $dy=5$ mm,  $dz=4$ mm

Reference Value = 42.67 V/m; Power Drift = -0.05 dB

Peak SAR (extrapolated) = 22.84 W/kg

**SAR(1 g) = 6.62 W/kg; SAR(10 g) = 2.27 W/kg**

Maximum value of SAR (measured) = 12.23 W/kg

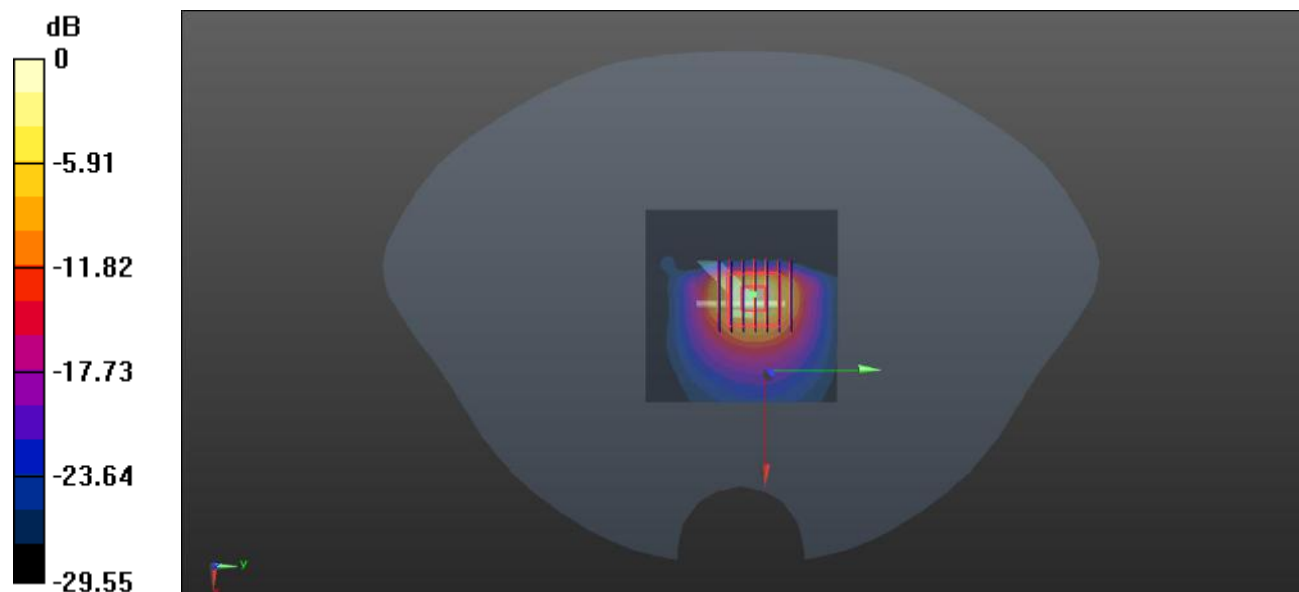

0 dB = 12.23 W/kg

## System Performance Check Data (3700MHz Head)

Date: 2022.10.19

Communication System Band: D3700 (3700.0 MHz); Frequency: 3700 MHz; Duty Cycle: 1:1

Medium parameters used:  $f = 3700$  MHz;  $\sigma = 3.132$  S/m;  $\epsilon_r = 37.783$ ;  $\rho = 1000$  kg/m<sup>3</sup>

Phantom section: Flat Section

Ambient Temperature: 21.9°C Liquid Temperature: 21.1°C

DASY5 Configuration:

- Probe: EX3DV4 - SN7607; ConvF(6.74, 6.74, 6.74); Calibrated: 2022.07.04;
- Sensor-Surface: 4mm (Mechanical Surface Detection)
- Electronics: DAE4 Sn878; Calibrated: 2022.06.13
- Phantom: SAM1; Type: QD000P40CD; Serial: TP:1576
- Measurement SW: DASY52, Version 52.8 (8); SEMCAD X Version 14.6.10 (7331)

**CW 3700/Area Scan (81x81x1):** Interpolated grid: dx=1.000 mm, dy=1.000 mm

Maximum value of SAR (interpolated) = 9.51 W/kg

**CW 3700/Zoom Scan (7x7x8)/Cube 0:** Measurement grid: dx=5mm, dy=5mm, dz=4mm

Reference Value = 42.99 V/m; Power Drift = -0.03 dB

Peak SAR (extrapolated) = 22.8 W/kg

**SAR(1 g) = 6.58 W/kg; SAR(10 g) = 2.29 W/kg**

Maximum value of SAR (measured) = 12.66 W/kg

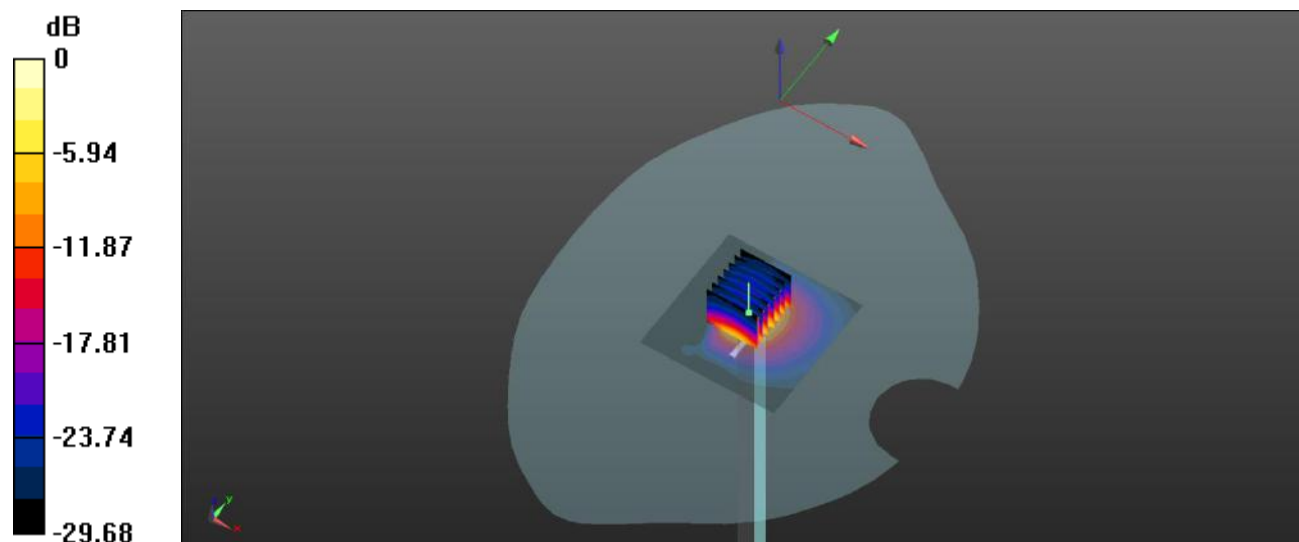

0 dB = 12.66 W/kg

## System Performance Check Data (3700MHz Head)

Date: 2022.10.20

Communication System Band: D3700 (3700.0 MHz); Frequency: 3700 MHz; Duty Cycle: 1:1

Medium parameters used:  $f = 3700$  MHz;  $\sigma = 3.129$  S/m;  $\epsilon_r = 37.551$ ;  $\rho = 1000$  kg/m<sup>3</sup>

Phantom section: Flat Section

Ambient Temperature: 22.7°C Liquid Temperature: 21.4°C

DASY5 Configuration:

- Probe: EX3DV4 - SN7607; ConvF(6.74, 6.74, 6.74); Calibrated: 2022.07.04;
- Sensor-Surface: 4mm (Mechanical Surface Detection)
- Electronics: DAE4 Sn878; Calibrated: 2022.06.13
- Phantom: SAM1; Type: QD000P40CD; Serial: TP:1576
- Measurement SW: DASY52, Version 52.8 (8); SEMCAD X Version 14.6.10 (7331)

**CW 3700/Area Scan (81x81x1):** Interpolated grid: dx=1.000 mm, dy=1.000 mm

Maximum value of SAR (interpolated) = 9.51 W/kg

**CW 3700/Zoom Scan (7x7x8)/Cube 0:** Measurement grid: dx=5mm, dy=5mm, dz=4mm

Reference Value = 43.15 V/m; Power Drift = 0.13 dB

Peak SAR (extrapolated) = 23.56 W/kg

**SAR(1 g) = 6.68 W/kg; SAR(10 g) = 2.29 W/kg**

Maximum value of SAR (measured) = 12.81 W/kg

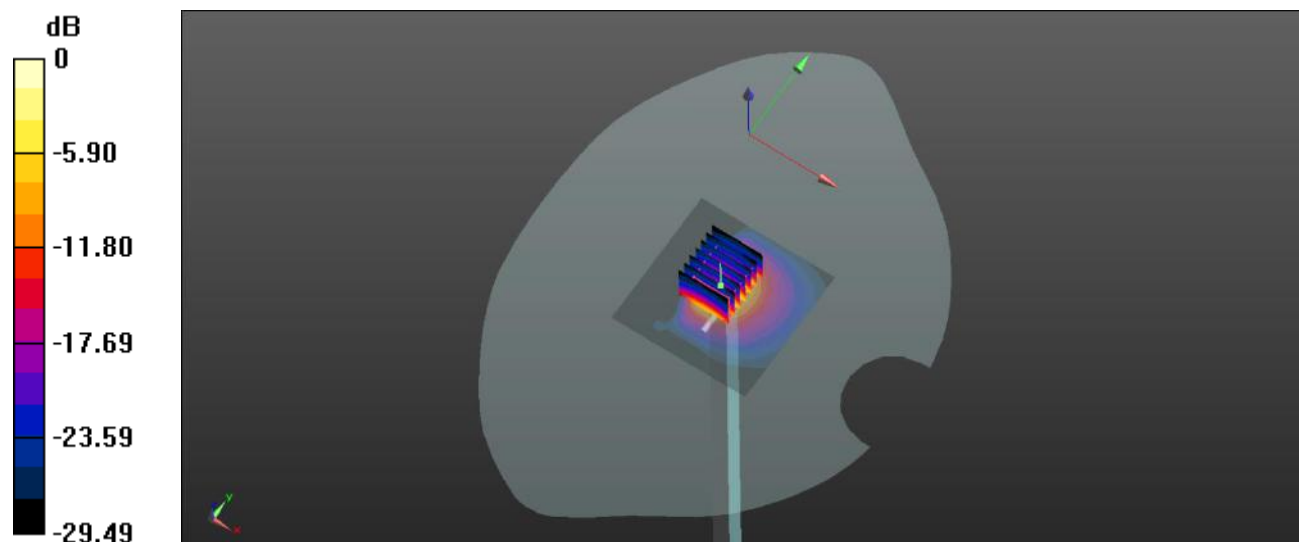

0 dB = 12.81 W/kg

## System Performance Check Data (3700MHz Head)

Date: 2022.10.22

Communication System Band: D3700 (3700.0 MHz); Frequency: 3700 MHz; Duty Cycle: 1:1

Medium parameters used:  $f = 3700$  MHz;  $\sigma = 3.131$  S/m;  $\epsilon_r = 37.803$ ;  $\rho = 1000$  kg/m<sup>3</sup>

Phantom section: Flat Section

Ambient Temperature: 21.8°C Liquid Temperature: 20.9°C

DASY5 Configuration:

- Probe: EX3DV4 - SN7607; ConvF(6.74, 6.74, 6.74); Calibrated: 2022.07.04;
- Sensor-Surface: 4mm (Mechanical Surface Detection)
- Electronics: DAE4 Sn878; Calibrated: 2022.06.13
- Phantom: SAM1; Type: QD000P40CD; Serial: TP:1576
- Measurement SW: DASY52, Version 52.8 (8); SEMCAD X Version 14.6.10 (7331)

**CW 3700/Area Scan (81x81x1):** Interpolated grid: dx=1.000 mm, dy=1.000 mm

Maximum value of SAR (interpolated) = 9.51 W/kg

**CW 3700/Zoom Scan (7x7x8)/Cube 0:** Measurement grid: dx=5mm, dy=5mm, dz=4mm

Reference Value = 43.02 V/m; Power Drift = 0.12 dB

Peak SAR (extrapolated) = 23.3 W/kg

**SAR(1 g) = 6.92 W/kg; SAR(10 g) = 2.46 W/kg**

Maximum value of SAR (measured) = 12.89 W/kg

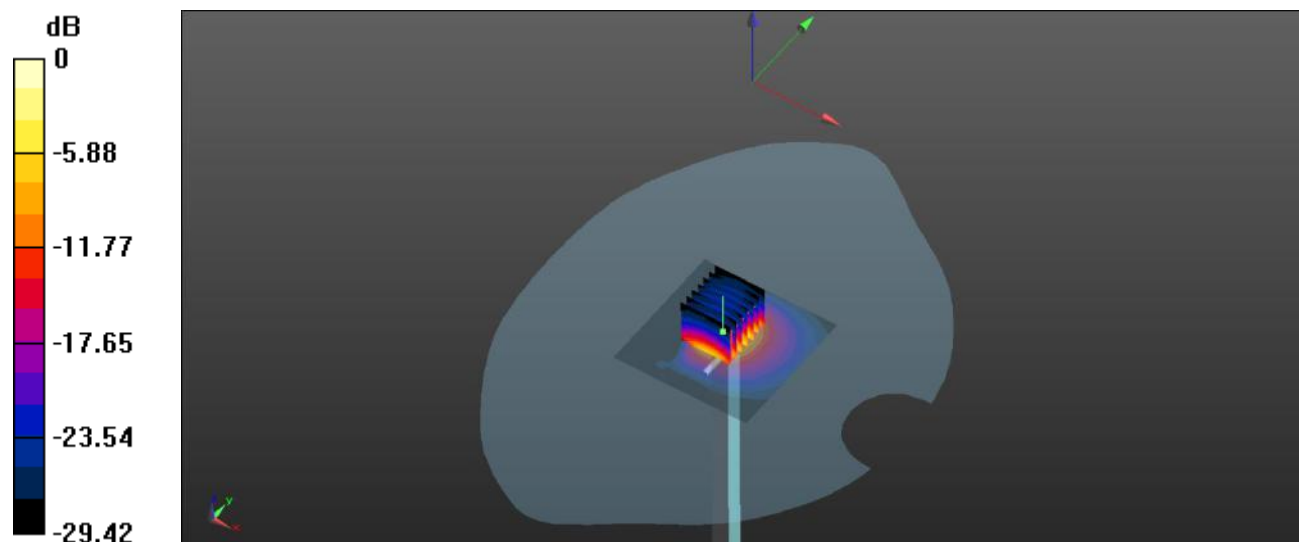

0 dB = 12.89 W/kg

## System Performance Check Data (3900MHz Head)

Date: 2022.10.15

Communication System Band: D3900 (3900.0 MHz); Frequency: 3900 MHz; Duty Cycle: 1:1

Medium parameters used:  $f = 3900$  MHz;  $\sigma = 3.385$  S/m;  $\epsilon_r = 37.356$ ;  $\rho = 1000$  kg/m<sup>3</sup>

Phantom section: Flat Section

Ambient Temperature: 22.3°C Liquid Temperature: 21.2°C

DASY5 Configuration:

- Probe: EX3DV4 - SN7607; ConvF(6.4, 6.4, 6.4); Calibrated: 2022.07.04;
- Sensor-Surface: 4mm (Mechanical Surface Detection)
- Electronics: DAE4 Sn878; Calibrated: 2022.06.13
- Phantom: SAM1; Type: QD000P40CD; Serial: TP:1576
- Measurement SW: DASY52, Version 52.8 (8); SEMCAD X Version 14.6.10 (7331)

**CW 3900/Area Scan (81x81x1):** Interpolated grid:  $dx=1.000$  mm,  $dy=1.000$  mm

Maximum value of SAR (interpolated) = 8.38 W/kg

**CW 3900/Zoom Scan (7x7x8)/Cube 0:** Measurement grid:  $dx=5$ mm,  $dy=5$ mm,  $dz=4$ mm

Reference Value = 47.01 V/m; Power Drift = 0.04 dB

Peak SAR (extrapolated) = 24.9 W/kg

**SAR(1 g) = 7.11 W/kg; SAR(10 g) = 2.35 W/kg**

Maximum value of SAR (measured) = 14.01 W/kg

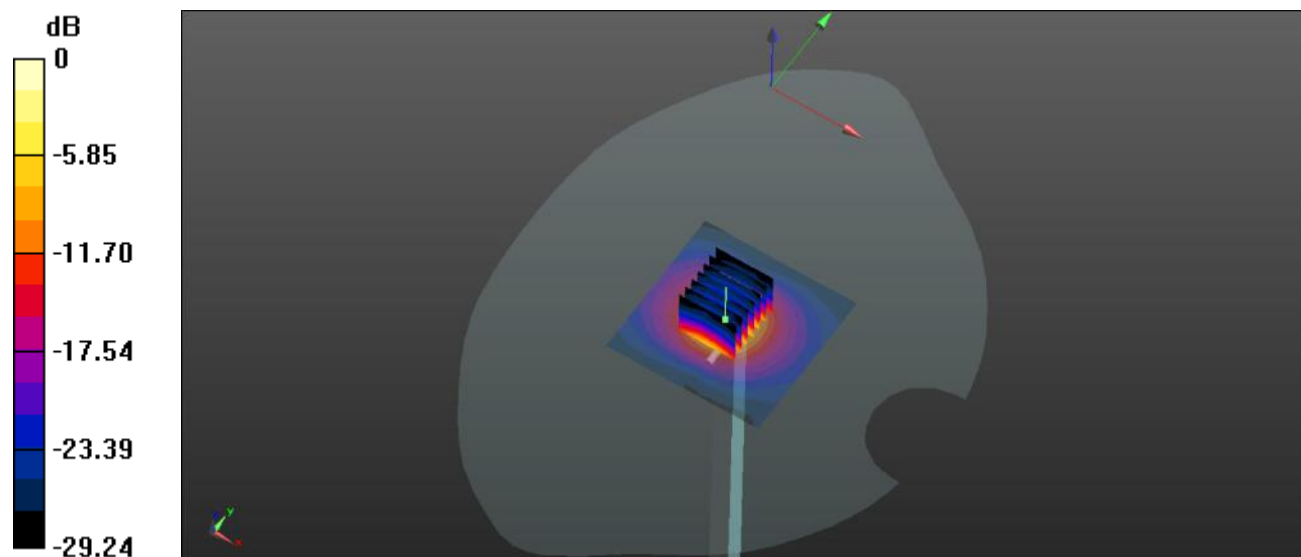

0 dB = 14.01 W/kg

# System Performance Check Data (3900MHz Head)

Date: 2022.10.19

Communication System Band: D3900 (3900.0 MHz); Frequency: 3900 MHz; Duty Cycle: 1:1

Medium parameters used:  $f = 3900 \text{ MHz}$ ;  $\sigma = 3.369 \text{ S/m}$ ;  $\epsilon_r = 37.156$ ;  $\rho = 1000 \text{ kg/m}^3$

Phantom section: Flat Section

Ambient Temperature: 21.9°C Liquid Temperature: 21.1°C

DASY5 Configuration:

- Probe: EX3DV4 - SN7607; ConvF(6.4, 6.4, 6.4); Calibrated: 2022.07.04;
- Sensor-Surface: 4mm (Mechanical Surface Detection)
- Electronics: DAE4 Sn878; Calibrated: 2022.06.13
- Phantom: SAM1; Type: QD000P40CD; Serial: TP:1576
- Measurement SW: DASY52, Version 52.8 (8); SEMCAD X Version 14.6.10 (7331)

**CW 3900/Area Scan (81x81x1):** Interpolated grid:  $dx=1.000 \text{ mm}$ ,  $dy=1.000 \text{ mm}$

Maximum value of SAR (interpolated) = 8.38 W/kg

**CW 3900/Zoom Scan (7x7x8)/Cube 0:** Measurement grid:  $dx=5\text{mm}$ ,  $dy=5\text{mm}$ ,  $dz=4\text{mm}$

Reference Value = 47.01 V/m; Power Drift = 0.02 dB

Peak SAR (extrapolated) = 24.9 W/kg

**SAR(1 g) = 7.21 W/kg; SAR(10 g) = 2.42 W/kg**

Maximum value of SAR (measured) = 13.96 W/kg

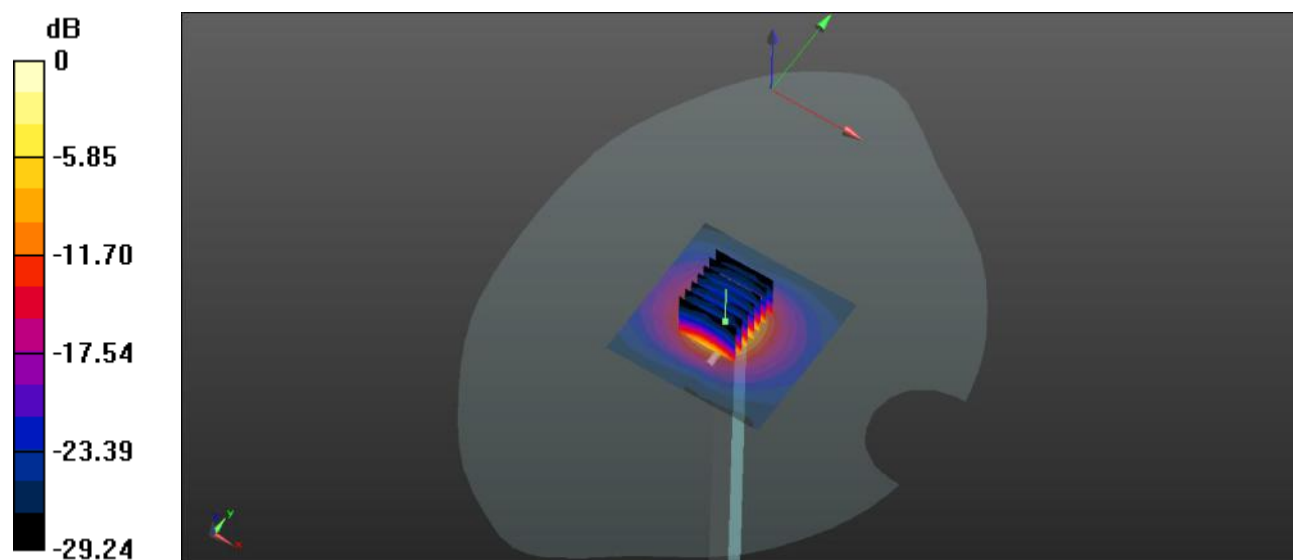

0 dB = 13.96 W/kg



## System Performance Check Data (5250MHz Head)

Date: 2022.10.23

Communication System Band: D5GHz (5000.0 - 6000.0 MHz); Frequency: 5250 MHz; Duty Cycle: 1:1

Medium parameters used:  $f = 5250$  MHz;  $\sigma = 4.696$  S/m;  $\epsilon_r = 35.986$ ;  $\rho = 1000$  kg/m<sup>3</sup>

Phantom section: Flat Section

Ambient Temperature: 22.6°C Liquid Temperature: 21.3°C

DASY5 Configuration:

- Probe: EX3DV4 - SN7607; ConvF(5.45, 5.45, 5.45); Calibrated: 2022.07.04;
- Sensor-Surface: 2mm (Mechanical Surface Detection)
- Electronics: DAE4 Sn878; Calibrated: 2022.06.13
- Phantom: SAM1; Type: QD000P40CD; Serial: TP:1576
- Measurement SW: DASY52, Version 52.8 (8); SEMCAD X Version 14.6.10 (7331)

**CW 5250 100mW /Area Scan (101x101x1):** Interpolated grid: dx=1.000 mm, dy=1.000 mm

Maximum value of SAR (interpolated) = 8.39 W/kg

**CW 5250 100mW /Zoom Scan (7x7x21)/Cube 0:** Measurement grid: dx=4mm, dy=4mm, dz=1.4mm

Reference Value = 37.06 V/m; Power Drift = 0.08 dB

Peak SAR (extrapolated) = 33.2 W/kg

**SAR(1 g) = 7.88 W/kg; SAR(10 g) = 2.28 W/kg**

Maximum value of SAR (measured) = 19.82 W/kg

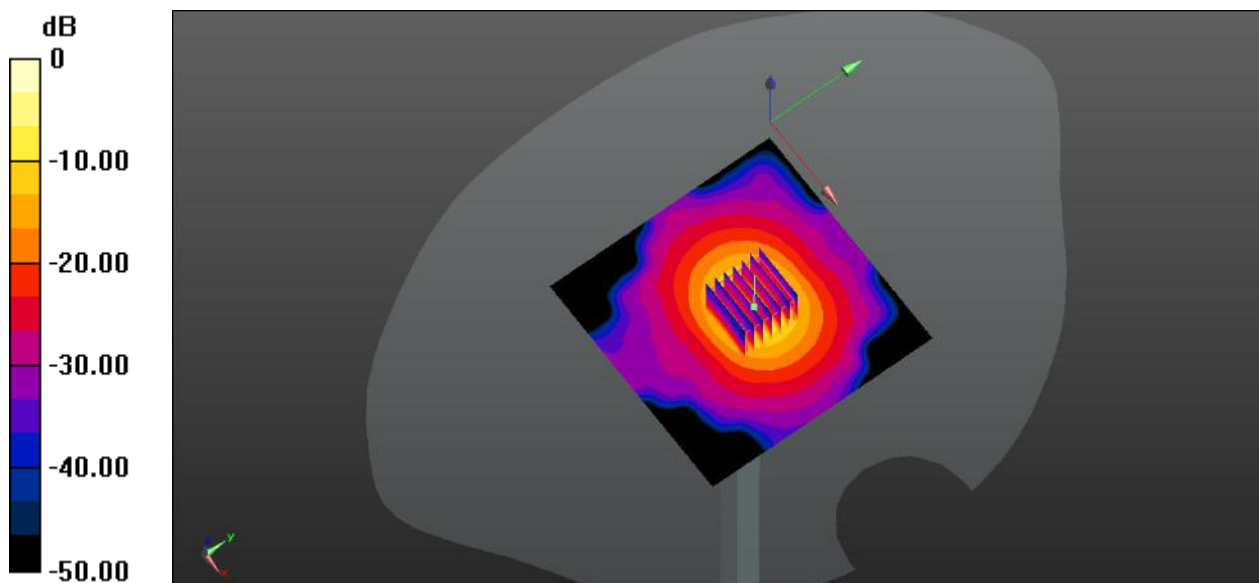

0 dB = 19.82 W/kg

## System Performance Check Data (5750MHz Head)

Date: 2022.10.24

Communication System Band: D5GHz (5000.0 - 6000.0 MHz); Frequency: 5750 MHz; Duty Cycle: 1:1

Medium parameters used:  $f = 5750$  MHz;  $\sigma = 5.175$  S/m;  $\epsilon_r = 35.609$ ;  $\rho = 1000$  kg/m<sup>3</sup>

Phantom section: Flat Section

Ambient Temperature: 22.5°C Liquid Temperature: 21.5°C

DASY5 Configuration:

- Probe: EX3DV4 - SN7607; ConvF(5, 5, 5); Calibrated: 2022.07.04;
- Sensor-Surface: 2mm (Mechanical Surface Detection)
- Electronics: DAE4 Sn878; Calibrated: 2022.06.13
- Phantom: SAM1; Type: QD000P40CD; Serial: TP:1576
- Measurement SW: DASY52, Version 52.8 (8); SEMCAD X Version 14.6.10 (7331)

**CW 5750 100mW/Area Scan (81x101x1):** Interpolated grid: dx=1.000 mm, dy=1.000 mm

Maximum value of SAR (interpolated) = 9.04 W/kg

**CW 5750 100mW/Zoom Scan (7x7x21)/Cube 0:** Measurement grid: dx=4mm, dy=4mm, dz=1.4mm

Reference Value = 33.35 V/m; Power Drift = -0.13 dB

Peak SAR (extrapolated) = 40.5 W/kg

**SAR(1 g) = 7.91 W/kg; SAR(10 g) = 2.22 W/kg**

Maximum value of SAR (measured) = 19.5 W/kg

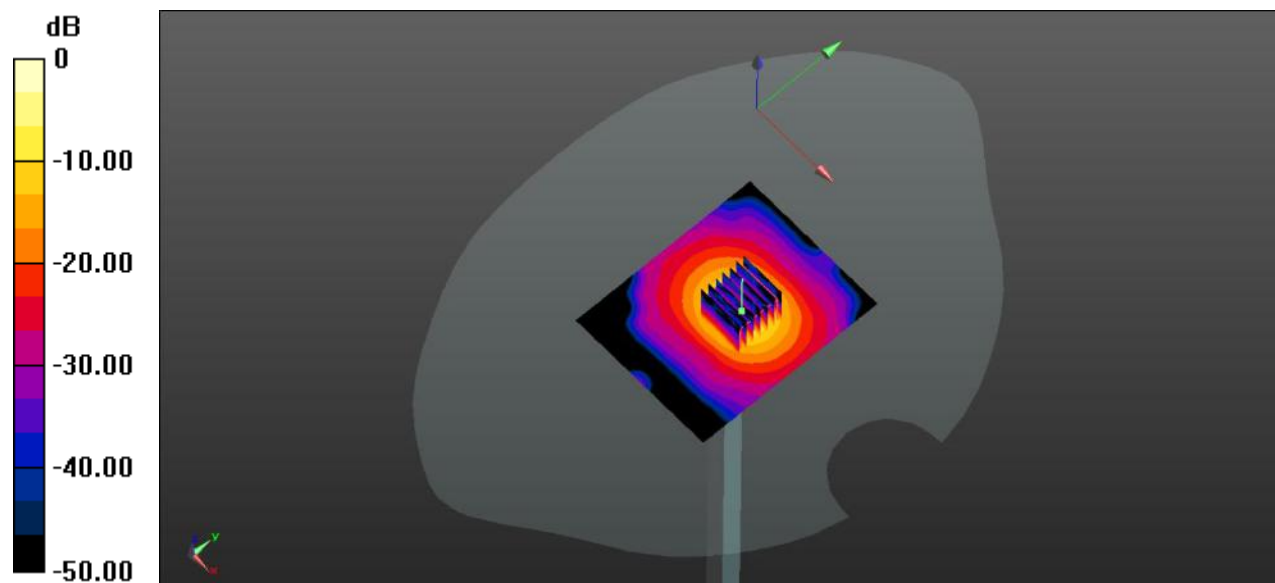

0 dB = 19.5 W/kg

## ANNEX C TEST DATA

### Meas.1 Right Head with Tilt on Middle Channel in GSM850 2Slots mode with Antenna.4

Date: 2022.10.01

Communication System Band: GSM850; Frequency: 836.6 MHz; Duty Cycle: 1:4.15

Medium parameters used (interpolated):  $f = 836.6$  MHz;  $\sigma = 0.905$  S/m;  $\epsilon_r = 41.741$ ;  $\rho = 1000$  kg/m<sup>3</sup>

Phantom section: Right Section

Ambient Temperature: 22.5°C Liquid Temperature: 21.3°C

DASY5 Configuration:

- Probe: EX3DV4 - SN7607; ConvF(10.44, 10.44, 10.44); Calibrated: 2022.07.04;
- Sensor-Surface: 4mm (Mechanical Surface Detection)
- Electronics: DAE4 Sn878; Calibrated: 2022.06.13
- Phantom: SAM1; Type: QD000P40CD; Serial: TP:1576
- Measurement SW: DASY52, Version 52.8 (8); SEMCAD X Version 14.6.10 (7331)

**Ch190/Area Scan (71x131x1):** Interpolated grid: dx=1.500 mm, dy=1.500 mm

Maximum value of SAR (interpolated) = 0.421 W/kg

**Ch190/Zoom Scan (5x5x7)/Cube 0:** Measurement grid: dx=8mm, dy=8mm, dz=5mm

Reference Value = 19.82 V/m; Power Drift = 0.13 dB

Peak SAR (extrapolated) = 0.598 W/kg

**SAR(1 g) = 0.49 W/kg; SAR(10 g) = 0.225 W/kg**

Maximum value of SAR (measured) = 0.319 W/kg

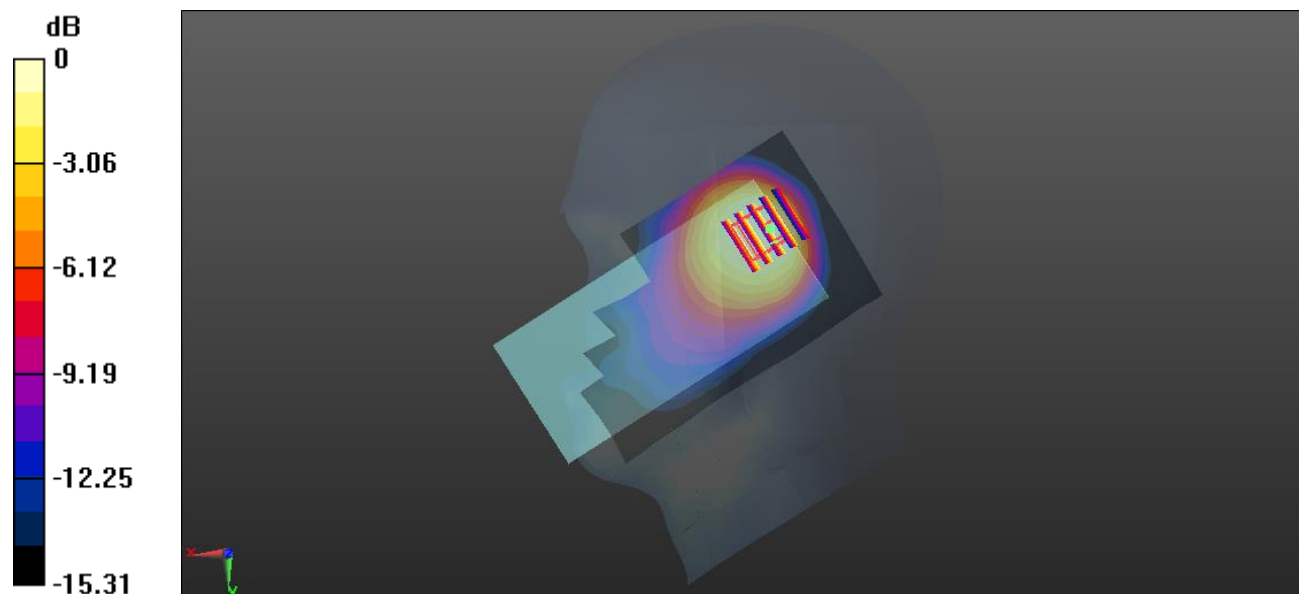

0 dB = 0.319 W/kg

**Meas.2 Body Plane with Back Side 10mm on Middle Channel in GSM850 2Slots mode with Antenna.1**

Date: 2022.10.01

Communication System Band: GSM850; Frequency: 836.6 MHz; Duty Cycle: 1:4.15

Medium parameters used (interpolated):  $f = 836.6$  MHz;  $\sigma = 0.905$  S/m;  $\epsilon_r = 41.741$ ;  $\rho = 1000$  kg/m<sup>3</sup>

Phantom section: Flat Section

Ambient Temperature: 22.5°C Liquid Temperature: 21.3°C

DASY5 Configuration:

- Probe: EX3DV4 - SN7607; ConvF(10.44, 10.44, 10.44); Calibrated: 2022.07.04;
- Sensor-Surface: 4mm (Mechanical Surface Detection)
- Electronics: DAE4 Sn878; Calibrated: 2022.06.13
- Phantom: SAM1; Type: QD000P40CD; Serial: TP:1576
- Measurement SW: DASY52, Version 52.8 (8); SEMCAD X Version 14.6.10 (7331)

**Ch190/Area Scan (71x131x1):** Interpolated grid: dx=1.500 mm, dy=1.500 mm

Maximum value of SAR (interpolated) = 0.219 W/kg

**Ch190/Zoom Scan (5x5x7)/Cube 0:** Measurement grid: dx=8mm, dy=8mm, dz=5mm

Reference Value = 13.82 V/m; Power Drift = -0.14 dB

Peak SAR (extrapolated) = 0.310 W/kg

**SAR(1 g) = 0.192 W/kg; SAR(10 g) = 0.118 W/kg**

Maximum value of SAR (measured) = 0.206 W/kg

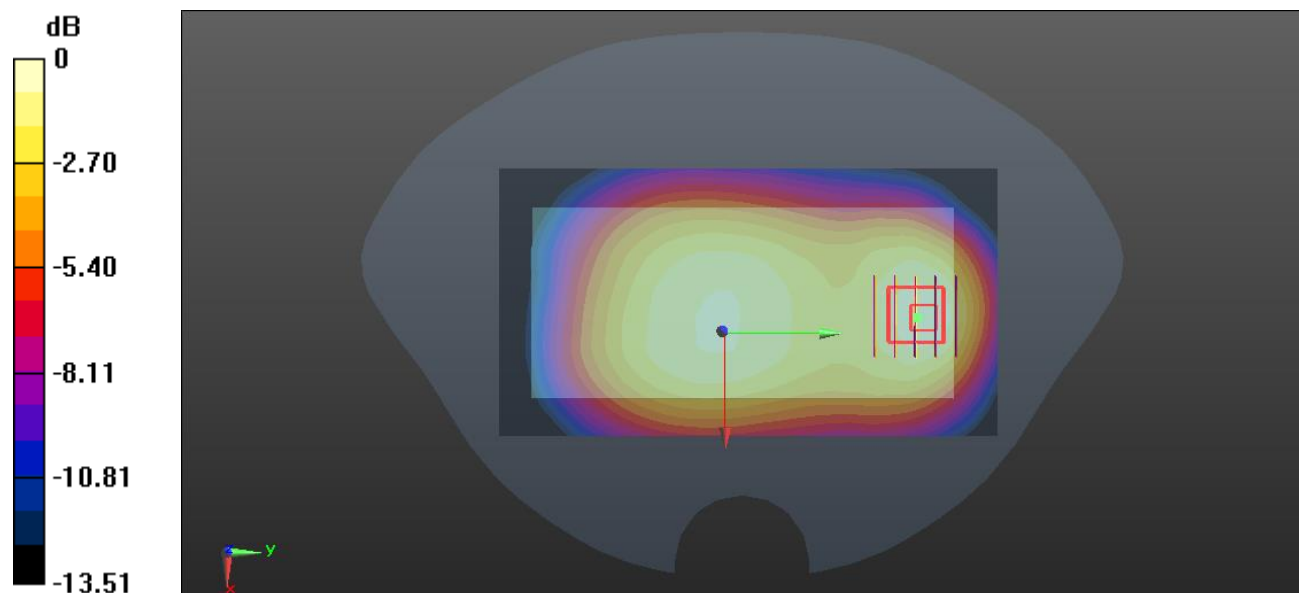

0 dB = 0.206 W/kg

**Meas.3 Right Head with Cheek on Middle Channel in GSM1900 2Slots mode with Antenna.4**

Date: 2022.10.07

Communication System Band: PCS1900; Frequency: 1880 MHz; Duty Cycle: 1:4.15

Medium parameters used (interpolated):  $f = 1880$  MHz;  $\sigma = 1.381$  S/m;  $\epsilon_r = 40.173$ ;  $\rho = 1000$  kg/m<sup>3</sup>

Phantom section: Right Section

Ambient Temperature: 22.7°C Liquid Temperature: 21.1°C

DASY5 Configuration:

- Probe: EX3DV4 - SN7607; ConvF(8.4, 8.4, 8.4); Calibrated: 2022.07.04;
- Sensor-Surface: 4mm (Mechanical Surface Detection)
- Electronics: DAE4 Sn878; Calibrated: 2022.06.13
- Phantom: SAM1; Type: QD000P40CD; Serial: TP:1576
- Measurement SW: DASY52, Version 52.8 (8); SEMCAD X Version 14.6.10 (7331)

**Ch661/Area Scan (71x131x1):** Interpolated grid: dx=1.500 mm, dy=1.500 mm

Maximum value of SAR (interpolated) = 0.362 W/kg

**Ch661/Zoom Scan (5x5x7)/Cube 0:** Measurement grid: dx=8mm, dy=8mm, dz=5mm

Reference Value = 9.563 V/m; Power Drift = -0.02 dB

Peak SAR (extrapolated) = 0.493 W/kg

**SAR(1 g) = 0.306 W/kg; SAR(10 g) = 0.159 W/kg**

Maximum value of SAR (measured) = 0.317 W/kg

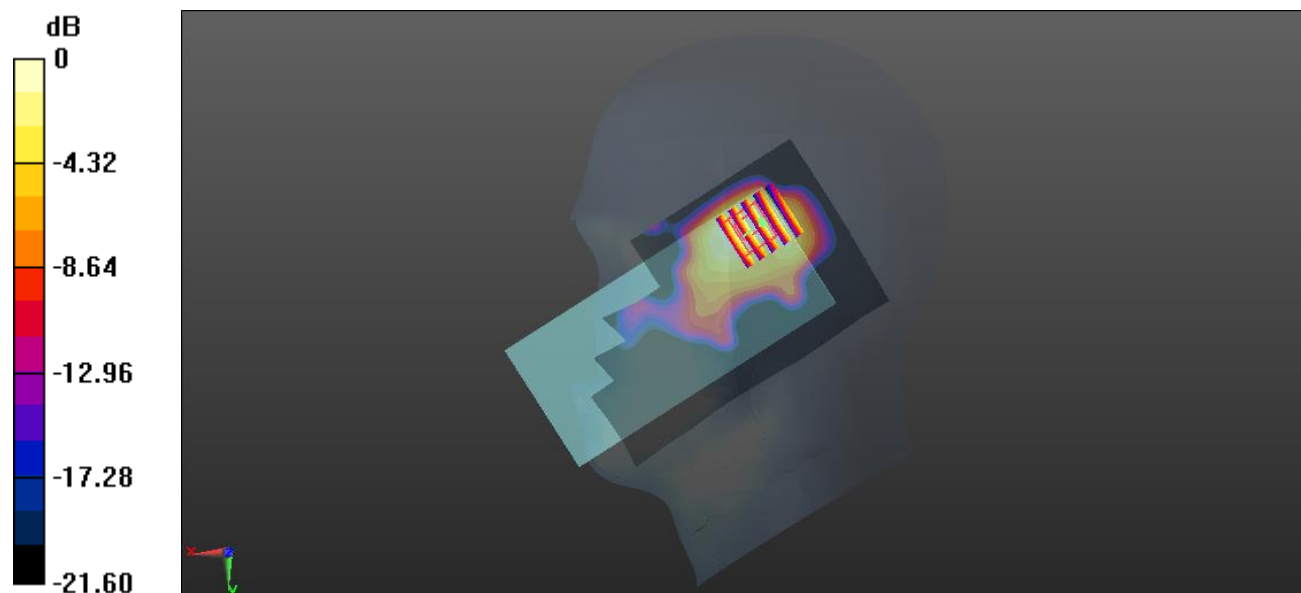

0 dB = 0.317 W/kg

**Meas.4 Body Plane with Bottom Edge 10mm on Middle Channel in GSM1900 2Slots mode with Antenna.1**

Date: 2022.10.07

Communication System Band: PCS1900; Frequency: 1880 MHz; Duty Cycle: 1:4.15

Medium parameters used (interpolated):  $f = 1880$  MHz;  $\sigma = 1.381$  S/m;  $\epsilon_r = 40.173$ ;  $\rho = 1000$  kg/m<sup>3</sup>

Phantom section: Flat Section

Ambient Temperature: 22.7°C Liquid Temperature: 21.1°C

DASY5 Configuration:

- Probe: EX3DV4 - SN7607; ConvF(8.4, 8.4, 8.4); Calibrated: 2022.07.04
- Sensor-Surface: 4mm (Mechanical Surface Detection)
- Electronics: DAE4 Sn878; Calibrated: 2022.06.13
- Phantom: SAM1; Type: QD000P40CD; Serial: TP:1576
- Measurement SW: DASY52, Version 52.8 (8); SEMCAD X Version 14.6.10 (7331)

**Ch661/Area Scan (51x71x1):** Interpolated grid: dx=1.500 mm, dy=1.500 mm

Maximum value of SAR (interpolated) = 0.441 W/kg

**Ch661/Zoom Scan (5x5x7)/Cube 0:** Measurement grid: dx=8mm, dy=8mm, dz=5mm

Reference Value = 16.79 V/m; Power Drift = 0.19 dB

Peak SAR (extrapolated) = 0.623 W/kg

**SAR(1 g) = 0.41 W/kg; SAR(10 g) = 0.212 W/kg**

Maximum value of SAR (measured) = 0.404 W/kg

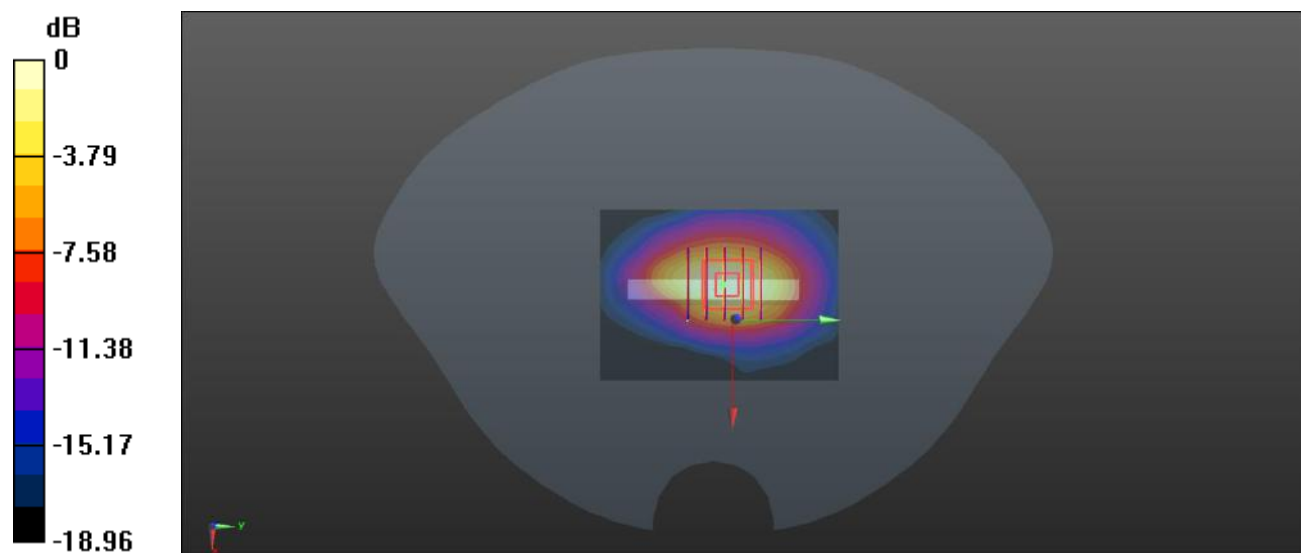

0 dB = 0.404 W/kg

**Meas.5 Body Plane with Bottom Edge 0mm on Middle Channel in GPRS1900 2Slots mode with Antenna.1**

Date: 2022.10.07

Communication System Band: PCS1900; Frequency: 1880 MHz; Duty Cycle: 1:4.15

Medium parameters used (interpolated):  $f = 1880$  MHz;  $\sigma = 1.381$  S/m;  $\epsilon_r = 40.173$ ;  $\rho = 1000$  kg/m<sup>3</sup>

Phantom section: Flat Section

Ambient Temperature: 22.7°C Liquid Temperature: 21.1°C

DASY5 Configuration:

- Probe: EX3DV4 - SN7607; ConvF(8.4, 8.4, 8.4); Calibrated: 2022.07.04
- Sensor-Surface: 4mm (Mechanical Surface Detection)
- Electronics: DAE4 Sn878; Calibrated: 2022.06.13
- Phantom: SAM1; Type: QD000P40CD; Serial: TP:1576
- Measurement SW: DASY52, Version 52.8 (8); SEMCAD X Version 14.6.10 (7331)

**Ch661/Area Scan (51x71x1):** Interpolated grid: dx=1.500 mm, dy=1.500 mm

Maximum value of SAR (interpolated) = 1.89 W/kg

**Configuration/Ch661/Zoom Scan (5x5x7)/Cube 0:** Measurement grid: dx=8mm, dy=8mm, dz=5mm

Reference Value = 24.60 V/m; Power Drift = -0.15 dB

Peak SAR (extrapolated) = 3.16 W/kg

**SAR(1 g) = 1.51 W/kg; SAR(10 g) = 0.650 W/kg**

Maximum value of SAR (measured) = 1.80 W/kg

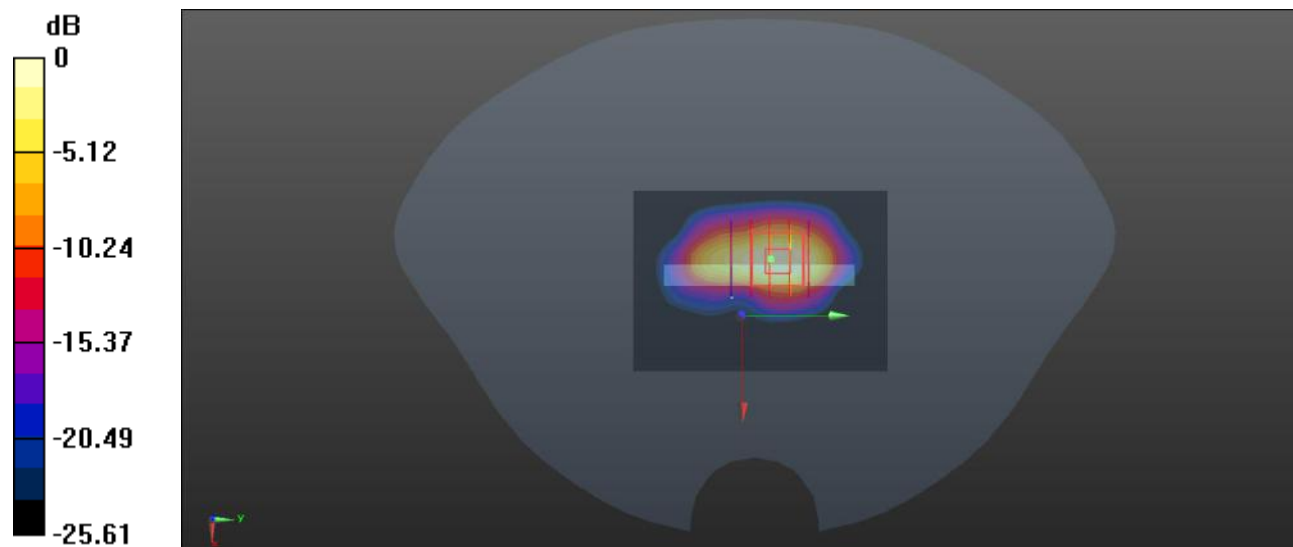

0 dB = 1.80 W/kg

**Meas.6 Right Head with Cheek on Middle Channel in WCDMA Band2 mode with Antenna.4**

Date: 2022.10.07

Communication System Band: BAND 2; Frequency: 1880 MHz; Duty Cycle: 1:1

Medium parameters used (interpolated):  $f = 1880$  MHz;  $\sigma = 1.381$  S/m;  $\epsilon_r = 40.173$ ;  $\rho = 1000$  kg/m<sup>3</sup>

Phantom section: Right Section

Ambient Temperature: 22.7°C Liquid Temperature: 21.1°C

DASY5 Configuration:

- Probe: EX3DV4 - SN7607; ConvF(8.4, 8.4, 8.4); Calibrated: 2022.07.04;
- Sensor-Surface: 4mm (Mechanical Surface Detection)
- Electronics: DAE4 Sn878; Calibrated: 2022.06.13
- Phantom: SAM1; Type: QD000P40CD; Serial: TP:1576
- Measurement SW: DASY52, Version 52.8 (8); SEMCAD X Version 14.6.10 (7331)

**Ch9400/Area Scan (71x131x1):** Interpolated grid: dx=1.500 mm, dy=1.500 mm

Maximum value of SAR (interpolated) = 0.312 W/kg

**Ch9400/Zoom Scan (5x5x7)/Cube 0:** Measurement grid: dx=8mm, dy=8mm, dz=5mm

Reference Value = 9.588 V/m; Power Drift = 0.07 dB

Peak SAR (extrapolated) = 0.371 W/kg

**SAR(1 g) = 0.184 W/kg; SAR(10 g) = 0.085 W/kg**

Maximum value of SAR (measured) = 0.220 W/kg

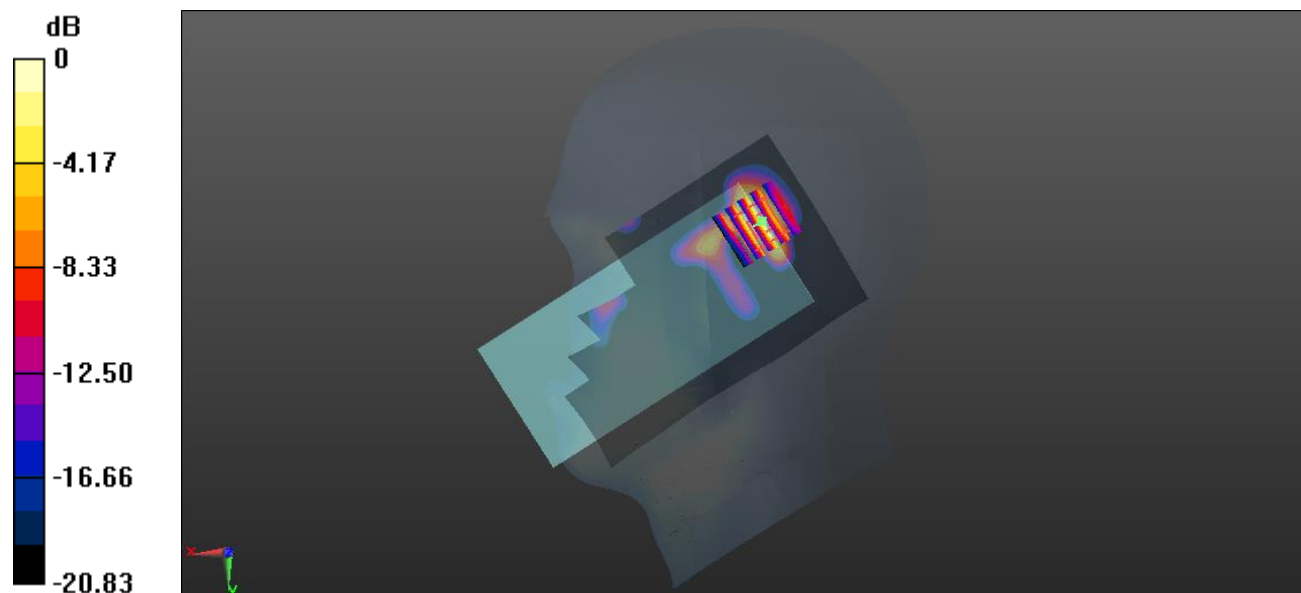

0 dB = 0.220 W/kg



**Meas.7 Body Plane with Bottom Edge 10mm on Low Channel in WCDMA Band2 mode with Antenna.1**

Date: 2022.10.07

Communication System Band: BAND 2; Frequency: 1852.4 MHz; Duty Cycle: 1:1

Medium parameters used (interpolated):  $f = 1852.4$  MHz;  $\sigma = 1.371$  S/m;  $\epsilon_r = 40.529$ ;  $\rho = 1000$  kg/m<sup>3</sup>

Phantom section: Flat Section

Ambient Temperature: 22.7°C Liquid Temperature: 21.1°C

DASY5 Configuration:

- Probe: EX3DV4 - SN7607; ConvF(8.4, 8.4, 8.4) ; Calibrated: 2022.07.04
- Sensor-Surface: 4mm (Mechanical Surface Detection)
- Electronics: DAE4 Sn878; Calibrated: 2022.06.13
- Phantom: SAM1; Type: QD000P40CD; Serial: TP:1576
- Measurement SW: DASY52, Version 52.8 (8); SEMCAD X Version 14.6.10 (7331)

**Ch9262/Area Scan (51x71x1):** Interpolated grid: dx=1.500 mm, dy=1.500 mm

Maximum value of SAR (interpolated) = 0.659 W/kg

**Ch9262/Zoom Scan (5x5x7)/Cube 0:** Measurement grid: dx=8mm, dy=8mm, dz=5mm

Reference Value = 20.40 V/m; Power Drift = 0.06 dB

Peak SAR (extrapolated) = 0.930 W/kg

**SAR(1 g) = 0.552 W/kg; SAR(10 g) = 0.296 W/kg**

Maximum value of SAR (measured) = 0.618 W/kg

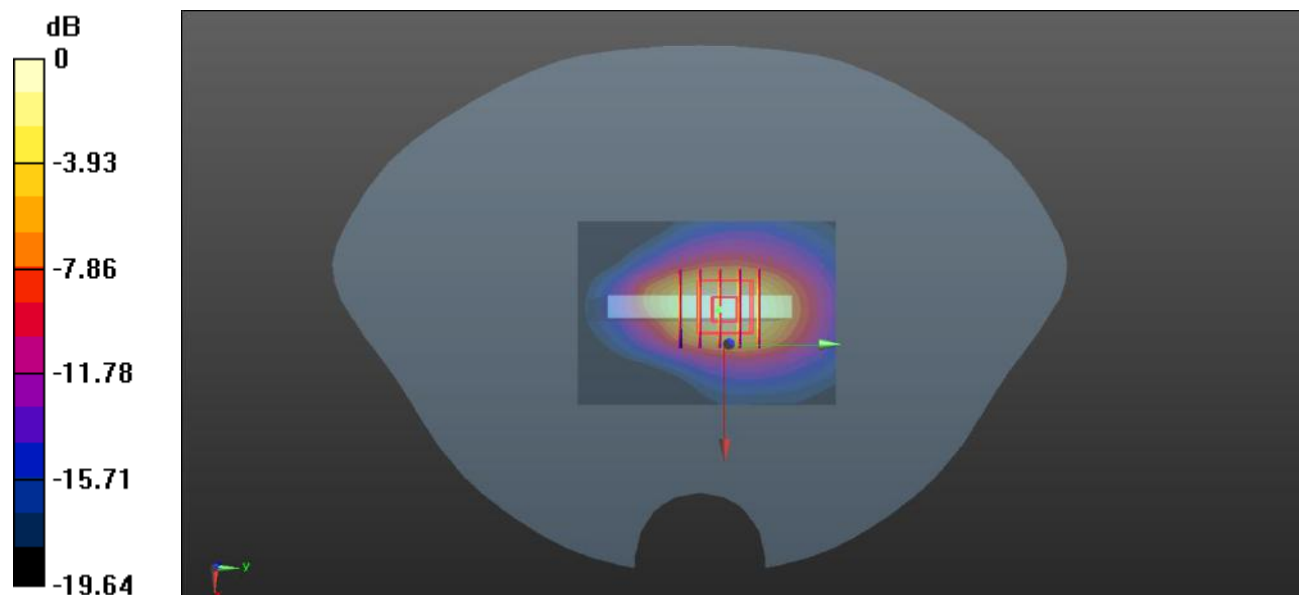

0 dB = 0.618 W/kg

**Meas.8 Body Plane with Bottom Edge 0mm on Low Channel in WCDMA Band2 mode with Antenna.1**

Date: 2022.10.07

Communication System Band: BAND 2; Frequency: 1852.4 MHz; Duty Cycle: 1:1

Medium parameters used (interpolated):  $f = 1852.4$  MHz;  $\sigma = 1.371$  S/m;  $\epsilon_r = 40.529$ ;  $\rho = 1000$  kg/m<sup>3</sup>

Phantom section: Flat Section

Ambient Temperature: 22.7°C Liquid Temperature: 21.1°C

DASY5 Configuration:

- Probe: EX3DV4 - SN7607; ConvF(8.4, 8.4, 8.4) ; Calibrated: 2022.07.04
- Sensor-Surface: 4mm (Mechanical Surface Detection)
- Electronics: DAE4 Sn878; Calibrated: 2022.06.13
- Phantom: SAM1; Type: QD000P40CD; Serial: TP:1576
- Measurement SW: DASY52, Version 52.8 (8); SEMCAD X Version 14.6.10 (7331)

**Ch9262/Area Scan (51x71x1):** Interpolated grid: dx=1.500 mm, dy=1.500 mm

Maximum value of SAR (interpolated) = 3.62 W/kg

**Ch9262/Zoom Scan (5x5x7)/Cube 0:** Measurement grid: dx=8mm, dy=8mm, dz=5mm

Reference Value = 40.08 V/m; Power Drift = 0.16 dB

Peak SAR (extrapolated) = 5.43 W/kg

**SAR(1 g) = 2.47 W/kg; SAR(10 g) = 1.04 W/kg**

Maximum value of SAR (measured) = 2.96 W/kg

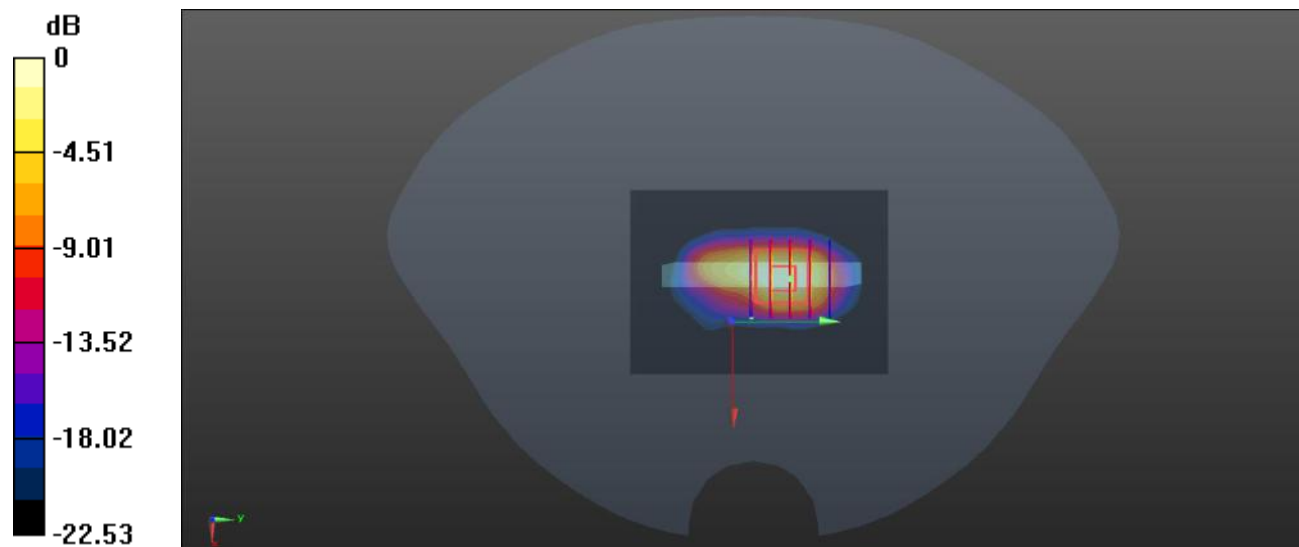

0 dB = 2.96 W/kg

**Meas.9 Right Head with Cheek on Middle Channel in WCDMA Band4 mode with Antenna.4**

Date: 2022.10.03

Communication System Band: BAND 4; Frequency: 1732.4 MHz; Duty Cycle: 1:1

Medium parameters used (interpolated):  $f = 1732.4$  MHz;  $\sigma = 1.366$  S/m;  $\epsilon_r = 40.408$ ;  $\rho = 1000$  kg/m<sup>3</sup>

Phantom section: Right Section

Ambient Temperature: 22.8°C Liquid Temperature: 21.5°C

DASY5 Configuration:

- Probe: EX3DV4 - SN7607; ConvF(8.69, 8.69, 8.69) ; Calibrated: 2022.07.04
- Sensor-Surface: 4mm (Mechanical Surface Detection)
- Electronics: DAE4 Sn878; Calibrated: 2022.06.13
- Phantom: SAM1; Type: QD000P40CD; Serial: TP:1576
- Measurement SW: DASY52, Version 52.8 (8); SEMCAD X Version 14.6.10 (7331)

**Ch1412/Area Scan (71x121x1):** Interpolated grid: dx=1.500 mm, dy=1.500 mm

Maximum value of SAR (interpolated) = 0.260 W/kg

**Ch1412/Zoom Scan (5x5x7)/Cube 0:** Measurement grid: dx=8mm, dy=8mm, dz=5mm

Reference Value = 8.043 V/m; Power Drift = -0.01 dB

Peak SAR (extrapolated) = 0.406 W/kg

**SAR(1 g) = 0.207 W/kg; SAR(10 g) = 0.097 W/kg**

Maximum value of SAR (measured) = 0.246 W/kg

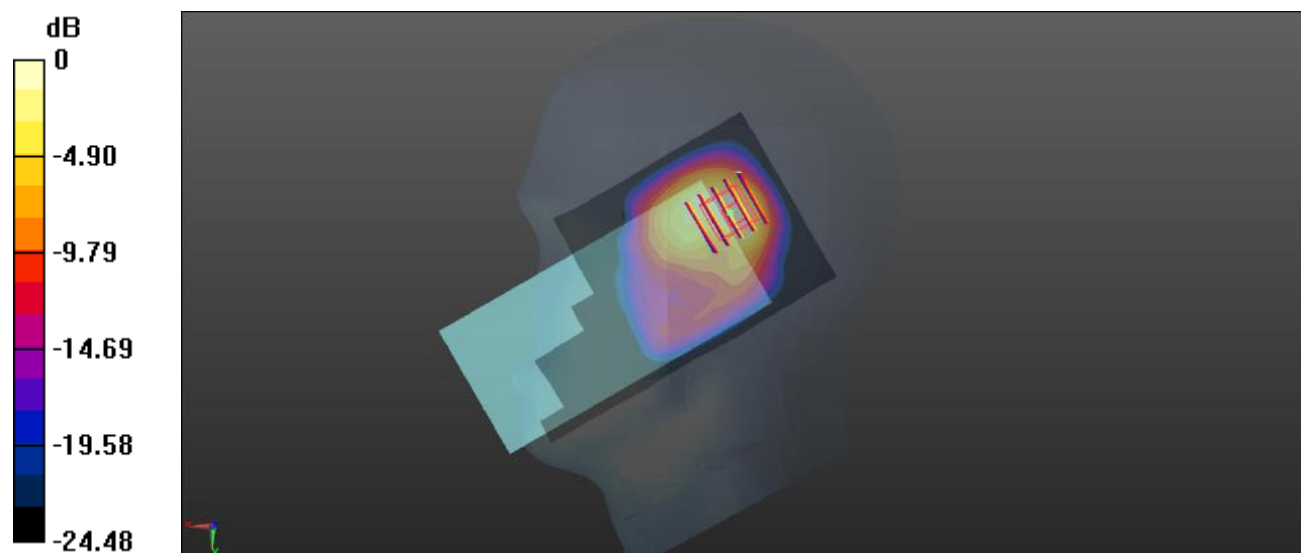

0 dB = 0.246 W/kg

**Meas.10 Body Plane with Bottom Edge 10mm on Middle Channel in WCDMA Band4 mode with Antenna.1**

Date: 2022.10.03

Communication System Band: BAND 4; Frequency: 1732.4 MHz; Duty Cycle: 1:1

Medium parameters used (interpolated):  $f = 1732.4$  MHz;  $\sigma = 1.366$  S/m;  $\epsilon_r = 40.408$ ;  $\rho = 1000$  kg/m<sup>3</sup>

Phantom section: Flat Section

Ambient Temperature: 22.8°C Liquid Temperature: 21.5°C

DASY5 Configuration:

- Probe: EX3DV4 - SN7607; ConvF(8.69, 8.69, 8.69); Calibrated: 2022.07.04;
- Sensor-Surface: 4mm (Mechanical Surface Detection)
- Electronics: DAE4 Sn878; Calibrated: 2022.06.13
- Phantom: SAM1; Type: QD000P40CD; Serial: TP:1576
- Measurement SW: DASY52, Version 52.8 (8); SEMCAD X Version 14.6.10 (7331)

**Ch1412/Area Scan (51x71x1):** Interpolated grid: dx=1.500 mm, dy=1.500 mm

Maximum value of SAR (interpolated) = 0.778 W/kg

**Ch1412/Zoom Scan (5x5x7)/Cube 0:** Measurement grid: dx=8mm, dy=8mm, dz=5mm

Reference Value = 21.55 V/m; Power Drift = -0.04 dB

Peak SAR (extrapolated) = 1.02 W/kg

**SAR(1 g) = 0.611 W/kg; SAR(10 g) = 0.328 W/kg**

Maximum value of SAR (measured) = 0.686 W/kg

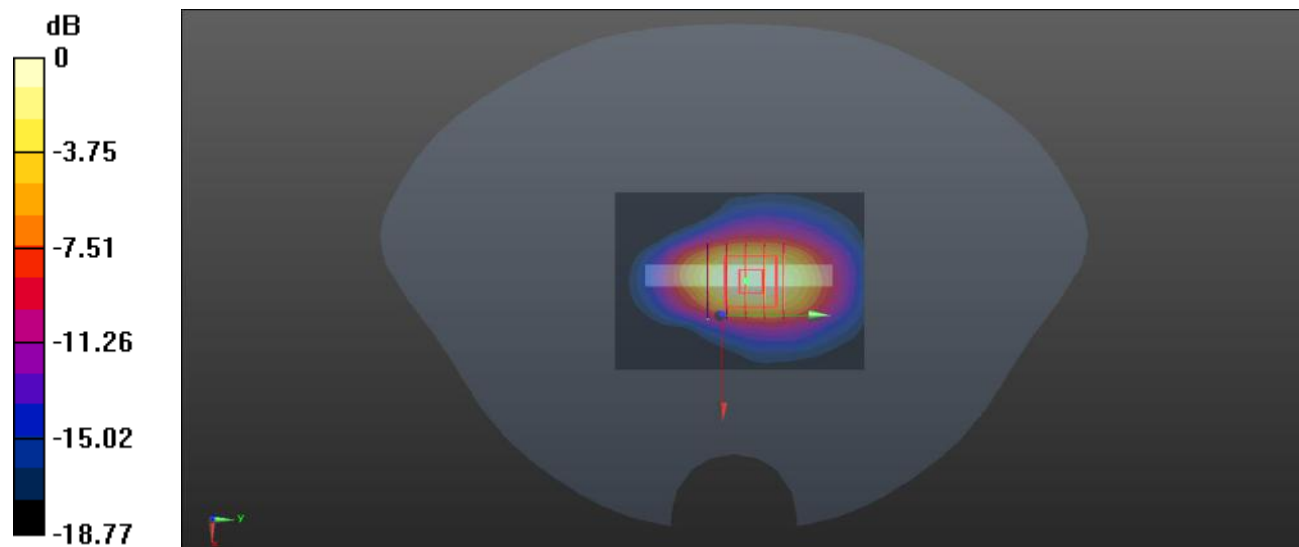

0 dB = 0.686 W/kg

**Meas.11 Body Plane with Bottom Edge 0mm on Middle Channel in WCDMA Band4 mode with Antenna.1**

Date: 2022.10.03

Communication System Band: BAND 4; Frequency: 1732.4 MHz; Duty Cycle: 1:1

Medium parameters used (interpolated):  $f = 1732.4$  MHz;  $\sigma = 1.366$  S/m;  $\epsilon_r = 40.408$ ;  $\rho = 1000$  kg/m<sup>3</sup>

Phantom section: Flat Section

Ambient Temperature: 22.8°C Liquid Temperature: 21.5°C

DASY5 Configuration:

- Probe: EX3DV4 - SN7607; ConvF(8.69, 8.69, 8.69); Calibrated: 2022.07.04;
- Sensor-Surface: 4mm (Mechanical Surface Detection)
- Electronics: DAE4 Sn878; Calibrated: 2022.06.13
- Phantom: SAM1; Type: QD000P40CD; Serial: TP:1576
- Measurement SW: DASY52, Version 52.8 (8); SEMCAD X Version 14.6.10 (7331)

**Ch1412/Area Scan (51x71x1):** Interpolated grid: dx=1.500 mm, dy=1.500 mm

Maximum value of SAR (interpolated) = 2.54 W/kg

**Ch1412/Zoom Scan (5x5x7)/Cube 0:** Measurement grid: dx=8mm, dy=8mm, dz=5mm

Reference Value = 24.95 V/m; Power Drift = 0.11 dB

Peak SAR (extrapolated) = 4.16 W/kg

**SAR(1 g) = 1.96 W/kg; SAR(10 g) = 0.849 W/kg**

Maximum value of SAR (measured) = 2.39 W/kg

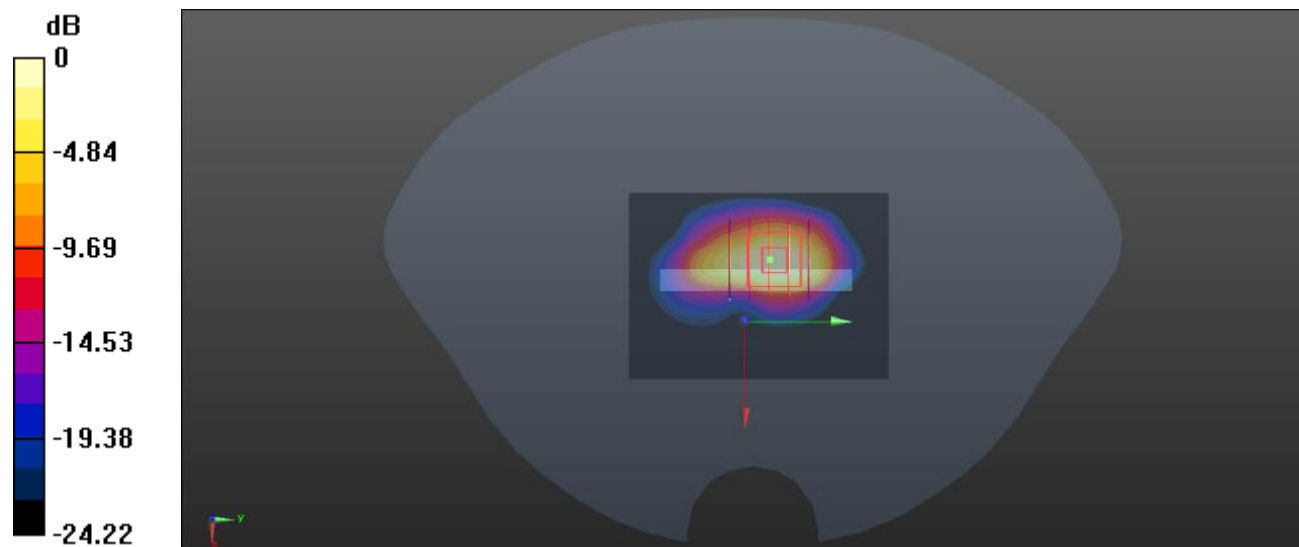

0 dB = 2.39 W/kg

**Meas.12 Right Head with Cheek on Middle Channel in WCDMA Band5 mode with Antenna .4**

Date: 2022.10.02

Communication System Band: BAND 5; Frequency: 836.4 MHz; Duty Cycle: 1:1

Medium parameters used (interpolated):  $f = 836.4$  MHz;  $\sigma = 0.913$  S/m;  $\epsilon_r = 41.731$ ;  $\rho = 1000$  kg/m<sup>3</sup>

Phantom section: Right Section

Ambient Temperature: 22.4°C Liquid Temperature: 21.1°C

DASY5 Configuration:

- Probe: EX3DV4 - SN7607; ConvF(10.44, 10.44, 10.44); Calibrated: 2022.07.04
- Sensor-Surface: 4mm (Mechanical Surface Detection)
- Electronics: DAE4 Sn878; Calibrated: 2022.06.13
- Phantom: SAM1; Type: QD000P40CD; Serial: TP:1576
- Measurement SW: DASY52, Version 52.8 (8); SEMCAD X Version 14.6.10 (7331)

**Ch4182/Area Scan (71x121x1):** Interpolated grid: dx=1.500 mm, dy=1.500 mm

Maximum value of SAR (interpolated) = 0.142 W/kg

**Ch4182/Zoom Scan (5x5x7)/Cube 0:** Measurement grid: dx=8mm, dy=8mm, dz=5mm

Reference Value = 11.57 V/m; Power Drift = 0.14 dB

Peak SAR (extrapolated) = 0.223 W/kg

**SAR(1 g) = 0.126 W/kg; SAR(10 g) = 0.077 W/kg**

Maximum value of SAR (measured) = 0.133 W/kg

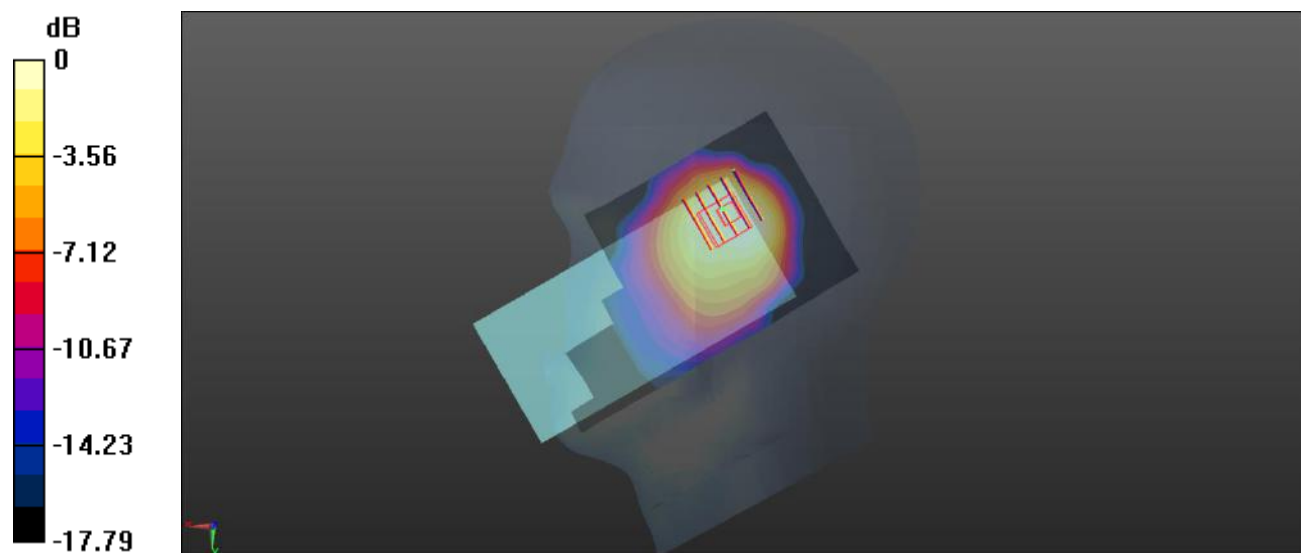

0 dB = 0.133 W/kg

**Meas.13 Body Plane with Back Side 10mm on Middle Channel in WCDMA Band5 mode with Antenna.1**

Date: 2022.10.02

Communication System Band: BAND 5; Frequency: 836.4 MHz; Duty Cycle: 1:1

Medium parameters used (interpolated):  $f = 836.4$  MHz;  $\sigma = 0.913$  S/m;  $\epsilon_r = 41.731$ ;  $\rho = 1000$  kg/m<sup>3</sup>

Phantom section: Flat Section

Ambient Temperature: 22.4°C Liquid Temperature: 21.1°C

DASY5 Configuration:

- Probe: EX3DV4 - SN7607; ConvF(10.44, 10.44, 10.44); Calibrated: 2022.07.04;
- Sensor-Surface: 4mm (Mechanical Surface Detection)
- Electronics: DAE4 Sn878; Calibrated: 2022.06.13
- Phantom: SAM1; Type: QD000P40CD; Serial: TP:1576
- Measurement SW: DASY52, Version 52.8 (8); SEMCAD X Version 14.6.10 (7331)

**Ch4182/Area Scan (71x131x1):** Interpolated grid: dx=1.500 mm, dy=1.500 mm

Maximum value of SAR (interpolated) = 0.233 W/kg

**Ch4182/Zoom Scan (5x5x7)/Cube 0:** Measurement grid: dx=8mm, dy=8mm, dz=5mm

Reference Value = 14.46 V/m; Power Drift = -0.11 dB

Peak SAR (extrapolated) = 0.332 W/kg

**SAR(1 g) = 0.219 W/kg; SAR(10 g) = 0.126 W/kg**

Maximum value of SAR (measured) = 0.221 W/kg

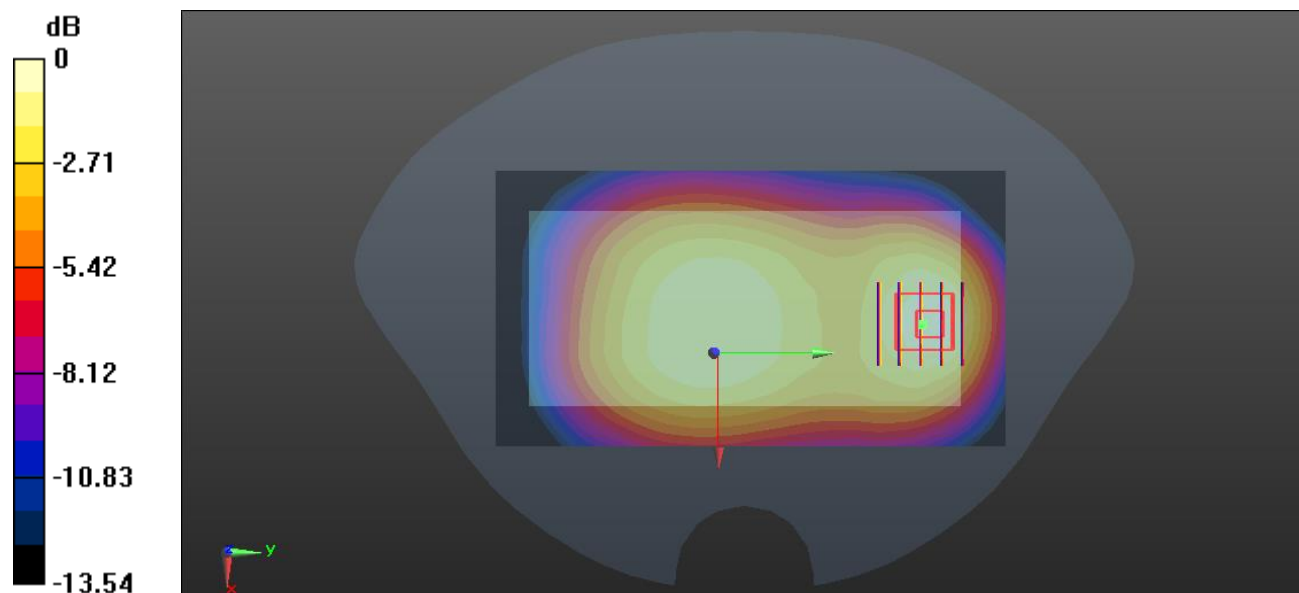

0 dB = 0.221 W/kg

**Meas.14 Right Head with Cheek on Low Channel in LTE Band2 mode with Antenna.2**

Date: 2022/10/26

Communication System Band: BAND 2; Frequency: 1860 MHz; Duty Cycle: 1:1

Medium parameters used (interpolated):  $f = 1860$  MHz;  $\sigma = 1.376$  S/m;  $\epsilon_r = 40.404$ ;  $\rho = 1000$  kg/m<sup>3</sup>

Phantom section: Right Section

Ambient Temperature: 22.6°C Liquid Temperature: 21.4°C

DASY5 Configuration:

- Probe: EX3DV4 - SN7607; ConvF(8.4, 8.4, 8.4); Calibrated: 2022.07.04
- Sensor-Surface: 4mm (Mechanical Surface Detection)
- Electronics: DAE4 Sn878; Calibrated: 2022.06.13
- Phantom: SAM1; Type: QD000P40CD; Serial: TP:1576
- Measurement SW: DASY52, Version 52.8 (8); SEMCAD X Version 14.6.10 (7331)

**Ch18700/Area Scan (71x131x1):** Interpolated grid: dx=1.500 mm, dy=1.500 mm

Maximum value of SAR (interpolated) = 0.453 W/kg

**Ch18700/Zoom Scan (5x5x7)/Cube 0:** Measurement grid: dx=8mm, dy=8mm, dz=5mm

Reference Value = 10.16 V/m; Power Drift = -0.16 dB

Peak SAR (extrapolated) = 0.756 W/kg

**SAR(1 g) = 0.412 W/kg; SAR(10 g) = 0.220 W/kg**

Maximum value of SAR (measured) = 0.413 W/kg

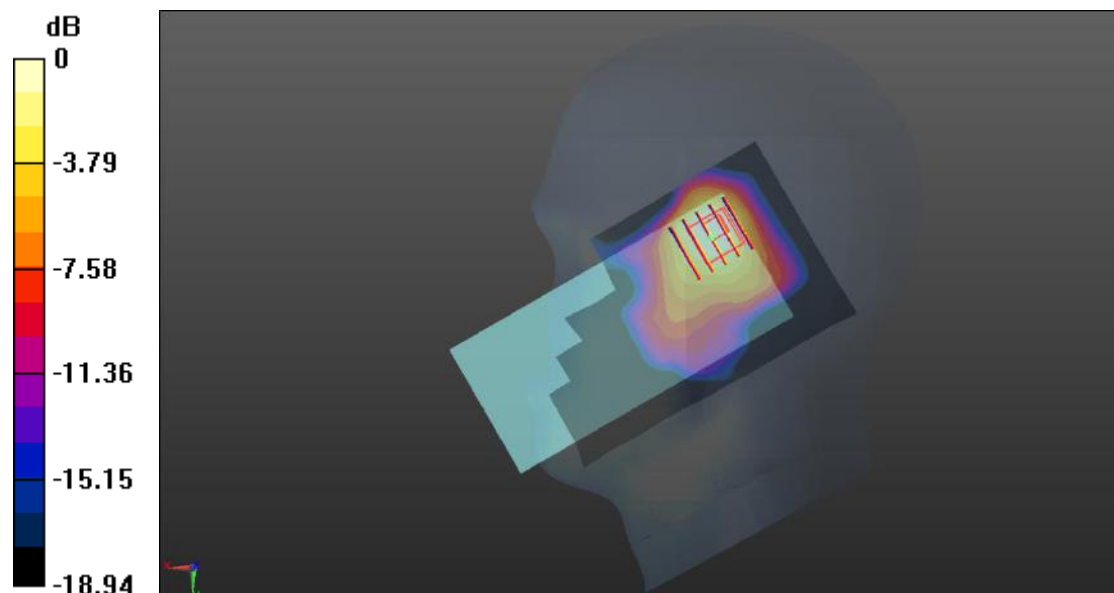

0 dB = 0.413 W/kg



**Meas.15 Body Plane with Bottom Edge 10mm on Low Channel in LTE Band2 mode with Antenna.1**

Date: 2022.10.06

Communication System Band: Band 2; Frequency: 1860 MHz; Duty Cycle: 1:1

Medium parameters used (interpolated):  $f = 1860$  MHz;  $\sigma = 1.376$  S/m;  $\epsilon_r = 40.404$ ;  $\rho = 1000$  kg/m<sup>3</sup>

Phantom section: Flat Section

Ambient Temperature: 22.6°C Liquid Temperature: 21.4°C

DASY5 Configuration:

- Probe: EX3DV4 - SN7607; ConvF(8.4, 8.4, 8.4); Calibrated: 2022.07.04;
- Sensor-Surface: 4mm (Mechanical Surface Detection)
- Electronics: DAE4 Sn878; Calibrated: 2022.06.13
- Phantom: SAM1; Type: QD000P40CD; Serial: TP:1576
- Measurement SW: DASY52, Version 52.8 (8); SEMCAD X Version 14.6.10 (7331)

**Ch18700/Area Scan (51x71x1):** Interpolated grid: dx=1.500 mm, dy=1.500 mm

Maximum value of SAR (interpolated) = 0.811 W/kg

**Ch18700/Zoom Scan (5x5x7)/Cube 0:** Measurement grid: dx=8mm, dy=8mm, dz=5mm

Reference Value = 22.39 V/m; Power Drift = -0.15 dB

Peak SAR (extrapolated) = 1.15 W/kg

**SAR(1 g) = 0.532 W/kg; SAR(10 g) = 0.309 W/kg**

Maximum value of SAR (measured) = 0.771 W/kg

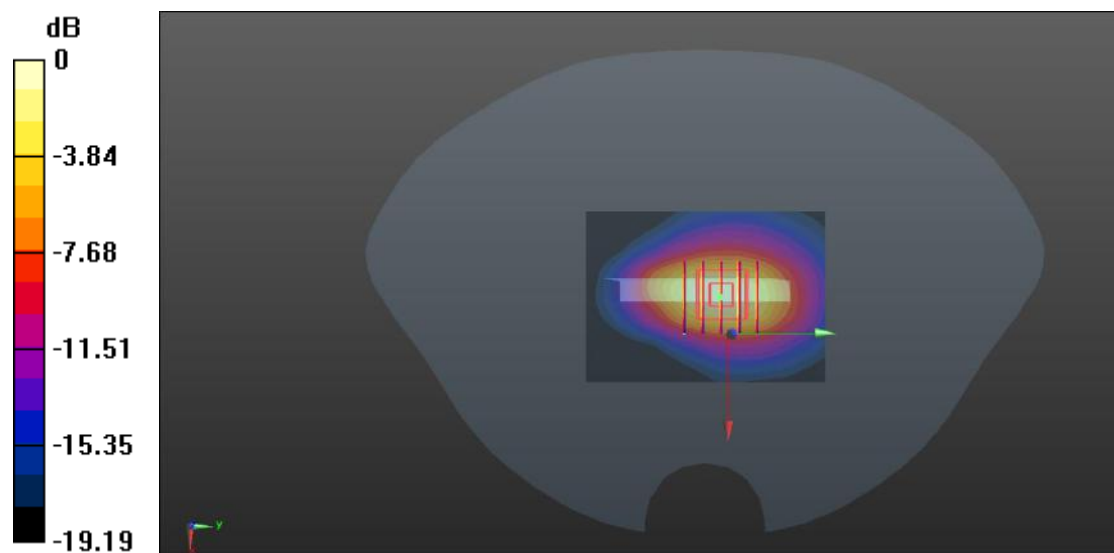

0 dB = 0.771 W/kg

**Meas.16 Body Plane with Bottom Edge 0mm on Low Channel in LTE Band2 mode with Antenna.1**

Date: 2022.10.06

Communication System Band: Band 2; Frequency: 1860 MHz; Duty Cycle: 1:1

Medium parameters used (interpolated):  $f = 1860$  MHz;  $\sigma = 1.376$  S/m;  $\epsilon_r = 40.404$ ;  $\rho = 1000$  kg/m<sup>3</sup>

Phantom section: Flat Section

Ambient Temperature: 22.6°C Liquid Temperature: 21.4°C

DASY5 Configuration:

- Probe: EX3DV4 - SN7607; ConvF(8.4, 8.4, 8.4); Calibrated: 2022.07.04;
- Sensor-Surface: 4mm (Mechanical Surface Detection)
- Electronics: DAE4 Sn878; Calibrated: 2022.06.13
- Phantom: SAM1; Type: QD000P40CD; Serial: TP:1576
- Measurement SW: DASY52, Version 52.8 (8); SEMCAD X Version 14.6.10 (7331)

**Ch18700/Area Scan (51x71x1):** Interpolated grid: dx=1.500 mm, dy=1.500 mm

Maximum value of SAR (interpolated) = 3.08 W/kg

**Ch18700/Zoom Scan (5x5x7)/Cube 0:** Measurement grid: dx=8mm, dy=8mm, dz=5mm

Reference Value = 29.84 V/m; Power Drift = -0.08 dB

Peak SAR (extrapolated) = 5.19 W/kg

**SAR(1 g) = 2.36 W/kg; SAR(10 g) = 0.997 W/kg**

Maximum value of SAR (measured) = 2.89 W/kg

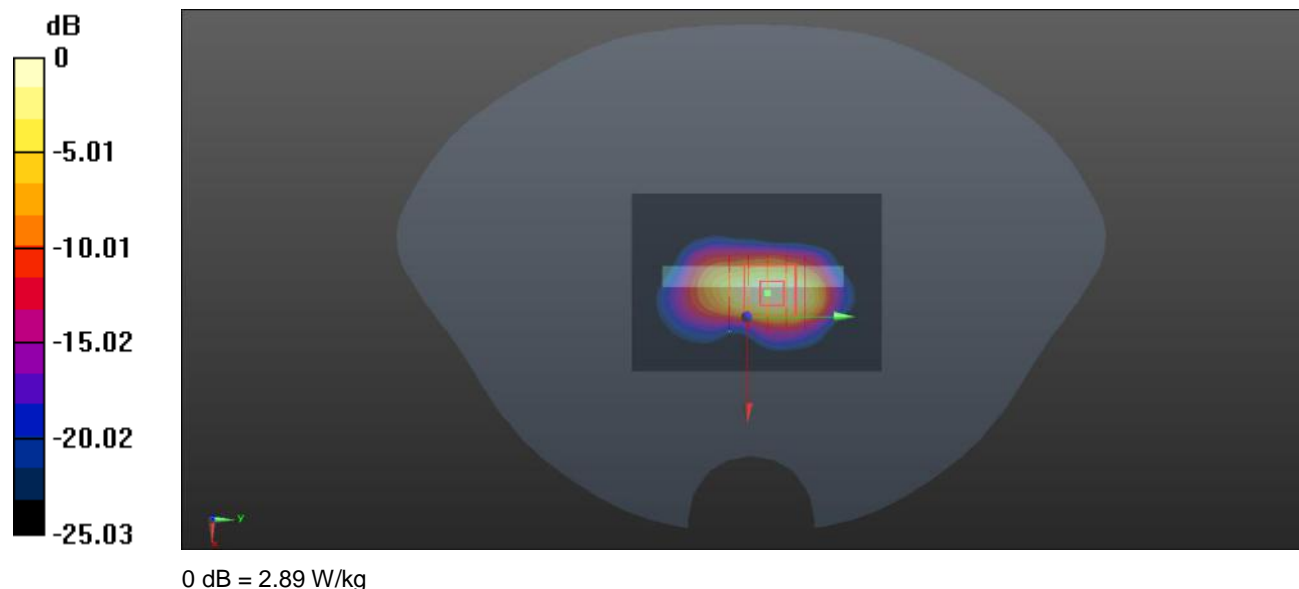

**Meas.17 Right Head with Cheek on Low Channel in LTE Band4 mode with Antenna.4**

Date: 2022.10.03

Communication System Band: Band 4; Frequency: 1720 MHz; Duty Cycle: 1:1

Medium parameters used (interpolated):  $f = 1720$  MHz;  $\sigma = 1.355$  S/m;  $\epsilon_r = 40.576$ ;  $\rho = 1000$  kg/m<sup>3</sup>

Phantom section: Right Section

Ambient Temperature: 22.8°C Liquid Temperature: 21.5°C

DASY5 Configuration:

- Probe: EX3DV4 - SN7607; ConvF(8.69, 8.69, 8.69); Calibrated: 2022.07.04;
- Sensor-Surface: 4mm (Mechanical Surface Detection)
- Electronics: DAE4 Sn878; Calibrated: 2022.06.13
- Phantom: SAM1; Type: QD000P40CD; Serial: TP:1576
- Measurement SW: DASY52, Version 52.8 (8); SEMCAD X Version 14.6.10 (7331)

**Ch20050/Area Scan (71x131x1):** Interpolated grid: dx=1.500 mm, dy=1.500 mm

Maximum value of SAR (interpolated) = 0.601 W/kg

**Ch20050/Zoom Scan (5x5x7)/Cube 0:** Measurement grid: dx=8mm, dy=8mm, dz=5mm

Reference Value = 10.13 V/m; Power Drift = -0.19 dB

Peak SAR (extrapolated) = 0.886 W/kg

**SAR(1 g) = 0.497 W/kg; SAR(10 g) = 0.264 W/kg**

Maximum value of SAR (measured) = 0.535 W/kg

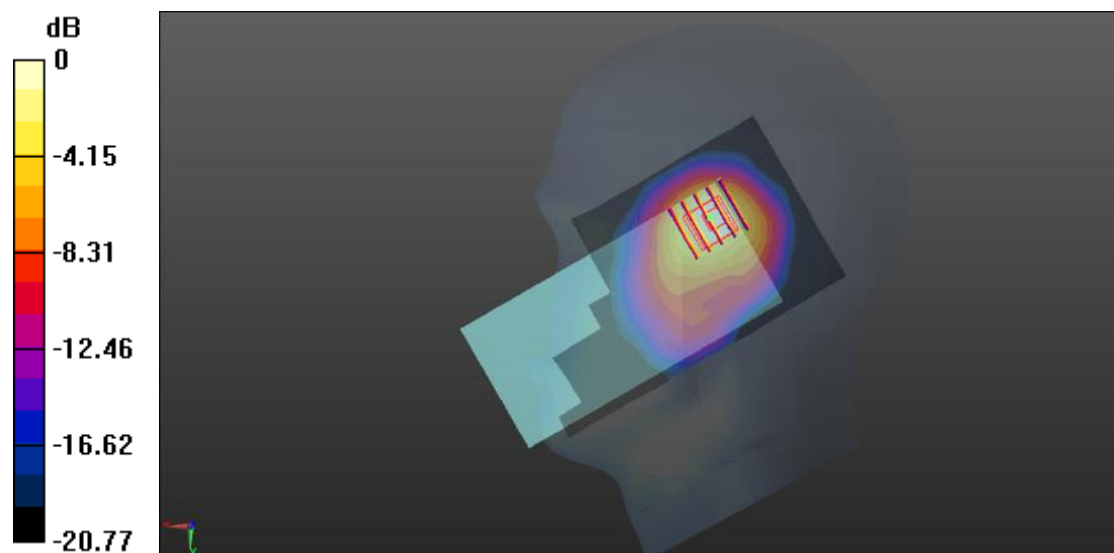

0 dB = 0.535 W/kg

**Meas.18 Body Plane with Bottom Edge 10mm on High Channel in LTE Band4 mode with Antenna.1**

Date: 2022.10.03

Communication System Band: Band 4; Frequency: 1745 MHz; Duty Cycle: 1:1

Medium parameters used (interpolated):  $f = 1745$  MHz;  $\sigma = 1.379$  S/m;  $\epsilon_r = 40.251$ ;  $\rho = 1000$  kg/m<sup>3</sup>

Phantom section: Flat Section

Ambient Temperature: 22.8°C Liquid Temperature: 21.5°C

DASY5 Configuration:

- Probe: EX3DV4 - SN7607; ConvF(8.69, 8.69, 8.69); Calibrated: 2022.07.04;
- Sensor-Surface: 4mm (Mechanical Surface Detection)
- Electronics: DAE4 Sn878; Calibrated: 2022.06.13
- Phantom: SAM1; Type: QD000P40CD; Serial: TP:1576
- Measurement SW: DASY52, Version 52.8 (8); SEMCAD X Version 14.6.10 (7331)

**Ch20300/Area Scan (51x71x1):** Interpolated grid: dx=1.500 mm, dy=1.500 mm

Maximum value of SAR (interpolated) = 0.610 W/kg

**Ch20300/Zoom Scan (5x5x7)/Cube 0:** Measurement grid: dx=8mm, dy=8mm, dz=5mm

Reference Value = 16.84 V/m; Power Drift = -0.04 dB

Peak SAR (extrapolated) = 0.836 W/kg

**SAR(1 g) = 0.483 W/kg; SAR(10 g) = 0.273 W/kg**

Maximum value of SAR (measured) = 0.565 W/kg

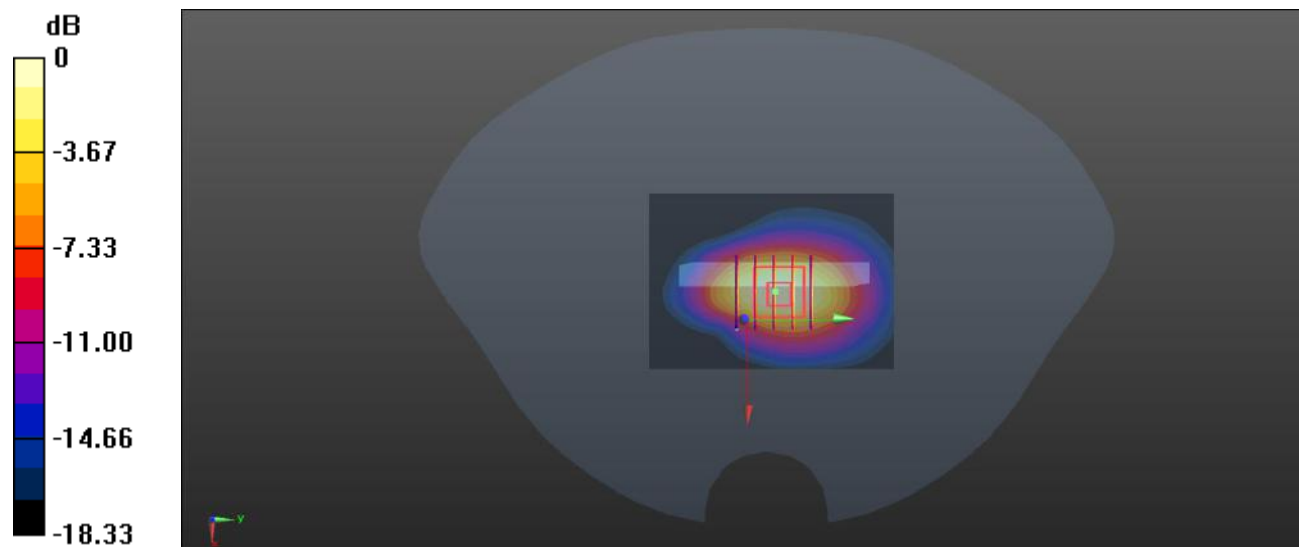

0 dB = 0.565 W/kg

**Meas.19 Body Plane with Bottom Edge 0mm on High Channel in LTE Band4 mode with Antenna.1**

Date: 2022.10.03

Communication System Band: Band 4; Frequency: 1745 MHz; Duty Cycle: 1:1

Medium parameters used (interpolated):  $f = 1745$  MHz;  $\sigma = 1.379$  S/m;  $\epsilon_r = 40.251$ ;  $\rho = 1000$  kg/m<sup>3</sup>

Phantom section: Flat Section

Ambient Temperature: 22.8°C Liquid Temperature: 21.5°C

DASY5 Configuration:

- Probe: EX3DV4 - SN7607; ConvF(8.69, 8.69, 8.69); Calibrated: 2022.07.04;
- Sensor-Surface: 4mm (Mechanical Surface Detection)
- Electronics: DAE4 Sn878; Calibrated: 2022.06.13
- Phantom: SAM1; Type: QD000P40CD; Serial: TP:1576
- Measurement SW: DASY52, Version 52.8 (8); SEMCAD X Version 14.6.10 (7331)

**Ch20300/Area Scan (51x71x1):** Interpolated grid: dx=1.500 mm, dy=1.500 mm

Maximum value of SAR (interpolated) = 2.12 W/kg

**Ch20300/Zoom Scan (5x5x7)/Cube 0:** Measurement grid: dx=8mm, dy=8mm, dz=5mm

Reference Value = 26.71 V/m; Power Drift = -0.05 dB

Peak SAR (extrapolated) = 3.38 W/kg

**SAR(1 g) = 1.58 W/kg; SAR(10 g) = 0.687 W/kg**

Maximum value of SAR (measured) = 1.93 W/kg

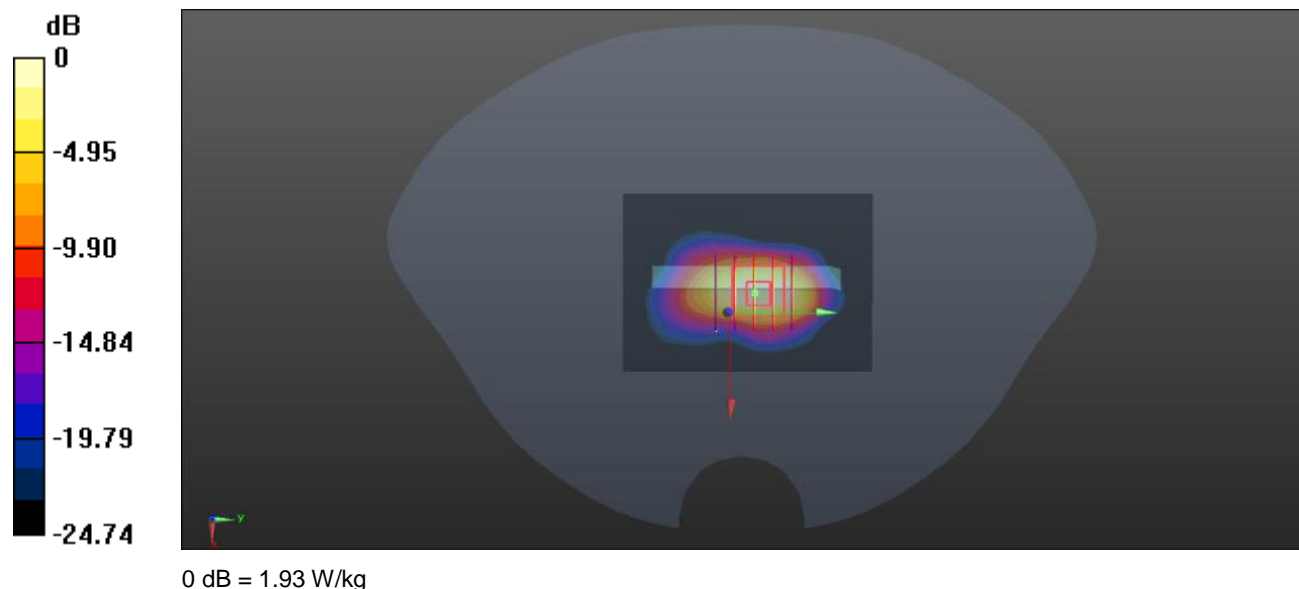

**Meas.20 Right Head with Cheek on High Channel in LTE Band5 mode with Antenna.4**

Date: 2022.10.01

Communication System Band: Band 5; Frequency: 844 MHz; Duty Cycle: 1:1

Medium parameters used (interpolated):  $f = 844$  MHz;  $\sigma = 0.921$  S/m;  $\epsilon_r = 41.519$ ;  $\rho = 1000$  kg/m<sup>3</sup>

Phantom section: Right Section

Ambient Temperature: 22.5°C Liquid Temperature: 21.3°C

DASY5 Configuration:

- Probe: EX3DV4 - SN7607; ConvF(10.44, 10.44, 10.44); Calibrated: 2022.07.04;
- Sensor-Surface: 4mm (Mechanical Surface Detection)
- Electronics: DAE4 Sn878; Calibrated: 2022.06.13
- Phantom: SAM1; Type: QD000P40CD; Serial: TP:1576
- Measurement SW: DASY52, Version 52.8 (8); SEMCAD X Version 14.6.10 (7331)

**Ch20600/Area Scan (71x111x1):** Interpolated grid: dx=1.500 mm, dy=1.500 mm

Maximum value of SAR (interpolated) = 0.412 W/kg

**Ch20600/Zoom Scan (5x5x7)/Cube 0:** Measurement grid: dx=8mm, dy=8mm, dz=5mm

Reference Value = 21.06 V/m; Power Drift = -0.03 dB

Peak SAR (extrapolated) = 0.842 W/kg

**SAR(1 g) = 0.396 W/kg; SAR(10 g) = 0.230 W/kg**

Maximum value of SAR (measured) = 0.441 W/kg

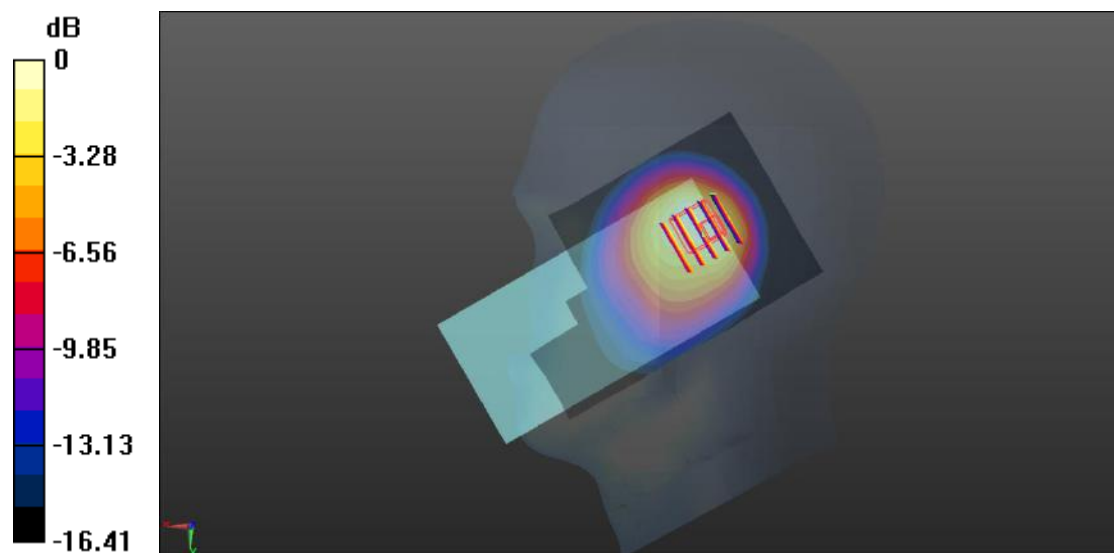

0 dB = 0.441 W/kg

**Meas.21 Body Plane with Back Side 10mm on Middle Channel in LTE Band5 mode with Antenna.1**

Date: 2022.10.01

Communication System Band: Band 5; Frequency: 836.5 MHz; Duty Cycle: 1:1

Medium parameters used (interpolated):  $f = 836.5$  MHz;  $\sigma = 0.902$  S/m;  $\epsilon_r = 41.746$ ;  $\rho = 1000$  kg/m<sup>3</sup>

Phantom section: Flat Section

Ambient Temperature: 22.5°C Liquid Temperature: 21.3°C

DASY5 Configuration:

- Probe: EX3DV4 - SN7607; ConvF(10.44, 10.44, 10.44); Calibrated: 2022.07.04;
- Sensor-Surface: 4mm (Mechanical Surface Detection)
- Electronics: DAE4 Sn878; Calibrated: 2022.06.13
- Phantom: SAM1; Type: QD000P40CD; Serial: TP:1576
- Measurement SW: DASY52, Version 52.8 (8); SEMCAD X Version 14.6.10 (7331)

**Ch20525/Area Scan (71x131x1):** Interpolated grid: dx=1.500 mm, dy=1.500 mm

Maximum value of SAR (interpolated) = 0.277 W/kg

**Ch20525/Zoom Scan (5x5x7)/Cube 0:** Measurement grid: dx=8mm, dy=8mm, dz=5mm

Reference Value = 13.69 V/m; Power Drift = -0.13 dB

Peak SAR (extrapolated) = 0.402 W/kg

**SAR(1 g) = 0.249 W/kg; SAR(10 g) = 0.152 W/kg**

Maximum value of SAR (measured) = 0.271 W/kg

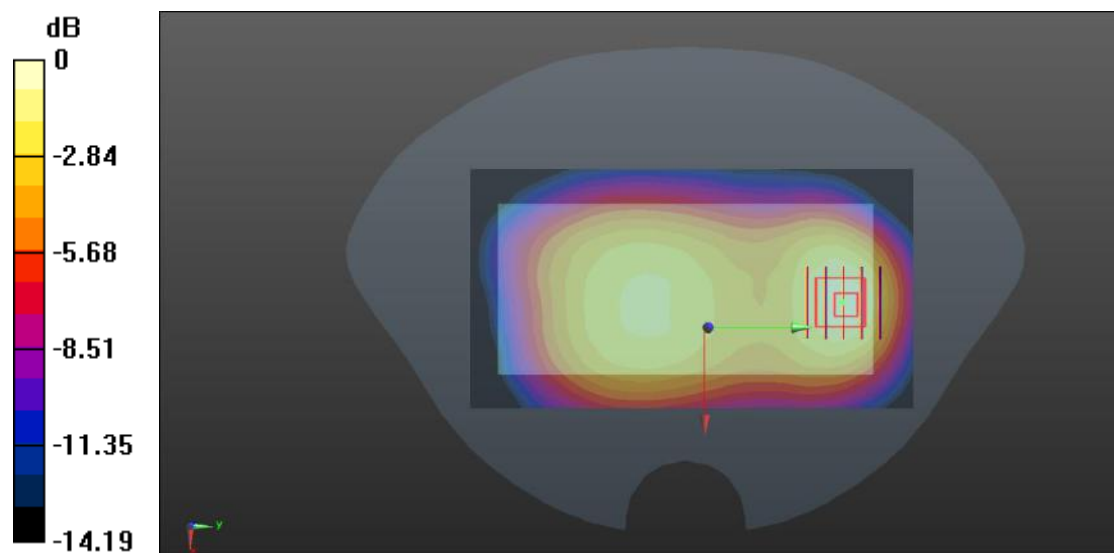

0 dB = 0.271 W/kg

**Meas.22 Right Head with Tilt on Middle Channel in LTE Band7 mode with Antenna.4**

Date: 2022.10.09

Communication System Band: Band 7; Frequency: 2535 MHz; Duty Cycle: 1:1

Medium parameters used (interpolated):  $f = 2535$  MHz;  $\sigma = 1.899$  S/m;  $\epsilon_r = 38.987$ ;  $\rho = 1000$  kg/m<sup>3</sup>

Phantom section: Right Section

Ambient Temperature: 22.4°C Liquid Temperature: 21.4°C

DASY5 Configuration:

- Probe: EX3DV4 - SN7607; ConvF(7.79, 7.79, 7.79); Calibrated: 2022.07.04;
- Sensor-Surface: 4mm (Mechanical Surface Detection)
- Electronics: DAE4 Sn878; Calibrated: 2022.06.13
- Phantom: SAM1; Type: QD000P40CD; Serial: TP:1576
- Measurement SW: DASY52, Version 52.8 (8); SEMCAD X Version 14.6.10 (7331)

**Ch21100/Area Scan (81x161x1):** Interpolated grid: dx=1.200 mm, dy=1.200 mm

Maximum value of SAR (interpolated) = 0.492 W/kg

**Ch21100/Zoom Scan (7x7x7)/Cube 0:** Measurement grid: dx=5mm, dy=5mm, dz=5mm

Reference Value = 7.005 V/m; Power Drift = 0.07 dB

Peak SAR (extrapolated) = 1.09 W/kg

**SAR(1 g) = 0.444 W/kg; SAR(10 g) = 0.185 W/kg**

Maximum value of SAR (measured) = 0.519 W/kg

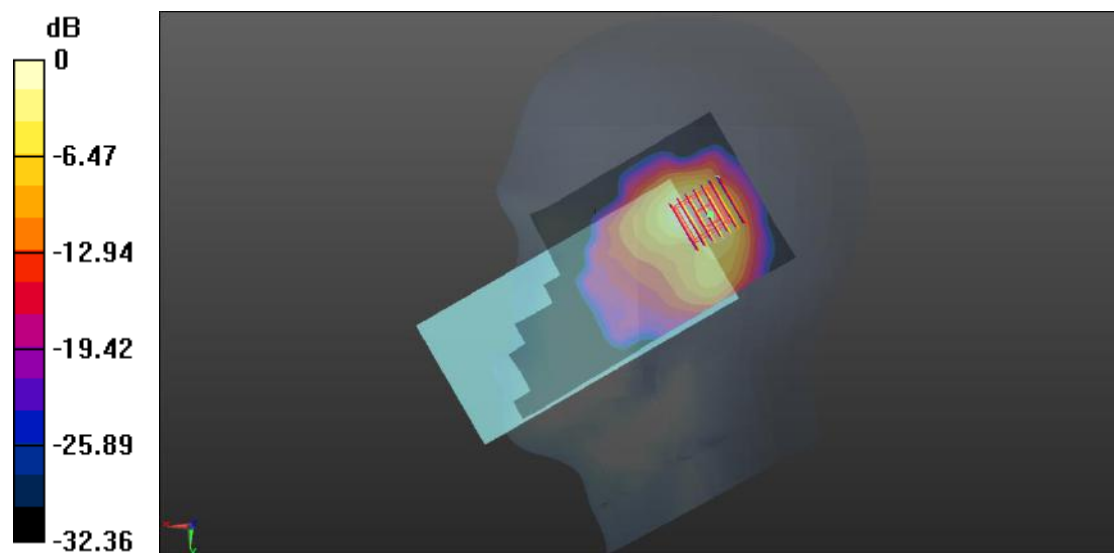

0 dB = 0.519 W/kg



**Meas.23 Body Plane with Back Side 10mm on Middle Channel in LTE Band7 mode with Antenna.2**

Date: 2022.10.09

Communication System Band: Band 7; Frequency: 2535 MHz; Duty Cycle: 1:1

Medium parameters used (interpolated):  $f = 2535$  MHz;  $\sigma = 1.899$  S/m;  $\epsilon_r = 38.987$ ;  $\rho = 1000$  kg/m<sup>3</sup>

Phantom section: Right Section

Ambient Temperature: 22.4°C Liquid Temperature: 21.4°C

DASY5 Configuration:

- Probe: EX3DV4 - SN7607; ConvF(7.79, 7.79, 7.79); Calibrated: 2022.07.04;
- Sensor-Surface: 4mm (Mechanical Surface Detection)
- Electronics: DAE4 Sn878; Calibrated: 2022.06.13
- Phantom: SAM1; Type: QD000P40CD; Serial: TP:1576
- Measurement SW: DASY52, Version 52.8 (8); SEMCAD X Version 14.6.10 (7331)

**Ch21100/Area Scan (91x161x1):** Interpolated grid: dx=1.200 mm, dy=1.200 mm

Maximum value of SAR (interpolated) = 0.196 W/kg

**Ch21100/Zoom Scan (7x7x7)/Cube 0:** Measurement grid: dx=5mm, dy=5mm, dz=5mm

Reference Value = 2.986 V/m; Power Drift = -0.13 dB

Peak SAR (extrapolated) = 0.333 W/kg

**SAR(1 g) = 0.174 W/kg; SAR(10 g) = 0.095 W/kg**

Maximum value of SAR (measured) = 0.188 W/kg

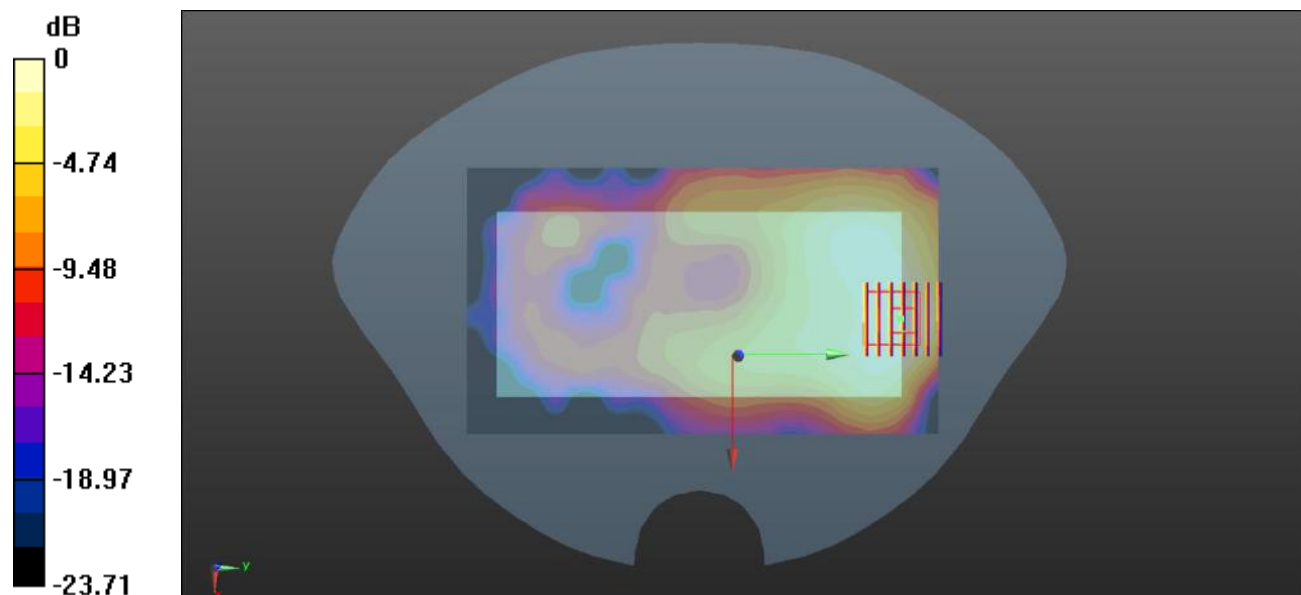

0 dB = 0.188 W/kg

**Meas.24 Right Head with Tilt on Middle Channel in LTE Band38 mode with Antenna.4**

Date: 2022.10.11

Communication System Band: Band 38; Frequency: 2595 MHz; Duty Cycle: 1:1.58

Medium parameters used (interpolated):  $f = 2595 \text{ MHz}$ ;  $\sigma = 1.966 \text{ S/m}$ ;  $\epsilon_r = 38.607$ ;  $\rho = 1000 \text{ kg/m}^3$

Phantom section: Right Section

Ambient Temperature: 22.7°C Liquid Temperature: 21.3°C

DASY5 Configuration:

- Probe: EX3DV4 - SN7607; ConvF(7.56, 7.56, 7.56); Calibrated: 2022.07.04;
- Sensor-Surface: 4mm (Mechanical Surface Detection)
- Electronics: DAE4 Sn878; Calibrated: 2022.06.13
- Phantom: SAM1; Type: QD000P40CD; Serial: TP:1576
- Measurement SW: DASY52, Version 52.8 (8); SEMCAD X Version 14.6.10 (7331)

**Ch38000/Area Scan (81x161x1):** Interpolated grid:  $dx=1.200 \text{ mm}$ ,  $dy=1.200 \text{ mm}$

Maximum value of SAR (interpolated) = 0.950 W/kg

**Ch38000/Zoom Scan (7x7x7)/Cube 0:** Measurement grid:  $dx=5\text{mm}$ ,  $dy=5\text{mm}$ ,  $dz=5\text{mm}$

Reference Value = 11.83 V/m; Power Drift = -0.13 dB

Peak SAR (extrapolated) = 2.02 W/kg

**SAR(1 g) = 0.797 W/kg; SAR(10 g) = 0.313 W/kg**

Maximum value of SAR (measured) = 0.965 W/kg

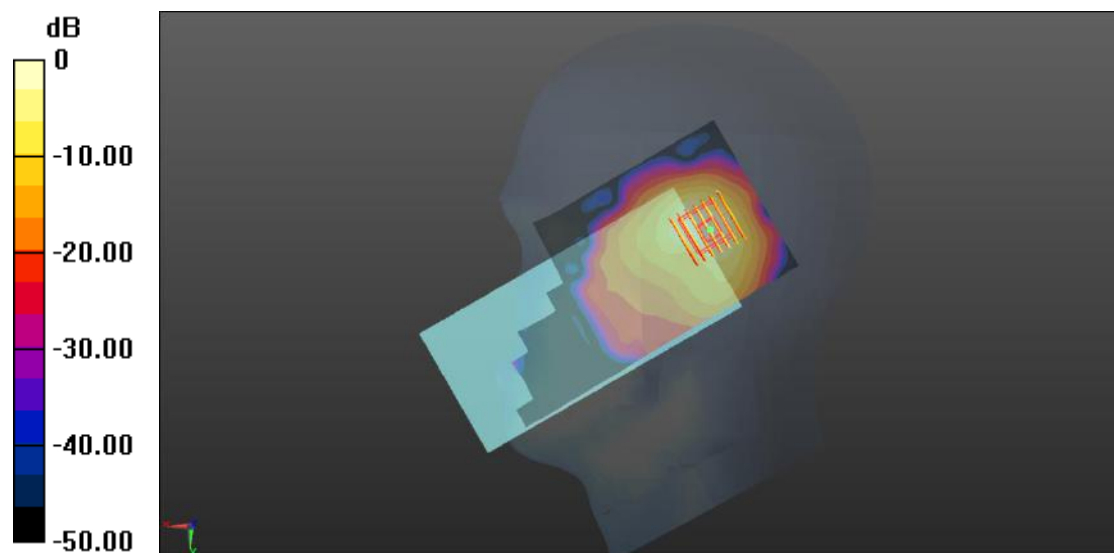

0 dB = 0.965 W/kg

**Meas.25 Body Plane with Top Edge 10mm on Middle Channel in LTE Band38 mode with Antenna.4**

Date: 2022.10.11

Communication System Band: Band 38; Frequency: 2595 MHz; Duty Cycle: 1:1.58

Medium parameters used (interpolated):  $f = 2595$  MHz;  $\sigma = 1.966$  S/m;  $\epsilon_r = 38.607$ ;  $\rho = 1000$  kg/m<sup>3</sup>

Phantom section: Flat Section

Ambient Temperature: 22.7°C Liquid Temperature: 21.3°C

DASY5 Configuration:

- Probe: EX3DV4 - SN7607; ConvF(7.56, 7.56, 7.56); Calibrated: 2022.07.04;
- Sensor-Surface: 4mm (Mechanical Surface Detection)
- Electronics: DAE4 Sn878; Calibrated: 2022.06.13
- Phantom: SAM1; Type: QD000P40CD; Serial: TP:1576
- Measurement SW: DASY52, Version 52.8 (8); SEMCAD X Version 14.6.10 (7331)

**Ch38000/Area Scan (61x91x1):** Interpolated grid: dx=1.200 mm, dy=1.200 mm

Maximum value of SAR (interpolated) = 0.408 W/kg

**Ch38000/Zoom Scan (7x7x7)/Cube 0:** Measurement grid: dx=5mm, dy=5mm, dz=5mm

Reference Value = 8.581 V/m; Power Drift = 0.02 dB

Peak SAR (extrapolated) = 0.746 W/kg

**SAR(1 g) = 0.339 W/kg; SAR(10 g) = 0.142 W/kg**

Maximum value of SAR (measured) = 0.390 W/kg

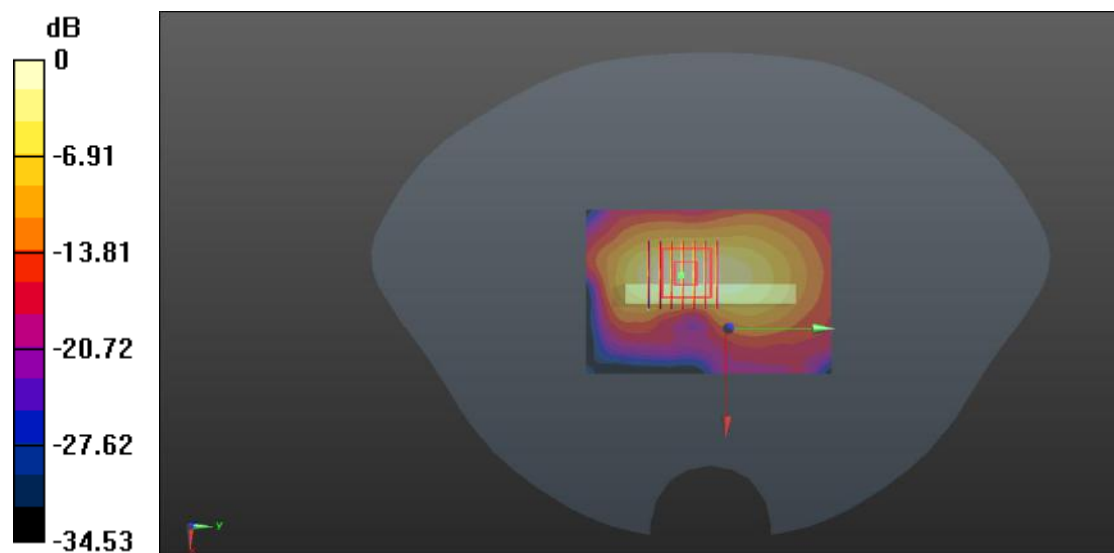

0 dB = 0.390 W/kg

**Meas.26 Body Plane with Top Edge 0mm on Middle Channel in LTE Band38 mode with Antenna 4**

Date: 2022.10.11

Communication System Band: Band 38; Frequency: 2595 MHz; Duty Cycle: 1:1.58

Medium parameters used (interpolated):  $f = 2595$  MHz;  $\sigma = 1.966$  S/m;  $\epsilon_r = 38.607$ ;  $\rho = 1000$  kg/m<sup>3</sup>

Phantom section: Flat Section

Ambient Temperature: 22.7°C Liquid Temperature: 21.3°C

DASY5 Configuration:

- Probe: EX3DV4 - SN7607; ConvF(7.56, 7.56, 7.56); Calibrated: 2022.07.04;
- Sensor-Surface: 4mm (Mechanical Surface Detection)
- Electronics: DAE4 Sn878; Calibrated: 2022.06.13
- Phantom: SAM1; Type: QD000P40CD; Serial: TP:1576
- Measurement SW: DASY52, Version 52.8 (8); SEMCAD X Version 14.6.10 (7331)

**Ch38000/Area Scan (61x81x1):** Interpolated grid: dx=1.200 mm, dy=1.200 mm

Maximum value of SAR (interpolated) = 2.33 W/kg

**Ch38000/Zoom Scan (7x7x7)/Cube 0:** Measurement grid: dx=5mm, dy=5mm, dz=5mm

Reference Value = 15.88 V/m; Power Drift = 0.03 dB

Peak SAR (extrapolated) = 6.88 W/kg

**SAR(1 g) = 1.93 W/kg; SAR(10 g) = 0.633 W/kg**

Maximum value of SAR (measured) = 2.45 W/kg

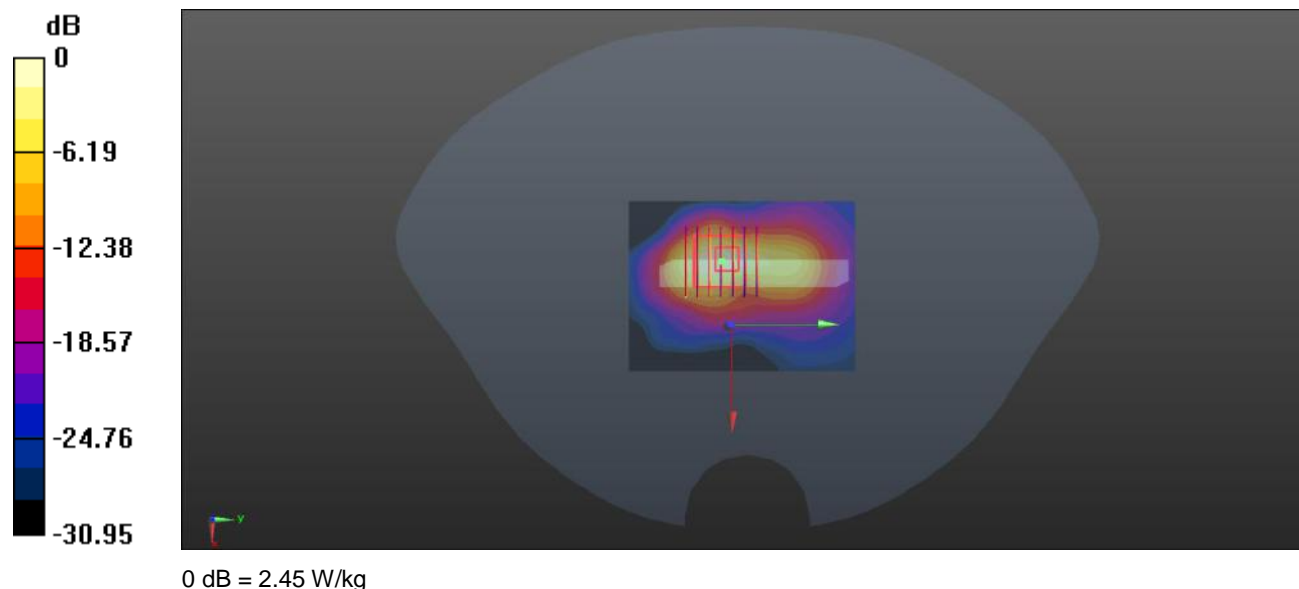

**Meas.27 Right Head with Tilt on High Channel in LTE Band41 mode with Antenna.4**

Date: 2022.10.13

Communication System Band: Band 41; Frequency: 2636.5 MHz; Duty Cycle: 1:1.58

Medium parameters used (interpolated):  $f = 2636.5$  MHz;  $\sigma = 2.049$  S/m;  $\epsilon_r = 38.525$ ;  $\rho = 1000$  kg/m<sup>3</sup>

Phantom section: Right Section

Ambient Temperature: 22.9°C Liquid Temperature: 21.8°C

DASY5 Configuration:

- Probe: EX3DV4 - SN7607; ConvF(7.56, 7.56, 7.56); Calibrated: 2022.07.04;
- Sensor-Surface: 4mm (Mechanical Surface Detection)
- Electronics: DAE4 Sn878; Calibrated: 2022.06.13
- Phantom: SAM1; Type: QD000P40CD; Serial: TP:1576
- Measurement SW: DASY52, Version 52.8 (8); SEMCAD X Version 14.6.10 (7331)

**Ch41055/Area Scan (81x161x1):** Interpolated grid: dx=1.200 mm, dy=1.200 mm

Maximum value of SAR (interpolated) = 0.821 W/kg

**Ch41055/Zoom Scan (7x7x7)/Cube 0:** Measurement grid: dx=5mm, dy=5mm, dz=5mm

Reference Value = 9.976 V/m; Power Drift = 0.14 dB

Peak SAR (extrapolated) = 1.67 W/kg

**SAR(1 g) = 0.649 W/kg; SAR(10 g) = 0.250 W/kg**

Maximum value of SAR (measured) = 0.767 W/kg

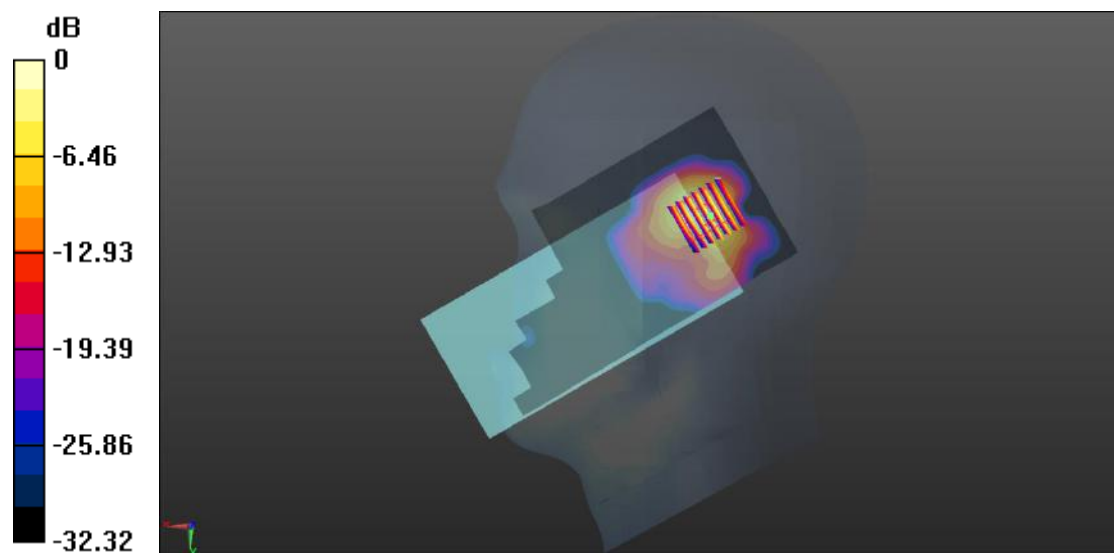

0 dB = 0.767 W/kg

**Meas.28 Body Plane with Top Edge 10mm on Middle Channel in LTE Band41 mode with Antenna.4**

Date: 2022.10.13

Communication System Band: Band 41; Frequency: 2593 MHz; Duty Cycle: 1:1.58

Medium parameters used (interpolated):  $f = 2593$  MHz;  $\sigma = 1.989$  S/m;  $\epsilon_r = 38.697$ ;  $\rho = 1000$  kg/m<sup>3</sup>

Phantom section: Flat Section

Ambient Temperature: 22.9°C Liquid Temperature: 21.8°C

DASY5 Configuration:

- Probe: EX3DV4 - SN7607; ConvF(7.56, 7.56, 7.56); Calibrated: 2022.07.04;
- Sensor-Surface: 4mm (Mechanical Surface Detection)
- Electronics: DAE4 Sn878; Calibrated: 2022.06.13
- Phantom: SAM1; Type: QD000P40CD; Serial: TP:1576
- Measurement SW: DASY52, Version 52.8 (8); SEMCAD X Version 14.6.10 (7331)

**Ch40620/Area Scan (61x91x1):** Interpolated grid: dx=1.200 mm, dy=1.200 mm

Maximum value of SAR (interpolated) = 0.444 W/kg

**Ch40620/Zoom Scan (7x7x7)/Cube 0:** Measurement grid: dx=5mm, dy=5mm, dz=5mm

Reference Value = 11.28 V/m; Power Drift = 0.12 dB

Peak SAR (extrapolated) = 0.739 W/kg

**SAR(1 g) = 0.334 W/kg; SAR(10 g) = 0.141 W/kg**

Maximum value of SAR (measured) = 0.377 W/kg

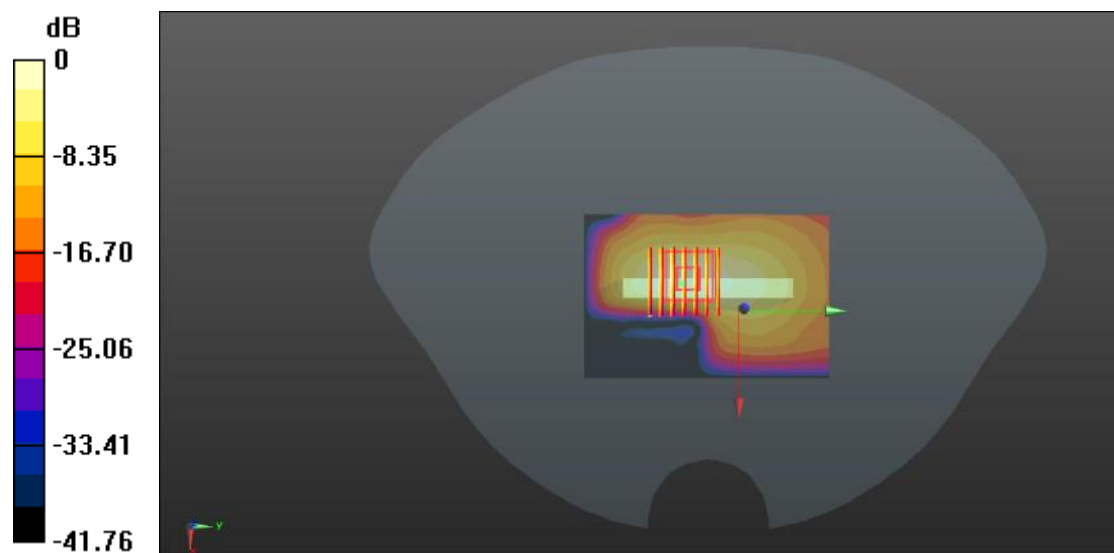

0 dB = 0.377 W/kg

**Meas.29 Body Plane with Top Edge 0mm on Middle Channel in LTE Band41 mode with Antenna.4**

Date: 2022.10.13

Communication System Band: Band 41; Frequency: 2593 MHz; Duty Cycle: 1:1.58

Medium parameters used (interpolated):  $f = 2593$  MHz;  $\sigma = 1.989$  S/m;  $\epsilon_r = 38.697$ ;  $\rho = 1000$  kg/m<sup>3</sup>

Phantom section: Flat Section

Ambient Temperature: 22.9°C Liquid Temperature: 21.8°C

DASY5 Configuration:

- Probe: EX3DV4 - SN7607; ConvF(7.56, 7.56, 7.56); Calibrated: 2022.07.04;
- Sensor-Surface: 4mm (Mechanical Surface Detection)
- Electronics: DAE4 Sn878; Calibrated: 2022.06.13
- Phantom: SAM1; Type: QD000P40CD; Serial: TP:1576
- Measurement SW: DASY52, Version 52.8 (8); SEMCAD X Version 14.6.10 (7331)

**Ch40620/Area Scan (61x81x1):** Interpolated grid: dx=1.200 mm, dy=1.200 mm

Maximum value of SAR (interpolated) = 2.32 W/kg

**Ch40620/Zoom Scan (7x7x7)/Cube 0:** Measurement grid: dx=5mm, dy=5mm, dz=5mm

Reference Value = 15.71 V/m; Power Drift = 0.17 dB

Peak SAR (extrapolated) = 6.86 W/kg

**SAR(1 g) = 1.92 W/kg; SAR(10 g) = 0.628 W/kg**

Maximum value of SAR (measured) = 2.39 W/kg

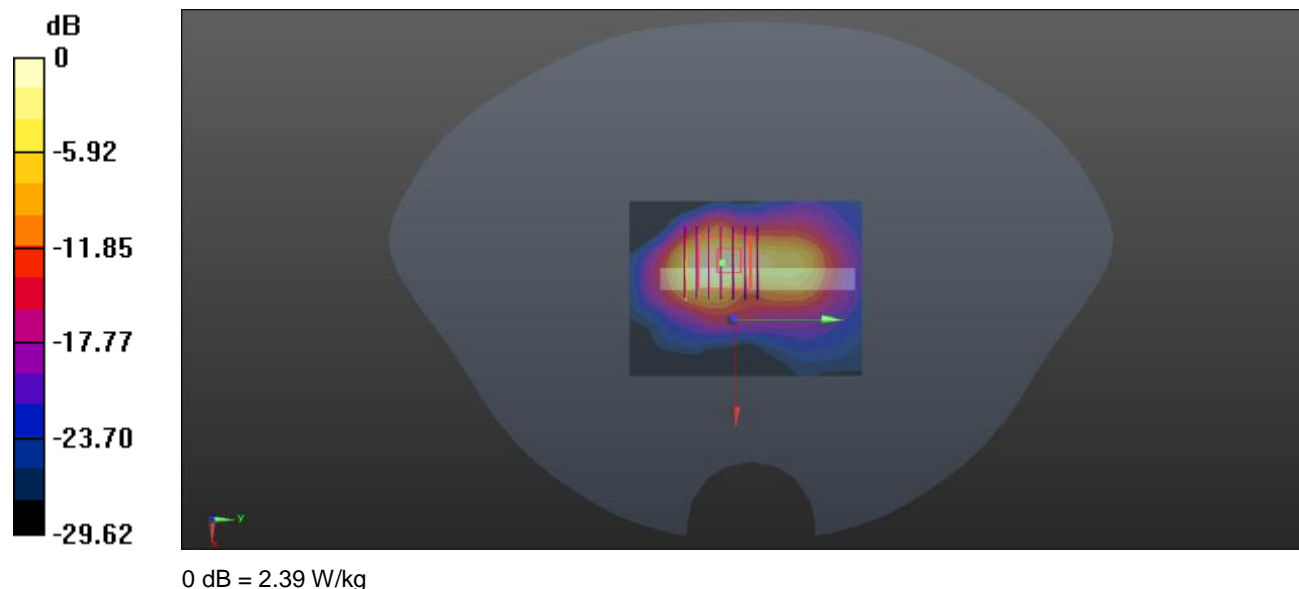

**Meas.30 Right Head with Tilt on PCC21100+SCC21298 Channel in LTE Band7 mode with Antenna.4**

Date: 2022.10.09

Communication System Band: Band 7; Frequency: 2535 MHz; Duty Cycle: 1:1

Medium parameters used (interpolated):  $f = 2535$  MHz;  $\sigma = 1.899$  S/m;  $\epsilon_r = 38.987$ ;  $\rho = 1000$  kg/m<sup>3</sup>

Phantom section: Right Section

Ambient Temperature: 22.4°C Liquid Temperature: 21.4°C

DASY5 Configuration:

- Probe: EX3DV4 - SN7607; ConvF(7.79, 7.79, 7.79); Calibrated: 2022.07.04;
- Sensor-Surface: 4mm (Mechanical Surface Detection)
- Electronics: DAE4 Sn878; Calibrated: 2022.06.13
- Phantom: SAM1; Type: QD000P40CD; Serial: TP:1576
- Measurement SW: DASY52, Version 52.8 (8); SEMCAD X Version 14.6.10 (7331)

**Ch21100/Area Scan (81x161x1):** Interpolated grid: dx=1.200 mm, dy=1.200 mm

Maximum value of SAR (interpolated) = 0.433 W/kg

**Ch21100/Zoom Scan (7x7x7)/Cube 0:** Measurement grid: dx=5mm, dy=5mm, dz=5mm

Reference Value = 11.36 V/m; Power Drift = -0.02 dB

Peak SAR (extrapolated) = 0.902 W/kg

**SAR(1 g) = 0.402 W/kg; SAR(10 g) = 0.175 W/kg**

Maximum value of SAR (measured) = 0.471 W/kg

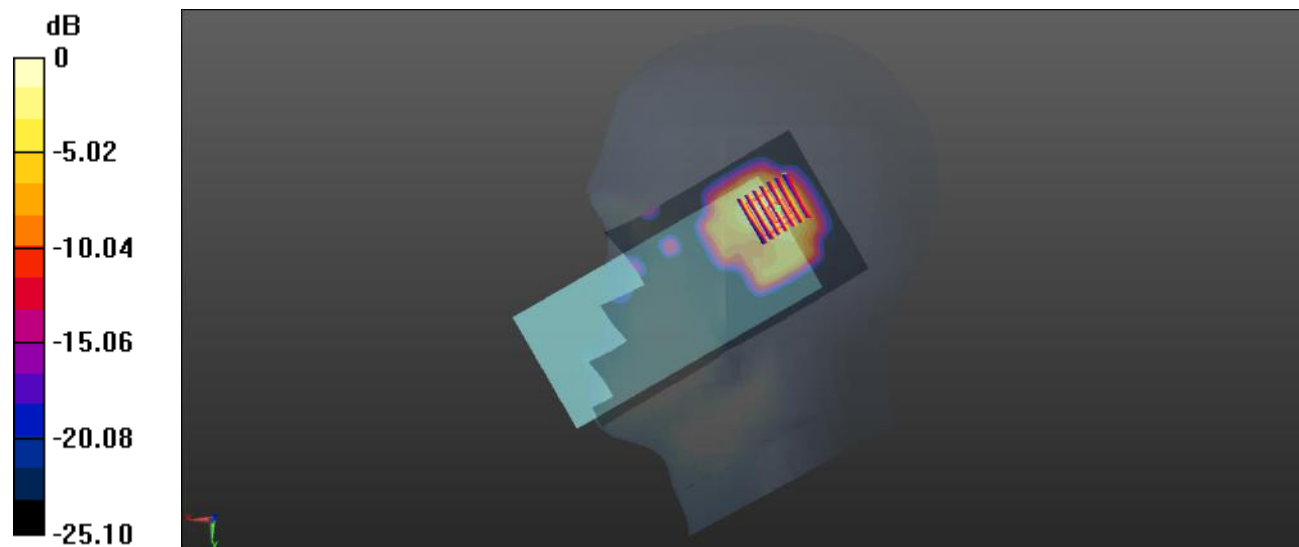

0 dB = 0.471 W/kg



**Meas.31 Body Plane with Back Side 10mm on PCC21100+SCC21298 Channel in LTE Band7 mode with Antenna.1**

Date: 2022.10.09

Communication System Band: Band 7; Frequency: 2535 MHz; Duty Cycle: 1:1

Medium parameters used (interpolated):  $f = 2535$  MHz;  $\sigma = 1.899$  S/m;  $\epsilon_r = 38.987$ ;  $\rho = 1000$  kg/m<sup>3</sup>

Phantom section: Flat Section

Ambient Temperature: 22.4°C Liquid Temperature: 21.4°C

DASY5 Configuration:

- Probe: EX3DV4 - SN7607; ConvF(7.79, 7.79, 7.79); Calibrated: 2022.07.04;
- Sensor-Surface: 4mm (Mechanical Surface Detection)
- Electronics: DAE4 Sn878; Calibrated: 2022.06.13
- Phantom: SAM1; Type: QD000P40CD; Serial: TP:1576
- Measurement SW: DASY52, Version 52.8 (8); SEMCAD X Version 14.6.10 (7331)

**Ch21100/Area Scan (81x161x1):** Interpolated grid: dx=1.200 mm, dy=1.200 mm

Maximum value of SAR (interpolated) = 0.193 W/kg

**Ch21100/Zoom Scan (7x7x7)/Cube 0:** Measurement grid: dx=5mm, dy=5mm, dz=5mm

Reference Value = 2.608 V/m; Power Drift = -0.05 dB

Peak SAR (extrapolated) = 0.314 W/kg

**SAR(1 g) = 0.167 W/kg; SAR(10 g) = 0.090 W/kg**

Maximum value of SAR (measured) = 0.183 W/kg

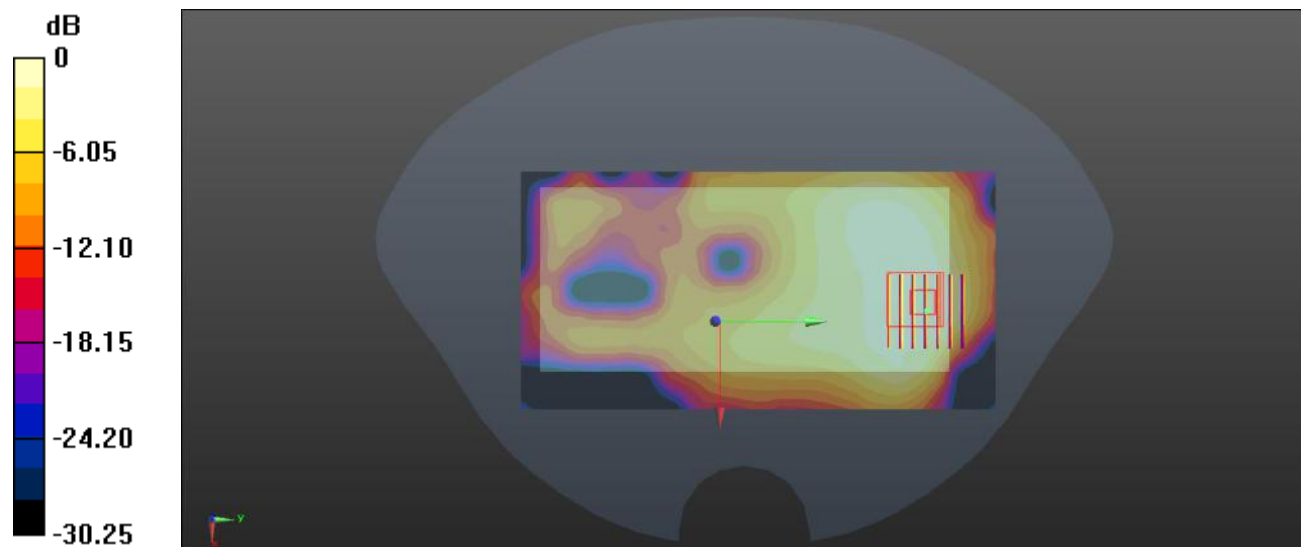

0 dB = 0.183 W/kg

**Meas.32 Right Head with Tilt on PCC38099+SCC37901 Channel in LTE Band38 mode with Antenna.4**

Date: 2022.10.11

Communication System Band: Band 38; Frequency: 2604.9 MHz; Duty Cycle: 1:1.58

Medium parameters used (interpolated):  $f = 2604.9$  MHz;  $\sigma = 1.976$  S/m;  $\epsilon_r = 38.503$ ;  $\rho = 1000$  kg/m<sup>3</sup>

Phantom section: Right Section

Ambient Temperature: 22.7°C Liquid Temperature: 21.3°C

DASY5 Configuration:

- Probe: EX3DV4 - SN7607; ConvF(7.56, 7.56, 7.56); Calibrated: 2022.07.04;
- Sensor-Surface: 4mm (Mechanical Surface Detection)
- Electronics: DAE4 Sn878; Calibrated: 2022.06.13
- Phantom: SAM1; Type: QD000P40CD; Serial: TP:1576
- Measurement SW: DASY52, Version 52.8 (8); SEMCAD X Version 14.6.10 (7331)

**Ch38099/Area Scan (81x161x1):** Interpolated grid: dx=1.200 mm, dy=1.200 mm

Maximum value of SAR (interpolated) = 0.932 W/kg

**Ch38099/Zoom Scan (7x7x7)/Cube 0:** Measurement grid: dx=5mm, dy=5mm, dz=5mm

Reference Value = 7.168 V/m; Power Drift = 0.02 dB

Peak SAR (extrapolated) = 1.90 W/kg

**SAR(1 g) = 0.784 W/kg; SAR(10 g) = 0.314 W/kg**

Maximum value of SAR (measured) = 0.943 W/kg

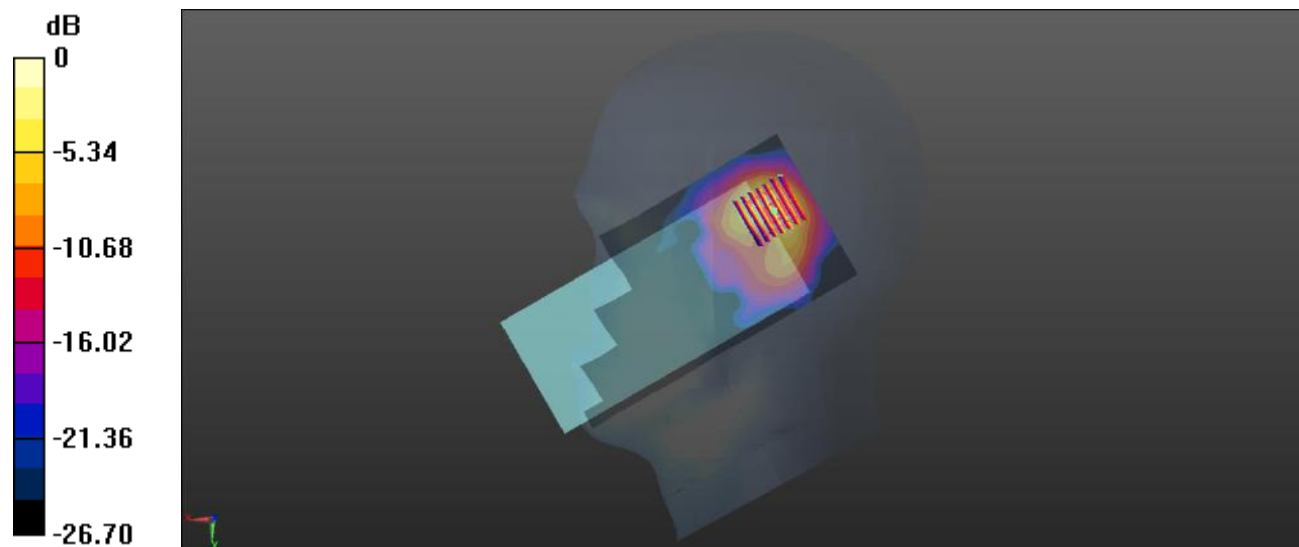

0 dB = 0.943 W/kg

**Meas.33 Body Plane with Top Edge 10mm on PCC38099+SCC37901 Channel in LTE Band38 mode with Antenna.4**

Date: 2022.10.11

Communication System Band: Band 38; Frequency: 2604.9 MHz; Duty Cycle: 1:1.58

Medium parameters used (interpolated):  $f = 2604.9$  MHz;  $\sigma = 1.976$  S/m;  $\epsilon_r = 38.503$ ;  $\rho = 1000$  kg/m<sup>3</sup>

Phantom section: Flat Section

Ambient Temperature: 22.7°C Liquid Temperature: 21.3°C

DASY5 Configuration:

- Probe: EX3DV4 - SN7607; ConvF(7.56, 7.56, 7.56); Calibrated: 2022.07.04;
- Sensor-Surface: 4mm (Mechanical Surface Detection)
- Electronics: DAE4 Sn878; Calibrated: 2022.06.13
- Phantom: SAM1; Type: QD000P40CD; Serial: TP:1576
- Measurement SW: DASY52, Version 52.8 (8); SEMCAD X Version 14.6.10 (7331)

**Ch38099/Area Scan (61x81x1):** Interpolated grid: dx=1.200 mm, dy=1.200 mm

Maximum value of SAR (interpolated) = 0.378 W/kg

**Ch38099/Zoom Scan (7x7x7)/Cube 0:** Measurement grid: dx=5mm, dy=5mm, dz=5mm

Reference Value = 7.171 V/m; Power Drift = 0.07 dB

Peak SAR (extrapolated) = 0.658 W/kg

**SAR(1 g) = 0.308 W/kg; SAR(10 g) = 0.134 W/kg**

Maximum value of SAR (measured) = 0.361 W/kg

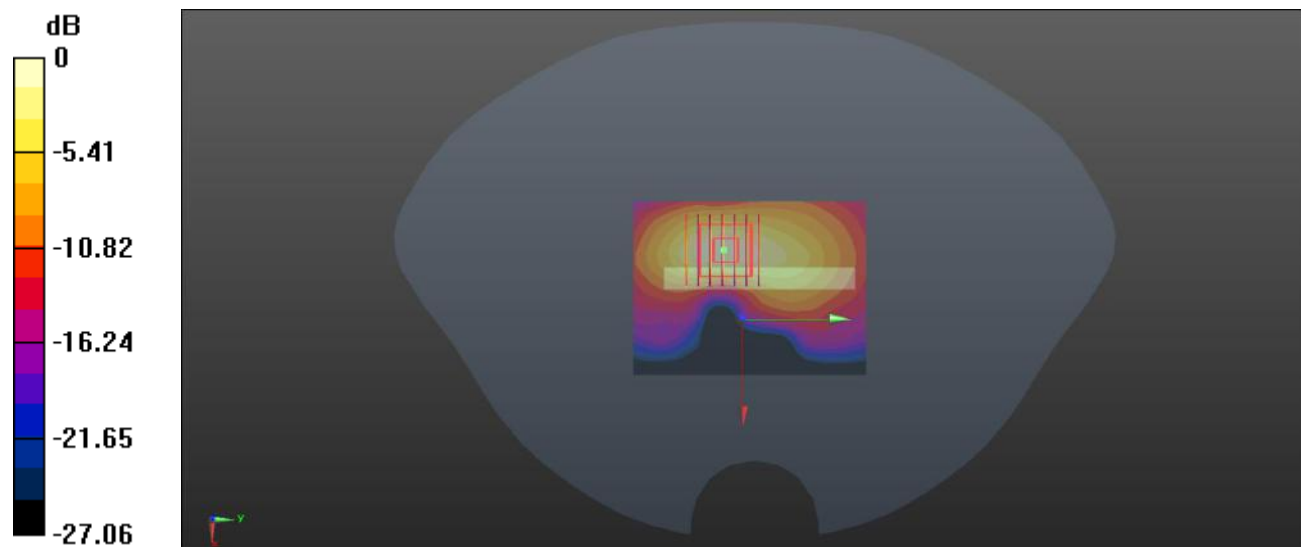

0 dB = 0.361 W/kg

**Meas.34 Body Plane with Top Edge 0mm on PCC38099+SCC37901 Channel in LTE Band38 mode with Antenna 4**

Date: 2022.10.11

Communication System Band: Band 38; Frequency: 2604.9 MHz; Duty Cycle: 1:1.58

Medium parameters used (interpolated):  $f = 2604.9$  MHz;  $\sigma = 1.976$  S/m;  $\epsilon_r = 38.503$ ;  $\rho = 1000$  kg/m<sup>3</sup>

Phantom section: Flat Section

Ambient Temperature: 22.7°C Liquid Temperature: 21.3°C

DASY5 Configuration:

- Probe: EX3DV4 - SN7607; ConvF(7.56, 7.56, 7.56); Calibrated: 2022.07.04;
- Sensor-Surface: 4mm (Mechanical Surface Detection)
- Electronics: DAE4 Sn878; Calibrated: 2022.06.13
- Phantom: SAM1; Type: QD000P40CD; Serial: TP:1576
- Measurement SW: DASY52, Version 52.8 (8); SEMCAD X Version 14.6.10 (7331)

**Ch38099/Area Scan (61x81x1):** Interpolated grid: dx=1.200 mm, dy=1.200 mm

Maximum value of SAR (interpolated) = 1.84 W/kg

**Configuration/Ch38099 2/Zoom Scan (7x7x7)/Cube 0:** Measurement grid: dx=5mm, dy=5mm, dz=5mm

Reference Value = 28.16 V/m; Power Drift = 0.02 dB

Peak SAR (extrapolated) = 6.95 W/kg

**SAR(1 g) = 1.95 W/kg; SAR(10 g) = 0.594 W/kg**

Maximum value of SAR (measured) = 2.49 W/kg

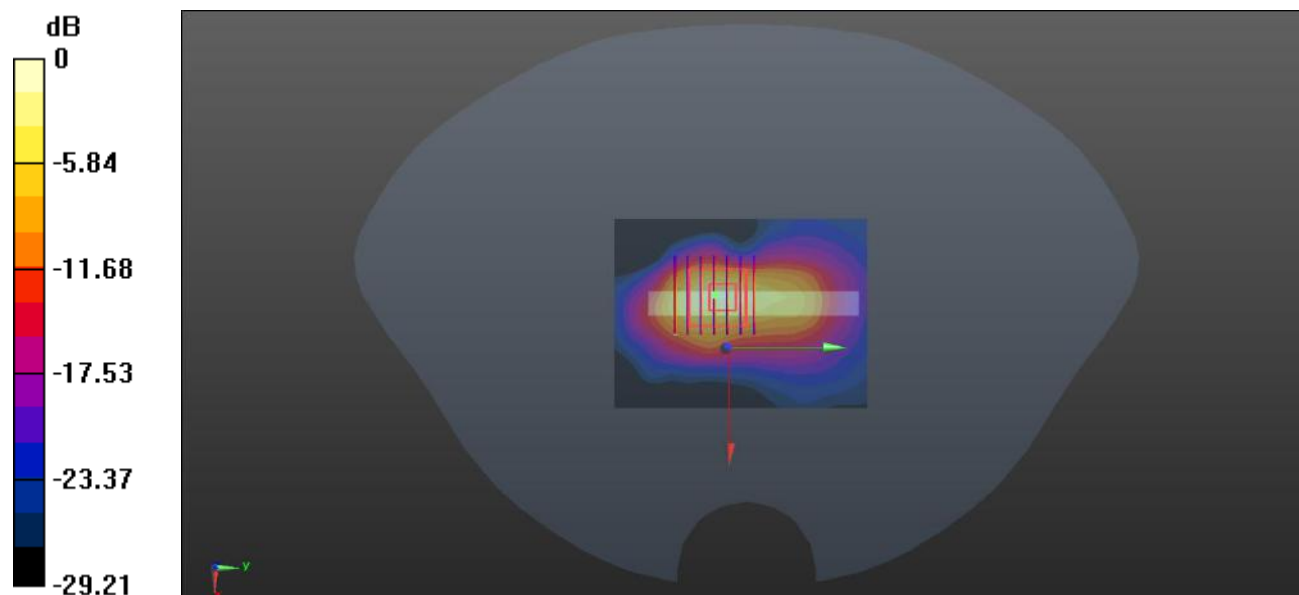

0 dB = 2.49 W/kg

**Meas.35 Right Head with Cheek on 167300 Channel in N5 mode with Antenna 4**

Date: 2022.10.02

Communication System Band: N5; Frequency: 836.5 MHz; Duty Cycle: 1:1

Medium parameters used (interpolated):  $f = 836.5$  MHz;  $\sigma = 0.918$  S/m;  $\epsilon_r = 41.722$ ;  $\rho = 1000$  kg/m<sup>3</sup>

Phantom section: Right Section

Ambient Temperature: 22.4°C Liquid Temperature: 21.1°C

DASY5 Configuration:

- Probe: EX3DV4 - SN7607; ConvF(10.44, 10.44, 10.44); Calibrated: 2022.07.04;
- Sensor-Surface: 4mm (Mechanical Surface Detection)
- Electronics: DAE4 Sn878; Calibrated: 2022.06.13
- Phantom: SAM1; Type: QD000P40CD; Serial: TP:1576
- Measurement SW: DASY52, Version 52.8 (8); SEMCAD X Version 14.6.10 (7331)

**Ch167300/Area Scan (71x131x1):** Interpolated grid: dx=1.500 mm, dy=1.500 mm

Maximum value of SAR (interpolated) = 0.547 W/kg

**Ch167300/Zoom Scan (5x5x7)/Cube 0:** Measurement grid: dx=8mm, dy=8mm, dz=5mm

Reference Value = 19.24 V/m; Power Drift = -0.17 dB

Peak SAR (extrapolated) = 0.656 W/kg

**SAR(1 g) = 0.386 W/kg; SAR(10 g) = 0.252 W/kg**

Maximum value of SAR (measured) = 0.376 W/kg

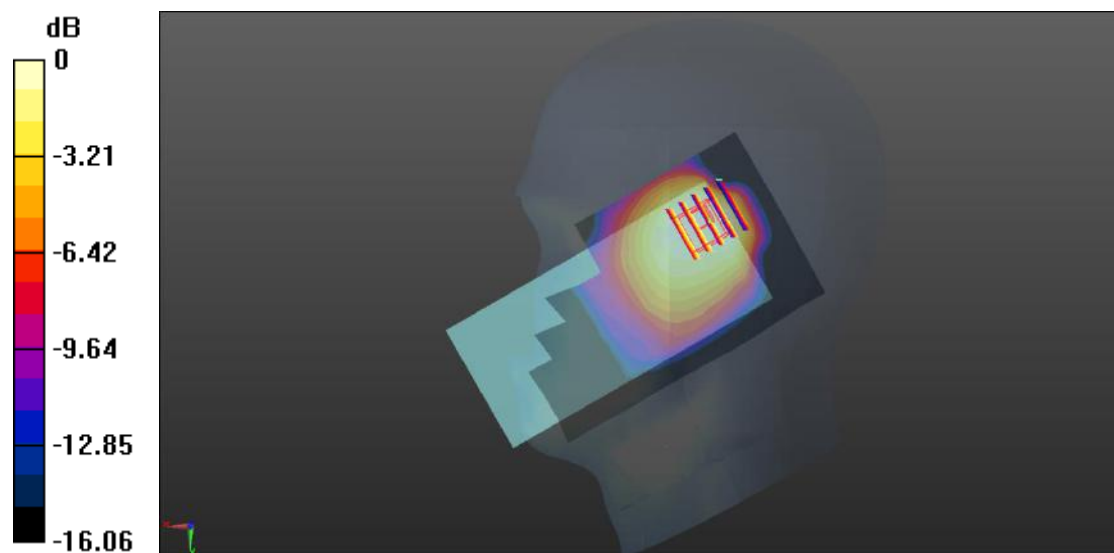

0 dB = 0.376 W/kg

**Meas.36 Body Plane with Back Side 10mm on 166800 Channel in N5 mode with Antenna.4**

Date: 2022.10.02

Communication System Band: N5; Frequency: 834 MHz; Duty Cycle: 1:1

Medium parameters used (interpolated):  $f = 834$  MHz;  $\sigma = 0.903$  S/m;  $\epsilon_r = 41.847$ ;  $\rho = 1000$  kg/m<sup>3</sup>

Phantom section: Flat Section

Ambient Temperature: 22.4°C Liquid Temperature: 21.1°C

DASY5 Configuration:

- Probe: EX3DV4 - SN7607; ConvF(10.44, 10.44, 10.44); Calibrated: 2022.07.04;
- Sensor-Surface: 4mm (Mechanical Surface Detection)
- Electronics: DAE4 Sn878; Calibrated: 2022.06.13
- Phantom: SAM1; Type: QD000P40CD; Serial: TP:1576
- Measurement SW: DASY52, Version 52.8 (8); SEMCAD X Version 14.6.10 (7331)

**Ch166800/Area Scan (71x131x1):** Interpolated grid: dx=1.500 mm, dy=1.500 mm

Maximum value of SAR (interpolated) = 0.304 W/kg

**Ch166800/Zoom Scan (5x5x7)/Cube 0:** Measurement grid: dx=8mm, dy=8mm, dz=5mm

Reference Value = 11.60 V/m; Power Drift = 0.04 dB

Peak SAR (extrapolated) = 0.444 W/kg

**SAR(1 g) = 0.263 W/kg; SAR(10 g) = 0.173 W/kg**

Maximum value of SAR (measured) = 0.291 W/kg

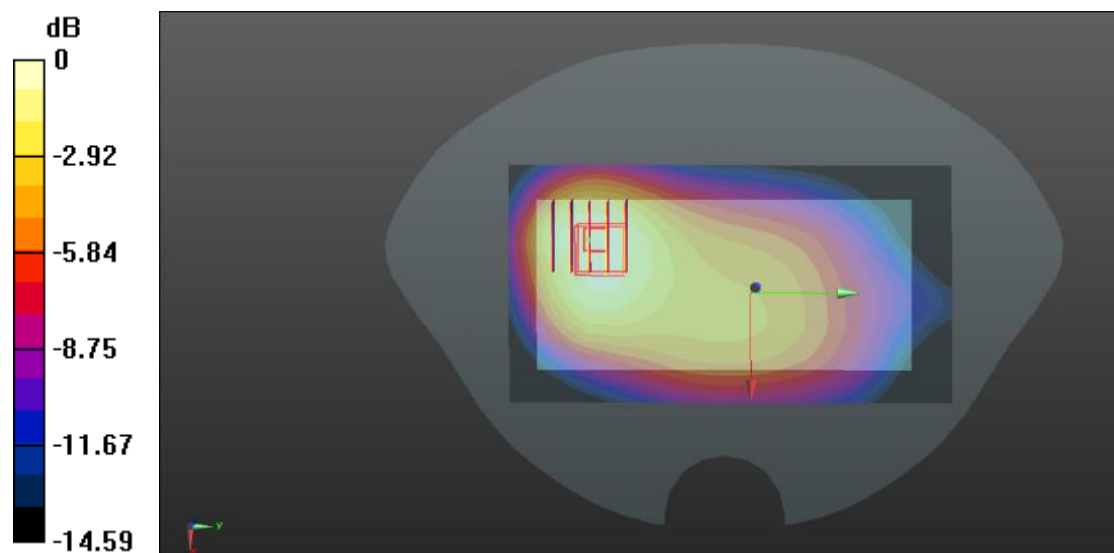

0 dB = 0.291 W/kg

**Meas.37 Right Head with Cheek on 502000 Channel in N7 mode with Antenna.4**

Date: 2022.10.10

Communication System Band: N7; Frequency: 2510 MHz; Duty Cycle: 1:1

Medium parameters used (interpolated):  $f = 2510$  MHz;  $\sigma = 1.865$  S/m;  $\epsilon_r = 39.138$ ;  $\rho = 1000$  kg/m<sup>3</sup>

Phantom section: Right Section

Ambient Temperature: 22.6°C Liquid Temperature: 21.5°C

DASY5 Configuration:

- Probe: EX3DV4 - SN7607; ConvF(7.79, 7.79, 7.79); Calibrated: 2022.07.04;
- Sensor-Surface: 4mm (Mechanical Surface Detection)
- Electronics: DAE4 Sn878; Calibrated: 2022.06.13
- Phantom: SAM1; Type: QD000P40CD; Serial: TP:1576
- Measurement SW: DASY52, Version 52.8 (8); SEMCAD X Version 14.6.10 (7331)

**Ch502000/Area Scan (81x161x1):** Interpolated grid: dx=1.200 mm, dy=1.200 mm

Maximum value of SAR (interpolated) = 1.07 W/kg

**Ch502000/Zoom Scan (7x7x7)/Cube 0:** Measurement grid: dx=5mm, dy=5mm, dz=5mm

Reference Value = 14.76 V/m; Power Drift = -0.13 dB

Peak SAR (extrapolated) = 1.99 W/kg

**SAR(1 g) = 0.866 W/kg; SAR(10 g) = 0.385 W/kg**

Maximum value of SAR (measured) = 0.996 W/kg

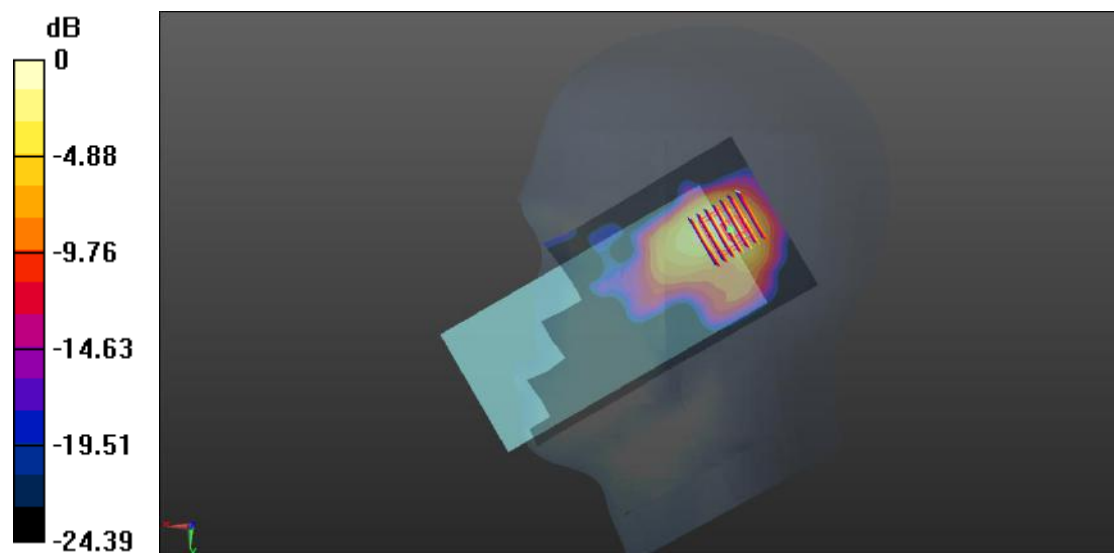

0 dB = 0.996 W/kg

**Meas.38 Body Plane with Back Side 10mm on 507000 Channel in N7 mode with Antenna.1**

Date: 2022.10.10

Communication System Band: N7; Frequency: 2535 MHz; Duty Cycle: 1:1

Medium parameters used (interpolated):  $f = 2535$  MHz;  $\sigma = 1.895$  S/m;  $\epsilon_r = 38.968$ ;  $\rho = 1000$  kg/m<sup>3</sup>

Phantom section: Flat Section

Ambient Temperature: 22.6°C Liquid Temperature: 21.5°C

DASY5 Configuration:

- Probe: EX3DV4 - SN7607; ConvF(7.79, 7.79, 7.79); Calibrated: 2022.07.04;
- Sensor-Surface: 4mm (Mechanical Surface Detection)
- Electronics: DAE4 Sn878; Calibrated: 2022.06.13
- Phantom: SAM1; Type: QD000P40CD; Serial: TP:1576
- Measurement SW: DASY52, Version 52.8 (8); SEMCAD X Version 14.6.10 (7331)

**Ch507000/Area Scan (91x161x1):** Interpolated grid: dx=1.200 mm, dy=1.200 mm

Maximum value of SAR (interpolated) = 0.381 W/kg

**Ch507000/Zoom Scan (7x7x7)/Cube 0:** Measurement grid: dx=5mm, dy=5mm, dz=5mm

Reference Value = 4.435 V/m; Power Drift = 0.08 dB

Peak SAR (extrapolated) = 0.677 W/kg

**SAR(1 g) = 0.356 W/kg; SAR(10 g) = 0.188 W/kg**

Maximum value of SAR (measured) = 0.398 W/kg

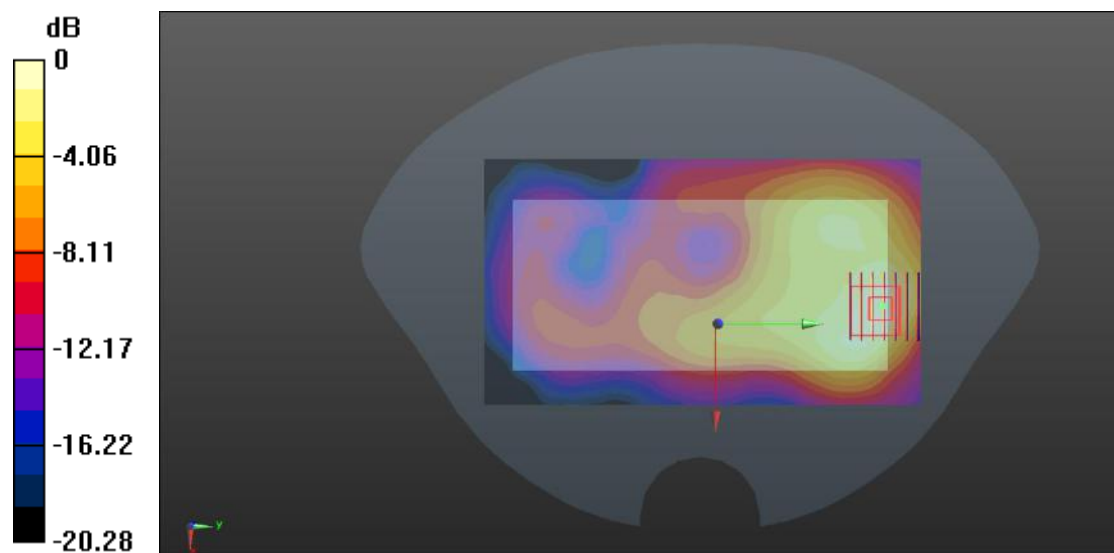

0 dB = 0.398 W/kg



**Meas.39 Body Plane with Back Side 0mm on 507000 Channel in N7 mode with Antenna4-50-DSI4**

Date: 2022.10.10

Communication System Band: N7; Frequency: 2535 MHz; Duty Cycle: 1:1

Medium parameters used (interpolated):  $f = 2535$  MHz;  $\sigma = 1.895$  S/m;  $\epsilon_r = 38.968$ ;  $\rho = 1000$  kg/m<sup>3</sup>

Phantom section: Flat Section

Ambient Temperature: 22.6°C Liquid Temperature: 21.5°C

DASY5 Configuration:

- Probe: EX3DV4 - SN7607; ConvF(7.79, 7.79, 7.79); Calibrated: 2022.07.04;
- Sensor-Surface: 4mm (Mechanical Surface Detection)
- Electronics: DAE4 Sn878; Calibrated: 2022.06.13
- Phantom: SAM1; Type: QD000P40CD; Serial: TP:1576
- Measurement SW: DASY52, Version 52.8 (8); SEMCAD X Version 14.6.10 (7331)

**Ch507000 3/Area Scan (81x151x1):** Interpolated grid: dx=1.200 mm, dy=1.200 mm

Maximum value of SAR (interpolated) = 2.01 W/kg

**Ch507000 3/Zoom Scan (7x7x7)/Cube 0:** Measurement grid: dx=5mm, dy=5mm, dz=5mm

Reference Value = 1.578 V/m; Power Drift = 0.14 dB

Peak SAR (extrapolated) = 4.32 W/kg

**SAR(1 g) = 1.59 W/kg; SAR(10 g) = 0.587 W/kg**

Maximum value of SAR (measured) = 2.05 W/kg

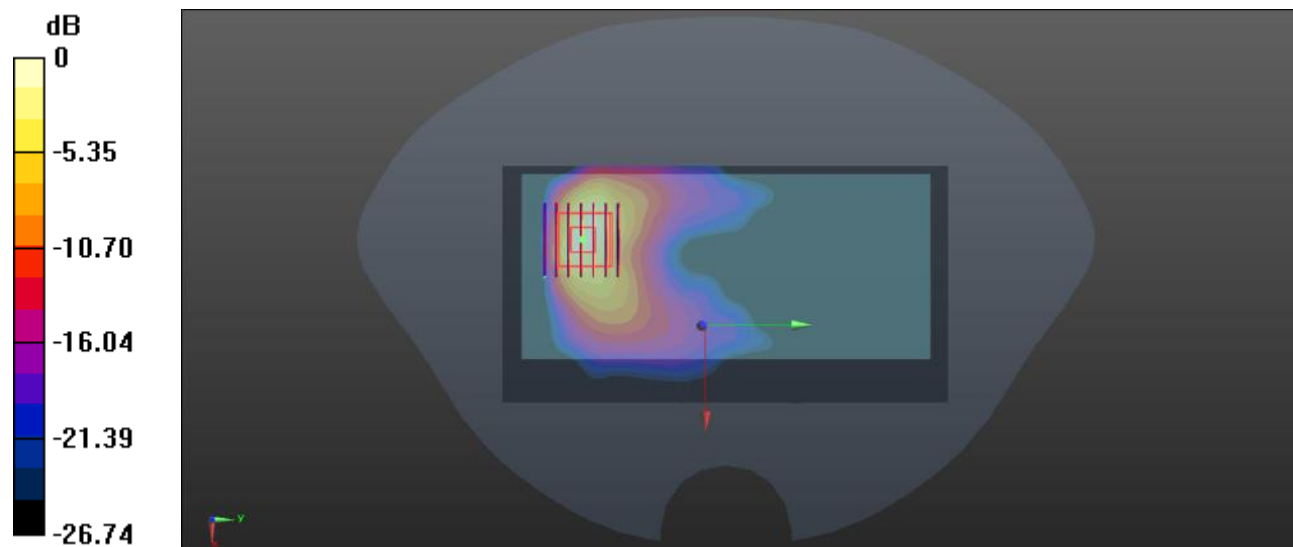

0 dB = 2.05 W/kg

**Meas.40 Right Head with Tilt on 518000 Channel in N38 mode with Antenna.4**

Date: 2022.10.12

Communication System Band: N38; Frequency: 2590 MHz; Duty Cycle: 1:1

Medium parameters used (interpolated):  $f = 2590$  MHz;  $\sigma = 1.965$  S/m;  $\epsilon_r = 38.599$ ;  $\rho = 1000$  kg/m<sup>3</sup>

Phantom section: Right Section

Ambient Temperature: 22.8°C Liquid Temperature: 21.6°C

DASY5 Configuration:

- Probe: EX3DV4 - SN7607; ConvF(7.56, 7.56, 7.56); Calibrated: 2022.07.04;
- Sensor-Surface: 4mm (Mechanical Surface Detection)
- Electronics: DAE4 Sn878; Calibrated: 2022.06.13
- Phantom: SAM1; Type: QD000P40CD; Serial: TP:1576
- Measurement SW: DASY52, Version 52.8 (8); SEMCAD X Version 14.6.10 (7331)

**Ch518000/Area Scan (81x161x1):** Interpolated grid: dx=1.200 mm, dy=1.200 mm

Maximum value of SAR (interpolated) = 0.746 W/kg

**Ch518000/Zoom Scan (7x7x7)/Cube 0:** Measurement grid: dx=5mm, dy=5mm, dz=5mm

Reference Value = 11.21 V/m; Power Drift = -0.02 dB

Peak SAR (extrapolated) = 1.48 W/kg

**SAR(1 g) = 0.612 W/kg; SAR(10 g) = 0.246 W/kg**

Maximum value of SAR (measured) = 0.738 W/kg

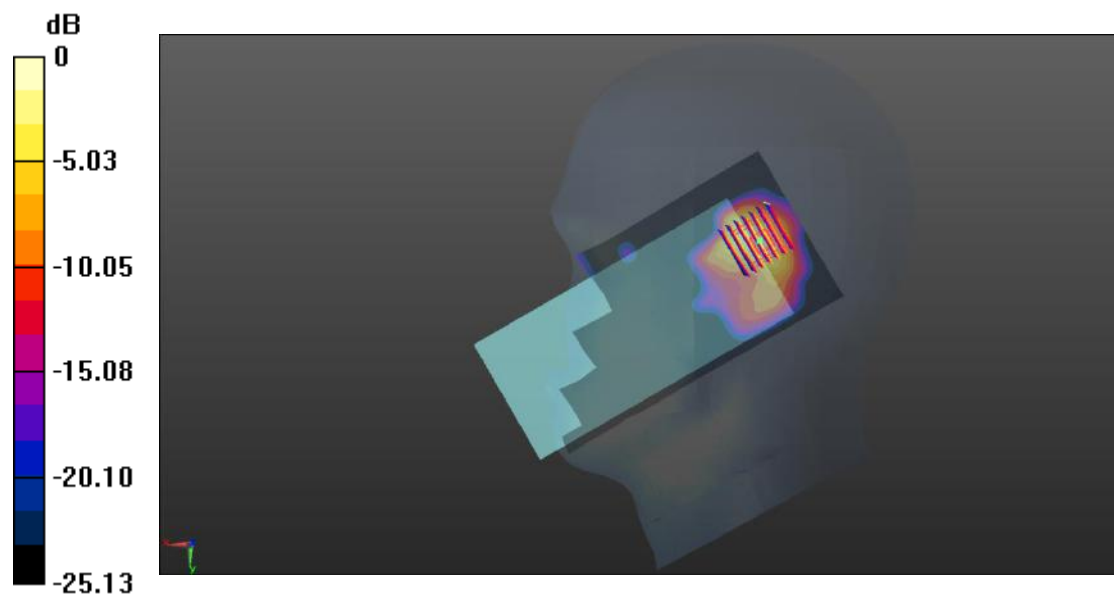

0 dB = 0.738 W/kg

**Meas.41 Body Plane with Top Edge 10mm on 519000 Channel in N38 mode with Antenna.4**

Date: 2022.10.12

Communication System Band: N38; Frequency: 2595 MHz; Duty Cycle: 1:1

Medium parameters used (interpolated):  $f = 2595$  MHz;  $\sigma = 1.977$  S/m;  $\epsilon_r = 38.492$ ;  $\rho = 1000$  kg/m<sup>3</sup>

Phantom section: Flat Section

Ambient Temperature: 22.8°C Liquid Temperature: 21.6°C

DASY5 Configuration:

- Probe: EX3DV4 - SN7607; ConvF(7.56, 7.56, 7.56); Calibrated: 2022.07.04;
- Sensor-Surface: 4mm (Mechanical Surface Detection)
- Electronics: DAE4 Sn878; Calibrated: 2022.06.13
- Phantom: SAM1; Type: QD000P40CD; Serial: TP:1576
- Measurement SW: DASY52, Version 52.8 (8); SEMCAD X Version 14.6.10 (7331)

**Ch519000/Area Scan (61x81x1):** Interpolated grid: dx=1.200 mm, dy=1.200 mm

Maximum value of SAR (interpolated) = 0.459 W/kg

**Ch519000/Zoom Scan (7x7x7)/Cube 0:** Measurement grid: dx=5mm, dy=5mm, dz=5mm

Reference Value = 10.56 V/m; Power Drift = 0.18 dB

Peak SAR (extrapolated) = 0.832 W/kg

**SAR(1 g) = 0.390 W/kg; SAR(10 g) = 0.162 W/kg**

Maximum value of SAR (measured) = 0.448 W/kg

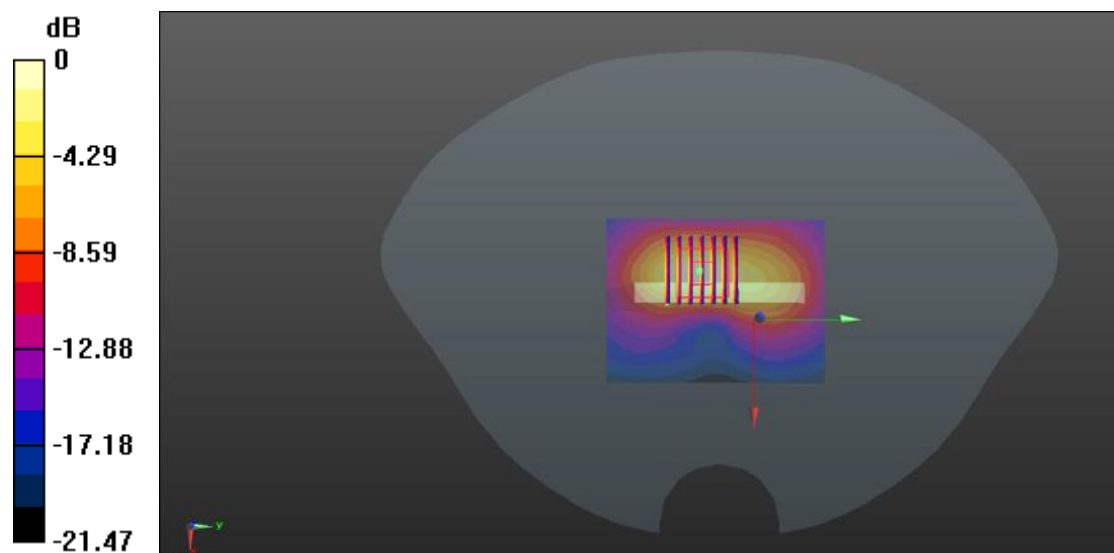

0 dB = 0.448 W/kg

**Meas.42 Right Head with Tilt on 518598 Channel in N41 mode with Antenna.4**

Date: 2022.10.14

Communication System Band: N41; Frequency: 2592.99 MHz; Duty Cycle: 1:1

Medium parameters used (interpolated):  $f = 2592.99$  MHz;  $\sigma = 1.96$  S/m;  $\epsilon_r = 38.629$ ;  $\rho = 1000$  kg/m<sup>3</sup>

Phantom section: Right Section

Ambient Temperature: 22.4°C Liquid Temperature: 21.4°C

DASY5 Configuration:

- Probe: EX3DV4 - SN7607; ConvF(7.56, 7.56, 7.56); Calibrated: 2022.07.04;
- Sensor-Surface: 4mm (Mechanical Surface Detection)
- Electronics: DAE4 Sn878; Calibrated: 2022.06.13
- Phantom: SAM1; Type: QD000P40CD; Serial: TP:1576
- Measurement SW: DASY52, Version 52.8 (8); SEMCAD X Version 14.6.10 (7331)

**Ch518198/Area Scan (81x161x1):** Interpolated grid: dx=1.200 mm, dy=1.200 mm

Maximum value of SAR (interpolated) = 0.810 W/kg

**Ch518198/Zoom Scan (7x7x7)/Cube 0:** Measurement grid: dx=5mm, dy=5mm, dz=5mm

Reference Value = 11.31 V/m; Power Drift = -0.02 dB

Peak SAR (extrapolated) = 1.56 W/kg

**SAR(1 g) = 0.653 W/kg; SAR(10 g) = 0.263 W/kg**

Maximum value of SAR (measured) = 0.786 W/kg

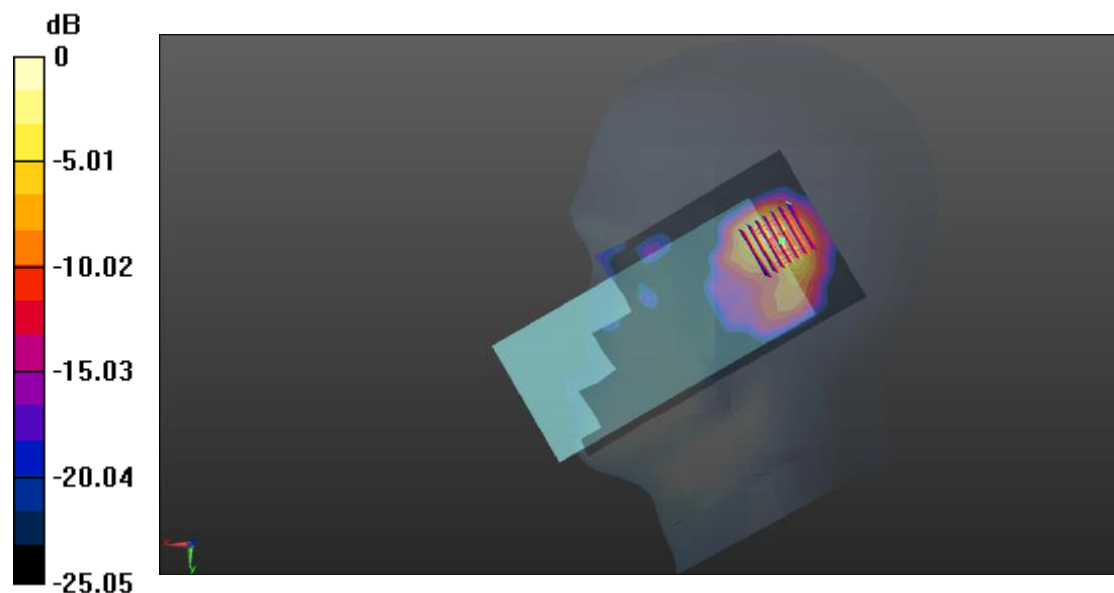

0 dB = 0.786 W/kg

**Meas.43 Body Plane with Top Edge 10mm on 518598 Channel in N41 mode with Antenna.4**

Date: 2022.10.14

Communication System Band: N41; Frequency: 2592.99 MHz; Duty Cycle: 1:1

Medium parameters used (interpolated):  $f = 2592.99$  MHz;  $\sigma = 1.96$  S/m;  $\epsilon_r = 38.629$ ;  $\rho = 1000$  kg/m<sup>3</sup>

Phantom section: Flat Section

Ambient Temperature: 22.4°C Liquid Temperature: 21.4°C

DASY5 Configuration:

- Probe: EX3DV4 - SN7607; ConvF(7.56, 7.56, 7.56); Calibrated: 2022.07.04;
- Sensor-Surface: 4mm (Mechanical Surface Detection)
- Electronics: DAE4 Sn878; Calibrated: 2022.06.13
- Phantom: SAM1; Type: QD000P40CD; Serial: TP:1576
- Measurement SW: DASY52, Version 52.8 (8); SEMCAD X Version 14.6.10 (7331)

**Ch518598/Area Scan (61x81x1):** Interpolated grid: dx=1.200 mm, dy=1.200 mm

Maximum value of SAR (interpolated) = 0.429 W/kg

**Ch518598/Zoom Scan (7x7x7)/Cube 0:** Measurement grid: dx=5mm, dy=5mm, dz=5mm

Reference Value = 10.43 V/m; Power Drift = -0.09 dB

Peak SAR (extrapolated) = 0.805 W/kg

**SAR(1 g) = 0.377 W/kg; SAR(10 g) = 0.165 W/kg**

Maximum value of SAR (measured) = 0.442 W/kg

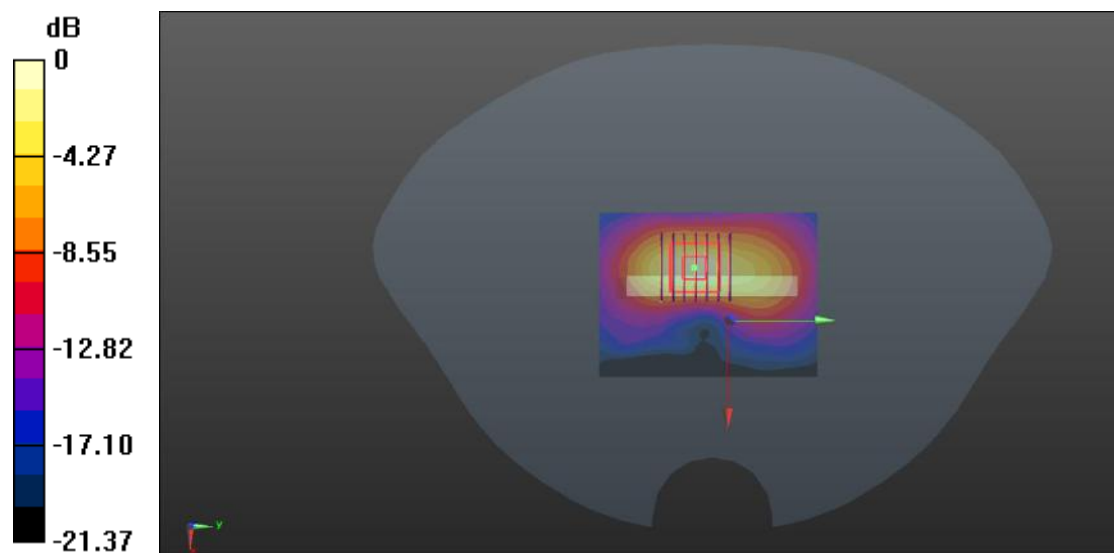

0 dB = 0.442 W/kg

**Meas.44 Right Head with Cheek on 633334 Channel in N77 mode with Antenna.2**

Date: 2022.10.15

Communication System Band: N77; Frequency: 3500.01 MHz; Duty Cycle: 1:1

Medium parameters used (interpolated):  $f = 3500.01$  MHz;  $\sigma = 2.899$  S/m;  $\epsilon_r = 38.221$ ;  $\rho = 1000$  kg/m<sup>3</sup>

Phantom section: Right Section

Ambient Temperature: 22.3°C Liquid Temperature: 21.2°C

DASY5 Configuration:

- Probe: EX3DV4 - SN7607; ConvF(6.9, 6.9, 6.9); Calibrated: 2022.07.04;
- Sensor-Surface: 4mm (Mechanical Surface Detection)
- Electronics: DAE4 Sn878; Calibrated: 2022.06.13
- Phantom: SAM1; Type: QD000P40CD; Serial: TP:1576
- Measurement SW: DASY52, Version 52.8 (8); SEMCAD X Version 14.6.10 (7331)

**Ch633334/Area Scan (81x161x1):** Interpolated grid: dx=1.200 mm, dy=1.200 mm

Maximum value of SAR (interpolated) = 0.969 W/kg

**Ch633334/Zoom Scan (5x5x7)/Cube 0:** Measurement grid: dx=6mm, dy=6mm, dz=4mm

Reference Value = 6.345 V/m; Power Drift = -0.12 dB

Peak SAR (extrapolated) = 2.31 W/kg

**SAR(1 g) = 0.764 W/kg; SAR(10 g) = 0.264 W/kg**

Maximum value of SAR (measured) = 0.930 W/kg

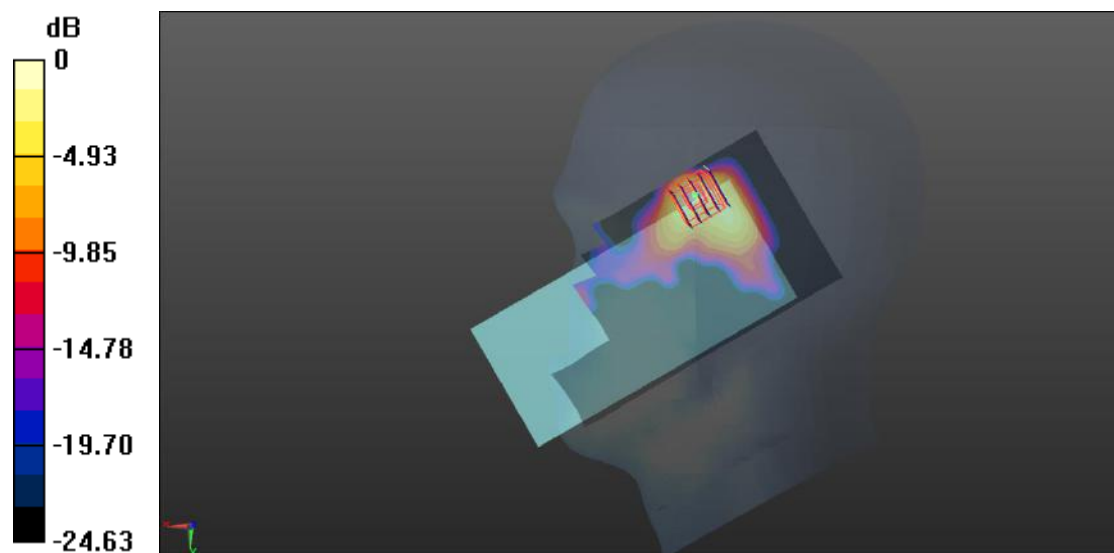

0 dB = 0.930 W/kg

**Meas.45 Body Plane with Back Side 10mm on 633334 Channel in N77 mode with Antenna.3**

Date: 2022.10.15

Communication System Band: N77; Frequency: 3500.01 MHz; Duty Cycle: 1:1

Medium parameters used (interpolated):  $f = 3500.01$  MHz;  $\sigma = 2.899$  S/m;  $\epsilon_r = 38.221$ ;  $\rho = 1000$  kg/m<sup>3</sup>

Phantom section: Flat Section

Ambient Temperature: 22.3°C Liquid Temperature: 21.2°C

DASY5 Configuration:

- Probe: EX3DV4 - SN7607; ConvF(6.9, 6.9, 6.9); Calibrated: 2022.07.04;
- Sensor-Surface: 4mm (Mechanical Surface Detection)
- Electronics: DAE4 Sn878; Calibrated: 2022.06.13
- Phantom: SAM1; Type: QD000P40CD; Serial: TP:1576
- Measurement SW: DASY52, Version 52.8 (8); SEMCAD X Version 14.6.10 (7331)

**Ch633334/Area Scan (81x151x1):** Interpolated grid: dx=1.200 mm, dy=1.200 mm

Maximum value of SAR (interpolated) = 0.550 W/kg

**Ch633334/Zoom Scan (5x5x7)/Cube 0:** Measurement grid: dx=6mm, dy=6mm, dz=4mm

Reference Value = 4.160 V/m; Power Drift = 0.12 dB

Peak SAR (extrapolated) = 1.20 W/kg

**SAR(1 g) = 0.497 W/kg; SAR(10 g) = 0.217 W/kg**

Maximum value of SAR (measured) = 0.563 W/kg

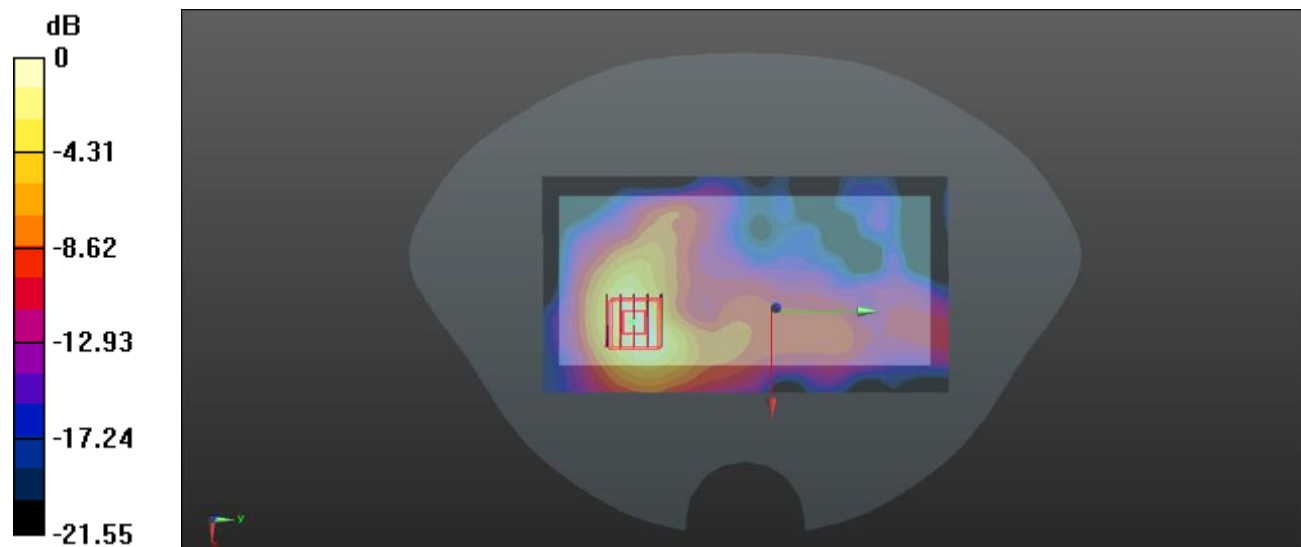

0 dB = 0.563 W/kg

**Meas.46 Body Plane with Back Side 0mm on 633334 Channel in N77 mode with Antenna2-135-DSI2**

Date: 2022.10.15

Communication System Band: N77; Frequency: 3500.01 MHz; Duty Cycle: 1:1

Medium parameters used (interpolated):  $f = 3500.01$  MHz;  $\sigma = 2.899$  S/m;  $\epsilon_r = 38.221$ ;  $\rho = 1000$  kg/m<sup>3</sup>

Phantom section: Flat Section

Ambient Temperature: 22.3°C Liquid Temperature: 21.2°C

DASY5 Configuration:

- Probe: EX3DV4 - SN7607; ConvF(6.9, 6.9, 6.9); Calibrated: 2022.07.04;
- Sensor-Surface: 4mm (Mechanical Surface Detection)
- Electronics: DAE4 Sn878; Calibrated: 2022.06.13
- Phantom: SAM1; Type: QD000P40CD; Serial: TP:1576
- Measurement SW: DASY52, Version 52.8 (8); SEMCAD X Version 14.6.10 (7331)

**Ch633334/Area Scan (81x151x1):** Interpolated grid: dx=1.200 mm, dy=1.200 mm

Maximum value of SAR (interpolated) = 6.26 W/kg

**Ch633334/Zoom Scan (5x5x7)/Cube 0:** Measurement grid: dx=6mm, dy=6mm, dz=4mm

Reference Value = 0.5910 V/m; Power Drift = 0.09 dB

Peak SAR (extrapolated) = 28.2 W/kg

**SAR(1 g) = 6.59 W/kg; SAR(10 g) = 1.63 W/kg**

Maximum value of SAR (measured) = 9.12 W/kg

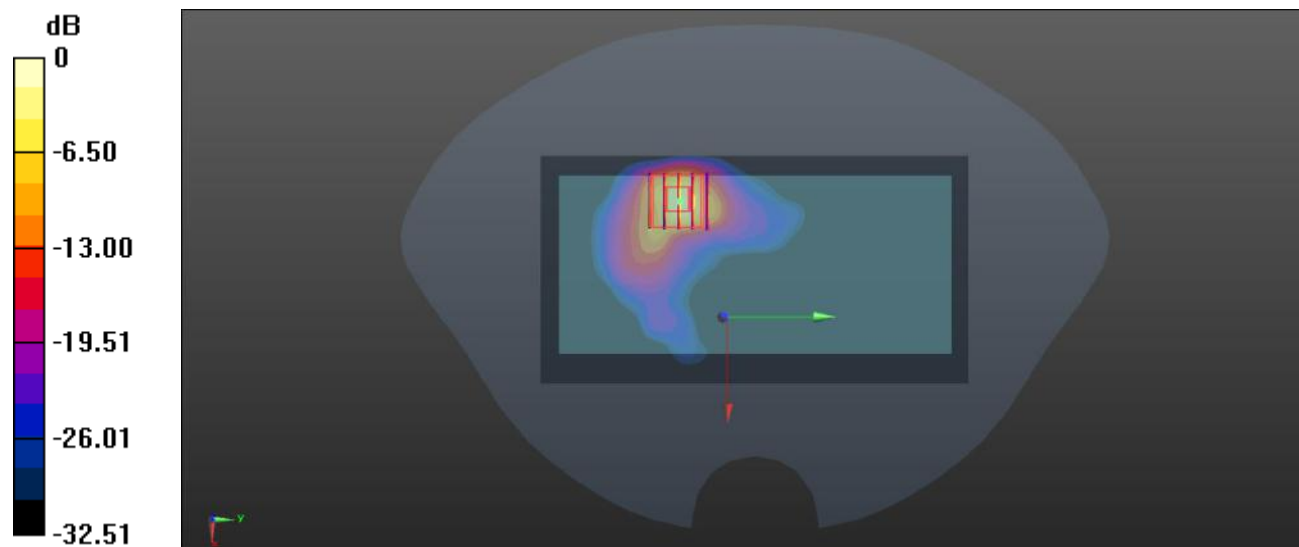

0 dB = 9.12 W/kg



**Meas.47 Right Head with Cheek on 656000 Channel in N77 mode with Antenna.2**

Date: 2022.10.15

Communication System Band: N77; Frequency: 3840 MHz; Duty Cycle: 1:1

Medium parameters used (interpolated):  $f = 3840$  MHz;  $\sigma = 3.312$  S/m;  $\epsilon_r = 37.441$ ;  $\rho = 1000$  kg/m<sup>3</sup>

Phantom section: Right Section

Ambient Temperature: 22.3°C Liquid Temperature: 21.2°C

DASY5 Configuration:

- Probe: EX3DV4 - SN7607; ConvF(6.4, 6.4, 6.4); Calibrated: 2022.07.04;
- Sensor-Surface: 4mm (Mechanical Surface Detection)
- Electronics: DAE4 Sn878; Calibrated: 2022.06.13
- Phantom: SAM1; Type: QD000P40CD; Serial: TP:1576
- Measurement SW: DASY52, Version 52.8 (8); SEMCAD X Version 14.6.10 (7331)

**Ch656000/Area Scan (81x161x1):** Interpolated grid: dx=1.200 mm, dy=1.200 mm

Maximum value of SAR (interpolated) = 0.842 W/kg

**Ch656000/Zoom Scan (5x5x7)/Cube 0:** Measurement grid: dx=6mm, dy=6mm, dz=4mm

Reference Value = 7.216 V/m; Power Drift = -0.15 dB

Peak SAR (extrapolated) = 2.26 W/kg

**SAR(1 g) = 0.771 W/kg; SAR(10 g) = 0.267 W/kg**

Maximum value of SAR (measured) = 0.895 W/kg

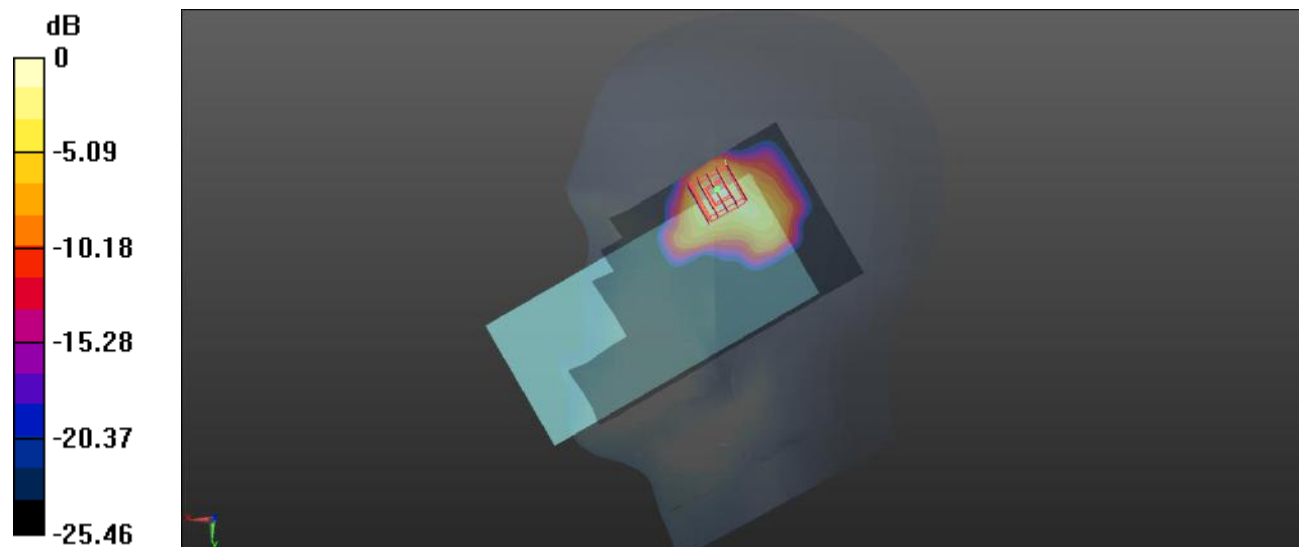

0 dB = 0.895 W/kg

**Meas.48 Body Plane with Top Edge 10mm on 662000 Channel in N77 mode with Antenna.3**

Date: 2022.10.15

Communication System Band: N77; Frequency: 3930 MHz; Duty Cycle: 1:1

Medium parameters used (interpolated):  $f = 3930$  MHz;  $\sigma = 3.421$  S/m;  $\epsilon_r = 37.101$ ;  $\rho = 1000$  kg/m<sup>3</sup>

Phantom section: Flat Section

Ambient Temperature: 22.3°C Liquid Temperature: 21.2°C

DASY5 Configuration:

- Probe: EX3DV4 - SN7607; ConvF(6.4, 6.4, 6.4); Calibrated: 2022.07.04;
- Sensor-Surface: 4mm (Mechanical Surface Detection)
- Electronics: DAE4 Sn878; Calibrated: 2022.06.13
- Phantom: SAM1; Type: QD000P40CD; Serial: TP:1576
- Measurement SW: DASY52, Version 52.8 (8); SEMCAD X Version 14.6.10 (7331)

**Ch662000/Area Scan (61x81x1):** Interpolated grid: dx=1.200 mm, dy=1.200 mm

Maximum value of SAR (interpolated) = 1.00 W/kg

**Ch662000/Zoom Scan (5x5x7)/Cube 0:** Measurement grid: dx=6mm, dy=6mm, dz=4mm

Reference Value = 6.386 V/m; Power Drift = -0.1 dB

Peak SAR (extrapolated) = 2.10 W/kg

**SAR(1 g) = 0.871 W/kg; SAR(10 g) = 0.366 W/kg**

Maximum value of SAR (measured) = 0.964 W/kg

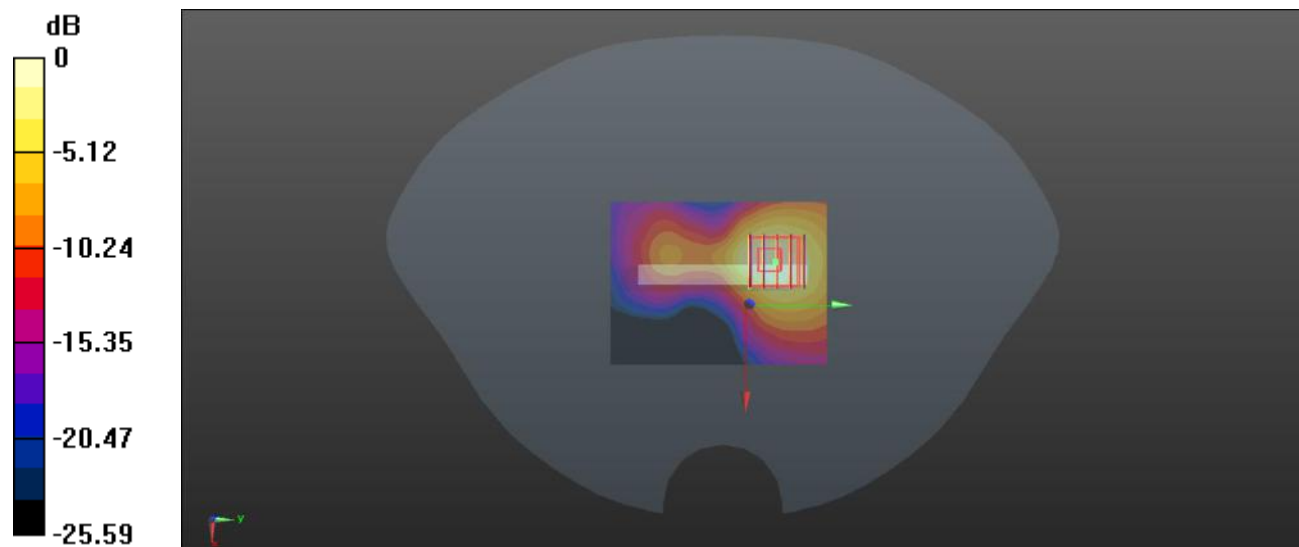

0 dB = 0.964 W/kg

**Meas.49 Body Plane with Left Edge 0mm on 656000 Channel in N77 mode with Antenna 2-DSI4-1RB**

Date: 2022.10.15

Communication System Band: N77; Frequency: 3840 MHz; Duty Cycle: 1:1

Medium parameters used (interpolated):  $f = 3840$  MHz;  $\sigma = 3.312$  S/m;  $\epsilon_r = 37.441$ ;  $\rho = 1000$  kg/m<sup>3</sup>

Phantom section: Flat Section

Ambient Temperature: 22.3°C Liquid Temperature: 21.2°C

DASY5 Configuration:

- Probe: EX3DV4 - SN7607; ConvF(6.4, 6.4, 6.4); Calibrated: 2022.07.04;
- Sensor-Surface: 4mm (Mechanical Surface Detection)
- Electronics: DAE4 Sn878; Calibrated: 2022.06.13
- Phantom: SAM1; Type: QD000P40CD; Serial: TP:1576
- Measurement SW: DASY52, Version 52.8 (8); SEMCAD X Version 14.6.10 (7331)

**Ch656000/Area Scan (61x161x1):** Interpolated grid: dx=1.200 mm, dy=1.200 mm

Maximum value of SAR (interpolated) = 4.12 W/kg

**Ch656000/Zoom Scan (5x5x7)/Cube 0:** Measurement grid: dx=6mm, dy=6mm, dz=4mm

Reference Value = 1.909 V/m; Power Drift = -0.03 dB

Peak SAR (extrapolated) = 17.3 W/kg

**SAR(1 g) = 4.39 W/kg; SAR(10 g) = 1.1 W/kg**

Maximum value of SAR (measured) = 5.72 W/kg

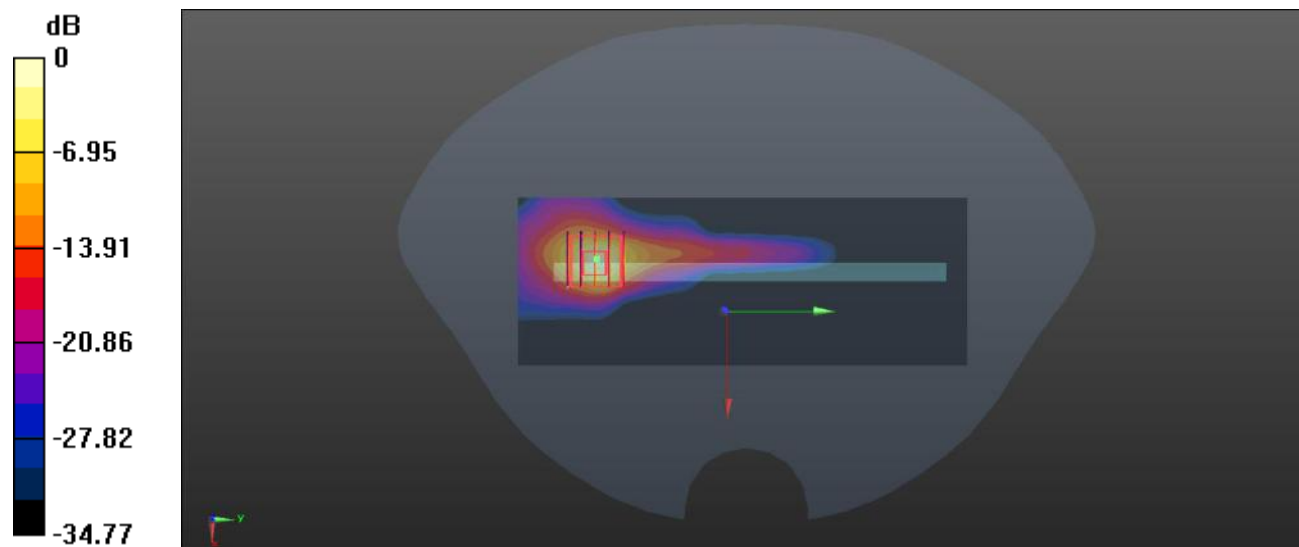

0 dB = 5.72 W/kg

**Meas.50 Left Head with Tilt on 633334 Channel in N78 mode with Antenna.3**

Date: 2022.10.20

Communication System Band: N78; Frequency: 3500.01 MHz; Duty Cycle: 1:1

Medium parameters used (interpolated):  $f = 3500.01$  MHz;  $\sigma = 2.923$  S/m;  $\epsilon_r = 37.856$ ;  $\rho = 1000$  kg/m<sup>3</sup>

Phantom section: Left Section

Ambient Temperature: 22.7°C Liquid Temperature: 21.4°C

DASY5 Configuration:

- Probe: EX3DV4 - SN7607; ConvF(6.9, 6.9, 6.9); Calibrated: 2022.07.04;
- Sensor-Surface: 4mm (Mechanical Surface Detection)
- Electronics: DAE4 Sn878; Calibrated: 2022.06.13
- Phantom: SAM1; Type: QD000P40CD; Serial: TP:1576
- Measurement SW: DASY52, Version 52.8 (8); SEMCAD X Version 14.6.10 (7331)

**Ch633334/Area Scan (81x161x1):** Interpolated grid: dx=1.200 mm, dy=1.200 mm

Maximum value of SAR (interpolated) = 0.887 W/kg

**Ch633334/Zoom Scan (5x5x7)/Cube 0:** Measurement grid: dx=6mm, dy=6mm, dz=4mm

Reference Value = 5.942 V/m; Power Drift = -0.11 dB

Peak SAR (extrapolated) = 1.66 W/kg

**SAR(1 g) = 0.581 W/kg; SAR(10 g) = 0.205 W/kg**

Maximum value of SAR (measured) = 0.698 W/kg

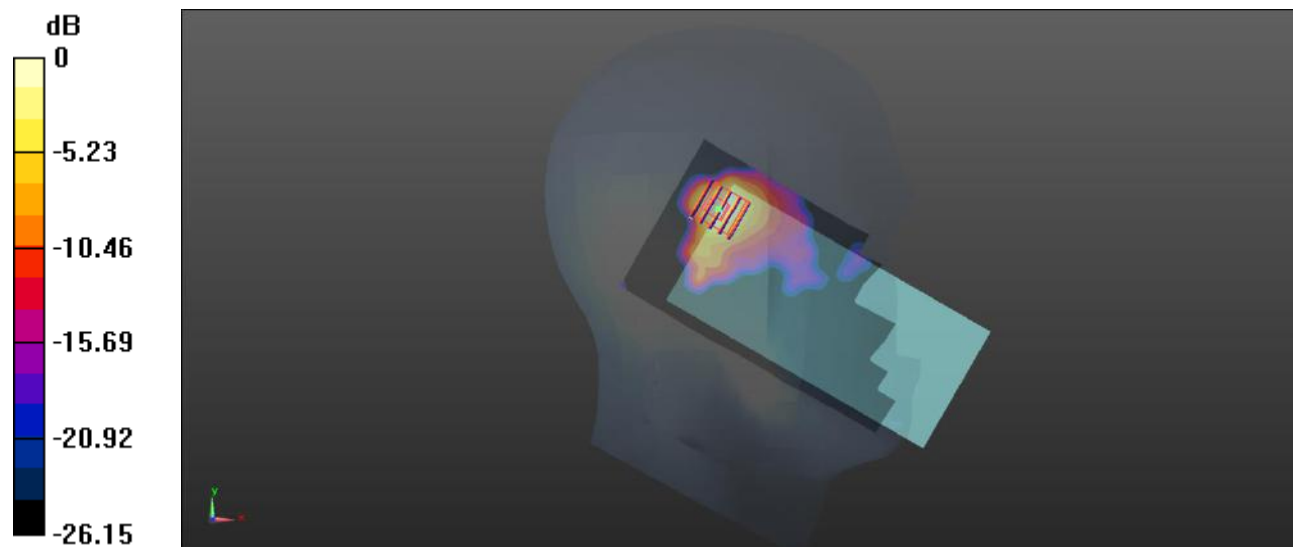

0 dB = 0.698 W/kg

**Meas.51 Body Plane with Back Side 10mm on 633334 Channel in N78 mode with Antenna.3**

Date: 2022.10.20

Communication System Band: N78; Frequency: 3500.01 MHz; Duty Cycle: 1:1

Medium parameters used (interpolated):  $f = 3500.01$  MHz;  $\sigma = 2.923$  S/m;  $\epsilon_r = 37.856$ ;  $\rho = 1000$  kg/m<sup>3</sup>

Phantom section: Flat Section

Ambient Temperature: 22.7°C Liquid Temperature: 21.4°C

DASY5 Configuration:

- Probe: EX3DV4 - SN7607; ConvF(6.9, 6.9, 6.9); Calibrated: 2022.07.04;
- Sensor-Surface: 4mm (Mechanical Surface Detection)
- Electronics: DAE4 Sn878; Calibrated: 2022.06.13
- Phantom: SAM1; Type: QD000P40CD; Serial: TP:1576
- Measurement SW: DASY52, Version 52.8 (8); SEMCAD X Version 14.6.10 (7331)

**Ch633334/Area Scan (81x161x1):** Interpolated grid: dx=1.200 mm, dy=1.200 mm

Maximum value of SAR (interpolated) = 0.587 W/kg

**Ch633334/Zoom Scan (5x5x7)/Cube 0:** Measurement grid: dx=6mm, dy=6mm, dz=4mm

Reference Value = 3.985 V/m; Power Drift = 0.06 dB

Peak SAR (extrapolated) = 1.31 W/kg

**SAR(1 g) = 0.533 W/kg; SAR(10 g) = 0.228 W/kg**

Maximum value of SAR (measured) = 0.579 W/kg

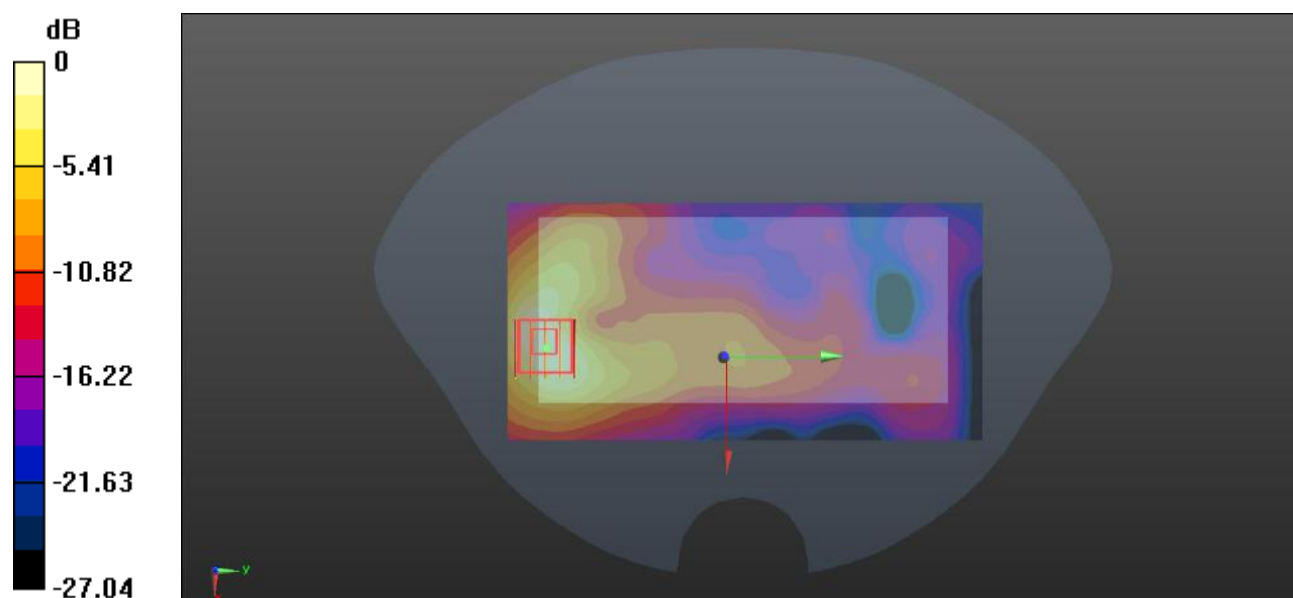

0 dB = 0.579 W/kg

**Meas.52 Body Plane with Back Side 0mm on 633334 Channel in N78 mode with Antenna.2**

Date: 2022.10.20

Communication System Band: N78; Frequency: 3500.01 MHz; Duty Cycle: 1:1

Medium parameters used (interpolated):  $f = 3500.01$  MHz;  $\sigma = 2.923$  S/m;  $\epsilon_r = 37.856$ ;  $\rho = 1000$  kg/m<sup>3</sup>

Phantom section: Flat Section

Ambient Temperature: 22.7°C Liquid Temperature: 21.4°C

DASY5 Configuration:

- Probe: EX3DV4 - SN7607; ConvF(6.9, 6.9, 6.9); Calibrated: 2022.07.04;
- Sensor-Surface: 4mm (Mechanical Surface Detection)
- Electronics: DAE4 Sn878; Calibrated: 2022.06.13
- Phantom: SAM1; Type: QD000P40CD; Serial: TP:1576
- Measurement SW: DASY52, Version 52.8 (8); SEMCAD X Version 14.6.10 (7331)

**Ch633334/Area Scan (81x161x1):** Interpolated grid: dx=1.200 mm, dy=1.200 mm

Maximum value of SAR (interpolated) = 8.05 W/kg

**Ch633334/Zoom Scan (5x5x7)/Cube 0:** Measurement grid: dx=6mm, dy=6mm, dz=4mm

Reference Value = 0 V/m; Power Drift = 0.15 dB

Peak SAR (extrapolated) = 30.8 W/kg

**SAR(1 g) = 7.44 W/kg; SAR(10 g) = 1.85 W/kg**

Maximum value of SAR (measured) = 9.35 W/kg

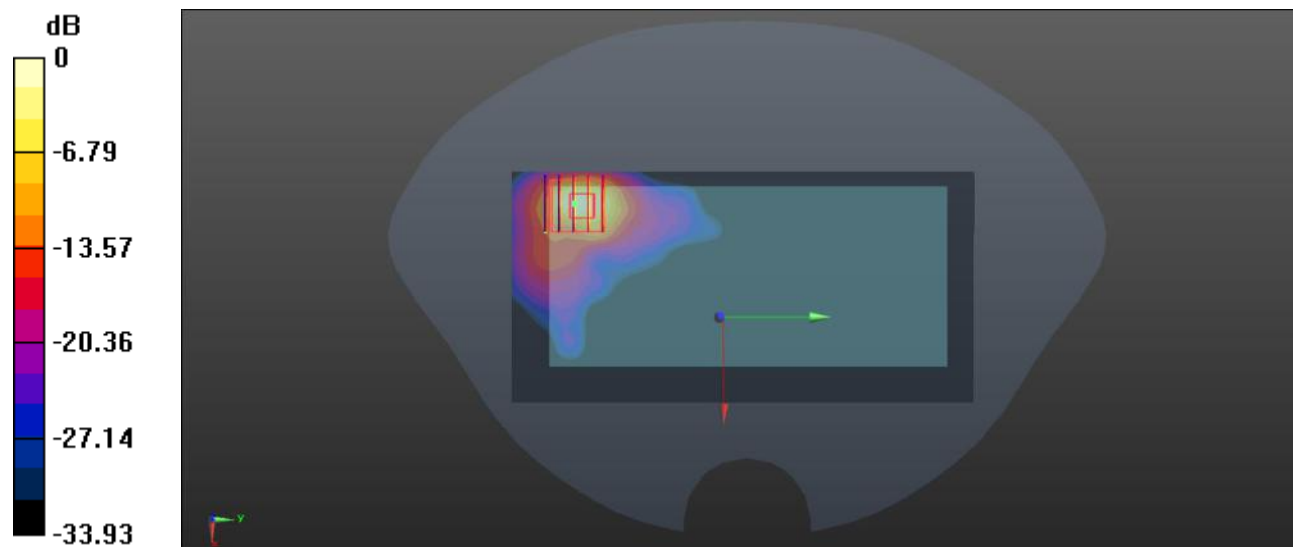

0 dB = 9.35 W/kg

**Meas.53 Right Head with Cheek on 650000 Channel in N78 mode with Antenna.2**

Date: 2022.10.20

Communication System Band: N78; Frequency: 3750 MHz; Duty Cycle: 1:1

Medium parameters used (interpolated):  $f = 3750$  MHz;  $\sigma = 3.191$  S/m;  $\epsilon_r = 37.372$ ;  $\rho = 1000$  kg/m<sup>3</sup>

Phantom section: Right Section

Ambient Temperature: 22.7°C Liquid Temperature: 21.4°C

DASY5 Configuration:

- Probe: EX3DV4 - SN7607; ConvF(6.74, 6.74, 6.74); Calibrated: 2022.07.04;
- Sensor-Surface: 4mm (Mechanical Surface Detection)
- Electronics: DAE4 Sn878; Calibrated: 2022.06.13
- Phantom: SAM1; Type: QD000P40CD; Serial: TP:1576
- Measurement SW: DASY52, Version 52.8 (8); SEMCAD X Version 14.6.10 (7331)

**Ch650000/Area Scan (81x161x1):** Interpolated grid: dx=1.200 mm, dy=1.200 mm

Maximum value of SAR (interpolated) = 0.913 W/kg

**Ch650000/Zoom Scan (5x5x7)/Cube 0:** Measurement grid: dx=6mm, dy=6mm, dz=4mm

Reference Value = 6.971 V/m; Power Drift = 0.08 dB

Peak SAR (extrapolated) = 2.25 W/kg

**SAR(1 g) = 0.753 W/kg; SAR(10 g) = 0.265 W/kg**

Maximum value of SAR (measured) = 0.970 W/kg

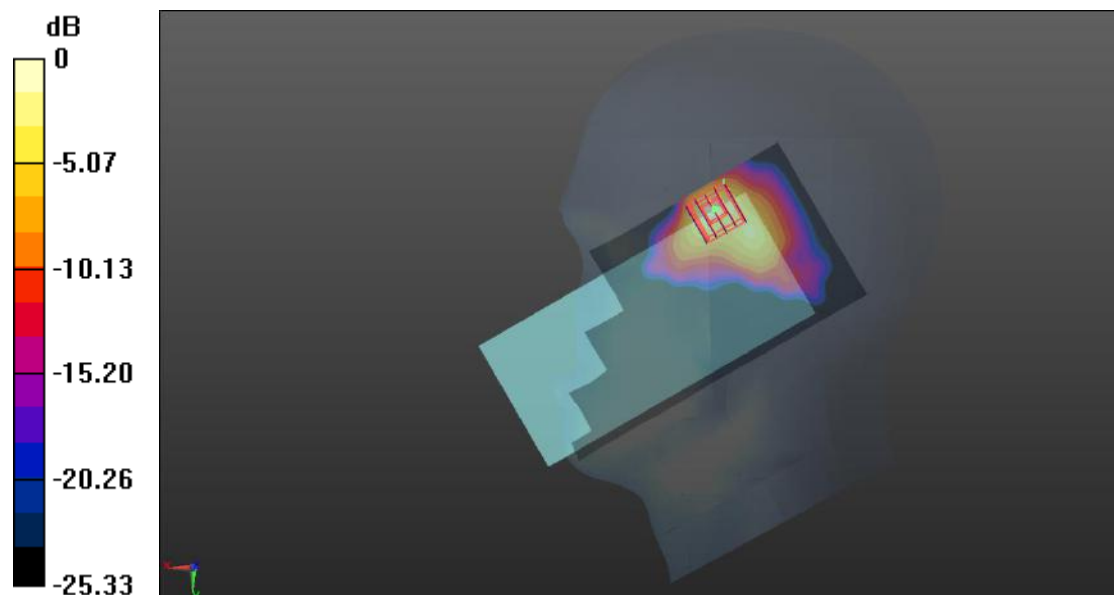

0 dB = 0.970 W/kg

**Meas.54 Body Plane with Right Edge 10mm on 650000 Channel in N78 mode with Antenna .3**

Date: 2022.10.20

Communication System Band: N78; Frequency: 3750 MHz; Duty Cycle: 1:1

Medium parameters used (interpolated):  $f = 3750$  MHz;  $\sigma = 3.191$  S/m;  $\epsilon_r = 37.372$ ;  $\rho = 1000$  kg/m<sup>3</sup>

Phantom section: Flat Section

Ambient Temperature: 22.7°C Liquid Temperature: 21.4°C

DASY5 Configuration:

- Probe: EX3DV4 - SN7607; ConvF(6.74, 6.74, 6.74); Calibrated: 2022.07.04;
- Sensor-Surface: 4mm (Mechanical Surface Detection)
- Electronics: DAE4 Sn878; Calibrated: 2022.06.13
- Phantom: SAM1; Type: QD000P40CD; Serial: TP:1576
- Measurement SW: DASY52, Version 52.8 (8); SEMCAD X Version 14.6.10 (7331)

**Ch650000/Area Scan (61x161x1):** Interpolated grid: dx=1.200 mm, dy=1.200 mm

Maximum value of SAR (interpolated) = 0.941 W/kg

**Ch650000/Zoom Scan (5x5x7)/Cube 0:** Measurement grid: dx=6mm, dy=6mm, dz=4mm

Reference Value = 6.240 V/m; Power Drift = 0.04 dB

Peak SAR (extrapolated) = 2.11 W/kg

**SAR(1 g) = 0.832 W/kg; SAR(10 g) = 0.323 W/kg**

Maximum value of SAR (measured) = 0.985 W/kg

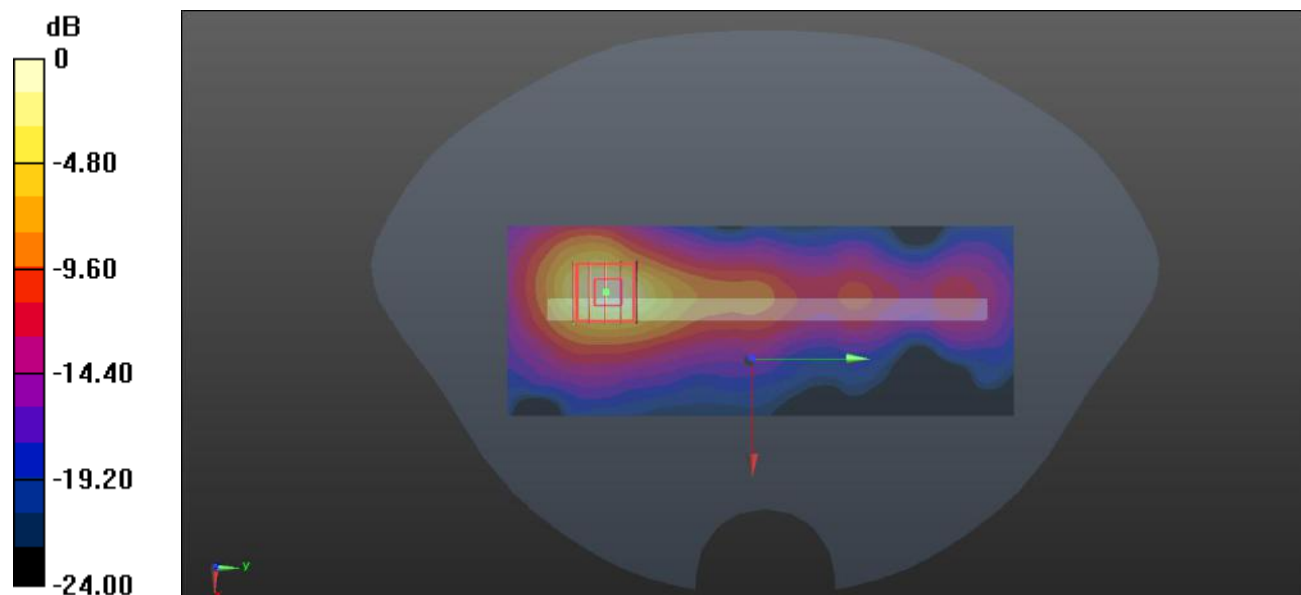

0 dB = 0.985 W/kg



**Meas.55 Body Plane with Back Side 0mm on 650000 Channel in N78 mode with Antenna 2**

Date: 2022.10.20

Communication System Band: N78; Frequency: 3750 MHz; Duty Cycle: 1:1

Medium parameters used (interpolated):  $f = 3750$  MHz;  $\sigma = 3.191$  S/m;  $\epsilon_r = 37.372$ ;  $\rho = 1000$  kg/m<sup>3</sup>

Phantom section: Flat Section

Ambient Temperature: 22.7°C Liquid Temperature: 21.4°C

DASY5 Configuration:

- Probe: EX3DV4 - SN7607; ConvF(6.74, 6.74, 6.74); Calibrated: 2022.07.04;
- Sensor-Surface: 4mm (Mechanical Surface Detection)
- Electronics: DAE4 Sn878; Calibrated: 2022.06.13
- Phantom: SAM1; Type: QD000P40CD; Serial: TP:1576
- Measurement SW: DASY52, Version 52.8 (8); SEMCAD X Version 14.6.10 (7331)

**Ch650000/Area Scan (71x161x1):** Interpolated grid: dx=1.200 mm, dy=1.200 mm

Maximum value of SAR (interpolated) = 11.9 W/kg

**Ch650000/Zoom Scan (5x5x7)/Cube 0:** Measurement grid: dx=6mm, dy=6mm, dz=4mm

Reference Value = 13.17 V/m; Power Drift = -0.11 dB

Peak SAR (extrapolated) = 36.9 W/kg

**SAR(1 g) = 8.48 W/kg; SAR(10 g) = 2.14 W/kg**

Maximum value of SAR (measured) = 11.6 W/kg

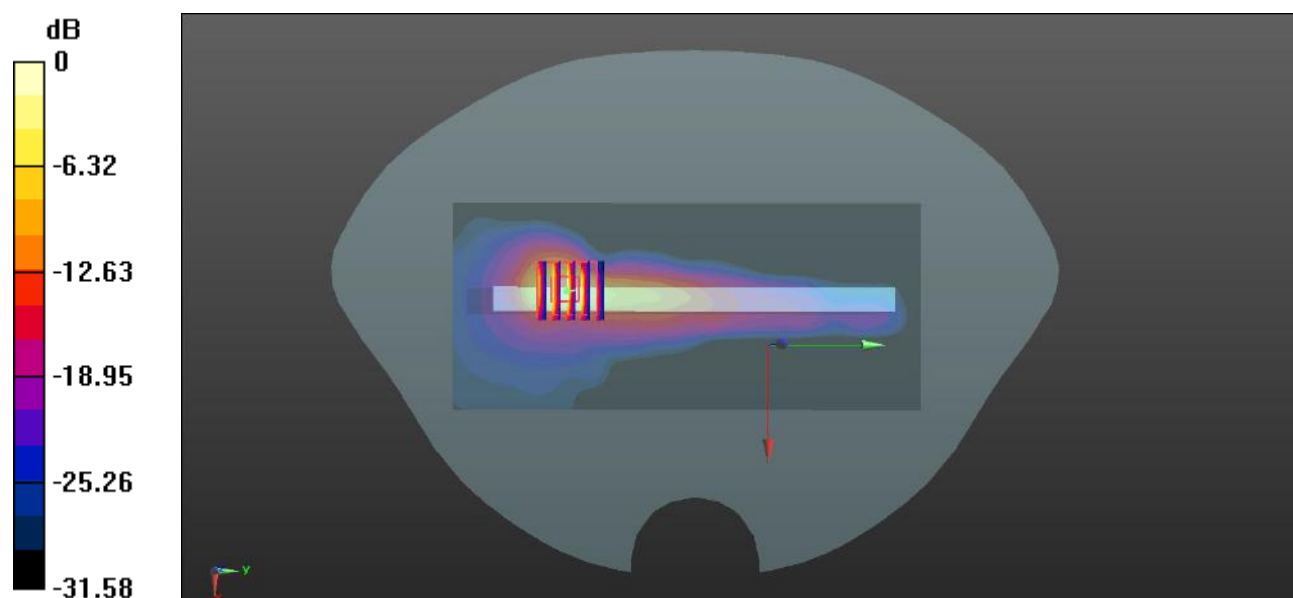

0 dB = 11.6 W/kg

**Meas.56 Left Head with Cheek on 11 Channel in IEEE802.11b mode with Antenna.7**

Date: 2022.10.08

Communication System Band: WLAN(b); Frequency: 2462 MHz; Duty Cycle: 1:1.02

Medium parameters used (interpolated):  $f = 2462$  MHz;  $\sigma = 1.833$  S/m;  $\epsilon_r = 39.418$ ;  $\rho = 1000$  kg/m<sup>3</sup>

Phantom section: Left Section

Ambient Temperature: 22.5°C Liquid Temperature: 21.1°C

DASY5 Configuration:

- Probe: EX3DV4 - SN7607; ConvF(7.79, 7.79, 7.79); Calibrated: 2022.07.04;
- Sensor-Surface: 4mm (Mechanical Surface Detection)
- Electronics: DAE4 Sn878; Calibrated: 2022.06.13
- Phantom: SAM1; Type: QD000P40CD; Serial: TP:1576
- Measurement SW: DASY52, Version 52.8 (8); SEMCAD X Version 14.6.10 (7331)

**Ch11/Area Scan (81x161x1):** Interpolated grid: dx=1.200 mm, dy=1.200 mm

Maximum value of SAR (interpolated) = 0.505 W/kg

**Ch11/Zoom Scan (7x7x7)/Cube 0:** Measurement grid: dx=5mm, dy=5mm, dz=5mm

Reference Value = 5.411 V/m; Power Drift = 0.02 dB

Peak SAR (extrapolated) = 0.793 W/kg

**SAR(1 g) = 0.45 W/kg; SAR(10 g) = 0.203 W/kg**

Maximum value of SAR (measured) = 0.453 W/kg

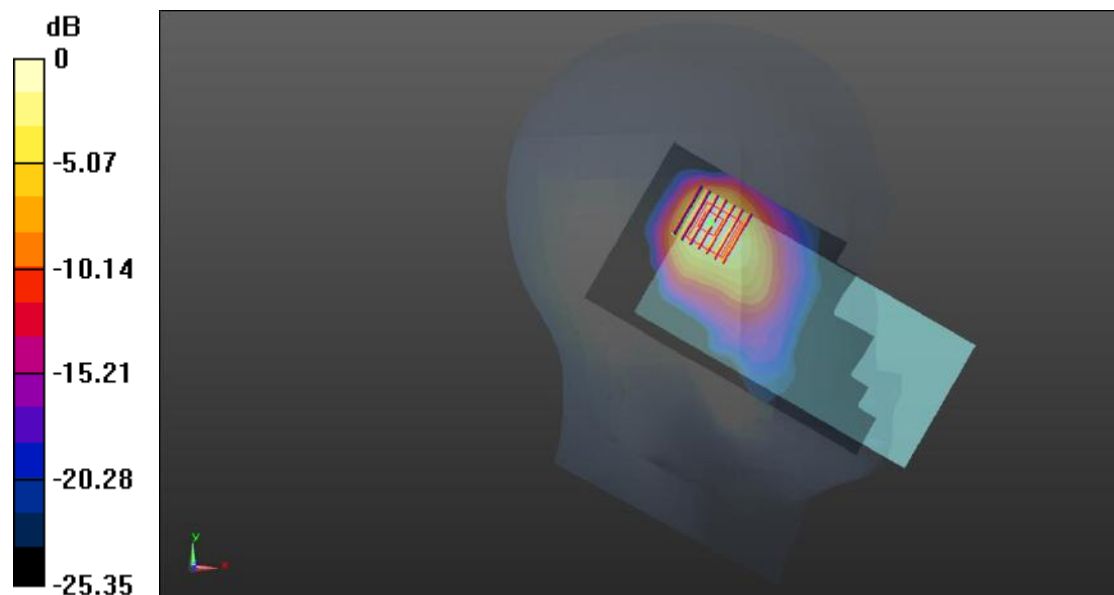

0 dB = 0.453 W/kg

**Meas.57 Body Plane with Back Side 10mm on 11 Channel in IEEE802.11b mode with Antenna.7**

Date: 2022.10.08

Communication System Band: WLAN(b); Frequency: 2462 MHz; Duty Cycle: 1:1.02

Medium parameters used (interpolated):  $f = 2462 \text{ MHz}$ ;  $\sigma = 1.833 \text{ S/m}$ ;  $\epsilon_r = 39.418$ ;  $\rho = 1000 \text{ kg/m}^3$

Phantom section: Flat Section

Ambient Temperature: 22.5°C Liquid Temperature: 21.1°C

DASY5 Configuration:

- Probe: EX3DV4 - SN7607; ConvF(7.79, 7.79, 7.79); Calibrated: 2022.07.04;
- Sensor-Surface: 4mm (Mechanical Surface Detection)
- Electronics: DAE4 Sn878; Calibrated: 2022.06.13
- Phantom: SAM1; Type: QD000P40CD; Serial: TP:1576
- Measurement SW: DASY52, Version 52.8 (8); SEMCAD X Version 14.6.10 (7331)

**Ch11/Area Scan (91x161x1):** Interpolated grid:  $dx=1.200 \text{ mm}$ ,  $dy=1.200 \text{ mm}$

Maximum value of SAR (interpolated) = 0.120 W/kg

**Ch11/Zoom Scan (7x7x7)/Cube 0:** Measurement grid:  $dx=5\text{mm}$ ,  $dy=5\text{mm}$ ,  $dz=5\text{mm}$

Reference Value = 2.407 V/m; Power Drift = 0.11 dB

Peak SAR (extrapolated) = 0.198 W/kg

**SAR(1 g) = 0.094 W/kg; SAR(10 g) = 0.045 W/kg**

Maximum value of SAR (measured) = 0.107 W/kg

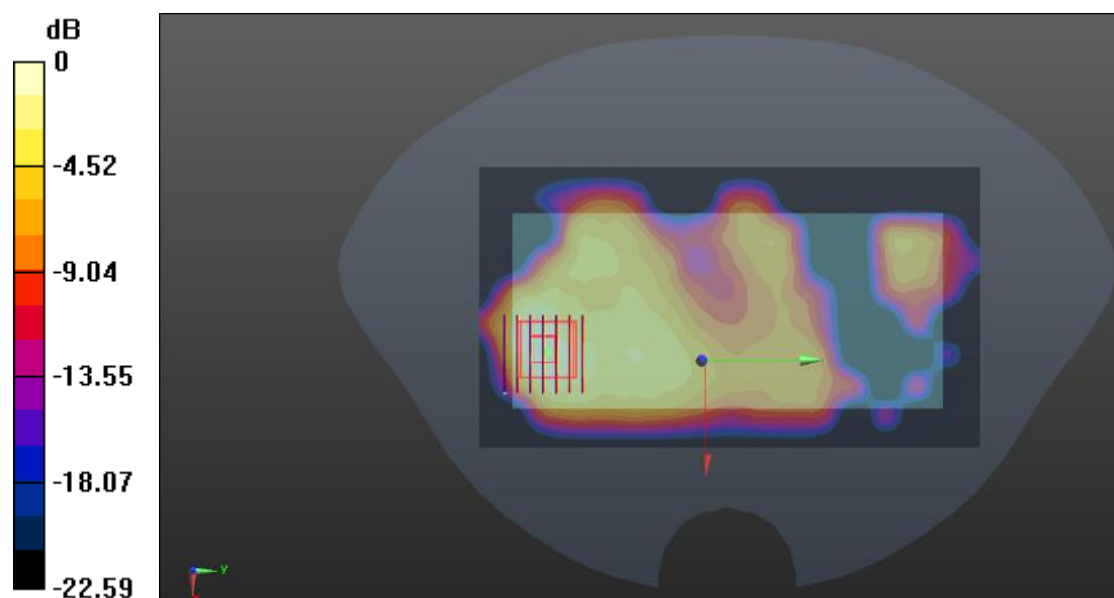

0 dB = 0.107 W/kg

**Meas.58 Left Head with Tilt on 64 Channel in IEEE802.11n20 mode with Antenna 7**

Date: 2022.10.23

Communication System Band: WLAN(n20); Frequency: 5320 MHz; Duty Cycle: 1:1.034

Medium parameters used (interpolated):  $f = 5320$  MHz;  $\sigma = 4.844$  S/m;  $\epsilon_r = 35.045$ ;  $\rho = 1000$  kg/m<sup>3</sup>

Phantom section: Left Section

Ambient Temperature: 22.6°C Liquid Temperature: 21.3°C

DASY5 Configuration:

- Probe: EX3DV4 - SN7607; ConvF(5.45, 5.45, 5.45); Calibrated: 2022.07.04;
- Sensor-Surface: 2mm (Mechanical Surface Detection)
- Electronics: DAE4 Sn878; Calibrated: 2022.06.13
- Phantom: SAM1; Type: QD000P40CD; Serial: TP:1576
- Measurement SW: DASY52, Version 52.8 (8); SEMCAD X Version 14.6.10 (7331)

**Ch64/Area Scan (101x191x1):** Interpolated grid: dx=1.000 mm, dy=1.000 mm

Maximum value of SAR (interpolated) = 1.33 W/kg

**Ch64/Zoom Scan (7x7x12)/Cube 0:** Measurement grid: dx=4mm, dy=4mm, dz=2mm

Reference Value = 4.619 V/m; Power Drift = 0.04 dB

Peak SAR (extrapolated) = 1.48 W/kg

**SAR(1 g) = 0.361 W/kg; SAR(10 g) = 0.085 W/kg**

Maximum value of SAR (measured) = 0.934 W/kg

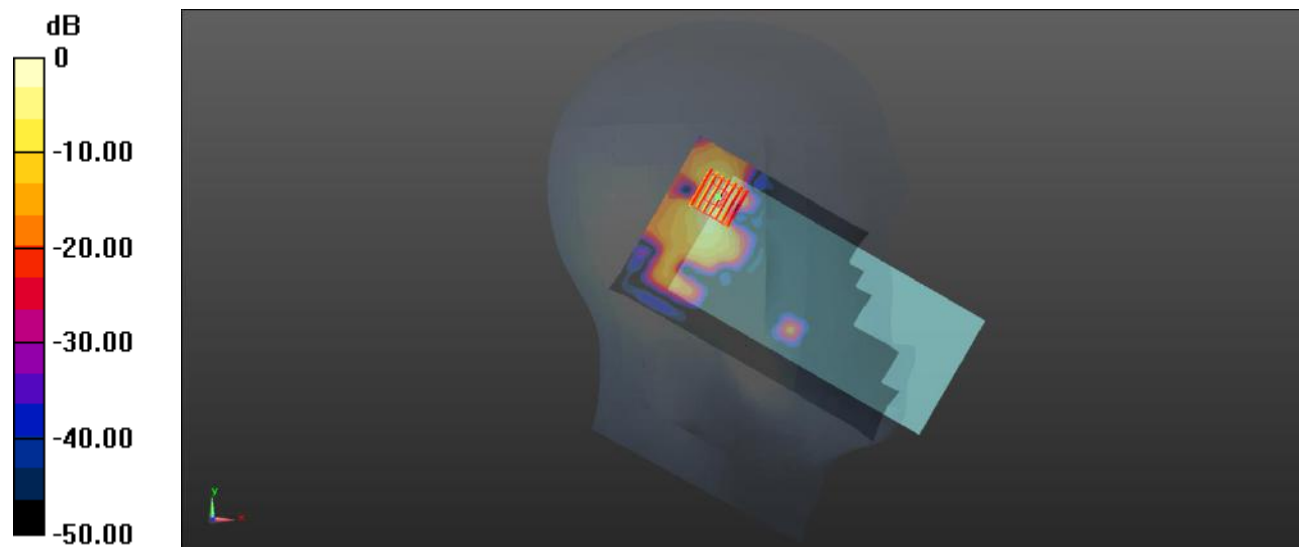

0 dB = 0.934 W/kg

**Meas.59 Left Head with Tilt on 142 Channel in IEEE802.11ac40 mode with Antenna 7**

Date: 2022.10.24

Communication System Band: WLAN(ac40); Frequency: 5710 MHz; Duty Cycle: 1:1.034

Medium parameters used (interpolated):  $f = 5710$  MHz;  $\sigma = 5.223$  S/m;  $\epsilon_r = 35.121$ ;  $\rho = 1000$  kg/m<sup>3</sup>

Phantom section: Flat Section

Ambient Temperature: 22.5°C Liquid Temperature: 21.5°C

DASY5 Configuration:

- Probe: EX3DV4 - SN7607; ConvF(5, 5, 5); Calibrated: 2022.07.04;
- Sensor-Surface: 2mm (Mechanical Surface Detection)
- Electronics: DAE4 Sn878; Calibrated: 2022.06.13
- Phantom: SAM1; Type: QD000P40CD; Serial: TP:1576
- Measurement SW: DASY52, Version 52.8 (8); SEMCAD X Version 14.6.10 (7331)

**Ch142/Area Scan (101x191x1):** Interpolated grid: dx=1.000 mm, dy=1.000 mm

Maximum value of SAR (interpolated) = 0.549 W/kg

**Ch142/Zoom Scan (7x7x12)/Cube 0:** Measurement grid: dx=4mm, dy=4mm, dz=2mm

Reference Value = 3.316 V/m; Power Drift = 0.05 dB

Peak SAR (extrapolated) = 1.99 W/kg

**SAR(1 g) = 0.218 W/kg; SAR(10 g) = 0.052 W/kg**

Maximum value of SAR (measured) = 0.492 W/kg

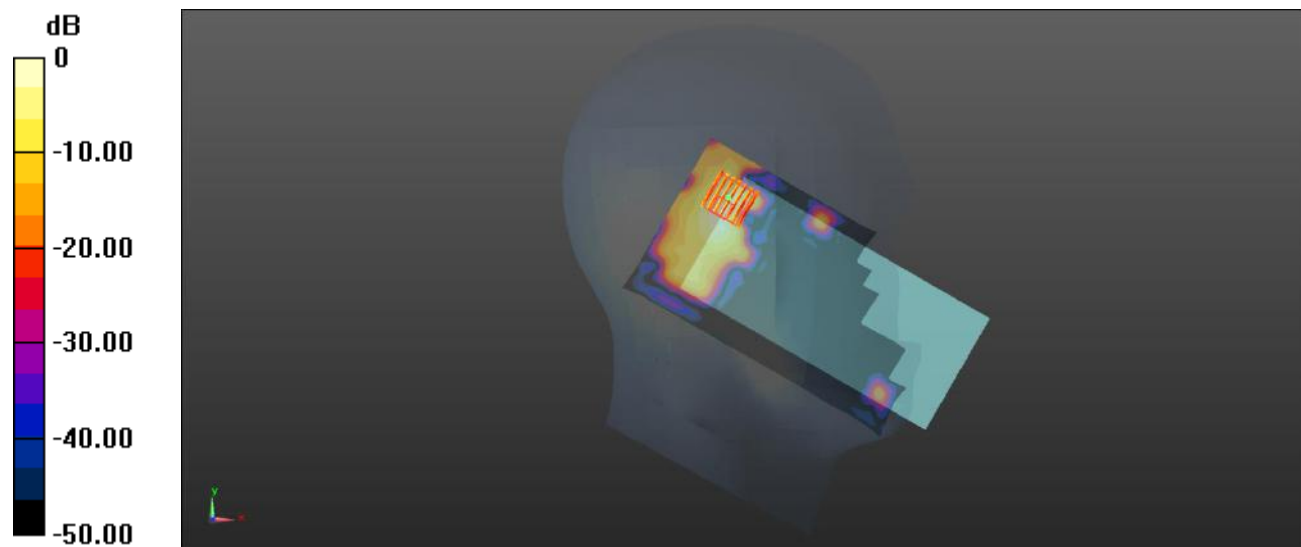

0 dB = 0.492 W/kg

**Meas.60 Left Head with Tilt on 155 Channel in IEEE802.11ac80 mode with Antenna 7**

Date: 2022.10.24

Communication System Band: WLAN(ac80); Frequency: 5775 MHz; Duty Cycle: 1:1.072

Medium parameters used (interpolated):  $f = 5775$  MHz;  $\sigma = 5.222$  S/m;  $\epsilon_r = 35.31$ ;  $\rho = 1000$  kg/m<sup>3</sup>

Phantom section: Flat Section

Ambient Temperature: 22.5°C Liquid Temperature: 21.5°C

## DASY5 Configuration:

- Probe: EX3DV4 - SN7607; ConvF(5, 5, 5); Calibrated: 2022.07.04;
- Sensor-Surface: 2mm (Mechanical Surface Detection)
- Electronics: DAE4 Sn878; Calibrated: 2022.06.13
- Phantom: SAM1; Type: QD000P40CD; Serial: TP:1576
- Measurement SW: DASY52, Version 52.8 (8); SEMCAD X Version 14.6.10 (7331)

**Ch155/Area Scan (101x191x1):** Interpolated grid: dx=1.000 mm, dy=1.000 mm

Maximum value of SAR (interpolated) = 0.322 W/kg

**Ch155/Zoom Scan (7x7x12)/Cube 0:** Measurement grid: dx=4mm, dy=4mm, dz=2mm

Reference Value = 2.134 V/m; Power Drift = 0.09 dB

Peak SAR (extrapolated) = 0.358 W/kg

**SAR(1 g) = 0.080 W/kg; SAR(10 g) = 0.022 W/kg**

Maximum value of SAR (measured) = 0.208 W/kg

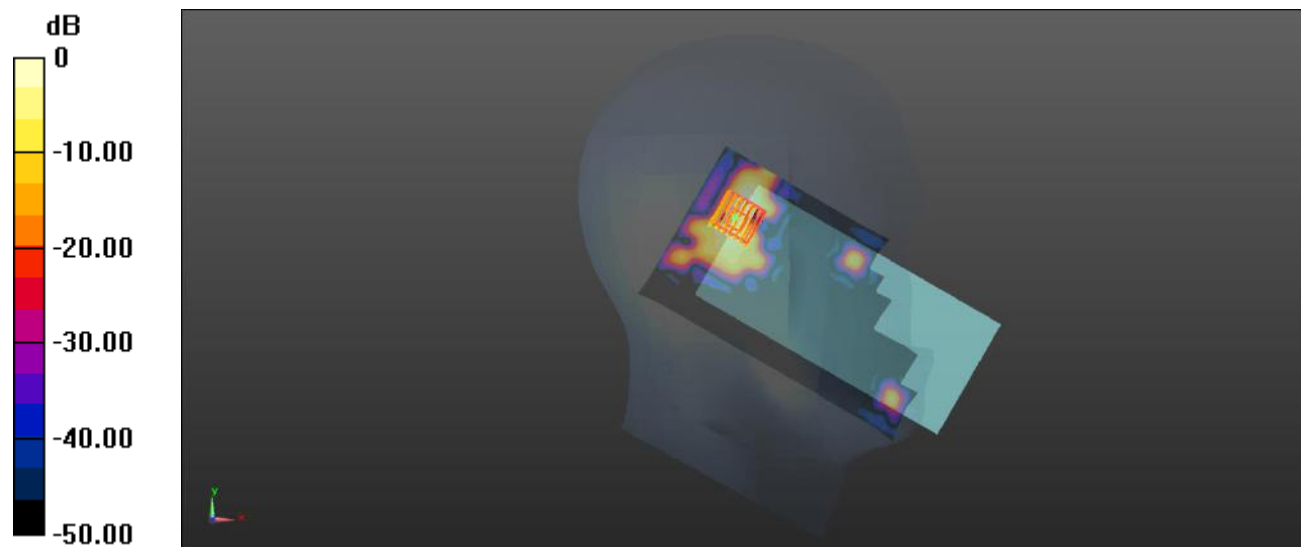

0 dB = 0.208 W/kg

**Meas.61 Body Plane with Back Side 10mm on 64 Channel in IEEE802.11n20 mode with Antenna.7**

Date: 2022.10.23

Communication System Band: WLAN(n20); Frequency: 5320 MHz; Duty Cycle: 1:1.034

Medium parameters used (interpolated):  $f = 5320$  MHz;  $\sigma = 4.844$  S/m;  $\epsilon_r = 35.045$ ;  $\rho = 1000$  kg/m<sup>3</sup>

Phantom section: Flat Section

Ambient Temperature: 22.6°C Liquid Temperature: 21.3°C

DASY5 Configuration:

- Probe: EX3DV4 - SN7607; ConvF(5.45, 5.45, 5.45); Calibrated: 2022.07.04;
- Sensor-Surface: 2mm (Mechanical Surface Detection)
- Electronics: DAE4 Sn878; Calibrated: 2022.06.13
- Phantom: SAM1; Type: QD000P40CD; Serial: TP:1576
- Measurement SW: DASY52, Version 52.8 (8); SEMCAD X Version 14.6.10 (7331)

**Ch64/Area Scan (111x191x1):** Interpolated grid: dx=1.000 mm, dy=1.000 mm

Maximum value of SAR (interpolated) = 0.775 W/kg

**Ch64/Zoom Scan (7x7x12)/Cube 0:** Measurement grid: dx=4mm, dy=4mm, dz=2mm

Reference Value = 0 V/m; Power Drift = 0.09 dB

Peak SAR (extrapolated) = 1.53 W/kg

**SAR(1 g) = 0.419 W/kg; SAR(10 g) = 0.152 W/kg**

Maximum value of SAR (measured) = 0.794 W/kg

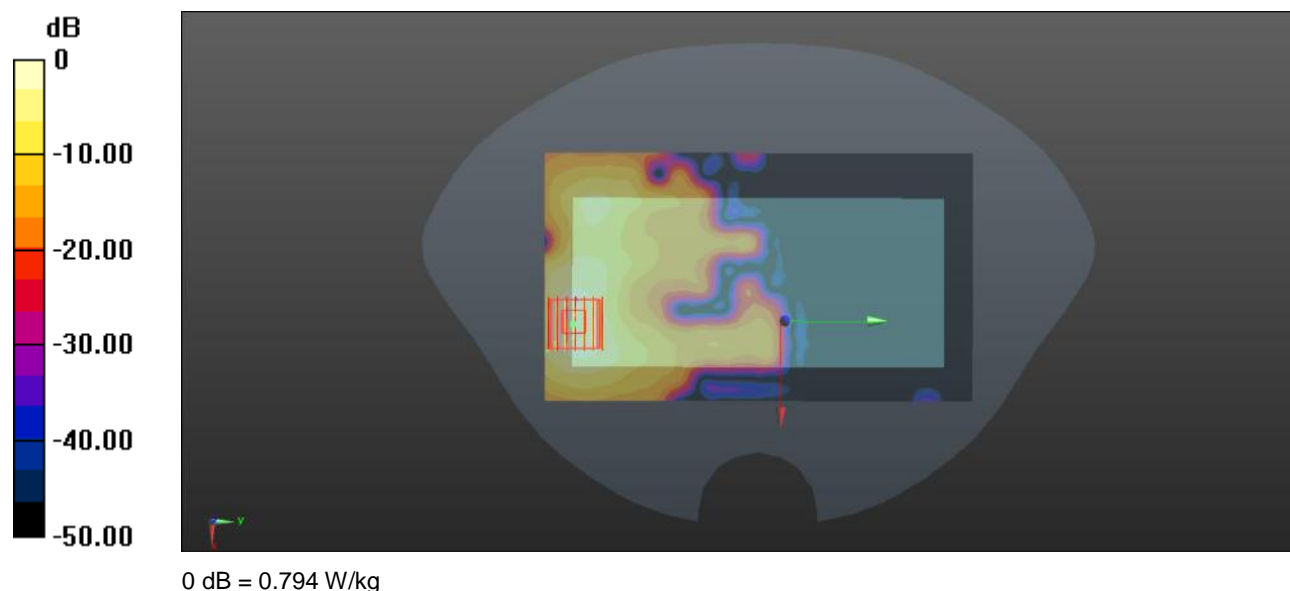

**Meas.62 Body Plane with Back Side 10mm on 142 Channel in IEEE802.11ac40 mode with Antenna 7**

Date: 2022.10.24

Communication System Band: WLAN(ac40); Frequency: 5710 MHz; Duty Cycle: 1:1.034

Medium parameters used (interpolated):  $f = 5710$  MHz;  $\sigma = 5.223$  S/m;  $\epsilon_r = 35.121$ ;  $\rho = 1000$  kg/m<sup>3</sup>

Phantom section: Flat Section

Ambient Temperature: 22.5°C Liquid Temperature: 21.5°C

DASY5 Configuration:

- Probe: EX3DV4 - SN7607; ConvF(5, 5, 5); Calibrated: 2022.07.04;
- Sensor-Surface: 2mm (Mechanical Surface Detection)
- Electronics: DAE4 Sn878; Calibrated: 2022.06.13
- Phantom: SAM1; Type: QD000P40CD; Serial: TP:1576
- Measurement SW: DASY52, Version 52.8 (8); SEMCAD X Version 14.6.10 (7331)

**Ch142/Area Scan (111x201x1):** Interpolated grid: dx=1.000 mm, dy=1.000 mm

Maximum value of SAR (interpolated) = 0.549 W/kg

**Ch142/Zoom Scan (7x7x12)/Cube 0:** Measurement grid: dx=4mm, dy=4mm, dz=2mm

Reference Value = 0.4490 V/m; Power Drift = -0.07 dB

Peak SAR (extrapolated) = 1.17 W/kg

**SAR(1 g) = 0.277 W/kg; SAR(10 g) = 0.088 W/kg**

Maximum value of SAR (measured) = 0.559 W/kg

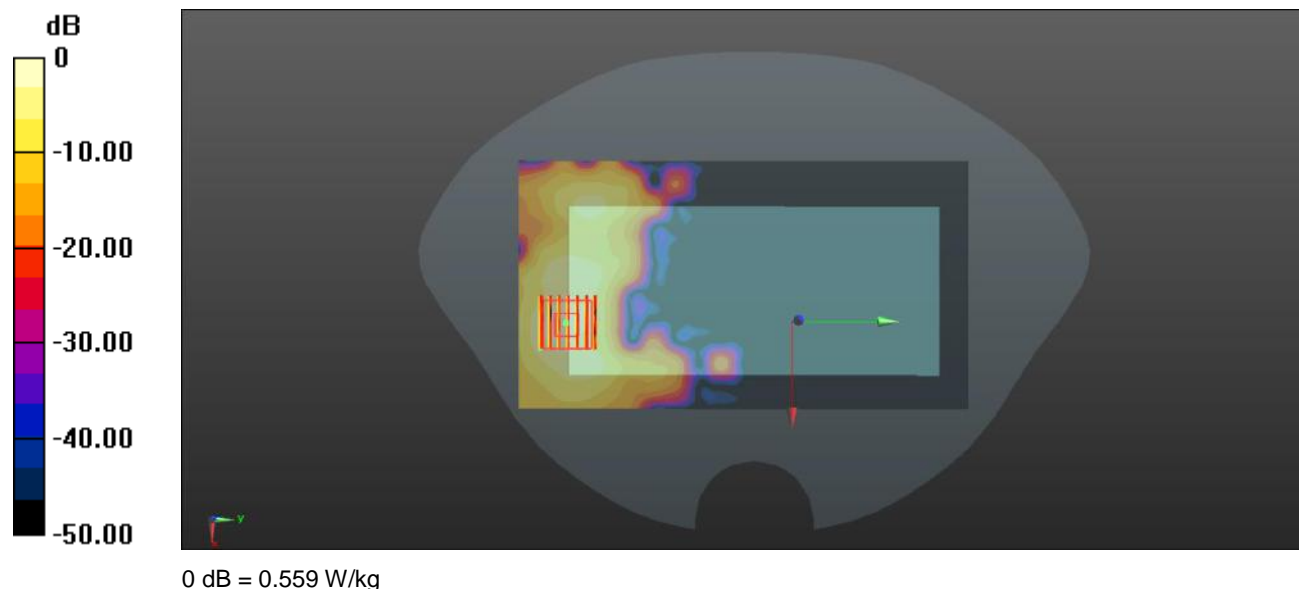



**Meas.63 Body Plane with Top Edge 10mm on 46 Channel in 802.11ac40 mode with Antenna.7**

Date: 2022.10.23

Communication System Band: WLAN(ac40); Frequency: 5230 MHz; Duty Cycle: 1:1.034

Medium parameters used (interpolated):  $f = 5230$  MHz;  $\sigma = 4.659$  S/m;  $\epsilon_r = 36.236$ ;  $\rho = 1000$  kg/m<sup>3</sup>

Phantom section: Flat Section

Ambient Temperature: 22.6°C Liquid Temperature: 21.3°C

DASY5 Configuration:

- Probe: EX3DV4 - SN7607; ConvF(5.45, 5.45, 5.45); Calibrated: 2022.07.04;
- Sensor-Surface: 2mm (Mechanical Surface Detection)
- Electronics: DAE4 Sn878; Calibrated: 2022.06.13
- Phantom: SAM1; Type: QD000P40CD; Serial: TP:1576
- Measurement SW: DASY52, Version 52.8 (8); SEMCAD X Version 14.6.10 (7331)

**Ch46/Area Scan (101x121x1):** Interpolated grid: dx=1.000 mm, dy=1.000 mm

Maximum value of SAR (interpolated) = 0.755 W/kg

**Ch46/Zoom Scan (7x7x12)/Cube 0:** Measurement grid: dx=4mm, dy=4mm, dz=2mm

Reference Value = 6.343 V/m; Power Drift = -0.16 dB

Peak SAR (extrapolated) = 1.48 W/kg

**SAR(1 g) = 0.411 W/kg; SAR(10 g) = 0.152 W/kg**

Maximum value of SAR (measured) = 0.762 W/kg

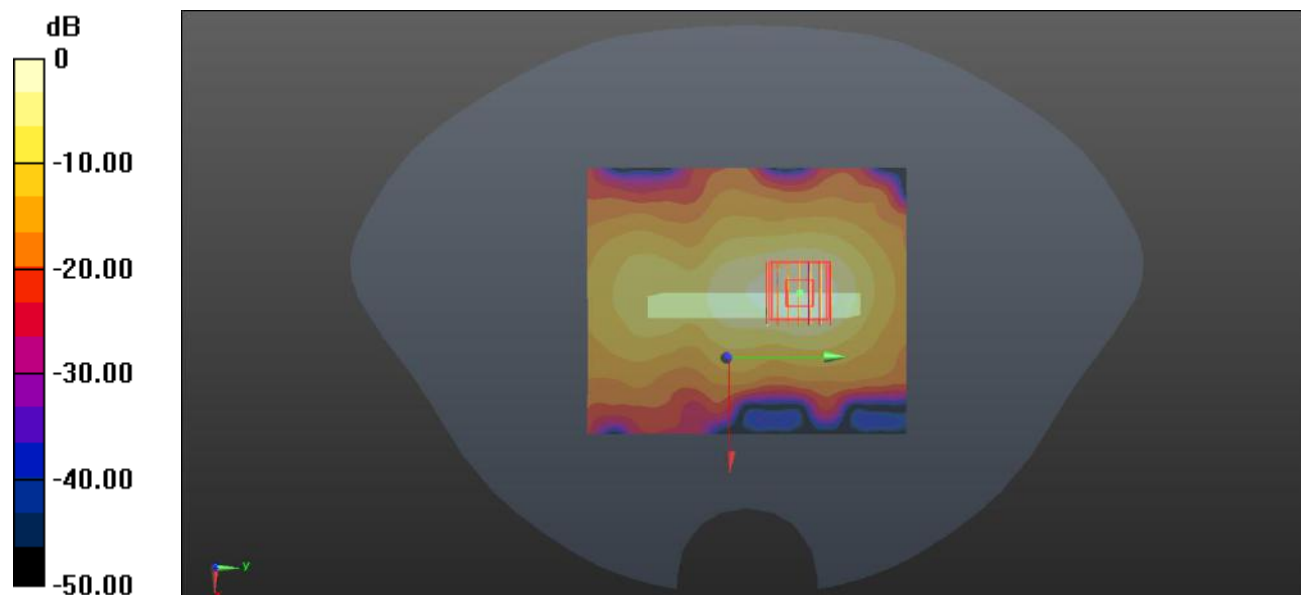

0 dB = 0.762 W/kg

**Meas.64 Body Plane with Top Edge 10mm on 155 Channel in 802.11ac80 mode with Antenna.7**

Date: 2022.10.24

Communication System Band: WLAN(ac80); Frequency: 5775 MHz; Duty Cycle: 1:1.072

Medium parameters used (interpolated):  $f = 5775$  MHz;  $\sigma = 5.222$  S/m;  $\epsilon_r = 35.31$ ;  $\rho = 1000$  kg/m<sup>3</sup>

Phantom section: Flat Section

Ambient Temperature: 22.5°C Liquid Temperature: 21.5°C

DASY5 Configuration:

- Probe: EX3DV4 - SN7607; ConvF(5, 5, 5); Calibrated: 2022.07.04;
- Sensor-Surface: 2mm (Mechanical Surface Detection)
- Electronics: DAE4 Sn878; Calibrated: 2022.06.13
- Phantom: SAM1; Type: QD000P40CD; Serial: TP:1576
- Measurement SW: DASY52, Version 52.8 (8); SEMCAD X Version 14.6.10 (7331)

**Ch155/Area Scan (101x121x1):** Interpolated grid: dx=1.000 mm, dy=1.000 mm

Maximum value of SAR (interpolated) = 0.178 W/kg

**Ch155/Zoom Scan (7x7x12)/Cube 0:** Measurement grid: dx=4mm, dy=4mm, dz=2mm

Reference Value = 2.786 V/m; Power Drift = 0.16 dB

Peak SAR (extrapolated) = 0.305 W/kg

**SAR(1 g) = 0.079 W/kg; SAR(10 g) = 0.025 W/kg**

Maximum value of SAR (measured) = 0.172 W/kg

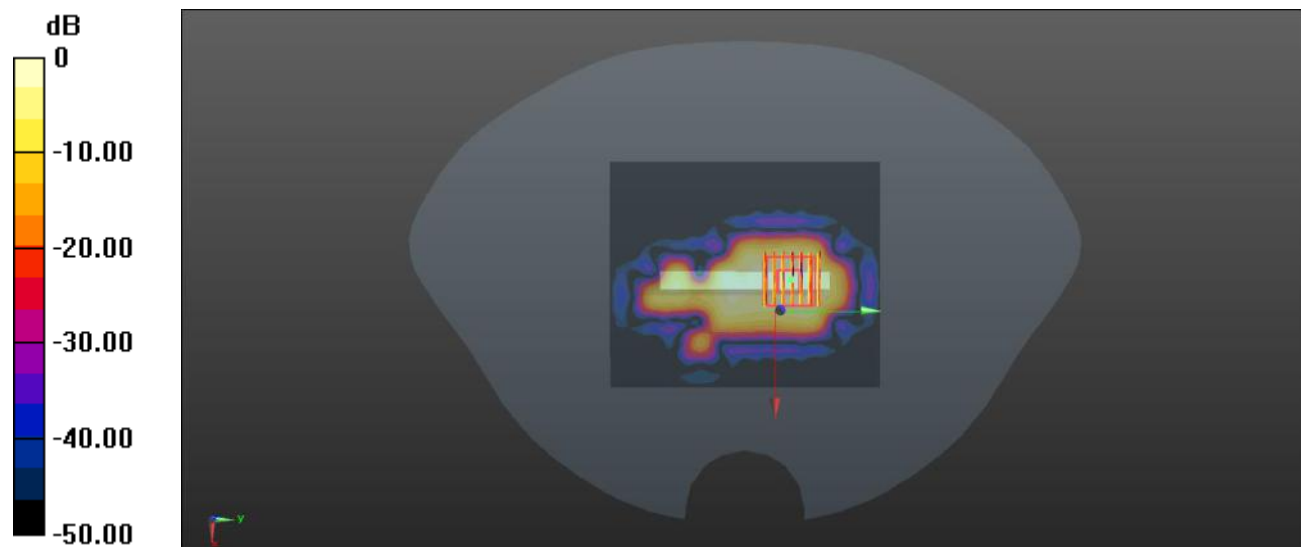

0 dB = 0.172 W/kg

**Meas.65 Body Plane with Top Edge 0mm on 64 Channel in 802.11n20 mode with Antenna.7**

Date: 2022.10.23

Communication System Band: WLAN(n20); Frequency: 5320 MHz; Duty Cycle: 1:1.034

Medium parameters used (interpolated):  $f = 5320$  MHz;  $\sigma = 4.844$  S/m;  $\epsilon_r = 35.045$ ;  $\rho = 1000$  kg/m<sup>3</sup>

Phantom section: Flat Section

Ambient Temperature: 22.6°C Liquid Temperature: 21.3°C

DASY5 Configuration:

- Probe: EX3DV4 - SN7607; ConvF(5.45, 5.45, 5.45); Calibrated: 2022.07.04;
- Sensor-Surface: 2mm (Mechanical Surface Detection)
- Electronics: DAE4 Sn878; Calibrated: 2022.06.13
- Phantom: SAM1; Type: QD000P40CD; Serial: TP:1576
- Measurement SW: DASY52, Version 52.8 (8); SEMCAD X Version 14.6.10 (7331)

**Ch64/Area Scan (101x121x1):** Interpolated grid: dx=1.000 mm, dy=1.000 mm

Maximum value of SAR (interpolated) = 12.8 W/kg

**Ch64/Zoom Scan (7x7x12)/Cube 0:** Measurement grid: dx=4mm, dy=4mm, dz=2mm

Reference Value = 8.095 V/m; Power Drift = -0.01 dB

Peak SAR (extrapolated) = 41.0 W/kg

**SAR(1 g) = 5.63 W/kg; SAR(10 g) = 1.05 W/kg**

Maximum value of SAR (measured) = 15.9 W/kg

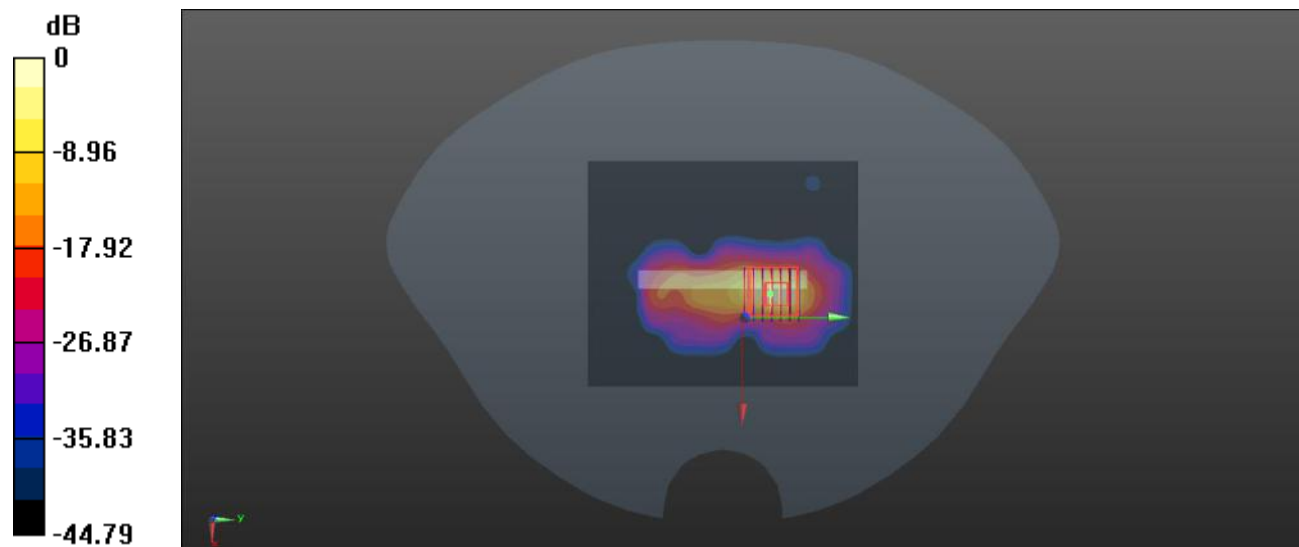

0 dB = 15.9 W/kg

**Meas.66 Body Plane with Top Edge 0mm on 142 Channel in 802.11ac40 mode with Antenna.7**

Date: 2022.10.24

Communication System Band: WLAN(ac40); Frequency: 5710 MHz; Duty Cycle: 1:1.034

Medium parameters used (interpolated):  $f = 5710$  MHz;  $\sigma = 5.223$  S/m;  $\epsilon_r = 35.121$ ;  $\rho = 1000$  kg/m<sup>3</sup>

Phantom section: Flat Section

Ambient Temperature: 22.5°C Liquid Temperature: 21.5°C

DASY5 Configuration:

- Probe: EX3DV4 - SN7607; ConvF(5, 5, 5); Calibrated: 2022.07.04;
- Sensor-Surface: 2mm (Mechanical Surface Detection)
- Electronics: DAE4 Sn878; Calibrated: 2022.06.13
- Phantom: SAM1; Type: QD000P40CD; Serial: TP:1576
- Measurement SW: DASY52, Version 52.8 (8); SEMCAD X Version 14.6.10 (7331)

**Ch142/Area Scan (101x121x1):** Interpolated grid: dx=1.000 mm, dy=1.000 mm

Maximum value of SAR (interpolated) = 8.51 W/kg

**Ch142/Zoom Scan (7x7x12)/Cube 0:** Measurement grid: dx=4mm, dy=4mm, dz=2mm

Reference Value = 8.878 V/m; Power Drift = 0.03 dB

Peak SAR (extrapolated) = 30.5 W/kg

**SAR(1 g) = 4.12 W/kg; SAR(10 g) = 0.879 W/kg**

Maximum value of SAR (measured) = 12.4 W/kg

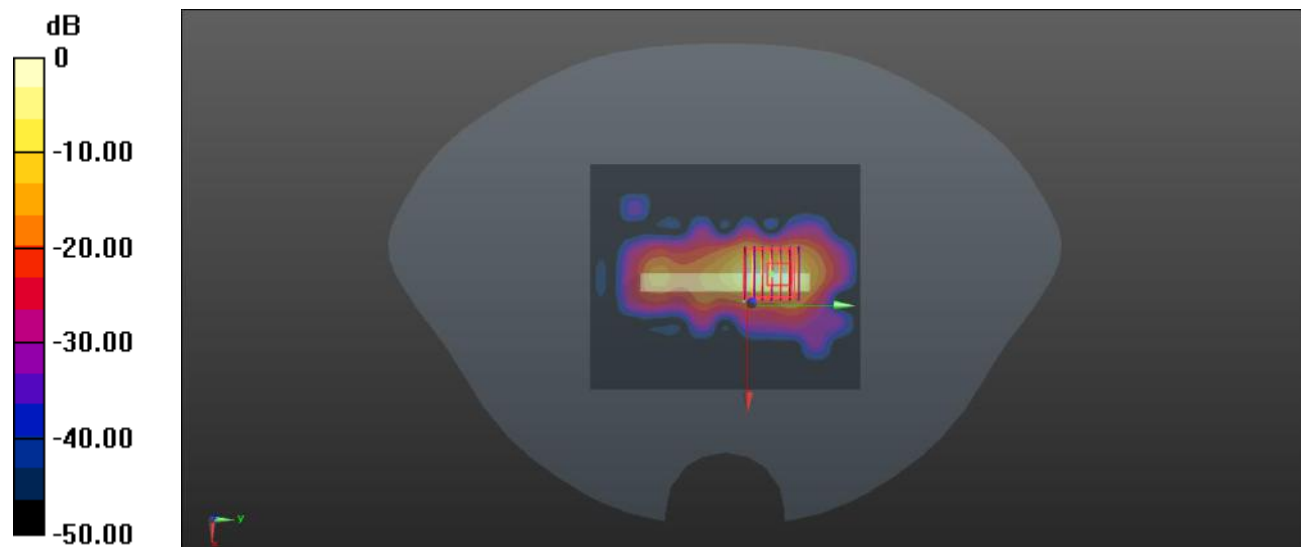

0 dB = 12.4 W/kg

**Meas.67 Left Head with Cheek on 0 Channel in Bluetooth mode with Antenna.6**

Date: 2022.10.08

Communication System Band: BT; Frequency: 2402 MHz;Duty Cycle: 1:1.301

Medium parameters used (interpolated):  $f = 2402$  MHz;  $\sigma = 1.747$  S/m;  $\epsilon_r = 39.829$ ;  $\rho = 1000$  kg/m<sup>3</sup>

Phantom section: Left Section

Ambient Temperature:22.5°C Liquid Temperature:21.1°C

DASY5 Configuration:

- Probe: EX3DV4 - SN7607; ConvF(7.79, 7.79, 7.79); Calibrated: 2022.07.04;
- Sensor-Surface: 4mm (Mechanical Surface Detection)
- Electronics: DAE4 Sn878; Calibrated: 2022.06.13
- Phantom: SAM1; Type: QD000P40CD; Serial: TP:1576
- Measurement SW: DASY52, Version 52.8 (8); SEMCAD X Version 14.6.10 (7331)

**Ch0/Area Scan (81x161x1):** Interpolated grid: dx=1.200 mm, dy=1.200 mm

Maximum value of SAR (interpolated) = 0.107 W/kg

**Ch0/Zoom Scan (7x7x7)/Cube 0:** Measurement grid: dx=5mm, dy=5mm, dz=5mm

Reference Value = 2.716 V/m; Power Drift = 0.03 dB

Peak SAR (extrapolated) = 0.159 W/kg

**SAR(1 g) = 0.086 W/kg; SAR(10 g) = 0.044 W/kg**

Maximum value of SAR (measured) = 0.0986 W/kg

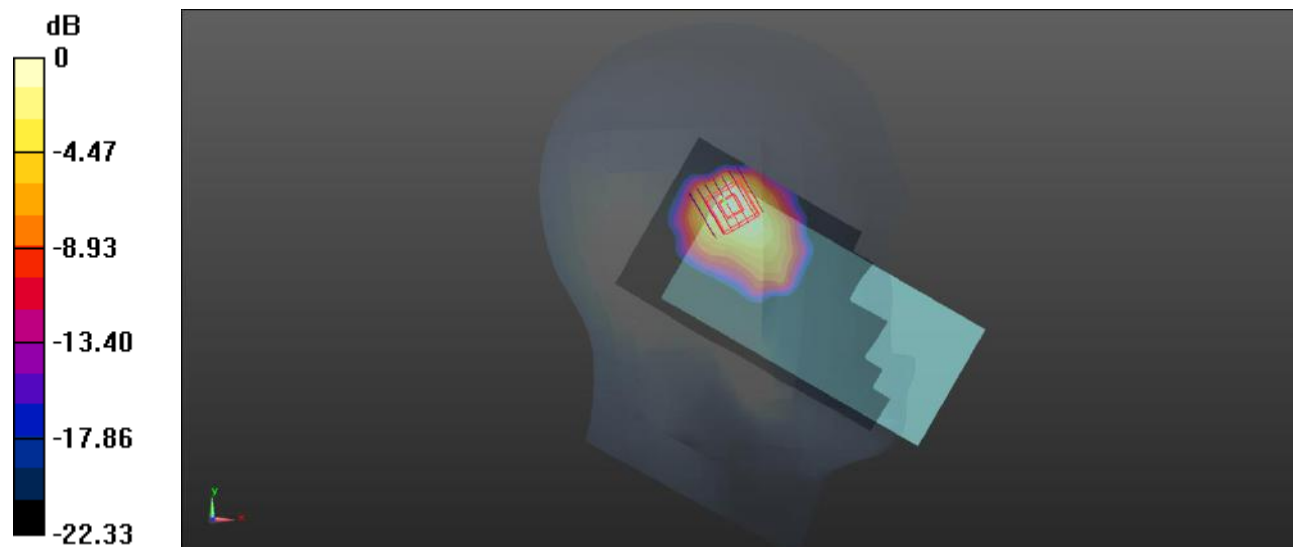

0 dB = 0.0986 W/kg

**Meas.68 Body Plane with Back Side 10mm on 0 Channel in BT mode with Antenna.6**

Date: 2022.10.08

Communication System Band: BT; Frequency: 2402 MHz; Duty Cycle: 1:1.301

Medium parameters used (interpolated):  $f = 2402$  MHz;  $\sigma = 1.747$  S/m;  $\epsilon_r = 39.829$ ;  $\rho = 1000$  kg/m<sup>3</sup>

Phantom section: Flat Section

Ambient Temperature: 22.5°C Liquid Temperature: 21.1°C

DASY5 Configuration:

- Probe: EX3DV4 - SN7607; ConvF(7.79, 7.79, 7.79); Calibrated: 2022.07.04;
- Sensor-Surface: 4mm (Mechanical Surface Detection)
- Electronics: DAE4 Sn878; Calibrated: 2022.06.13
- Phantom: SAM1; Type: QD000P40CD; Serial: TP:1576
- Measurement SW: DASY52, Version 52.8 (8); SEMCAD X Version 14.6.10 (7331)

**Ch0/Area Scan (91x161x1):** Interpolated grid: dx=1.200 mm, dy=1.200 mm

Maximum value of SAR (interpolated) = 0.0277 W/kg

**/Ch0/Zoom Scan (7x7x7)/Cube 0:** Measurement grid: dx=5mm, dy=5mm, dz=5mm

Reference Value = 0 V/m; Power Drift = 0.15 dB

Peak SAR (extrapolated) = 0.0420 W/kg

**SAR(1 g) = 0.019 W/kg; SAR(10 g) = 0.15 W/kg**

Maximum value of SAR (measured) = 0.0215 W/kg

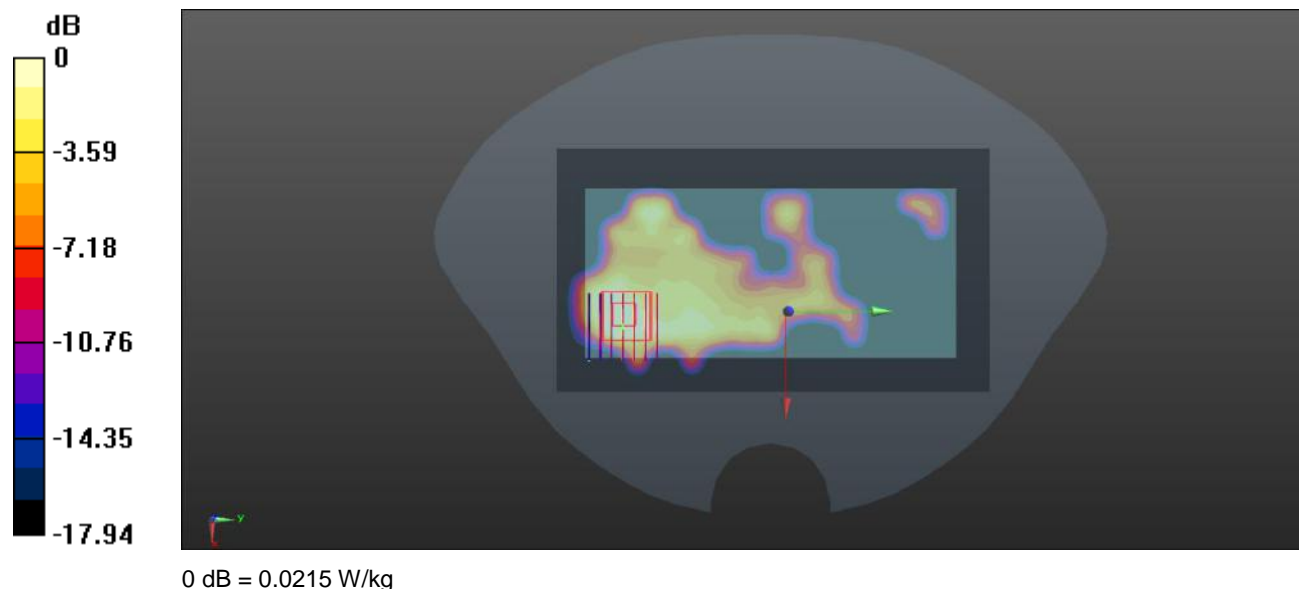

## **ANNEX D EUT EXTERNAL PHOTOS**

Please refer the document “BL-SZ2290497-AW.pdf”.

## **ANNEX E SAR TEST SETUP PHOTOS**

Please refer the document “BL-SZ2290497-AS.pdf”.

## **ANNEX F CALIBRATION REPORT**

Please refer the document “CALIBRATION REPORT.pdf”.

## Statement

1. The laboratory guarantees the scientificity, accuracy and impartiality of the test, and is responsible for all the information in the report, except the information provided by the customer. The customer is responsible for the impact of the information provided on the validity of the results.
2. The report without China inspection body and laboratory Mandatory Approval (CMA) mark has no effect of proving to the society.
3. For the report with CNAS mark or A2LA mark, the items marked with "☆" are not within the accredited scope.
4. This report is invalid if it is altered, without the signature of the testing and approval personnel, or without the "inspection and testing dedicated stamp" or test report stamp.
5. The test data and results are only valid for the tested samples provided by the customer.
6. This report shall not be partially reproduced without the written permission of the laboratory.
7. Any objection shall be raised to the laboratory within 30 days after receiving the report.

--END OF REPORT--