

FCC RF Test Report

APPLICANT : Xiaomi Communications Co., Ltd.
EQUIPMENT : Mobile Phone
BRAND NAME : POCO
MODEL NAME : 22041216UG
FCC ID : 2AFZZ1216U
STANDARD : 47 CFR Part 2, Part 27 Subpart Q
CLASSIFICATION : PCS Licensed Transmitter Held to Ear (PCE)
TEST DATE(S) : Mar. 25, 2022 ~ Apr. 11, 2022

We, Sporton International Inc. (Kunshan), would like to declare that the tested sample has been evaluated in accordance with the procedures given in ANSI C63.26-2015 and shown compliance with the applicable technical standards.

The test results in this report apply exclusively to the tested model / sample. Without written approval of Sporton International Inc. (Kunshan), the test report shall not be reproduced except in full.

Jason Jia

Approved by: Jason Jia



Sporton International Inc. (Kunshan)

**No. 1098, Pengxi North Road, Kunshan Economic Development Zone Jiangsu Province 215300
People's Republic of China**



TABLE OF CONTENTS

REVISION HISTORY..... 3
SUMMARY OF TEST RESULT 4
1 GENERAL DESCRIPTION 5
1.1 Applicant 5
1.2 Manufacturer 5
1.3 Product Feature of Equipment Under Test 5
1.4 Product Specification of Equipment Under Test 5
1.5 Modification of EUT 6
1.6 Maximum EIRP Power and Emission Designator 6
1.7 Testing Site 7
1.8 Test Software 7
1.9 Applied Standards 7
2 TEST CONFIGURATION OF EQUIPMENT UNDER TEST 8
2.1 Test Mode 8
2.2 Connection Diagram of Test System 9
2.3 Support Unit used in test configuration and system 9
2.4 Measurement Results Explanation Example 9
2.5 Frequency List of Low/Middle/High Channels 10
3 CONDUCTED TEST ITEMS 12
3.1 Measuring Instruments 12
3.2 Test Setup 12
3.3 Test Result of Conducted Test 12
3.4 Conducted Output Power Measurement 13
3.5 Peak-to-Average Ratio 14
3.6 EIRP 15
3.7 Occupied Bandwidth 16
3.8 Conducted Band Edge Measurement 17
3.9 Conducted Spurious Emission Measurement 18
3.10 Frequency Stability Measurement 19
4 RADIATED TEST ITEMS 20
4.1 Measuring Instruments 20
4.2 Test Setup 20
4.3 Test Result of Radiated Test 21
4.4 Radiated Spurious Emission Measurement 22
5 LIST OF MEASURING EQUIPMENT 23
6 UNCERTAINTY OF EVALUATION 24
APPENDIX A. TEST RESULTS OF CONDUCTED TEST
APPENDIX B. TEST RESULTS OF RADIATED TEST
APPENDIX C. TEST SETUP PHOTOGRAPHS

SUMMARY OF TEST RESULT

Report Section	FCC Rule	Description	Limit	Result	Remark
3.4	§2.1046	Conducted Output Power	—	Report Only	-
3.5	§27.50 (k)(4)	Peak-to-Average Ratio	<13dB	PASS	
3.6	§27.50 (k)(3)	EIRP	EIRP < 1W (30dBm)	PASS	-
3.7	§2.1049	Occupied Bandwidth	—	Report Only	-
3.8	§2.1051 §27.53 (n)(2)	Conducted Band Edge Measurement	-13dBm/MHz	PASS	-
3.9	§2.1051 §27.53 (n)(2)	Conducted Spurious Emission	-13dBm/MHz	PASS	-
3.10	§2.1055 §27.54	Frequency Stability Temperature & Voltage	Within the band	PASS	-
4.4	§2.1053 §27.53 (n)(2)	Radiated Spurious Emission	-13dBm/MHz	PASS	Under limit 38.70 dB at 6900.000 MHz

Declaration of Conformity:
The test results with all measurement uncertainty excluded are presented in accordance with the regulation limits or requirements declared by manufacturers.
Comments and Explanations:
The declared of product specification for EUT presented in the report are provided by the manufacturer, and the manufacturer takes all the responsibilities for the accuracy of product specification.

1 General Description

1.1 Applicant

Xiaomi Communications Co., Ltd.

#019, 9th Floor, Building 6, 33 Xi'erqi Middle Road, Haidian District, Beijing, China, 100085

1.2 Manufacturer

Xiaomi Communications Co., Ltd.

#019, 9th Floor, Building 6, 33 Xi'erqi Middle Road, Haidian District, Beijing, China, 100085

1.3 Product Feature of Equipment Under Test

Product Feature	
Equipment	Mobile Phone
Brand Name	POCO
Model Name	22041216UG
FCC ID	2AFZZ1216U
IMEI Code	Conducted: 867032060031692 Radiation: 867032060031676/867032060031684
HW Version	P2
SW Version	MIUI13
EUT Stage	Identical Prototype

1.4 Product Specification of Equipment Under Test

Product Feature	
Tx/Rx Frequency	5G NR n77: 3450 MHz ~ 3550 MHz 5G NR n78: 3450 MHz ~ 3550 MHz
SCS	15kHz/30kHz
Bandwidth	n77, n78(15kHz): 10MHz / 15MHz / 20MHz / 25MHz / 30MHz / 40MHz / 50MHz n77, n78(30kHz): 10MHz / 15MHz / 20MHz / 25MHz / 30MHz / 40MHz / 50MHz / 60MHz / 70MHz / 80MHz / 90MHz / 100MHz
Antenna Gain	Ant. 2: 5G NR n77: -1.1 dBi 5G NR n78: -1.1 dBi Ant. 3: 5G NR n77: 0.77 dBi 5G NR n78: 0.77 dBi Ant. 4: 5G NR n77: 1.1 dBi 5G NR n78: 1.1 dBi Ant. 5: 5G NR n77: -1.3 dBi 5G NR n78: -0.8 dBi

Type of Modulation	CP-OFDM: QPSK / 16QAM / 64QAM / 256QAM
	DFT-s-OFDM: PI/2 BPSK / QPSK / 16QAM / 64QAM / 256QAM

Remark:

1. The maximum EIRP is calculated from max Output power and antenna gain, only the maximum EIRP are shown in the report, 5G NR n77/n78 for Antenna 4.
2. The device supports n78(1T4R) SRS resources on Ant.2/3/4/5, only the test data of worst Ant.4 is showed in the report according to the maximum power
3. 5G NR n77 support SA, n78 support SA & NSA, SA covers NSA by referring to the maximum power.
4. 5G NR bands support SCS 15kHz and SCS 30kHz. According to the maximum power, n78 SCS 15kHz covers SCS 30kHz for BW 10/15/20/25/30/40/50MHz.
5. The device supports HPUE mode for 5G NR SA n78.
6. The EN-DC mode combination: DC_2A_n78A, DC_5A_n78A, DC_7A_n78A, DC_38A_n78A, DC_41A_n78A.

1.5 Modification of EUT

No modifications are made to the EUT during all test items.

1.6 Maximum EIRP Power and Emission Designator

5G NR n77 SA (15kHz)		PI/2 BPSK / QPSK		16QAM / 64QAM / 256QAM	
BW (MHz)	Frequency Range (MHz)	Maximum EIRP(W)	Emission Designator (99%OBW)	Maximum EIRP(W)	Emission Designator (99%OBW)
50	3475.02 ~ 3525.00	0.4217	48M4G7D	0.3243	48M3W7D
5G NR n77 SA (30kHz)		PI/2 BPSK / QPSK		16QAM / 64QAM / 256QAM	
BW (MHz)	Frequency Range (MHz)	Maximum EIRP(W)	Emission Designator (99%OBW)	Maximum EIRP(W)	Emission Designator (99%OBW)
100	3500.01	0.4325	97M7G7D	0.2931	97M3W7D

5G NR n78 SA (15kHz)		PI/2 BPSK / QPSK		16QAM / 64QAM / 256QAM	
BW (MHz)	Frequency Range (MHz)	Maximum EIRP(W)	Emission Designator (99%OBW)	Maximum EIRP(W)	Emission Designator (99%OBW)
50	3475.02 ~ 3525.00	0.7482	48M4G7D	0.5675	48M3W7D
5G NR n78 SA (30kHz)		PI/2 BPSK / QPSK		16QAM / 64QAM / 256QAM	
BW (MHz)	Frequency Range (MHz)	Maximum EIRP(W)	Emission Designator (99%OBW)	Maximum EIRP(W)	Emission Designator (99%OBW)
100	3500.01	0.7447	97M7G7D	0.5176	97M3W7D

Note:

1. All modulations have been tested, and only the worst test results of PSK & QAM are shown in the report.
2. 5G NR Band n78 overlaps the entire frequency range of Band n77. Therefore, the conducted test results provided in this report covers Band n78 as well as Band n77.

1.7 Testing Site

Sporton International Inc. (Kunshan) is accredited to ISO/IEC 17025:2017 by American Association for Laboratory Accreditation with Certificate Number 5145.02.

Test Firm	Sporton International Inc. (Kunshan)		
Test Site Location	No. 1098, Pengxi North Road, Kunshan Economic Development Zone Jiangsu Province 215300 People's Republic of China TEL : +86-512-57900158 FAX : +86-512-57900958		
Test Site No.	Sporton Site No.	FCC Designation No.	FCC Test Firm Registration No.
	03CH04-KS TH01-KS	CN1257	314309

1.8 Test Software

Item	Site	Manufacture	Name	Version
1.	03CH04-KS	AUDIX	E3	6.2009-8-24a

1.9 Applied Standards

According to the specifications of the manufacturer, the EUT must comply with the requirements of the following standards:

- ♦ 47 CFR Part 2, Part 27 Subpart Q
- ♦ ANSI C63.26-2015
- ♦ FCC KDB 971168 Power Meas License Digital Systems D01 v03r01
- ♦ FCC KDB 412172 D01 Determining ERP and EIRP v01r01

Remark:

1. All test items were verified and recorded according to the standards and without any deviation during the test.
2. This EUT has also been tested and complied with the requirements of FCC Part 15, Subpart B, recorded in a separate test report.

2 Test Configuration of Equipment Under Test

2.1 Test Mode

Antenna port conducted and radiated test items listed below are performed according to KDB 971168 D01 Power Meas. License Digital Systems v03r01 with maximum output power.

For radiated measurement, pre-scanned in three orthogonal panels, X, Y, Z. The worst cases (Z plane) were recorded in this report.

Test Items	5G NR	Bandwidth (MHz)									Modulation					RB #		Test Channel				
		10	15	20	25	30	40	50	60-90	100	PI/2 BPSK	QPSK	16QAM	64QAM	256 QAM	1	Full	L	M	H		
Max. Output Power	n77	v	v	v	v	v	v	v	v	v	v	v	v	v	v	v	v	v	v	v		
	n78	v	v	v	v	v	v	v	v	v	v	v	v	v	v	v	v	v	v	v		
Peak-to-Average Ratio	n78							v		v	v	v	v	v		v			v			
26dB and 99% Bandwidth	n78							v		v		v	v				v			v		
Conducted Band Edge	n78	v	v	v	v	v	v	v	v	v	v	v	v	v	v	v	v	v	v		v	
Conducted Spurious Emission	n78	v	v	v	v	v	v	v	v	v		v					v			v	v	v
Frequency Stability	n78							v		v		v					v				v	
E.R.P / E.I.R.P	n77	v	v	v	v	v	v	v	v	v	v	v	v	v	v	v	v	v	v	v	v	v
	n78	v	v	v	v	v	v	v	v	v	v	v	v	v	v	v	v	v	v	v	v	v
Radiated Spurious Emission	n78	Worst Case																		v		
Note	<ol style="list-style-type: none"> The mark "v" means that this configuration is chosen for testing The mark "-" means that this bandwidth is not supported. The device is investigated from 30MHz to 10 times of fundamental signal for radiated spurious emission test under different RB size/offset and modulations in exploratory test. Subsequently, only the worst case emissions are reported. Based on engineering evaluation, only the worst modulations test results are shown in the report. 5G NR n78 overlaps the entire frequency range of n77, Therefore, the test results provided in this report covers n78 as well as n77. Normal Voltage: 3.87Vdc, Extreme Voltage: 3.60Vdc ~4.45Vdc 																					

2.2 Connection Diagram of Test System

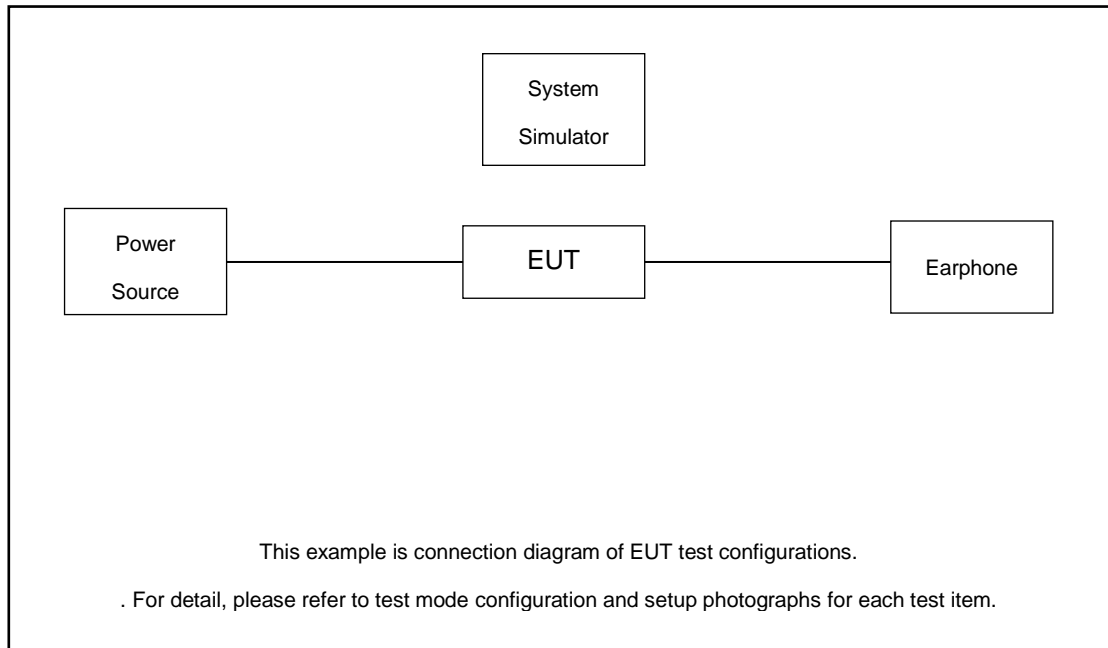

2.3 Support Unit used in test configuration and system

Item	Equipment	Trade Name	Model No.	FCC ID	Data Cable	Power Cord
1.	Power Supply	GWINSTEK	PSS-2002	N/A	N/A	Unshielded, 1.8 m
2.	LTE Base Station	Anritsu	MT8821C	N/A	N/A	Unshielded, 1.8 m
3.	NR Base Station	Anritsu	MT8000A	N/A	N/A	Unshielded, 1.8 m
4.	Earphone	Xiaomi	N/A	N/A	N/A	N/A

2.4 Measurement Results Explanation Example

For all conducted test items:

The offset level is set in the spectrum analyzer to compensate the RF cable loss between EUT conducted output port and spectrum analyzer. With the offset compensation, the spectrum analyzer reading level is exactly the EUT RF output level.

The spectrum analyzer offset is derived from RF cable loss.

Offset = RF cable loss.

Following shows an offset computation example with cable loss 6.5 dB.

Example :

$$\begin{aligned} \text{Offset(dB)} &= \text{RF cable loss(dB)}. \\ &= 6.5 \text{ (dB)} \end{aligned}$$



2.5 Frequency List of Low/Middle/High Channels

5G n77 (15kHz) Channel and Frequency List				
BW [MHz]	Channel/Frequency(MHz)	Lowest	Middle	Highest
50	Channel	631667	633334	635000
	Frequency	3475.01	3500.01	3525.00
40	Channel	631334	633334	635333
	Frequency	3470.01	3500.01	3530.00
30	Channel	631000	633334	635666
	Frequency	3465.00	3500.01	3534.99
25	Channel	630834	633334	635833
	Frequency	3154.17	3500.01	3179.17
20	Channel	630667	633334	636000
	Frequency	3460.02	3500.01	3540
15	Channel	630500	633334	636166
	Frequency	3457.5	3500.01	3542.49
10	Channel	630334	633334	636333
	Frequency	3455.01	3500.01	3545.00

5G n77 (30kHz) Channel and Frequency List				
BW [MHz]	Channel/Frequency(MHz)	Lowest	Middle	Highest
100	Channel		633334	
	Frequency		3500.01	
90	Channel	633000	633334	633668
	Frequency	3495	3500.01	3505.02
80	Channel	632668	633334	634000
	Frequency	3490.02	3500.01	3510
70	Channel	632334	633334	634334
	Frequency	3485.01	3500.01	3515.01
60	Channel	632000	633334	634668
	Frequency	3480	3500.01	3520.02
50	Channel	631667	633334	635000
	Frequency	3475.01	3500.01	3525.00
40	Channel	631334	633334	635333
	Frequency	3470.01	3500.01	3530.00
30	Channel	631000	633334	635666
	Frequency	3465.00	3500.01	3534.99
25	Channel	630834	633334	635833
	Frequency	3154.17	3500.01	3179.17
20	Channel	630667	633334	636000
	Frequency	3460.02	3500.01	3540
15	Channel	630500	633334	636166
	Frequency	3457.5	3500.01	3542.49
10	Channel	630334	633334	636333
	Frequency	3455.01	3500.01	3545.00



5G n78 (15kHz) Channel and Frequency List				
BW [MHz]	Channel/Frequency(MHz)	Lowest	Middle	Highest
50	Channel	631668	633334	635000
	Frequency	3475.02	3500.01	3525
40	Channel	631334	633334	635334
	Frequency	3470.01	3500.01	3530.01
30	Channel	631000	633334	635668
	Frequency	3465	3500.01	3535.02
25	Channel	630834	633334	635834
	Frequency	3462.51	3500.01	3537.51
20	Channel	630668	633334	636000
	Frequency	3460.02	3500.01	3540
15	Channel	630500	633334	636168
	Frequency	3457.5	3500.01	3542.52
10	Channel	630334	633334	636334
	Frequency	3455.01	3500.01	3545.01

5G n78 (30kHz) Channel and Frequency List				
BW [MHz]	Channel/Frequency(MHz)	Lowest	Middle	Highest
100	Channel		633334	
	Frequency		3500.01	
90	Channel	633000	633334	633668
	Frequency	3495	3500.01	3505.02
80	Channel	632668	633334	634000
	Frequency	3490.02	3500.01	3510
70	Channel	632334	633334	634334
	Frequency	3485.01	3500.01	3515.01
60	Channel	632000	633334	634668
	Frequency	3480	3500.01	3520.02
50	Channel	631668	633334	635000
	Frequency	3475.02	3500.01	3525
40	Channel	631334	633334	635334
	Frequency	3470.01	3500.01	3530.01
30	Channel	631000	633334	635668
	Frequency	3465	3500.01	3535.02
25	Channel	630834	633334	635834
	Frequency	3462.51	3500.01	3537.51
20	Channel	630668	633334	636000
	Frequency	3460.02	3500.01	3540
15	Channel	630500	633334	636168
	Frequency	3457.5	3500.01	3542.52
10	Channel	630334	633334	636334
	Frequency	3455.01	3500.01	3545.01

3 Conducted Test Items

3.1 Measuring Instruments

See list of measuring instruments of this test report.

3.2 Test Setup

3.2.1 Conducted Output Power

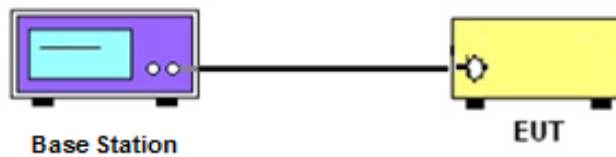

3.2.2 Peak-to-Average Ratio, Occupied / 26dB Bandwidth ,Band-Edge and Conducted Spurious Emission

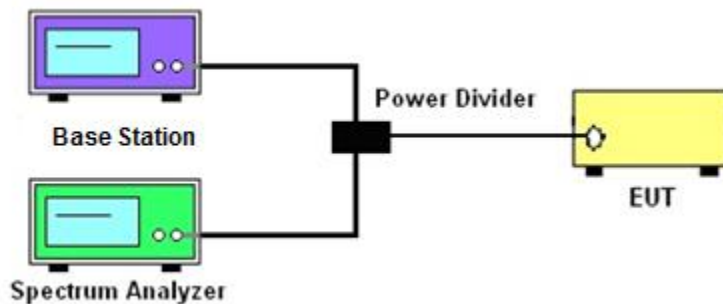

3.2.3 Frequency Stability

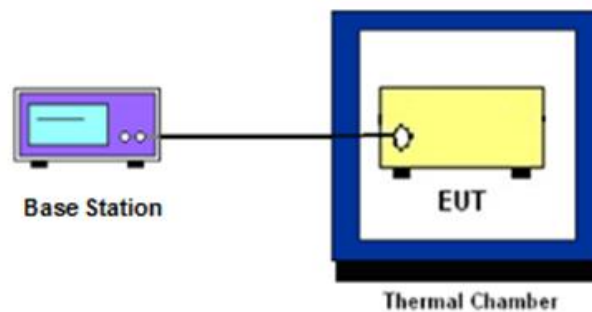

3.3 Test Result of Conducted Test

Please refer to Appendix A.



3.4 Conducted Output Power Measurement

3.4.1 Description of the Conducted Output Power Measurement

A base station simulator was used to establish communication with the EUT. Its parameters were set to transmit the maximum power on the EUT. The measured power in the radio frequency on the transmitter output terminals shall be reported.

3.4.2 Test Procedures

1. The testing follows ANSI C63.26 Section 5.2
2. The transmitter output port was connected to the system simulator.
3. Set EUT at maximum power through the system simulator.
4. Select lowest, middle, and highest channels for each band and different modulation.
5. Measure and record the power level from the system simulator.

3.5 Peak-to-Average Ratio

3.5.1 Description of the PAR Measurement

Power Complementary Cumulative Distribution Function (CCDF) curves provide a means for characterizing the power peaks of a digitally modulated signal on a statistical basis. A CCDF curve depicts the probability of the peak signal amplitude exceeding the average power level. Most contemporary measurement instrumentation include the capability to produce CCDF curves for an input signal provided that the instrument's resolution bandwidth can be set wide enough to accommodate the entire input signal bandwidth. In measuring transmissions in this band using an average power technique, the peak-to-average ratio (PAR) of the transmission may not exceed 13 dB.

3.5.2 Test Procedures

1. The testing follows ANSI C63.26 Section 5.2.3.4 (CCDF).
2. The EUT was connected to spectrum and system simulator via a power divider.
3. Set the CCDF (Complementary Cumulative Distribution Function) option in spectrum analyzer.
4. The highest RF powers were measured and recorded the maximum PAPR level associated with a probability of 0.1 %.
5. Record the deviation as Peak to Average Ratio.

3.6 EIRP

3.6.1 Description of EIRP Limit

§ 27.50 (k)(3)

Mobile devices are limited to 1Watt (30 dBm) EIRP. Mobile devices operating in these bands must employ a means for limiting power to the minimum necessary for successful communications

3.6.2 Test Procedures

1. According to KDB 412172 D01 Power Approach,
2. $EIRP = P_T + G_T - L_C$, $ERP = EIRP - 2.15$, where
 P_T = transmitter output power in dBm
 G_T = gain of the transmitting antenna in dBi
 L_C = signal attenuation in the connecting cable between the transmitter and antenna in dB

3.7 Occupied Bandwidth

3.7.1 Description of Occupied Bandwidth Measurement

The occupied bandwidth is the width of a frequency band such that, below the lower and above the upper frequency limits, the mean powers emitted are each equal to a specified percentage 0.5% of the total mean transmitted power.

The 26 dB emission bandwidth is defined as the frequency range between two points, one above and one below the carrier frequency, at which the spectral density of the emission is attenuated 26 dB below the maximum in-band spectral density of the modulated signal. Spectral density (power per unit bandwidth) is to be measured with a detector of resolution bandwidth equal to approximately 1.0% of the emission bandwidth.

3.7.2 Test Procedures

1. The testing follows ANSI C63.26 Section 5.4
2. The EUT was connected to spectrum analyzer and system simulator via a power divider.
3. The spectrum analyzer center frequency is set to the nominal EUT channel center frequency. The span range for the spectrum analyzer shall be between two and five times the anticipated OBW.
4. The nominal resolution bandwidth (RBW) shall be in the range of 1 to 5 % of the anticipated OBW, and the VBW shall be at least 3 times the RBW.
5. Set the detection mode to peak, and the trace mode to max hold.
6. Determine the reference value: Set the EUT to transmit a modulated signal. Allow the trace to stabilize. Set the spectrum analyzer marker to the highest level of the displayed trace.
(this is the reference value)
7. Determine the “-26 dB down amplitude” as equal to (Reference Value – X).
8. Place two markers, one at the lowest and the other at the highest frequency of the envelope of the spectral display such that each marker is at or slightly below the “-X dB down amplitude” determined in step 6. If a marker is below this “-X dB down amplitude” value it shall be placed as close as possible to this value. The OBW is the positive frequency difference between the two markers.
9. Use the 99 % power bandwidth function of the spectrum analyzer and report the measured bandwidth.

3.8 Conducted Band Edge Measurement

3.8.1 Description of Conducted Band Edge Measurement

§ 27.53 (n)(2)

For mobile operations in the 3450-3550 MHz band, the conducted power of any emission outside the licensee's authorized bandwidth shall not exceed -13 dBm/MHz.

Compliance with this paragraph is based on the use of measurement instrumentation employing a resolution bandwidth of 1 megahertz or greater. However, in the 1 megahertz bands immediately outside and adjacent to the licensee's frequency block, a resolution bandwidth of at least one percent of the emission bandwidth of the fundamental emission of the transmitter may be employed, but limited to a maximum of 200 kHz. In the bands between 1 and 5 MHz removed from the licensee's frequency block, the minimum resolution bandwidth for the measurement shall be 500 kHz.

3.8.2 Test Procedures

1. The testing follows ANSI C63.26 section 5.7
2. The EUT was connected to spectrum analyzer and system simulator via a power divider.
3. The band edges of low and high channels for the highest RF powers were measured.
4. Set RBW \geq 1% EBW but limited to a maximum of 200 kHz in the 1MHz band immediately outside and adjacent to the band edge.
5. Beyond the 1 MHz and 5 MHz removed from the band edge, set RBW \geq 500KHz.
6. Beyond the 5 MHz removed from the band edge, set RBW = 1MHz.
7. Set spectrum analyzer with RMS detector.
8. The RF fundamental frequency should be excluded against the limit line in the operating frequency band.
9. Checked that all the results comply with the emission limit line.

3.9 Conducted Spurious Emission Measurement

3.9.1 Description of Conducted Spurious Emission Measurement

The power of any emission outside of the authorized operating frequency ranges shall not exceed -13 dBm/MHz.

It is measured by means of a calibrated spectrum analyzer and scanned from 9 kHz up to a frequency including its 10th harmonic.

3.9.2 Test Procedures

1. The testing follows ANSI C63.26 section 5.7
2. The EUT was connected to spectrum analyzer and system simulator via a power divider.
3. The RF output of EUT was connected to the spectrum analyzer by RF cable and attenuator. The path loss was compensated to the results for each measurement.
4. The middle channel for the highest RF power within the transmitting frequency was measured.
5. The conducted spurious emission for the whole frequency range was taken.
6. Make the measurement with the spectrum analyzer's RBW = 1MHz, VBW = 3MHz.
7. Set spectrum analyzer with RMS detector.
8. Taking the record of maximum spurious emission.
9. The RF fundamental frequency should be excluded against the limit line in the operating frequency band.
10. Checked that all the results comply with the emission limit line.

3.10 Frequency Stability Measurement

3.10.1 Description of Frequency Stability Measurement

The frequency stability shall be measured by variation of ambient temperature and variation of primary supply voltage to ensure that the fundamental emission stays within the authorized frequency block.

3.10.2 Test Procedures for Temperature Variation

1. The testing follows ANSI C63.26 section 5.6.4
2. The EUT was set up in the thermal chamber and connected with the system simulator.
3. With power OFF, the temperature was decreased to -30°C and the EUT was stabilized before testing. Power was applied and the maximum change in frequency was recorded within one minute.
4. With power OFF, the temperature was raised in 10°C step up to 50°C . The EUT was stabilized at each step for at least half an hour. Power was applied and the maximum frequency change was recorded within one minute.

3.10.3 Test Procedures for Voltage Variation

1. The testing follows ANSI C63.26 section 5.6.5.
2. The EUT was placed in a temperature chamber at $20\pm 5^{\circ}\text{C}$ and connected with the system simulator.
3. The power supply voltage to the EUT was varied from 85% to 115% of the nominal value for other than hand carried battery equipment.
4. For hand carried, battery powered equipment, reduce the primary ac or dc supply voltage to the battery operating end point, which shall be specified by the manufacturer.
5. The variation in frequency was measured for the worst case.

4 Radiated Test Items

4.1 Measuring Instruments

See list of measuring instruments of this test report.

4.2 Test Setup

4.2.1 For radiated test below 30MHz

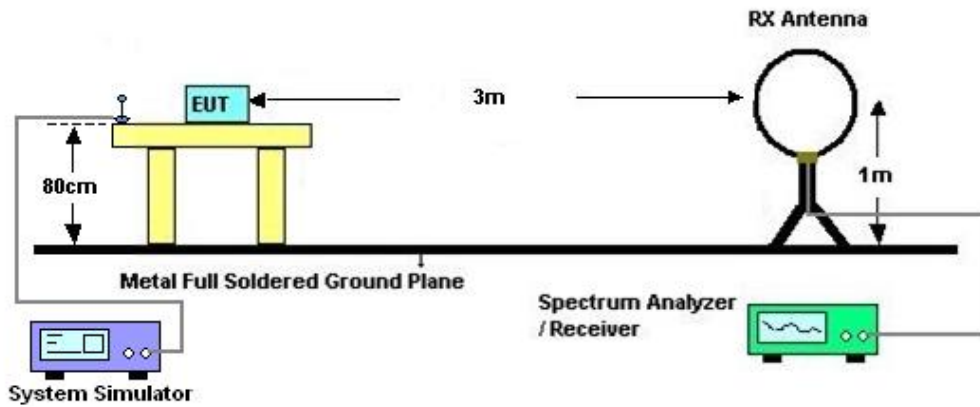

4.2.2 For radiated test from 30MHz to 1GHz

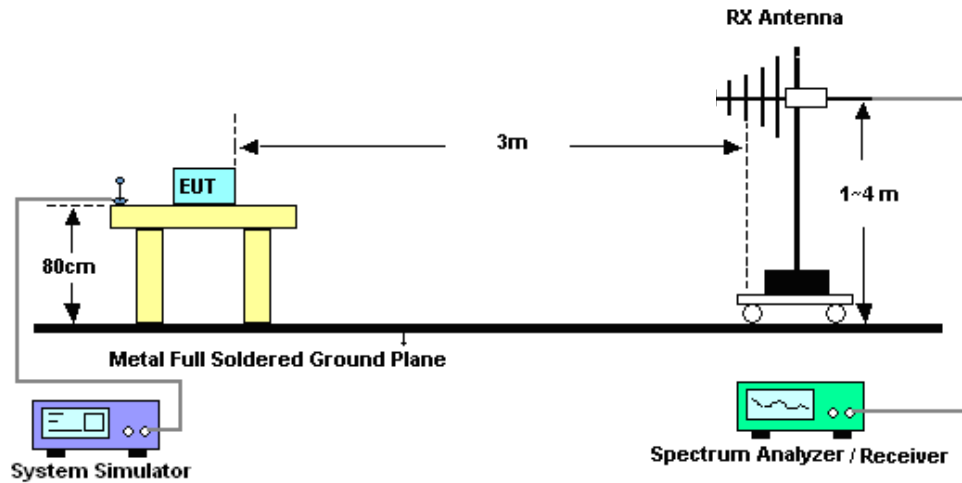

4.2.3 For radiated test above 1GHz

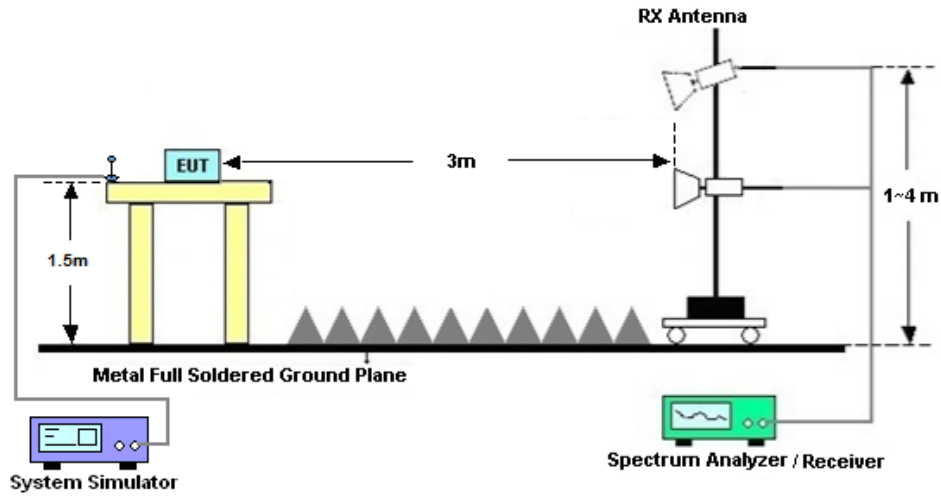

4.3 Test Result of Radiated Test

The low frequency, which started from 9 kHz to 30MHz, was pre-scanned and the result which was 20dB lower than the limit line was not reported.

Please refer to Appendix B.

4.4 Radiated Spurious Emission Measurement

4.4.1 Description of Radiated Spurious Emission

The radiated spurious emission was measured by substitution method according to ANSI/TIA-603-E. The power of any emission outside of the authorized operating frequency ranges shall not exceed -13 dBm/MHz.

The spectrum is scanned from 30 MHz up to a frequency including its 10th harmonic.

4.4.2 Test Procedures

1. The testing follows ANSI C63.26 Section 5.5
2. The EUT was placed on a turntable with 0.8 meter height for frequency below 1GHz and 1.5 meter height for frequency above 1GHz respectively above ground.
3. The EUT was set 3 meters from the receiving antenna mounted on the antenna tower.
4. The table was rotated 360 degrees to determine the position of the highest spurious emission.
5. The height of the receiving antenna is varied between 1m to 4m to search the maximum spurious emission for both horizontal and vertical polarizations.
6. During the measurement, the system simulator parameters were set to force the EUT transmitting at maximum output power.
7. Make the measurement with the spectrum analyzer's RBW = 1MHz, VBW = 3MHz, taking the record of maximum spurious emission.
8. A horn antenna was substituted in place of the EUT and was driven by a signal generator.
9. Tune the output power of signal generator to the same emission level with EUT maximum spurious emission.
$$\text{EIRP (dBm)} = \text{S.G. Power} - \text{Tx Cable Loss} + \text{Tx Antenna Gain}$$
$$\text{ERP (dBm)} = \text{EIRP} - 2.15$$
10. The RF fundamental frequency should be excluded against the limit line in the operating frequency band.



5 List of Measuring Equipment

Instrument	Manufacturer	Model No.	Serial No.	Characteristics	Calibration Date	Test Date	Due Date	Remark
Spectrum Analyzer	R&S	FSV40	101040	10Hz~40GHz	Oct. 14, 2021	Mar. 25, 2022~ Apr. 03, 2022	Oct. 13, 2022	Conducted (TH01-KS)
Power divider	STI	STI08-0055	-	0.5~40GHz	Aug. 26, 2021	Mar. 25, 2022~ Apr. 03, 2022	Aug. 25, 2022	Conducted (TH01-KS)
Temperature & humidity chamber	Hongzhan	LP-150U	H2014011440	-40~+150°C 20%~95%RH	Jul. 12, 2021	Mar. 25, 2022~ Apr. 03, 2022	Jul. 11, 2022	Conducted (TH01-KS)
EXA Spectrum Analyzer	Keysight	N9010A	MY55150244	10Hz-44G,MAX 30dB	Apr. 13, 2021	Apr. 11, 2022	Apr. 12, 2022	Radiation (03CH04-KS)
Loop Antenna	R&S	HFH2-Z2	100321	9kHz~30MHz	Oct. 30, 2021	Apr. 11, 2022	Oct. 29, 2022	Radiation (03CH04-KS)
Bilog Antenna	TeseQ	CBL6111D	49922	30MHz-1GHz	May 30, 2021	Apr. 11, 2022	May 29, 2022	Radiation (03CH04-KS)
Horn Antenna	Schwarzbeck	BBHA9120D	1356	1GHz~18GHz	Apr. 18, 2021	Apr. 11, 2022	Apr. 17, 2022	Radiation (03CH04-KS)
SHF-EHF Horn	Com-power	AH-840	101070	18GHz~40GHz	Jan. 05, 2022	Apr. 11, 2022	Jan. 04, 2023	Radiation (03CH04-KS)
Amplifier	SONOMA	310N	187289	9KHz-1GHz	Jan. 05, 2022	Apr. 11, 2022	Jan. 04, 2023	Radiation (03CH04-KS)
Amplifier	MITEQ	EM18G40G GA	060728	18~40GHz	Jan. 05, 2022	Apr. 11, 2022	Jan. 04, 2023	Radiation (03CH04-KS)
high gain Amplifier	MITEQ	AMF-7D-00 101800-30-1 0P	2025788	1Ghz-18Ghz	Jul. 30, 2021	Apr. 11, 2022	Jul. 29, 2022	Radiation (03CH04-KS)
Amplifier	Keysight	83017A	MY57280106	500MHz~26.5GHz	Oct. 13, 2021	Apr. 11, 2022	Oct. 12, 2022	Radiation (03CH04-KS)
AC Power Source	Chroma	61601	F104090004	N/A	NCR	Apr. 11, 2022	NCR	Radiation (03CH04-KS)
Turn Table	ChamPro	EM 1000-T	060762-T	0~360 degree	NCR	Apr. 11, 2022	NCR	Radiation (03CH04-KS)
Antenna Mast	ChamPro	EM 1000-A	060762-A	1 m~4 m	NCR	Apr. 11, 2022	NCR	Radiation (03CH04-KS)

NCR: No Calibration Required

6 Uncertainty of Evaluation

The measurement uncertainties shown below were calculated in accordance with the requirements of ANSI 63.26-2015. All the measurement uncertainty value were shown with a coverage $K=2$ to indicate 95% level of confidence. The measurement data show herein meets or exceeds the CISPR measurement uncertainty values specified in CISPR 16-4-2 and can be compared directly to specified limit to determine compliance.

Uncertainty of Radiated Emission Measurement (30 MHz ~ 1000 MHz)

Measuring Uncertainty for a Level of Confidence of 95% ($U = 2Uc(y)$)	3.3dB
---	-------

Uncertainty of Radiated Emission Measurement (1 GHz ~ 40 GHz)

Measuring Uncertainty for a Level of Confidence of 95% ($U = 2Uc(y)$)	2.8dB
---	-------



Appendix A. Test Results of Conducted Test

Test Engineer :	Jason Zhang	Temperature :	24~26°C
		Relative Humidity :	50~53%



FR1 N77-15K

Transmitter Conducted Output Power And EIRP, (GT-LC)=1.10dB

BW [MHz]	Modulation	RB Size	RB Offset	Power Low Ch. / Freq.	Power Middle Ch. / Freq.	Power High Ch. / Freq.	Gain	EIRP	EIRP	EIRP
Channel				631667	633334	635000		L	M	H
Frequency (MHz)				3475.01	3500.01	3525.00				
50	PI/2 BPSK	1	1	24.90	24.94	24.97	1.10	0.3981	0.4018	0.4046
50	PI/2 BPSK	1	268	24.99	25.04	24.54	1.10	0.4064	0.4111	0.3664
50	PI/2 BPSK	135	67	25.15	25.11	25.05	1.10	0.4217	0.4178	0.4121
50	PI/2 BPSK	270	0	24.55	24.64	24.23	1.10	0.3673	0.3750	0.3412
50	QPSK	1	1	24.84	24.95	24.24	1.10	0.3926	0.4027	0.3420
50	QPSK	1	268	24.91	25.04	24.56	1.10	0.3990	0.4111	0.3681
50	QPSK	135	67	25.15	25.12	24.47	1.10	0.4217	0.4188	0.3606
50	QPSK	270	0	24.11	24.08	24.04	1.10	0.3319	0.3296	0.3266
50	16QAM	1	1	23.98	24.01	23.87	1.10	0.3221	0.3243	0.3141
50	64QAM	1	1	22.34	22.35	21.77	1.10	0.2208	0.2213	0.1936
50	256QAM	1	1	20.64	20.69	20.41	1.10	0.1493	0.1510	0.1416
Channel				631334	633334	635333	Gain	EIRP	EIRP	EIRP
Frequency (MHz)				3470.01	3500.01	3530.00				
40	PI/2 BPSK	1	1	24.66	24.87	24.52	1.10	0.3767	0.3954	0.3648
Channel				631000	633334	635666	Gain	EIRP	EIRP	EIRP
Frequency (MHz)				3465.00	3500.01	3534.99				
30	PI/2 BPSK	1	1	24.94	24.77	24.85	1.10	0.4018	0.3864	0.3936
Channel				630834	633334	635833	Gain	EIRP	EIRP	EIRP
Frequency (MHz)				3154.17	3500.01	3179.17				
25	PI/2 BPSK	1	1	25.10	24.85	24.78	1.10	0.4169	0.3936	0.3873
Channel				630667	633334	636000	Gain	EIRP	EIRP	EIRP
Frequency (MHz)				3460.02	3500.01	3540				
20	PI/2 BPSK	1	1	24.69	24.23	25.09	1.10	0.3793	0.3412	0.4159
Channel				630500	633334	636166	Gain	EIRP	EIRP	EIRP
Frequency (MHz)				3457.5	3500.01	3542.49				
15	PI/2 BPSK	1	1	25.07	24.97	25.02	1.10	0.4140	0.4046	0.4093
Channel				630334	633334	636333	Gain	EIRP	EIRP	EIRP
Frequency (MHz)				3455.01	3500.01	3545.00				
10	PI/2 BPSK	1	1	24.61	25.01	25.11	1.10	0.3724	0.4083	0.4178



FR1 N77-30K

Transmitter Conducted Output Power And EIRP, (GT-LC)=1.10dB

BW [MHz]	Modulation	RB Size	RB Offset	Power Low Ch. / Freq.	Power Middle Ch. / Freq.	Power High Ch. / Freq.	Gain	EIRP	EIRP	EIRP
Channel				633334	633334	633334		L	M	H
Frequency (MHz)				3500.01	3500.01	3500.01				
100	PI/2 BPSK	1	1		24.65		1.10		0.3758	
100	PI/2 BPSK	1	137		25.26		1.10		0.4325	
100	PI/2 BPSK	1	271		24.72		1.10		0.3819	
100	PI/2 BPSK	135	0		24.53		1.10		0.3656	
100	PI/2 BPSK	135	67		25.17		1.10		0.4236	
100	PI/2 BPSK	135	138		24.71		1.10		0.3811	
100	PI/2 BPSK	270	0		24.47		1.10		0.3606	
100	QPSK	1	1		24.64		1.10		0.3750	
100	QPSK	1	137		25.21		1.10		0.4276	
100	QPSK	1	271		24.68		1.10		0.3784	
100	QPSK	135	0		24.02		1.10		0.3251	
100	QPSK	135	67		25.20		1.10		0.4266	
100	QPSK	135	138		24.13		1.10		0.3334	
100	QPSK	270	0		24.14		1.10		0.3342	
100	16QAM	1	1		23.57		1.10		0.2931	
100	64QAM	1	1		22.27		1.10		0.2173	
100	256QAM	1	1		20.34		1.10		0.1393	
Channel				633000	633334	633668	Gain	EIRP	EIRP	EIRP
Frequency (MHz)				3495	3500.01	3505.02				
90	PI/2 BPSK	1	1	24.58	24.61	24.63	1.10	0.3698	0.3724	0.3741
Channel				632668	633334	634000	Gain	EIRP	EIRP	EIRP
Frequency (MHz)				3490.02	3500.01	3510				
80	PI/2 BPSK	1	1	24.90	24.96	24.93	1.10	0.3981	0.4036	0.4009
Channel				632334	633334	634334	Gain	EIRP	EIRP	EIRP
Frequency (MHz)				3485.01	3500.01	3515.01				
70	PI/2 BPSK	1	1	24.80	24.91	24.69	1.10	0.3890	0.3990	0.3793
Channel				632000	633334	634668	Gain	EIRP	EIRP	EIRP
Frequency (MHz)				3480	3500.01	3520.02				
60	PI/2 BPSK	1	1	24.86	24.85	24.78	1.10	0.3945	0.3936	0.3873
Channel				631668	633334	635000	Gain	EIRP	EIRP	EIRP
Frequency (MHz)				3475.02	3500.01	3525				
50	PI/2 BPSK	1	1	24.93	24.90	24.76	1.10	0.4009	0.3981	0.3855
Channel				631334	633334	635334	Gain	EIRP	EIRP	EIRP
Frequency (MHz)				3470.01	3500.01	3530.01				
40	PI/2 BPSK	1	1	24.73	24.60	24.68	1.10	0.3828	0.3715	0.3784



Channel				631000	633334	635668	Gain	EIRP	EIRP	EIRP
Frequency (MHz)				3465	3500.01	3535.02				
30	PI/2 BPSK	1	1	24.76	24.81	24.73	1.10	0.3855	0.3899	0.3828
Channel				630834	633334	635834	Gain	EIRP	EIRP	EIRP
Frequency (MHz)				3462.51	3500.01	3537.51				
25	PI/2 BPSK	1	1	25.06	24.94	24.82	1.10	0.4130	0.4018	0.3908
Channel				630668	633334	636000	Gain	EIRP	EIRP	EIRP
Frequency (MHz)				3460.02	3500.01	3540				
20	PI/2 BPSK	1	1	25.09	24.95	24.92	1.10	0.4159	0.4027	0.3999
Channel				630500	633334	636168	Gain	EIRP	EIRP	EIRP
Frequency (MHz)				3457.5	3500.01	3542.52				
15	PI/2 BPSK	1	1	25.02	24.89	24.97	1.10	0.4093	0.3972	0.4046
Channel				630334	633334	636334	Gain	EIRP	EIRP	EIRP
Frequency (MHz)				3455.01	3500.01	3545.01				
10	PI/2 BPSK	1	1	24.96	24.89	24.85	1.10	0.4036	0.3972	0.3936



FR1 N78-15K

Transmitter Conducted Output Power And EIRP, (GT-LC)=1.10dB

BW [MHz]	Modulation	RB Size	RB Offset	Power Low Ch. / Freq.	Power Middle Ch. / Freq.	Power High Ch. / Freq.	Gain	EIRP	EIRP	EIRP
Channel				631667	633334	635000		L	M	H
Frequency (MHz)				3475.02	3500.01	3525				
50	PI/2 BPSK	1	1	27.46	27.49	27.53	1.10	0.7178	0.7228	0.7295
50	PI/2 BPSK	1	268	27.42	27.34	27.38	1.10	0.7112	0.6982	0.7047
50	PI/2 BPSK	135	67	27.56	27.54	27.64	1.10	0.7345	0.7311	0.7482
50	PI/2 BPSK	270	0	26.92	26.89	26.99	1.10	0.6339	0.6295	0.6442
50	QPSK	1	1	27.44	27.38	27.42	1.10	0.7145	0.7047	0.7112
50	QPSK	1	268	27.53	27.50	27.55	1.10	0.7295	0.7244	0.7328
50	QPSK	135	67	27.61	27.52	27.56	1.10	0.7430	0.7278	0.7345
50	QPSK	270	0	26.56	26.52	26.48	1.10	0.5834	0.5781	0.5728
50	16QAM	1	1	26.38	26.32	26.44	1.10	0.5598	0.5521	0.5675
50	64QAM	1	1	25.10	25.06	25.16	1.10	0.4169	0.4130	0.4227
50	256QAM	1	1	23.09	23.10	23.21	1.10	0.2624	0.2630	0.2698
Channel				631334	633334	635333	Gain	EIRP	EIRP	EIRP
Frequency (MHz)				3470.01	3500.01	3530.01				
40	PI/2 BPSK	1	1	27.38	27.33	27.42	1.10	0.7047	0.6966	0.7112
Channel				631000	633334	635667	Gain	EIRP	EIRP	EIRP
Frequency (MHz)				3465	3500.01	3535.02				
30	PI/2 BPSK	1	1	27.39	27.23	27.31	1.10	0.7063	0.6808	0.6934
Channel				630834	633334	635833	Gain	EIRP	EIRP	EIRP
Frequency (MHz)				3462.51	3500.01	3537.51				
25	PI/2 BPSK	1	1	27.13	27.22	27.35	1.10	0.6653	0.6792	0.6998
Channel				630667	633334	636000	Gain	EIRP	EIRP	EIRP
Frequency (MHz)				3460.02	3500.01	3540				
20	PI/2 BPSK	1	1	27.19	27.26	27.23	1.10	0.6745	0.6855	0.6808
Channel				630500	633334	636166	Gain	EIRP	EIRP	EIRP
Frequency (MHz)				3457.5	3500.01	3542.52				
15	PI/2 BPSK	1	1	27.16	27.25	27.23	1.10	0.6699	0.6839	0.6808
Channel				630334	633334	636333	Gain	EIRP	EIRP	EIRP
Frequency (MHz)				3455.01	3500.01	3545.01				
10	PI/2 BPSK	1	1	27.29	27.33	27.42	1.10	0.6902	0.6966	0.7112



FR1 n78

Peak-to-Average Ratio

Mode	FR1 n78 / 50MHz / DFT-S OFDM				
Mod.	50M				Limit: 13dB
RB Size	BPSK	QPSK	16QAM	64QAM	Result
Middle CH	5.32	5.19	5.46	5.35	PASS
RB Size	256QAM				
Middle CH	5.25				

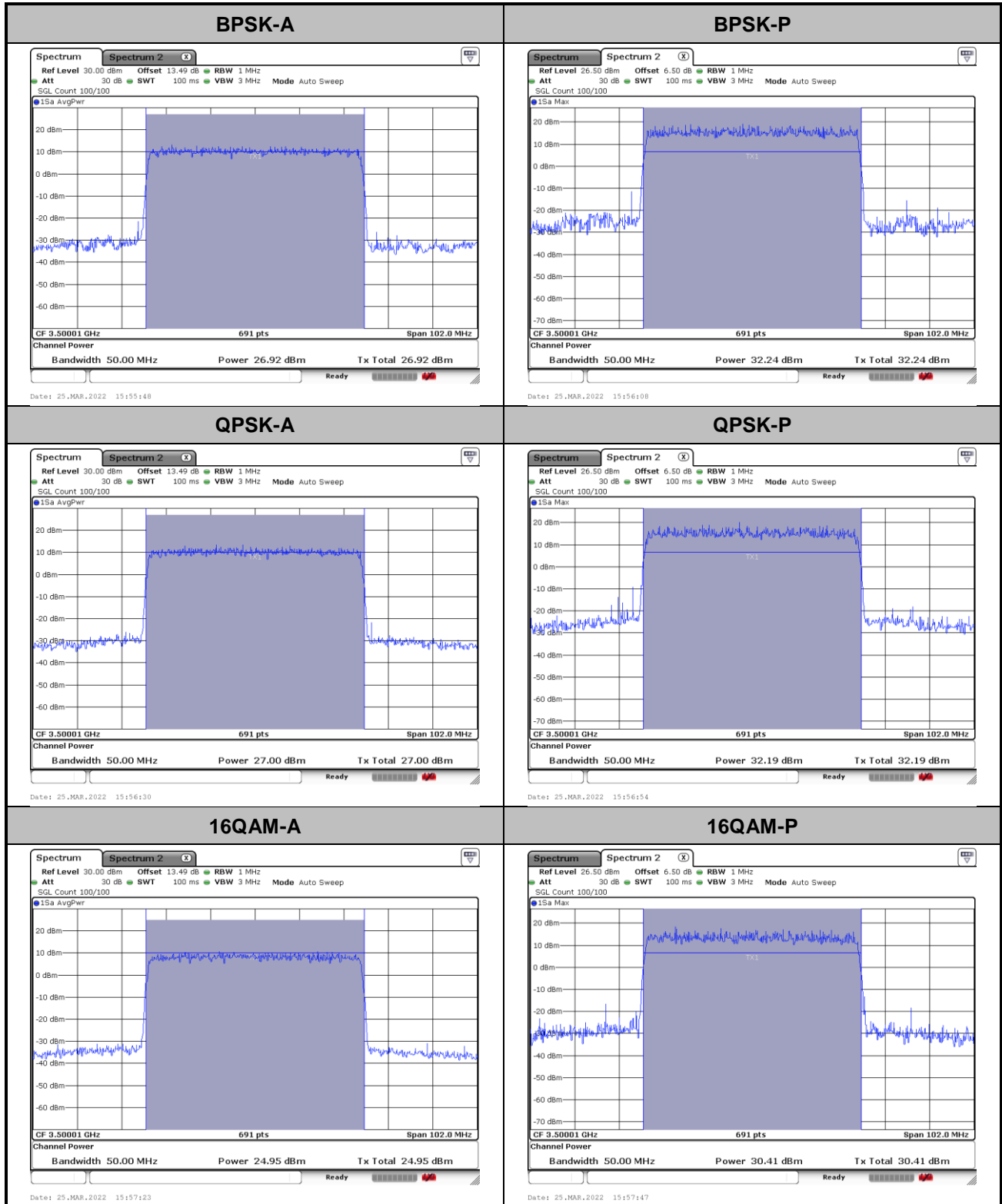

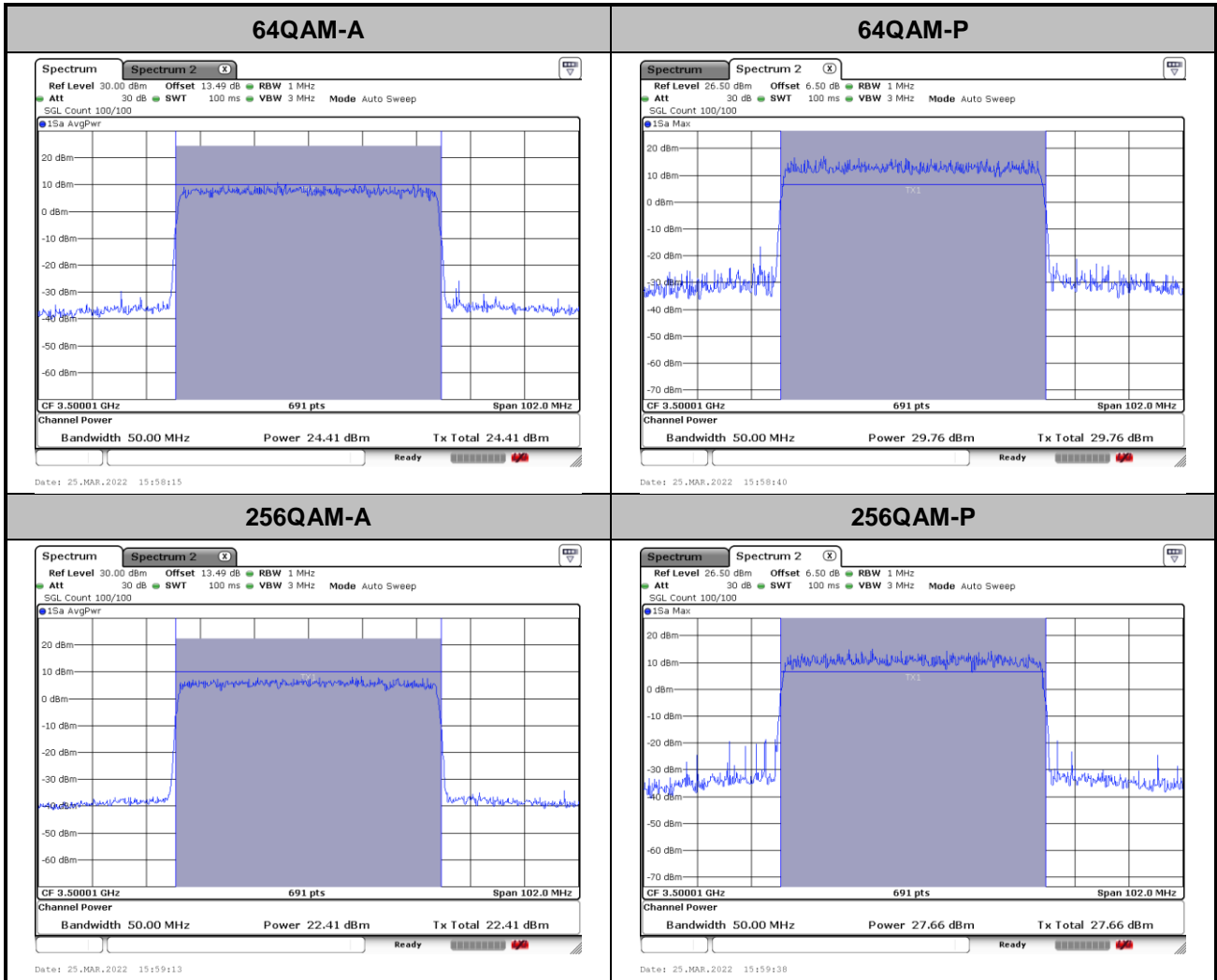



26dB Bandwidth

Mode	FR1 n78 : 26dB BW(MHz) / DFT-S OFDM	
BW	DFT 50MHz	
Mod.	QPSK	16QAM
Middle CH	50.55	50.75

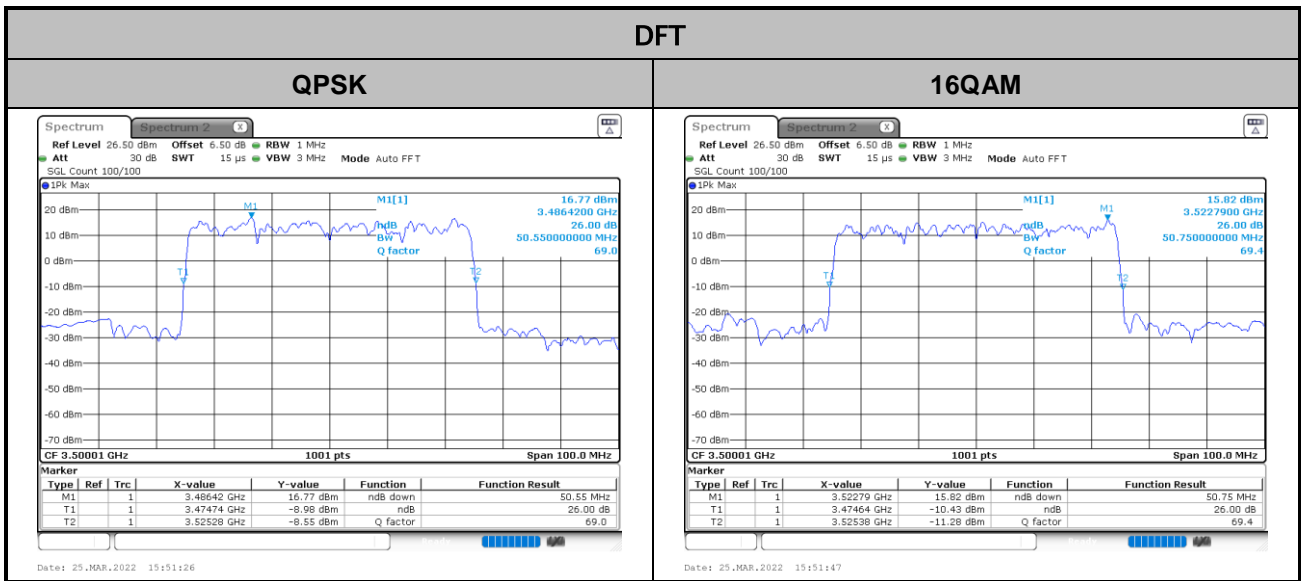



Occupied Bandwidth

Mode	FR1 n78: OB BW(MHz) / DFT-S OFDM	
BW	DFT 50MHz	
Mod.	QPSK	16QAM
Middle CH	48.35	48.25

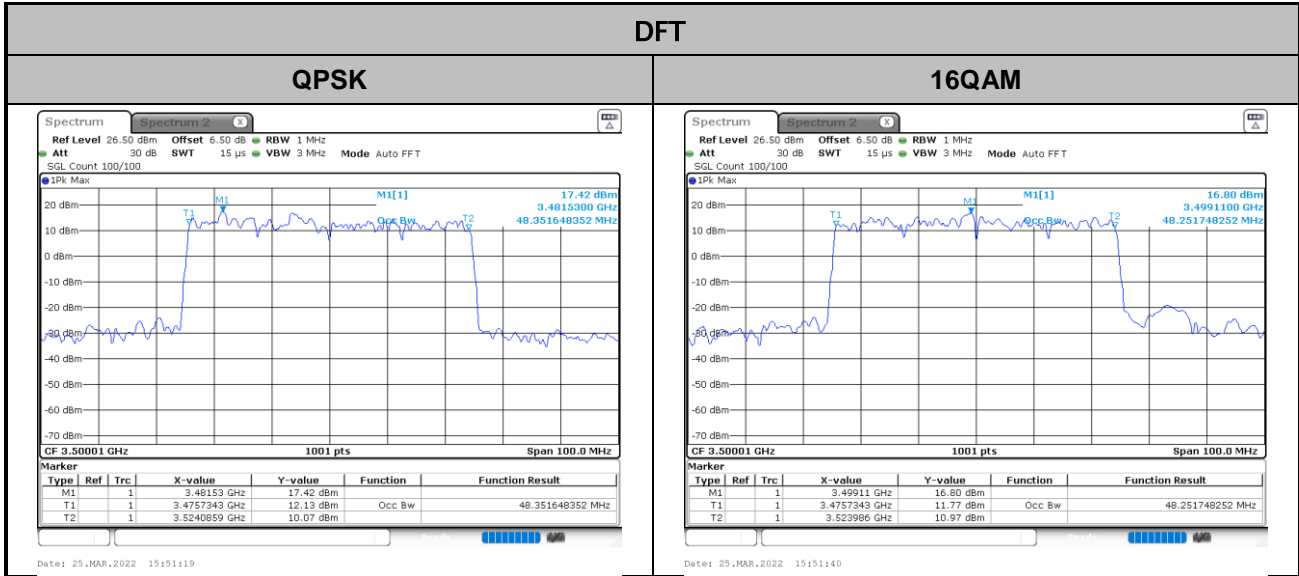



Conducted Band Edge

FR1 n78 / 10MHz / DFT-S OFDM / PI/2 BPSK

Lowest Band Edge / 1RB0

Highest Band Edge / 1RBmax

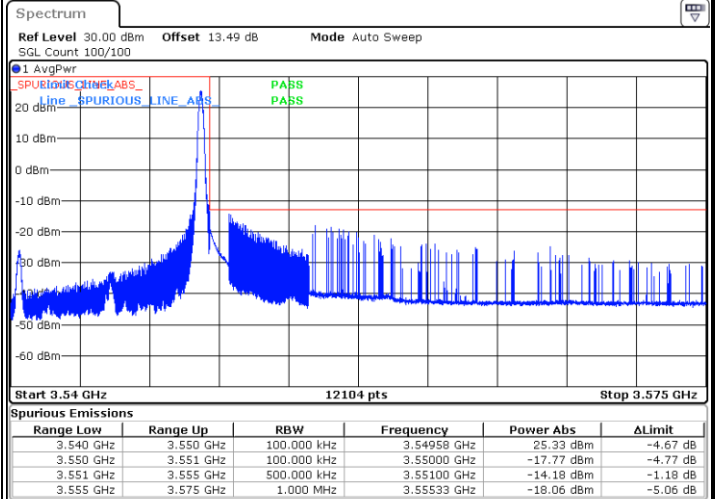
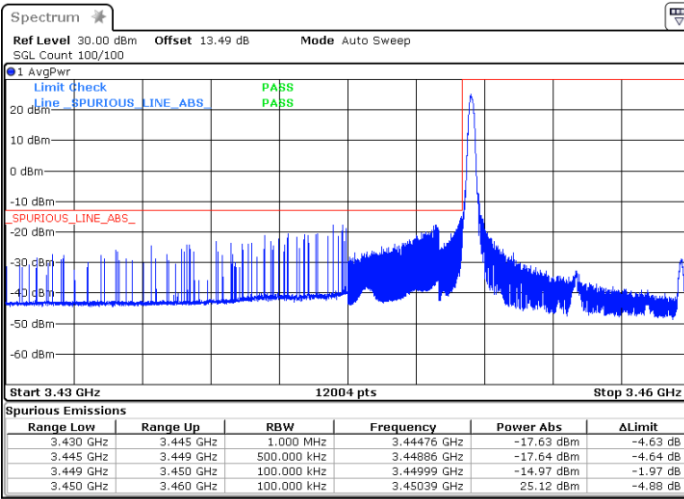

Date: 3.APR.2022 15:11:28

Date: 3.APR.2022 15:29:53

Lowest Band Edge / Full RB

Highest Band Edge / Full RB

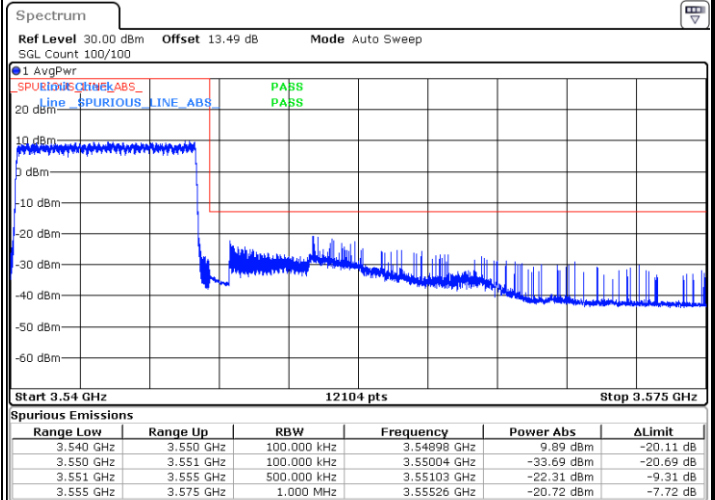
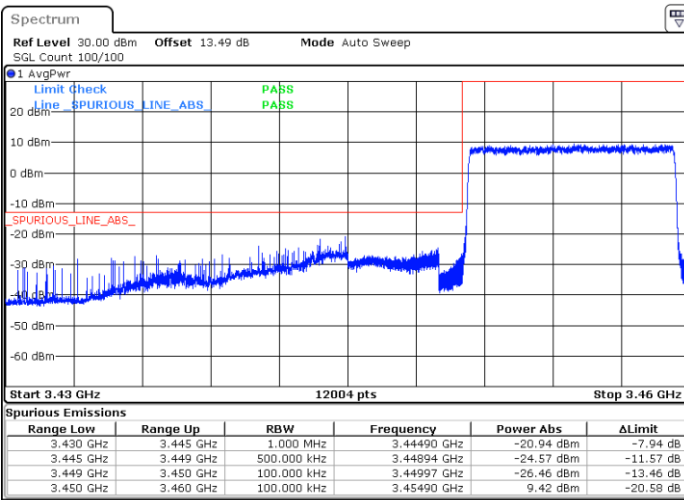

Date: 3.APR.2022 15:21:20

Date: 3.APR.2022 15:22:56



FR1 n78 / 10MHz / DFT-S OFDM / QPSK

Lowest Band Edge / 1RB0

Highest Band Edge / 1RBmax

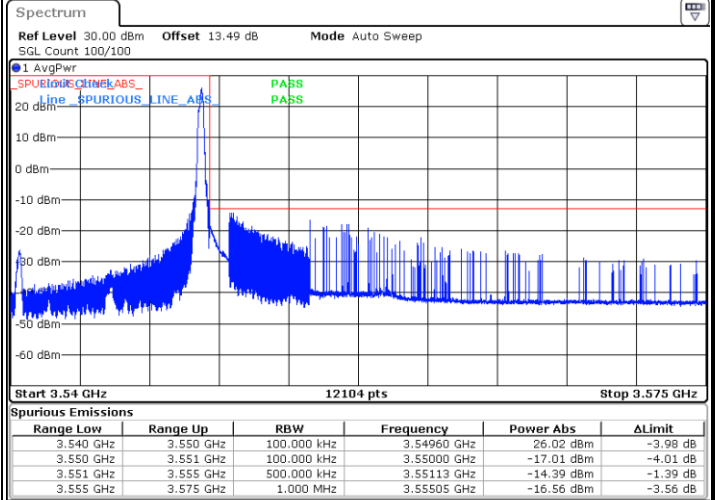
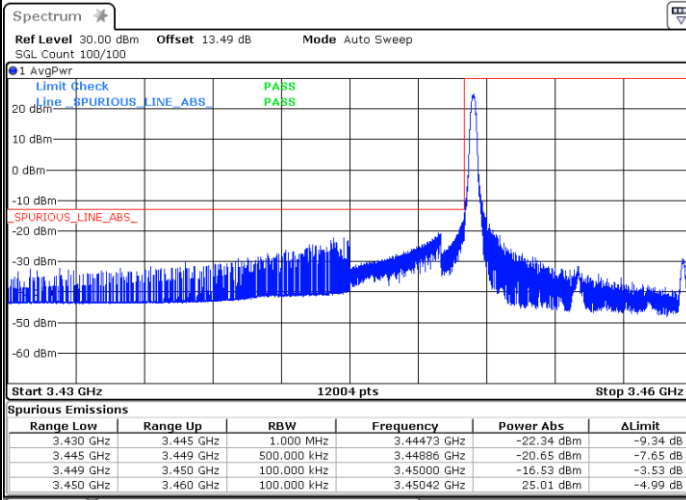

Date: 3.APR.2022 15:09:54

Date: 3.APR.2022 15:29:05

Lowest Band Edge / Full RB

Highest Band Edge / Full RB

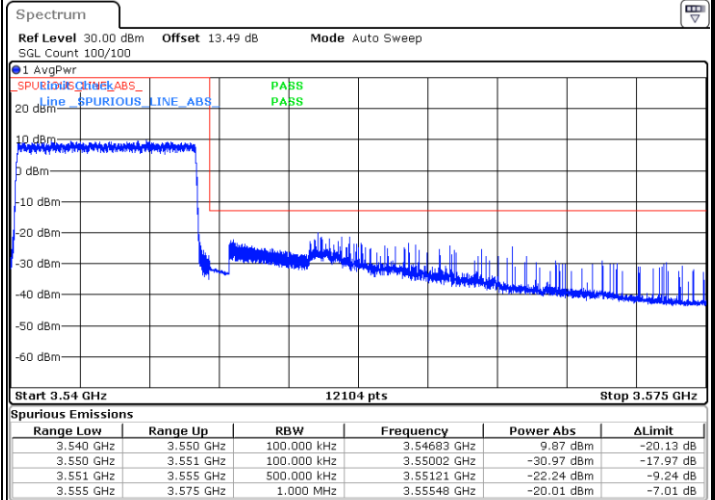
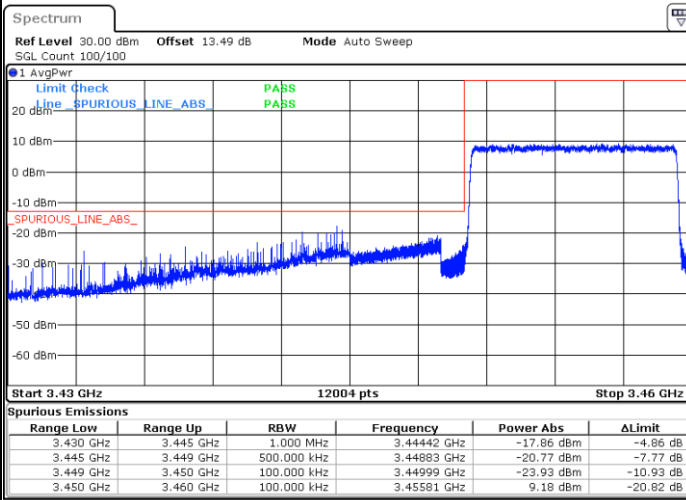

Date: 3.APR.2022 15:20:32

Date: 3.APR.2022 15:23:39



FR1 n78/ 10MHz / DFT-S OFDM / 16Q

Lowest Band Edge / 1RB0

Highest Band Edge / 1RBmax

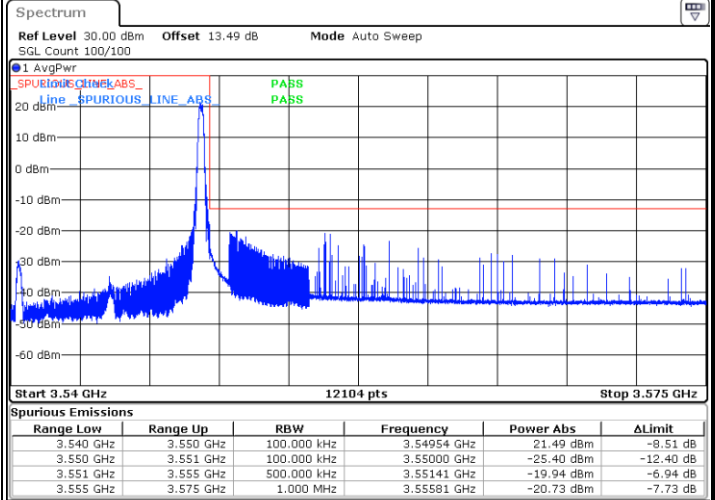
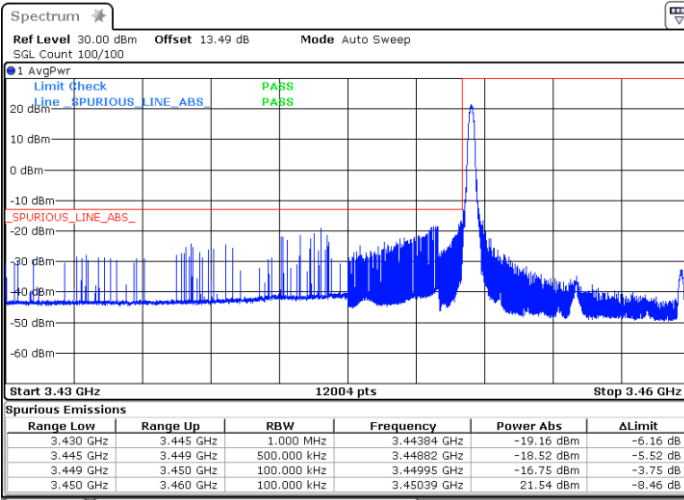

Date: 3.APR.2022 15:13:07

Date: 3.APR.2022 15:28:24

Lowest Band Edge / Full RB

Highest Band Edge / Full RB

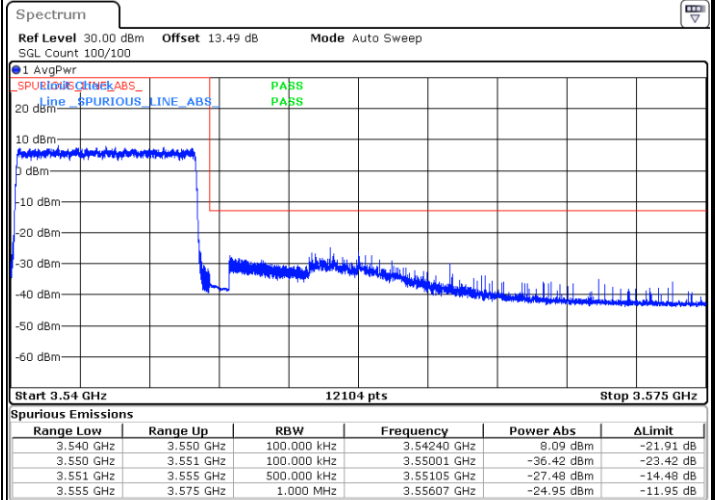
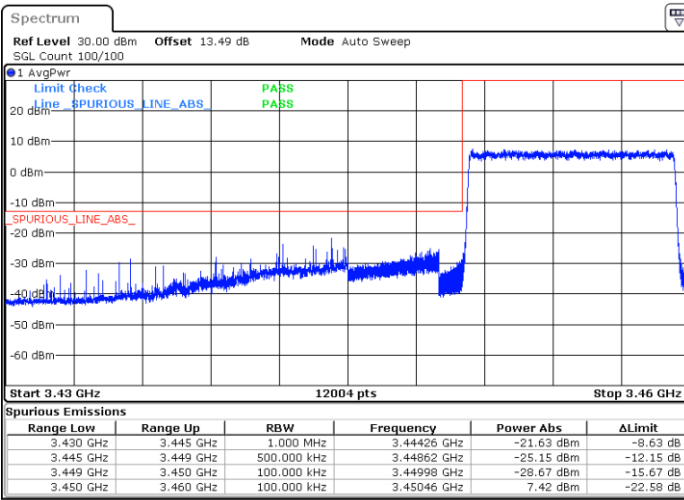

Date: 3.APR.2022 15:19:51

Date: 3.APR.2022 15:24:21



FR1 n78 / 10MHz / DFT-S OFDM / 64Q

Lowest Band Edge / 1RB0

Highest Band Edge / 1RBmax

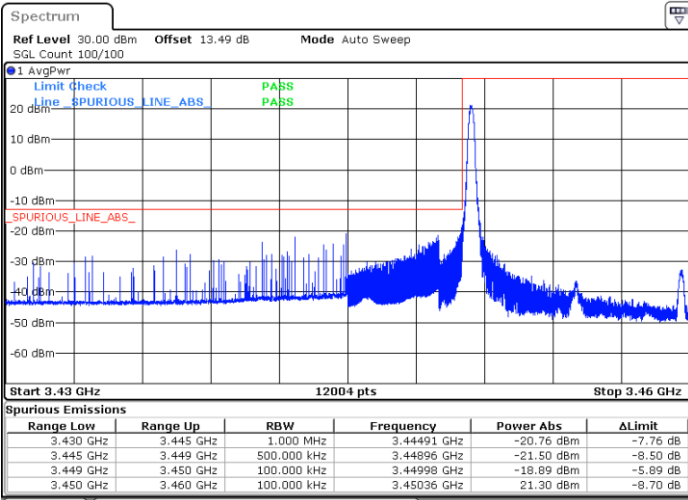

Date: 3.APR.2022 15:16:22

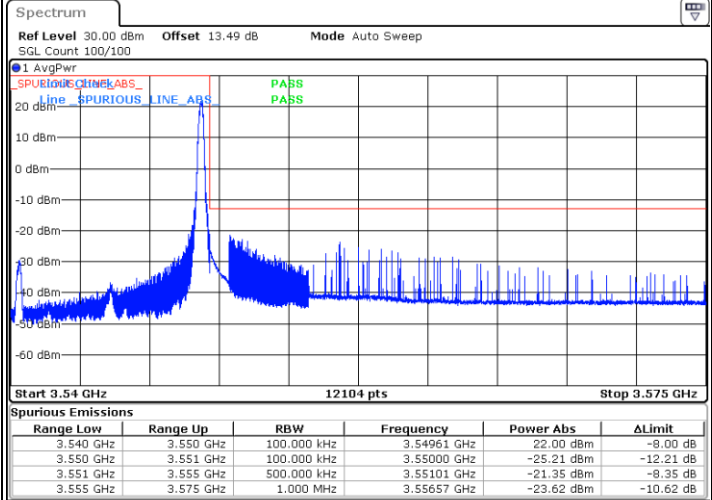

Date: 3.APR.2022 15:27:41

Lowest Band Edge / Full RB

Highest Band Edge / Full RB

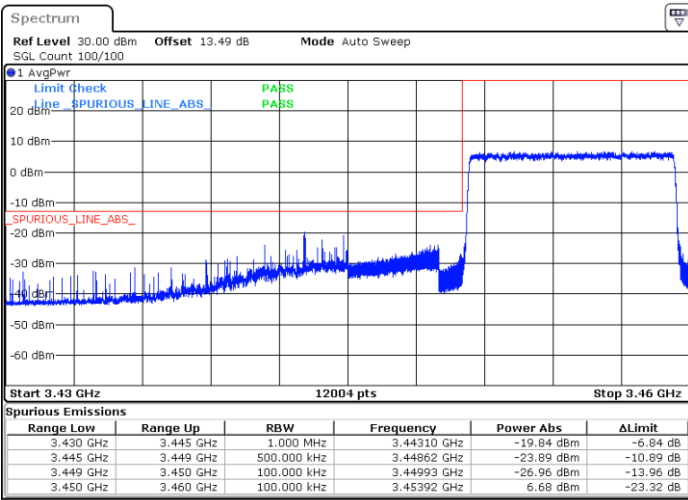

Date: 3.APR.2022 15:19:07

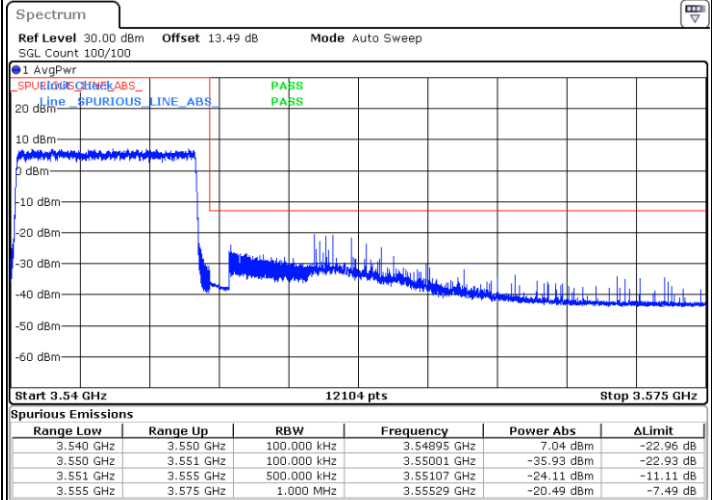

Date: 3.APR.2022 15:25:04



FR1 n78/ 10MHz / DFT-S OFDM / 256Q

Lowest Band Edge / 1RB0

Highest Band Edge / 1RBmax

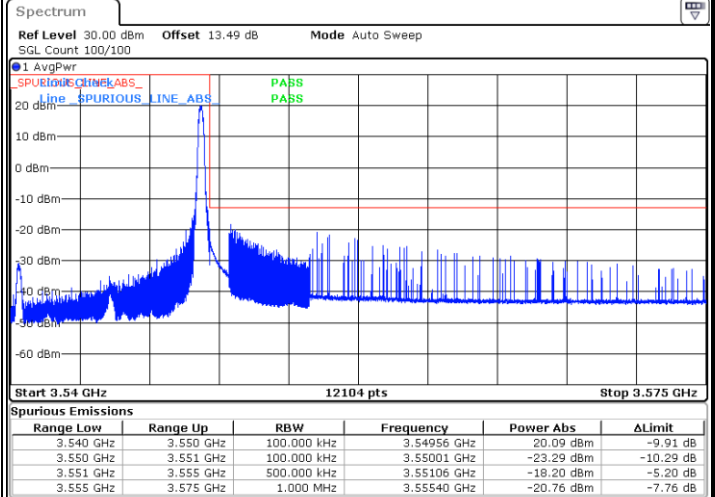
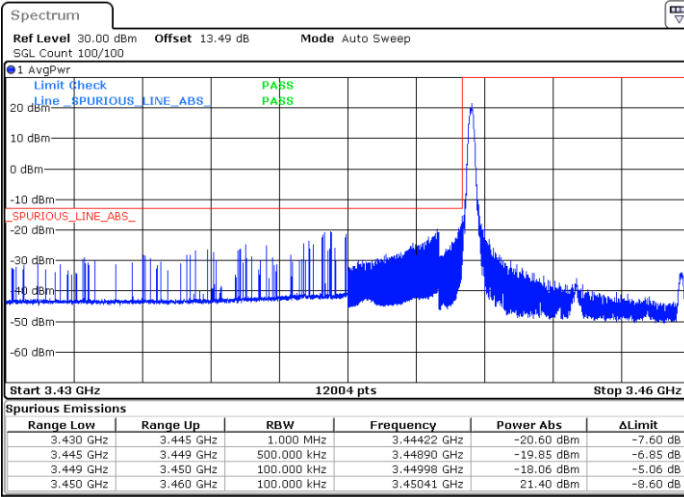

Date: 3.APR.2022 15:17:20

Date: 3.APR.2022 15:26:52

Lowest Band Edge / Full RB

Highest Band Edge / Full RB

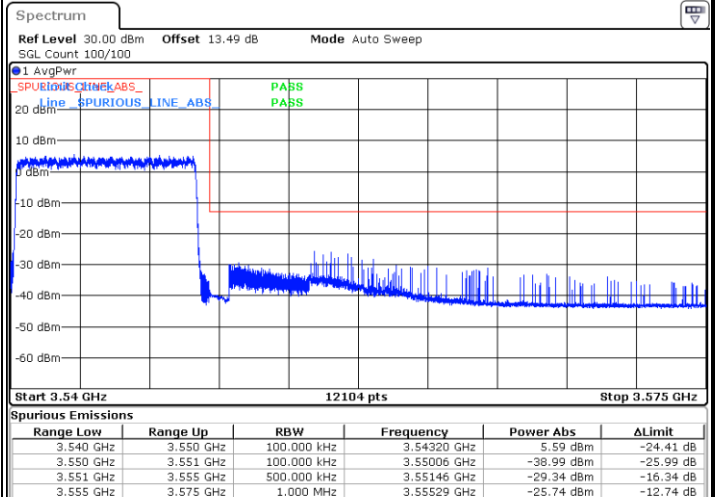
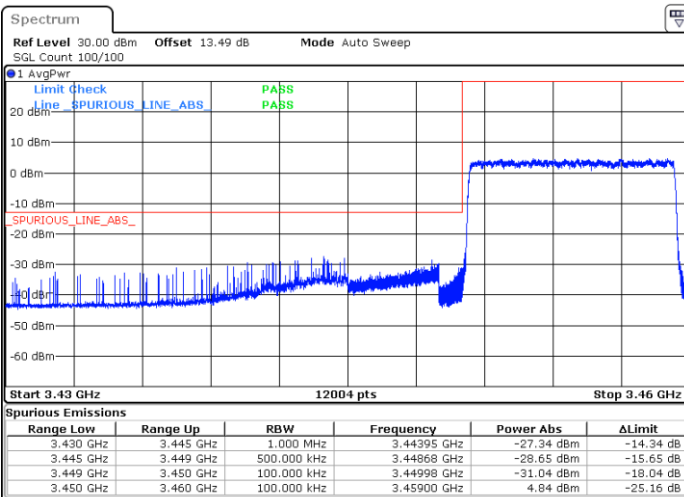

Date: 3.APR.2022 15:18:11

Date: 3.APR.2022 15:25:53



FR1 n78 / 15MHz / DFT-S OFDM / PI/2 BPSK

Lowest Band Edge / 1RB0

Highest Band Edge / 1RBmax

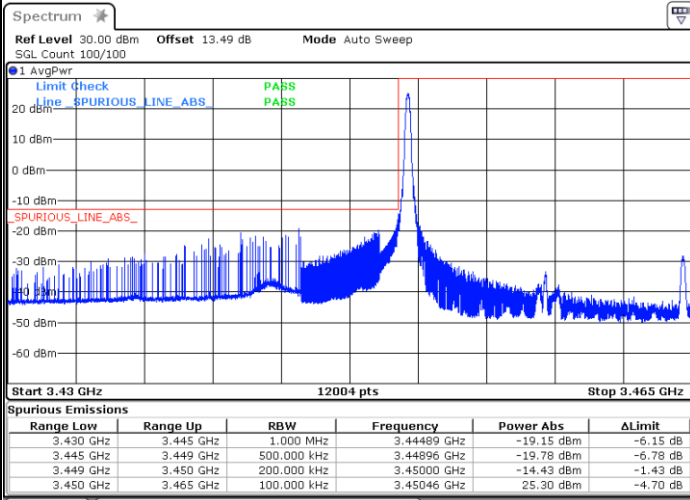

Date: 3.APR.2022 15:45:37

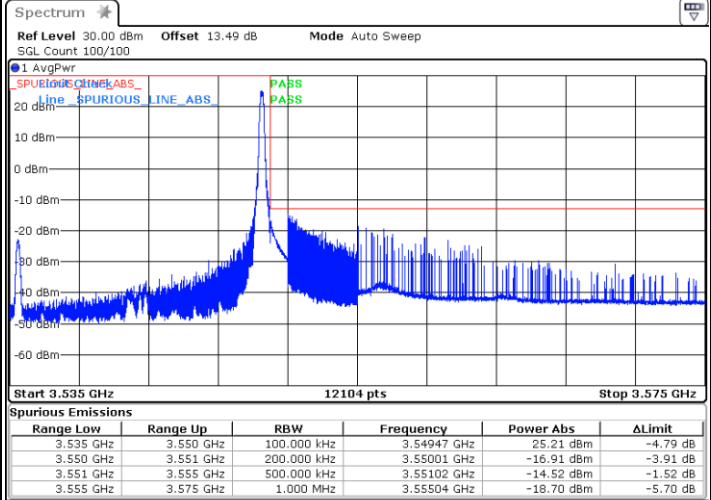

Date: 3.APR.2022 15:54:51

Lowest Band Edge / Full RB

Highest Band Edge / Full RB

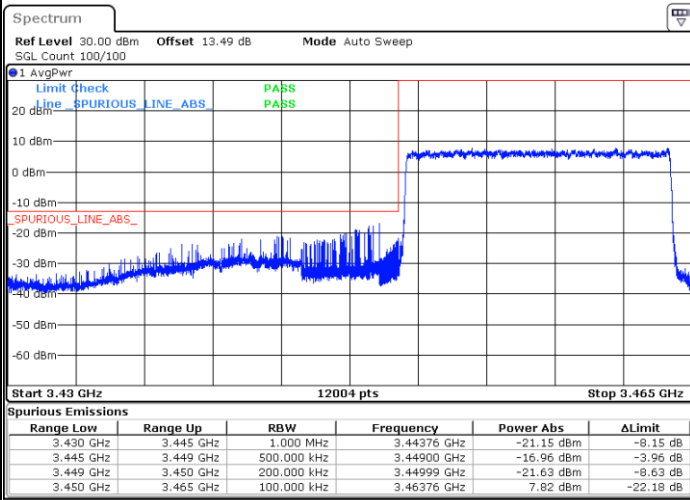

Date: 3.APR.2022 15:31:36

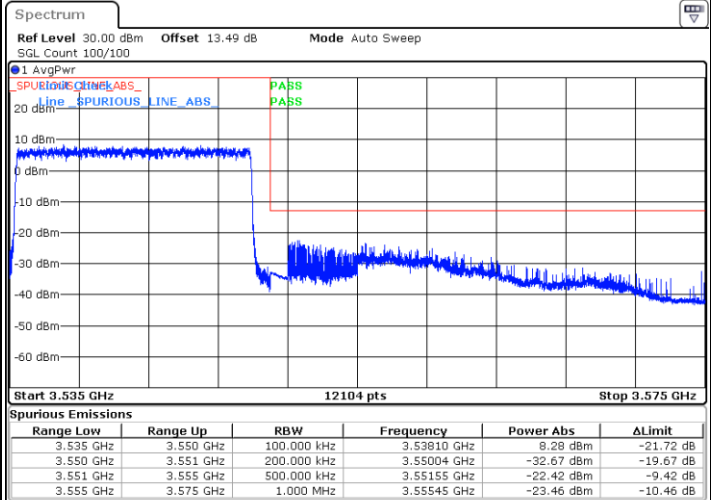

Date: 3.APR.2022 15:46:55



FR1 n78 / 15MHz / DFT-S OFDM / QPSK

Lowest Band Edge / 1RB0

Highest Band Edge / 1RBmax

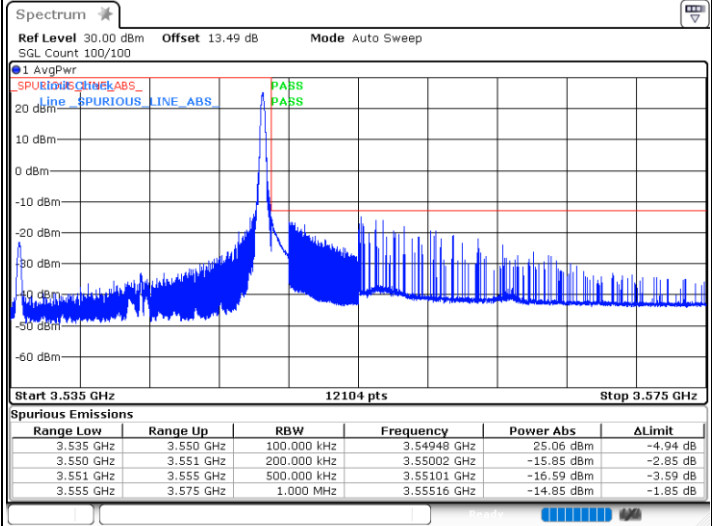
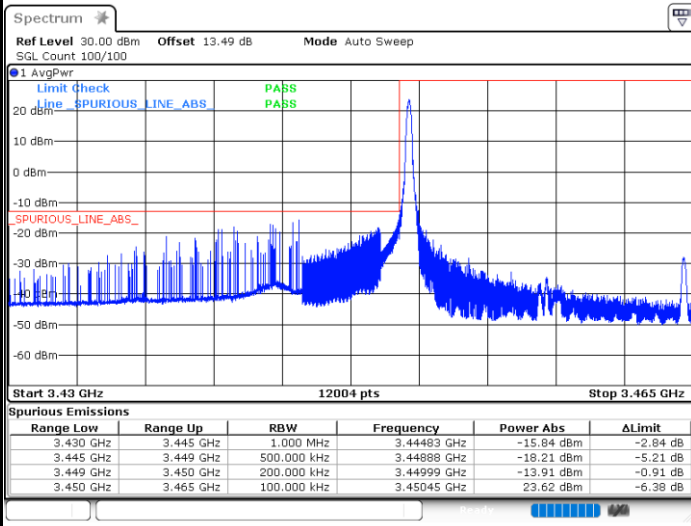

Date: 3.APR.2022 15:43:32

Date: 3.APR.2022 15:53:30

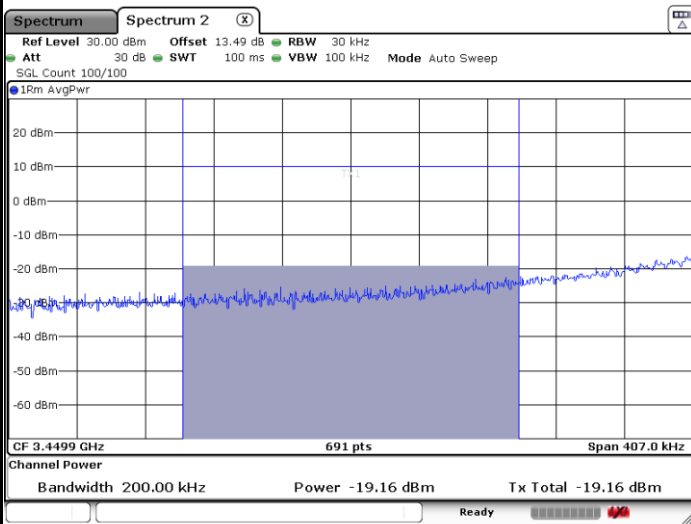

Date: 25.MAR.2022 10:50:43

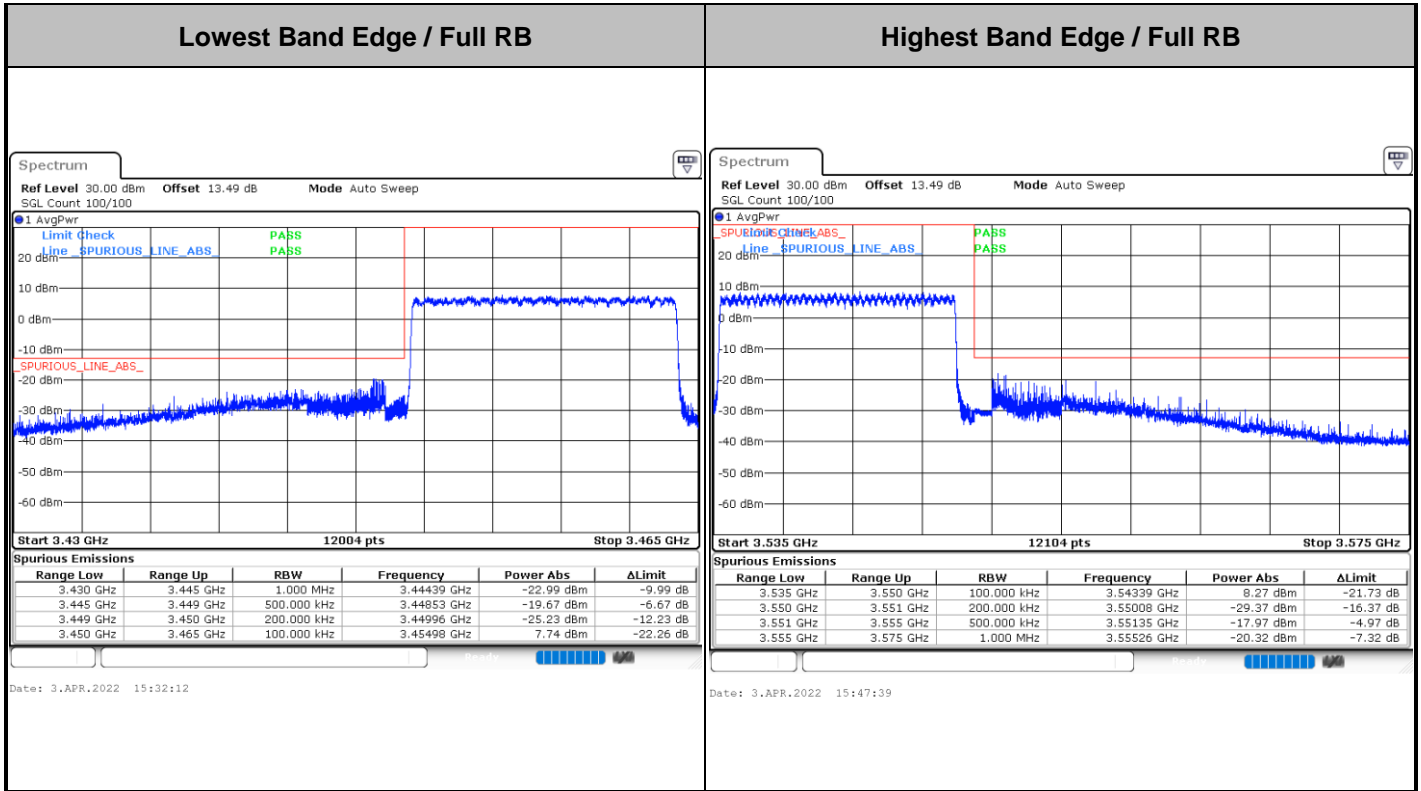



FR1 n78/ 15MHz / DFT-S OFDM / 16Q

Lowest Band Edge / 1RB0

Highest Band Edge / 1RBmax

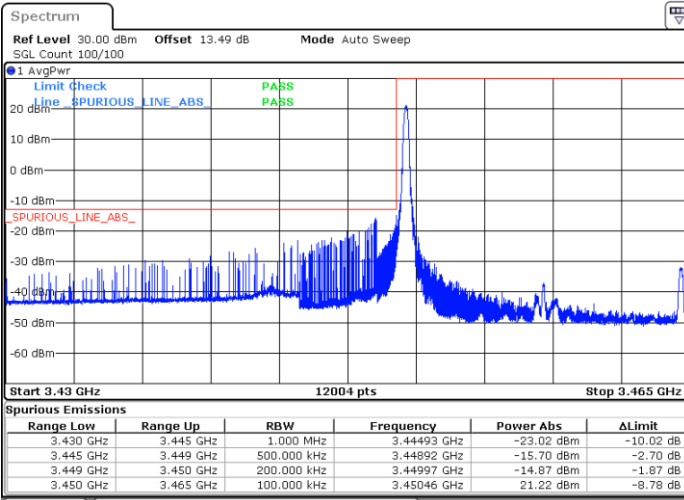

Date: 3.APR.2022 15:39:15

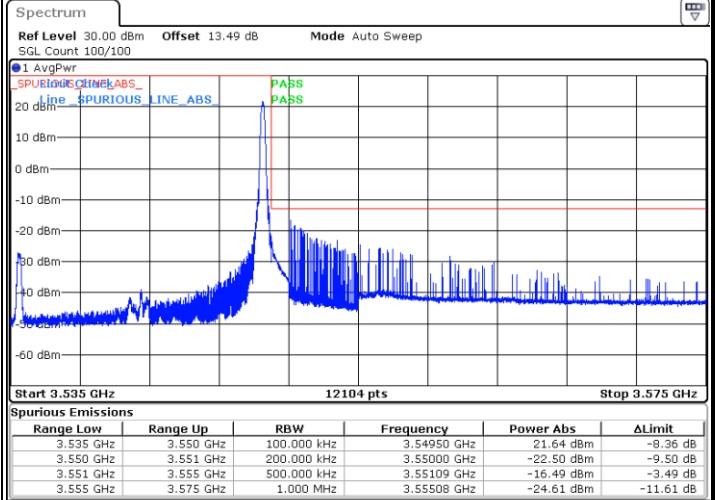

Date: 3.APR.2022 15:51:54

Lowest Band Edge / Full RB

Highest Band Edge / Full RB

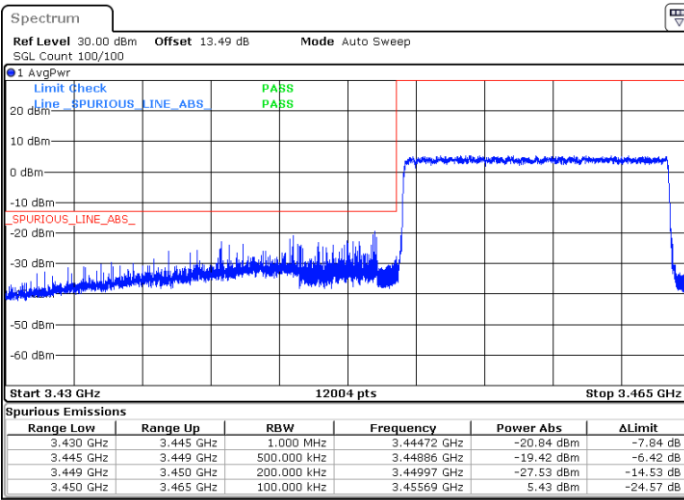

Date: 3.APR.2022 15:33:15

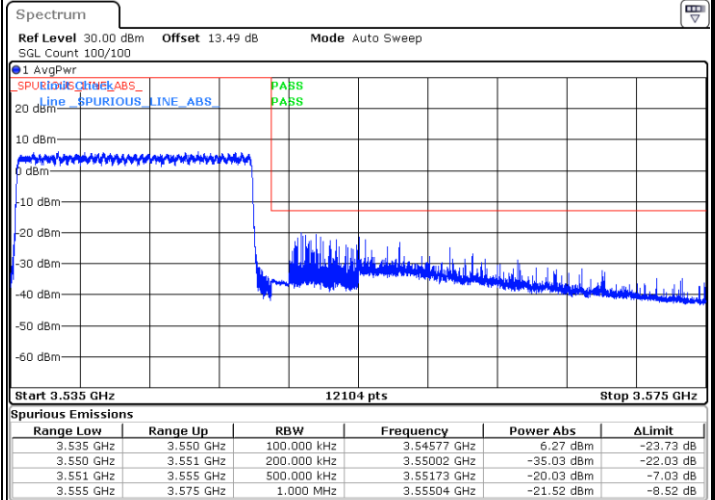

Date: 3.APR.2022 15:48:19



FR1 n78 / 15MHz / DFT-S OFDM / 64Q

Lowest Band Edge / 1RB0

Highest Band Edge / 1RBmax

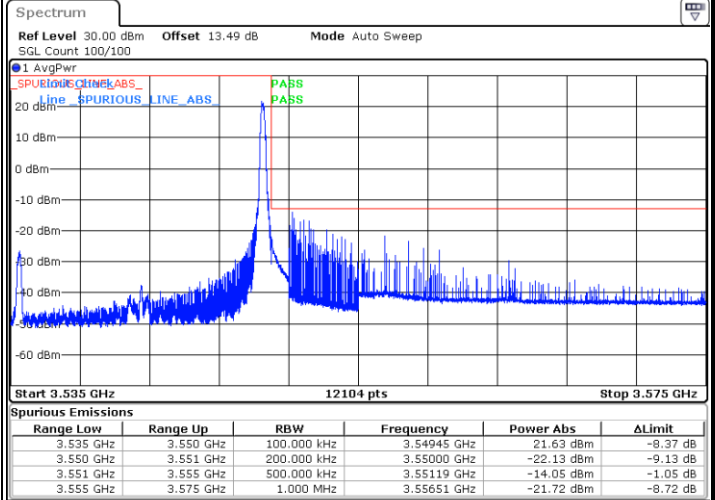
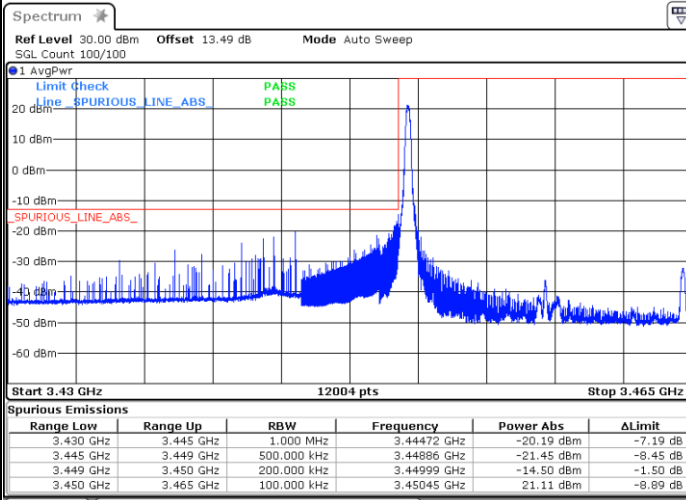

Date: 3.APR.2022 15:38:23

Date: 3.APR.2022 15:51:18

Lowest Band Edge / Full RB

Highest Band Edge / Full RB

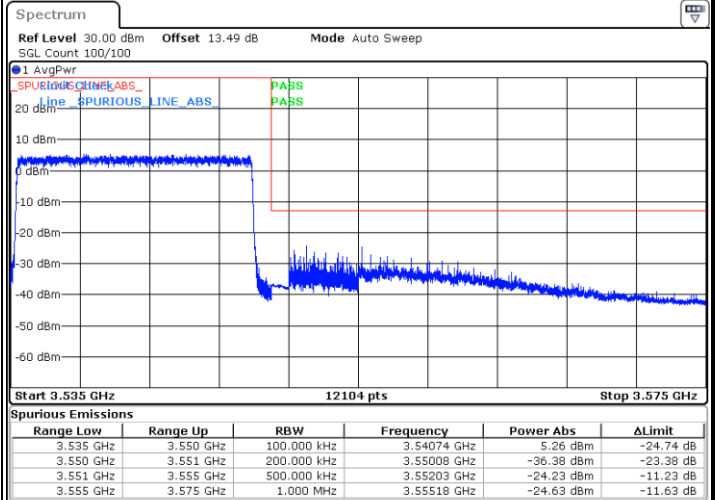
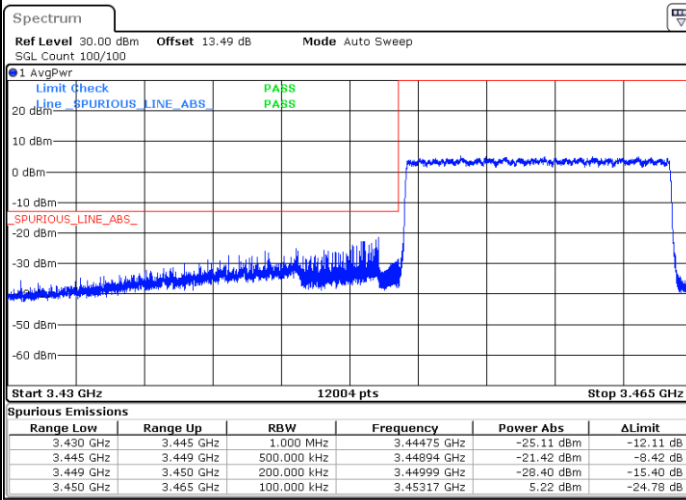

Date: 3.APR.2022 15:33:58

Date: 3.APR.2022 15:48:59



FR1 n78/ 15MHz / DFT-S OFDM / 256Q

Lowest Band Edge / 1RB0

Highest Band Edge / 1RBmax

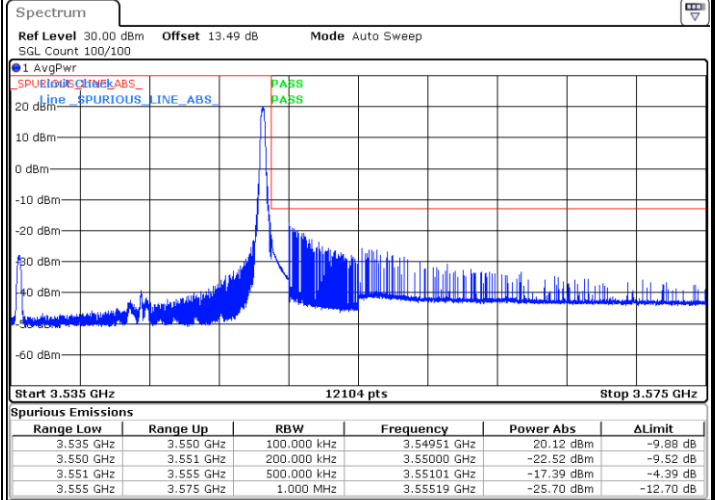
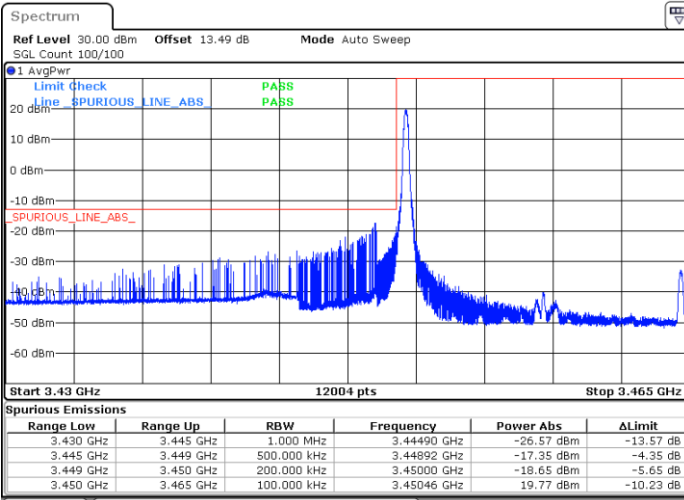

Date: 3.APR.2022 15:35:36

Date: 3.APR.2022 15:50:41

Lowest Band Edge / Full RB

Highest Band Edge / Full RB

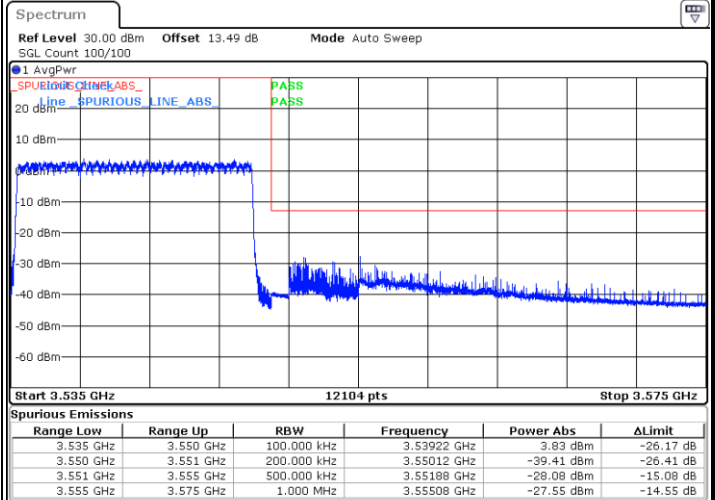
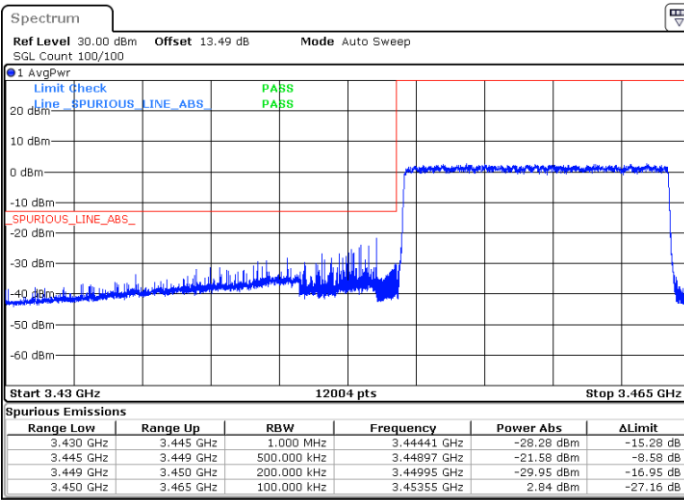

Date: 3.APR.2022 15:34:58

Date: 3.APR.2022 15:49:51



FR1 n78 / 20MHz / DFT-S OFDM / PI/2 BPSK

Lowest Band Edge / 1RB0

Highest Band Edge / 1RBmax

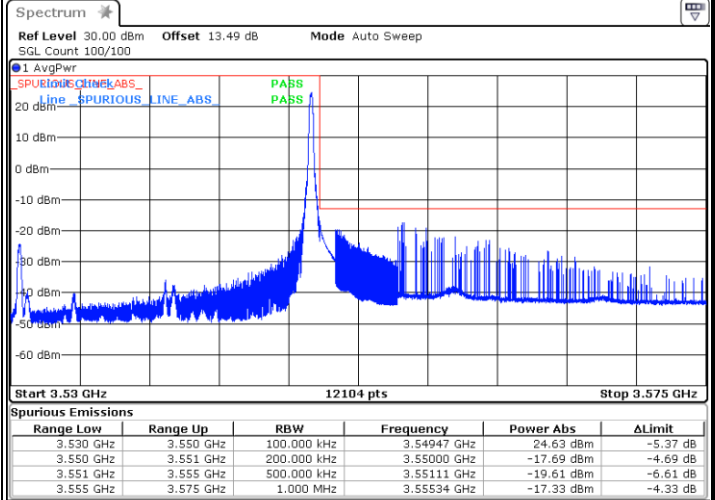
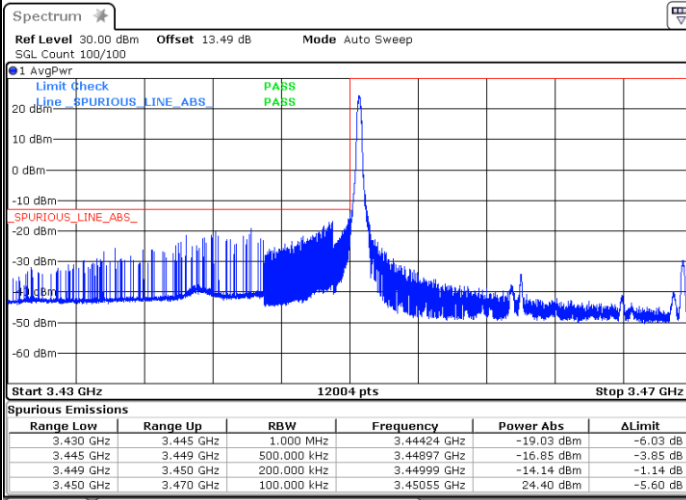

Date: 3.APR.2022 16:05:25

Date: 3.APR.2022 16:14:45

Lowest Band Edge / Full RB

Highest Band Edge / Full RB

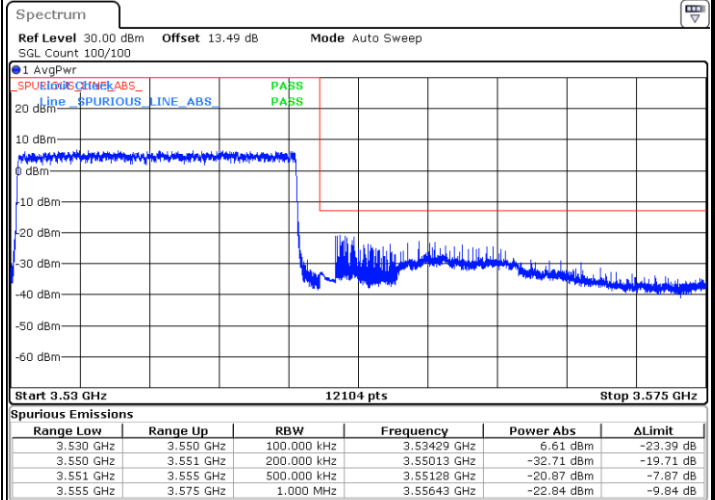
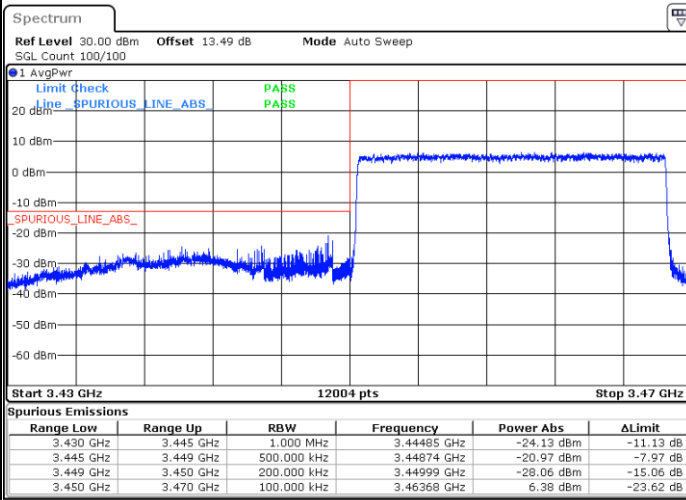

Date: 3.APR.2022 15:55:49

Date: 3.APR.2022 16:06:21



FR1 n78 / 20MHz / DFT-S OFDM / QPSK

Lowest Band Edge / 1RB0

Highest Band Edge / 1RBmax

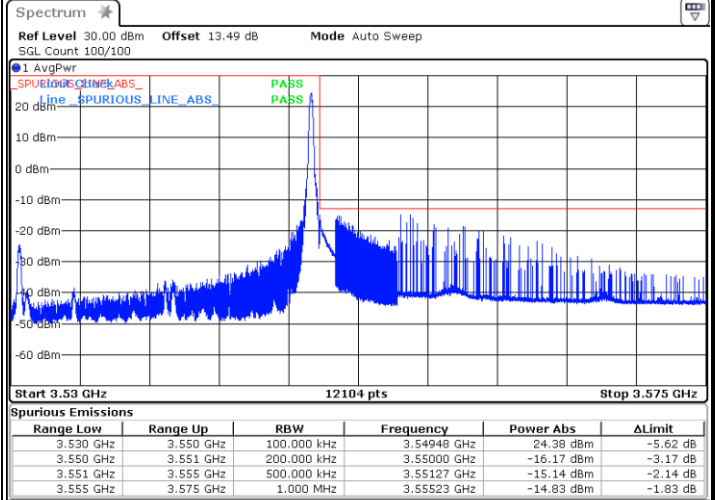
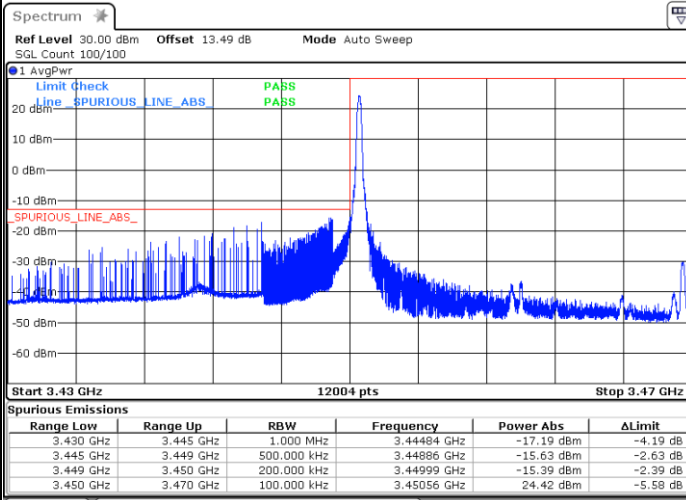

Date: 3.APR.2022 17:27:21

Date: 3.APR.2022 16:13:19

Lowest Band Edge / Full RB

Highest Band Edge / Full RB

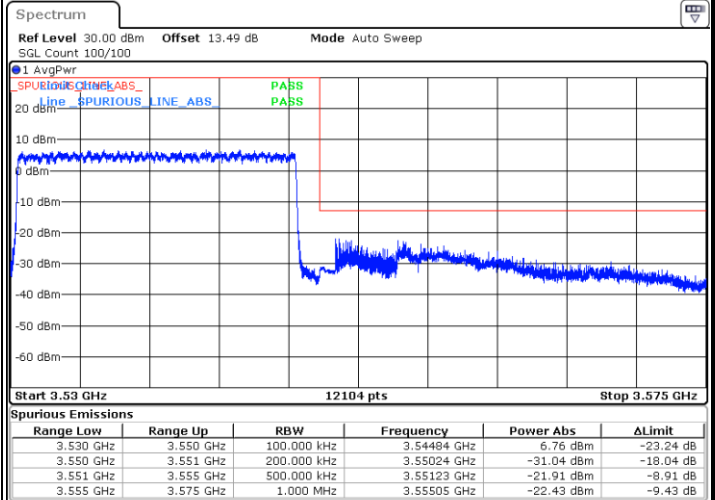
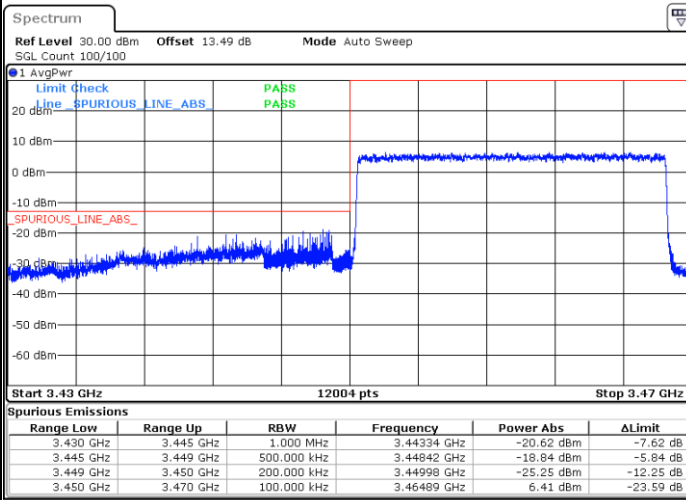

Date: 3.APR.2022 15:56:30

Date: 3.APR.2022 16:06:57



FR1 n78/ 20MHz / DFT-S OFDM / 16Q

Lowest Band Edge / 1RB0

Highest Band Edge / 1RBmax

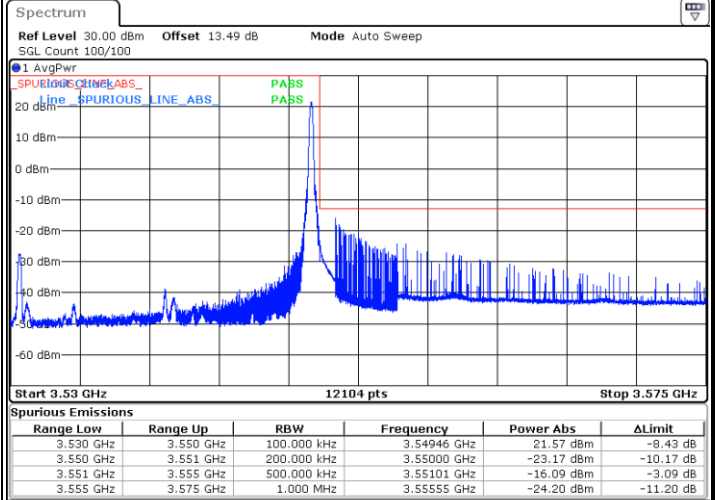
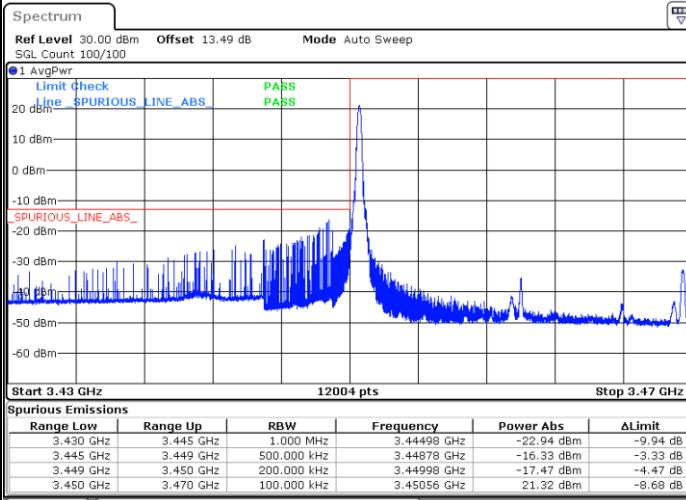

Date: 3.APR.2022 16:01:42

Date: 3.APR.2022 16:11:43

Lowest Band Edge / Full RB

Highest Band Edge / Full RB

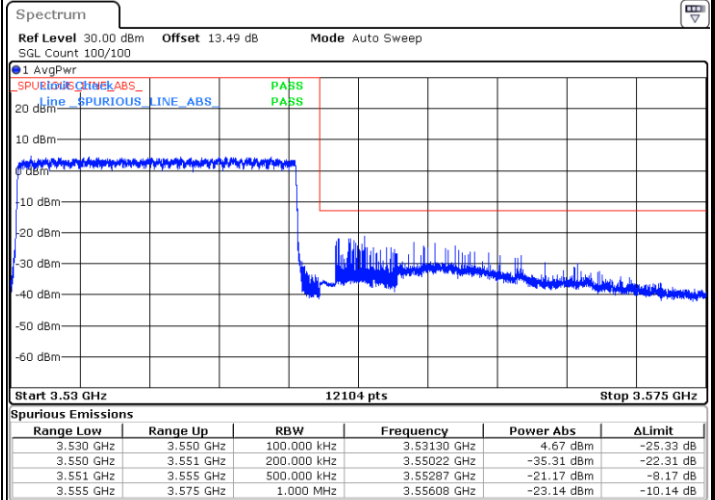
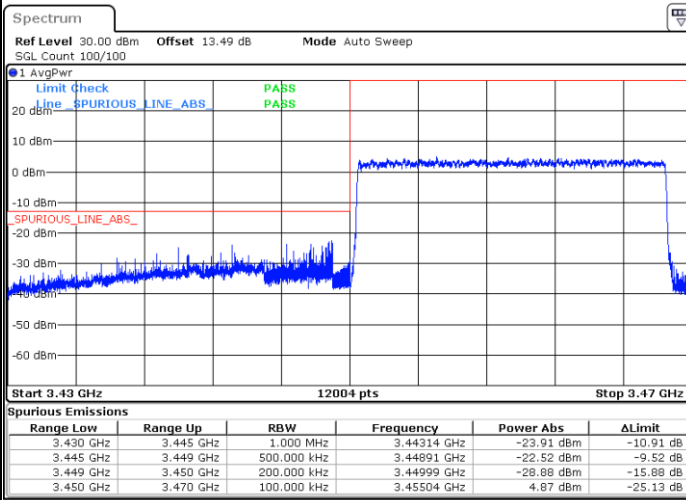

Date: 3.APR.2022 15:57:05

Date: 3.APR.2022 16:07:44



FR1 n78 / 20MHz / DFT-S OFDM / 64Q

Lowest Band Edge / 1RB0

Highest Band Edge / 1RBmax

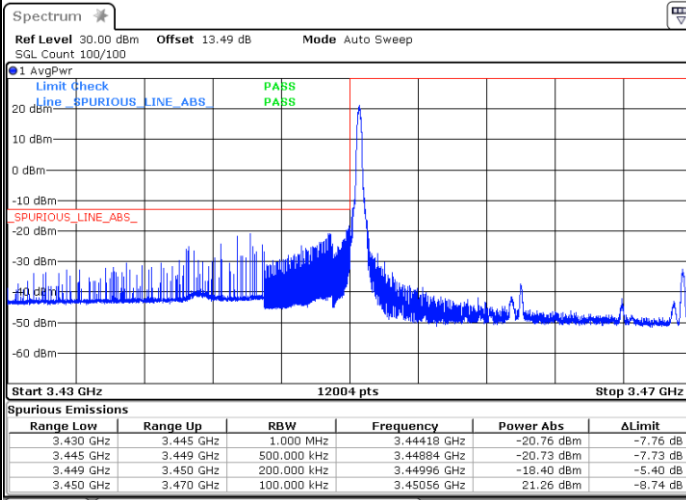

Date: 3.APR.2022 16:00:42

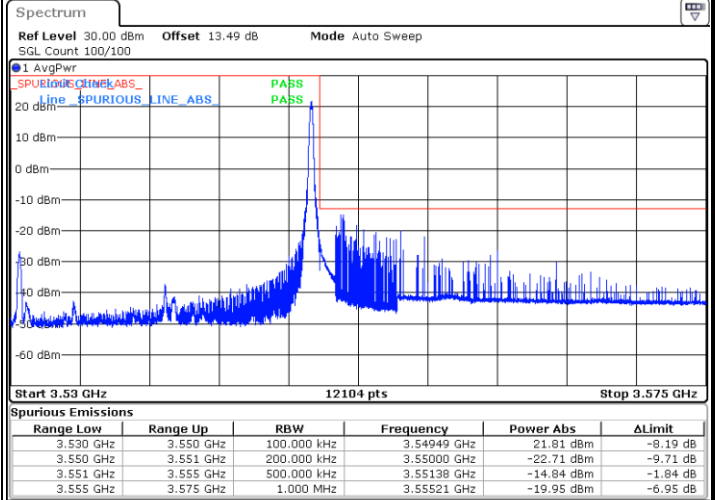

Date: 3.APR.2022 16:11:03

Lowest Band Edge / Full RB

Highest Band Edge / Full RB

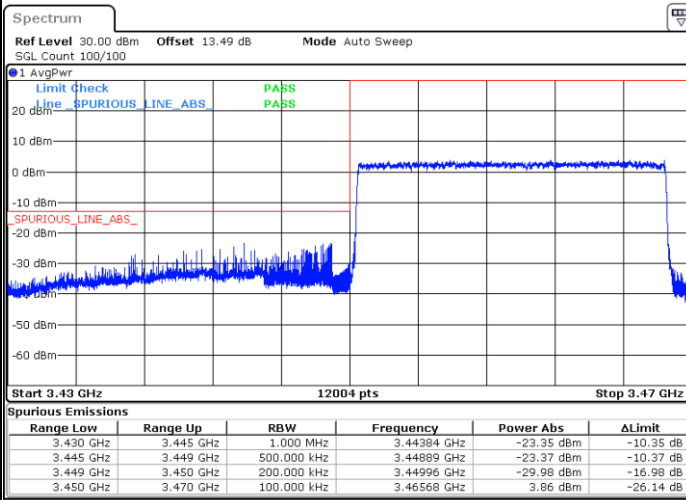

Date: 3.APR.2022 15:57:42

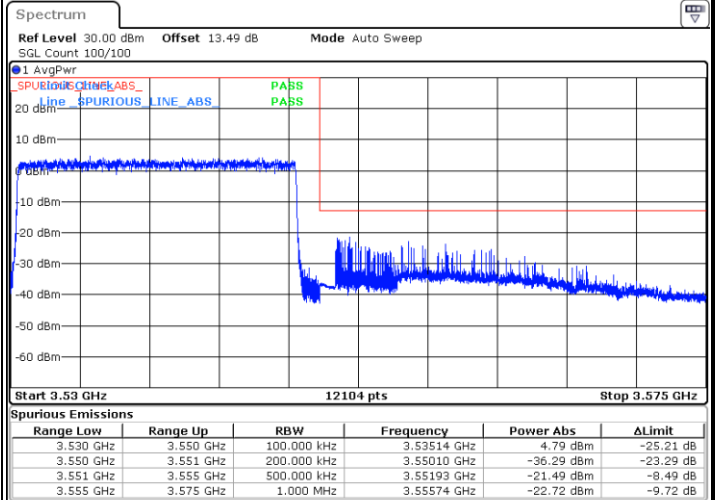

Date: 3.APR.2022 16:08:24



FR1 n78/ 20MHz / DFT-S OFDM / 256Q

Lowest Band Edge / 1RB0

Highest Band Edge / 1RBmax

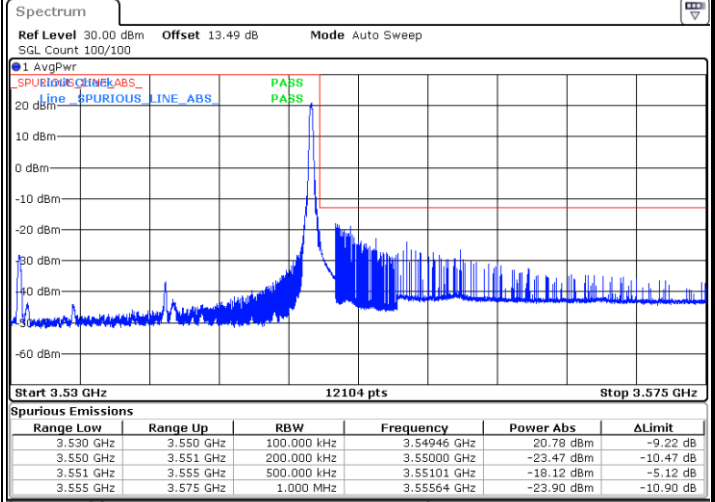
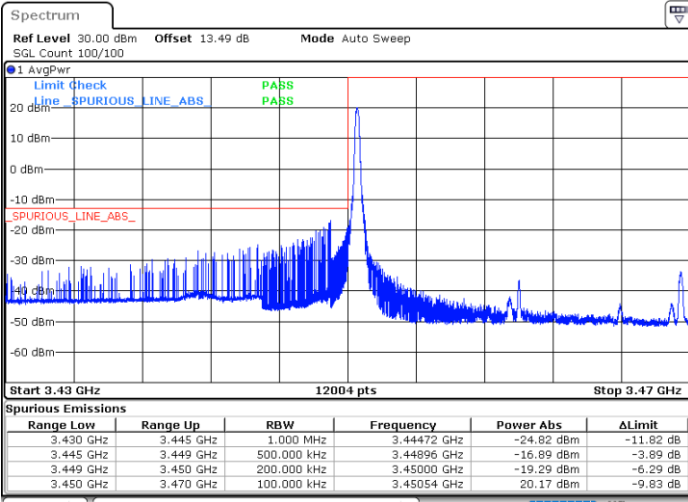

Date: 3.APR.2022 15:59:04

Date: 3.APR.2022 16:10:19

Lowest Band Edge / Full RB

Highest Band Edge / Full RB

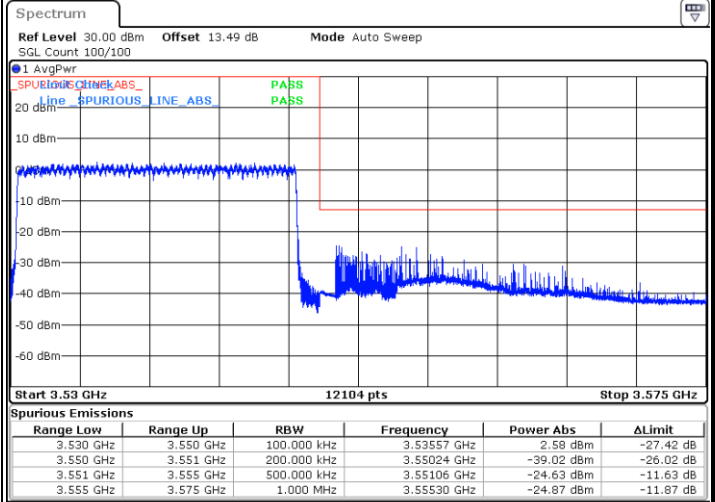
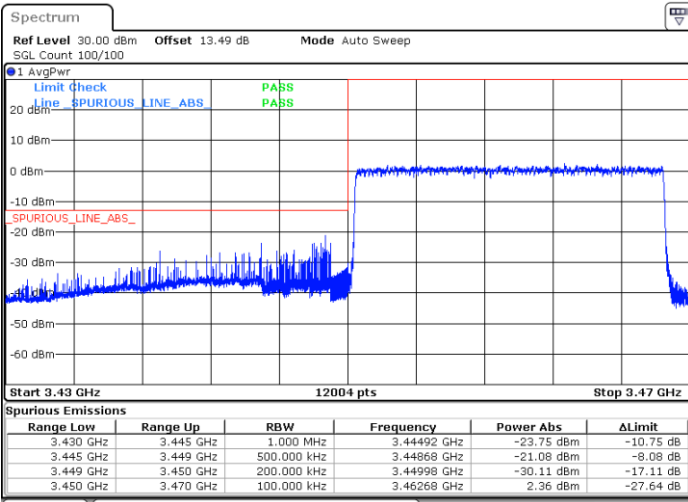

Date: 3.APR.2022 15:58:21

Date: 3.APR.2022 16:09:26



FR1 n78 / 25MHz / DFT-S OFDM / PI/2 BPSK

Lowest Band Edge / 1RB0

Highest Band Edge / 1RBmax

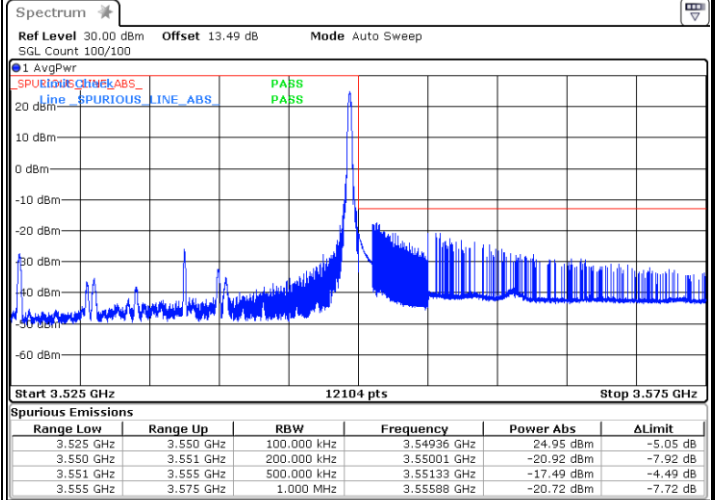
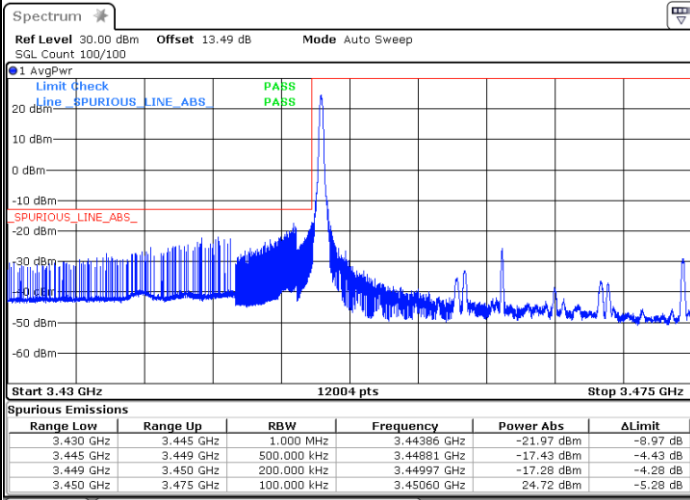

Date: 3.APR.2022 16:26:43

Date: 3.APR.2022 16:36:36

Lowest Band Edge / Full RB

Highest Band Edge / Full RB

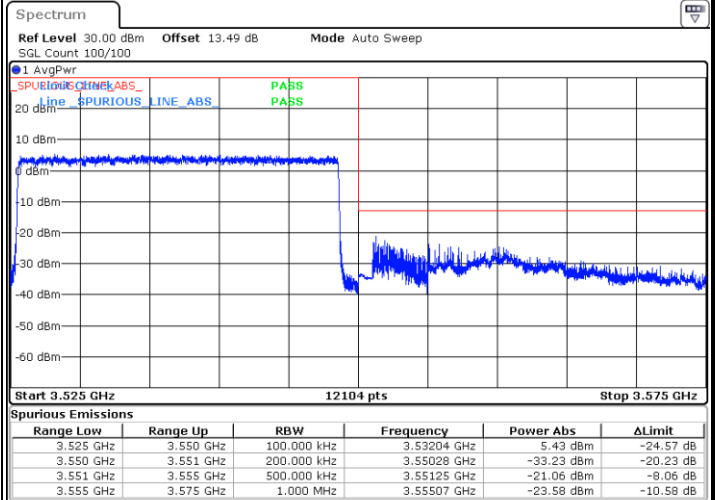
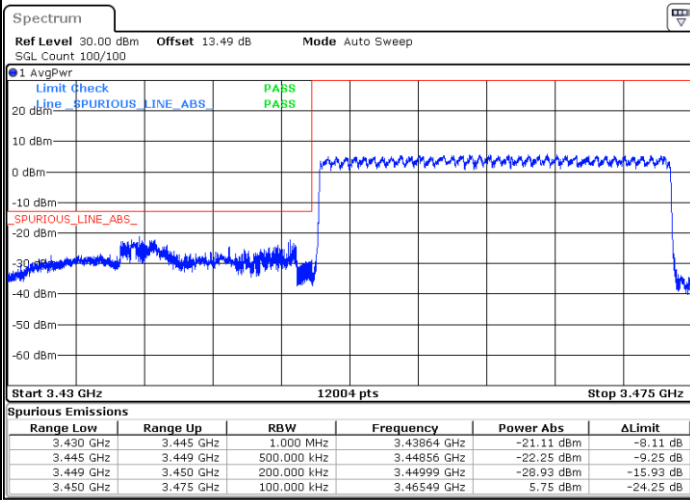

Date: 3.APR.2022 16:15:59

Date: 3.APR.2022 16:28:00



FR1 n78 / 25MHz / DFT-S OFDM / QPSK

Lowest Band Edge / 1RB0

Highest Band Edge / 1RBmax

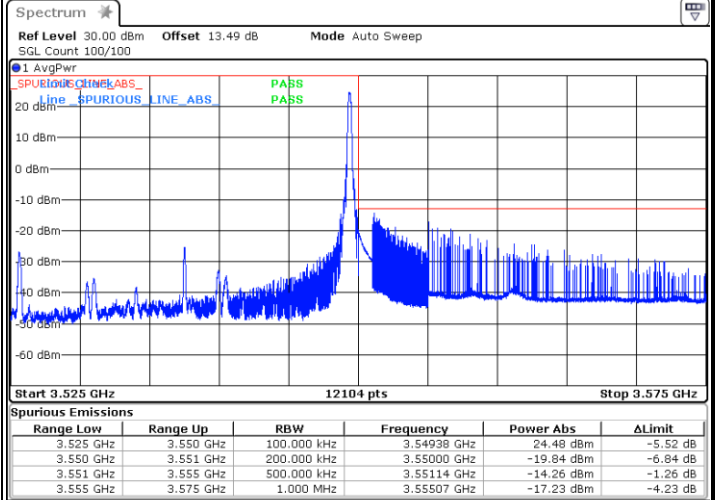
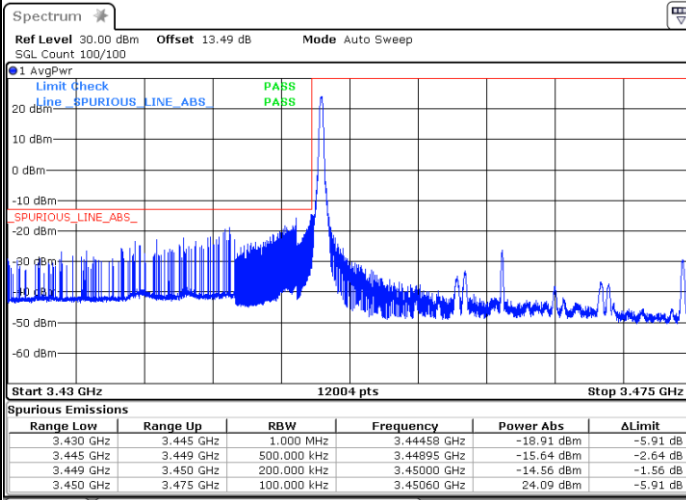

Date: 3.APR.2022 16:25:19

Date: 3.APR.2022 16:35:13

Lowest Band Edge / Full RB

Highest Band Edge / Full RB

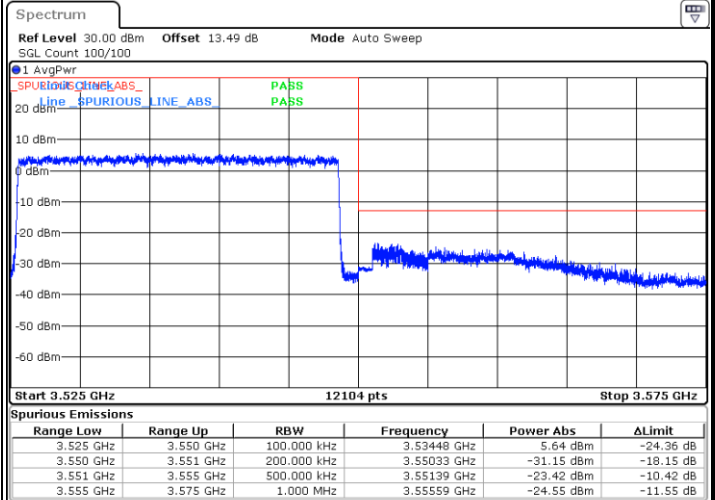
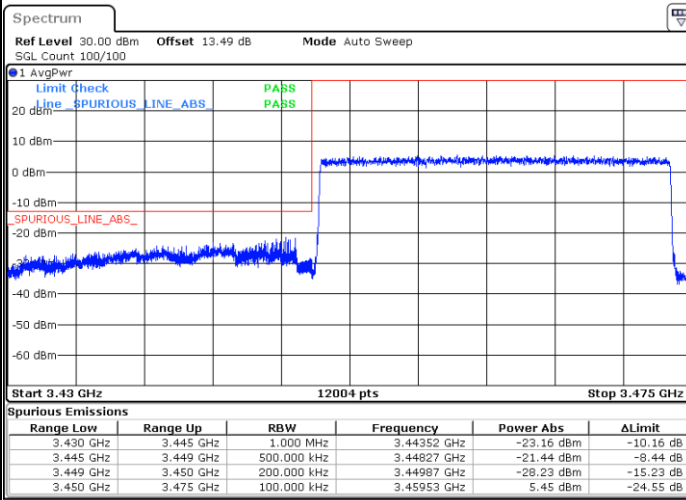

Date: 3.APR.2022 16:16:54

Date: 3.APR.2022 16:28:37