



FCC RF Test Report

APPLICANT : Xiaomi Communications Co., Ltd.
EQUIPMENT : Mobile Phone
BRAND NAME : XIAOMI
MODEL NAME : 22081212UG
FCC ID : 2AFZZ1212UG
STANDARD : 47 CFR Part 2, 27(M)
CLASSIFICATION : PCS Licensed Transmitter Held to Ear (PCE)
TEST DATE(S) : Jun. 23, 2022 ~ Jul. 13, 2022

We, Sporton International Inc. (Kunshan), would like to declare that the tested sample has been evaluated in accordance with the procedures given in ANSI C63.26-2015 and shown compliance with the applicable technical standards.

The test results in this report apply exclusively to the tested model / sample. Without written approval of Sporton International Inc. (Kunshan), the test report shall not be reproduced except in full.

Jason Jia

Approved by: Jason Jia



Sporton International Inc. (Kunshan)

**No. 1098, Pengxi North Road, Kunshan Economic Development Zone Jiangsu Province 215300
People's Republic of China**



TABLE OF CONTENTS

REVISION HISTORY...3
SUMMARY OF TEST RESULT...4
1 GENERAL DESCRIPTION...5
1.1 Applicant...5
1.2 Manufacturer...5
1.3 Product Feature of Equipment Under Test...5
1.4 Product Specification of Equipment Under Test...6
1.5 Modification of EUT...7
1.6 Maximum EIRP and Emission Designator...7
1.7 Testing Location...8
1.8 Test Software...8
1.9 Applicable Standards...8
2 TEST CONFIGURATION OF EQUIPMENT UNDER TEST...9
2.1 Test Mode...9
2.2 Connection Diagram of Test System...11
2.3 Support Unit used in test configuration and system...11
2.4 Measurement Results Explanation Example...11
2.5 Frequency List of Low/Middle/High Channels...12
3 CONDUCTED TEST ITEMS...15
3.1 Measuring Instruments...15
3.2 Test Setup...15
3.3 Test Result of Conducted Test...15
3.4 Conducted Output Power and EIRP...16
3.5 Peak-to-Average Ratio...17
3.6 Occupied Bandwidth...18
3.7 Conducted Band Edge...19
3.8 Conducted Spurious Emission...20
3.9 Frequency Stability...21
4 RADIATED TEST ITEMS...22
4.1 Measuring Instruments...22
4.2 Test Setup...22
4.3 Test Result of Radiated Test...23
4.4 Radiated Spurious Emission...24
5 LIST OF MEASURING EQUIPMENT...25
6 UNCERTAINTY OF EVALUATION...26
APPENDIX A. TEST RESULTS OF CONDUCTED TEST
APPENDIX B. TEST RESULTS OF RADIATED TEST
APPENDIX C. TEST SETUP PHOTOGRAPHS



REVISION HISTORY

REPORT NO.	VERSION	DESCRIPTION	ISSUED DATE
FG253108C	Rev. 01	Initial issue of report	Jul. 14, 2022



SUMMARY OF TEST RESULT

Report Section	FCC Rule	Description	Limit	Result	Remark
3.4	§2.1046	Conducted Output Power	-	Report Only	-
	§27.50(h)(2)	Equivalent Isotropic Radiated Power (Band 7) (Band 38) (Band 41)	EIRP < 2Watt		-
3.5	N/A	Peak-to-Average Ratio	<13 dB	PASS	-
3.6	§2.1049	Occupied Bandwidth	-	Report Only	-
3.7	§27.53(m)(4)	Conducted Band Edge Measurement (Band 7) (Band 38) (Band 41)	§27.53(m)(4)	PASS	-
3.8	§2.1051 §27.53(m)(4)	Conducted Spurious Emission (Band 7) (Band 38) (Band 41)	< 55+10log ₁₀ (P[Watts])	PASS	-
3.9	§2.1055 §27.54	Frequency Stability Temperature & Voltage	Within Authorized Band	PASS	-
4.4	§2.1053 §27.53(m)(4)	Radiated Spurious Emission (Band 7) (Band 38) (Band 41)	< 55+10log ₁₀ (P[Watts])	PASS	Under limit 23.26 dB at 10340.000 MHz

Declaration of Conformity:

The test results with all measurement uncertainty excluded are presented in accordance with the regulation limits or requirements declared by manufacturers.

Comments and Explanations:

The declared of product specification for EUT presented in the report are provided by the manufacturer, and the manufacturer takes all the responsibilities for the accuracy of product specification.



1 General Description

1.1 Applicant

Xiaomi Communications Co., Ltd.

#019, 9th Floor, Building 6, 33 Xi'erqi Middle Road, Haidian District, Beijing, China, 100085

1.2 Manufacturer

Xiaomi Communications Co., Ltd.

#019, 9th Floor, Building 6, 33 Xi'erqi Middle Road, Haidian District, Beijing, China, 100085

1.3 Product Feature of Equipment Under Test

Product Feature	
Equipment	Mobile Phone
Brand Name	XIAOMI
Model Name	22081212UG
FCC ID	2AFZZ1212UG
IMEI Code	Conducted: 869678060020925/869678060020933 Radiation: 869678060065326/869678060065334
HW Version	P2
SW Version	MIUI 13
EUT Stage	Identical Prototype



1.4 Product Specification of Equipment Under Test

Standards-related Product Specification	
Tx Frequency	LTE Band 7 : 2500 MHz ~ 2570 MHz LTE Band 38 : 2570 MHz ~ 2620 MHz LTE Band 41 : 2496 MHz ~ 2690 MHz
Rx Frequency	LTE Band 7 : 2620 MHz ~ 2690 MHz LTE Band 38 : 2570 MHz ~ 2620 MHz LTE Band 41 : 2496 MHz ~ 2690 MHz
Bandwidth	LTE Band 7 : 5MHz/ 10MHz / 15MHz / 20MHz LTE Band 38 : 5MHz / 10MHz / 15MHz / 20MHz LTE Band 41 : 5MHz / 10MHz / 15MHz / 20MHz
Maximum Output Power to Antenna	<p><Ant. 0> LTE Band 7 : 21.87 dBm; LTE Band 7C : 21.43 dBm LTE Band 38 : 21.84 dBm; LTE Band 38C : 21.37 dBm LTE Band 41 : 21.98 dBm</p> <p><Ant. 1> LTE Band 7 : 22.86 dBm; LTE Band 7C : 22.34 dBm LTE Band 38 : 22.98 dBm; LTE Band 38C : 22.53 dBm LTE Band 41 : 23.16 dBm</p> <p><Ant. 2> LTE Band 7 : 24.73 dBm; LTE Band 7C : 24.14 dBm LTE Band 38 : 24.45 dBm; LTE Band 38C : 23.99 dBm LTE Band 41 : 24.56 dBm</p> <p><Ant. 3> LTE Band 7 : 24.30 dBm; LTE Band 7C : 24.03 dBm LTE Band 38 : 24.62 dBm; LTE Band 38C : 24.07 dBm LTE Band 41 : 24.63 dBm</p>
Antenna Gain	<p><Ant. 0> LTE Band 7 : -3.50 dBi LTE Band 38 : -3.50 dBi LTE Band 41 : -3.50 dBi</p> <p><Ant. 1> LTE Band 7 : -1.60 dBi LTE Band 38 : -1.60 dBi LTE Band 41 : -1.60 dBi</p> <p><Ant. 2> LTE Band 7 : -1.44 dBi LTE Band 38 : -1.44 dBi LTE Band 41 : -1.44 dBi</p> <p><Ant. 3> LTE Band 7 : -3.37 dBi LTE Band 38 : -3.37 dBi LTE Band 41 : -3.37 dBi</p>
Type of Modulation	QPSK / 16QAM / 64QAM / 256QAM

Note:

1. The maximum EIRP is calculated from max output power and antenna gain, only the maximum EIRP of Ant.2 is shown in the report.
2. The device supports two PAs for LTE Band 7: main PA and other PA(for ENDC_7A-n5A). The maximum power of main PA is higher than the other PA, therefore, we chose higher power of main PA to calculate the EIRP and show in the report.



1.5 Modification of EUT

No modifications are made to the EUT during all test items.

1.6 Maximum EIRP and Emission Designator

LTE Band 7		QPSK		16QAM/64QAM/256QAM	
BW (MHz)	Frequency Range (MHz)	Maximum EIRP(W)	Emission Designator (99%OBW)	Maximum EIRP(W)	Emission Designator (99%OBW)
20	2510.0 ~ 2560.0	0.2133	17M9G7D	0.1718	17M9W7D
LTE Band 38		QPSK		16QAM/64QAM/256QAM	
BW (MHz)	Frequency Range (MHz)	Maximum EIRP(W)	Emission Designator (99%OBW)	Maximum EIRP(W)	Emission Designator (99%OBW)
20	2580.0 ~ 2610.0	0.2000	17M8G7D	0.1493	17M9W7D
LTE Band 41		QPSK		16QAM/64QAM/256QAM	
BW (MHz)	Frequency Range (MHz)	Maximum EIRP(W)	Emission Designator (99%OBW)	Maximum EIRP(W)	Emission Designator (99%OBW)
20	2506.0 ~ 2680.0	0.2051	17M8G7D	0.1648	17M9W7D

LTE Band 7 CA		QPSK		16QAM/64QAM/256QAM	
BW (MHz)		Maximum EIRP(W)	Emission Designator (99%OBW)	Maximum EIRP(W)	Emission Designator (99%OBW)
20MHz+20MHz		0.1862	37M9G7D	0.1592	37M5W7D
LTE Band 38 CA		QPSK		16QAM/64QAM/256QAM	
BW (MHz)		Maximum EIRP(W)	Emission Designator (99%OBW)	Maximum EIRP(W)	Emission Designator (99%OBW)
20MHz+20MHz		0.1799	37M6G7D	0.1419	37M6W7D

Note:

1. LTE Band 41 overlaps the entire frequency range of LTE Band 38. Therefore, the test results provided in this report covers Band 41 as well as Band 38.
2. All modulations have been tested, only maximum bandwidth and the worst test results of PSK & QAM are shown in the report.



1.7 Testing Location

Sporton International Inc. (Kunshan) is accredited to ISO/IEC 17025:2017 by American Association for Laboratory Accreditation with Certificate Number 5145.02.

Test Firm	Sporton International Inc. (Kunshan)		
Test Site Location	No. 1098, Pengxi North Road, Kunshan Economic Development Zone Jiangsu Province 215300 People's Republic of China TEL : +86-512-57900158 FAX : +86-512-57900958		
Test Site No.	Sporton Site No.	FCC Designation No.	FCC Test Firm Registration No.
	03CH04-KS TH01-KS	CN1257	314309

1.8 Test Software

Item	Site	Manufacture	Name	Version
1.	03CH04-KS	AUDIX	E3	6.2009-8-24a

1.9 Applicable Standards

According to the specifications of the manufacturer, the EUT must comply with the requirements of the following standards:

- ♦ 47 CFR Part 2, 27(M)
- ♦ ANSI C63.26-2015
- ♦ FCC KDB 971168 D01 Power Meas License Digital Systems v03r01
- ♦ FCC KDB 412172 D01 Determining ERP and EIRP v01r01

Remark:

1. All test items were verified and recorded according to the standards and without any deviation during the test.
2. This EUT has also been tested and complied with the requirements of FCC Part 15, Subpart B, recorded in a separate test report.



2 Test Configuration of Equipment Under Test

2.1 Test Mode

Antenna port conducted and radiated test items listed below are performed according to KDB 971168 D01 Power Meas License Digital Systems v03r01 with maximum output power.

Radiated measurements are performed by rotating the EUT in three different orthogonal test planes to find the maximum emission.

Test Items	Band	Bandwidth (MHz)						Modulation				RB #			Test Channel				
		1.4	3	5	10	15	20	QPSK	16QAM	64QAM	256QAM	1	Half	Full	L	M	H		
Max. Output Power	7	-	-	v	v	v	v	v	v	v	v	v	v	v	v	v	v		
	38	-	-	v	v	v	v	v	v	v	v	v	v	v	v	v	v		
	41	-	-	v	v	v	v	v	v	v	v	v	v	v	v	v	v		
Peak-to-Average Ratio	7	-	-				v	v	v	v	v			v		v			
	41	-	-				v	v	v	v	v			v		v			
26dB and 99% Bandwidth	7	-	-				v	v	v					v		v			
	41	-	-				v	v	v					v		v			
Conducted Band Edge	7	-	-	v	v	v	v	v	v	v	v	v		v	v		v		
	41	-	-	v	v	v	v	v	v	v	v	v		v	v		v		
Conducted Spurious Emission	7	-	-	v	v	v	v	v					v			v	v	v	
	41	-	-	v	v	v	v	v					v			v	v	v	
Frequency Stability	7	-	-		v			v							v		v		
	41	-	-		v			v							v		v		
E.R.P / E.I.R.P	7	-	-	v	v	v	v	v	v	v	v	v	v	v	v	v	v	v	
	38	-	-	v	v	v	v	v	v	v	v	v	v	v	v	v	v	v	
	41	-	-	v	v	v	v	v	v	v	v	v	v	v	v	v	v	v	
Radiated Spurious Emission	7	Worst Case																v	
	41	Worst Case																v	
Note	<ol style="list-style-type: none"> The mark "v" means that this configuration is chosen for testing The mark "-" means that this bandwidth is not supported. The device is investigated from 30MHz to 10 times of fundamental signal for radiated spurious emission test under different RB size/offset and modulations in exploratory test. Subsequently, only the worst case emissions are reported. 																		



Test Items	Band	Bandwidth (MHz)										Modulation				RB #			Test Channel				
		20+20	20+15	15+20	20+10	10+20	20+5	5+20	15+15	15+10	10+15	QPSK	16QAM	64 QAM	256 QAM	1	Half	Full	L	M	H		
Max. Output Power	7C_CA	v	v	v	v	v	-	-	v	v	-	v	v	v	v	v	v	v	v	v	v	v	v
	38C_CA	v	-	-	-	-	-	-	v	-	-	v	v	v	v	v	v	v	v	v	v	v	v
26dB and 99% Bandwidth	7C_CA	v					-	-			-	v	v	v	v			v		v			
	38C_CA	v	-	-	-	-	-	-		-	-	v	v	v	v			v		v			
Conducted Band Edge	7C_CA	v	v	v	v	v	-	-	v	v	-	v	v	v	v	v		v	v		v		
	38C_CA	v	-	-	-	-	-	-	v	-	-	v	v	v	v	v		v	v		v		
Conducted Spurious Emission	7C_CA	v	v	v	v	v	-	-	v	v	-	v				v				v	v	v	
	38C_CA	v	-	-	-	-	-	-	v	-	-	v				v				v	v	v	
E.I.R.P.	7C_CA	v	v	v	v	v	-	-	v	v	-	v	v	v	v	v	v	v	v	v	v	v	
	38C_CA	v	-	-	-	-	-	-	v	-	-	v	v	v	v	v	v	v	v	v	v	v	
Frequency Stability	7C_CA	v					-	-			-	v							v		v		
	38C_CA	v	-	-	-	-	-	-		-	-	v							v		v		
Radiated Spurious Emission	7C_CA	Worst Case																				v	
	38C_CA	Worst Case																				v	
Note	1. The mark "v" means that this configuration is chosen for testing 2. The mark "-" means that this bandwidth is not supported. 3. The device is investigated from 30MHz to 10 times of fundamental signal for radiated spurious emission test under different RB size/offset and modulations in exploratory test. Subsequently, only the worst case emissions are reported.																						

2.2 Connection Diagram of Test System

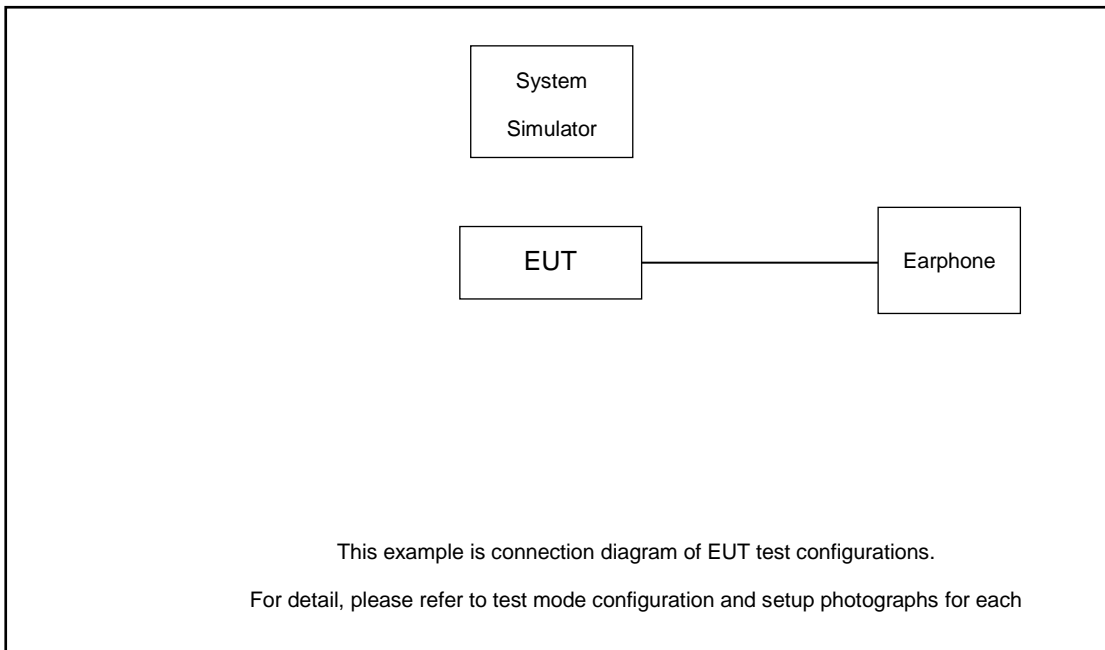

2.3 Support Unit used in test configuration and system

Item	Equipment	Trade Name	Model No.	FCC ID	Data Cable	Power Cord
1.	LTE Base Station	Anritsu	MT8820C	N/A	N/A	Unshielded, 1.8 m

2.4 Measurement Results Explanation Example

For all conducted test items:

The offset level is set in the spectrum analyzer to compensate the RF cable loss between EUT conducted output port and spectrum analyzer. With the offset compensation, the spectrum analyzer reading level is exactly the EUT RF output level.

The spectrum analyzer offset is derived from RF cable loss.

Offset = RF cable loss.

Following shows an offset computation example with cable loss 6.0 dB.

Example :

$$\begin{aligned} \text{Offset(dB)} &= \text{RF cable loss(dB)}. \\ &= 6.0 \text{ (dB)} \end{aligned}$$



2.5 Frequency List of Low/Middle/High Channels

LTE Band 7 Channel and Frequency List				
BW [MHz]	Channel/Frequency(MHz)	Lowest	Middle	Highest
20	Channel	20850	21100	21350
	Frequency	2510	2535	2560
15	Channel	20825	21100	21375
	Frequency	2507.5	2535	2562.5
10	Channel	20800	21100	21400
	Frequency	2505	2535	2565
5	Channel	20775	21100	21425
	Frequency	2502.5	2535	2567.5

LTE Band 38 Channel and Frequency List				
BW [MHz]	Channel/Frequency(MHz)	Lowest	Middle	Highest
20	Channel	37850	38000	38150
	Frequency	2580	2595	2610
15	Channel	37825	38000	38175
	Frequency	2577.5	2595	2612.5
10	Channel	37800	38000	38200
	Frequency	2575	2595	2615
5	Channel	37775	38000	38225
	Frequency	2572.5	2595	2617.5

LTE Band 41 Channel and Frequency List				
BW [MHz]	Channel/Frequency(MHz)	Lowest	Middle	Highest
20	Channel	39750	40620	41490
	Frequency	2506	2593	2680
15	Channel	39725	40620	41515
	Frequency	2503.5	2593	2682.5
10	Channel	39700	40620	41540
	Frequency	2501	2593	2685
5	Channel	39675	40620	41565
	Frequency	2498.5	2593	2687.5



LTE Band 7C_CA Channel and Frequency List					
BW [MHz]	Channel/Frequency(MHz)		Lowest	Middle	Highest
20 + 20	PCC	Channel	20850	21001	21152
		Frequency	2510.0	2525.1	2540.2
	SCC	Channel	21048	21199	21350
		Frequency	2529.8	2544.9	2560.0
20 + 15	PCC	Channel	20850	21026	21201
		Frequency	2510.0	2527.6	2545.1
	SCC	Channel	21021	21197	21372
		Frequency	2527.1	2544.7	2562.2
15 + 20	PCC	Channel	20828	21003	21179
		Frequency	2507.8	2525.3	2542.9
	SCC	Channel	20999	21174	21350
		Frequency	2524.9	2542.4	2560.0
20 + 10	PCC	Channel	20850	21051	21251
		Frequency	2510.0	2530.1	2550.1
	SCC	Channel	20994	21195	21395
		Frequency	2524.4	2544.5	2564.5
10 + 20	PCC	Channel	20805	21006	21206
		Frequency	2505.5	2525.6	2545.6
	SCC	Channel	20949	21150	21350
		Frequency	2519.9	2540.0	2560.0
15 + 15	PCC	Channel	20825	21025	21225
		Frequency	2507.5	2527.5	2547.5
	SCC	Channel	20975	21175	21375
		Frequency	2522.5	2542.5	2562.5
15 + 10	PCC	Channel	20825	21051	21277
		Frequency	2507.5	2530.1	2552.7
	SCC	Channel	20945	21171	21397
		Frequency	2519.5	2542.1	2564.7



LTE Band 38C_CA Channel and Frequency List					
BW [MHz]	Channel/Frequency(MHz)		Lowest	Middle	Highest
20 + 20	PCC	Channel	37850	37901	37952
		Frequency	2580.0	2585.1	2590.2
	SCC	Channel	38048	38099	38150
		Frequency	2599.8	2604.9	2610.0
15+ 15	PCC	Channel	37825	37925	38025
		Frequency	2577.5	2587.5	2597.5
	SCC	Channel	37975	38075	38175
		Frequency	2592.5	2602.5	2612.5

3 Conducted Test Items

3.1 Measuring Instruments

See list of measuring instruments of this test report.

3.2 Test Setup

3.2.1 Conducted Output Power

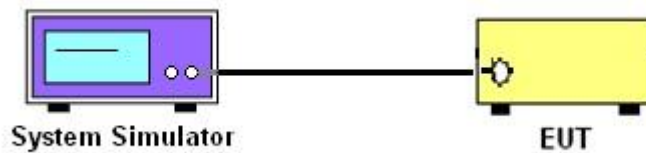

3.2.2 Peak-to-Average Ratio, Occupied Bandwidth, Conducted Band-Edge and Conducted Spurious Emission

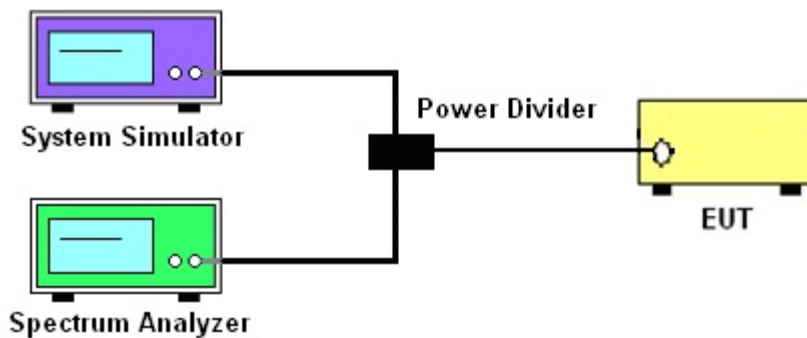

3.2.3 Frequency Stability

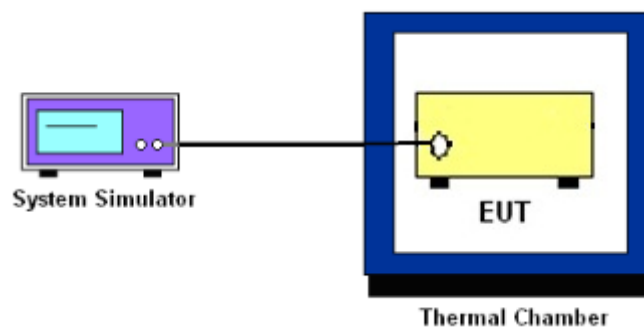

3.3 Test Result of Conducted Test

Please refer to Appendix A.



3.4 Conducted Output Power and EIRP

3.4.1 Description of the Conducted Output Power Measurement and EIRP Measurement

A system simulator was used to establish communication with the EUT. Its parameters were set to force the EUT transmitting at maximum output power. The measured power in the radio frequency on the transmitter output terminals shall be reported.

The EIRP of mobile transmitters must not exceed 2 Watts for LTE Band 7 and Band 38 and Band 41.

According to KDB 412172 D01 Power Approach,

$EIRP = P_T + G_T - L_C$, $ERP = EIRP - 2.15$, where

P_T = transmitter output power in dBm

G_T = gain of the transmitting antenna in dBi

L_C = signal attenuation in the connecting cable between the transmitter and antenna in dB

3.4.2 Test Procedures

1. The testing follows ANSI C63.26 Section 5.2
2. The transmitter output port was connected to the system simulator.
3. Set EUT at maximum power through the system simulator.
4. Select lowest, middle, and highest channels for each band and different modulation.
5. Measure and record the power level from the system simulator.



3.5 Peak-to-Average Ratio

3.5.1 Description of the PAR Measurement

Power Complementary Cumulative Distribution Function (CCDF) curves provide a means for characterizing the power peaks of a digitally modulated signal on a statistical basis. A CCDF curve depicts the probability of the peak signal amplitude exceeding the average power level. Most contemporary measurement instrumentation include the capability to produce CCDF curves for an input signal provided that the instrument's resolution bandwidth can be set wide enough to accommodate the entire input signal bandwidth. In measuring transmissions in this band using an average power technique, the peak-to-average ratio (PAR) of the transmission may not exceed 13 dB.

3.5.2 Test Procedures

1. The testing follows ANSI C63.26 Section 5.2.3.4 (CCDF).
2. The EUT was connected to spectrum and system simulator via a power divider.
3. Set the CCDF (Complementary Cumulative Distribution Function) option in spectrum analyzer.
4. The highest RF powers were measured and recorded the maximum PAPR level associated with a probability of 0.1 %.
5. Record the deviation as Peak to Average Ratio.



3.6 Occupied Bandwidth

3.6.1 Description of Occupied Bandwidth Measurement

The occupied bandwidth is the width of a frequency band such that, below the lower and above the upper frequency limits, the mean powers emitted are each equal to a specified percentage 0.5% of the total mean transmitted power.

The 26 dB emission bandwidth is defined as the frequency range between two points, one above and one below the carrier frequency, at which the spectral density of the emission is attenuated 26 dB below the maximum in-band spectral density of the modulated signal. Spectral density (power per unit bandwidth) is to be measured with a detector of resolution bandwidth equal to approximately 1.0% of the emission bandwidth.

3.6.2 Test Procedures

1. The testing follows ANSI C63.26 Section 5.4
2. The EUT was connected to spectrum analyzer and system simulator via a power divider.
3. The spectrum analyzer center frequency is set to the nominal EUT channel center frequency. The span range for the spectrum analyzer shall be between two and five times the anticipated OBW.
4. The nominal resolution bandwidth (RBW) shall be in the range of 1 to 5 % of the anticipated OBW, and the VBW shall be at least 3 times the RBW.
5. Set the detection mode to peak, and the trace mode to max hold.
6. Determine the reference value: Set the EUT to transmit a modulated signal. Allow the trace to stabilize. Set the spectrum analyzer marker to the highest level of the displayed trace.
(this is the reference value)
7. Determine the “-26 dB down amplitude” as equal to (Reference Value – X).
8. Place two markers, one at the lowest and the other at the highest frequency of the envelope of the spectral display such that each marker is at or slightly below the “-X dB down amplitude” determined in step 6. If a marker is below this “-X dB down amplitude” value it shall be placed as close as possible to this value. The OBW is the positive frequency difference between the two markers.
9. Use the 99 % power bandwidth function of the spectrum analyzer and report the measured bandwidth.



3.7 Conducted Band Edge

3.7.1 Description of Conducted Band Edge Measurement

27.53(m)(4)

For mobile digital stations, the attenuation factor shall be not less than $40 + 10 \log (P)$ dB on all frequencies between the channel edge and 5 megahertz from the channel edge, $43 + 10 \log (P)$ dB on all frequencies between 5 megahertz and X megahertz from the channel edge, and $55 + 10 \log (P)$ dB on all frequencies more than X megahertz from the channel edge, where X is the greater of 6 megahertz or the actual emission bandwidth as defined in paragraph (m)(6) of this section. In addition, the attenuation factor shall not be less than $43 + 10 \log (P)$ dB on all frequencies between 2490.5 MHz and 2496 MHz and $55 + 10 \log (P)$ dB at or below 2490.5 MHz. Mobile Satellite Service licensees operating on frequencies below 2495 MHz may also submit a documented interference complaint against BRS licensees operating on channel BRS Channel 1 on the same terms and conditions as adjacent channel BRS or EBS licensees.

3.7.2 Test Procedures

1. The testing follows ANSI C63.26 section 5.7
2. The EUT was connected to spectrum analyzer and system simulator via a power divider.
3. The band edges of low and high channels for the highest RF powers were measured.
4. Set RBW $\geq 1\%/2\%$ EBW in the 1MHz band immediately outside and adjacent to the band edge.
5. Beyond the 1 MHz band from the band edge, RBW=1MHz was used.
6. Set spectrum analyzer with RMS detector.
7. Offset has included the duty factor for LTE Band 38/41. Duty factor = $10 \log (1/x)$, where x is the measured duty cycle.
8. The RF fundamental frequency should be excluded against the limit line in the operating frequency band.
9. Checked that all the results comply with the emission limit line.

Example:

The limit line is derived from $43 + 10 \log (P)$ dB below the transmitter power P(Watts)

$$= P(W) - [43 + 10 \log (P)] \text{ (dB)}$$

$$= [30 + 10 \log (P)] \text{ (dBm)} - [43 + 10 \log (P)] \text{ (dB)} = -13 \text{ dBm.}$$

10. For LTE Band 7, 38, 41, the other 40 dB, and 55 dB have additionally applied same calculation above.
11. When using the integration method, the starting frequency of the integration shall be centered at one-half of the RBW away from the band edge.



3.8 Conducted Spurious Emission

3.8.1 Description of Conducted Spurious Emission Measurement

The power of any emission outside of the authorized operating frequency ranges must be lower than the transmitter power (P) by a factor of at least $43 + 10 \log (P)$ dB.

For Band 7,38,41:

The power of any emission outside of the authorized operating frequency ranges must be lower than the transmitter power (P) by a factor of at least $55 + 10 \log (P)$ dB.

It is measured by means of a calibrated spectrum analyzer and scanned from 30 MHz up to a frequency including its 10th harmonic.

3.8.2 Test Procedures

1. The testing follows ANSI C63.26 section 5.7
2. The EUT was connected to spectrum analyzer and system simulator via a power divider.
3. The RF output of EUT was connected to the spectrum analyzer by RF cable and attenuator. The path loss was compensated to the results for each measurement.
4. The middle channel for the highest RF power within the transmitting frequency was measured.
5. The conducted spurious emission for the whole frequency range was taken.
6. Make the measurement with the spectrum analyzer's RBW = 1MHz, VBW = 3MHz.
7. Set spectrum analyzer with RMS detector.
8. Offset has included the duty factor for LTE Band 38/41. Duty factor = $10 \log (1/x)$, where x is the measured duty cycle.
9. Taking the record of maximum spurious emission.
10. The RF fundamental frequency should be excluded against the limit line in the operating frequency band.
11. The limit line is derived from $43 + 10 \log (P)$ dB below the transmitter power P(Watts)
= $P(W) - [43 + 10 \log (P)]$ (dB)
= $[30 + 10 \log (P)]$ (dBm) - $[43 + 10 \log (P)]$ (dB)
= -13dBm.
12. For Band 7, 38, 41
The limit line is derived from $55 + 10 \log (P)$ dB below the transmitter power P(Watts)
= $P(W) - [55 + 10 \log (P)]$ (dB)
= $[30 + 10 \log (P)]$ (dBm) - $[55 + 10 \log (P)]$ (dB)
= -25dBm.



3.9 Frequency Stability

3.9.1 Description of Frequency Stability Measurement

The frequency stability shall be measured by variation of ambient temperature and variation of primary supply voltage to ensure that the fundamental emission stays within the authorized frequency block. The frequency stability of the transmitter shall be maintained within $\pm 0.00025\%$ ($\pm 2.5\text{ppm}$) of the center frequency.

3.9.2 Test Procedures for Temperature Variation

1. The testing follows ANSI C63.26 section 5.6.4
2. The EUT was set up in the thermal chamber and connected with the system simulator.
3. With power OFF, the temperature was decreased to -30°C and the EUT was stabilized before testing. Power was applied and the maximum change in frequency was recorded within one minute.
4. With power OFF, the temperature was raised in 10°C step up to 50°C . The EUT was stabilized at each step for at least half an hour. Power was applied and the maximum frequency change was recorded within one minute.

3.9.3 Test Procedures for Voltage Variation

1. The testing follows ANSI C63.26 section 5.6.5
2. The EUT was placed in a temperature chamber at $20\pm 5^{\circ}\text{C}$ and connected with the system simulator.
3. The power supply voltage to the EUT was varied from 85% to 115% of the nominal value for other than hand carried battery equipment.
4. For hand carried, battery powered equipment, reduce the primary ac or dc supply voltage to the battery operating end point, which shall be specified by the manufacturer.
5. The variation in frequency was measured for the worst case.

4 Radiated Test Items

4.1 Measuring Instruments

See list of measuring instruments of this test report.

4.2 Test Setup

4.2.1 For radiated test below 30MHz

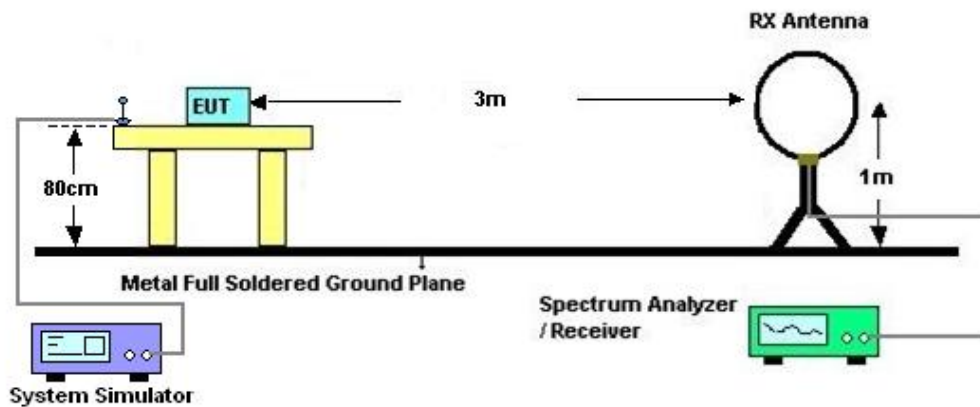

4.2.2 For radiated test from 30MHz to 1GHz

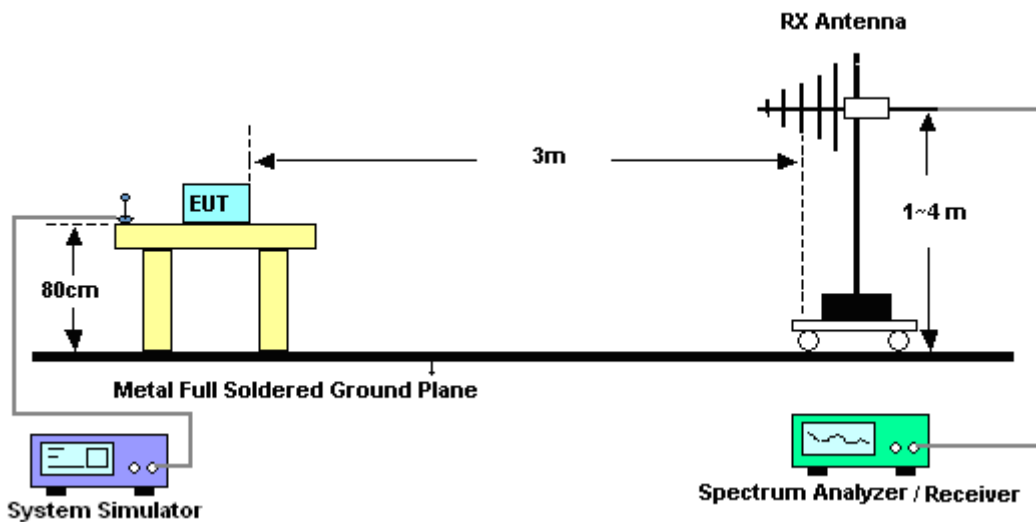

4.2.3 For radiated test above 1GHz

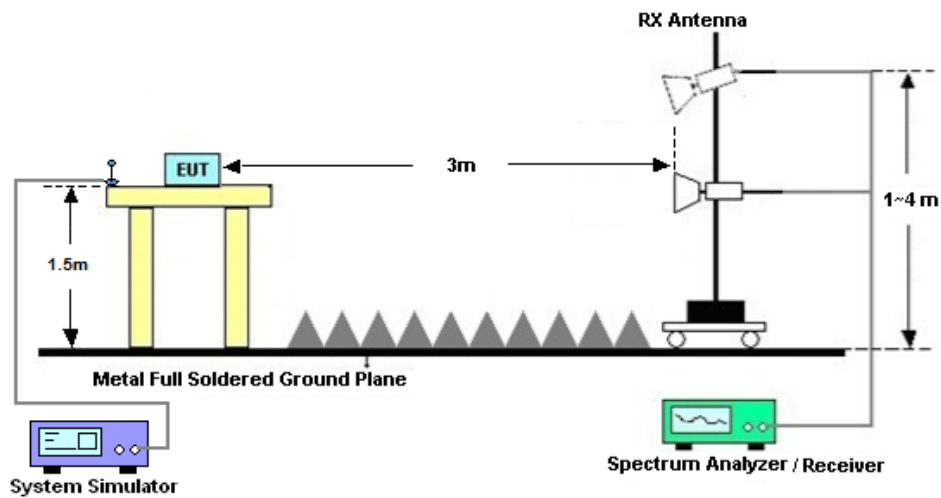

4.3 Test Result of Radiated Test

The low frequency, which started from 9 kHz to 30MHz, was pre-scanned and the result which was 20dB lower than the limit line was not reported.

Please refer to Appendix B.



4.4 Radiated Spurious Emission

4.4.1 Description of Radiated Spurious Emission

The radiated spurious emission was measured by substitution method according to ANSI C63.26. The power of any emission outside of the authorized operating frequency ranges must be attenuated below the transmitter power (P) by a factor of at least $43 + 10 \log (P)$ dB.

For Band 7, 38, 41

The power of any emission outside of the authorized operating frequency ranges must be attenuated below the transmitter power (P) by a factor of at least $55 + 10 \log (P)$ dB.

The spectrum is scanned from 30 MHz up to a frequency including its 10th harmonic.

4.4.2 Test Procedures

1. The testing follows ANSI C63.26 Section 5.5
2. The EUT was placed on a turntable with 0.8 meter height for frequency below 1GHz and 1.5 meter height for frequency above 1GHz respectively above ground.
3. The EUT was set 3 meters from the receiving antenna mounted on the antenna tower.
4. The table was rotated 360 degrees to determine the position of the highest spurious emission.
5. The height of the receiving antenna is varied between 1m to 4m to search the maximum spurious emission for both horizontal and vertical polarizations.
6. During the measurement, the system simulator parameters were set to force the EUT transmitting at maximum output power.
7. Make the measurement with the spectrum analyzer's RBW = 1MHz, VBW = 3MHz, taking the record of maximum spurious emission.
8. A horn antenna was substituted in place of the EUT and was driven by a signal generator.
9. Tune the output power of signal generator to the same emission level with EUT maximum spurious emission.
10. $EIRP (dBm) = S.G. Power - Tx Cable Loss + Tx Antenna Gain$
11. $ERP (dBm) = EIRP - 2.15$
12. The RF fundamental frequency should be excluded against the limit line in the operating frequency band.

The limit line is derived from $43 + 10\log(P)$ dB below the transmitter power P(Watts)
 $= P(W) - [43 + 10\log(P)] (dB)$
 $= [30 + 10\log(P)] (dBm) - [43 + 10\log(P)] (dB)$
 $= -13dBm.$

13. For Band 7, 38, 41:

The limit line is derived from $55 + 10\log(P)$ dB below the transmitter power P(Watts)



5 List of Measuring Equipment

Instrument	Manufacturer	Model No.	Serial No.	Characteristics	Calibration Date	Test Date	Due Date	Remark
Spectrum Analyzer	R&S	FSV40	101040	10Hz~40GHz	Oct. 14, 2021	Jun. 23, 2022~ Jul. 13, 2022	Oct. 13, 2022	Conducted (TH01-KS)
Power divider	STI	STI08-0055	-	0.5~40GHz	Aug. 26, 2021	Jun. 23, 2022~ Jul. 13, 2022	Aug. 25, 2022	Conducted (TH01-KS)
Temperature & humidity chamber	Hongzhan	LP-150U	H2014011440	-40~+150°C 20%~95%RH	Jul. 12, 2021	Jun. 23, 2022~ Jul. 13, 2022	Jul. 11, 2022	Conducted (TH01-KS)
Temperature & humidity chamber	Hongzhan	LP-150U	H2014011440	-40~+150°C 20%~95%RH	Jul. 11, 2022		Jul. 10, 2023	Conducted (TH01-KS)
EXA Spectrum Analyzer	Keysight	N9010B	MY57541079	10Hz-44G,MAX 30dB	Oct. 14, 2021	Jun. 29, 2022	Oct. 13, 2022	Radiation (03CH04-KS)
Loop Antenna	R&S	HFH2-Z2	100321	9kHz~30MHz	Oct. 30, 2021	Jun. 29, 2022	Oct. 29, 2022	Radiation (03CH04-KS)
Bilog Antenna	TeseQ	CBL6111D	49922	30MHz-1GHz	May 30, 2022	Jun. 29, 2022	May 29, 2023	Radiation (03CH04-KS)
Horn Antenna	Schwarzbeck	BBHA9120D	1284	1GHz~18GHz	Oct. 18, 2021	Jun. 29, 2022	Oct. 17, 2022	Radiation (03CH04-KS)
SHF-EHF Horn	Com-power	AH-840	101070	18GHz~40GHz	Jan. 05, 2022	Jun. 29, 2022	Jan. 04, 2023	Radiation (03CH04-KS)
Amplifier	SONOMA	310N	187289	9KHz-1GHz	Jan. 05, 2022	Jun. 29, 2022	Jan. 04, 2023	Radiation (03CH04-KS)
Amplifier	MITEQ	EM18G40G GA	060728	18~40GHz	Jan. 05, 2022	Jun. 29, 2022	Jan. 04, 2023	Radiation (03CH04-KS)
high gain Amplifier	MITEQ	AMF-7D-00 101800-30-1 0P	2025788	1Ghz-18Ghz	Jul. 30, 2021	Jun. 29, 2022	Jul. 29, 2022	Radiation (03CH04-KS)
Amplifier	Keysight	83017A	MY57280106	500MHz~26.5GHz	Oct. 13, 2021	Jun. 29, 2022	Oct. 12, 2022	Radiation (03CH04-KS)
AC Power Source	Chroma	61601	F104090004	N/A	NCR	Jun. 29, 2022	NCR	Radiation (03CH04-KS)
Turn Table	ChamPro	EM 1000-T	060762-T	0~360 degree	NCR	Jun. 29, 2022	NCR	Radiation (03CH04-KS)
Antenna Mast	ChamPro	EM 1000-A	060762-A	1 m~4 m	NCR	Jun. 29, 2022	NCR	Radiation (03CH04-KS)

NCR: No Calibration Required



6 Uncertainty of Evaluation

The measurement uncertainties shown below were calculated in accordance with the requirements of ANSI 63.26-2015. All the measurement uncertainty value were shown with a coverage K=2 to indicate 95% level of confidence. The measurement data show herein meets or exceeds the CISPR measurement uncertainty values specified in CISPR 16-4-2 and can be compared directly to specified limit to determine compliance.

Uncertainty of Conducted Measurement

Test Item	Uncertainty
Conducted Power	0.56 dB
Conducted Emissions	0.92 dB
Occupied Channel Bandwidth	0.03 %
Conducted Power Spectral Density	0.54 dB
Frequency tolerance	0.414ppm

Uncertainty of Radiated Emission Measurement (30 MHz ~ 1000 MHz)

Measuring Uncertainty for a Level of Confidence of 95% (U = 2Uc(y))	3.3dB
---	-------

Uncertainty of Radiated Emission Measurement (1 GHz ~ 18 GHz)

Measuring Uncertainty for a Level of Confidence of 95% (U = 2Uc(y))	2.8dB
---	-------

Uncertainty of Radiated Emission Measurement (18 GHz ~ 40 GHz)

Measuring Uncertainty for a Level of Confidence of 95% (U = 2Uc(y))	2.8dB
---	-------



Appendix A. Test Results of Conducted Test

Test Engineer :	Lex Wu	Temperature :	24~26°C
		Relative Humidity :	50~53%

Conducted Output Power(Average power) and EIRP

LTE Band 7:

BW [MHz]	Modulation	RB Size	RB Offset	Power Low Ch. / Freq.	Power Middle Ch. / Freq.	Power High Ch. / Freq.	EIRP(W)		
Channel				20850	20850	21350			
Frequency (MHz)				2510	2535	2560	L	M	H
20	QPSK	1	0	24.60	24.73	24.68	0.2070	0.2133	0.2109
20	QPSK	1	99	24.58	24.34	24.56	0.2061	0.1950	0.2051
20	QPSK	100	0	23.21	23.44	23.35	0.1503	0.1585	0.1552
20	16QAM	1	0	23.41	23.79	23.37	0.1574	0.1718	0.1560
20	64QAM	1	0	22.29	22.35	22.02	0.1216	0.1233	0.1143
20	256QAM	1	0	19.70	19.89	19.72	0.0670	0.0700	0.0673
Channel				20825	21100	21375	EIRP(W)		
Frequency (MHz)				2507.5	2535	2562.5	L	M	H
15	QPSK	1	0	24.23	24.70	24.40	0.1901	0.2118	0.1977
15	16QAM	1	0	23.48	23.78	23.46	0.1600	0.1714	0.1592
Channel				20800	21100	21400	EIRP(W)		
Frequency (MHz)				2505	2535	2565	L	M	H
10	QPSK	1	0	24.23	24.67	24.42	0.1901	0.2104	0.1986
10	16QAM	1	0	23.51	23.78	23.43	0.1611	0.1714	0.1581
Channel				20775	21100	21425	EIRP(W)		
Frequency (MHz)				2502.5	2535	2567.5	L	M	H
5	QPSK	1	0	24.22	24.68	24.43	0.1897	0.2109	0.1991
5	16QAM	1	0	23.48	23.78	23.46	0.1600	0.1714	0.1592



LTE Band 38:

BW [MHz]	Modulation	RB Size	RB Offset	Power Low Ch. / Freq.	Power Middle Ch. / Freq.	Power High Ch. / Freq.	EIRP(W)		
Channel				37850	38000	38150			
Frequency (MHz)				2580	2595	2610	L	M	H
20	QPSK	1	0	24.29	24.45	24.20	0.1928	0.2000	0.1888
20	QPSK	1	99	24.31	24.05	24.06	0.1936	0.1824	0.1828
20	QPSK	100	0	23.12	23.16	23.05	0.1472	0.1486	0.1449
20	16QAM	1	0	22.98	23.04	23.18	0.1426	0.1445	0.1493
20	64QAM	1	0	22.44	21.95	21.92	0.1259	0.1125	0.1117
20	256QAM	1	0	19.41	19.48	19.44	0.0627	0.0637	0.0631
Channel				37825	38000	38175	EIRP(W)		
Frequency (MHz)				2577.5	2595	2612.5	L	M	H
15	QPSK	1	0	24.21	24.42	24.08	0.1892	0.1986	0.1837
15	16QAM	1	0	22.98	22.93	23.14	0.1426	0.1409	0.1479
Channel				37800	38000	38200	EIRP(W)		
Frequency (MHz)				2575	2595	2615	L	M	H
10	QPSK	1	0	24.26	24.39	24.19	0.1914	0.1972	0.1884
10	16QAM	1	0	22.93	22.92	23.09	0.1409	0.1406	0.1462
Channel				37775	38000	38225	EIRP(W)		
Frequency (MHz)				2572.5	2595	2617.5	L	M	H
5	QPSK	1	0	24.29	24.35	24.14	0.1928	0.1954	0.1862
5	16QAM	1	0	23.10	23.02	22.84	0.1466	0.1439	0.1380

LTE Band 41:

BW [MHz]	Modulation	RB Size	RB Offset	Power Low Ch. / Freq.	Power Middle Ch. / Freq.	Power High Ch. / Freq.	EIRP(W)		
Channel				39750	40620	41490			
Frequency (MHz)				2506	2593	2680	L	M	H
20	QPSK	1	0	23.98	24.56	24.16	0.1795	0.2051	0.1871
20	QPSK	1	99	23.88	24.06	24.09	0.1754	0.1828	0.1841
20	QPSK	100	0	23.09	23.41	23.23	0.1462	0.1574	0.1510
20	16QAM	1	0	22.74	23.61	23.23	0.1349	0.1648	0.1510
20	64QAM	1	0	21.90	22.43	22.43	0.1112	0.1256	0.1256
20	256QAM	1	0	19.53	19.70	19.60	0.0644	0.0670	0.0655
Channel				39725	40620	41515	EIRP(W)		
Frequency (MHz)				2503.5	2593	2682.5	L	M	H
15	QPSK	1	0	24.02	24.49	24.20	0.1811	0.2018	0.1888
15	16QAM	1	0	23.11	23.51	23.26	0.1469	0.1611	0.1521
Channel				39700	40620	41540	EIRP(W)		
Frequency (MHz)				2501	2593	2685	L	M	H
10	QPSK	1	0	24.13	24.55	24.21	0.1858	0.2046	0.1892
10	16QAM	1	0	22.81	23.45	23.38	0.1371	0.1589	0.1563
Channel				39675	40620	41565	EIRP(W)		
Frequency (MHz)				2498.5	2593	2687.5	L	M	H
5	QPSK	1	0	24.03	24.51	24.29	0.1816	0.2028	0.1928
5	16QAM	1	0	23.06	22.97	23.57	0.1452	0.1422	0.1633



LTE Band 7C_CA:

Combination 20MHz+20MHz (100RB+100RB)							
Channel	Modulation	PCC		SCC		Measured Power	EIRP(W)
		RB Size	RB offset	RB Size	RB offset		
L	QPSK	1	Max	1	0	22.31	0.1222
M	QPSK	1	Max	1	0	15.72	0.0268
H	QPSK	1	Max	1	0	24.14	0.1862
L	16QAM	1	Max	1	0	21.32	0.0973
M	16QAM	1	Max	1	0	16.02	0.0287
H	16QAM	1	Max	1	0	23.46	0.1592
L	64QAM	1	Max	1	0	21.23	0.0953
M	64QAM	1	Max	1	0	15.86	0.0277
H	64QAM	1	Max	1	0	23.41	0.1574
L	256QAM	1	Max	1	0	19.28	0.0608
M	256QAM	1	Max	1	0	15.96	0.0283
H	256QAM	1	Max	1	0	19.49	0.0638
Combination 20MHz+15MHz (100RB+75RB)							
Channel	Modulation	PCC		SCC		Measured Power	EIRP(W)
		RB Size	RB offset	RB Size	RB offset		
H	QPSK	1	Max	1	0	24.01	0.1807
H	16QAM	1	Max	1	0	23.26	0.1521
Combination 15MHz+20MHz (75RB+100RB)							
Channel	Modulation	PCC		SCC		Measured Power	EIRP(W)
		RB Size	RB offset	RB Size	RB offset		
H	QPSK	1	Max	1	0	24.09	0.1841
H	16QAM	1	Max	1	0	23.37	0.1560
Combination 15MHz+15MHz (75RB+75RB)							
Channel	Modulation	PCC		SCC		Measured Power	EIRP(W)
		RB Size	RB offset	RB Size	RB offset		
H	QPSK	1	Max	1	0	23.98	0.1795
H	16QAM	1	Max	1	0	23.29	0.1531
Combination 20MHz+10MHz (100RB+50RB)							
Channel	Modulation	PCC		SCC		Measured Power	EIRP(W)
		RB Size	RB offset	RB Size	RB offset		
H	QPSK	1	Max	1	0	23.94	0.1778
H	16QAM	1	Max	1	0	23.28	0.1528
Combination 10MHz+20MHz (50RB+100RB)							
Channel	Modulation	PCC		SCC		Measured Power	EIRP(W)
		RB Size	RB offset	RB Size	RB offset		
H	QPSK	1	Max	1	0	24.03	0.1816
H	16QAM	1	Max	1	0	23.40	0.1570
Combination 15MHz+10MHz (75RB+50RB)							
Channel	Modulation	PCC		SCC		Measured Power	EIRP(W)
		RB Size	RB offset	RB Size	RB offset		
H	QPSK	1	Max	1	0	23.91	0.1766
H	16QAM	1	Max	1	0	23.22	0.1507



LTE Band 38C_CA:

Combination 20MHz+20MHz (100RB+100RB)							
Channel	Modulation	PCC		SCC		Measured Power	EIRP(W)
		RB Size	RB offset	RB Size	RB offset		
L	QPSK	1	Max	1	0	22.03	0.1146
M	QPSK	1	Max	1	0	15.52	0.0256
H	QPSK	1	Max	1	0	23.99	0.1799
L	16QAM	1	Max	1	0	21.04	0.0912
M	16QAM	1	Max	1	0	15.51	0.0255
H	16QAM	1	Max	1	0	22.96	0.1419
L	64QAM	1	Max	1	0	21.03	0.0910
M	64QAM	1	Max	1	0	15.54	0.0257
H	64QAM	1	Max	1	0	22.01	0.1140
L	256QAM	1	Max	1	0	19.36	0.0619
M	256QAM	1	Max	1	0	15.57	0.0259
H	256QAM	1	Max	1	0	18.99	0.0569
Combination 15MHz+15MHz (75RB+75RB)							
Channel	Modulation	PCC		SCC		Measured Power	EIRP(W)
		RB Size	RB offset	RB Size	RB offset		
H	QPSK	1	Max	1	0	23.90	0.1762
H	16QAM	1	Max	1	0	22.90	0.1400



LTE Band 7

Peak-to-Average Ratio

Mode	LTE Band 7 / 20MHz				
Mod.	QPSK	16QAM	64QAM	256QAM	Limit: 13dB
RB Size	Full RB	Full RB	Full RB	Full RB	Result
Middle CH	4.52	5.68	6.38	6.52	PASS

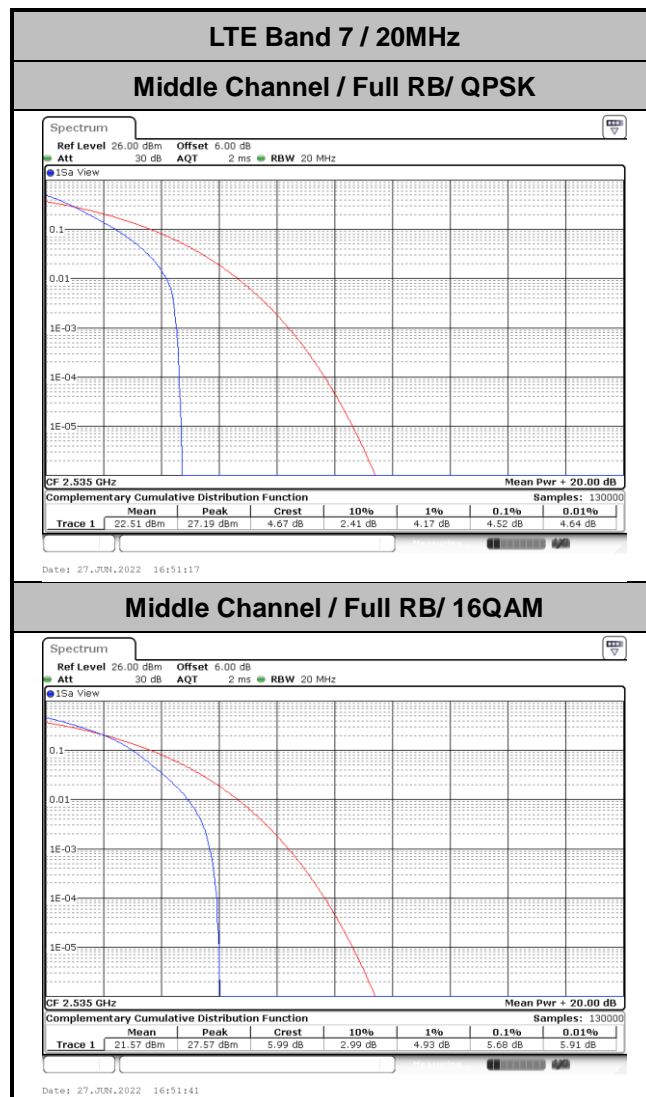

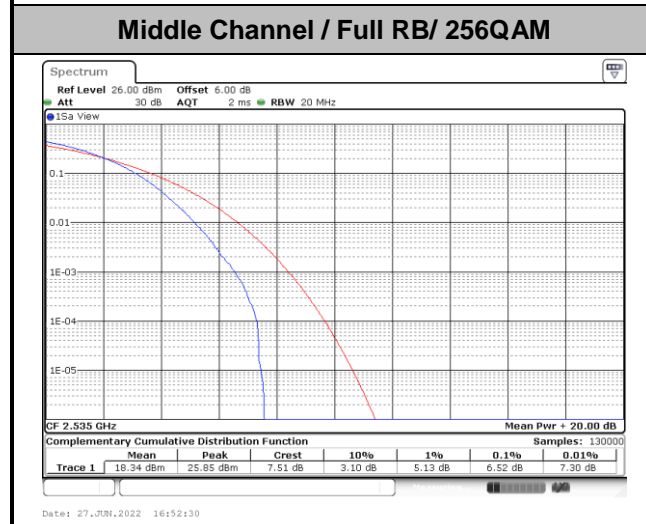
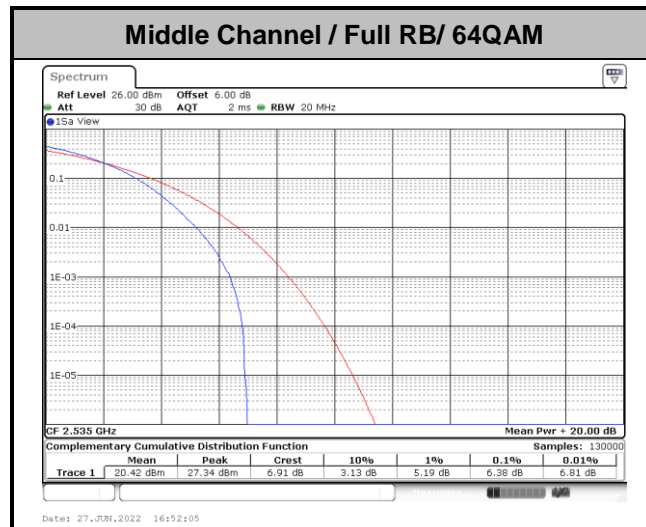



26dB Bandwidth

Mode	LTE Band 7 : 26dB BW(MHz)	
BW	20MHz	
Mod.	QPSK	16QAM
Middle CH	18.94	18.82

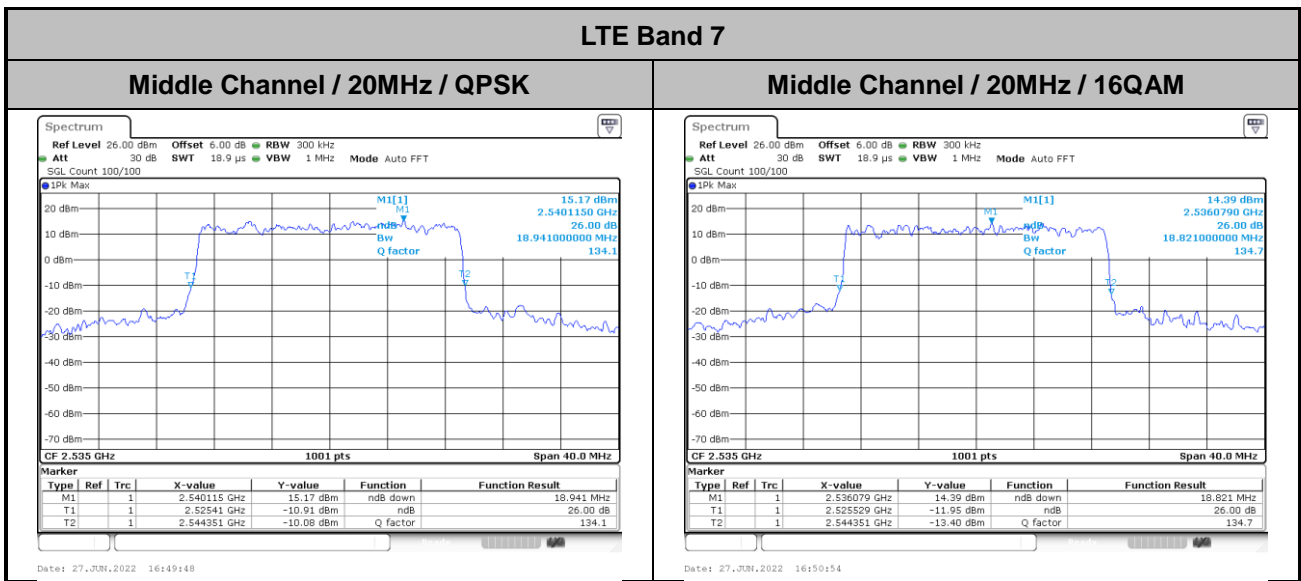



Occupied Bandwidth

Mode	LTE Band 7 : 99%OBW(MHz)	
BW	20MHz	
Mod.	QPSK	16QAM
Middle CH	17.90	17.94

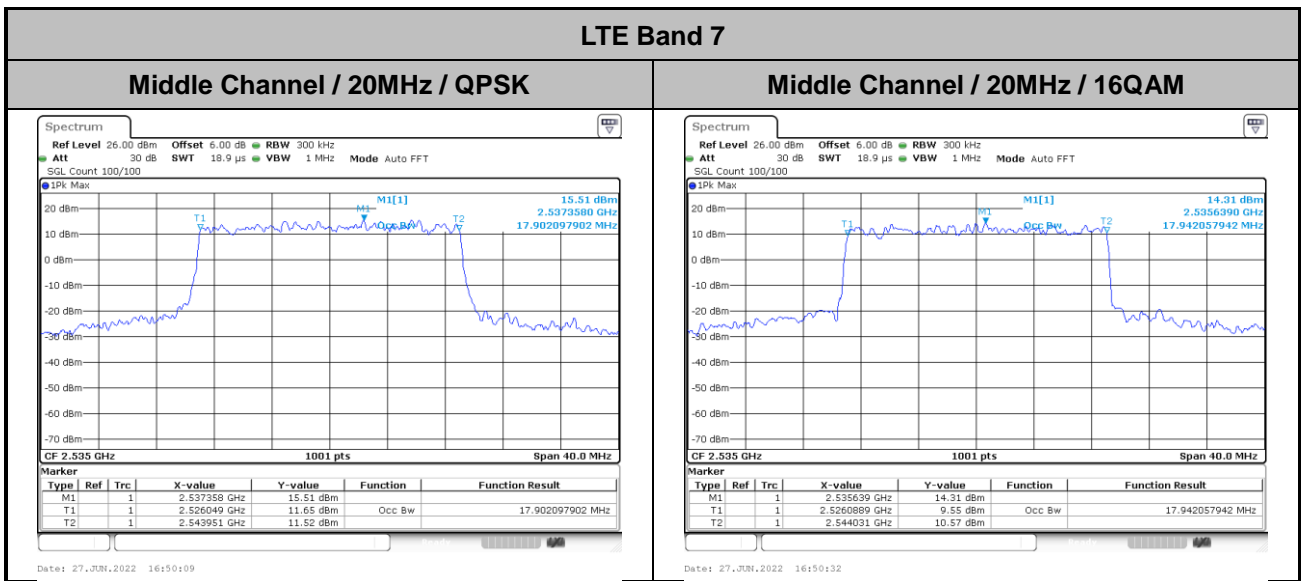



Conducted Band Edge

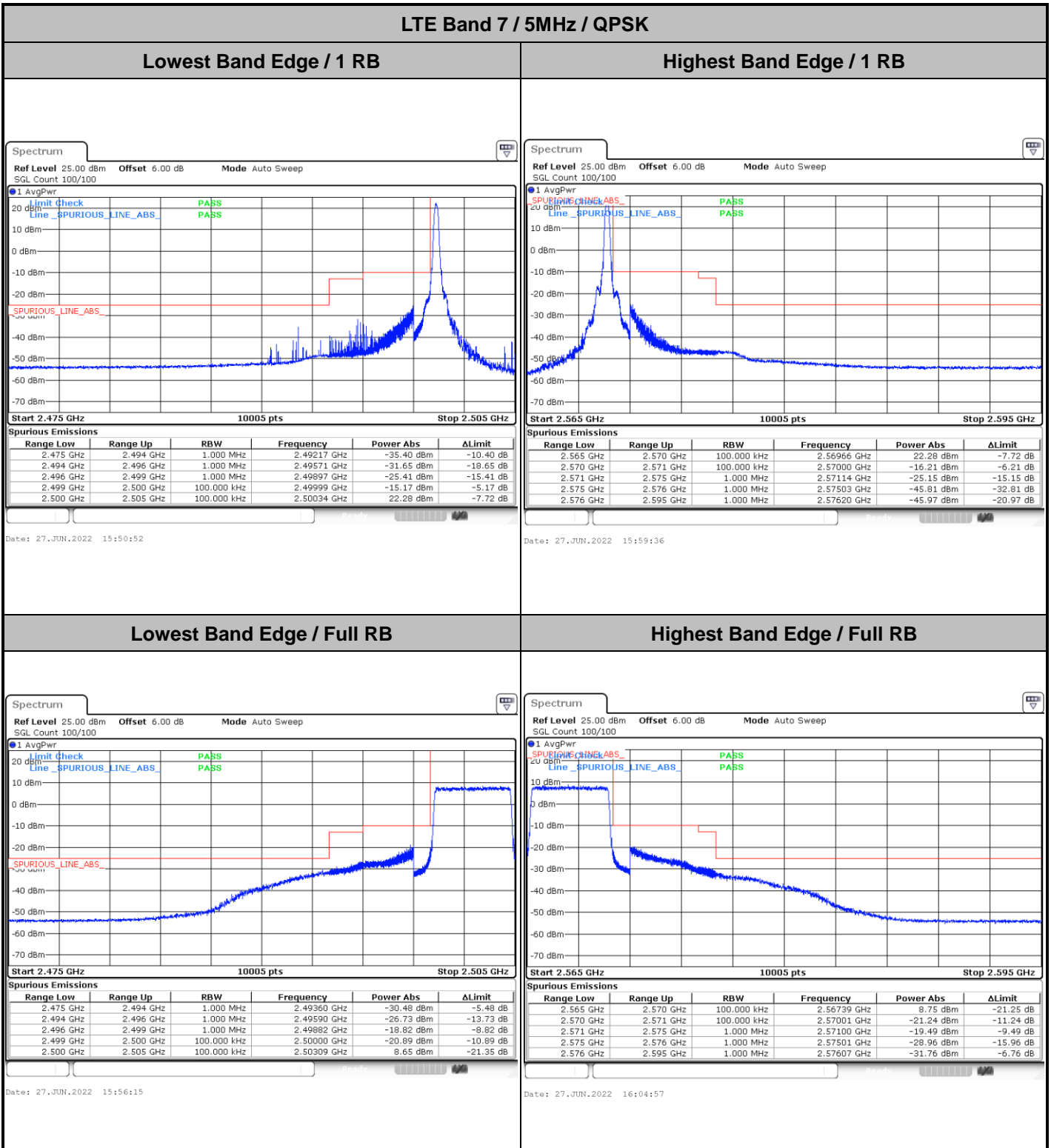



LTE Band 7 / 5MHz / 16QAM

Lowest Band Edge / 1RB

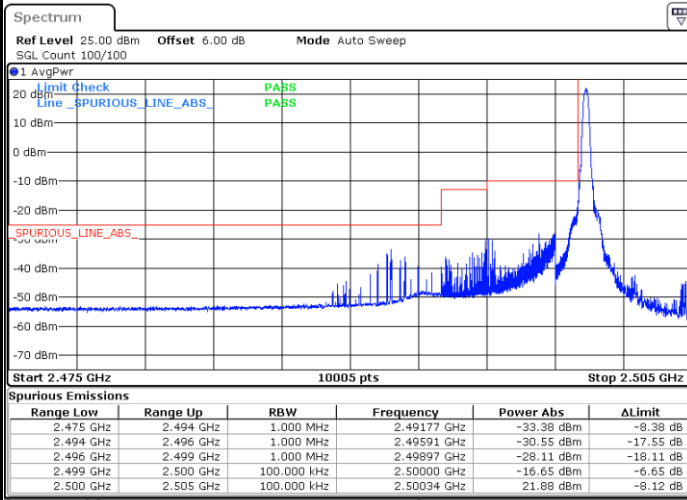

Date: 27 JUN.2022 15:51:33

Highest Band Edge / 1 RB

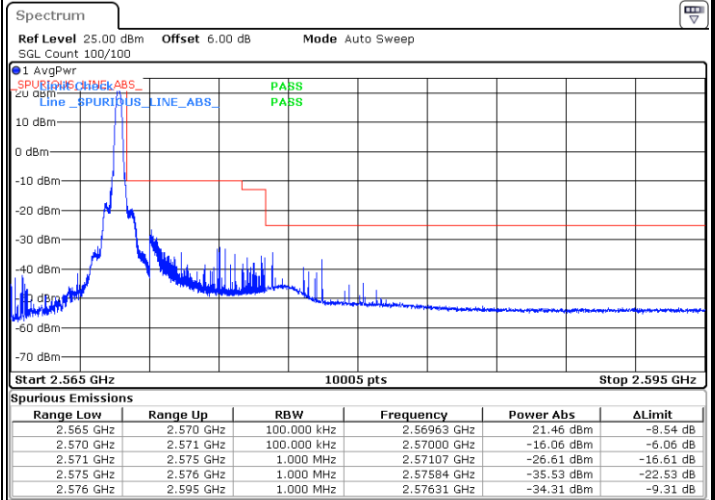

Date: 27 JUN.2022 16:00:16

Lowest Band Edge / Full RB

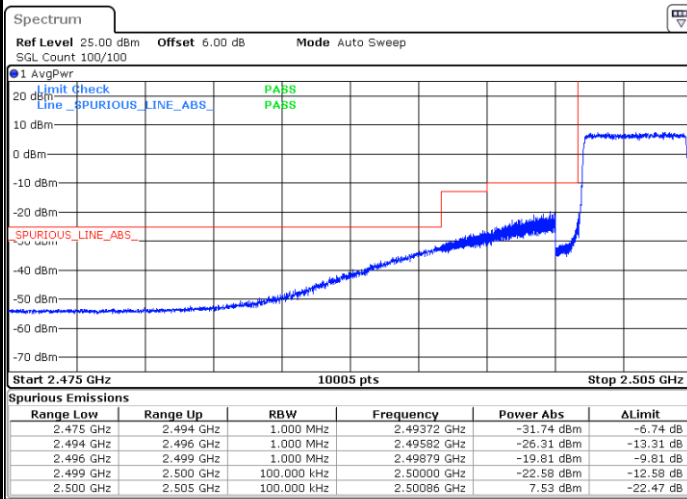

Date: 27 JUN.2022 15:55:34

Highest Band Edge / Full RB

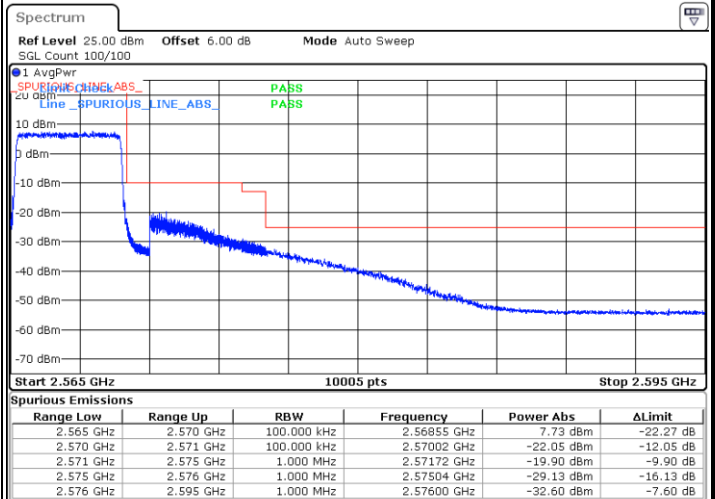

Date: 27 JUN.2022 16:04:16



LTE Band 7 / 5MHz / 64QAM

Lowest Band Edge / 1RB

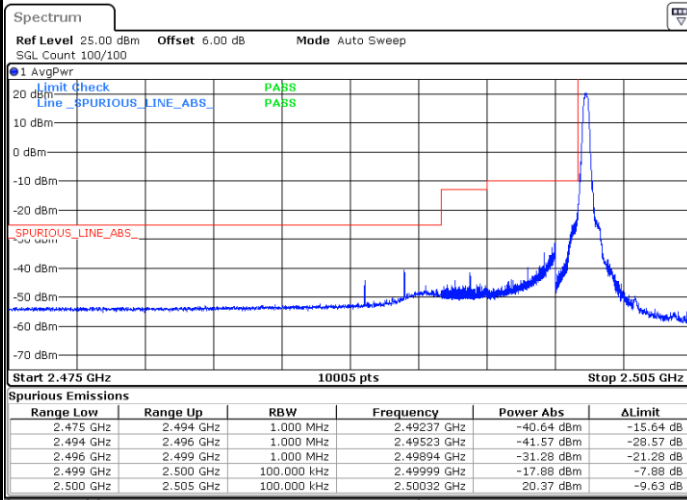

Date: 27 JUN 2022 15:52:13

Highest Band Edge / 1 RB

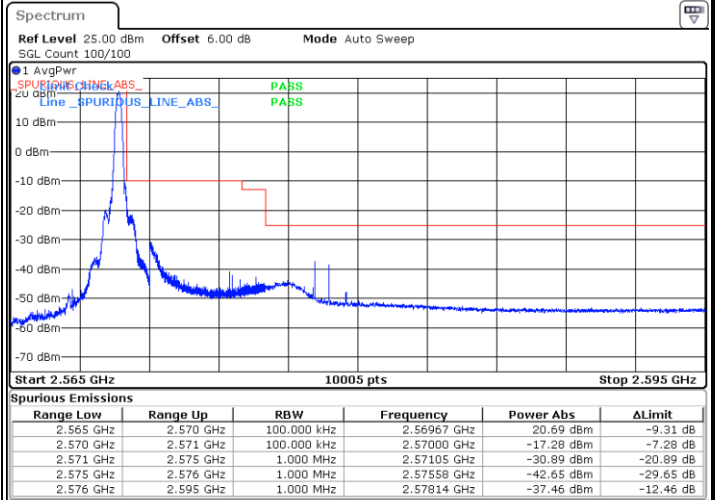

Date: 27 JUN 2022 16:00:57

Lowest Band Edge / Full RB

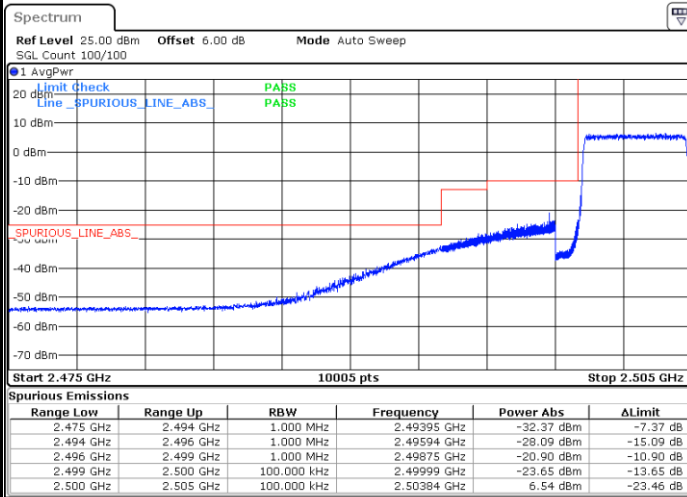

Date: 27 JUN 2022 15:54:54

Highest Band Edge / Full RB

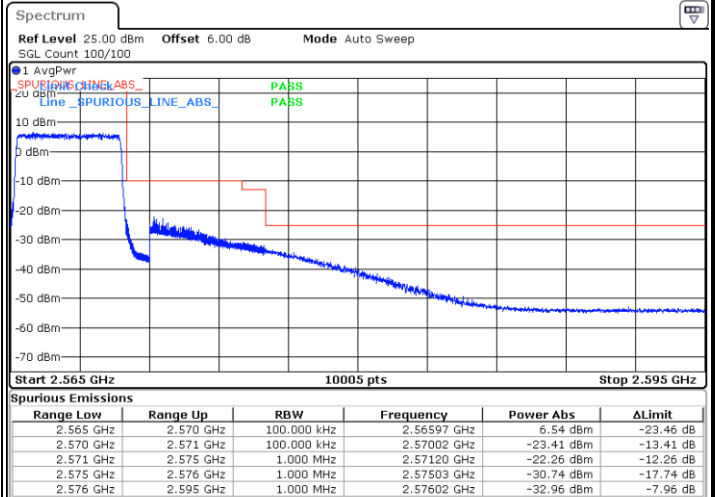

Date: 27 JUN 2022 16:03:36



LTE Band 7 / 5MHz /256QAM

Lowest Band Edge / 1RB

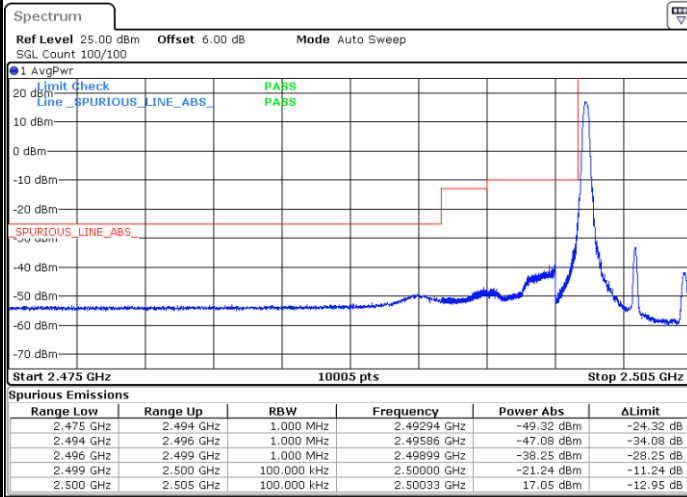

Date: 27 JUN 2022 15:52:54

Highest Band Edge / 1 RB

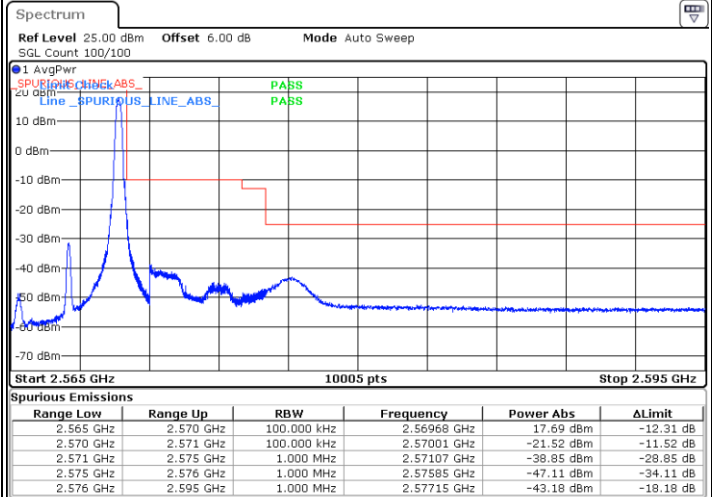

Date: 27 JUN 2022 16:01:37

Lowest Band Edge / Full RB

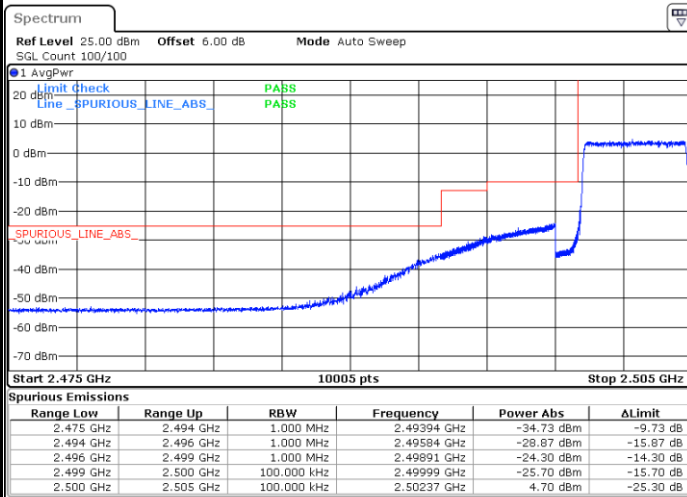

Date: 27 JUN 2022 15:54:10

Highest Band Edge / Full RB

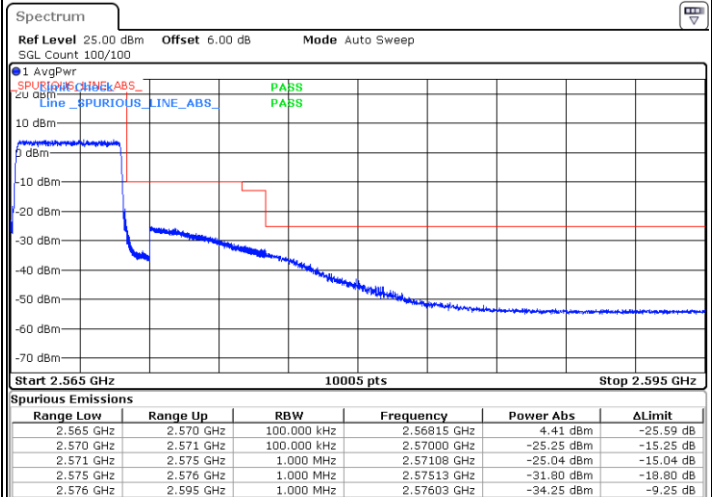

Date: 27 JUN 2022 16:02:52



LTE Band 7 / 10MHz / QPSK

Lowest Band Edge / 1 RB

Highest Band Edge / 1 RB

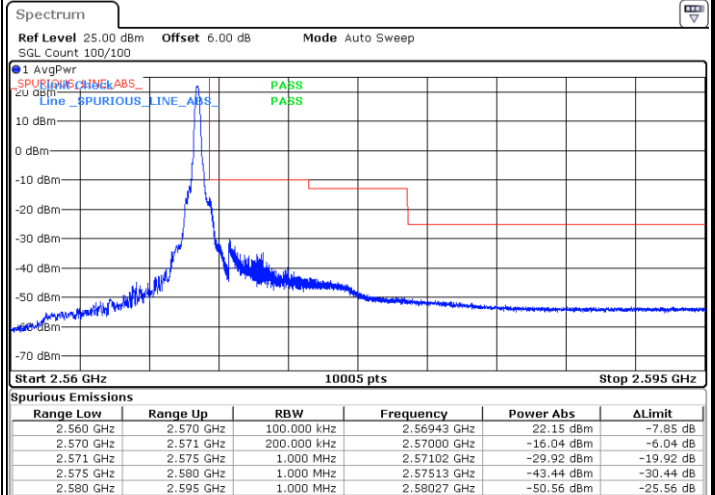
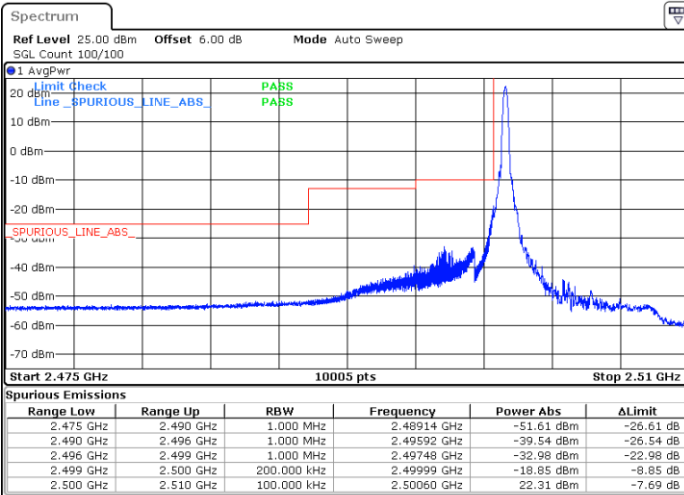

Date: 27 JUN 2022 16:06:59

Date: 27 JUN 2022 16:15:06

Lowest Band Edge / Full RB

Highest Band Edge / Full RB

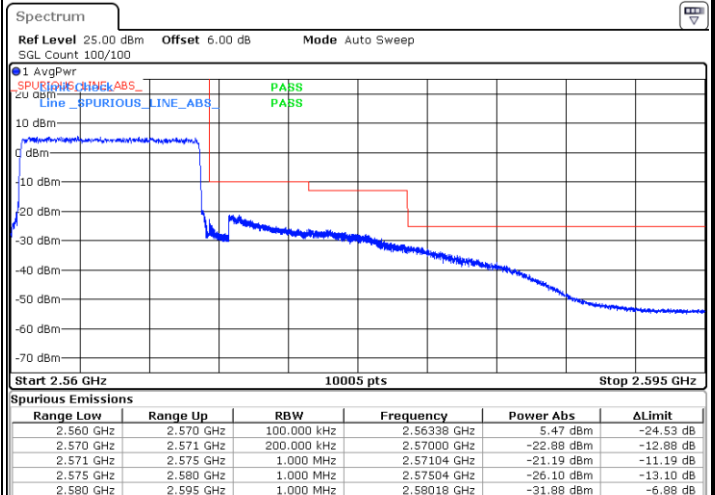
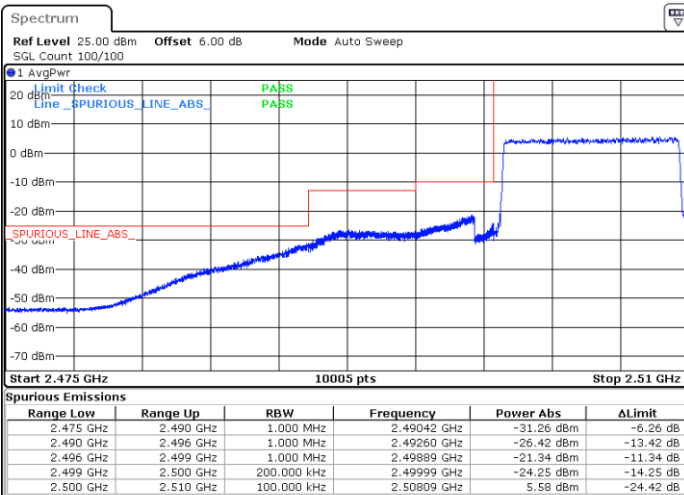

Date: 27 JUN 2022 16:11:46

Date: 27 JUN 2022 16:19:52



LTE Band 7 / 10MHz / 16QAM

Lowest Band Edge / 1 RB

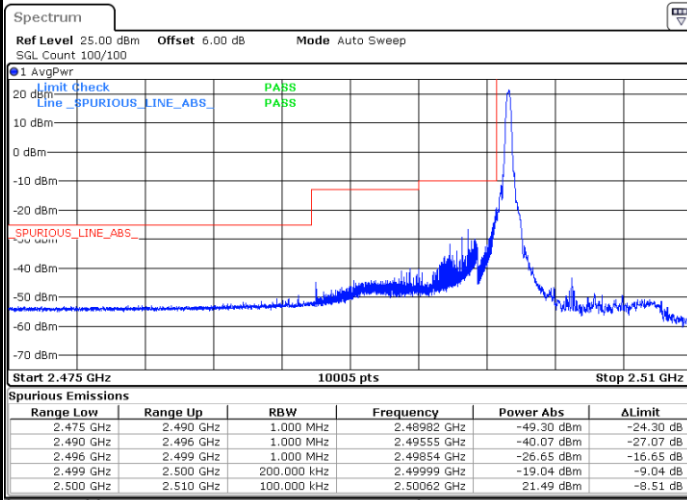

Date: 27 JUN.2022 16:07:40

Highest Band Edge / 1 RB

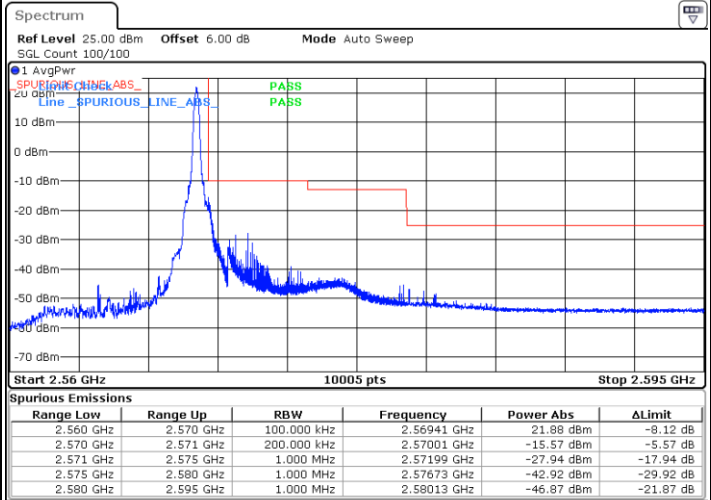

Date: 27 JUN.2022 16:15:47

Lowest Band Edge / Full RB

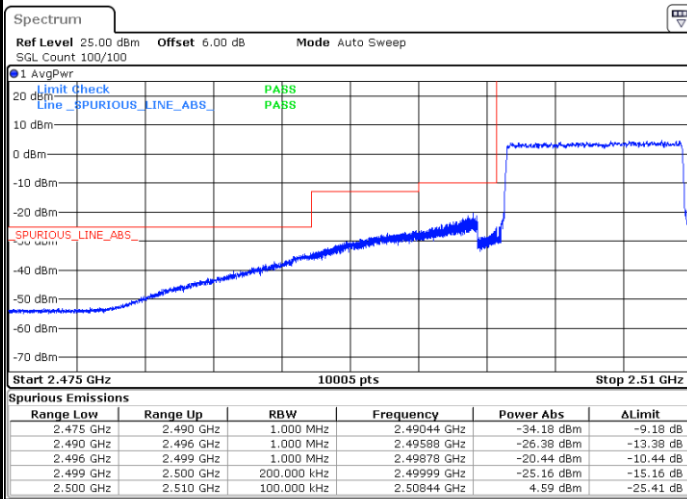

Date: 27 JUN.2022 16:11:05

Highest Band Edge / Full RB

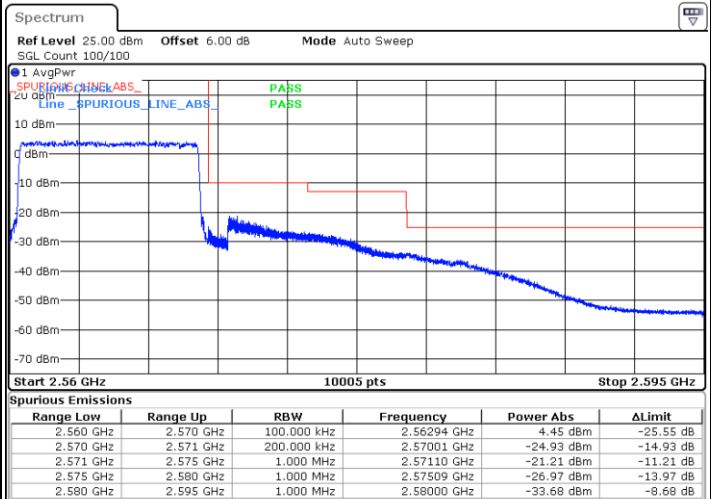

Date: 27 JUN.2022 16:19:12



LTE Band 7 / 10MHz / 64QAM

Lowest Band Edge / 1 RB

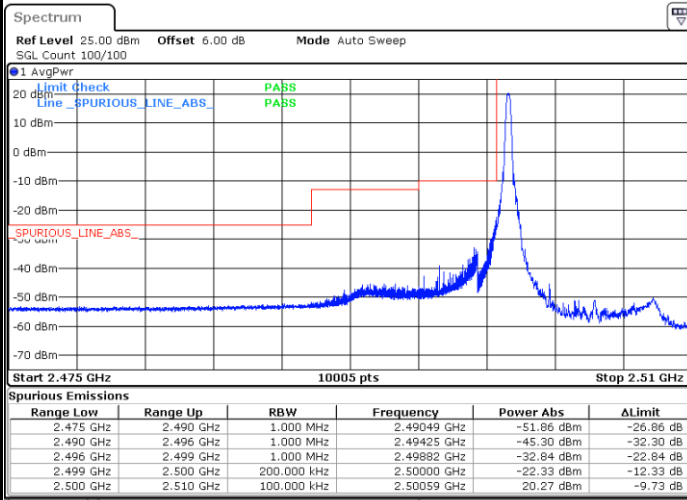

Date: 27 JUN 2022 16:08:20

Highest Band Edge / 1 RB

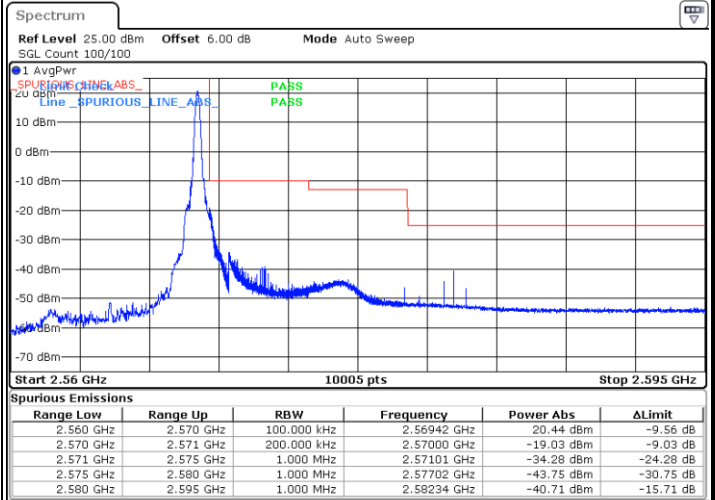

Date: 27 JUN 2022 16:16:27

Lowest Band Edge / Full RB

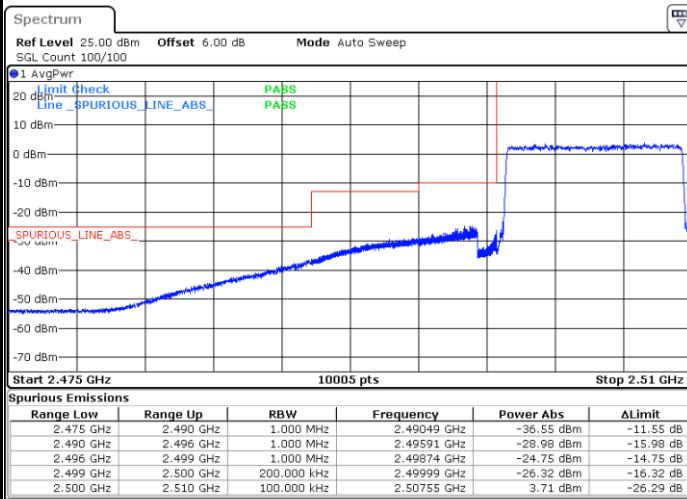

Date: 27 JUN 2022 16:10:25

Highest Band Edge / Full RB

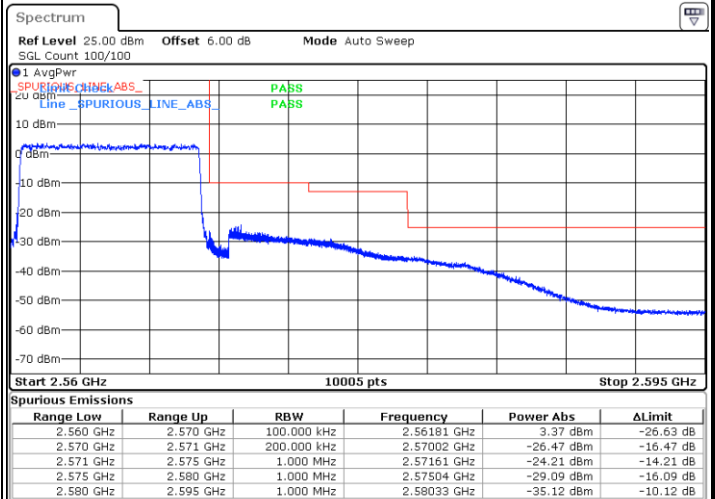

Date: 27 JUN 2022 16:18:31



LTE Band 7 / 10MHz / 256QAM

Lowest Band Edge / 1 RB

Highest Band Edge / 1 RB

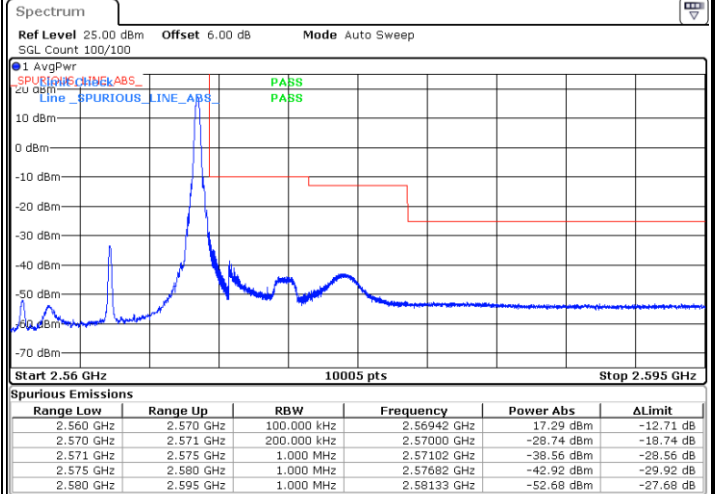
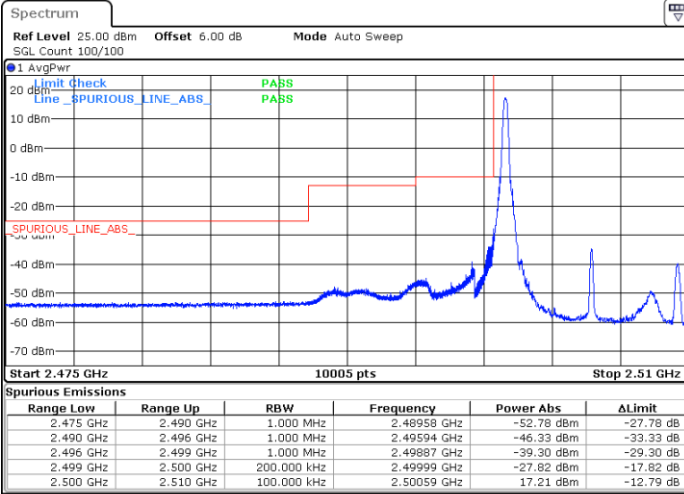

Date: 27 JUN 2022 16:09:01

Date: 27 JUN 2022 16:17:07

Lowest Band Edge / Full RB

Highest Band Edge / Full RB

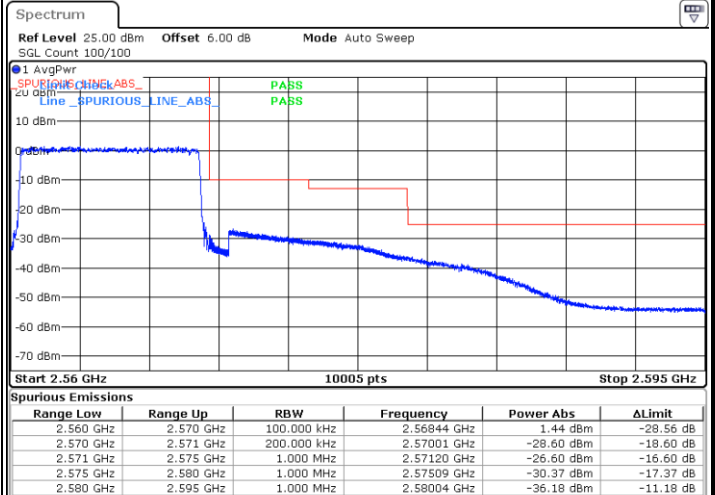
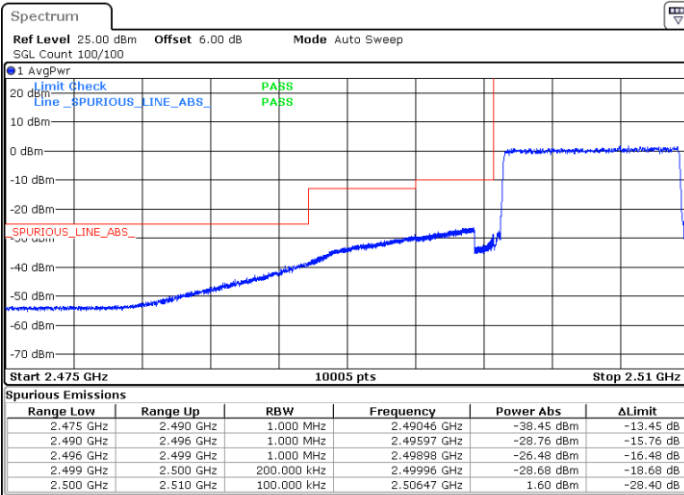

Date: 27 JUN 2022 16:09:44

Date: 27 JUN 2022 16:17:51



LTE Band 7 / 15MHz / QPSK

Lowest Band Edge / 1 RB

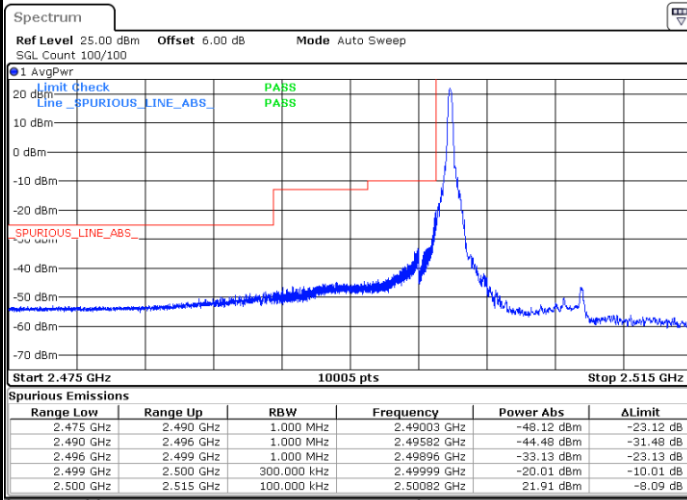

Date: 27 JUN 2022 16:21:55

Highest Band Edge / 1 RB

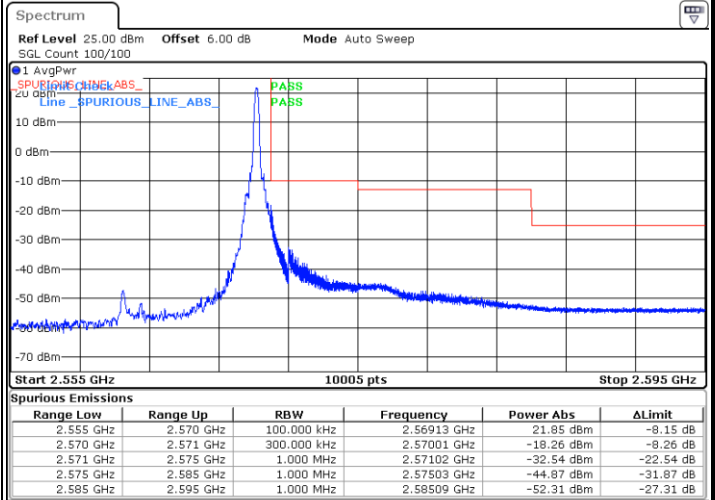

Date: 27 JUN 2022 16:30:03

Lowest Band Edge / Full RB

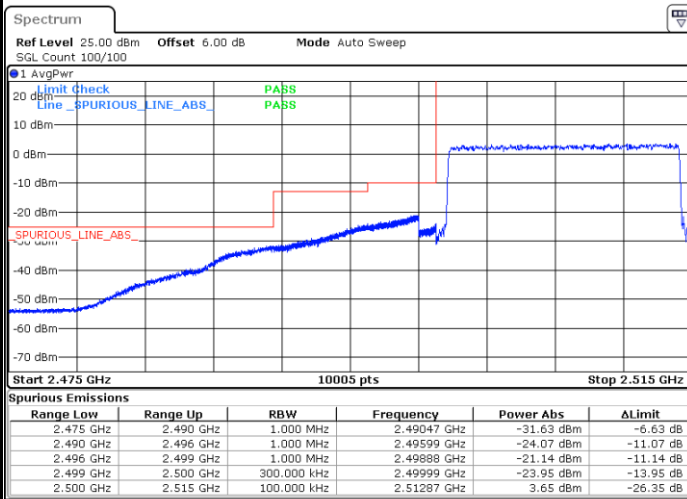

Date: 27 JUN 2022 16:26:42

Highest Band Edge / Full RB

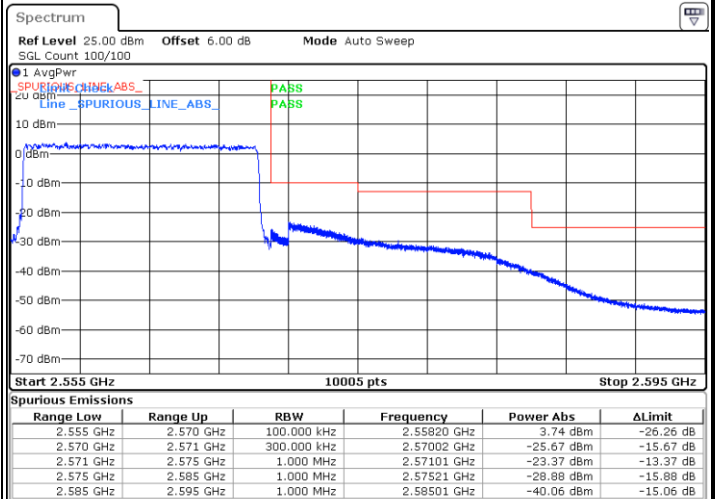

Date: 27 JUN 2022 16:35:21



LTE Band 7 / 15MHz / 16QAM

Lowest Band Edge / 1 RB

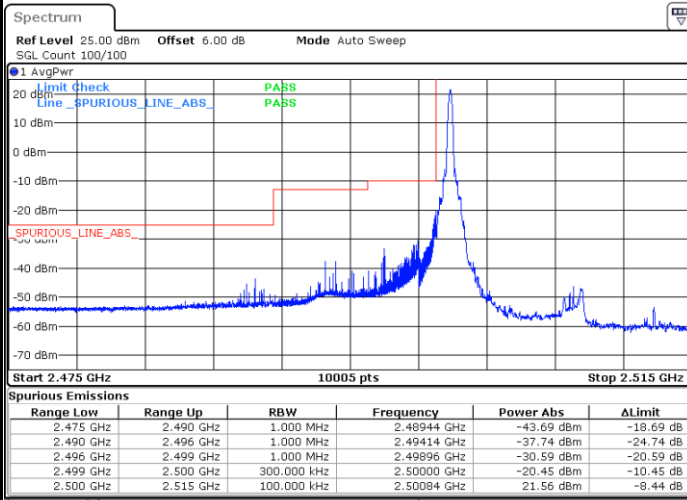

Date: 27 JUN.2022 16:22:35

Highest Band Edge / 1 RB

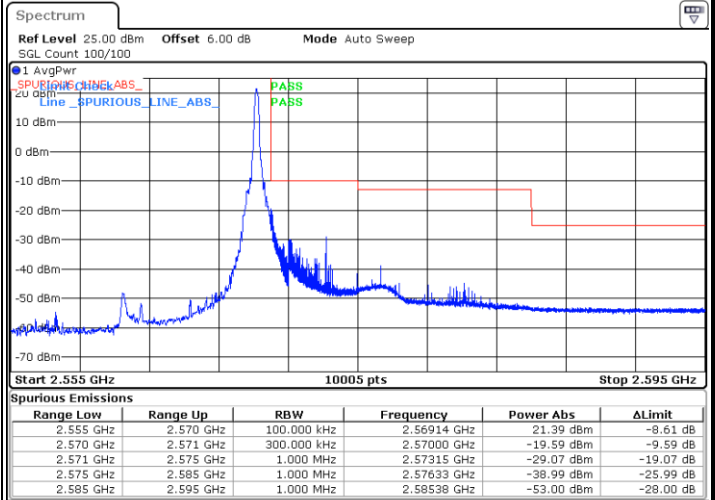

Date: 27 JUN.2022 16:30:43

Lowest Band Edge / Full RB

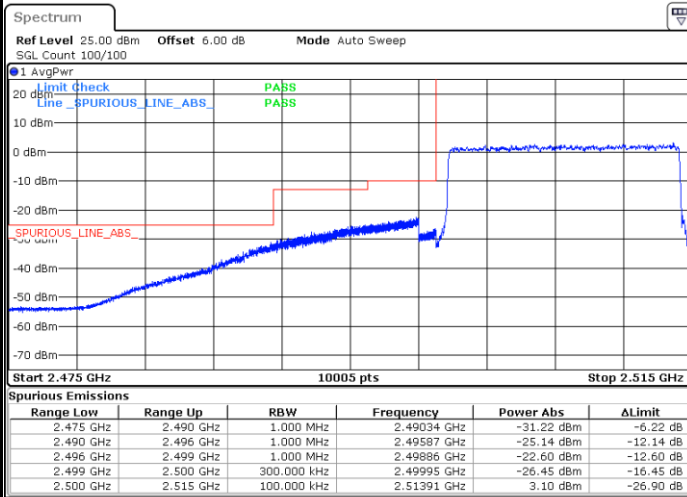

Date: 27 JUN.2022 16:26:02

Highest Band Edge / Full RB

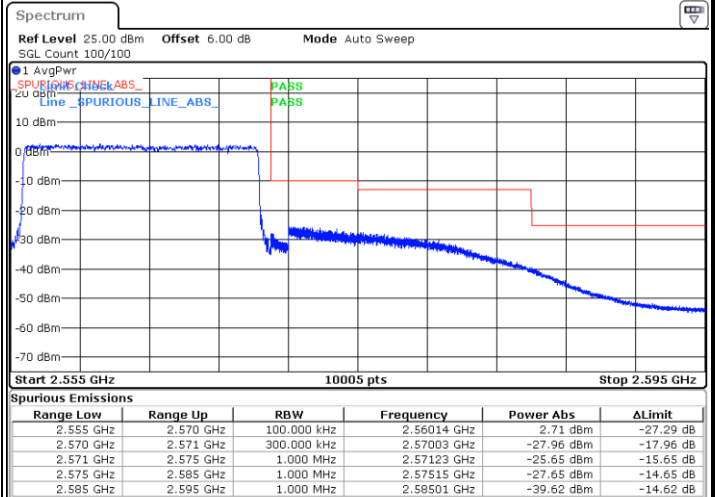

Date: 27 JUN.2022 16:34:40



LTE Band 7 / 15MHz / 64QAM

Lowest Band Edge / 1 RB

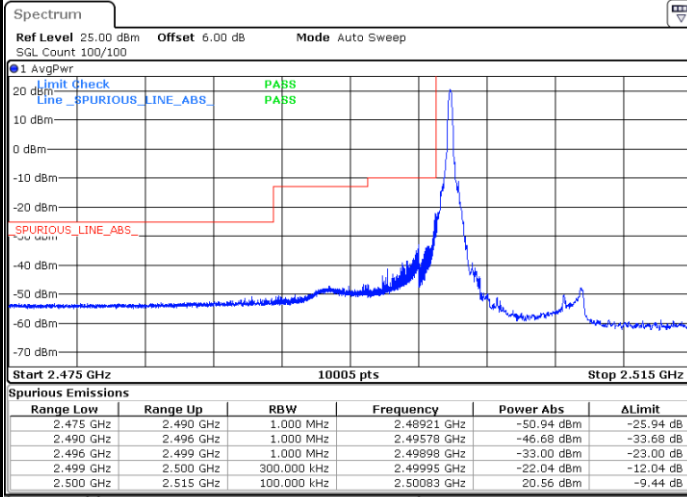

Date: 27 JUN.2022 16:23:16

Highest Band Edge / 1 RB

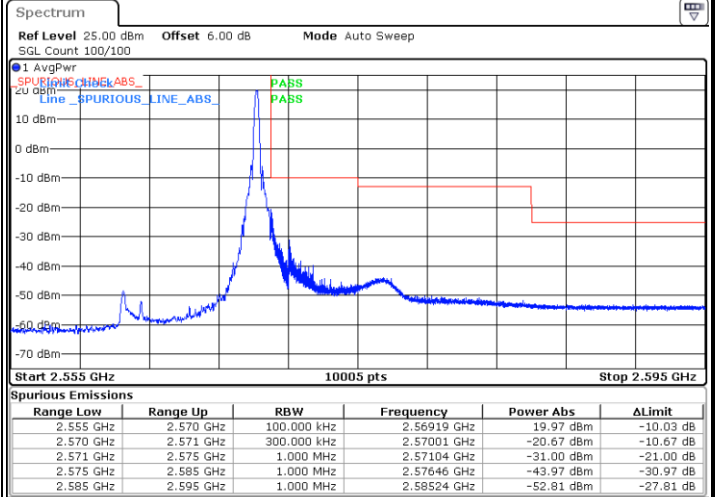

Date: 27 JUN.2022 16:31:24

Lowest Band Edge / Full RB

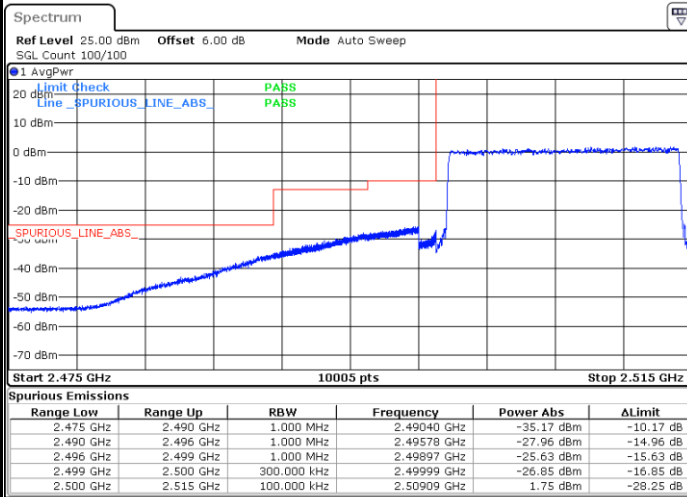

Date: 27 JUN.2022 16:25:21

Highest Band Edge / Full RB

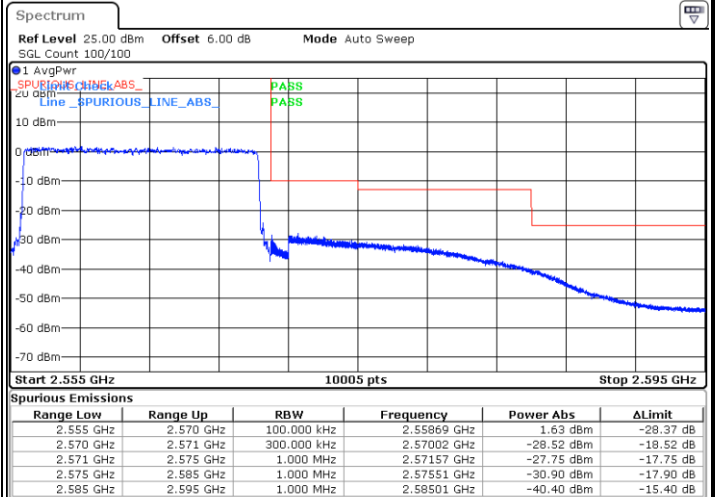

Date: 27 JUN.2022 16:34:00



LTE Band 7 / 15MHz / 256QAM

Lowest Band Edge / 1 RB

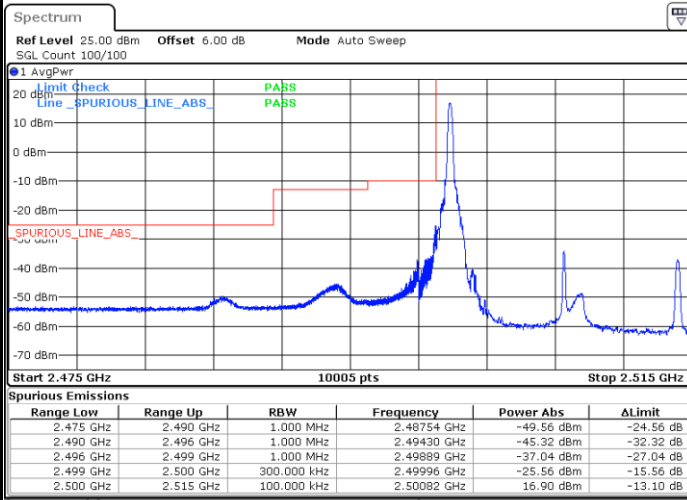

Date: 27 JUN.2022 16:23:57

Highest Band Edge / 1 RB

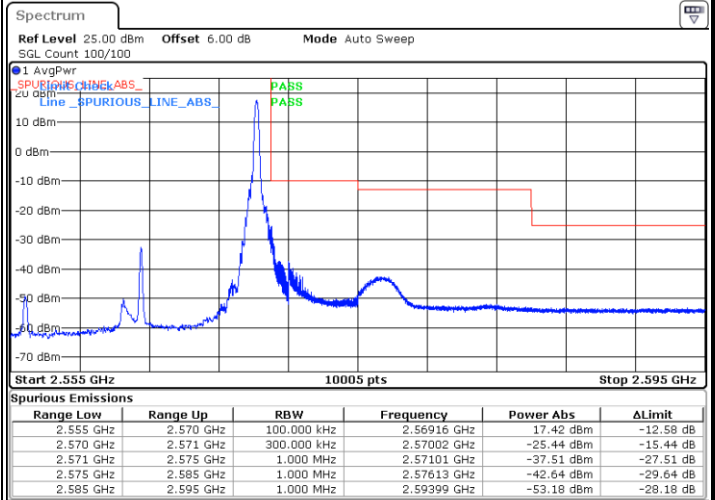

Date: 27 JUN.2022 16:32:04

Lowest Band Edge / Full RB

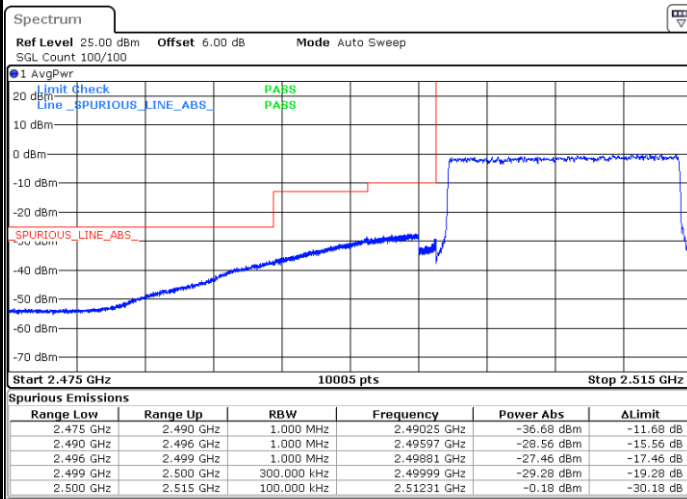

Date: 27 JUN.2022 16:24:40

Highest Band Edge / Full RB

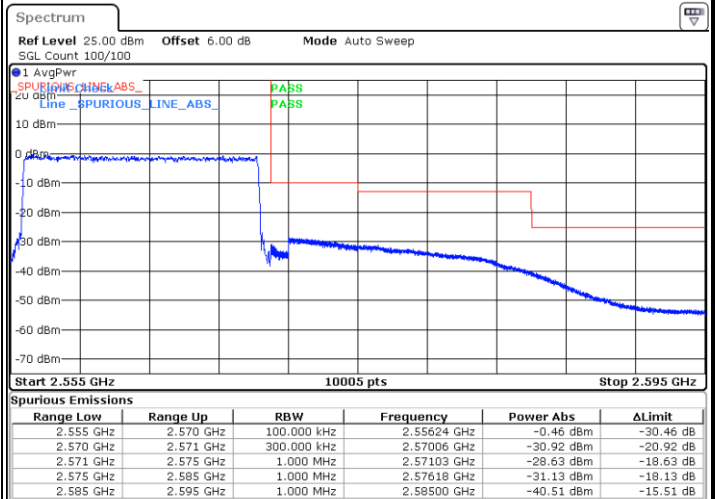

Date: 27 JUN.2022 16:33:19



LTE Band 7 / 20MHz / QPSK

Lowest Band Edge / 1 RB

Highest Band Edge / 1 RB

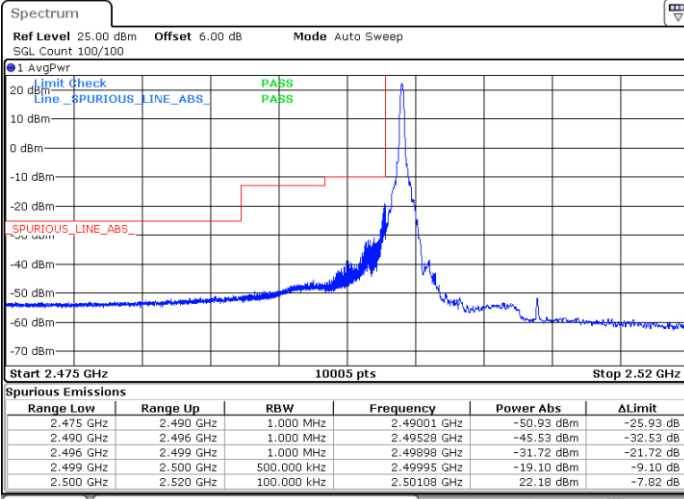

Date: 27 JUN 2022 16:37:23

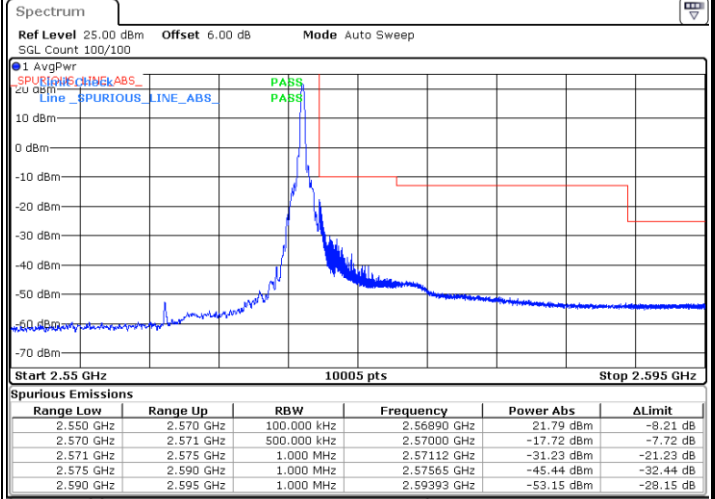

Date: 27 JUN 2022 16:46:04

Lowest Band Edge / Full RB

Highest Band Edge / Full RB

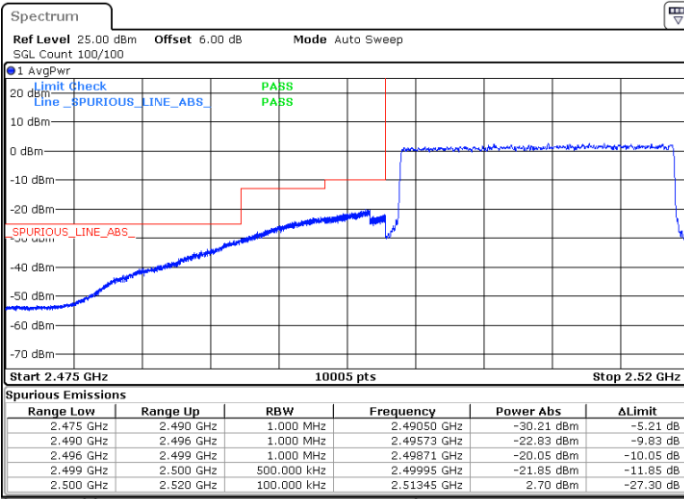

Date: 27 JUN 2022 16:42:43

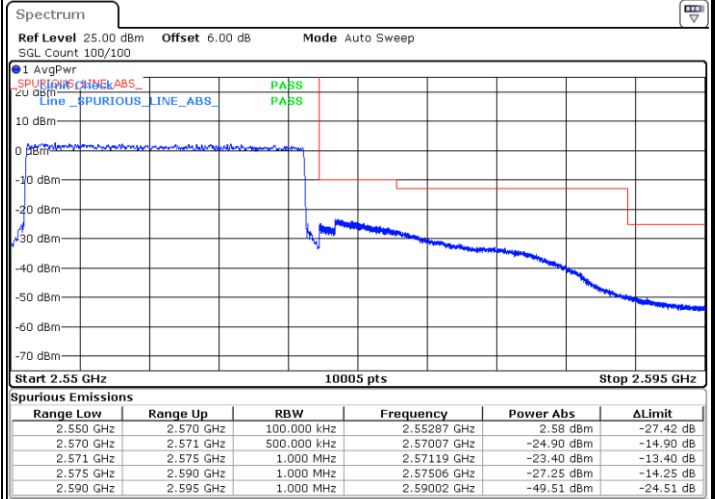

Date: 27 JUN 2022 16:49:26



LTE Band 7 / 20MHz / 16QAM

Lowest Band Edge / 1 RB

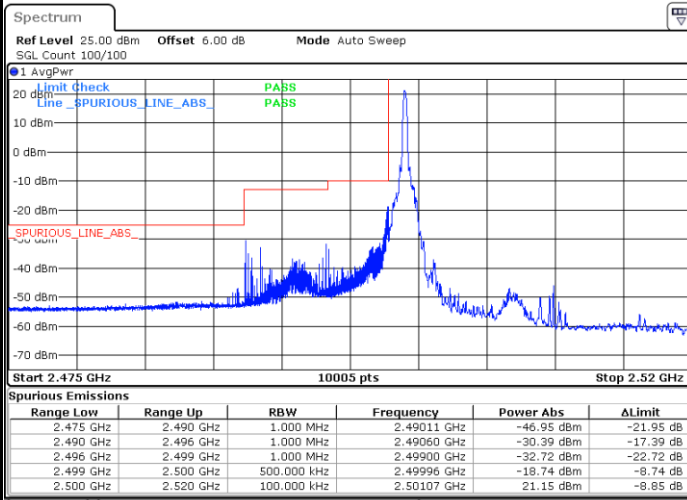

Date: 27 JUN 2022 16:38:04

Highest Band Edge / 1 RB

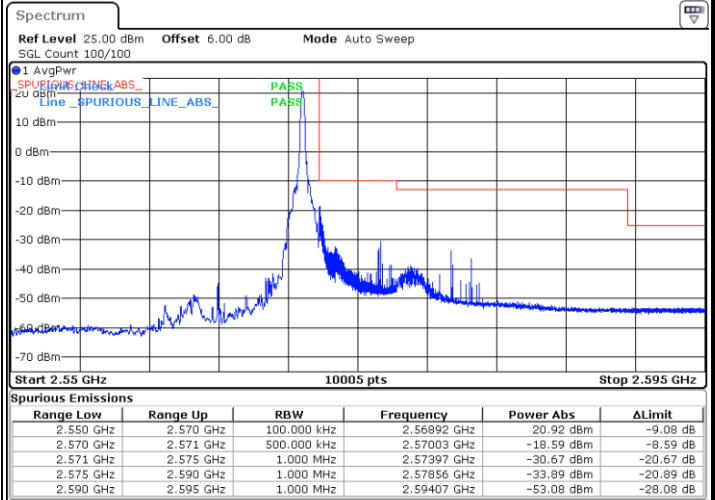

Date: 27 JUN 2022 16:46:44

Lowest Band Edge / Full RB

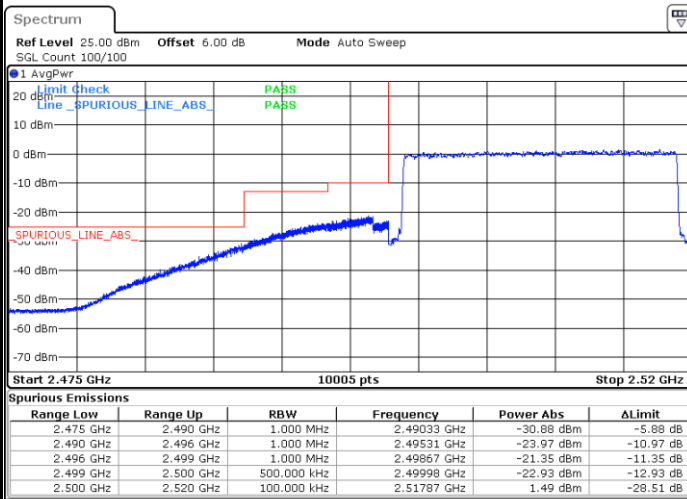

Date: 27 JUN 2022 16:42:02

Highest Band Edge / Full RB

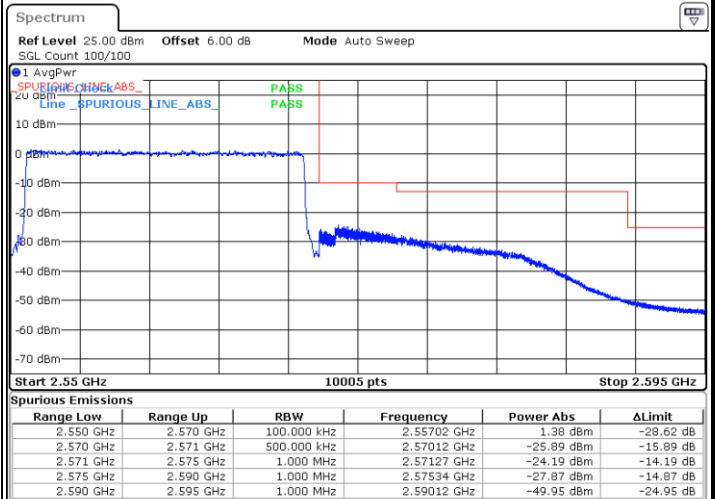

Date: 27 JUN 2022 16:48:46



LTE Band 7 / 20MHz / 64QAM

Lowest Band Edge / 1 RB

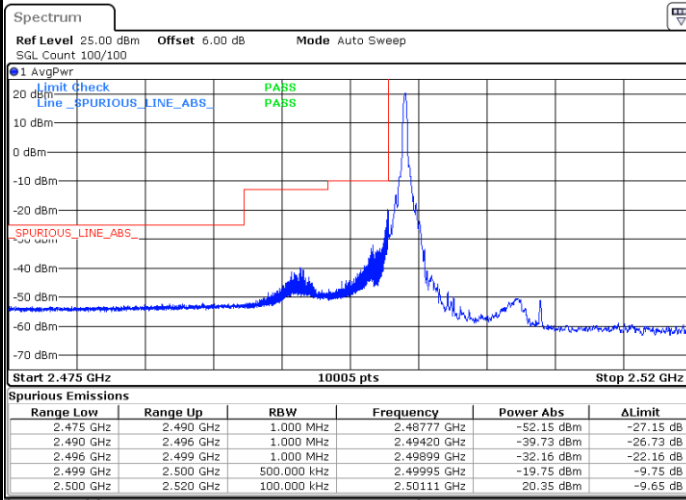

Date: 27 JUN 2022 16:38:45

Highest Band Edge / 1 RB

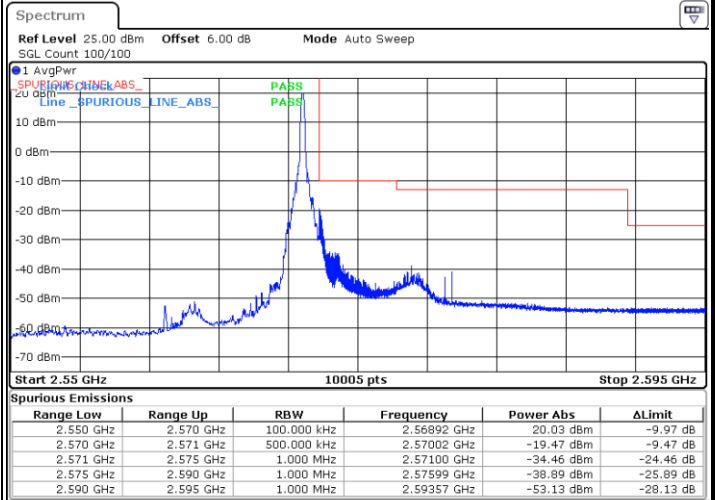

Date: 27 JUN 2022 16:47:25

Lowest Band Edge / Full RB

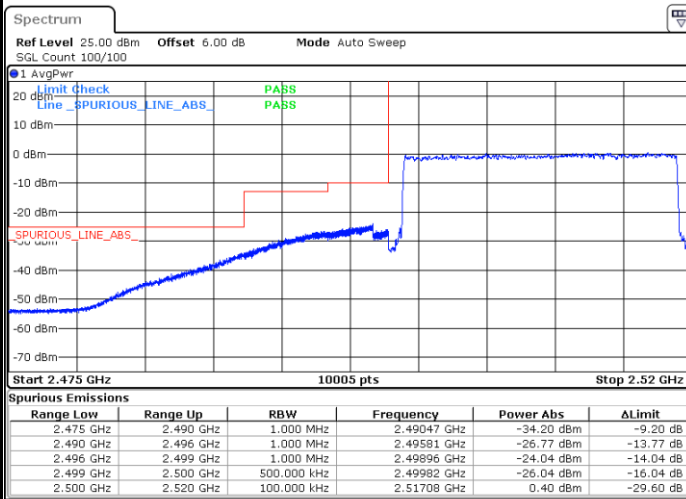

Date: 27 JUN 2022 16:41:22

Highest Band Edge / Full RB

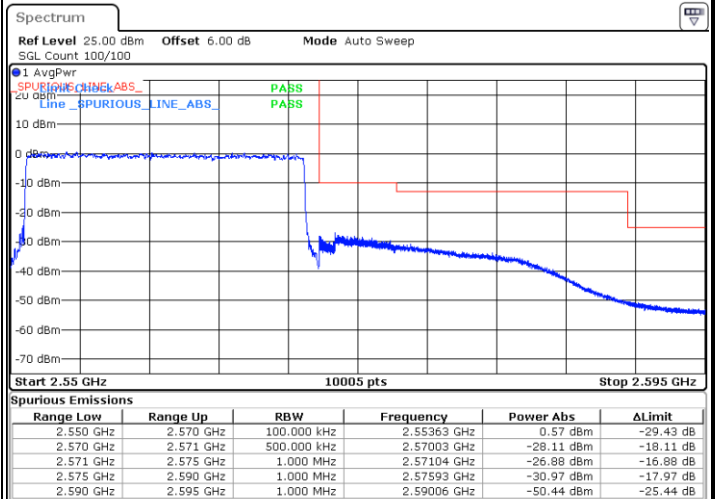

Date: 27 JUN 2022 16:48:05



LTE Band 7 / 20MHz /256QAM

Lowest Band Edge / 1 RB

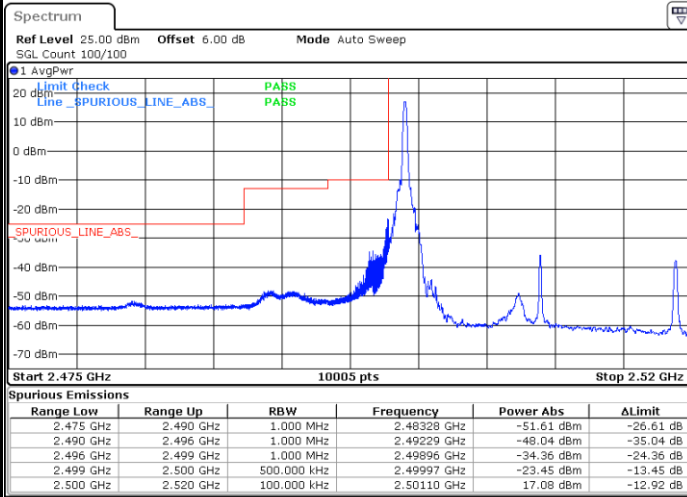

Date: 27 JUN 2022 16:39:26

Highest Band Edge / 1 RB

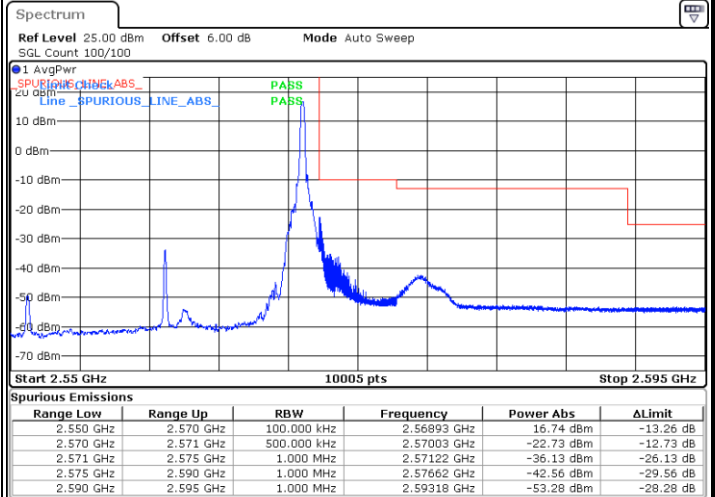

Date: 27 JUN 2022 17:38:07

Lowest Band Edge / Full RB

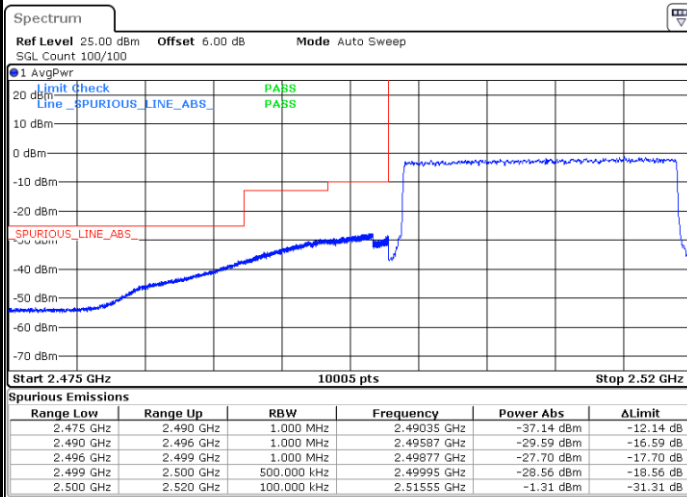

Date: 27 JUN 2022 16:40:41

Highest Band Edge / Full RB

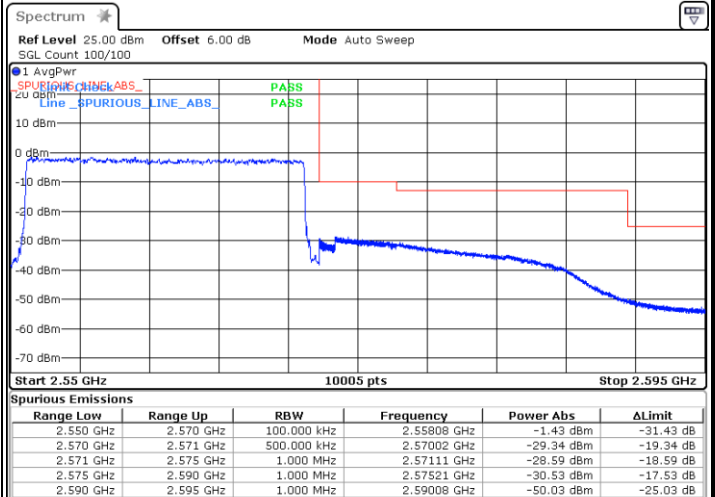

Date: 27 JUN 2022 17:39:03



Conducted Spurious Emission

