

FCC TEST REPORT

(PART 22)



Applicant:	Xiaomi Communications Co., Ltd.
Address:	#019, 9th Floor, Building 6, 33 Xi'erqi Middle Road, Haidian District, Beijing, China, 100085

Manufacturer or Supplier:	Xiaomi Communications Co., Ltd.
Address:	#019, 9th Floor, Building 6, 33 Xi'erqi Middle Road, Haidian District, Beijing, China, 100085
Product:	Mobile Phone
Brand Name:	Redmi
Model Name:	2201117SG
FCC ID:	2AFZZ117SG
Date of tests:	Nov. 01, 2021 ~ Nov. 29, 2021

The tests have been carried out according to the requirements of the following standard:

- | | |
|--|--|
| <input checked="" type="checkbox"/> FCC PART 22, Subpart H | <input checked="" type="checkbox"/> FCC Part 2 |
| <input checked="" type="checkbox"/> ANSI/TIA/EIA-603-D | <input checked="" type="checkbox"/> ANSI C63.26-2015 |
| <input checked="" type="checkbox"/> ANSI/TIA/EIA-603-E | |

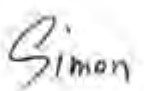
CONCLUSION: The submitted sample was found to COMPLY with the test requirement

Prepared by Simon Wang Engineer / Mobile Department	Approved by Luke Lu Manager / Mobile Department
	
Date: Nov. 29, 2021	Date: Nov. 29, 2021

This report is governed by, and incorporates by reference, CPS Conditions of Service as posted at the date of issuance of this report at <http://www.bureauveritas.com/home/about-us/our-business/cps/about-us/terms-conditions> and is intended for your exclusive use. Any copying or replication of this report to or for any other person or entity, or use of our name or trademark, is permitted only with our prior written permission. This report sets forth our findings solely with respect to the test samples identified herein. The results set forth in this report are not indicative or representative of the quality or characteristics of the lot from which a test sample was taken or any similar or identical product unless specifically and expressly noted. Our report includes all of the tests requested by you and the results thereof based upon the information that you provided to us. Measurement uncertainty is only provided upon request for accredited tests. You have 60 days from date of issuance of this report to notify us of any material error or omission caused by our negligence or if you require measurement uncertainty; provided, however, that such notice shall be in writing and shall specifically address the issue you wish to raise. A failure to raise such issue within the prescribed time shall constitute your unqualified acceptance of the completeness of this report, the tests conducted and the correctness of the report contents.



TABLE OF CONTENTS

RELEASE CONTROL RECORD 7

1 SUMMARY OF TEST RESULTS..... 8

* REFER TO KDB 971168 D01 POWER MEAS LICENSE DIGITAL SYSTEMS V03R01..... 8

1.1 MEASUREMENT UNCERTAINTY 8

1.2 TEST SITE AND INSTRUMENTS 9

2 GENERAL INFORMATION 10

2.1 GENERAL DESCRIPTION OF EUT 10

2.2 CONFIGURATION OF SYSTEM UNDER TEST 12

2.3 DESCRIPTION OF SUPPORT UNITS 13

2.4 TEST ITEM AND TEST CONFIGURATION..... 13

2.5 EUT OPERATING CONDITIONS..... 17

2.6 GENERAL DESCRIPTION OF APPLIED STANDARDS 18

3 TEST TYPES AND RESULTS..... 19

3.1 OUTPUT POWER MEASUREMENT 19

3.1.1 LIMITS OF OUTPUT POWER MEASUREMENT 19

3.1.2 TEST PROCEDURES 19

3.1.3 TEST SETUP 20

3.1.4 TEST RESULTS 20

3.2 FREQUENCY STABILITY MEASUREMENT 38

3.2.1 LIMITS OF FREQUENCY STABILITY MEASUREMENT 38

3.2.2 TEST PROCEDURE 38

3.2.3 TEST SETUP 38

3.2.4 TEST RESULTS 39

3.3 OCCUPIED BANDWIDTH MEASUREMENT 40

3.3.1 TEST PROCEDURES 40

3.3.2 TEST SETUP 40

3.3.3 TEST RESULTS 41

3.4 BAND EDGE MEASUREMENT 42

3.4.1 LIMITS OF BAND EDGE MEASUREMENT 42

3.4.2 TEST SETUP 42

3.4.3 TEST PROCEDURES 43

3.4.4 TEST RESULTS 44

3.5 CONDUCTED SPURIOUS EMISSIONS..... 45

3.5.1 LIMITS OF CONDUCTED SPURIOUS EMISSIONS MEASUREMENT 45

3.5.2 TEST PROCEDURE 45

3.5.3 TEST SETUP 45

3.5.4 TEST RESULTS 46

3.6 RADIATED EMISSION MEASUREMENT..... 47

3.6.1 LIMITS OF RADIATED EMISSION MEASUREMENT 47

3.6.2 TEST PROCEDURES 47



**BUREAU
VERITAS**

Test Report No.: W7L-P21100026RF13

3.6.3 DEVIATION FROM TEST STANDARD 47

3.6.4 TEST SETUP 48

3.6.5 TEST RESULTS 49

3.7 PEAK TO AVERAGE RATIO 81

3.7.1 LIMITS OF PEAK TO AVERAGE RATIO MEASUREMENT 81

3.7.2 TEST SETUP 81

3.7.3 TEST PROCEDURES 81

3.7.4 TEST RESULTS 82

4 PHOTOGRAPHS OF THE TEST CONFIGURATION 83

5 INFORMATION ON THE TESTING LABORATORIES 84

6 APPENDIX A – MODIFICATIONS RECORDERS FOR ENGINEERING CHANGES TO THE EUT BY THE LAB 85

APPENDIX B : 85

GSM850..... 85

FREQUENCY STABILITY 85

GSM850..... 85

TEST RESULT..... 85

99% & 26DB BANDWIDTH 87

GSM850_OBW..... 87

TEST RESULT..... 87

TEST GRAPH..... 88

GSM850_XDB 91

TEST RESULT..... 91

TEST GRAPH..... 92

PEAK-AVERAGE RATIO..... 95

GSM850..... 95

TEST RESULT..... 95

TEST GRAPH..... 96

SPURIOUS EMISSION 99

GSM850..... 99

TEST RESULT..... 99

TEST GRAPH..... 100



**BUREAU
VERITAS**

Test Report No.: W7L-P21100026RF13

WCDMA BAND5..... 105

FREQUENCY STABILITY 105

BAND5..... 105

TEST RESULT..... 105

99% & 26DB BANDWIDTH 106

WCDMA _OBW 106

TEST RESULT..... 106

TEST GRAPH..... 107

BAND5_XDB 109

TEST RESULT..... 109

TEST GRAPH..... 110

PEAK-AVERAGE RATIO 112

BAND5..... 112

TEST RESULT..... 112

TEST GRAPH..... 113

SPURIOUS EMISSION 115

BAND5..... 115

TEST RESULT..... 115

TEST GRAPH..... 116

LTE BAND5 119

FREQUENCY STABILITY 119

B5_1.4MHZ 119

TEST RESULT..... 119

B5_3MHZ..... 121

TEST RESULT..... 121

B5_5MHZ..... 123

TEST RESULT..... 123

B5_10MHZ 125



**BUREAU
VERITAS**

Test Report No.: W7L-P21100026RF13

TEST RESULT..... 125

99% & 26DB BANDWIDTH 128

BAND5_OBW 128

TEST RESULT..... 128

TEST GRAPH..... 129

BAND5_XDB 147

TEST RESULT..... 147

TEST GRAPH..... 148

PEAK-AVERAGE RATIO 166

B5_1.4MHZ 166

TEST RESULT..... 166

TEST GRAPH..... 167

B5_3MHZ..... 172

TEST RESULT..... 172

TEST GRAPH..... 173

B5_5MHZ..... 178

TEST RESULT..... 178

TEST GRAPH..... 179

TEST GRAPH..... 185

SPURIOUS EMISSION 190

B5_1.4MHZ 190

TEST RESULT..... 190

TEST GRAPH..... 191

B5_3MHZ..... 202

TEST RESULT..... 202

TEST GRAPH..... 203

B5_5MHZ..... 214

TEST RESULT..... 214



BUREAU
VERITAS

Test Report No.: W7L-P21100026RF13

TEST GRAPH.....215

B5_10MHZ226

TEST RESULT.....226

TEST GRAPH.....227



BUREAU
VERITAS

Test Report No.: W7L-P21100026RF13

RELEASE CONTROL RECORD

ISSUE NO.	REASON FOR CHANGE	DATE ISSUED
W7L-P21100026RF13	Original release	Nov. 29, 2021

1 SUMMARY OF TEST RESULTS

The EUT has been tested according to the following specifications:

APPLIED STANDARD: FCC Part 22 & Part 2		
STANDARD SECTION	TEST TYPE	RESULT
2.1046 22.913 (a)	Effective Radiated Power	Compliance
2.1055 22.355	Frequency Stability	Compliance
2.1049 22.917 (b)	Occupied Bandwidth	Compliance
22.913 (d)	Peak to average ratio*	Compliance
22.917	Band Edge Measurements	Compliance
2.1051 22.917	Conducted Spurious Emissions	Compliance
2.1053 22.917	Radiated Spurious Emissions	Compliance

* Refer to KDB 971168 D01 Power Meas License Digital Systems v03r01.

1.1 MEASUREMENT UNCERTAINTY

Where relevant, the following measurement uncertainty levels have been estimated for tests performed on the EUT as specified in CISPR 16-4-2:

MEASUREMENT	UNCERTAINTY
Maximum Peak Output Power	±2.06dB
Frequency Stability	± 76.97Hz
Radiated emissions (30MHz~1GMHz)	±4.98dB
Radiated emissions (1GMHz ~6GMHz)	±4.70dB
Radiated emissions (6GMHz ~18GMHz)	±4.60dB
Radiated emissions (18GMHz ~40GMHz)	±4.12dB
Conducted emissions	±4.01dB
Occupied Channel Bandwidth	±43.58KHz
Band Edge Measurements	±4.70dB
Peak to average ratio	±0.76dB

This uncertainty represents an expanded uncertainty expressed at approximately the 95% confidence level using a coverage factor of k=2.



1.2 TEST SITE AND INSTRUMENTS

Equipment	Manufacturer	Model No.	Serial No.	Last Cal.	Next Cal.
MXE EMI Receiver	KEYSIGHT	N9038A-544	MY54450026	Apr. 22,21	Apr. 21,22
EXA Signal Analyzer	KEYSIGHT	N9010A-544	MY54510355	Jun. 03,21	Jun. 02,22
Bilog Antenna 2	ETS-LINDGREN	3143B	00161965	Mar. 05,21	Mar. 04,22
Horn Antenna 1	ETS-LINDGREN	3117	00168728	Aug. 19,21	Aug. 18,22
Horn Antenna 2	ETS-LINDGREN	3117	00168692	Apr. 02,21	Apr. 01,22
Horn Antenna (18GHz-40GHz)	N/A	QWH-SL-18-40-K-SG/QMS-00361	15433	Aug. 25, 21	Aug. 24, 22
Radio Communication Analyzer	ANRITSU	MT8820C	6201465426	Feb. 25,21	Feb. 24,22
Signal Pre-Amplifier	EMSI	EMC 9135	980249	Jun. 02,21	Jun. 01,22
Signal Pre-Amplifier	EMSI	EMC 012645B	980257	Jun. 03,21	Jun. 02,22
Signal Pre-Amplifier	EMSI	EMC 184045B	980259	Apr. 22,21	Apr. 21,22
3m Semi-anechoic Chamber	ETS-LINDGREN	9m*6m*6m	Euroshieldpn-CT0001143-1216	May. 19,20	May. 18,23
Test Software	E3	V 9.160323	N/A	N/A	N/A
Test Software	ADT	ADT_Radiated_V 7.6.15.9.2	N/A	N/A	N/A
10dB Attenuator	JFW/USA	50HF-010-SMA	1505	Jun. 03,21	Jun. 02,22
Power Meter	Anritsu	ML2495A	1506002	Apr. 07,21	Apr. 06,22
Power Sensor	Anritsu	MA2411B	1339352	May. 07,21	May. 06,22
Temperature Chamber	ESPEC	SH-242	93000855	Jun. 02,21	Jun. 01,22
MXG Analog Microwave Signal Generator	KEYSIGHT	N5183A	MY50143024	Mar. 05,21	Mar. 04,22
Power Divider	MCLI/USA	PS2-15	24880	N/A	N/A

- NOTE:**
1. The calibration interval of the above test instruments is 12 months or 36 months and the calibrations are traceable to CEPREI/CHINA, GRGT/CHINA and NIM/CHINA.
 2. The test was performed in 3m Semi-anechoic Chamber and RF Oven Room.
 3. The horn antenna is used only for the measurement of emission frequency above 1GHz if tested.
 4. The FCC Site Registration No. is 525120; The Designation No. is CN1171.



2 GENERAL INFORMATION

2.1 GENERAL DESCRIPTION OF EUT

PRODUCT	Mobile Phone	
BRAND NAME	Redmi	
MODEL NAME	2201117SG	
NOMINAL VOLTAGE	5.0V/9.0V/11.0V/12.0V/20.0Vdc(adapter or host equipment) 3.87Vdc (Li-ion, battery)	
MODULATION TYPE	GSM/GPRS/EDGE	GMSK, 8PSK
	WCDMA	QPSK
	LTE	QPSK, 16QAM, 64QAM
FREQUENCY RANGE	GSM/GPRS/EDGE	824.2MHz ~ 848.8MHz
	WCDMA	826.4MHz ~ 846.6MHz
	LTE Band 5 (Channel Bandwidth: 1.4MHz)	824.7MHz ~ 848.3MHz
	LTE Band 5 (Channel Bandwidth: 3MHz)	825.5MHz ~ 847.5MHz
	LTE Band 5 (Channel Bandwidth: 5MHz)	826.5MHz ~ 846.5MHz
	LTE Band 5 (Channel Bandwidth: 10MHz)	829MHz ~ 844MHz
MAX. ERP POWER	GSM/GPRS	562.34mW
	EDGE	121.62mW
	WCDMA	76.74mW
	LTE Band 5 (Channel Bandwidth: 1.4MHz)	72.61mW
	LTE Band 5 (Channel Bandwidth: 3MHz)	71.45mW
	LTE Band 5 (Channel Bandwidth: 5MHz)	71.45mW
	LTE Band 5 (Channel Bandwidth: 10MHz)	72.11mW
EMISSION DESIGNATOR GOGN	GSM/GPRS	248KGXW
	EDGE	244KGXW
	WCDMA	4M19F9W
	LTE Band 5 (Channel Bandwidth: 1.4MHz)	QPSK: 1M11G7D
		16QAM: 1M12W7D
		64QAM: 1M12W7D
	LTE Band 5 (Channel Bandwidth: 3MHz)	QPSK: 2M73G7D
		16QAM: 2M74W7D
64QAM: 2M73W7D		



	LTE Band 5 (Channel Bandwidth: 5MHz)	QPSK: 4M55G7D
		16QAM: 4M56W7D
		64QAM: 4M55W7D
	LTE Band 5 (Channel Bandwidth: 10MHz)	QPSK: 9M05G7D
		16QAM: 9M06W7D
		64QAM:9M07W7D
ANTENNA TYPE	Ant0:PIFA Antenna with -3.36dBi gain for GSM850/ WCDMA V/LTE B5 Ant1:Fixed Internal Antenna with -3.45dBi gain for GSM850/ WCDMA V/LTE B5	
HW VERSION	P1.1	
SW VERSION	MIUI12.5	
IMEI	868909050050825	
I/O PORTS	Refer to user's manual	
CABLE SUPPLIED	USB1 cable: unshielded without ferrite, 1.0meter USB2 cable: unshielded without ferrite, 1.0meter	
EXTREME TEMPERATURE	0-40 °C	
EXTREME VOLTAGE	EUT 3.6V - EUT 4.2V	

NOTE:

1. For a more detailed features description, please refer to the manufacturer's specifications or the user's manual.
2. The EUT incorporates a SISO function. Physically, the EUT provides one completed transmitter and one receiver.

MODULATION MODE	TX FUNCTION
GSM/GPRS/EDGE	1TX/1RX
WCDMA	1TX/1RX
LTE	1TX/1RX

3. For the test results, the EUT had been tested with all conditions. But only the worst case was shown in test report.



2.2 CONFIGURATION OF SYSTEM UNDER TEST FOR RADIATION EMISSION

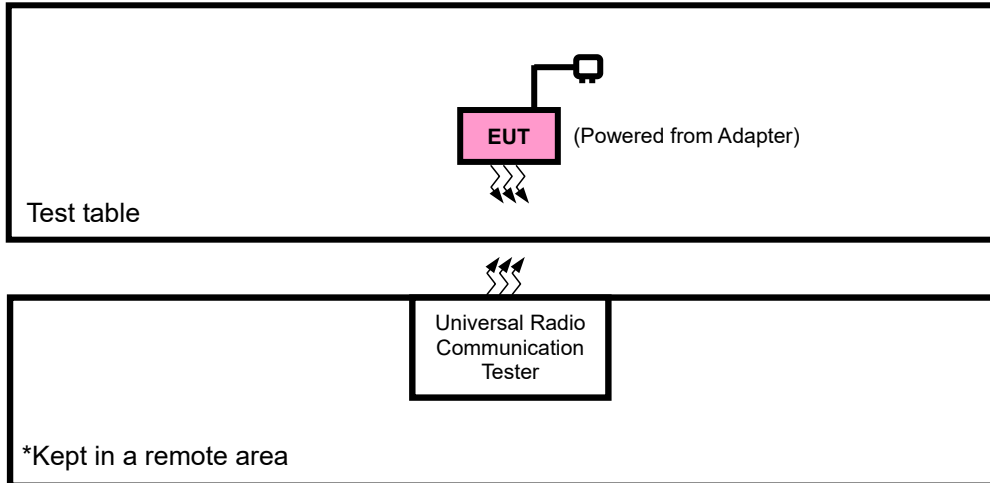



2.3 DESCRIPTION OF SUPPORT UNITS

The EUT has been tested as an independent unit together with other necessary accessories or support units. The following support units or accessories were used to form a representative test configuration during the tests.

NO.	PRODUCT	BRAND	MODEL NO.	SERIAL NO.	FCC ID
1	DC source	Kikusui/JP	PMX18-5A	0000001	N/A

NO.	SIGNAL CABLE DESCRIPTION OF THE ABOVE SUPPORT UNITS
1	DC Line: Unshielded, Detachable 1.0m

2.4 TEST ITEM AND TEST CONFIGURATION

Pre-Scan has been conducted to determine the worst-case mode from all possible combinations between available modulations, data rates, XYZ axis and antenna ports. The worst case in ERP and radiated emission was found when positioned on X-plane for GSM /EDGE /LTE. Following channel(s) was (were) selected for the final test as listed below:

EUT CONFIGURE MODE	DESCRIPTION
A	EUT + Adapter with GSM or WCDMA or LTE link



**BUREAU
VERITAS**

Test Report No.: W7L-P21100026RF13

GSM MODE

EUT CONFIGURE MODE	TEST ITEM	AVAILABLE CHANNEL	TESTED CHANNEL	MODE
A	ERP	128 to 251	128, 189, 251	GSM,EDGE
A	FREQUENCY STABILITY	128 to 251	128, 251	GSM,EDGE
A	OCCUPIED BANDWIDTH	128 to 251	128, 189, 251	GSM,EDGE
A	BAND EDGE	128 to 251	128, 251	GSM,EDGE
A	CONDCUDETED EMISSION	128 to 251	128, 189, 251	GSM,EDGE
A	RADIATED EMISSION	128 to 251	128, 189, 251	GSM,EDGE
A	PEAK TO AVERAGE RATIO	128 to 251	128, 189, 251	GSM,EDGE

WCDMA MODE

EUT CONFIGURE MODE	TEST ITEM	AVAILABLE CHANNEL	TESTED CHANNEL	MODE
A	ERP	4132 to 4233	4132, 4182, 4233	WCDMA
A	FREQUENCY STABILITY	4132 to 4233	4132, 4233	WCDMA
A	OCCUPIED BANDWIDTH	4132 to 4233	4132, 4182, 4233	WCDMA
A	BAND EDGE	4132 to 4233	4132, 4182, 4233	WCDMA
A	CONDCUDETED EMISSION	4132 to 4233	4132, 4233	WCDMA
A	RADIATED EMISSION	4132 to 4233	4132, 4182, 4233	WCDMA
A	PEAK TO AVERAGE RATIO	4132 to 4233	4132, 4182, 4233	WCDMA



LTE BAND 5 MODE

TEST ITEM	Available Channel	Tested Channel	Channel bandwidth	modulation	mode
ERP	20407 to 20643	20407, 20525, 20643	1.4MHz	QPSK,16QAM,64QAM	1 RB / 0 RB Offset
	20415 to 20635	20415, 20525, 20635	3MHz	QPSK,16QAM,64QAM	1 RB / 0 RB Offset
	20425 to 20625	20425, 20525, 20625	5MHz	QPSK,16QAM,64QAM	1 RB / 0 RB Offset
	20450 to 20600	20450, 20525, 20600	10MHz	QPSK,16QAM,64QAM	1 RB / 0 RB Offset
FREQUENCY STABILITY	20407 to 20643	20407, 20643	1.4MHz	QPSK	1 RB / 0 RB Offset
	20415 to 20635	20415, 20635	3MHz	QPSK	1 RB / 0 RB Offset
	20425 to 20625	20425, 20625	5MHz	QPSK	1 RB / 0 RB Offset
	20450 to 20600	20450, 20600	10MHz	QPSK	1 RB / 0 RB Offset
OCCUPIED BANDWIDTH	20407 to 20643	20407, 20525, 20643	1.4MHz	QPSK,16QAM,64QAM	6 RB / 0 RB Offset
	20415 to 20635	20415, 20525, 20635	3MHz	QPSK,16QAM,64QAM	15 RB / 0 RB Offset
	20425 to 20625	20425, 20525, 20625	5MHz	QPSK,16QAM,64QAM	25 RB / 0 RB Offset
	20450 to 20600	20450, 20525, 20600	10MHz	QPSK,16QAM,64QAM	50 RB / 0 RB Offset
BAND EDGE	20407 to 20643	20407	1.4 MHz	QPSK,16QAM,64QAM	1 RB / 0 RB Offset
					6 RB / 0 RB Offset
	20407 to 20643	20643	1.4 MHz	QPSK,16QAM,64QAM	1 RB / 5 RB Offset
					6 RB / 0 RB Offset
	20415 to 20635	20415	3 MHz	QPSK,16QAM,64QAM	1 RB / 0 RB Offset
					15 RB / 0 RB Offset
	20415 to 20635	20635	3 MHz	QPSK,16QAM,64QAM	1 RB / 14 RB Offset
					15 RB / 0 RB Offset
	20425 to 20625	20425	5MHz	QPSK,16QAM,64QAM	1 RB / 0 RB Offset
					25 RB / 0 RB Offset
	20425 to 20625	20625	5MHz	QPSK,16QAM,64QAM	1 RB / 24 RB Offset
					25 RB / 0 RB Offset
20450 to 20600	20450	10MHz	QPSK,16QAM,64QAM	1 RB / 0 RB Offset	
				50 RB / 0 RB Offset	
20450 to 20600	20600	10MHz	QPSK,16QAM,64QAM	1 RB / 49 RB Offset	
				50 RB / 0 RB Offset	



CONDCUDED EMISSION	20407 to 20643	20407, 20525, 20643	1.4MHz	QPSK	1 RB / 0 RB Offset
	20415 to 20635	20415, 20525, 20635	3MHz	QPSK	1 RB / 0 RB Offset
	20425 to 20625	20425, 20525, 20625	5MHz	QPSK	1 RB / 0 RB Offset
	20450 to 20600	20450, 20525, 20600	10MHz	QPSK	1 RB / 0 RB Offset
RADIATED EMISSION	20407 to 20643	20525	1.4MHz	QPSK	1 RB / 0 RB Offset
	20415 to 20635	20415, 20525, 20635	3MHz	QPSK	1 RB / 0 RB Offset
	20425 to 20625	20525	5MHz	QPSK	1 RB / 0 RB Offset
	20450 to 20600	20525	10MHz	QPSK	1 RB / 0 RB Offset
PEAK TO AVERAGE RATIO	20407 to 20643	20407, 20525, 20643	1.4MHz	QPSK,16QAM,64QAM	1 RB / 0 RB Offset
	20415 to 20635	20415, 20525, 20635	3MHz	QPSK,16QAM,64QAM	1 RB / 0 RB Offset
	20425 to 20625	20425, 20525, 20625	5MHz	QPSK,16QAM,64QAM	1 RB / 0 RB Offset
	20450 to 20600	20450, 20525, 20600	10MHz	QPSK,16QAM,64QAM	1 RB / 0 RB Offset

Note: This device was tested under all bandwidths, RB configurations and modulations. The worst case was found in QPSK modulation.



TEST CONDITION:

TEST ITEM	ENVIRONMENTAL CONDITIONS	INPUT POWER	TESTED BY
ERP	23deg. C, 70%RH	DC 5V/9V/11V/12V/20V By Adapter	Jace Hu
FREQUENCY STABILITY	23deg. C, 70%RH	DC 5V/9V/11V/12V/20V By Adapter	James Fu
OCCUPIED BANDWIDTH	23deg. C, 70%RH	DC 5V/9V/11V/12V/20V By Adapter	James Fu
BAND EDGE	23deg. C, 70%RH	DC 5V/9V/11V/12V/20V By Adapter	James Fu
CONDCUDED EMISSION	23deg. C, 70%RH	DC 5V/9V/11V/12V/20V By Adapter	James Fu
RADIATED EMISSION	23deg. C, 70%RH	DC 5V/9V/11V/12V/20V By Adapter	Jace Hu
PEAK TO AVERAGE RATIO	23deg. C, 70%RH	DC 3.87 By Battery	James Fu

2.5 EUT OPERATING CONDITIONS

The EUT makes a call to the communication simulator. The communication simulator station system controlled a EUT to export maximum output power under transmission mode and specific channel frequency



Test Report No.: W7L-P21100026RF13

2.6 GENERAL DESCRIPTION OF APPLIED STANDARDS

The EUT is a RF product. According to the specifications of the manufacturer, it must comply with the requirements of the following standards:

FCC 47 CFR Part 2

FCC 47 CFR Part 22

KDB 971168 D01 Power Meas License Digital Systems v03r01

ANSI/TIA/EIA-603-D

ANSI/TIA/EIA-603-E

ANSI C63.26-2015

NOTE: All test items have been performed and recorded as per the above standards.



3 TEST TYPES AND RESULTS

3.1 OUTPUT POWER MEASUREMENT

3.1.1 LIMITS OF OUTPUT POWER MEASUREMENT

Mobile / Portable station are limited to 7 watts e.r.p.

3.1.2 TEST PROCEDURES

EIRP / ERP MEASUREMENT:

Per KDB 971168 D01 Power Meas License Digital Systems v03r01 or subclause 5.2.5.5 of ANSI C63.26-2015, the relevant equation for determining the ERP or EIRP from the conducted RF output power measured using the guidance provided above is:

$$\text{ERP or EIRP} = P_{\text{Meas}} + G_{\text{T}} - L_{\text{C}}$$

Where:

ERP or EIRP = effective radiated power or equivalent isotropically radiated power, respectively

(expressed in the same units as P_{Meas} , typically dBW or dBm);

P_{Meas} = measured transmitter output power or PSD, in dBm or dBW;

G_{T} = gain of the transmitting antenna, in dBd (ERP) or dBi (EIRP);

L_{C} = signal attenuation in the connecting cable between the transmitter and antenna, in dB.

CONDUCTED POWER MEASUREMENT:

The EUT was set up for the maximum power with WCDMA link data modulation and link up with simulator. Set the EUT to transmit under low, middle and high channel and record the power level shown on simulator.



3.1.3 TEST SETUP

EIRP / ERP Measurement:

CONDUCTED POWER MEASUREMENT:

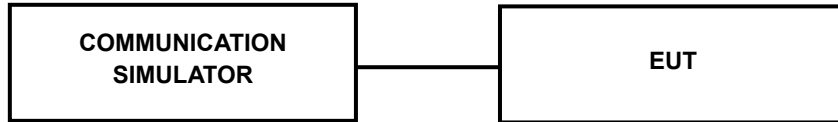

3.1.4 TEST RESULTS

CONDUCTED OUTPUT POWER (dBm)

Ant0:

Band	GSM850			Max. Tune-up Power
Channel	128	189	251	
Frequency	824.2	836.4	848.8	
GSM (GMSK, 1Tx-slot)	32.82	33.01	32.93	33.50
GPRS (GMSK, 1Tx-slot)	32.80	32.98	32.91	33.50
GPRS (GMSK, 2Tx-slot)	30.82	30.98	30.79	31.00
GPRS (GMSK, 3Tx-slot)	29.07	29.19	29.00	29.50
GPRS (GMSK, 4Tx-slot)	27.17	27.32	27.08	27.50
EDGE (8PSK, 1Tx-slot)	26.30	26.24	26.29	28.00
EDGE (8PSK, 2Tx-slot)	23.79	23.78	23.75	25.50
EDGE (8PSK, 3Tx-slot)	22.30	22.26	22.18	24.00
EDGE (8PSK, 4Tx-slot)	21.02	21.04	20.87	22.50

Band	WCDMA V			Max. Tune-up Power
Channel	4132	4182	4233	
Frequency	826.4	836.4	846.6	
RMC 12.2K	24.19	24.08	24.06	25.50
HSDPA Subtest-1	23.22	23.15	23.12	24.50
HSDPA Subtest-2	23.20	23.12	23.09	24.50
HSDPA Subtest-3	22.75	22.77	22.67	24.50
HSDPA Subtest-4	22.73	22.74	22.65	24.50
DC-HSDPA Subtest-1	23.20	23.14	23.10	25.00
DC-HSDPA Subtest-2	23.18	23.12	23.09	25.00
DC-HSDPA Subtest-3	22.76	22.71	22.65	24.50
DC-HSDPA Subtest-4	22.74	22.70	22.65	24.50
HSUPA Subtest-1	21.43	21.36	21.35	23.00
HSUPA Subtest-2	21.75	21.81	21.83	23.00
HSUPA Subtest-3	22.15	22.07	22.11	24.00
HSUPA Subtest-4	21.32	21.28	21.29	22.50
HSUPA Subtest-5	22.50	22.40	22.38	24.00



**BUREAU
VERITAS**

Test Report No.: W7L-P21100026RF13

LTE Band 5

Band/BW	Modulation	RB Size	RB Offset	Low CH 20407	Mid CH 20525	High CH 20643	MPR
				Frequency 824.7 MHz	Frequency 836.5 MHz	Frequency 848.3 MHz	
5/ 1.4	QPSK	1	0	23.89	23.99	23.95	0
		1	2	23.95	23.94	23.99	0
		1	5	23.91	23.91	23.95	0
		3	0	23.82	23.87	23.88	0
		3	1	23.98	24.12	23.97	0
		3	3	23.93	23.97	23.98	0
		6	0	22.91	22.98	22.94	1
	16QAM	1	0	23.17	23.25	23.25	1
		1	2	23.16	23.24	23.22	1
		1	5	23.13	23.12	23.20	1
		3	0	22.86	22.95	22.88	1
		3	1	22.89	23.08	22.95	1
		3	3	22.89	22.98	23.00	1
		6	0	21.86	21.97	21.91	2
	64QAM	1	0	22.03	22.15	22.16	2
		1	2	22.04	22.24	22.12	2
		1	5	22.03	22.12	22.12	2
		3	0	21.77	21.86	21.76	2
		3	1	21.90	22.09	21.99	2
		3	3	21.90	21.94	21.93	2
		6	0	20.87	20.98	20.92	3



**BUREAU
VERITAS**

Test Report No.: W7L-P21100026RF13

Band/BW	Modulation	RB Size	RB Offset	Low CH 20415	Mid CH 20525	High CH 20635	MPR
				Frequency 825.5 MHz	Frequency 836.5 MHz	Frequency 847.5 MHz	
5/3	QPSK	1	0	23.91	24.01	23.94	0
		1	7	23.91	23.95	23.99	0
		1	14	23.87	23.91	23.95	0
		8	0	22.81	22.90	22.88	1
		8	3	22.91	23.12	22.99	1
		8	7	22.90	23.04	23.02	1
		15	0	22.88	22.99	22.88	1
	16QAM	1	0	23.14	23.31	23.28	1
		1	7	23.13	23.27	23.20	1
		1	14	23.16	23.12	23.20	1
		8	0	21.82	21.96	21.88	2
		8	3	21.94	22.03	21.98	2
		8	7	21.91	21.96	21.96	2
		15	0	21.86	21.91	21.94	2
	64QAM	1	0	22.09	22.18	22.10	2
		1	7	22.07	22.18	22.11	2
		1	14	22.04	22.14	22.12	2
		8	0	20.80	20.90	20.77	3
		8	3	20.94	21.03	21.04	3
		8	7	20.87	20.98	20.89	3
		15	0	20.89	20.95	20.96	3



Band/BW	Modulation	RB Size	RB Offset	Low CH 20425	Mid CH 20525	High CH 20625	MPR
				Frequency 826.5 MHz	Frequency 836.5 MHz	Frequency 846.5 MHz	
5 / 5	QPSK	1	0	23.92	23.96	23.95	0
		1	12	23.96	23.92	23.99	0
		1	24	23.88	23.90	23.99	0
		12	0	22.84	22.90	22.85	1
		12	6	22.91	23.13	23.00	1
		12	13	22.94	23.00	23.03	1
		25	0	22.86	23.02	22.91	1
	16QAM	1	0	23.15	23.27	23.28	1
		1	12	23.10	23.30	23.19	1
		1	24	23.16	23.12	23.19	1
		12	0	21.82	21.94	21.85	2
		12	6	21.91	22.07	21.94	2
		12	13	21.86	21.98	21.99	2
		25	0	21.86	21.92	21.91	2
	64QAM	1	0	22.03	22.15	22.16	2
		1	12	22.04	22.24	22.11	2
		1	24	21.97	22.19	22.12	2
		12	0	20.81	20.87	20.76	3
		12	6	20.88	21.10	21.03	3
		12	13	20.91	20.97	20.86	3
		25	0	20.85	21.01	20.94	3



**BUREAU
VERITAS**

Test Report No.: W7L-P21100026RF13

Band/BW	Modulation	RB Size	RB Offset	Low CH 20450	Mid CH 20525	High CH 20600	MPR
				Frequency 829 MHz	Frequency 836.5 MHz	Frequency 844 MHz	
5/ 10	QPSK	1	0	23.97	24.03	24.00	0
		1	24	23.98	24.00	24.01	0
		1	49	23.93	23.98	24.00	0
		25	0	22.88	22.95	22.90	1
		25	12	22.99	23.14	23.05	1
		25	25	22.98	23.05	23.04	1
		50	0	22.92	23.04	22.96	1
	16QAM	1	0	23.22	23.32	23.30	1
		1	24	23.18	23.32	23.24	1
		1	49	23.18	23.20	23.21	1
		25	0	21.90	22.00	21.93	2
		25	12	21.97	22.09	22.00	2
		25	25	21.93	22.03	22.01	2
		50	0	21.92	21.99	21.96	2
	64QAM	1	0	22.10	22.20	22.18	2
		1	24	22.12	22.26	22.17	2
		1	49	22.05	22.20	22.14	2
		25	0	20.85	20.92	20.84	3
		25	12	20.96	21.11	21.05	3
		25	25	20.95	21.02	20.94	3
		50	0	20.91	21.03	20.97	3



Ant1:

Band	GSM850			Max. Tune-up Power
	Channel	128	189	
Frequency	824.2	836.4	848.8	
GSM (GMSK, 1Tx-slot)	32.61	32.73	32.58	33.50
GPRS (GMSK, 1Tx-slot)	32.59	32.70	32.56	33.50
GPRS (GMSK, 2Tx-slot)	30.87	30.98	30.84	31.00
GPRS (GMSK, 3Tx-slot)	29.25	29.37	29.29	29.50
GPRS (GMSK, 4Tx-slot)	27.38	27.52	27.28	27.50
EDGE (8PSK, 1Tx-slot)	26.40	26.45	26.41	28.00
EDGE (8PSK, 2Tx-slot)	23.93	23.97	24.01	25.50
EDGE (8PSK, 3Tx-slot)	22.41	22.35	22.42	24.00
EDGE (8PSK, 4Tx-slot)	21.13	21.11	20.94	22.50

Band	WCDMA V			Max. Tune-up Power
	Channel	4132	4182	
Frequency	826.4	836.4	846.6	
RMC 12.2K	24.45	24.38	24.41	25.50
HSDPA Subtest-1	23.49	23.39	23.40	24.50
HSDPA Subtest-2	23.48	23.35	23.34	24.50
HSDPA Subtest-3	22.99	22.99	22.95	24.50
HSDPA Subtest-4	23.02	23.02	22.87	24.50
DC-HSDPA Subtest-1	23.45	23.36	23.34	25.00
DC-HSDPA Subtest-2	23.47	23.36	23.37	25.00
DC-HSDPA Subtest-3	23.01	22.99	22.88	24.50
DC-HSDPA Subtest-4	23.02	22.92	22.93	24.50
HSUPA Subtest-1	21.65	21.60	21.57	23.00
HSUPA Subtest-2	21.99	22.09	22.07	23.00
HSUPA Subtest-3	22.40	22.29	22.40	24.00
HSUPA Subtest-4	21.58	21.53	21.54	22.50
HSUPA Subtest-5	22.74	22.68	22.63	24.00



**BUREAU
VERITAS**

Test Report No.: W7L-P21100026RF13

LTE Band 5

Band/BW	Modulation	RB Size	RB Offset	Low CH 20407	Mid CH 20525	High CH 20643	MPR
				Frequency 824.7 MHz	Frequency 836.5 MHz	Frequency 848.3 MHz	
5/ 1.4	QPSK	1	0	24.04	24.12	24.09	0
		1	2	24.13	24.12	24.14	0
		1	5	24.06	24.04	24.09	0
		3	0	24.00	24.03	24.05	0
		3	1	24.04	24.16	24.02	0
		3	3	24.11	24.13	24.15	0
		6	0	23.07	23.12	23.09	1
	16QAM	1	0	23.30	23.36	23.37	1
		1	2	23.33	23.39	23.38	1
		1	5	23.28	23.25	23.34	1
		3	0	22.91	22.98	22.92	1
		3	1	23.03	23.20	23.08	1
		3	3	23.04	23.11	23.14	1
		6	0	22.02	22.11	22.06	2
	64QAM	1	0	22.18	22.28	22.30	2
		1	2	22.21	22.39	22.28	2
		1	5	22.21	22.28	22.29	2
		3	0	21.92	21.99	21.90	2
		3	1	22.04	22.21	22.12	2
		3	3	21.95	21.97	21.97	2
		6	0	21.03	21.12	21.07	3



Band/BW	Modulation	RB Size	RB Offset	Low CH 20415	Mid CH 20525	High CH 20635	MPR
				Frequency 825.5 MHz	Frequency 836.5 MHz	Frequency 847.5 MHz	
5/3	QPSK	1	0	24.06	24.14	24.08	0
		1	7	24.09	24.13	24.14	0
		1	14	24.02	24.04	24.09	0
		8	0	22.99	23.06	23.05	1
		8	3	23.07	23.26	23.14	1
		8	7	23.08	23.20	23.19	1
		15	0	23.04	23.13	23.03	1
	16QAM	1	0	23.27	23.42	23.40	1
		1	7	23.30	23.42	23.36	1
		1	14	23.31	23.25	23.34	1
		8	0	21.87	21.99	21.92	2
		8	3	22.08	22.15	22.11	2
		8	7	22.06	22.09	22.10	2
		15	0	22.02	22.05	22.09	2
	64QAM	1	0	22.24	22.31	22.24	2
		1	7	22.24	22.33	22.27	2
		1	14	22.22	22.30	22.29	2
		8	0	20.95	21.03	20.91	3
		8	3	21.08	21.15	21.17	3
		8	7	20.92	21.01	20.93	3
		15	0	21.05	21.09	21.11	3



Band/BW	Modulation	RB Size	RB Offset	Low CH 20425	Mid CH 20525	High CH 20625	MPR
				Frequency 826.5 MHz	Frequency 836.5 MHz	Frequency 846.5 MHz	
5 / 5	QPSK	1	0	24.07	24.09	24.09	0
		1	12	24.14	24.10	24.14	0
		1	24	24.03	24.03	24.13	0
		12	0	23.02	23.06	23.02	1
		12	6	23.07	23.27	23.15	1
		12	13	23.12	23.16	23.20	1
		25	0	23.02	23.16	23.06	1
	16QAM	1	0	23.28	23.38	23.40	1
		1	12	23.27	23.45	23.35	1
		1	24	23.31	23.25	23.33	1
		12	0	21.87	21.97	21.89	2
		12	6	22.05	22.19	22.07	2
		12	13	22.01	22.11	22.13	2
		25	0	22.02	22.06	22.06	2
	64QAM	1	0	22.18	22.28	22.30	2
		1	12	22.21	22.39	22.27	2
		1	24	22.15	22.35	22.29	2
		12	0	20.96	21.00	20.90	3
		12	6	21.02	21.22	21.16	3
		12	13	20.96	21.00	20.90	3
		25	0	21.01	21.15	21.09	3



**BUREAU
VERITAS**

Test Report No.: W7L-P21100026RF13

Band/BW	Modulation	RB Size	RB Offset	Low CH 20450	Mid CH 20525	High CH 20600	MPR
				Frequency 829 MHz	Frequency 836.5 MHz	Frequency 844 MHz	
5/ 10	QPSK	1	0	24.12	24.16	24.14	0
		1	24	24.16	24.18	24.16	0
		1	49	24.08	24.11	24.14	0
		25	0	23.06	23.11	23.07	1
		25	12	23.15	23.28	23.20	1
		25	25	23.16	23.21	23.21	1
		50	0	23.08	23.18	23.11	1
	16QAM	1	0	23.35	23.43	23.42	1
		1	24	23.35	23.47	23.40	1
		1	49	23.33	23.33	23.35	1
		25	0	21.95	22.03	21.97	2
		25	12	22.11	22.21	22.13	2
		25	25	22.08	22.16	22.15	2
		50	0	22.08	22.13	22.11	2
	64QAM	1	0	22.25	22.33	22.32	2
		1	24	22.29	22.41	22.33	2
		1	49	22.23	22.36	22.31	2
		25	0	21.00	21.05	20.98	3
		25	12	21.10	21.23	21.18	3
		25	25	21.00	21.05	20.98	3
		50	0	21.07	21.17	21.12	3

ERP POWER (dBm)

Ant0:

GSM

Channel	Frequency (MHz)	Conducted Power (dBm)	G _T -L _c (dB)	ERP (dBm)	ERP (mW)	Limit (W)
128	824.2	32.82	-3.36	27.31	538.27	7
189	836.4	33.01	-3.36	27.5	562.34	7
251	848.8	32.93	-3.36	27.42	552.08	7

REMARKS: ERP Output Power (dBm) = EIRP (dBm) -2.15(dB).

EDGE

Channel	Frequency (MHz)	Conducted Power (dBm)	G _T -L _c (dB)	ERP (dBm)	ERP (mW)	Limit (W)
128	824.2	26.3	-3.36	20.79	119.95	7
189	836.4	26.24	-3.36	20.73	118.3	7
251	848.8	26.29	-3.36	20.78	119.67	7

REMARKS: ERP Output Power (dBm) = EIRP (dBm) -2.15(dB).

WCDMA

Channel	Frequency (MHz)	Conducted Power (dBm)	G _T -L _c (dB)	ERP (dBm)	ERP (mW)	Limit (W)
4132	826.4	24.19	-3.36	18.68	73.79	7
4182	836.4	24.08	-3.36	18.57	71.94	7
4233	846.6	24.06	-3.36	18.55	71.61	7

REMARKS: ERP Output Power (dBm) = EIRP (dBm) -2.15(dB).



LTE BAND 5

CHANNEL BANDWIDTH: 1.4MHz QPSK

Channel	Frequency (MHz)	Conducted Power (dBm)	G _T -L _c (dB)	ERP (dBm)	ERP (mW)	Limit (W)
20407	824.7	23.98	-3.36	18.47	70.31	7
20525	836.5	24.12	-3.36	18.61	72.61	7
20643	848.3	23.99	-3.36	18.48	70.47	7

CHANNEL BANDWIDTH: 1.4MHz 16QAM

Channel	Frequency (MHz)	Conducted Power (dBm)	G _T -L _c (dB)	ERP (dBm)	ERP (mW)	Limit (W)
20407	824.7	23.17	-3.36	17.66	58.34	7
20525	836.5	23.25	-3.36	17.74	59.43	7
20643	848.3	23.25	-3.36	17.74	59.43	7

CHANNEL BANDWIDTH: 1.4MHz 64QAM

Channel	Frequency (MHz)	Conducted Power (dBm)	G _T -L _c (dB)	ERP (dBm)	ERP (mW)	Limit (W)
20407	824.7	22.04	-3.36	16.53	44.98	7
20525	836.5	22.24	-3.36	16.73	47.1	7
20643	848.3	22.16	-3.36	16.65	46.24	7

CHANNEL BANDWIDTH: 3MHz QPSK

Channel	Frequency (MHz)	Conducted Power (dBm)	G _T -L _c (dB)	ERP (dBm)	ERP (mW)	Limit (W)
20415	825.5	23.91	-3.36	18.4	69.18	7
20525	836.5	24.01	-3.36	18.5	70.79	7
20635	847.5	23.99	-3.36	18.48	70.47	7

CHANNEL BANDWIDTH: 3MHz 16QAM

Channel	Frequency (MHz)	Conducted Power (dBm)	G _T -L _c (dB)	ERP (dBm)	ERP (mW)	Limit (W)
20415	825.5	23.16	-3.36	17.65	58.21	7
20525	836.5	23.31	-3.36	17.8	60.26	7
20635	847.5	23.28	-3.36	17.77	59.84	7



CHANNEL BANDWIDTH: 3MHz 64QAM

Channel	Frequency (MHz)	Conducted Power (dBm)	G _{T-Lc} (dB)	ERP (dBm)	ERP (mW)	Limit (W)
20415	825.5	22.09	-3.36	16.58	45.5	7
20525	836.5	22.18	-3.36	16.67	46.45	7
20635	847.5	22.12	-3.36	16.61	45.81	7

CHANNEL BANDWIDTH: 5MHz QPSK

Channel	Frequency (MHz)	Conducted Power (dBm)	G _{T-Lc} (dB)	ERP (dBm)	ERP (mW)	Limit (W)
20425	826.5	23.96	-3.36	18.45	69.98	7
20525	836.5	23.96	-3.36	18.45	69.98	7
20625	846.5	23.99	-3.36	18.48	70.47	7

CHANNEL BANDWIDTH: 5MHz 16QAM

Channel	Frequency (MHz)	Conducted Power (dBm)	G _{T-Lc} (dB)	ERP (dBm)	ERP (mW)	Limit (W)
20425	826.5	23.16	-3.36	17.65	58.21	7
20525	836.5	23.3	-3.36	17.79	60.12	7
20625	846.5	23.28	-3.36	17.77	59.84	7

CHANNEL BANDWIDTH: 5MHz 64QAM

Channel	Frequency (MHz)	Conducted Power (dBm)	G _{T-Lc} (dB)	ERP (dBm)	ERP (mW)	Limit (W)
20425	826.5	22.04	-3.36	16.53	44.98	7
20525	836.5	22.24	-3.36	16.73	47.1	7
20625	846.5	22.16	-3.36	16.65	46.24	7

CHANNEL BANDWIDTH: 10MHz QPSK

Channel	Frequency (MHz)	Conducted Power (dBm)	G _{T-Lc} (dB)	ERP (dBm)	ERP (mW)	Limit (W)
20450	829.0	23.98	-3.36	18.47	70.31	7
20525	836.5	24.03	-3.36	18.52	71.12	7
20600	844.0	24.01	-3.36	18.5	70.79	7



CHANNEL BANDWIDTH: 10MHz 16QAM

Channel	Frequency (MHz)	Conducted Power (dBm)	G _{T-Lc} (dB)	ERP (dBm)	ERP (mW)	Limit (W)
20450	829.0	23.22	-3.36	17.71	59.02	7
20525	836.5	23.32	-3.36	17.81	60.39	7
20600	844.0	23.3	-3.36	17.79	60.12	7

CHANNEL BANDWIDTH: 10MHz 64QAM

Channel	Frequency (MHz)	Conducted Power (dBm)	G _{T-Lc} (dB)	ERP (dBm)	ERP (mW)	Limit (W)
20450	829.0	22.12	-3.36	16.61	45.81	7
20525	836.5	22.26	-3.36	16.75	47.32	7
20600	844.0	22.18	-3.36	16.67	46.45	7

REMARKS: ERP Output Power (dBm) = EIRP (dBm) -2.15(dB).



**BUREAU
VERITAS**

Test Report No.: W7L-P21100026RF13

Ant1:

GSM

Channel	Frequency (MHz)	Conducted Power (dBm)	G _T -L _c (dB)	ERP (dBm)	ERP (mW)	Limit (W)
128	824.2	32.61	-3.45	27.01	502.34	7
189	836.4	32.73	-3.45	27.13	516.42	7
251	848.8	32.58	-3.45	26.98	498.88	7

REMARKS: ERP Output Power (dBm) = EIRP (dBm) -2.15(dB).

EDGE

Channel	Frequency (MHz)	Conducted Power (dBm)	G _T -L _c (dB)	ERP (dBm)	ERP (mW)	Limit (W)
128	824.2	26.4	-3.45	20.8	120.23	7
189	836.4	26.45	-3.45	20.85	121.62	7
251	848.8	26.41	-3.45	20.81	120.5	7

REMARKS: ERP Output Power (dBm) = EIRP (dBm) -2.15(dB).

WCDMA

Channel	Frequency (MHz)	Conducted Power (dBm)	G _T -L _c (dB)	ERP (dBm)	ERP (mW)	Limit (W)
4132	826.4	24.45	-3.45	18.85	76.74	7
4182	836.4	24.38	-3.45	18.78	75.51	7
4233	846.6	24.41	-3.45	18.81	76.03	7

REMARKS: ERP Output Power (dBm) = EIRP (dBm) -2.15(dB).



LTE BAND 5

CHANNEL BANDWIDTH: 1.4MHz QPSK

Channel	Frequency (MHz)	Conducted Power (dBm)	G _T -L _c (dB)	ERP (dBm)	ERP (mW)	Limit (W)
20407	824.7	24.13	-3.45	18.53	71.29	7
20525	836.5	24.16	-3.45	18.56	71.78	7
20643	848.3	24.15	-3.45	18.55	71.61	7

CHANNEL BANDWIDTH: 1.4MHz 16QAM

Channel	Frequency (MHz)	Conducted Power (dBm)	G _T -L _c (dB)	ERP (dBm)	ERP (mW)	Limit (W)
20407	824.7	23.33	-3.45	17.73	59.29	7
20525	836.5	23.39	-3.45	17.79	60.12	7
20643	848.3	23.38	-3.45	17.78	59.98	7

CHANNEL BANDWIDTH: 1.4MHz 64QAM

Channel	Frequency (MHz)	Conducted Power (dBm)	G _T -L _c (dB)	ERP (dBm)	ERP (mW)	Limit (W)
20407	824.7	22.21	-3.45	16.61	45.81	7
20525	836.5	22.39	-3.45	16.79	47.75	7
20643	848.3	22.3	-3.45	16.7	46.77	7

CHANNEL BANDWIDTH: 3MHz QPSK

Channel	Frequency (MHz)	Conducted Power (dBm)	G _T -L _c (dB)	ERP (dBm)	ERP (mW)	Limit (W)
20415	825.5	24.09	-3.45	18.49	70.63	7
20525	836.5	24.14	-3.45	18.54	71.45	7
20635	847.5	24.14	-3.45	18.54	71.45	7

CHANNEL BANDWIDTH: 3MHz 16QAM

Channel	Frequency (MHz)	Conducted Power (dBm)	G _T -L _c (dB)	ERP (dBm)	ERP (mW)	Limit (W)
20415	825.5	23.31	-3.45	17.71	59.02	7
20525	836.5	23.42	-3.45	17.82	60.53	7
20635	847.5	23.4	-3.45	17.8	60.26	7



CHANNEL BANDWIDTH: 3MHz 64QAM

Channel	Frequency (MHz)	Conducted Power (dBm)	G _{T-Lc} (dB)	ERP (dBm)	ERP (mW)	Limit (W)
20415	825.5	22.24	-3.45	16.64	46.13	7
20525	836.5	22.33	-3.45	16.73	47.1	7
20635	847.5	22.29	-3.45	16.69	46.67	7

CHANNEL BANDWIDTH: 5MHz QPSK

Channel	Frequency (MHz)	Conducted Power (dBm)	G _{T-Lc} (dB)	ERP (dBm)	ERP (mW)	Limit (W)
20425	826.5	24.14	-3.45	18.54	71.45	7
20525	836.5	24.1	-3.45	18.5	70.79	7
20625	846.5	24.14	-3.45	18.54	71.45	7

CHANNEL BANDWIDTH: 5MHz 16QAM

Channel	Frequency (MHz)	Conducted Power (dBm)	G _{T-Lc} (dB)	ERP (dBm)	ERP (mW)	Limit (W)
20425	826.5	23.31	-3.45	17.71	59.02	7
20525	836.5	23.45	-3.45	17.85	60.95	7
20625	846.5	23.4	-3.45	17.8	60.26	7

CHANNEL BANDWIDTH: 5MHz 64QAM

Channel	Frequency (MHz)	Conducted Power (dBm)	G _{T-Lc} (dB)	ERP (dBm)	ERP (mW)	Limit (W)
20425	826.5	22.21	-3.45	16.61	45.81	7
20525	836.5	22.39	-3.45	16.79	47.75	7
20625	846.5	22.3	-3.45	16.7	46.77	7

CHANNEL BANDWIDTH: 10MHz QPSK

Channel	Frequency (MHz)	Conducted Power (dBm)	G _{T-Lc} (dB)	ERP (dBm)	ERP (mW)	Limit (W)
20450	829.0	24.16	-3.45	18.56	71.78	7
20525	836.5	24.18	-3.45	18.58	72.11	7
20600	844.0	24.16	-3.45	18.56	71.78	7



**BUREAU
VERITAS**

Test Report No.: W7L-P21100026RF13

CHANNEL BANDWIDTH: 10MHz 16QAM

Channel	Frequency (MHz)	Conducted Power (dBm)	G _{T-Lc} (dB)	ERP (dBm)	ERP (mW)	Limit (W)
20450	829.0	23.35	-3.45	17.75	59.57	7
20525	836.5	23.47	-3.45	17.87	61.24	7
20600	844.0	23.42	-3.45	17.82	60.53	7

CHANNEL BANDWIDTH: 10MHz 64QAM

Channel	Frequency (MHz)	Conducted Power (dBm)	G _{T-Lc} (dB)	ERP (dBm)	ERP (mW)	Limit (W)
20450	829.0	22.29	-3.45	16.69	46.67	7
20525	836.5	22.41	-3.45	16.81	47.97	7
20600	844.0	22.33	-3.45	16.73	47.1	7

REMARKS: ERP Output Power (dBm) = EIRP (dBm) -2.15(dB).

3.2 FREQUENCY STABILITY MEASUREMENT

3.2.1 LIMITS OF FREQUENCY STABILITY MEASUREMENT

1.5 ppm is for base and fixed station. 2.5 ppm is for mobile station.

3.2.2 TEST PROCEDURE

- Device is placed at the oven room. The oven room could control the temperatures and humidity. Power warm up is at least 15 min and power applied should perform before recording frequency error.
- EUT is connected the external power supply to control the DC input power. The test voltage range is from minimum to maximum working voltage. Each step shall be record the frequency error rate.
- The temperature range step is 10 degrees in this test items. All temperature levels shall be hold the $\pm 0.5^{\circ}\text{C}$ during the measurement testing. The each temperature step shall be at least 0.5 hours, consider the EUT could be test under the stability condition.

NOTE: The frequency error was recorded frequency error from the communication simulator.

3.2.3 TEST SETUP

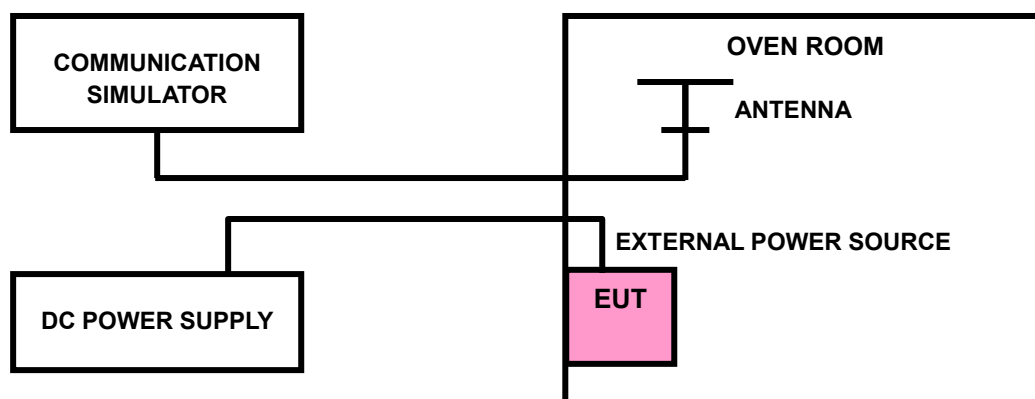



Test Report No.: W7L-P21100026RF13

3.2.4 TEST RESULTS

Please Refer to Appendix B Of this test report.

3.3 OCCUPIED BANDWIDTH MEASUREMENT

3.3.1 TEST PROCEDURES

The EUT makes a call to the communication simulator. All measurements were done at low, middle and high operational frequency range. The communication simulator station system controlled a EUT to export maximum output power under transmission mode and specific channel frequency. Use OBW measurement function of Spectrum analyzer to measure 99 % occupied bandwidth.

3.3.2 TEST SETUP

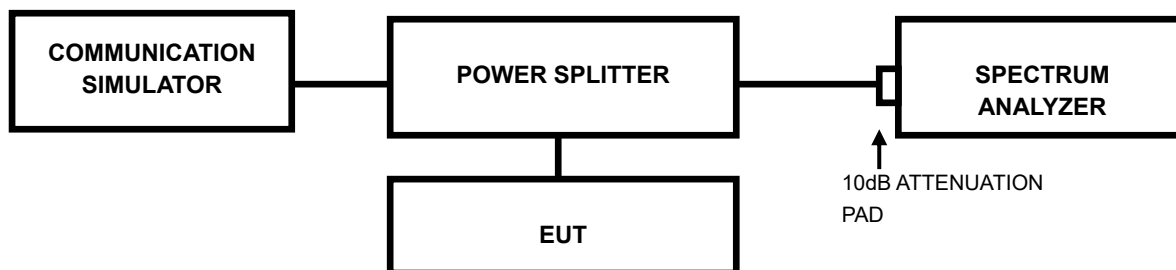



BUREAU
VERITAS

Test Report No.: W7L-P21100026RF13

3.3.3 TEST RESULTS

Please Refer to Appendix B Of this test report.

3.4 BAND EDGE MEASUREMENT

3.4.1 LIMITS OF BAND EDGE MEASUREMENT

Power of any emission outside of the authorized operating frequency ranges must be attenuated below the transmitting power (P) by a factor of at least $43 + 10 \log(P)$ dB. In the 1 MHz bands immediately outside and adjacent to the frequency block a resolution bandwidth of at least one percent of the emission bandwidth of the fundamental emission of the transmitter may be employed.

3.4.2 TEST SETUP

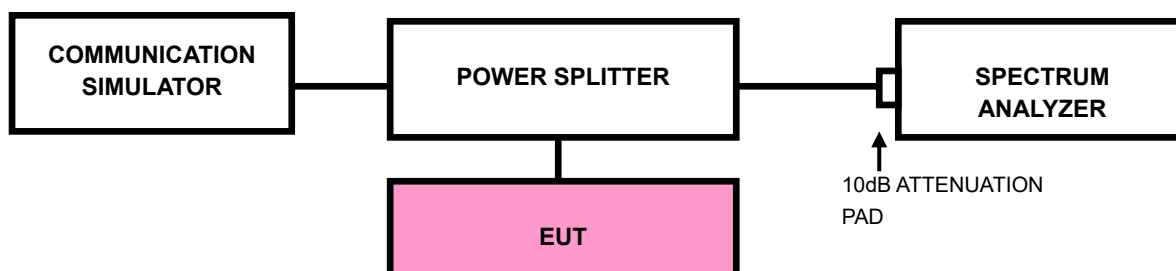



3.4.3 TEST PROCEDURES

- a. All measurements were done at low and high operational frequency range.
- b. The center frequency of spectrum is the band edge frequency and span is 1.5MHz. RBW of the spectrum is 10kHz and VBW of the spectrum is 30kHz (GSM/GPRS/EDGE).
- c. The center frequency of spectrum is the band edge frequency and span is 10MHz. RBW of the spectrum is 100kHz and VBW of the spectrum is 300kHz (WCDMA).
- d. The center frequency of spectrum is the band edge frequency and span is 1~5 MHz. RBW of the spectrum is 20kHz and VBW of the spectrum is 100 kHz. (LTE bandwidth 1.4MHz).
- e. The center frequency of spectrum is the band edge frequency and span is 1~5 MHz. RBW of the spectrum is 30kHz and VBW of the spectrum is 100kHz. (LTE bandwidth 3MHz)
- f. The center frequency of spectrum is the band edge frequency and span is 1~5 MHz. RBW of the spectrum is 50kHz and VBW of the spectrum is 200kHz. (LTE bandwidth 5MHz)
- g. The center frequency of spectrum is the band edge frequency and span is 1~5 MHz. RBW of the spectrum is 100kHz and VBW of the spectrum is 300kHz. (LTE bandwidth 10MHz)
- h. Record the max trace plot into the test report.



BUREAU
VERITAS

Test Report No.: W7L-P21100026RF13

3.4.4 TEST RESULTS

Please Refer to Appendix B Of this test report.

3.5 CONDUCTED SPURIOUS EMISSIONS

3.5.1 LIMITS OF CONDUCTED SPURIOUS EMISSIONS MEASUREMENT

The power of any emission outside of the authorized operating frequency ranges must be attenuated below the transmitting power (P) by a factor of at least $43 + 10 \log(P)$ dB. The emission limit equal to -13dBm .

3.5.2 TEST PROCEDURE

- a. The EUT makes a phone call to the communication simulator. All measurements were done at low, middle and high operational frequency range.
- b. Measuring frequency range is from 9 kHz to 9GHz. 10dB attenuation pad is connected with spectrum. RBW=1MHz and VBW=3MHz is used for conducted emission measurement.

3.5.3 TEST SETUP

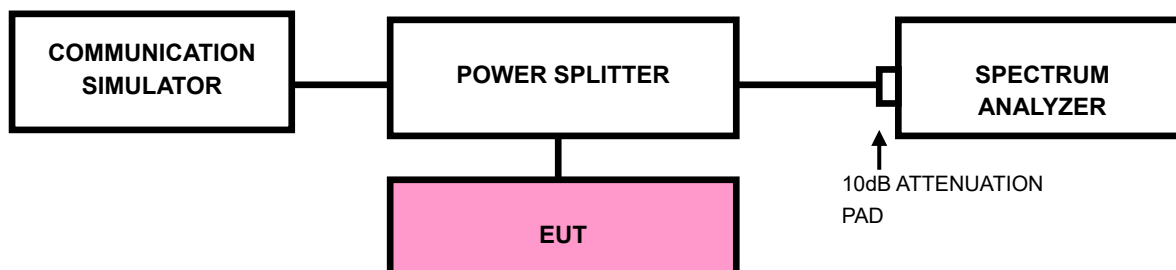



BUREAU
VERITAS

Test Report No.: W7L-P21100026RF13

3.5.4 TEST RESULTS

Please Refer to Appendix B Of this test report.



3.6 RADIATED EMISSION MEASUREMENT

3.6.1 LIMITS OF RADIATED EMISSION MEASUREMENT

The power of any emission outside of the authorized operating frequency ranges must be attenuated below the transmitting power (P) by a factor of at least $43 + 10 \log(P)$ dB. The emission limit equal to -13dBm .

3.6.2 TEST PROCEDURES

- a. Substitution method is used for E.I.R.P measurement. In the semi-anechoic chamber, EUT placed on the 0.8m height of Turn Table, rotated the table around 360 degrees to search the maximum radiation power and receiver antenna shall be rotated vertical and horizontal polarization and moved height from 1m to 4m to find the maximum polar radiated power. The "Read Value" is the spectrum reading the maximum power value.
- b. The substitution horn antenna is substituted for EUT at the same position and signals generator export the CW signal to the substitution antenna via a TX cable. Rotated the Turn Table and moved receiving antenna to find the maximum radiation power. Adjust output power level of S.G to get a Value of spectrum reading equal to "Read Value" of step a. Record the power level of S.G
- c. $\text{EIRP} = \text{Output power level of S.G} - \text{TX cable loss} + \text{Antenna gain of substitution horn}$.
- d. E.R.P power can be calculated form E.I.R.P power by subtracting the gain of dipole, $\text{E.R.P power} = \text{E.I.P.R power} - 2.15\text{dBi}$.

NOTE: The resolution bandwidth and video bandwidth of test receiver/spectrum analyzer is 1MHz/3MHz.

3.6.3 DEVIATION FROM TEST STANDARD

No deviation



3.6.4 TEST SETUP

< Frequency Range 30MHz~1GHz >

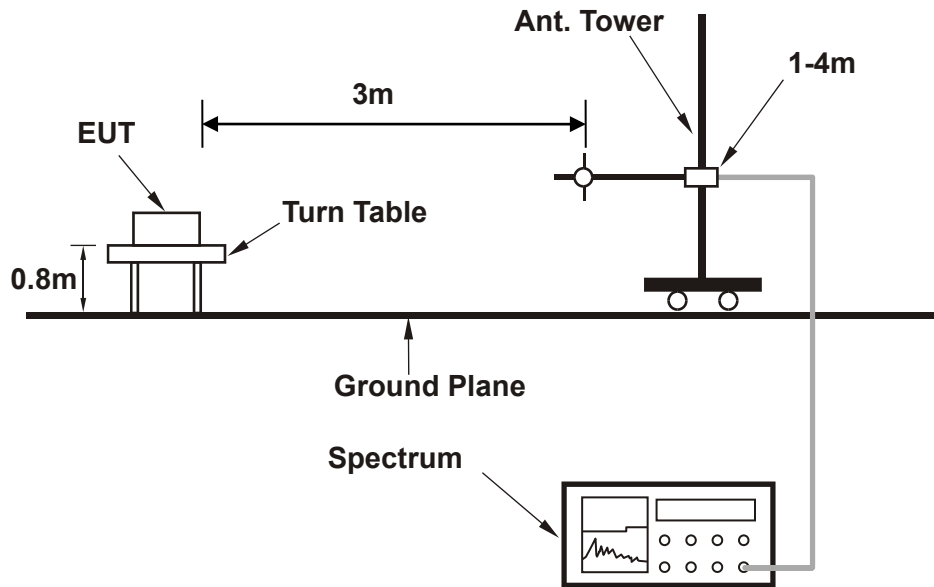

<Frequency Range above 1GHz>

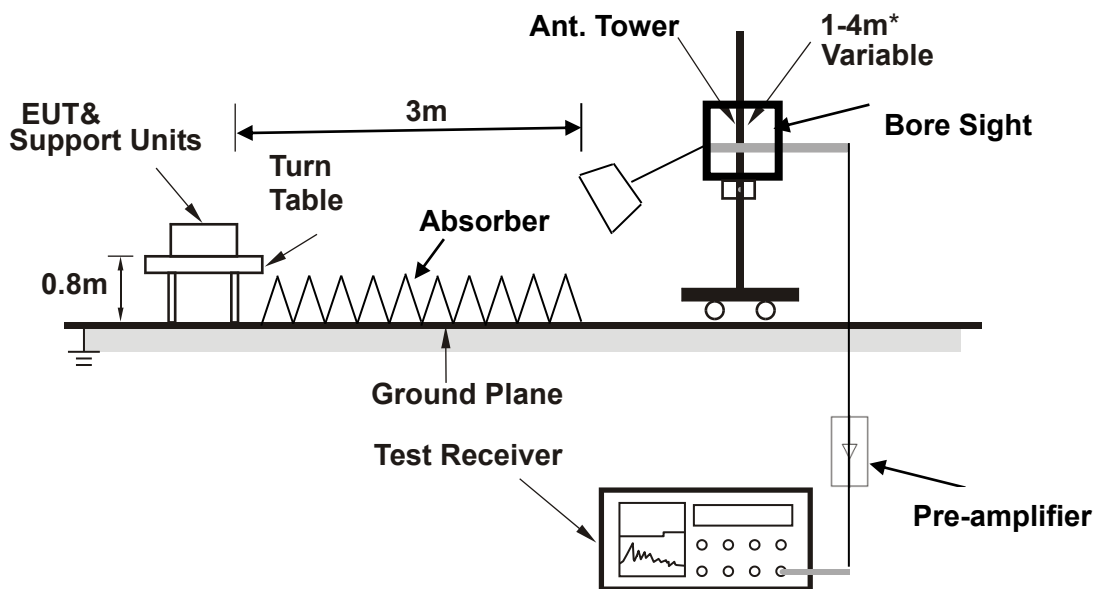

Note: Above 1G is a directional antenna

Depends on the EUT height and the antenna 3dB beamwidth both, refer to section 7.3 of CISPR 16-2-3.

For the actual test configuration, please refer to the attached file (Test Setup Photo).



**BUREAU
VERITAS**

Test Report No.: W7L-P21100026RF13

3.6.5 TEST RESULTS

BELOW 1GHz WORST-CASE DATA

30 MHz – 1GHz data:

GSM850 (Ant1)

CHANNEL BANDWIDTH: 128 ~ 251

MODE	TX channel 251	FREQUENCY RANGE	Below 1000MHz
ENVIRONMENTAL CONDITIONS	23deg. C, 70%RH	INPUT POWER	AC 120V/60Hz
TESTED BY	Jace Hu		
ANTENNA POLARITY & TEST DISTANCE: HORIZONTAL AT 3 M			

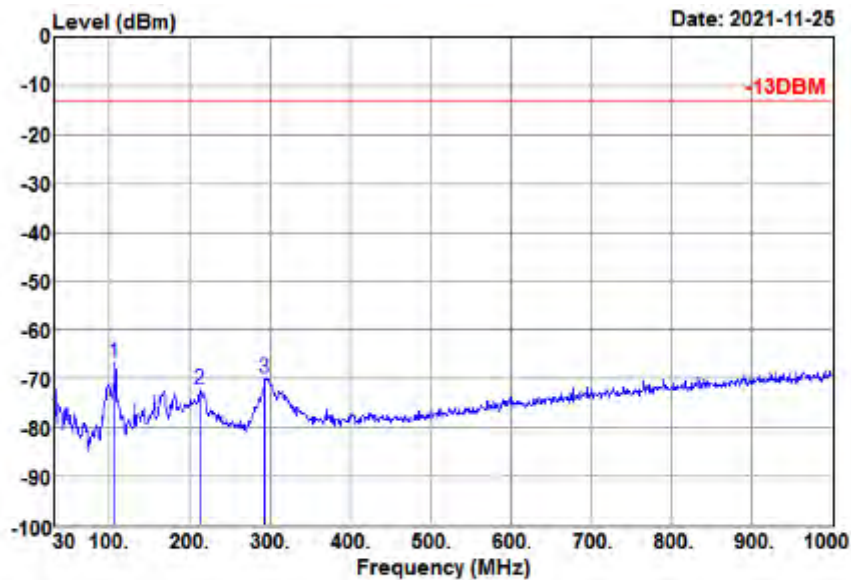

Freq MHz	Reading level dBm	Aux factor dB	level dBm	Limit level dBm	Over limit dB	Remark
107.600	-60.30	-6.33	-66.63	-13.00	-53.63	Peak
213.330	-66.23	-5.95	-72.18	-13.00	-59.18	Peak
293.840	-66.93	-2.91	-69.84	-13.00	-56.84	Peak



**BUREAU
VERITAS**

Test Report No.: W7L-P21100026RF13

MODE	TX channel 251	FREQUENCY RANGE	Below 1000MHz
ENVIRONMENTAL CONDITIONS	23deg. C, 70%RH	INPUT POWER	AC 120V/60Hz
TESTED BY	Jace Hu		
ANTENNA POLARITY & TEST DISTANCE: VERTICAL AT 3 M			

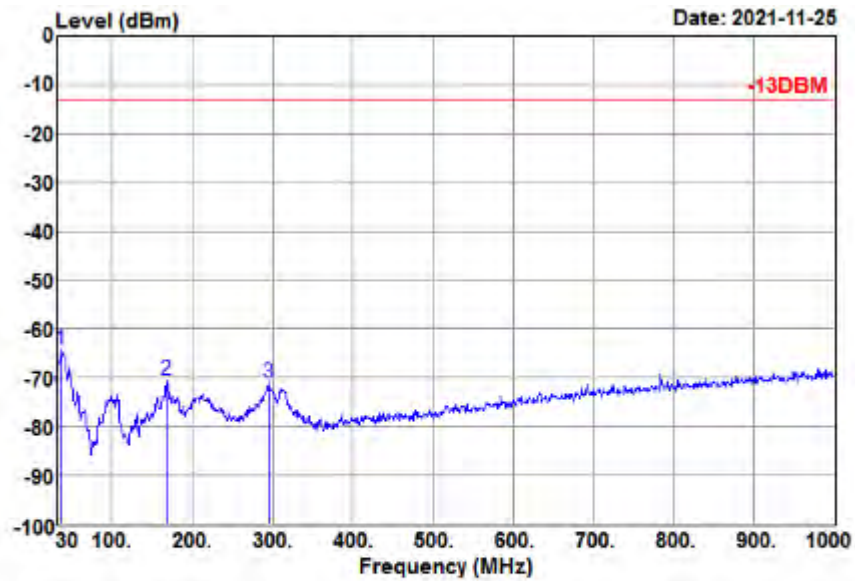

Freq MHz	Reading level dBm	Aux factor dB	level dBm	Limit level dBm	Over limit dB	Remark
37.760	-59.47	-4.78	-64.25	-13.00	-51.25	Peak
168.710	-66.44	-4.00	-70.44	-13.00	-57.44	Peak
294.810	-68.28	-2.87	-71.15	-13.00	-58.15	Peak



**BUREAU
VERITAS**

Test Report No.: W7L-P21100026RF13

ABOVE 1GHz DATA

Note:

1. The emission in the range of 1 GHz~1.5 GHz was tested 20db below the limit, the data not recorded in the sheet.
2. For higher frequency, the emission is too low to be detected.

GSM 850(Ant1)

CH 128:

MODE	TX channel 128	FREQUENCY RANGE	Above 1000MHz
ENVIRONMENTAL CONDITIONS	23deg. C, 70%RH	INPUT POWER	AC 120V/60Hz
TESTED BY	Jace Hu		
ANTENNA POLARITY & TEST DISTANCE: HORIZONTAL AT 3 M			

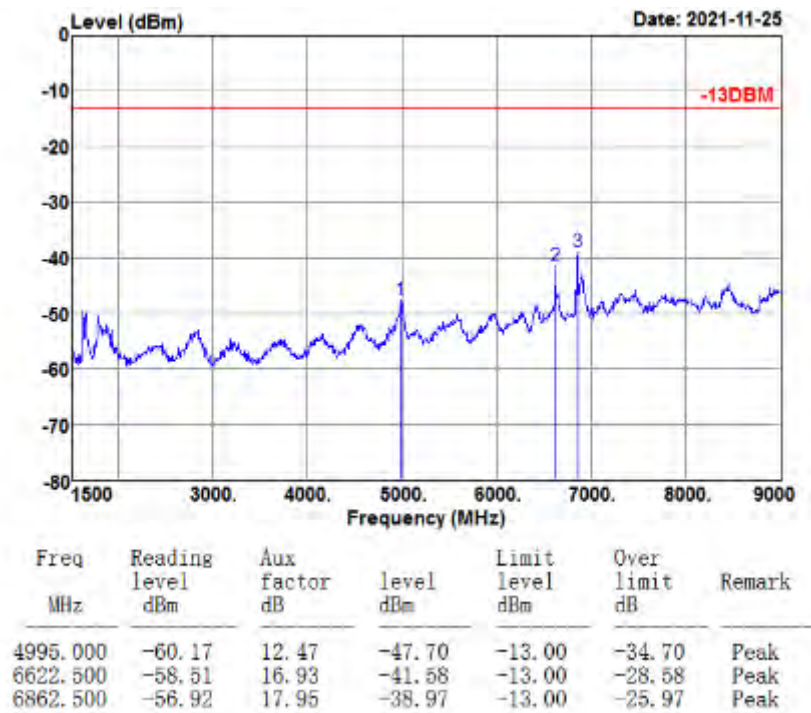



**BUREAU
VERITAS**

Test Report No.: W7L-P21100026RF13

MODE	TX channel 128	FREQUENCY RANGE	Above 1000MHz
ENVIRONMENTAL CONDITIONS	23deg. C, 70%RH	INPUT POWER	AC 120V/60Hz
TESTED BY	Jace Hu		
ANTENNA POLARITY & TEST DISTANCE: VERTICAL AT 3 M			

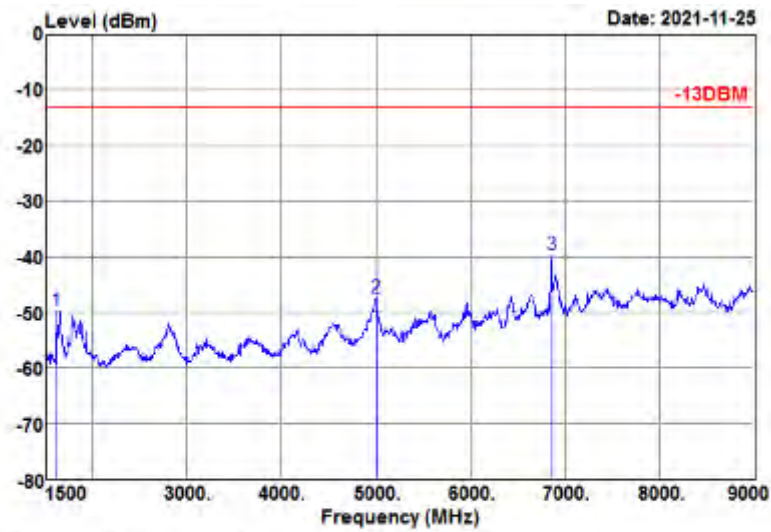

Freq MHz	Reading level dBm	Aux factor dB	level dBm	Limit level dBm	Over limit dB	Remark
1627.500	-56.02	6.30	-49.72	-13.00	-36.72	Peak
5002.500	-60.20	12.89	-47.31	-13.00	-34.31	Peak
6862.500	-57.97	18.38	-39.59	-13.00	-26.59	Peak



**BUREAU
VERITAS**

Test Report No.: W7L-P21100026RF13

CH 189:

MODE	TX channel 189	FREQUENCY RANGE	Above 1000MHz
ENVIRONMENTAL CONDITIONS	23deg. C, 70%RH	INPUT POWER	AC 120V/60Hz
TESTED BY	Jace Hu		
ANTENNA POLARITY & TEST DISTANCE: HORIZONTAL AT 3 M			

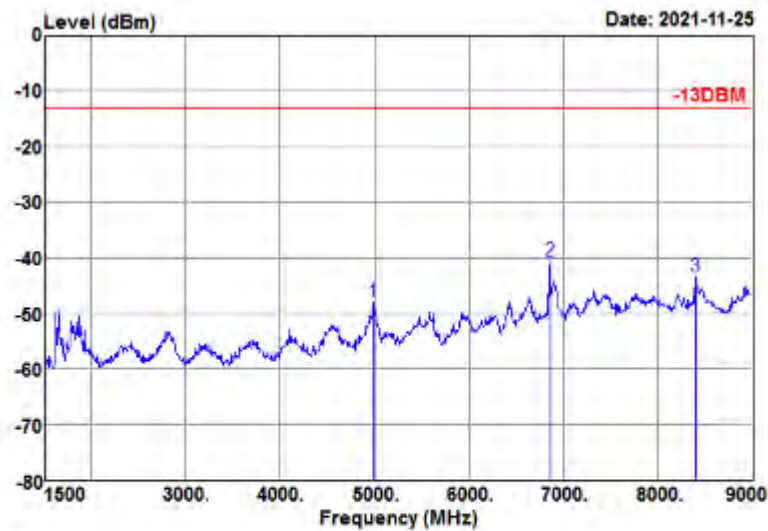

Freq MHz	Reading level dBm	Aux factor dB	level dBm	Limit level dBm	Over limit dB	Remark
4987.500	-60.24	12.45	-47.79	-13.00	-34.79	Peak
6862.500	-58.64	17.95	-40.69	-13.00	-27.69	Peak
8400.000	-62.65	19.25	-43.40	-13.00	-30.40	Peak



**BUREAU
VERITAS**

Test Report No.: W7L-P21100026RF13

MODE	TX channel 189	FREQUENCY RANGE	Above 1000MHz
ENVIRONMENTAL CONDITIONS	23deg. C, 70%RH	INPUT POWER	AC 120V/60Hz
TESTED BY	Jace Hu		
ANTENNA POLARITY & TEST DISTANCE: VERTICAL AT 3 M			

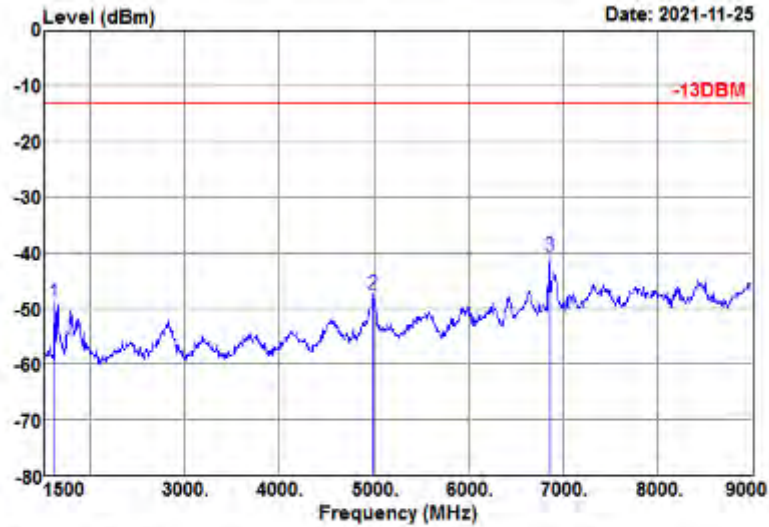

Freq MHz	Reading level dBm	Aux factor dB	level dBm	Limit level dBm	Over limit dB	Remark
1627.500	-55.18	6.30	-48.88	-13.00	-35.88	Peak
4987.500	-60.24	12.86	-47.38	-13.00	-34.38	Peak
6862.500	-59.05	18.38	-40.67	-13.00	-27.67	Peak



**BUREAU
VERITAS**

Test Report No.: W7L-P21100026RF13

CH 251:

MODE	TX channel 251	FREQUENCY RANGE	Above 1000MHz
ENVIRONMENTAL CONDITIONS	23deg. C, 70%RH	INPUT POWER	AC 120V/60Hz
TESTED BY	Jace Hu		
ANTENNA POLARITY & TEST DISTANCE: HORIZONTAL AT 3 M			

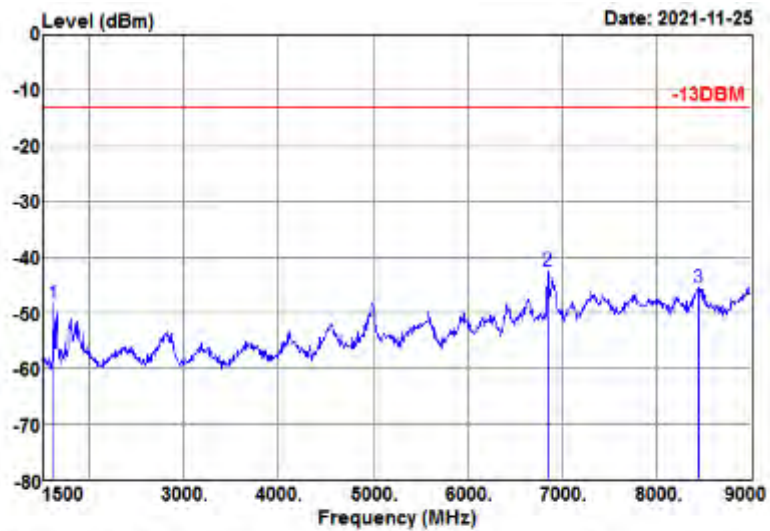

Freq MHz	Reading level dBm	Aux factor dB	level dBm	Limit level dBm	Over limit dB	Remark
1627.500	-54.25	5.95	-48.30	-13.00	-35.30	Peak
6855.000	-60.41	17.92	-42.49	-13.00	-29.49	Peak
8445.000	-64.77	19.26	-45.51	-13.00	-32.51	Peak



**BUREAU
VERITAS**

Test Report No.: W7L-P21100026RF13

MODE	TX channel 251	FREQUENCY RANGE	Above 1000MHz
ENVIRONMENTAL CONDITIONS	23deg. C, 70%RH	INPUT POWER	AC 120V/60Hz
TESTED BY	Jace Hu		
ANTENNA POLARITY & TEST DISTANCE: VERTICAL AT 3 M			

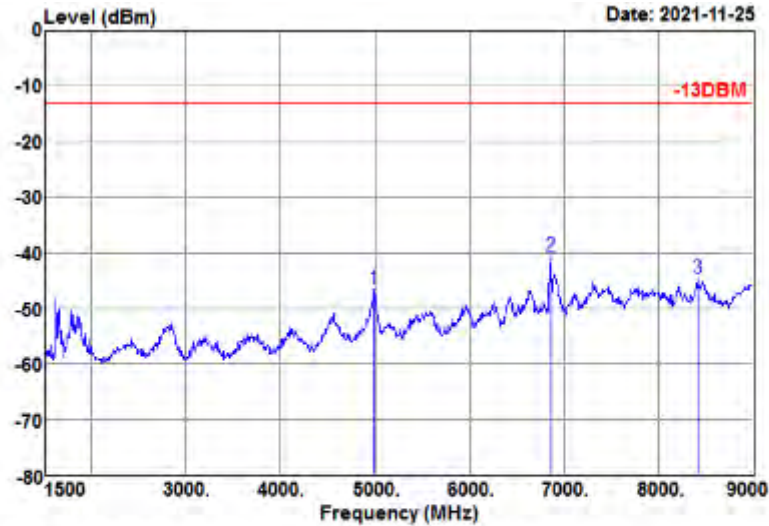

Freq MHz	Reading level dBm	Aux factor dB	level dBm	Limit level dBm	Over limit dB	Remark
4987.500	-59.23	12.86	-46.37	-13.00	-33.37	Peak
6862.500	-58.91	18.38	-40.53	-13.00	-27.53	Peak
8415.000	-64.03	19.53	-44.50	-13.00	-31.50	Peak



**BUREAU
VERITAS**

Test Report No.: W7L-P21100026RF13

EDGE 850(Ant1)

CH 128:

MODE	TX channel 128	FREQUENCY RANGE	Above 1000MHz
ENVIRONMENTAL CONDITIONS	23deg. C, 70%RH	INPUT POWER	AC 120V/60Hz
TESTED BY	Jace Hu		
ANTENNA POLARITY & TEST DISTANCE: HORIZONTAL AT 3 M			

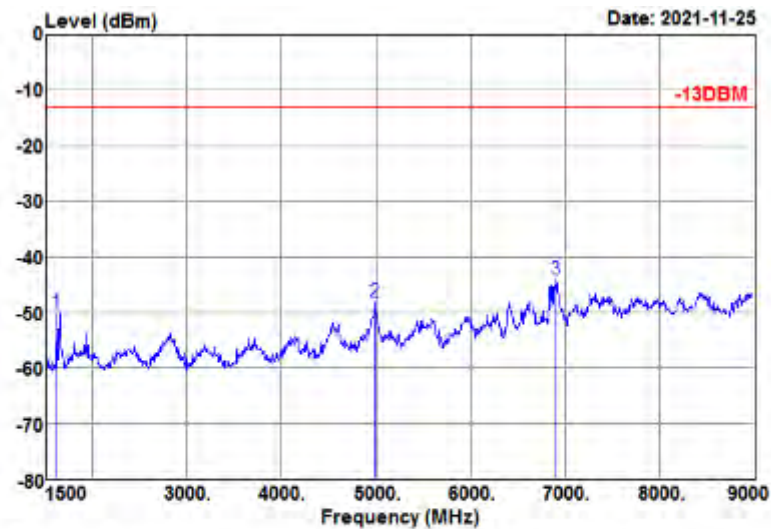

Freq MHz	Reading level dBm	Aux factor dB	level dBm	Limit level dBm	Over limit dB	Remark
1627.500	-55.93	5.95	-49.98	-13.00	-36.98	Peak
4987.500	-60.61	12.45	-48.16	-13.00	-35.16	Peak
6907.500	-62.19	18.15	-44.04	-13.00	-31.04	Peak



**BUREAU
VERITAS**

Test Report No.: W7L-P21100026RF13

MODE	TX channel 128	FREQUENCY RANGE	Above 1000MHz
ENVIRONMENTAL CONDITIONS	23deg. C, 70%RH	INPUT POWER	AC 120V/60Hz
TESTED BY	Jace Hu		
ANTENNA POLARITY & TEST DISTANCE: VERTICAL AT 3 M			

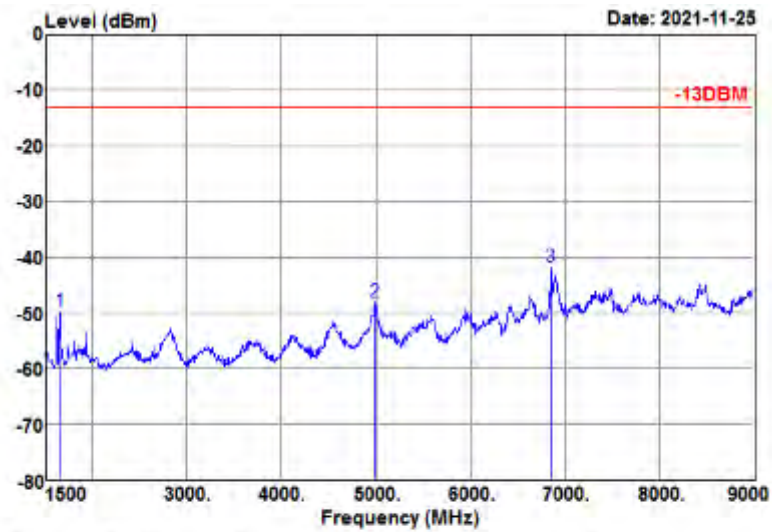

Freq MHz	Reading level dBm	Aux factor dB	level dBm	Limit level dBm	Over limit dB	Remark
1665.000	-56.37	6.51	-49.86	-13.00	-36.86	Peak
4987.500	-60.89	12.86	-48.03	-13.00	-35.03	Peak
6855.000	-60.04	18.35	-41.69	-13.00	-28.69	Peak



**BUREAU
VERITAS**

Test Report No.: W7L-P21100026RF13

CH 189:

MODE	TX channel 189	FREQUENCY RANGE	Above 1000MHz
ENVIRONMENTAL CONDITIONS	23deg. C, 70%RH	INPUT POWER	AC 120V/60Hz
TESTED BY	Jace Hu		
ANTENNA POLARITY & TEST DISTANCE: HORIZONTAL AT 3 M			

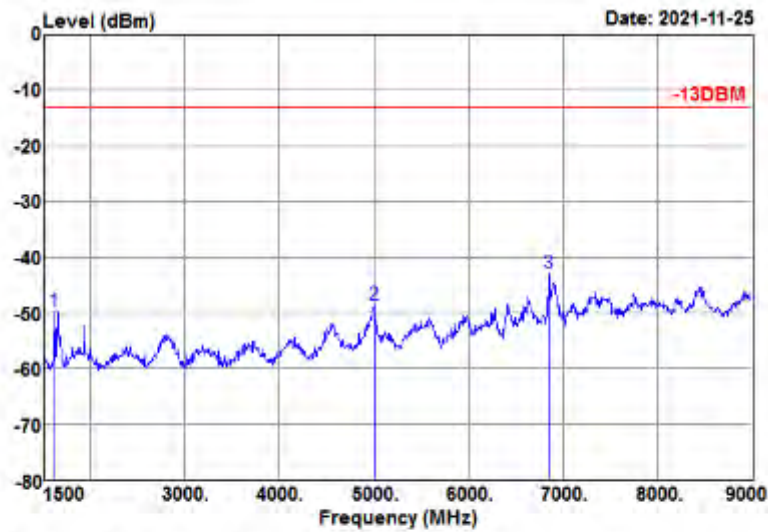

Freq MHz	Reading level dBm	Aux factor dB	level dBm	Limit level dBm	Over limit dB	Remark
1627.500	-55.76	5.95	-49.81	-13.00	-36.81	Peak
5002.500	-61.11	12.48	-48.63	-13.00	-35.63	Peak
6855.000	-60.94	17.92	-43.02	-13.00	-30.02	Peak



**BUREAU
VERITAS**

Test Report No.: W7L-P21100026RF13

MODE	TX channel 189	FREQUENCY RANGE	Above 1000MHz
ENVIRONMENTAL CONDITIONS	23deg. C, 70%RH	INPUT POWER	AC 120V/60Hz
TESTED BY	Jace Hu		
ANTENNA POLARITY & TEST DISTANCE: VERTICAL AT 3 M			

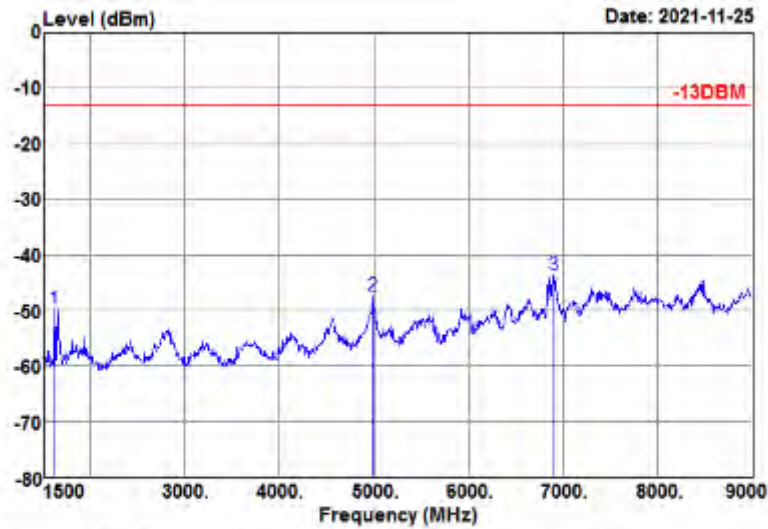

Freq MHz	Reading level dBm	Aux factor dB	level dBm	Limit level dBm	Over limit dB	Remark
1627.500	-56.00	6.30	-49.70	-13.00	-36.70	Peak
4987.500	-60.34	12.86	-47.48	-13.00	-34.48	Peak
6900.000	-62.21	18.53	-43.68	-13.00	-30.68	Peak



**BUREAU
VERITAS**

Test Report No.: W7L-P21100026RF13

CH 251:

MODE	TX channel 251	FREQUENCY RANGE	Above 1000MHz
ENVIRONMENTAL CONDITIONS	23deg. C, 70%RH	INPUT POWER	AC 120V/60Hz
TESTED BY	Jace Hu		
ANTENNA POLARITY & TEST DISTANCE: HORIZONTAL AT 3 M			

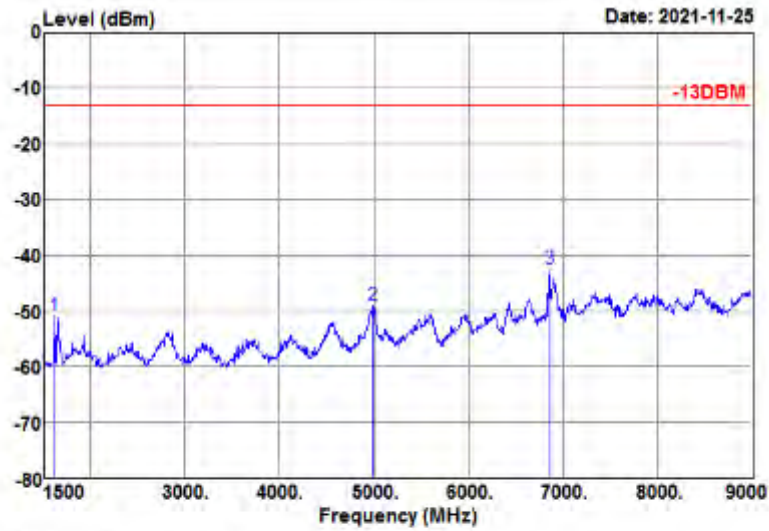

Freq MHz	Reading level dBm	Aux factor dB	level dBm	Limit level dBm	Over limit dB	Remark
1627.500	-57.00	5.95	-51.05	-13.00	-38.05	Peak
4987.500	-61.49	12.45	-49.04	-13.00	-36.04	Peak
6862.500	-60.36	17.95	-42.41	-13.00	-29.41	Peak



**BUREAU
VERITAS**

Test Report No.: W7L-P21100026RF13

MODE	TX channel 251	FREQUENCY RANGE	Above 1000MHz
ENVIRONMENTAL CONDITIONS	23deg. C, 70%RH	INPUT POWER	AC 120V/60Hz
TESTED BY	Jace Hu		
ANTENNA POLARITY & TEST DISTANCE: VERTICAL AT 3 M			

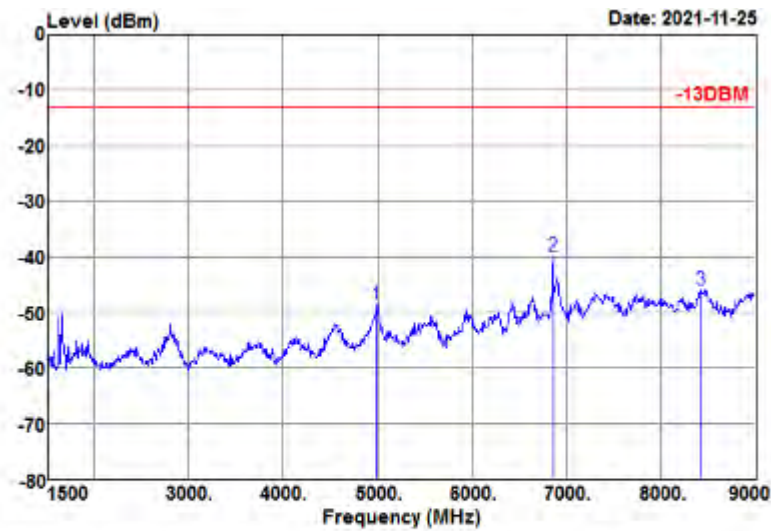

Freq MHz	Reading level dBm	Aux factor dB	level dBm	Limit level dBm	Over limit dB	Remark
4995.000	-61.48	12.88	-48.60	-13.00	-35.60	Peak
6862.500	-58.32	18.38	-39.94	-13.00	-26.94	Peak
8430.000	-65.48	19.53	-45.95	-13.00	-32.95	Peak



WCDMA Band V(Ant0)

CH 4132:

MODE	TX channel 4132	FREQUENCY RANGE	Above 1000MHz
ENVIRONMENTAL CONDITIONS	23deg. C, 70%RH	INPUT POWER	AC 120V/60Hz
TESTED BY	Jace Hu		
ANTENNA POLARITY & TEST DISTANCE: HORIZONTAL AT 3 M			

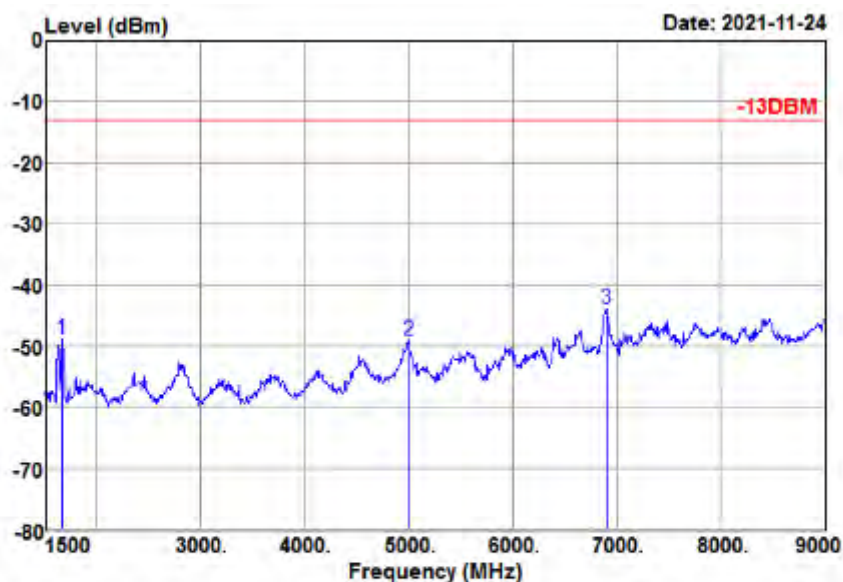

Freq MHz	Reading level dBm	Aux factor dB	level dBm	Limit level dBm	Over limit dB	Remark
1665.000	-55.14	6.19	-48.95	-13.00	-35.95	Peak
5002.500	-61.61	12.48	-49.13	-13.00	-36.13	Peak
6900.000	-62.06	18.11	-43.95	-13.00	-30.95	Peak



**BUREAU
VERITAS**

Test Report No.: W7L-P21100026RF13

MODE	TX channel 4132	FREQUENCY RANGE	Above 1000MHz
ENVIRONMENTAL CONDITIONS	23deg. C, 70%RH	INPUT POWER	AC 120V/60Hz
TESTED BY	Jace Hu		
ANTENNA POLARITY & TEST DISTANCE: VERTICAL AT 3 M			

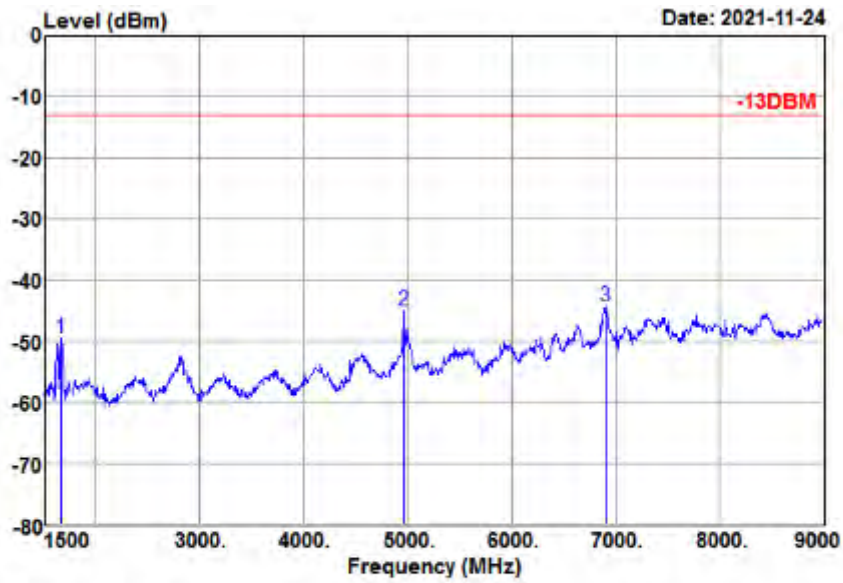

Freq MHz	Reading level dBm	Aux factor dB	level dBm	Limit level dBm	Over limit dB	Remark
1665.000	-55.98	6.51	-49.47	-13.00	-36.47	Peak
4965.000	-57.77	12.80	-44.97	-13.00	-31.97	Peak
6900.000	-62.94	18.53	-44.41	-13.00	-31.41	Peak



CH 4182:

MODE	TX channel 4182	FREQUENCY RANGE	Above 1000MHz
ENVIRONMENTAL CONDITIONS	23deg. C, 70%RH	INPUT POWER	AC 120V/60Hz
TESTED BY	Jace Hu		
ANTENNA POLARITY & TEST DISTANCE: HORIZONTAL AT 3 M			

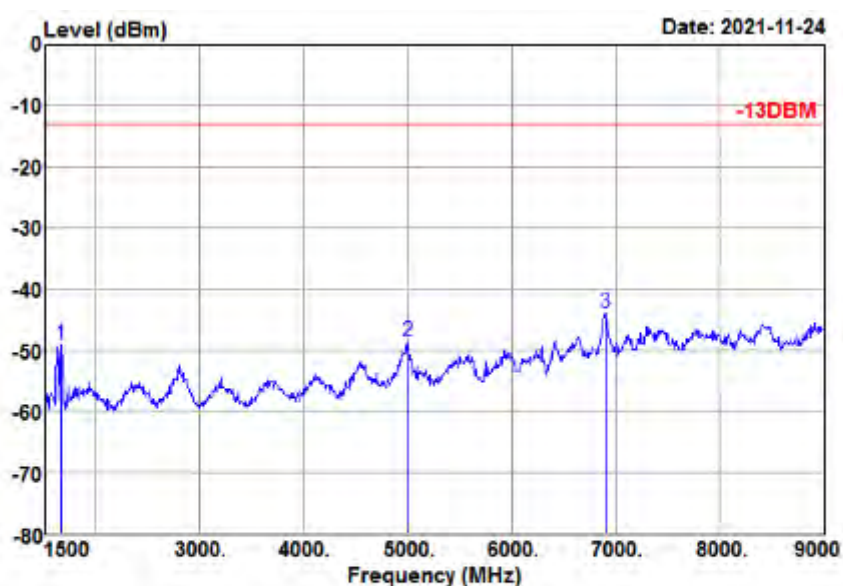

Freq MHz	Reading level dBm	Aux factor dB	level dBm	Limit level dBm	Over limit dB	Remark
1665.000	-55.31	6.19	-49.12	-13.00	-36.12	Peak
5002.500	-61.17	12.48	-48.69	-13.00	-35.69	Peak
6900.000	-61.96	18.11	-43.85	-13.00	-30.85	Peak



Test Report No.: W7L-P21100026RF13

MODE	TX channel 4182	FREQUENCY RANGE	Above 1000MHz
ENVIRONMENTAL CONDITIONS	23deg. C, 70%RH	INPUT POWER	AC 120V/60Hz
TESTED BY	Jace Hu		
ANTENNA POLARITY & TEST DISTANCE: VERTICAL AT 3 M			

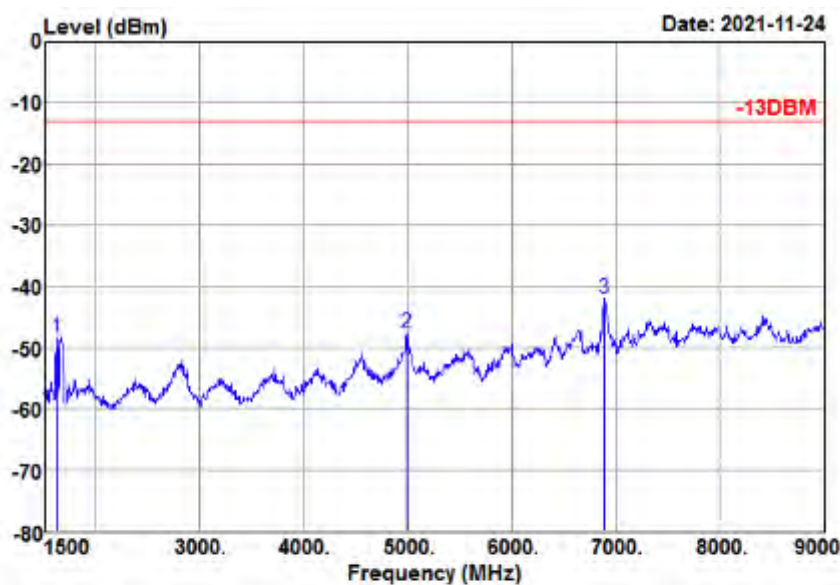

Freq MHz	Reading level dBm	Aux factor dB	level dBm	Limit level dBm	Over limit dB	Remark
1627.500	-54.62	6.30	-48.32	-13.00	-35.32	Peak
4987.500	-60.47	12.86	-47.61	-13.00	-34.61	Peak
6892.500	-60.54	18.50	-42.04	-13.00	-29.04	Peak



**BUREAU
VERITAS**

Test Report No.: W7L-P21100026RF13

CH 4233:

MODE	TX channel 4233	FREQUENCY RANGE	Above 1000MHz
ENVIRONMENTAL CONDITIONS	23deg. C, 70%RH	INPUT POWER	AC 120V/60Hz
TESTED BY	Jace Hu		
ANTENNA POLARITY & TEST DISTANCE: HORIZONTAL AT 3 M			

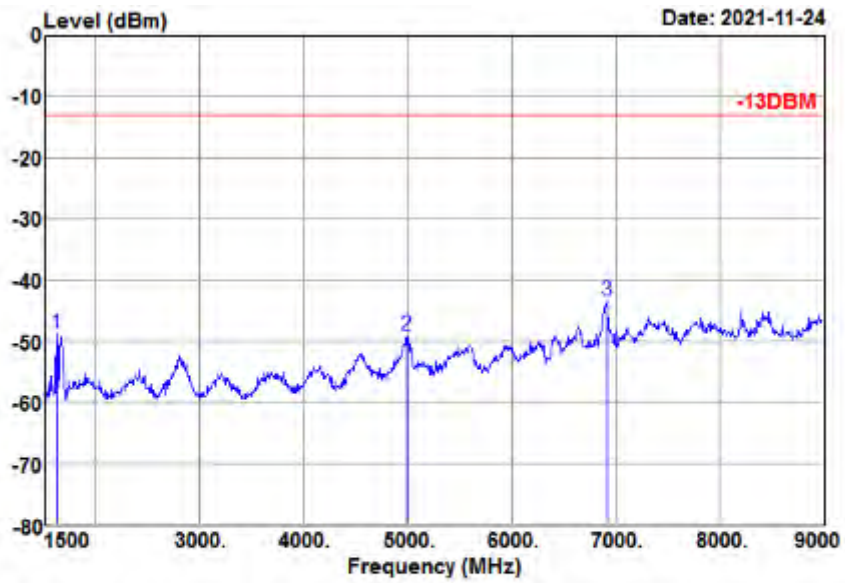

Freq MHz	Reading level dBm	Aux factor dB	level dBm	Limit level dBm	Over limit dB	Remark
1627.500	-54.85	5.95	-48.90	-13.00	-35.90	Peak
4987.500	-61.44	12.45	-48.99	-13.00	-35.99	Peak
6915.000	-61.68	18.18	-43.50	-13.00	-30.50	Peak



Test Report No.: W7L-P21100026RF13

MODE	TX channel 4233	FREQUENCY RANGE	Above 1000MHz
ENVIRONMENTAL CONDITIONS	23deg. C, 70%RH	INPUT POWER	AC 120V/60Hz
TESTED BY	Jace Hu		
ANTENNA POLARITY & TEST DISTANCE: VERTICAL AT 3 M			

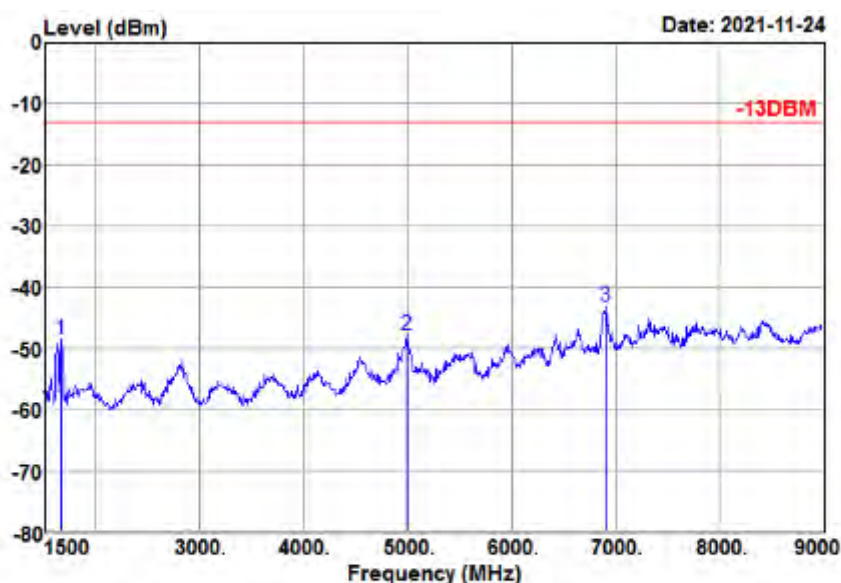

Freq MHz	Reading level dBm	Aux factor dB	level dBm	Limit level dBm	Over limit dB	Remark
1672.500	-55.21	6.55	-48.66	-13.00	-35.66	Peak
4987.500	-60.83	12.86	-47.97	-13.00	-34.97	Peak
6900.000	-61.71	18.53	-43.18	-13.00	-30.18	Peak



**BUREAU
VERITAS**

Test Report No.: W7L-P21100026RF13

LTE Band 5(Ant0)

CHANNEL BANDWIDTH: 1.4MHz / QPSK

MODE	TX channel 20525	FREQUENCY RANGE	Above 1000MHz
ENVIRONMENTAL CONDITIONS	23deg. C, 70%RH	INPUT POWER	AC 120V/60Hz
TESTED BY	Jace Hu		
ANTENNA POLARITY & TEST DISTANCE: HORIZONTAL AT 3 M			

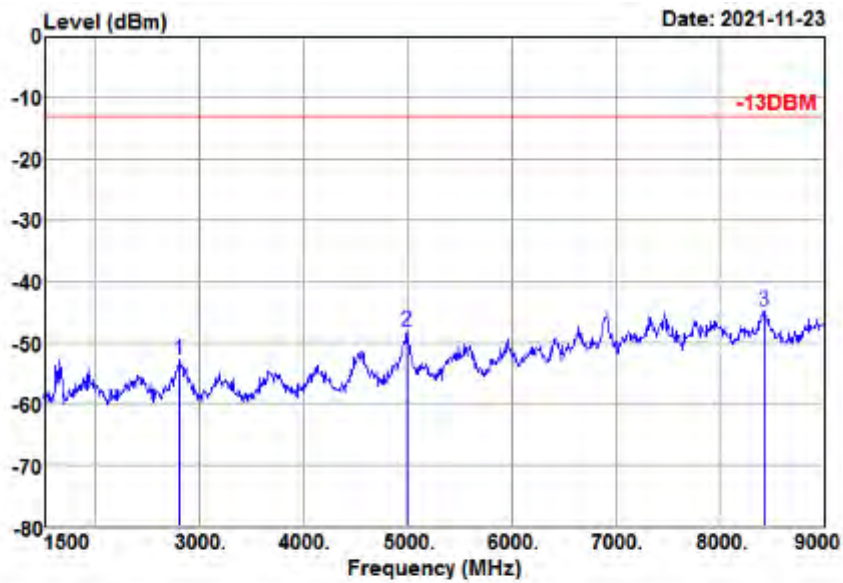

Freq MHz	Reading level dBm	Aux factor dB	level dBm	Limit level dBm	Over limit dB	Remark
2797.500	-60.65	7.89	-52.76	-13.00	-39.76	Peak
4987.500	-60.53	12.45	-48.08	-13.00	-35.08	Peak
8437.500	-64.10	19.26	-44.84	-13.00	-31.84	Peak



**BUREAU
VERITAS**

Test Report No.: W7L-P21100026RF13

MODE	TX channel 20525	FREQUENCY RANGE	Above 1000MHz
ENVIRONMENTAL CONDITIONS	23deg. C, 70%RH	INPUT POWER	AC 120V/60Hz
TESTED BY	Jace Hu		
ANTENNA POLARITY & TEST DISTANCE: VERTICAL AT 3 M			

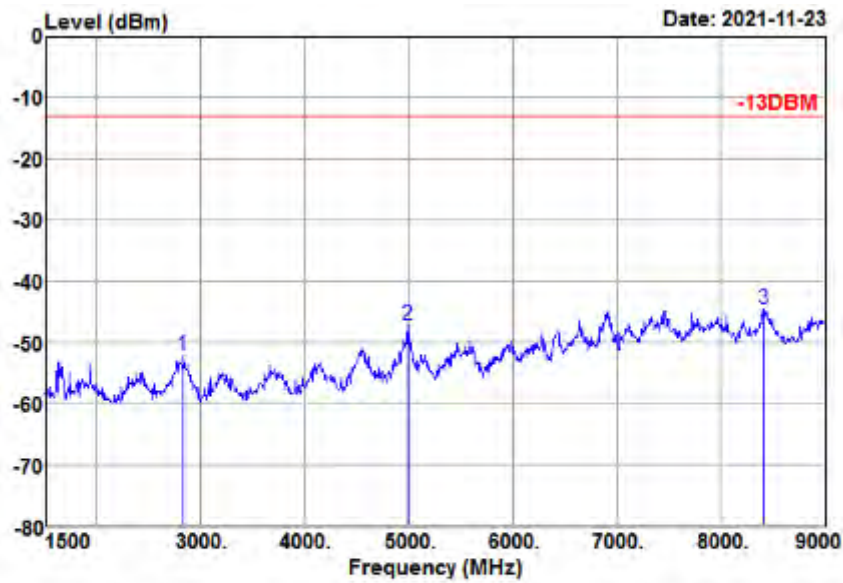

Freq MHz	Reading level dBm	Aux factor dB	level dBm	Limit level dBm	Over limit dB	Remark
2835.000	-60.10	8.03	-52.07	-13.00	-39.07	Peak
4995.000	-60.03	12.88	-47.15	-13.00	-34.15	Peak
8415.000	-64.06	19.53	-44.53	-13.00	-31.53	Peak



**BUREAU
VERITAS**

Test Report No.: W7L-P21100026RF13

CHANNEL BANDWIDTH: 3MHz / QPSK

MODE	TX channel 20525	FREQUENCY RANGE	Above 1000MHz
ENVIRONMENTAL CONDITIONS	23deg. C, 70%RH	INPUT POWER	AC 120V/60Hz
TESTED BY	Jace Hu		
ANTENNA POLARITY & TEST DISTANCE: HORIZONTAL AT 3 M			

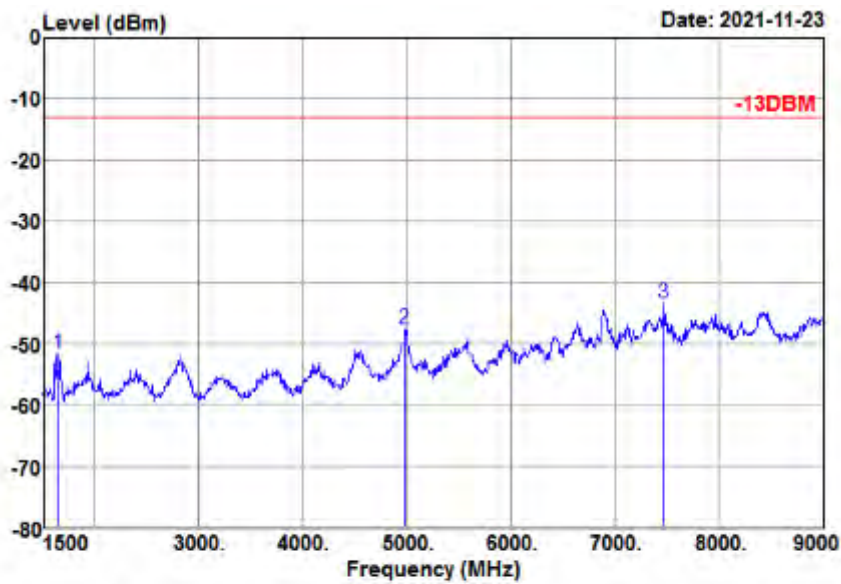

Freq MHz	Reading level dBm	Aux factor dB	level dBm	Limit level dBm	Over limit dB	Remark
1657.500	-57.84	6.14	-51.70	-13.00	-38.70	Peak
4980.000	-59.99	12.44	-47.55	-13.00	-34.55	Peak
7477.500	-63.86	20.47	-43.39	-13.00	-30.39	Peak



**BUREAU
VERITAS**

Test Report No.: W7L-P21100026RF13

MODE	TX channel 20525	FREQUENCY RANGE	Above 1000MHz
ENVIRONMENTAL CONDITIONS	23deg. C, 70%RH	INPUT POWER	AC 120V/60Hz
TESTED BY	Jace Hu		
ANTENNA POLARITY & TEST DISTANCE: VERTICAL AT 3 M			

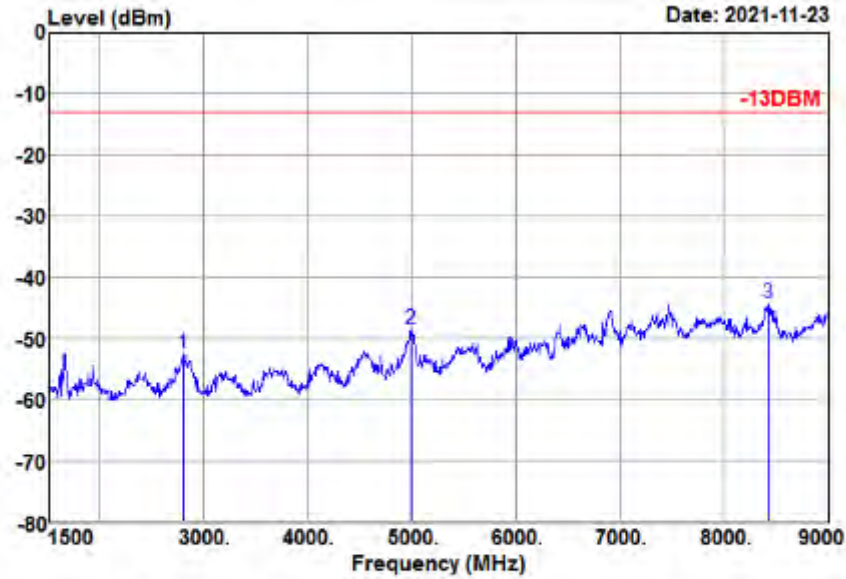

Freq MHz	Reading level dBm	Aux factor dB	level dBm	Limit level dBm	Over limit dB	Remark
2797.500	-60.84	8.27	-52.57	-13.00	-39.57	Peak
4987.500	-61.45	12.86	-48.59	-13.00	-35.59	Peak
8437.500	-63.81	19.53	-44.28	-13.00	-31.28	Peak



**BUREAU
VERITAS**

Test Report No.: W7L-P21100026RF13

CHANNEL BANDWIDTH: 5MHz / QPSK

MODE	TX channel 20525	FREQUENCY RANGE	Above 1000MHz
ENVIRONMENTAL CONDITIONS	23deg. C, 70%RH	INPUT POWER	AC 120V/60Hz
TESTED BY	Jace Hu		
ANTENNA POLARITY & TEST DISTANCE: HORIZONTAL AT 3 M			

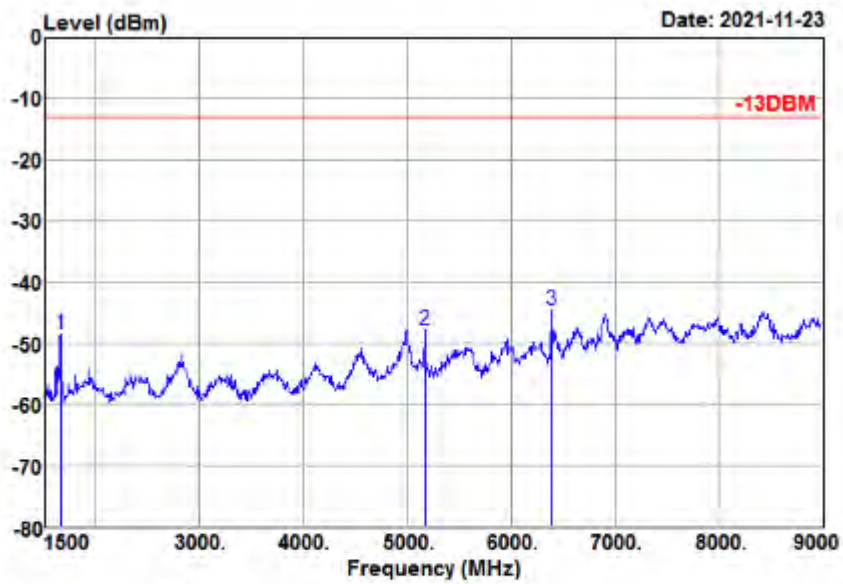

Freq MHz	Reading level dBm	Aux factor dB	level dBm	Limit level dBm	Over limit dB	Remark
1665.000	-54.76	6.19	-48.57	-13.00	-35.57	Peak
5167.500	-60.42	12.59	-47.83	-13.00	-34.83	Peak
6390.000	-60.41	15.92	-44.49	-13.00	-31.49	Peak



**BUREAU
VERITAS**

Test Report No.: W7L-P21100026RF13

MODE	TX channel 20525	FREQUENCY RANGE	Above 1000MHz
ENVIRONMENTAL CONDITIONS	23deg. C, 70%RH	INPUT POWER	AC 120V/60Hz
TESTED BY	Jace Hu		
ANTENNA POLARITY & TEST DISTANCE: VERTICAL AT 3 M			

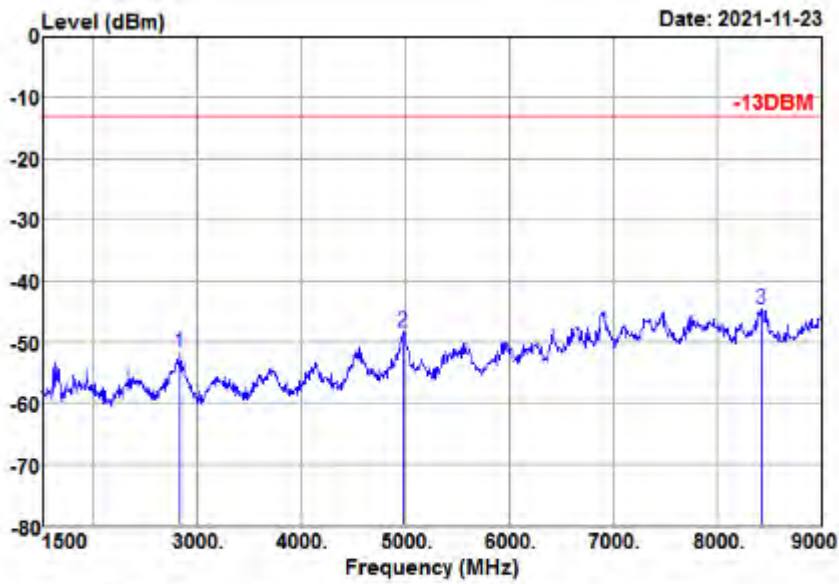

Freq MHz	Reading level dBm	Aux factor dB	level dBm	Limit level dBm	Over limit dB	Remark
2835.000	-59.71	8.03	-51.68	-13.00	-38.68	Peak
4980.000	-61.15	12.84	-48.31	-13.00	-35.31	Peak
8437.500	-64.04	19.53	-44.51	-13.00	-31.51	Peak



**BUREAU
VERITAS**

Test Report No.: W7L-P21100026RF13

CHANNEL BANDWIDTH: 10MHz / QPSK

CH20450:

MODE	TX channel 20450	FREQUENCY RANGE	Above 1000MHz
ENVIRONMENTAL CONDITIONS	23deg. C, 70%RH	INPUT POWER	AC 120V/60Hz
TESTED BY	Jace Hu		
ANTENNA POLARITY & TEST DISTANCE: HORIZONTAL AT 3 M			

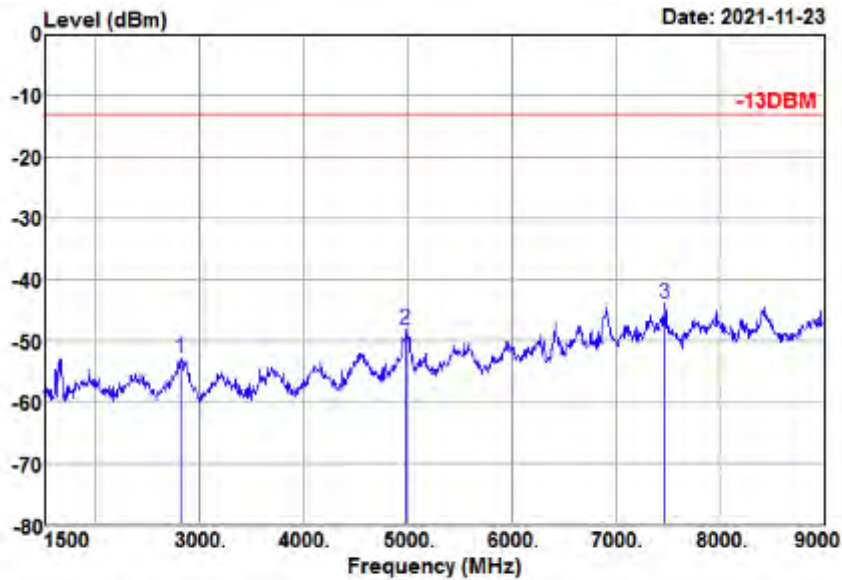

Freq MHz	Reading level dBm	Aux factor dB	level dBm	Limit level dBm	Over limit dB	Remark
2820.000	-60.61	7.78	-52.83	-13.00	-39.83	Peak
4980.000	-60.48	12.44	-48.04	-13.00	-35.04	Peak
7477.500	-64.30	20.47	-43.83	-13.00	-30.83	Peak



**BUREAU
VERITAS**

Test Report No.: W7L-P21100026RF13

MODE	TX channel 20450	FREQUENCY RANGE	Above 1000MHz
ENVIRONMENTAL CONDITIONS	23deg. C, 70%RH	INPUT POWER	AC 120V/60Hz
TESTED BY	Jace Hu		
ANTENNA POLARITY & TEST DISTANCE: VERTICAL AT 3 M			

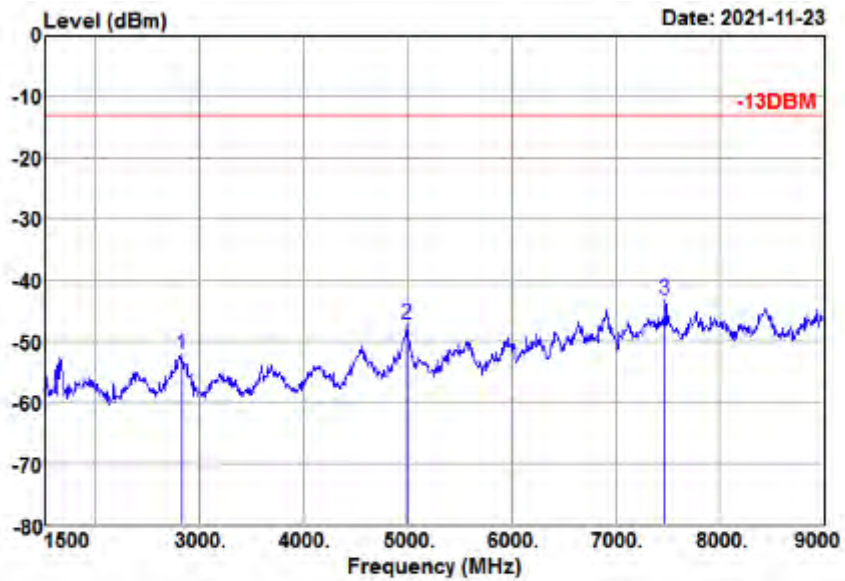

Freq MHz	Reading level dBm	Aux factor dB	level dBm	Limit level dBm	Over limit dB	Remark
2827.500	-60.17	8.08	-52.09	-13.00	-39.09	Peak
4995.000	-60.15	12.88	-47.27	-13.00	-34.27	Peak
7477.500	-64.30	21.02	-43.28	-13.00	-30.28	Peak



**BUREAU
VERITAS**

Test Report No.: W7L-P21100026RF13

CH20525:

MODE	TX channel 20525	FREQUENCY RANGE	Above 1000MHz
ENVIRONMENTAL CONDITIONS	23deg. C, 70%RH	INPUT POWER	AC 120V/60Hz
TESTED BY	Jace Hu		
ANTENNA POLARITY & TEST DISTANCE: HORIZONTAL AT 3 M			

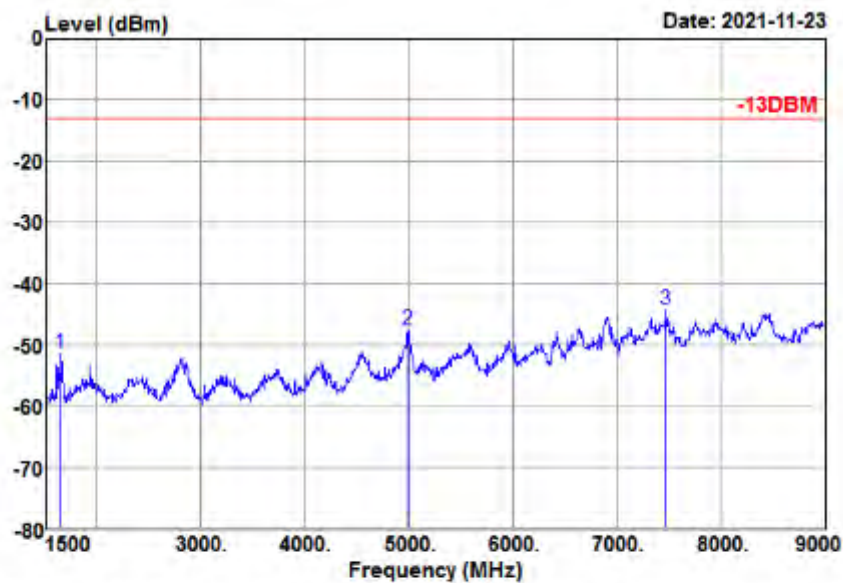

Freq MHz	Reading level dBm	Aux factor dB	level dBm	Limit level dBm	Over limit dB	Remark
1657.500	-57.49	6.14	-51.35	-13.00	-38.35	Peak
4987.500	-60.02	12.45	-47.57	-13.00	-34.57	Peak
7477.500	-64.89	20.47	-44.42	-13.00	-31.42	Peak



**BUREAU
VERITAS**

Test Report No.: W7L-P21100026RF13

MODE	TX channel 20525	FREQUENCY RANGE	Above 1000MHz
ENVIRONMENTAL CONDITIONS	23deg. C, 70%RH	INPUT POWER	AC 120V/60Hz
TESTED BY	Jace Hu		
ANTENNA POLARITY & TEST DISTANCE: VERTICAL AT 3 M			

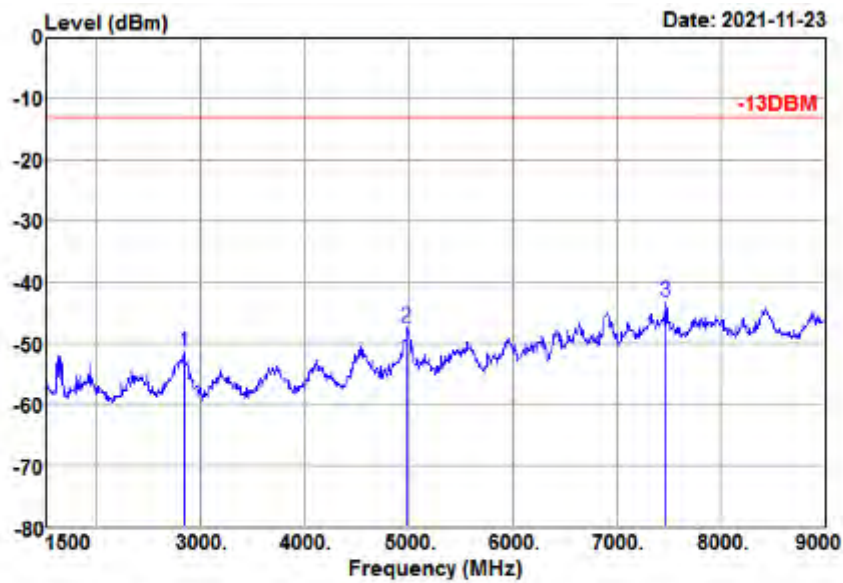

Freq MHz	Reading level dBm	Aux factor dB	level dBm	Limit level dBm	Over limit dB	Remark
2842.500	-59.53	7.98	-51.55	-13.00	-38.55	Peak
4980.000	-60.36	12.84	-47.52	-13.00	-34.52	Peak
7477.500	-64.15	21.02	-43.13	-13.00	-30.13	Peak



**BUREAU
VERITAS**

Test Report No.: W7L-P21100026RF13

CH20600:

MODE	TX channel 20600	FREQUENCY RANGE	Above 1000MHz
ENVIRONMENTAL CONDITIONS	23deg. C, 70%RH	INPUT POWER	AC 120V/60Hz
TESTED BY	Jace Hu		
ANTENNA POLARITY & TEST DISTANCE: HORIZONTAL AT 3 M			

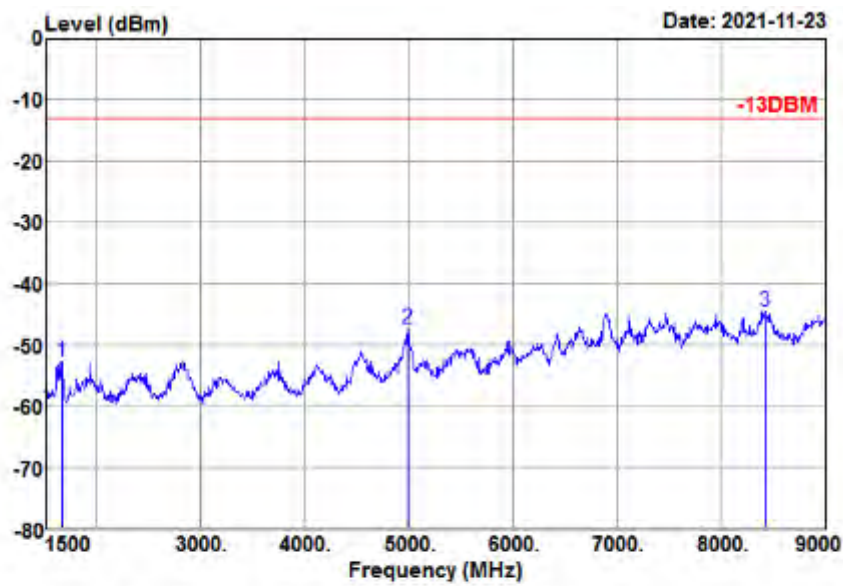

Freq MHz	Reading level dBm	Aux factor dB	level dBm	Limit level dBm	Over limit dB	Remark
1672.500	-59.05	6.24	-52.81	-13.00	-39.81	Peak
4995.000	-60.00	12.47	-47.53	-13.00	-34.53	Peak
8430.000	-63.73	19.25	-44.48	-13.00	-31.48	Peak



**BUREAU
VERITAS**

Test Report No.: W7L-P21100026RF13

MODE	TX channel 20600	FREQUENCY RANGE	Above 1000MHz
ENVIRONMENTAL CONDITIONS	23deg. C, 70%RH	INPUT POWER	AC 120V/60Hz
TESTED BY	Jace Hu		
ANTENNA POLARITY & TEST DISTANCE: VERTICAL AT 3 M			

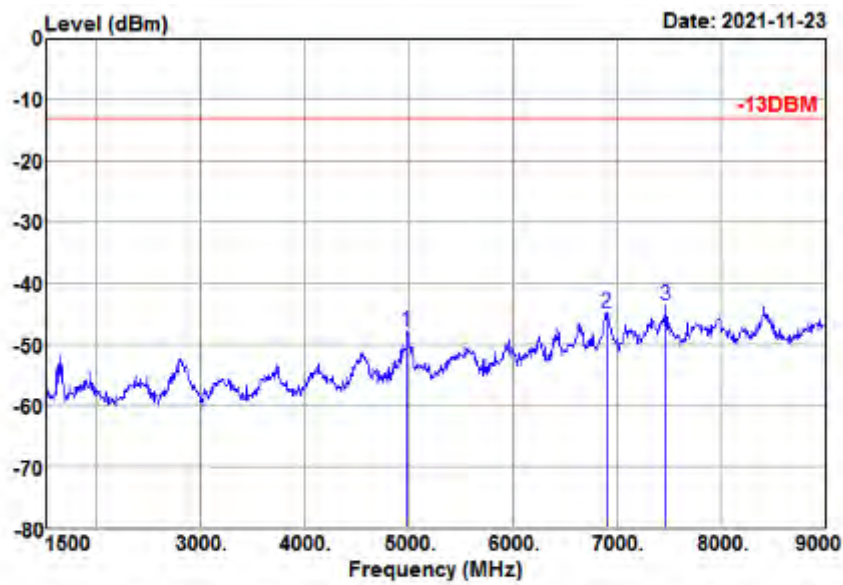

Freq MHz	Reading level dBm	Aux factor dB	level dBm	Limit level dBm	Over limit dB	Remark
4980.000	-60.85	12.84	-48.01	-13.00	-35.01	Peak
6907.500	-63.37	18.57	-44.80	-13.00	-31.80	Peak
7470.000	-64.72	20.99	-43.73	-13.00	-30.73	Peak

3.7 PEAK TO AVERAGE RATIO

3.7.1 LIMITS OF PEAK TO AVERAGE RATIO MEASUREMENT

In measuring transmissions in this band using an average power technique, the peak to-average ratio (PAR) of the transmission may not exceed 13 dB

3.7.2 TEST SETUP

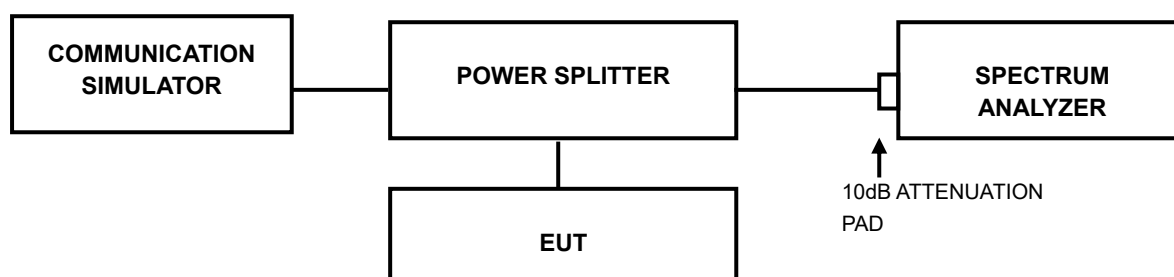

3.7.3 TEST PROCEDURES

1. Set resolution/measurement bandwidth \geq signal's occupied bandwidth;
2. Set the number of counts to a value that stabilizes the measured CCDF curve;
3. Record the maximum PAPR level associated with a probability of 0.1%.



BUREAU
VERITAS

Test Report No.: W7L-P21100026RF13

3.7.4 TEST RESULTS

Please Refer to Appendix B Of this test report.



Test Report No.: W7L-P21100026RF13

4 PHOTOGRAPHS OF THE TEST CONFIGURATION

Please refer to the attached file (Test Setup Photo).



Test Report No.: W7L-P21100026RF13

5 INFORMATION ON THE TESTING LABORATORIES

We, BV 7LAYERS COMMUNICATIONS TECHNOLOGY (SHENZHEN) CO. LTD., were founded in 2015 to provide our best service in EMC, Radio, Telecom and Safety consultation. Our laboratories are accredited and approved according to ISO/IEC 17025.

If you have any comments, please feel free to contact us at the following:

Shenzhen EMC/RF Lab:

Tel: +86-755-88696566

Fax: +86-755-88696577

Email: customerservice.sw@bureauveritas.com

Web Site: www.adt.com.tw

The address and road map of all our labs can be found in our web site also.



6 APPENDIX A – MODIFICATIONS RECORDERS FOR ENGINEERING CHANGES TO THE EUT BY THE LAB

No any modifications are made to the EUT by the lab during the test.

Please Refer to Appendix B Of this test report.

APPENDIX B :

GSM850

FREQUENCY STABILITY

GSM850

TEST RESULT

Band: GSM850							
Network	Frequency (MHz)	Temp. (°C)	Voltage (VDC)	Freq. Error (Hz)	Freq. vs. Rated (ppm)		Verdict
					Result	Limit	
GSM	824.2	20	3.27	0.07	0.00	-2.5 to 2.5	Pass
			3.85	1.20	0.00	-2.5 to 2.5	Pass
			4.43	0.29	0.00	-2.5 to 2.5	Pass
		-30	3.85	0.19	0.00	-2.5 to 2.5	Pass
		-20	3.85	-1.74	-0.00	-2.5 to 2.5	Pass
		-10	3.85	1.65	0.00	-2.5 to 2.5	Pass
		0	3.85	1.00	0.00	-2.5 to 2.5	Pass
		10	3.85	2.26	0.00	-2.5 to 2.5	Pass
		30	3.85	2.71	0.00	-2.5 to 2.5	Pass
		40	3.85	-0.26	-0.00	-2.5 to 2.5	Pass
	50	3.85	2.81	0.00	-2.5 to 2.5	Pass	
	836.6	20	3.27	2.49	0.00	-2.5 to 2.5	Pass
			3.85	-0.29	-0.00	-2.5 to 2.5	Pass
			4.43	-0.48	-0.00	-2.5 to 2.5	Pass
		-30	3.85	2.42	0.00	-2.5 to 2.5	Pass
		-20	3.85	3.46	0.00	-2.5 to 2.5	Pass
		-10	3.85	2.81	0.00	-2.5 to 2.5	Pass
		0	3.85	2.13	0.00	-2.5 to 2.5	Pass
		10	3.85	2.87	0.00	-2.5 to 2.5	Pass
		30	3.85	2.23	0.00	-2.5 to 2.5	Pass
		40	3.85	-0.45	-0.00	-2.5 to 2.5	Pass
	50	3.85	3.49	0.00	-2.5 to 2.5	Pass	
	848.8	20	3.27	0.10	0.00	-2.5 to 2.5	Pass
			3.85	2.71	0.00	-2.5 to 2.5	Pass
			4.43	2.23	0.00	-2.5 to 2.5	Pass
		-30	3.85	4.91	0.01	-2.5 to 2.5	Pass
		-20	3.85	2.10	0.00	-2.5 to 2.5	Pass
		-10	3.85	2.94	0.00	-2.5 to 2.5	Pass



**BUREAU
VERITAS**

Test Report No.: W7L-P21100026RF13

		0	3.85	-1.45	-0.00	-2.5 to 2.5	Pass
		10	3.85	3.10	0.00	-2.5 to 2.5	Pass
		30	3.85	-1.97	-0.00	-2.5 to 2.5	Pass
		40	3.85	2.36	0.00	-2.5 to 2.5	Pass
		50	3.85	1.39	0.00	-2.5 to 2.5	Pass
EGPRS	824.2	20	3.27	4.20	0.01	-2.5 to 2.5	Pass
			3.85	0.61	0.00	-2.5 to 2.5	Pass
			4.43	7.01	0.01	-2.5 to 2.5	Pass
		-30	3.85	0.00	0.00	-2.5 to 2.5	Pass
		-20	3.85	3.97	0.00	-2.5 to 2.5	Pass
		-10	3.85	1.23	0.00	-2.5 to 2.5	Pass
		0	3.85	1.23	0.00	-2.5 to 2.5	Pass
		10	3.85	1.87	0.00	-2.5 to 2.5	Pass
		30	3.85	2.71	0.00	-2.5 to 2.5	Pass
		40	3.85	6.46	0.01	-2.5 to 2.5	Pass
		50	3.85	1.49	0.00	-2.5 to 2.5	Pass
		836.6	20	3.27	5.04	0.01	-2.5 to 2.5
	3.85			-0.52	-0.00	-2.5 to 2.5	Pass
	4.43			-0.45	-0.00	-2.5 to 2.5	Pass
	-30		3.85	0.81	0.00	-2.5 to 2.5	Pass
	-20		3.85	6.59	0.01	-2.5 to 2.5	Pass
	-10		3.85	0.35	0.00	-2.5 to 2.5	Pass
	0		3.85	6.10	0.01	-2.5 to 2.5	Pass
	10		3.85	2.78	0.00	-2.5 to 2.5	Pass
	30		3.85	2.07	0.00	-2.5 to 2.5	Pass
	40		3.85	2.29	0.00	-2.5 to 2.5	Pass
	50		3.85	5.10	0.01	-2.5 to 2.5	Pass
	848.8		20	3.27	0.61	0.00	-2.5 to 2.5
		3.85		1.55	0.00	-2.5 to 2.5	Pass
		4.43		4.23	0.01	-2.5 to 2.5	Pass
		-30	3.85	6.59	0.01	-2.5 to 2.5	Pass
		-20	3.85	2.36	0.00	-2.5 to 2.5	Pass
		-10	3.85	3.87	0.00	-2.5 to 2.5	Pass
		0	3.85	4.65	0.01	-2.5 to 2.5	Pass
		10	3.85	3.62	0.00	-2.5 to 2.5	Pass
		30	3.85	0.26	0.00	-2.5 to 2.5	Pass
		40	3.85	6.23	0.01	-2.5 to 2.5	Pass
		50	3.85	4.97	0.01	-2.5 to 2.5	Pass



**BUREAU
VERITAS**

Test Report No.: W7L-P21100026RF13

99% & 26DB BANDWIDTH

GSM850_OBW

TEST RESULT

Band: GSM850					
ENV	Mode		Frequency (MHz)	99% Occupied Bandwidth (MHz)	Verdict
	Network	Subset		Result	
NTNV	GSM	/	824.2	0.239	Pass
			836.6	0.248	Pass
			848.8	0.238	Pass
	EGPRS	/	824.2	0.244	Pass
			836.6	0.243	Pass
			848.8	0.241	Pass



BUREAU
VERITAS

Test Report No.: W7L-P21100026RF13

TEST GRAPH

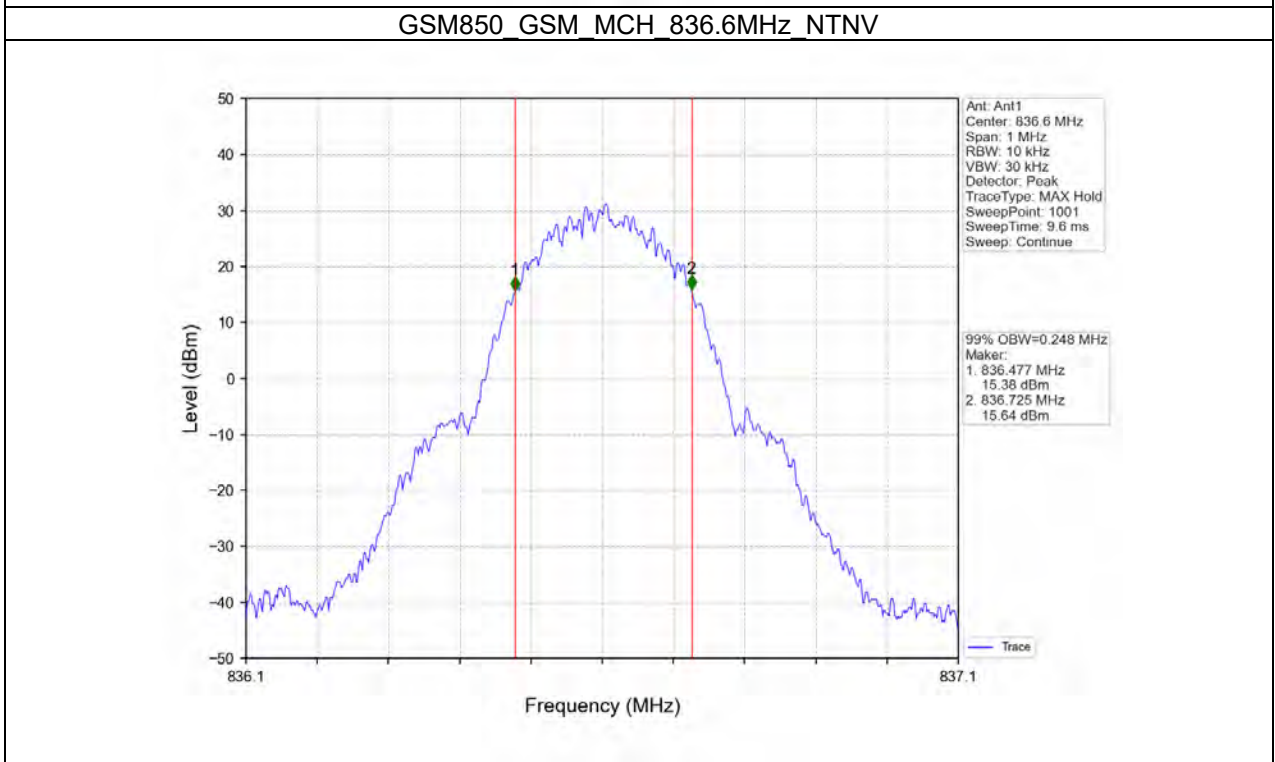
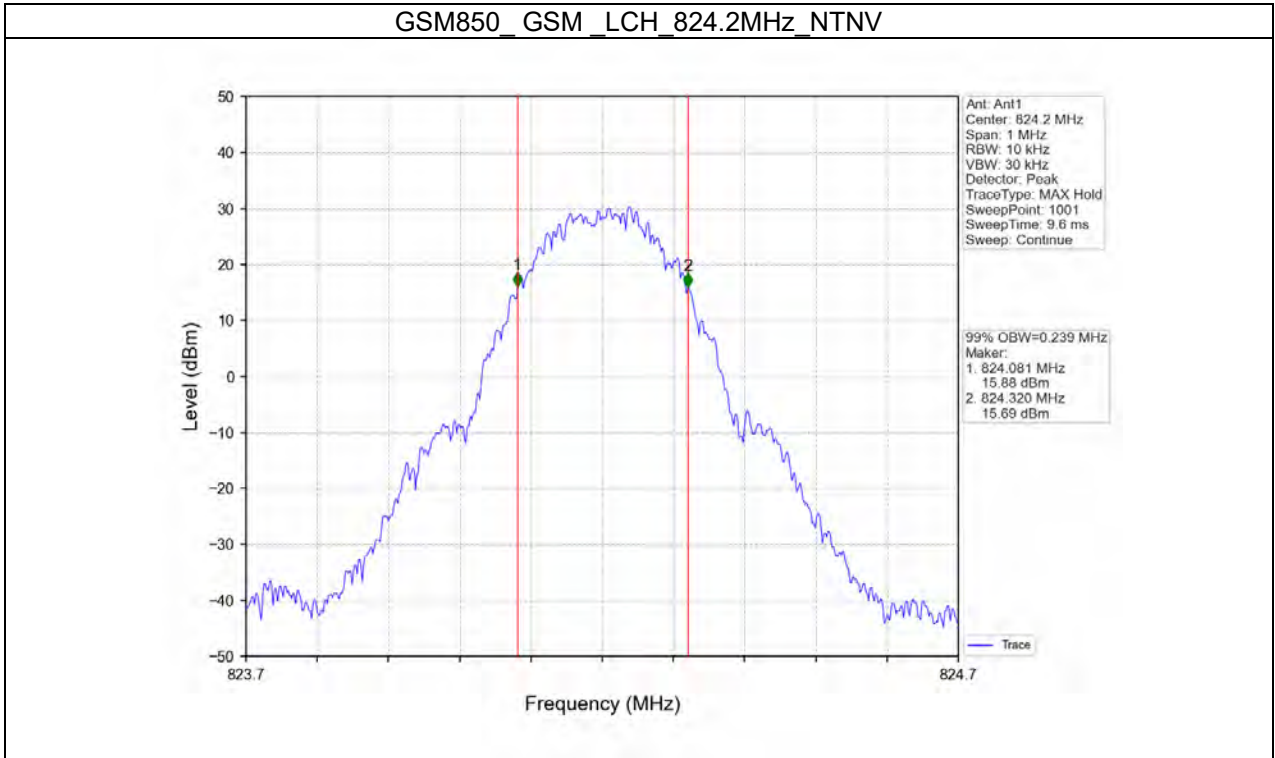



BUREAU
VERITAS

Test Report No.: W7L-P21100026RF13

GSM850_GSM_HCH_848.8MHz_NTNV

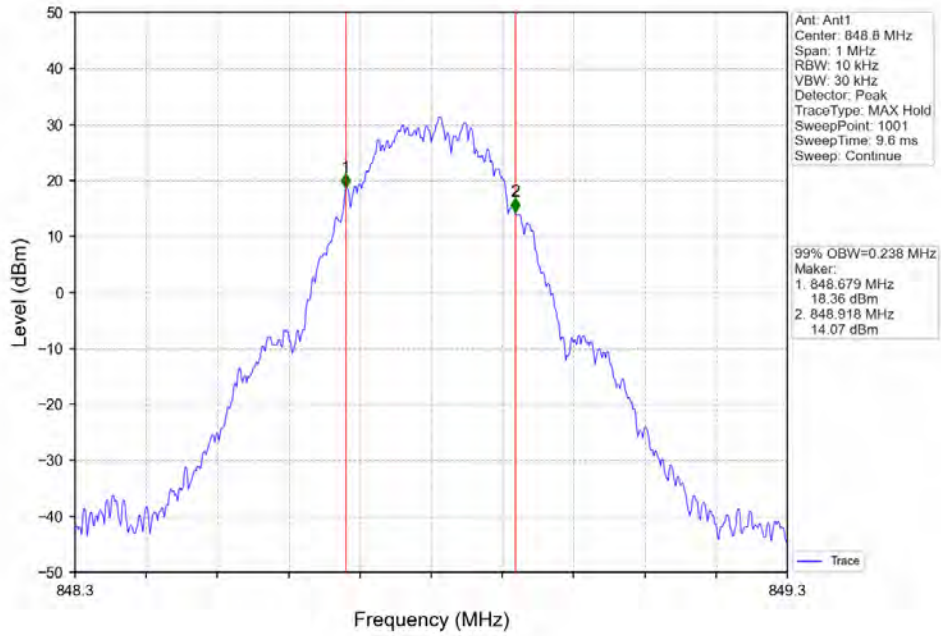

GSM850 EGPRS LCH_824.2MHz_NTNV

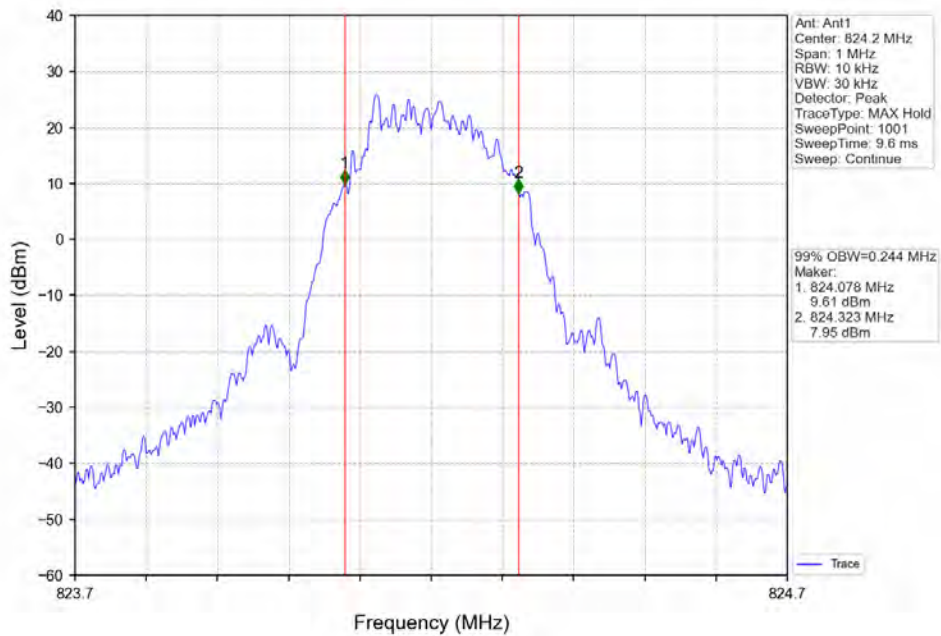



BUREAU
VERITAS

Test Report No.: W7L-P21100026RF13

GSM850_EGPRS_MCH_836.6MHz_NTNV

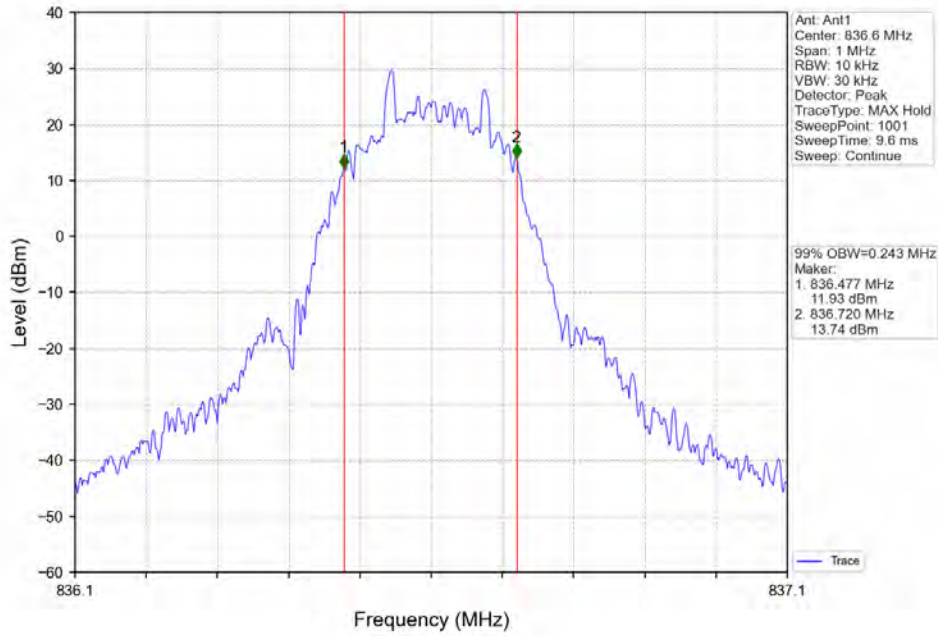

GSM850_EGPRS_HCH_848.8MHz_NTNV

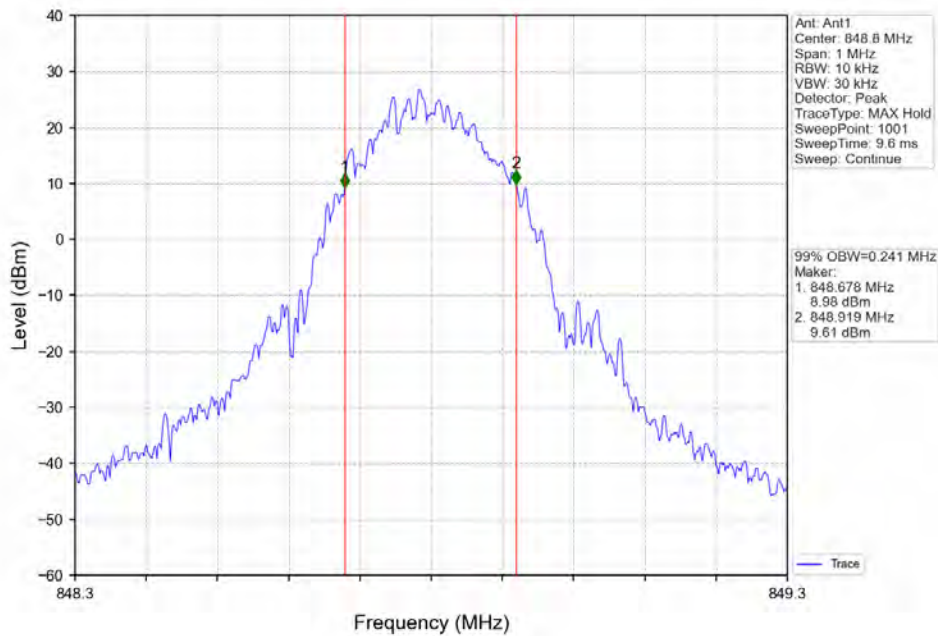



BUREAU
VERITAS

Test Report No.: W7L-P21100026RF13

GSM850_XDB

TEST RESULT

Band: GSM850					
ENV	Mode		Frequency (MHz)	26dB Bandwidth (MHz)	Verdict
	Network	Subset		Result	
NTNV	GSM	1 TX Slot	824.2	0.318	Pass
			836.6	0.313	Pass
			848.8	0.308	Pass
	EGPRS	1 TX Slot	824.2	0.304	Pass
			836.6	0.279	Pass
			848.8	0.306	Pass



BUREAU
VERITAS

Test Report No.: W7L-P21100026RF13

TEST GRAPH

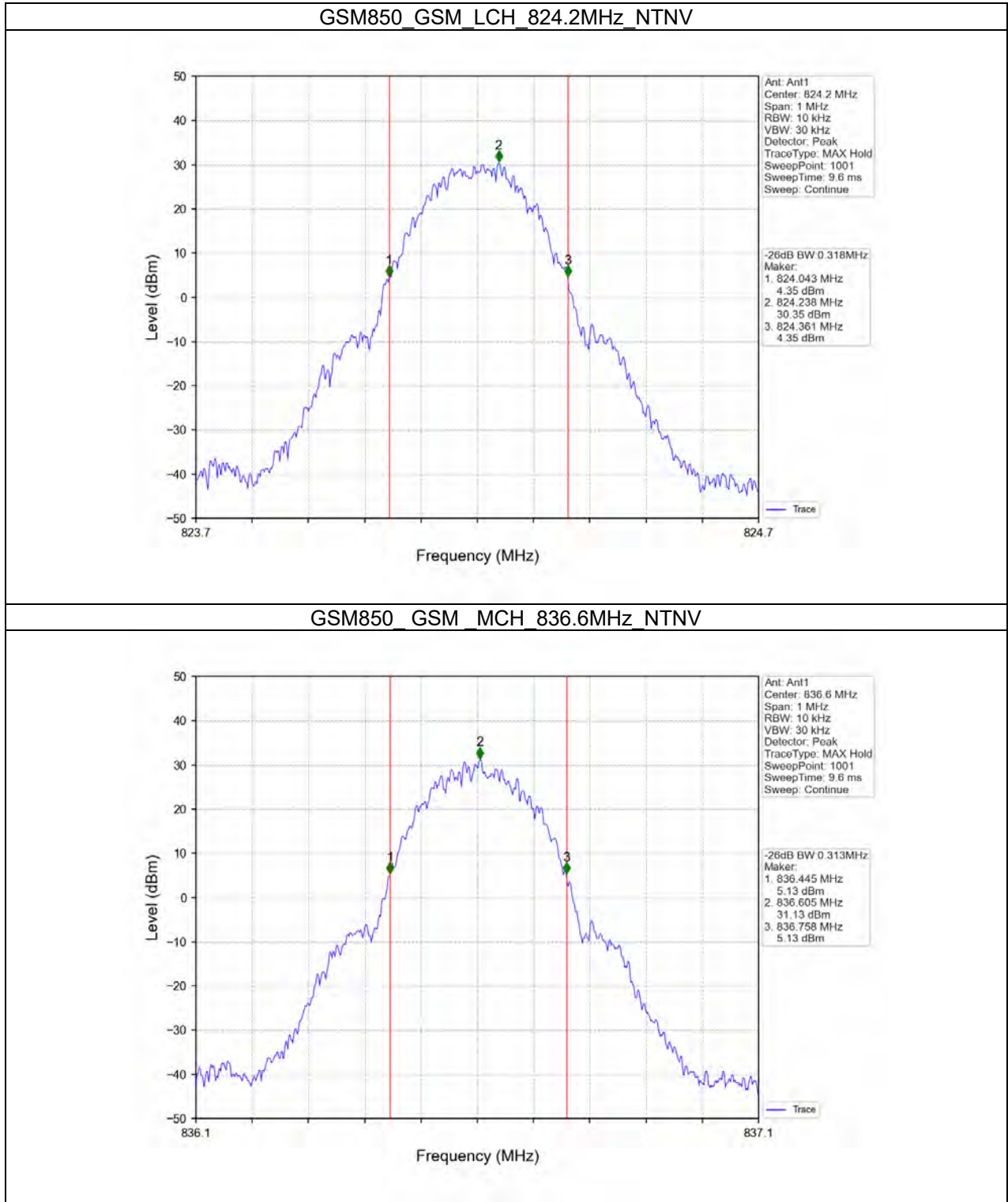



BUREAU
VERITAS

Test Report No.: W7L-P21100026RF13

GSM850_GSM_HCH_848.8MHz_NTNV

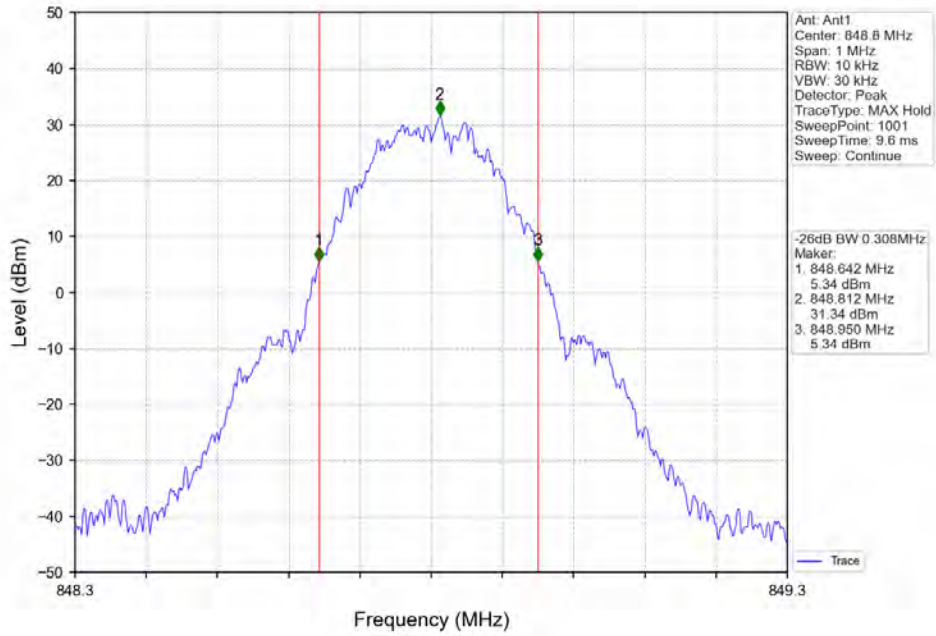

GSM850_EGPRS_LCH_824.2MHz_NTNV

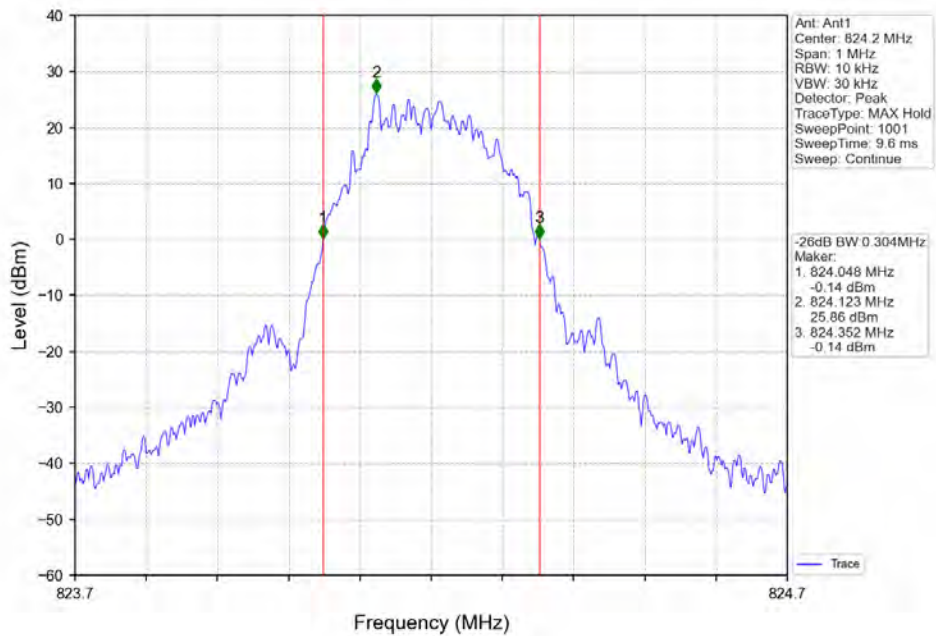



BUREAU
VERITAS

Test Report No.: W7L-P21100026RF13

GSM850_EGPRS_MCH_836.6MHz_NTNV

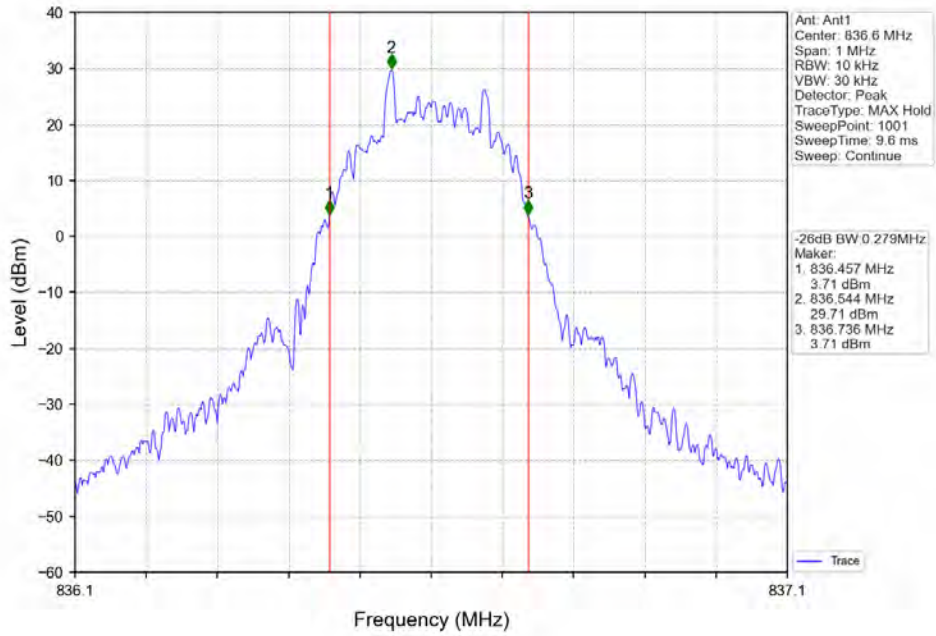

GSM850_EGPRS_HCH_848.8MHz_NTNV

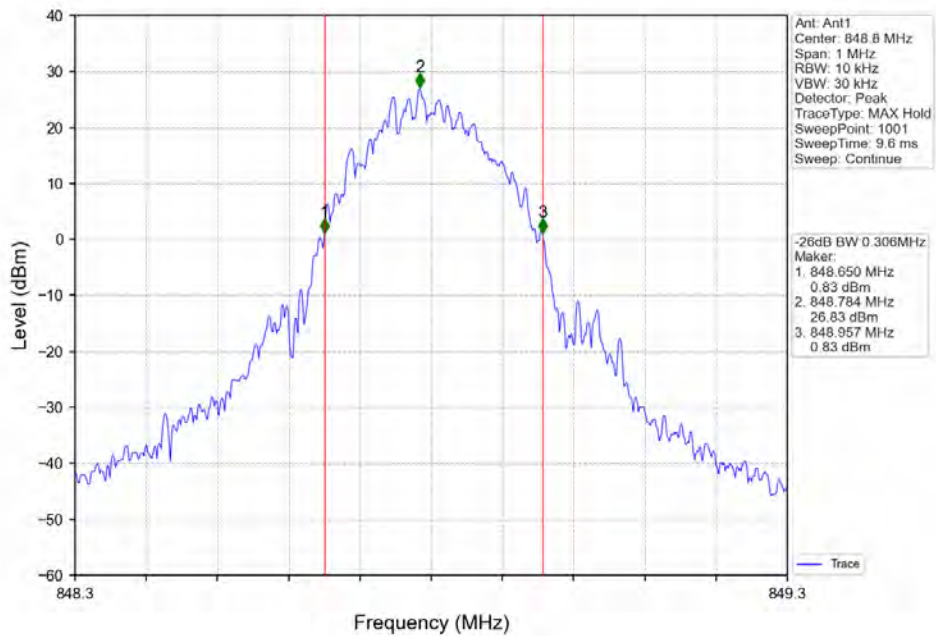



BUREAU
VERITAS

Test Report No.: W7L-P21100026RF13

PEAK-AVERAGE RATIO

GSM850

TEST RESULT

Band: GSM850						
ENV	Mode		Frequency (MHz)	Peak-Average Ratio (dB)		Verdict
	Network	Subset		Result	Limit	
NTNV	GSM	/	824.2	9.33	<=13	Pass
			836.6	9.08	<=13	Pass
			848.8	3.57	<=13	Pass
	EGPRS	/	824.2	9.62	<=13	Pass
			836.6	9.95	<=13	Pass
			848.8	9.65	<=13	Pass



BUREAU
VERITAS

Test Report No.: W7L-P21100026RF13

TEST GRAPH

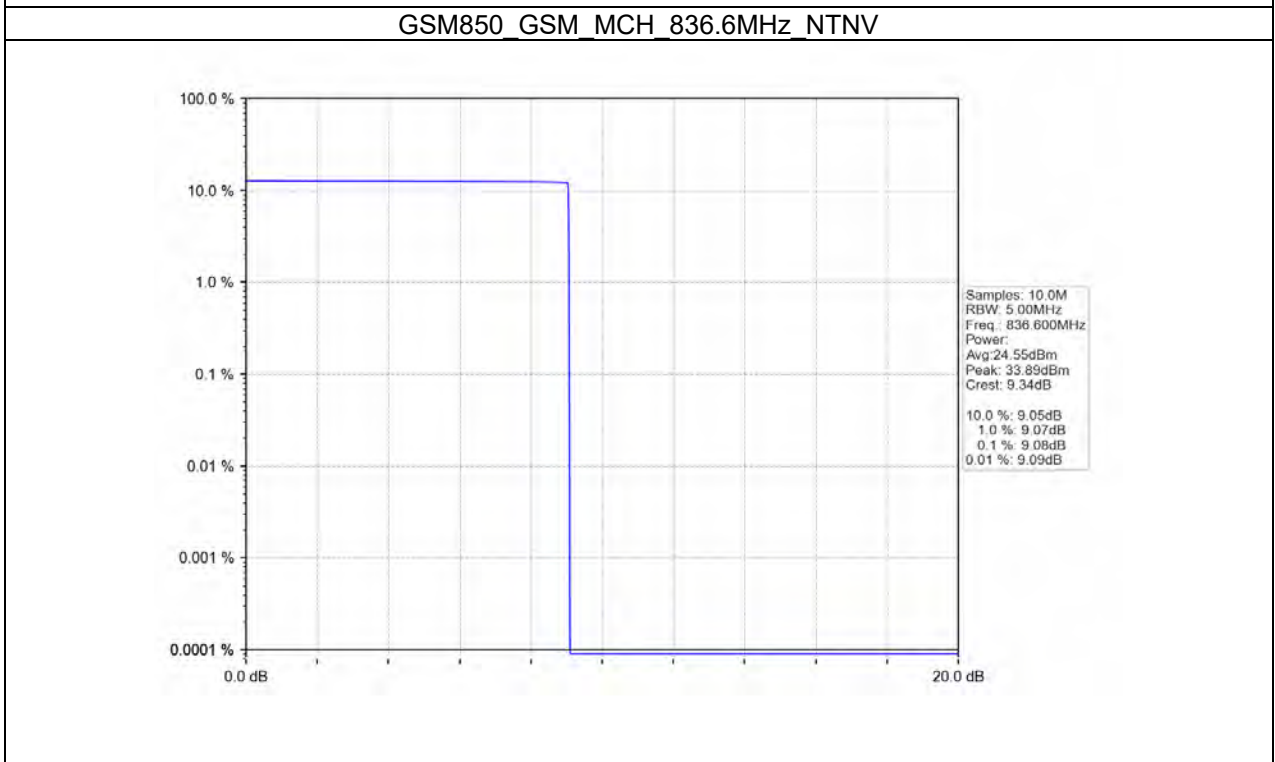
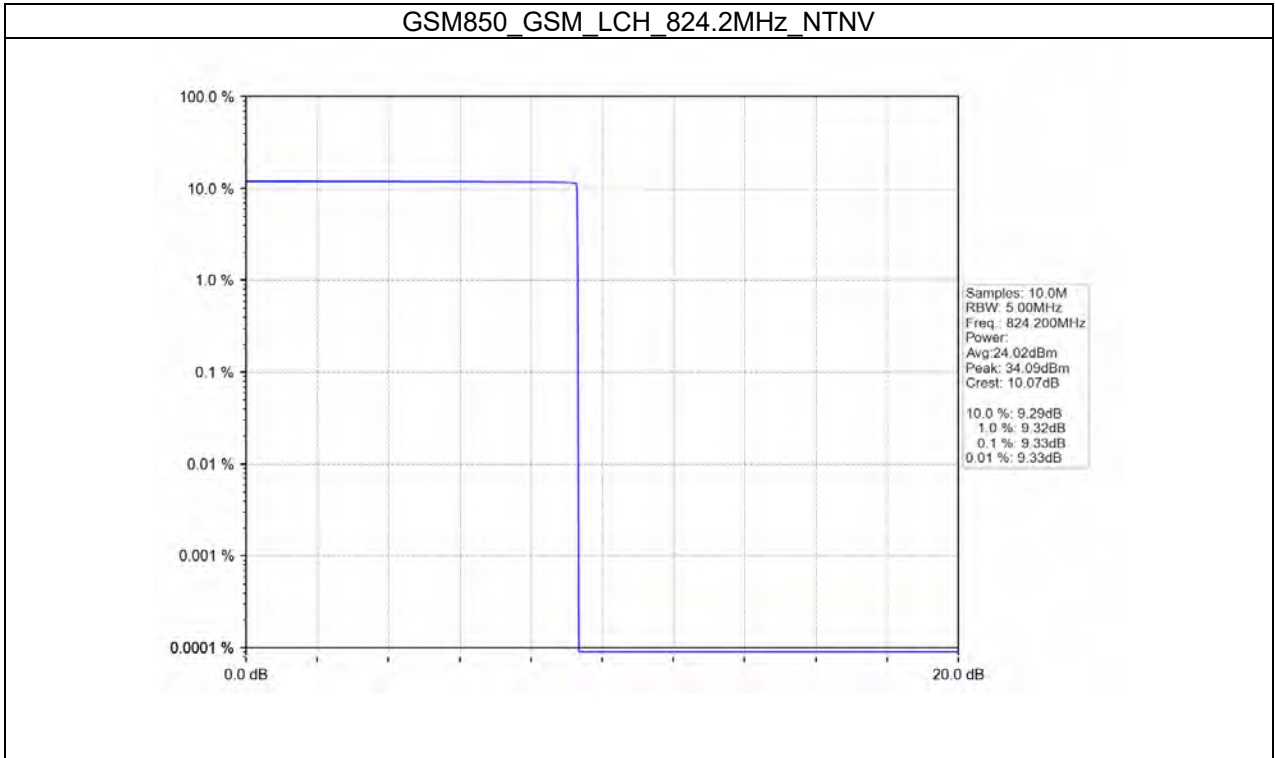



BUREAU
VERITAS

Test Report No.: W7L-P21100026RF13

GSM850_GSM_HCH_848.8MHz_NTNV

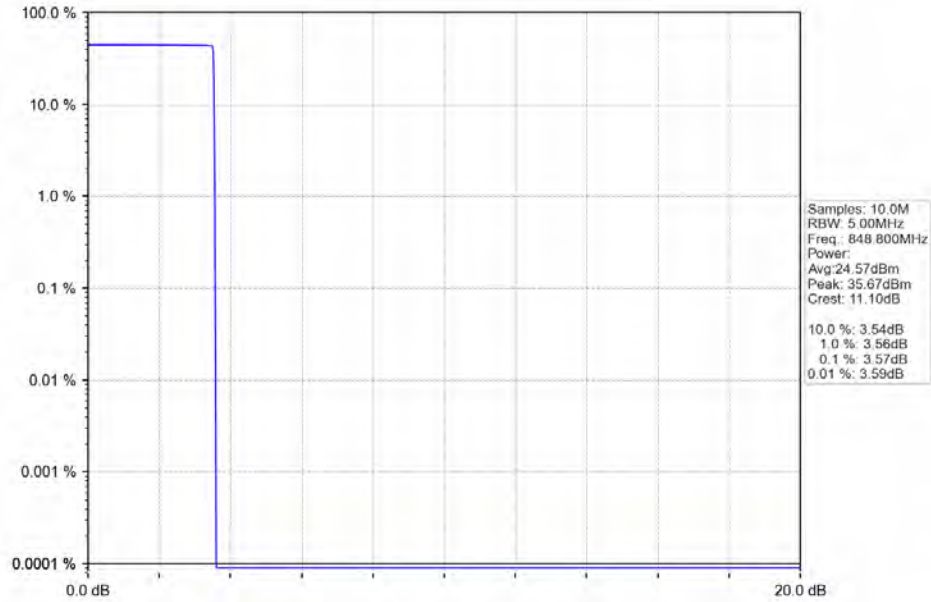

GSM850_EGPRS_LCH_824.2MHz_NTNV

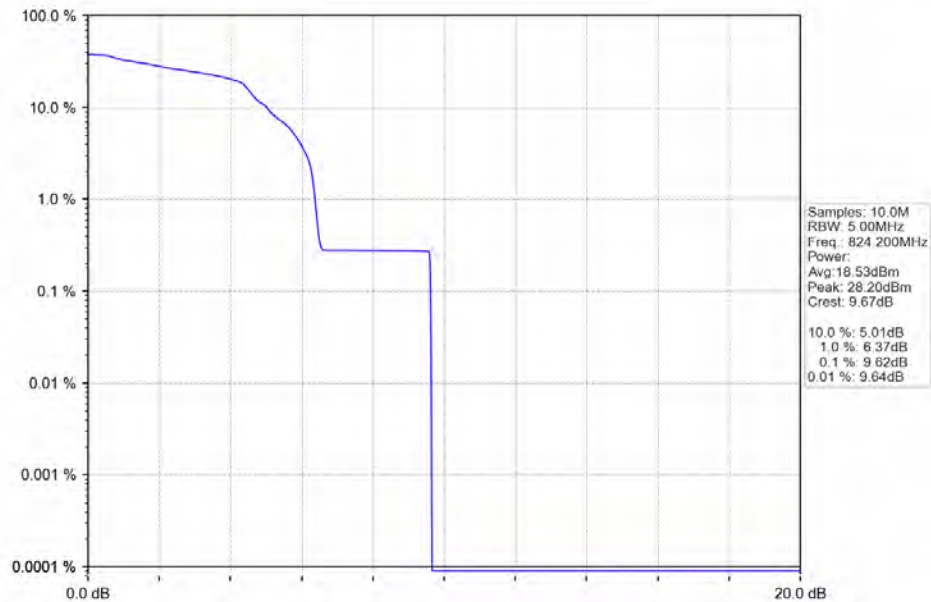



BUREAU
VERITAS

Test Report No.: W7L-P21100026RF13

GSM850_EGPRS_MCH_836.6MHz_NTNV

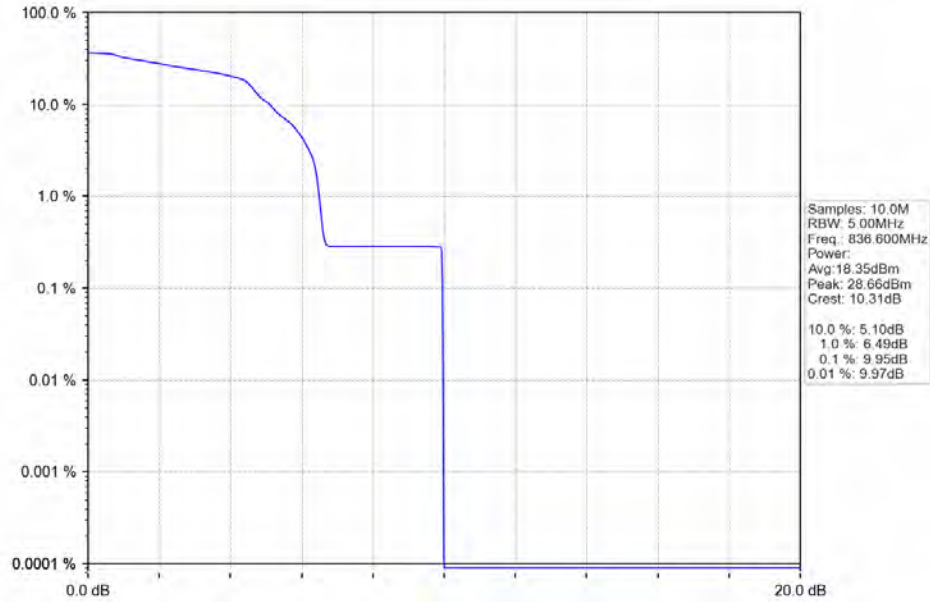

GSM850_EGPRS_HCH_848.8MHz_NTNV

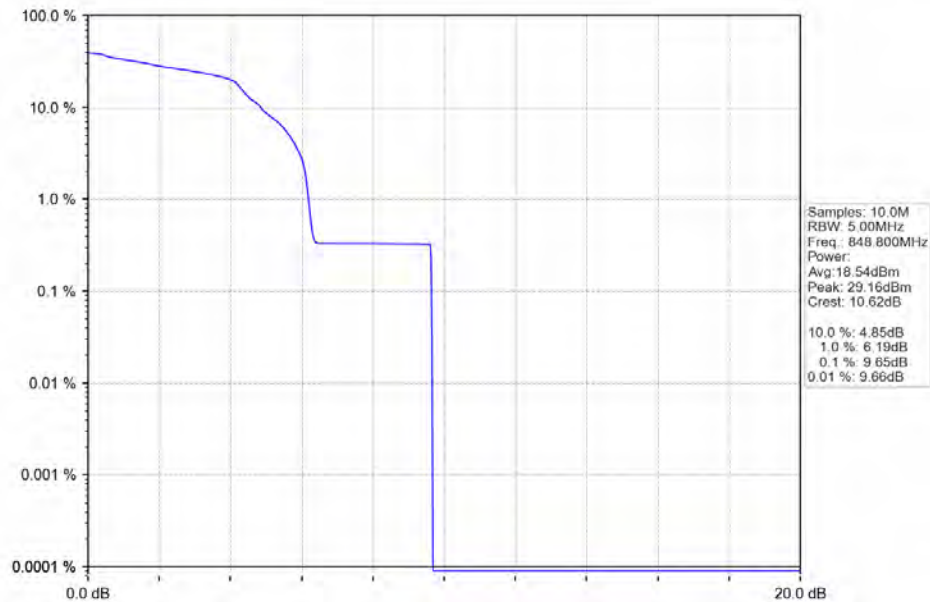



BUREAU
VERITAS

Test Report No.: W7L-P21100026RF13

SPURIOUS EMISSION

GSM850

TEST RESULT

Band: GSM850						
ENV	Mode		Frequency (MHz)	Spurious Emission		Verdict
	Network	Subset		Result	Limit	
NTNV	GSM	/	824.2	Refer To Test Graph		Pass
			836.6	Refer To Test Graph		Pass
			848.8	Refer To Test Graph		Pass
	EGPRS	/	824.2	Refer To Test Graph		Pass
			836.6	Refer To Test Graph		Pass
			848.8	Refer To Test Graph		Pass



BUREAU
VERITAS

Test Report No.: W7L-P21100026RF13

TEST GRAPH

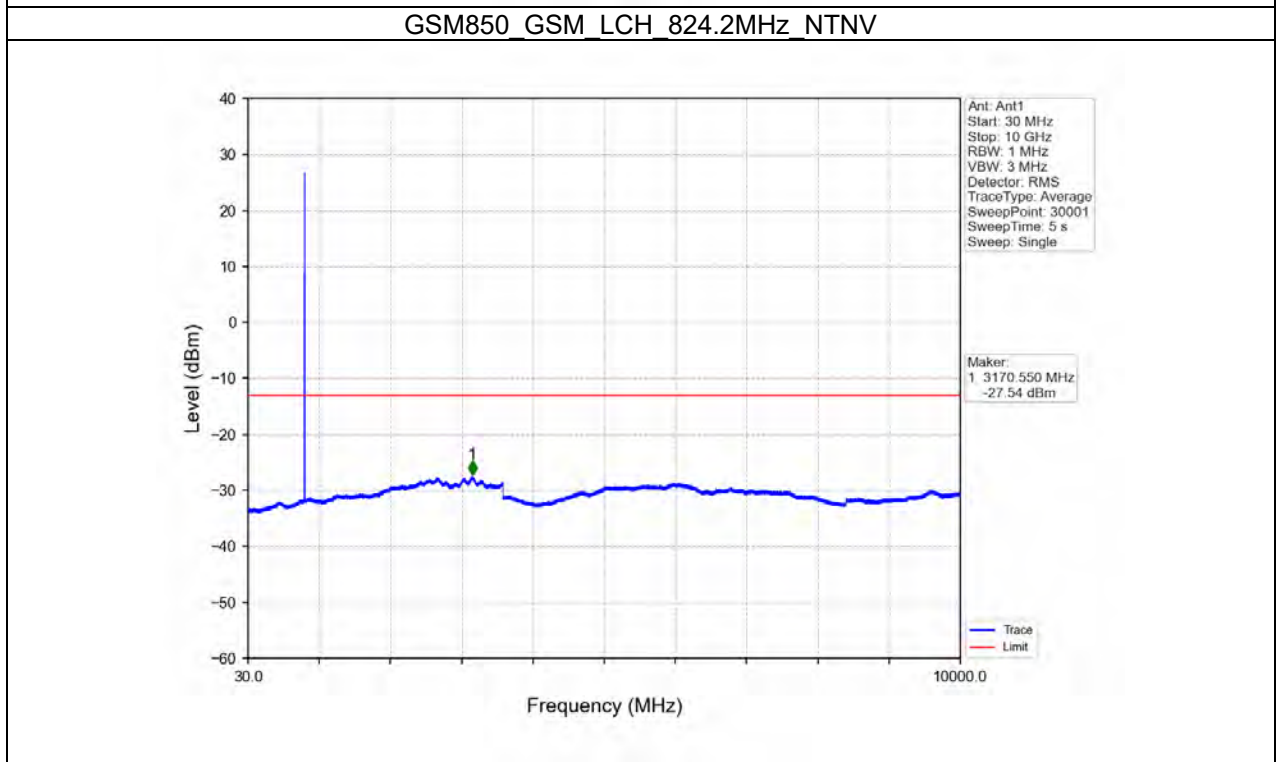
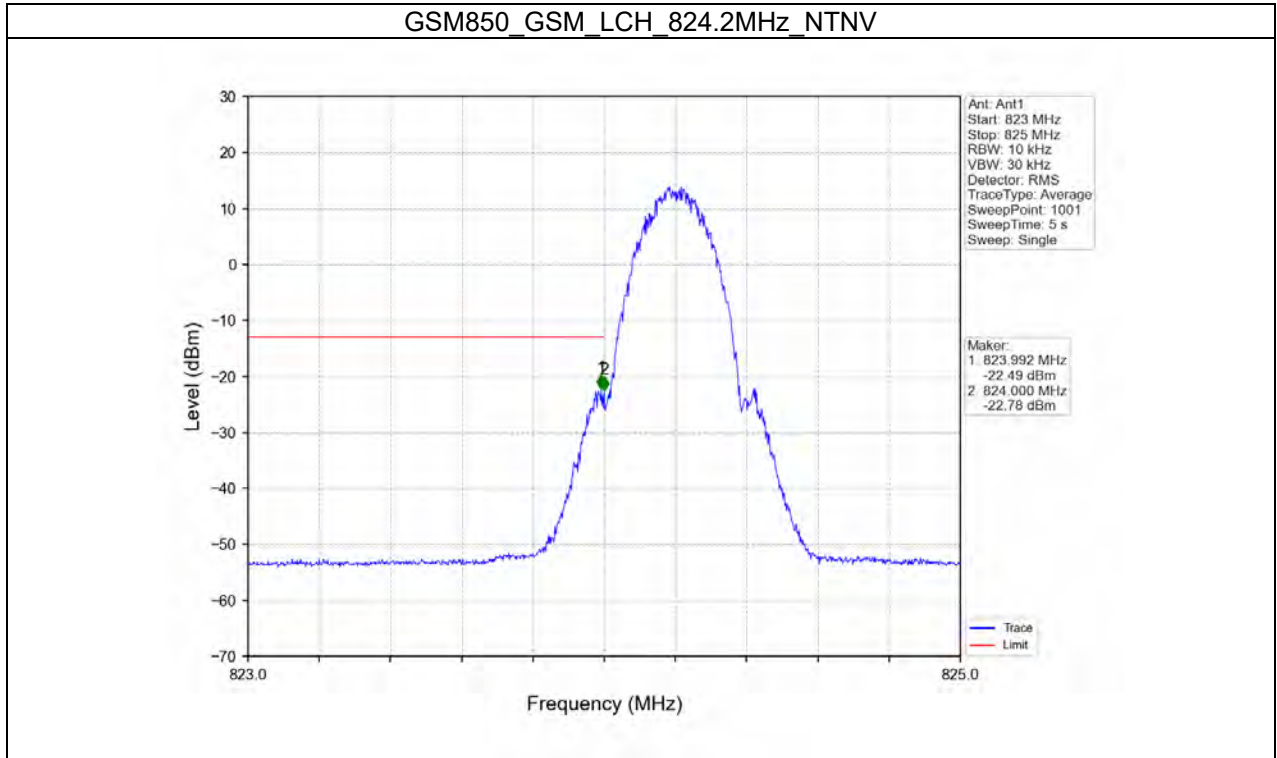



BUREAU
VERITAS

Test Report No.: W7L-P21100026RF13

GSM850_GSM_MCH_836.6MHz_NTNV

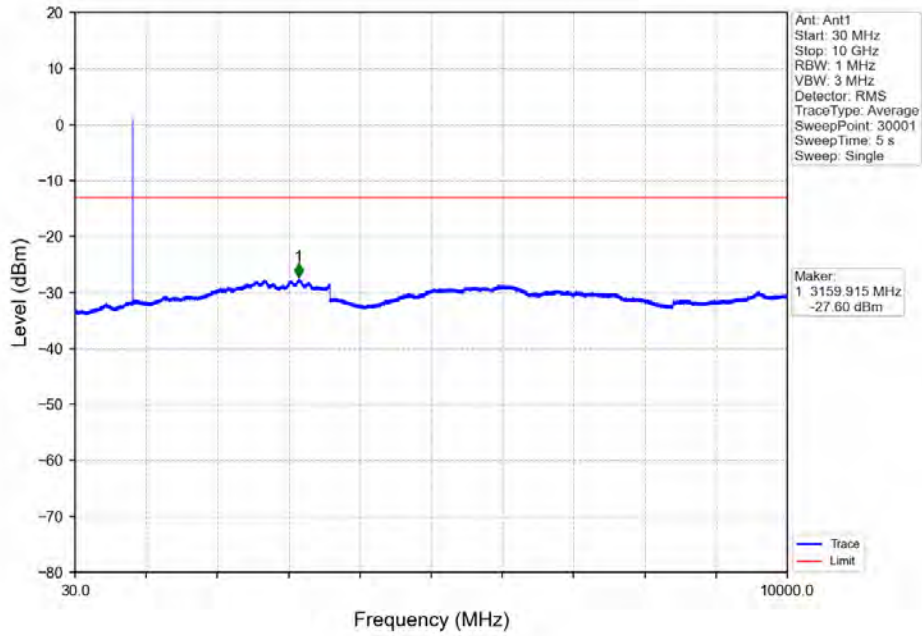

GSM850_GSM_HCH_848.8MHz_NTNV

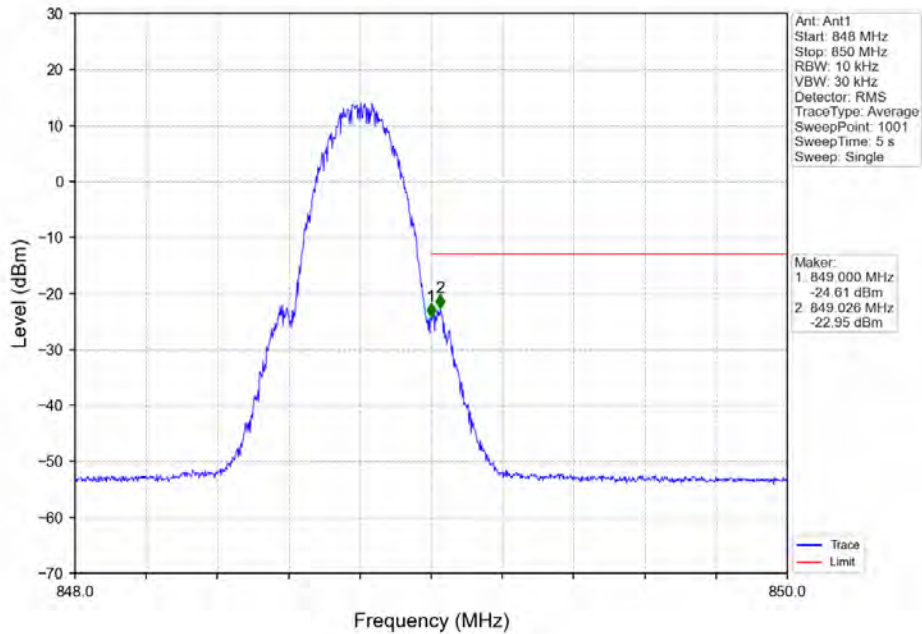



BUREAU
VERITAS

Test Report No.: W7L-P21100026RF13

GSM850_GSM_HCH_848.8MHz_NTNV

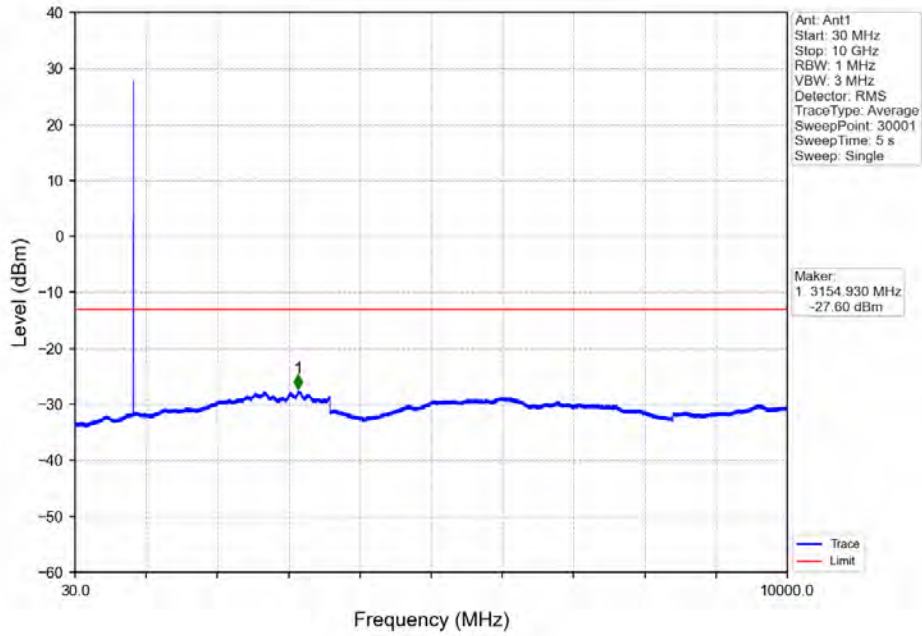

GSM850 EGPRS LCH 824.2MHz_NTNV

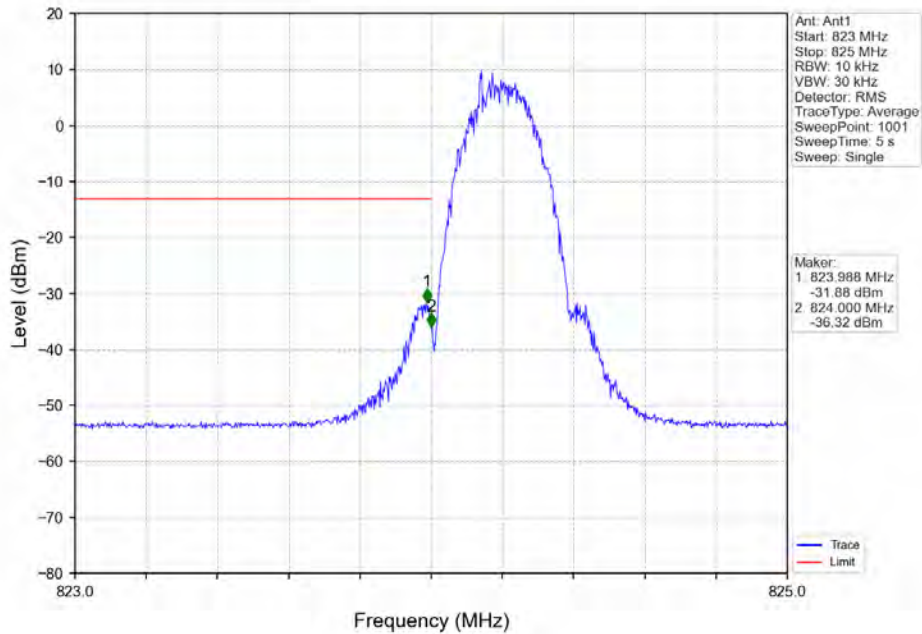



BUREAU
VERITAS

Test Report No.: W7L-P21100026RF13

GSM850_EGPRS_LCH_824.2MHz_NTNV

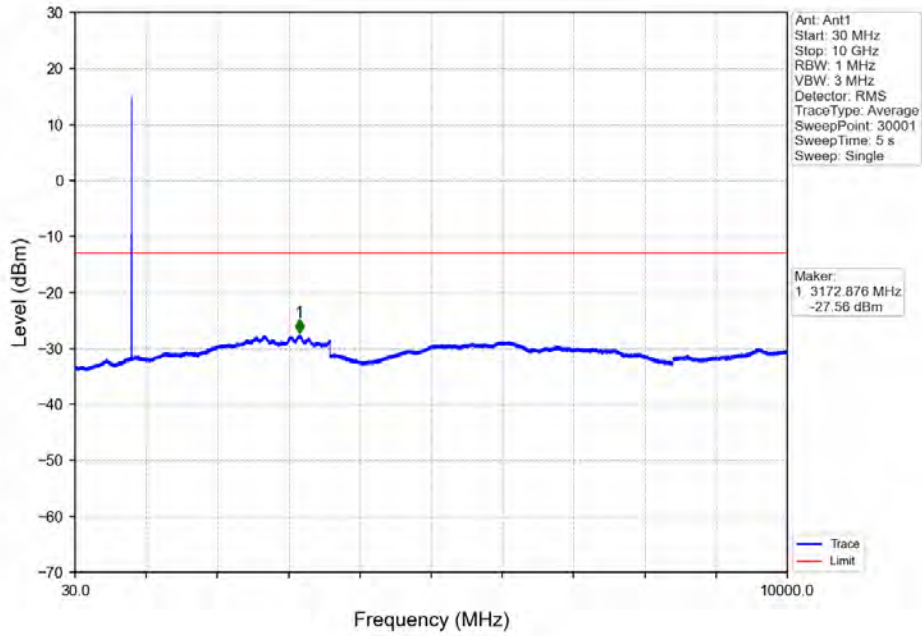

GSM850 EGPRS MCH 836.6MHz_NTNV

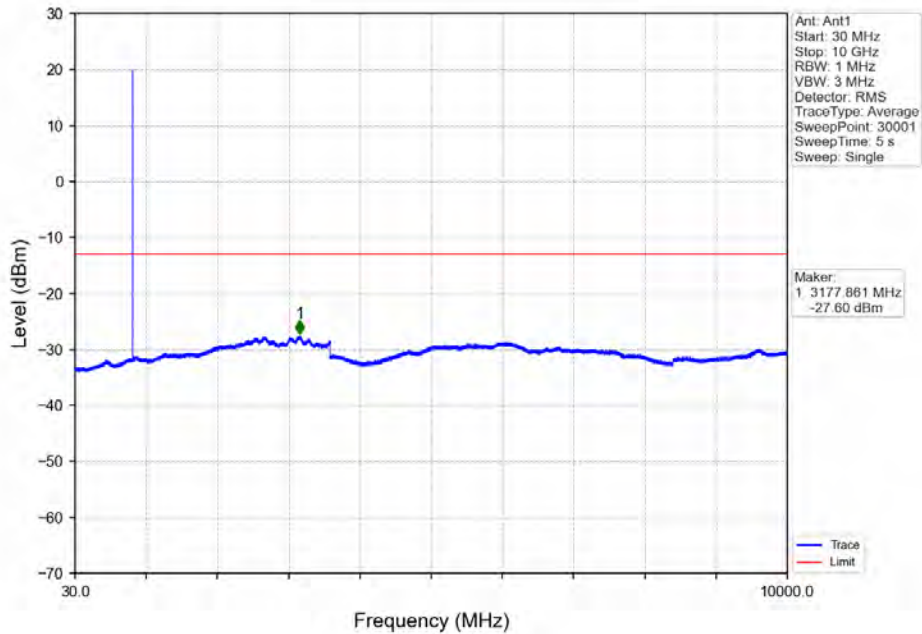



BUREAU
VERITAS

Test Report No.: W7L-P21100026RF13

GSM850_EGPRS_HCH_848.8MHz_NTNV

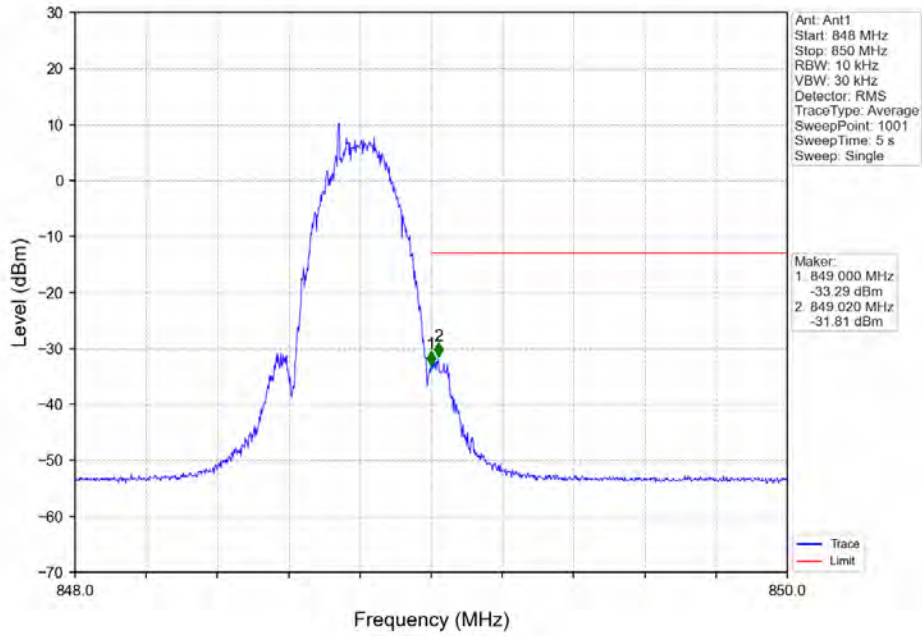

GSM850_EGPRS_HCH_848.8MHz_NTNV

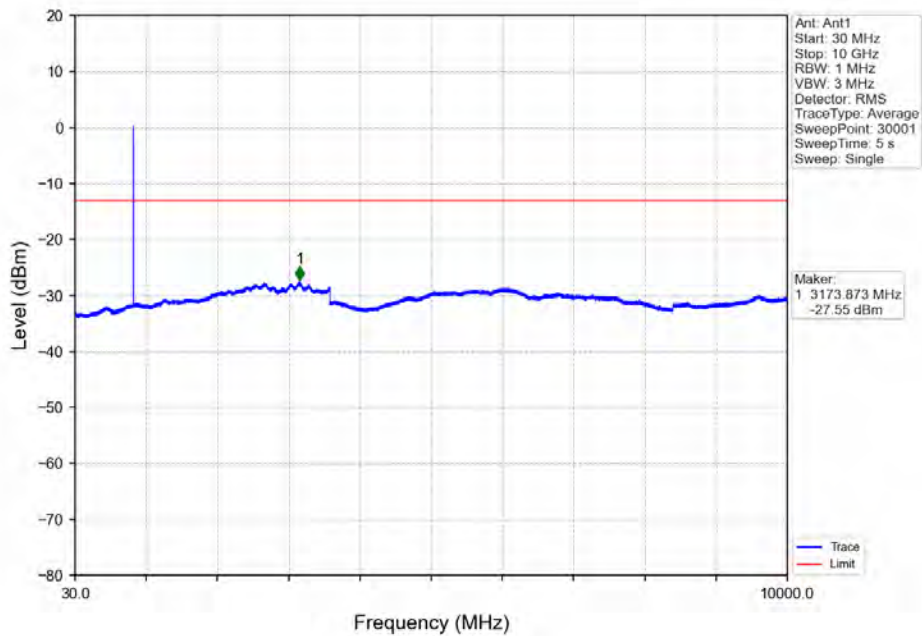



**BUREAU
VERITAS**

Test Report No.: W7L-P21100026RF13

WCDMA BAND5

FREQUENCY STABILITY

BAND5

TEST RESULT

Band: 5							
Network	Frequency (MHz)	Temp. (°C)	Voltage (VDC)	Freq. Error (Hz)	Freq. vs. Rated (ppm)		Verdict
					Result	Limit	
RMC	826.4	20	3.27	-2.99	-0.00	-2.5 to 2.5	Pass
			3.85	-1.14	-0.00	-2.5 to 2.5	Pass
			4.43	-2.79	-0.00	-2.5 to 2.5	Pass
		-30	3.85	-0.88	-0.00	-2.5 to 2.5	Pass
		-20	3.85	-5.82	-0.01	-2.5 to 2.5	Pass
		-10	3.85	-4.61	-0.01	-2.5 to 2.5	Pass
		0	3.85	-5.64	-0.01	-2.5 to 2.5	Pass
		10	3.85	-5.07	-0.01	-2.5 to 2.5	Pass
		30	3.85	-4.69	-0.01	-2.5 to 2.5	Pass
		40	3.85	-5.25	-0.01	-2.5 to 2.5	Pass
	50	3.85	-4.15	-0.01	-2.5 to 2.5	Pass	
	836.6	20	3.27	-4.61	-0.01	-2.5 to 2.5	Pass
			3.85	-6.13	-0.01	-2.5 to 2.5	Pass
			4.43	-2.09	-0.00	-2.5 to 2.5	Pass
		-30	3.85	-2.37	-0.00	-2.5 to 2.5	Pass
		-20	3.85	-3.41	-0.00	-2.5 to 2.5	Pass
		-10	3.85	-2.54	-0.00	-2.5 to 2.5	Pass
		0	3.85	-4.74	-0.01	-2.5 to 2.5	Pass
		10	3.85	-4.69	-0.01	-2.5 to 2.5	Pass
		30	3.85	-6.70	-0.01	-2.5 to 2.5	Pass
		40	3.85	-2.89	-0.00	-2.5 to 2.5	Pass
	50	3.85	-5.14	-0.01	-2.5 to 2.5	Pass	
	846.6	20	3.27	-2.48	-0.00	-2.5 to 2.5	Pass
			3.85	-3.51	-0.00	-2.5 to 2.5	Pass
			4.43	-2.67	-0.00	-2.5 to 2.5	Pass
		-30	3.85	-5.36	-0.01	-2.5 to 2.5	Pass
		-20	3.85	-3.48	-0.00	-2.5 to 2.5	Pass
		-10	3.85	-5.76	-0.01	-2.5 to 2.5	Pass
		0	3.85	-5.29	-0.01	-2.5 to 2.5	Pass
		10	3.85	-6.81	-0.01	-2.5 to 2.5	Pass
30		3.85	-1.87	-0.00	-2.5 to 2.5	Pass	
40		3.85	-2.90	-0.00	-2.5 to 2.5	Pass	
50	3.85	-3.15	-0.00	-2.5 to 2.5	Pass		



BUREAU
VERITAS

Test Report No.: W7L-P21100026RF13

99% & 26DB BANDWIDTH

WCDMA_OBW

TEST RESULT

Band: 5					
ENV	Mode		Frequency (MHz)	99% Occupied Bandwidth (MHz)	Verdict
	Network	Subset		Result	
NTNV	RMC	12.2kbps RMC	826.4	4.169	Pass
			836.6	4.188	Pass
			846.6	4.176	Pass



BUREAU
VERITAS

Test Report No.: W7L-P21100026RF13

TEST GRAPH

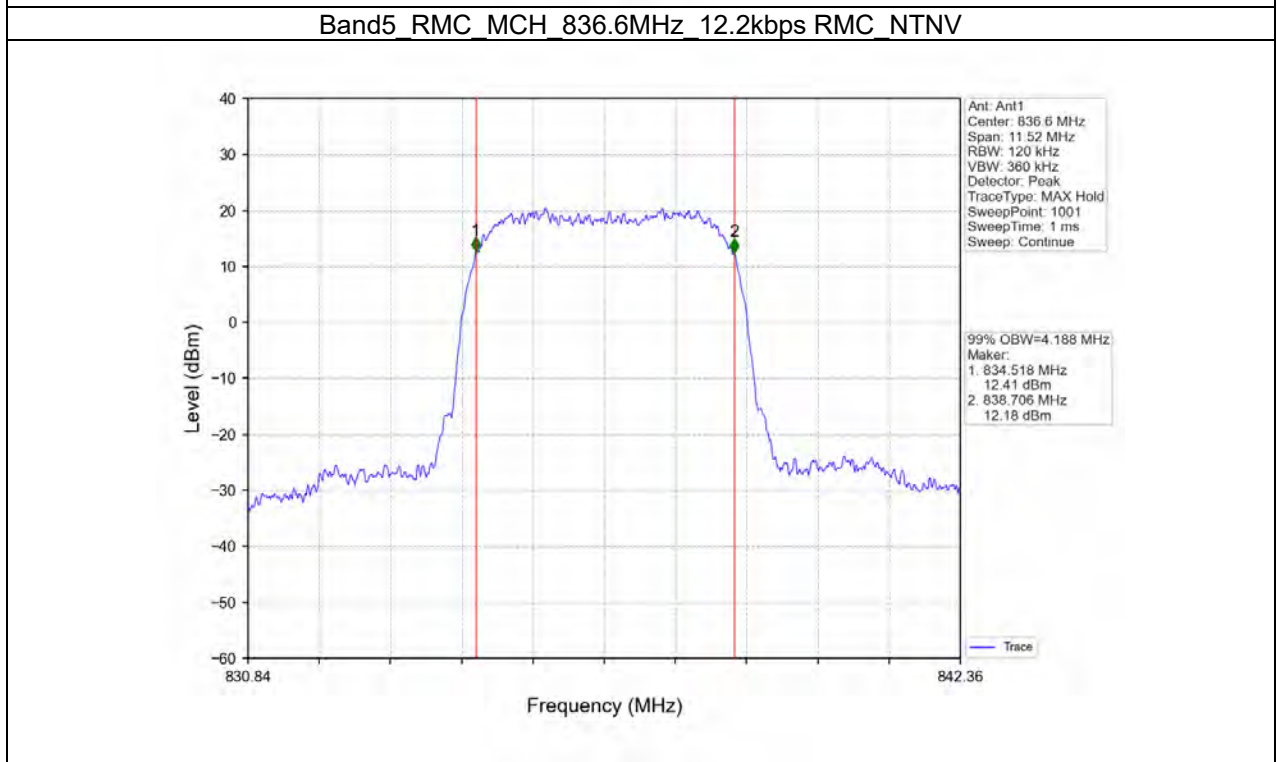
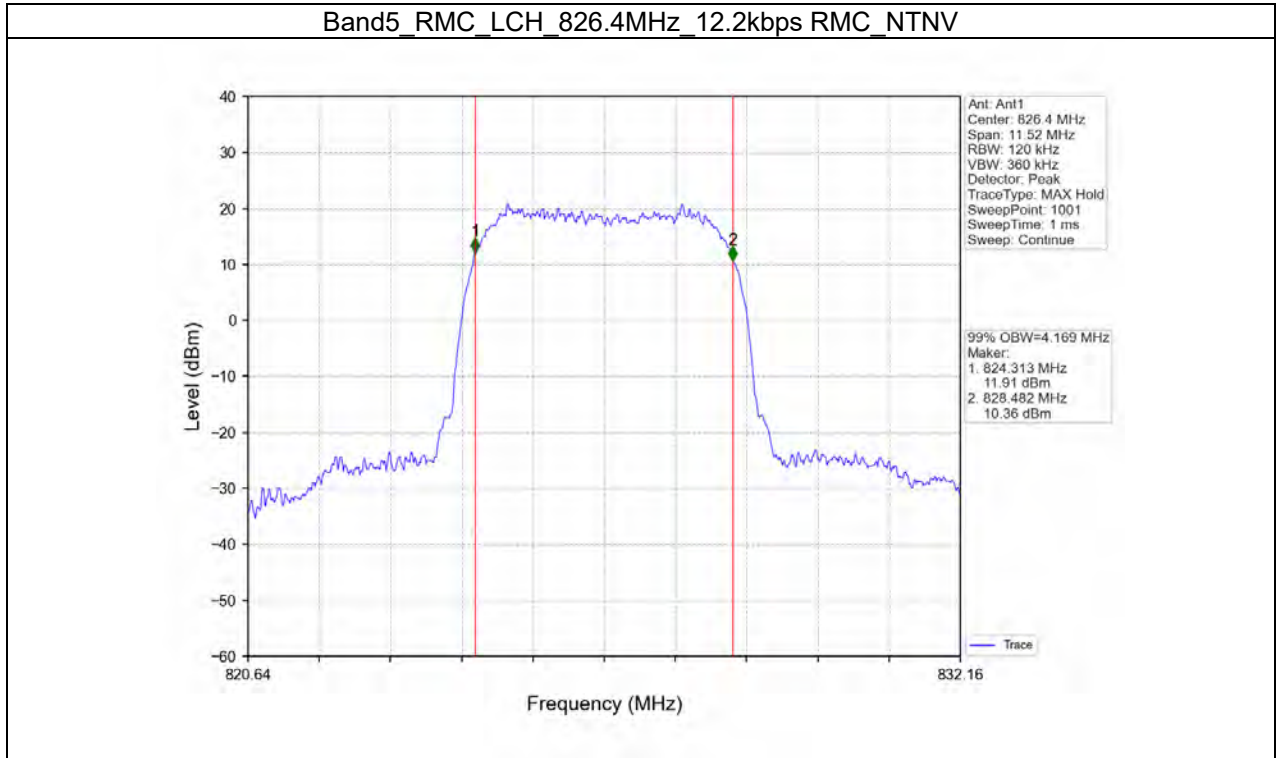



BUREAU
VERITAS

Test Report No.: W7L-P21100026RF13

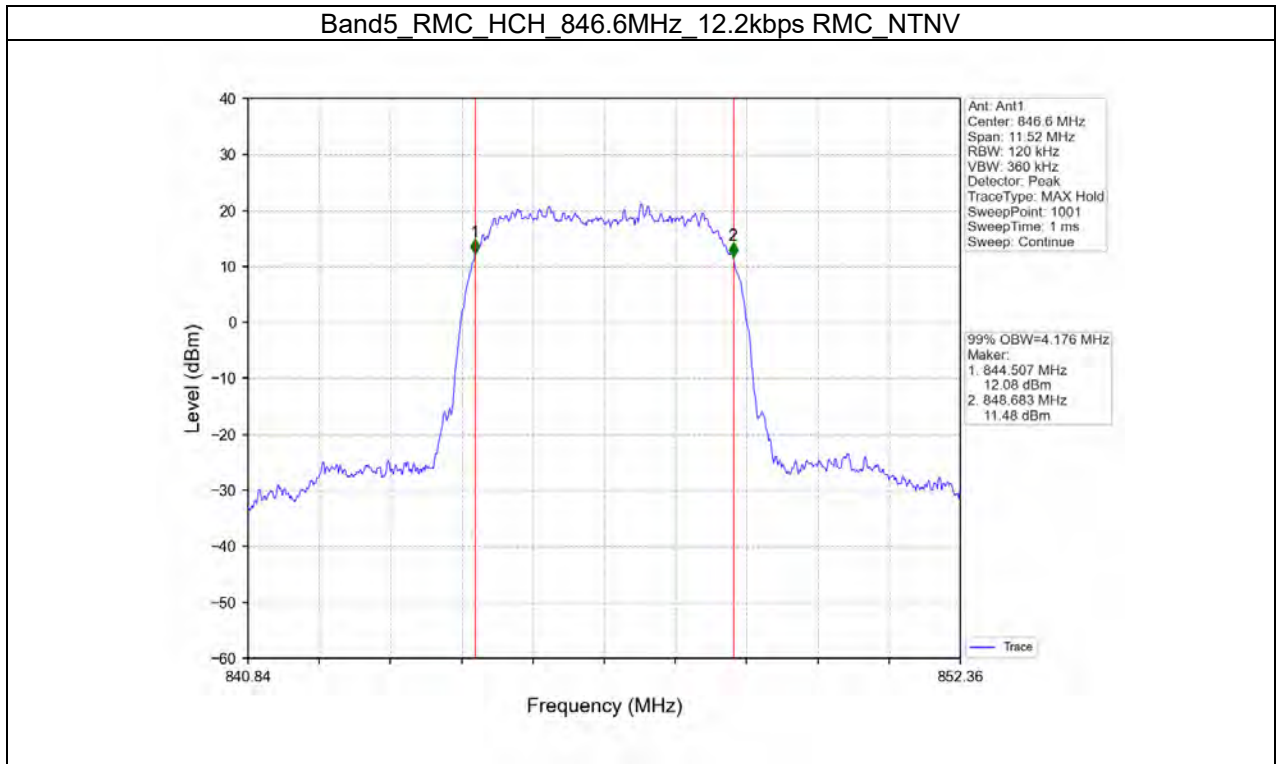



BUREAU
VERITAS

Test Report No.: W7L-P21100026RF13

BAND5_XDB

TEST RESULT

Band: 5					
ENV	Mode		Frequency (MHz)	26dB Bandwidth (MHz)	Verdict
	Network	Subset		Result	
NTNV	RMC	12.2kbps RMC	826.4	4.740	Pass
			836.6	4.738	Pass
			846.6	4.738	Pass



BUREAU
VERITAS

Test Report No.: W7L-P21100026RF13

TEST GRAPH

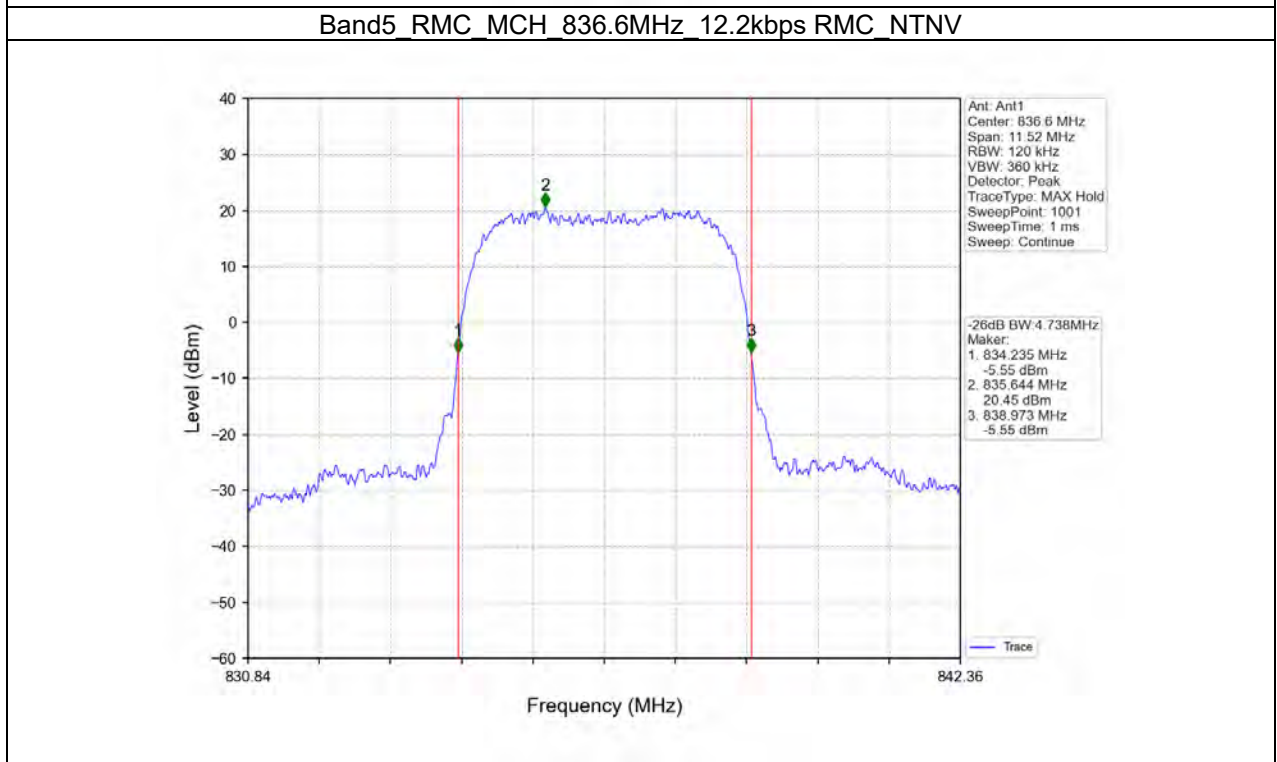
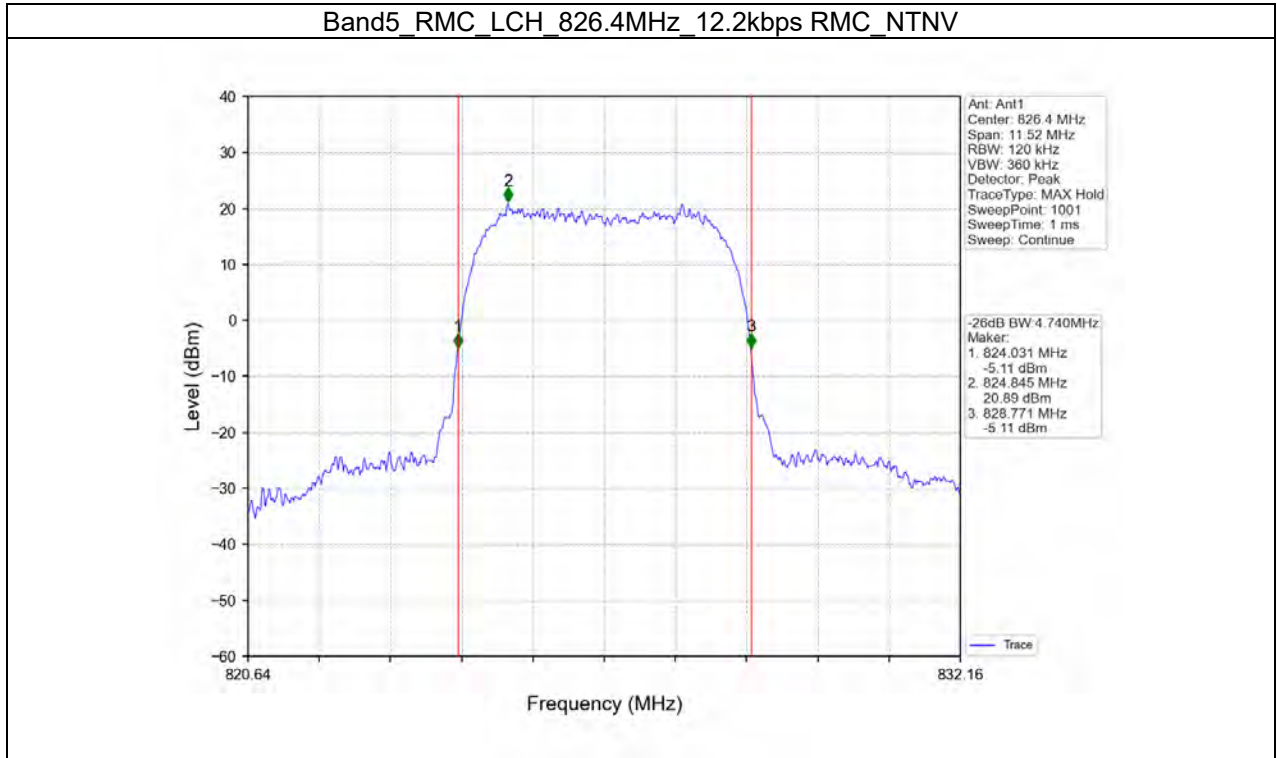



BUREAU
VERITAS

Test Report No.: W7L-P21100026RF13

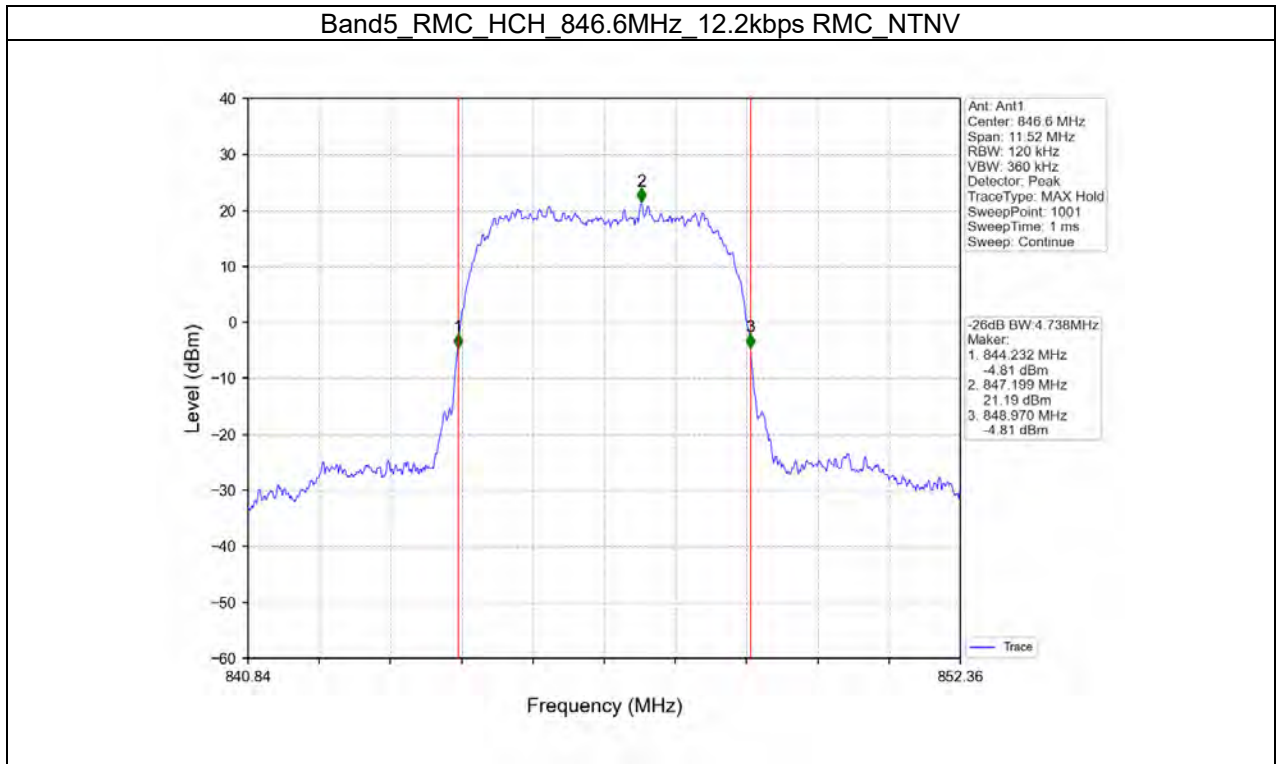



**BUREAU
VERITAS**

Test Report No.: W7L-P21100026RF13

PEAK-AVERAGE RATIO

BAND5

TEST RESULT

Band: 5						
ENV	Mode		Frequency (MHz)	Peak-Average Ratio (dB)		Verdict
	Network	Subset		Result	Limit	
NTNV	RMC	12.2kbps RMC	826.4	2.89	<=13	Pass
			836.6	2.93	<=13	Pass
			846.6	2.92	<=13	Pass



BUREAU
VERITAS

Test Report No.: W7L-P21100026RF13

TEST GRAPH

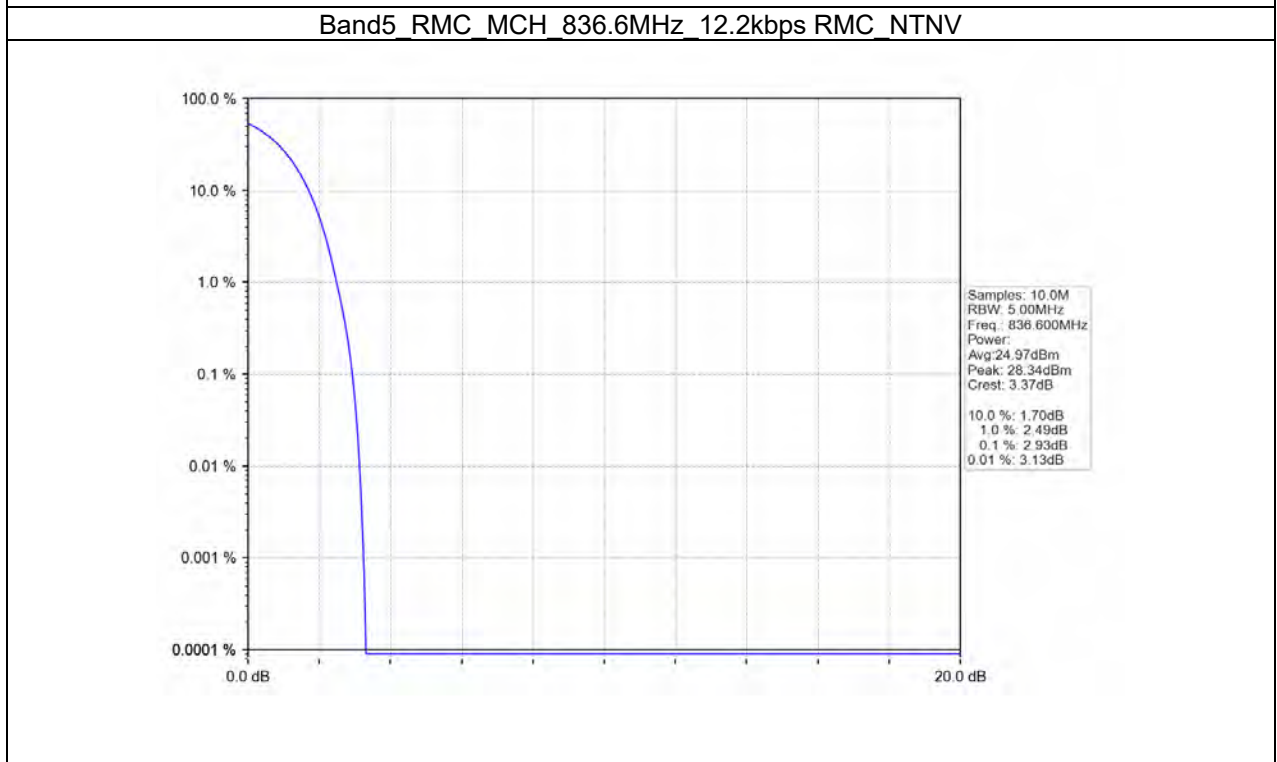
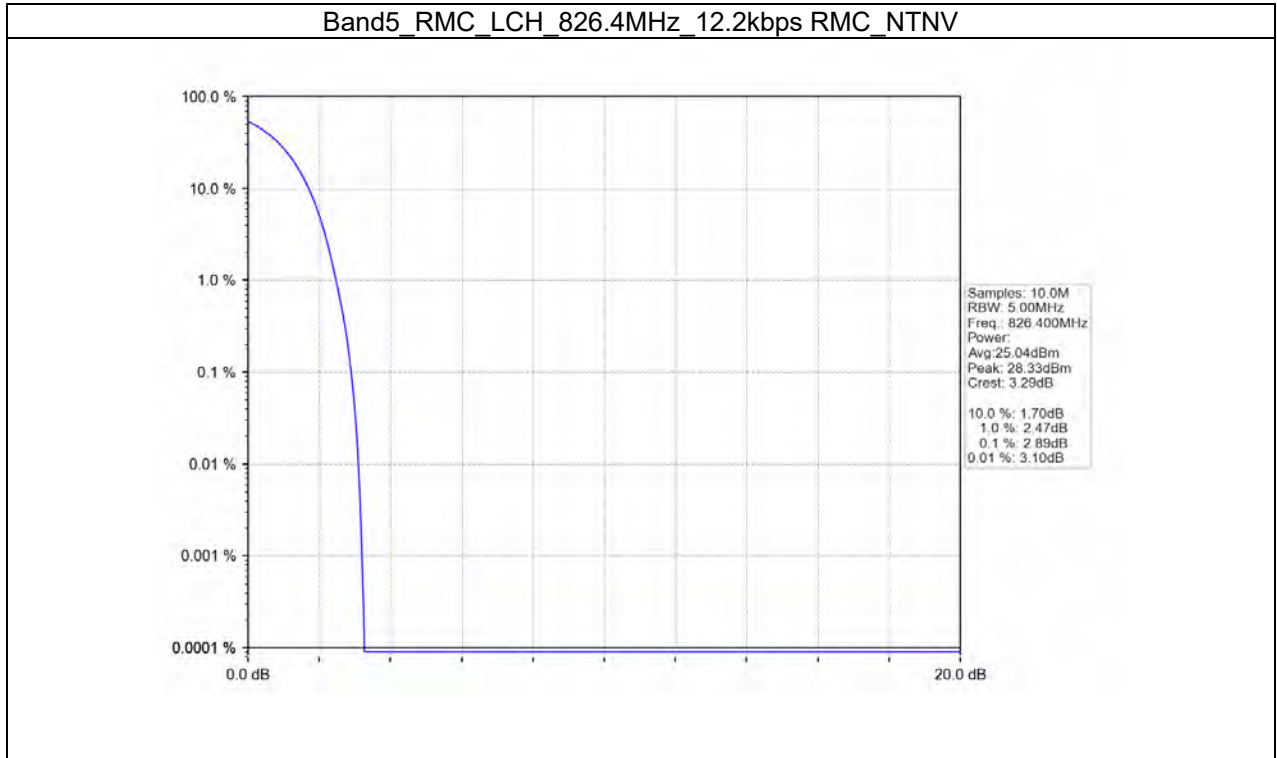



BUREAU
VERITAS

Test Report No.: W7L-P21100026RF13

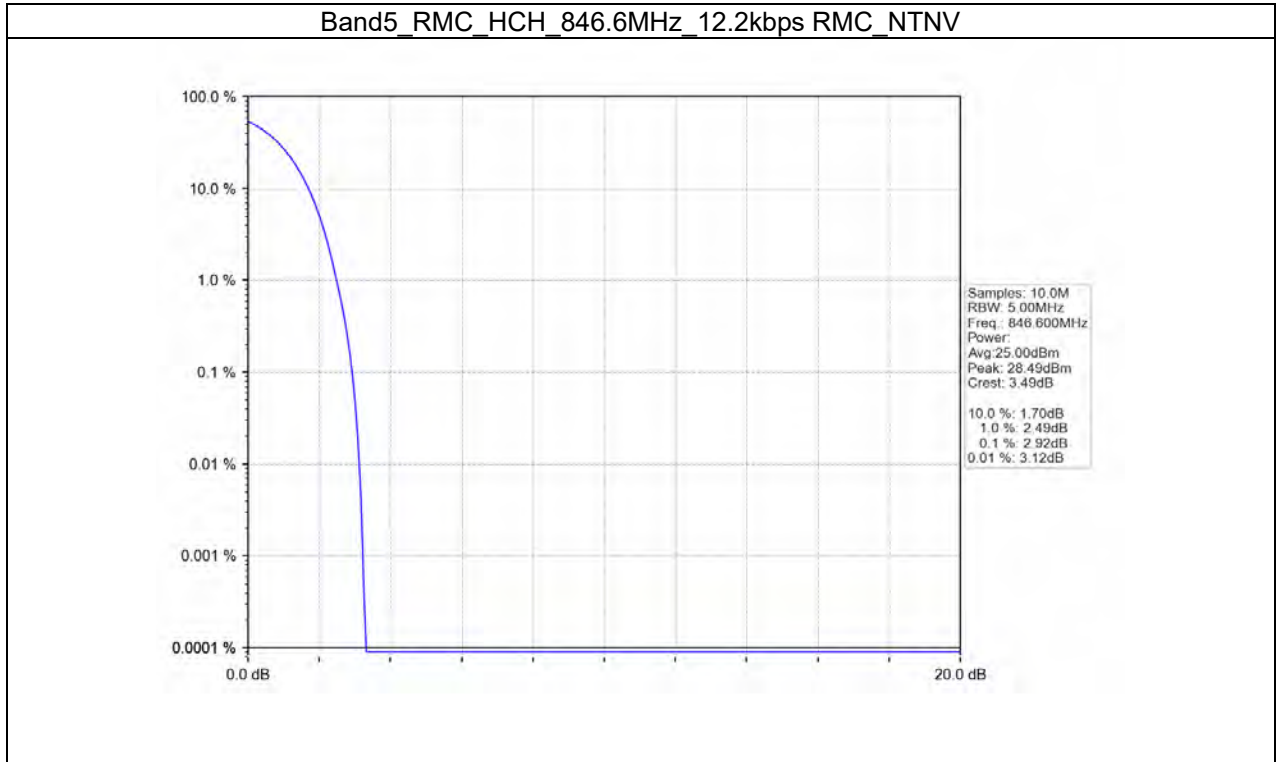



**BUREAU
VERITAS**

Test Report No.: W7L-P21100026RF13

SPURIOUS EMISSION

BAND5

TEST RESULT

Band: 5						
ENV	Mode		Frequency (MHz)	Spurious Emission		Verdict
	Network	Subset		Result	Limit	
NTNV	RMC	12.2kbps RMC	826.4	Refer To Test Graph		Pass
			836.6	Refer To Test Graph		Pass
			846.6	Refer To Test Graph		Pass



BUREAU
VERITAS

Test Report No.: W7L-P21100026RF13

TEST GRAPH

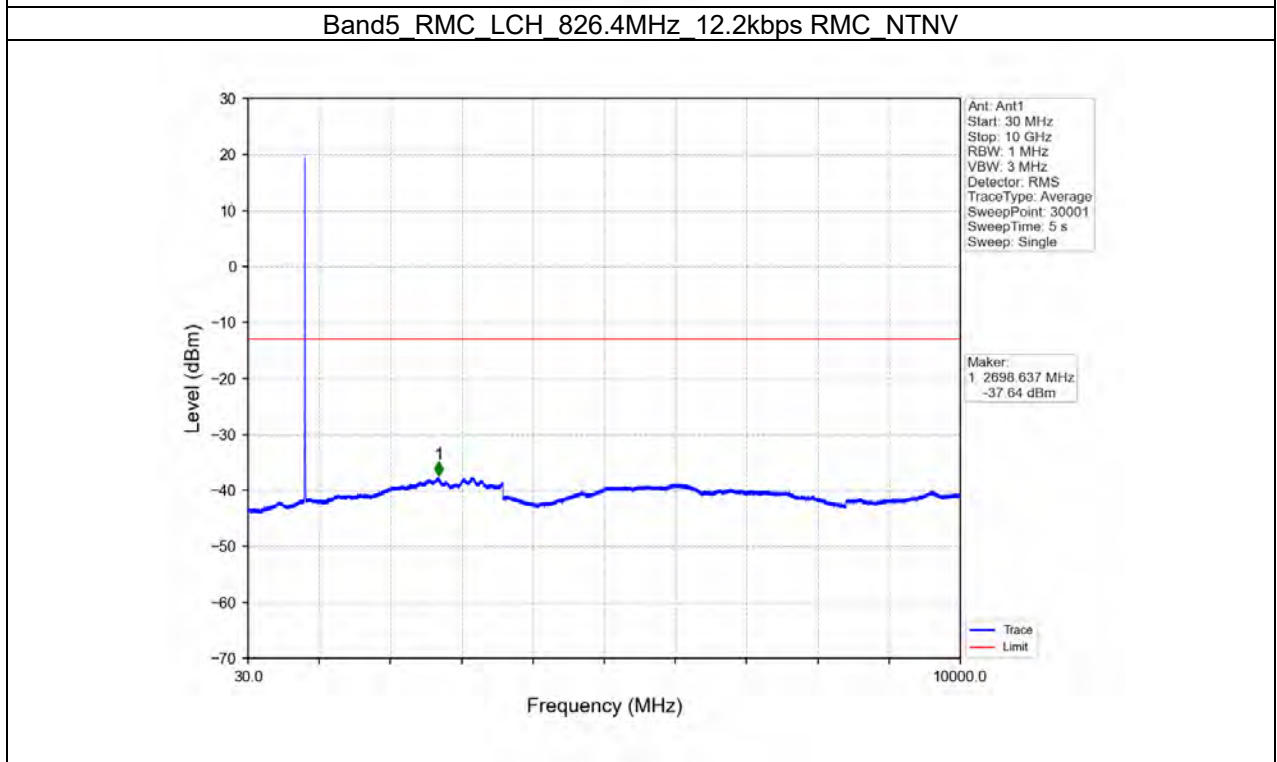
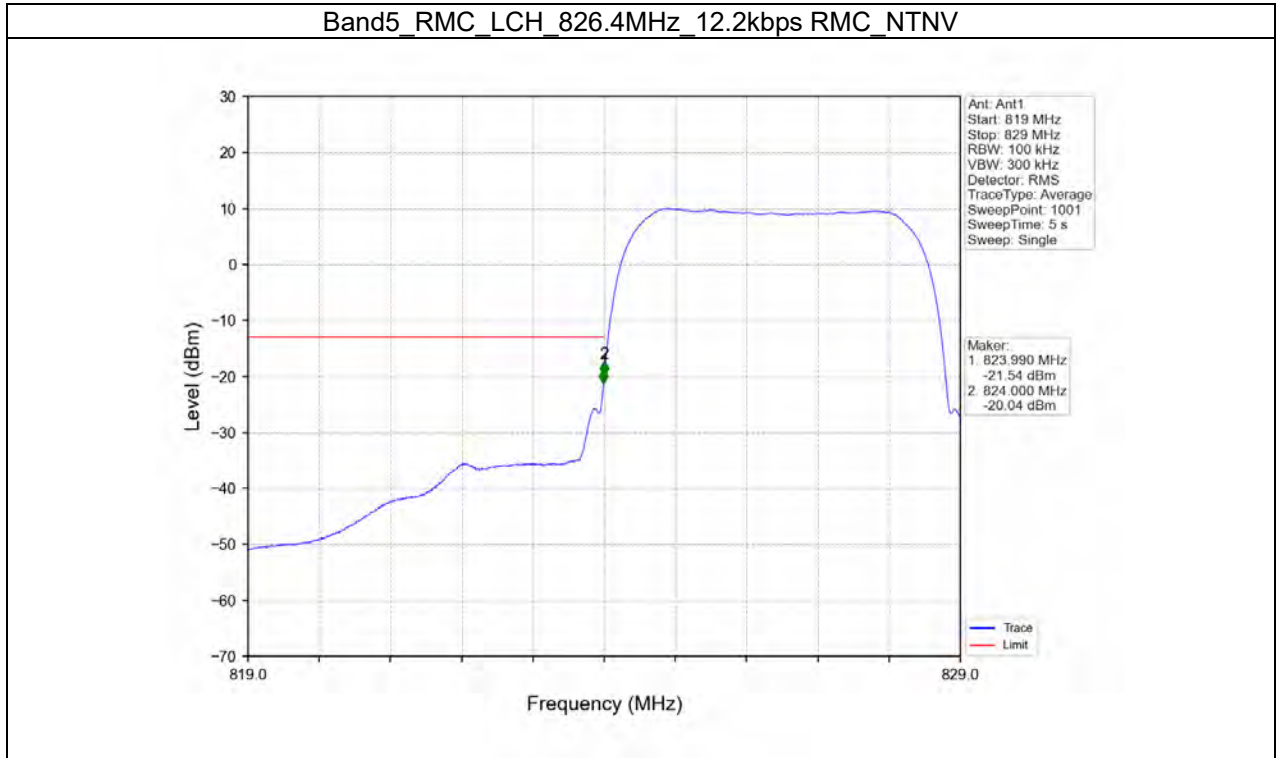



BUREAU
VERITAS

Test Report No.: W7L-P21100026RF13

Band5_RMC_MCH_836.6MHz_12.2kbps RMC_NTNV

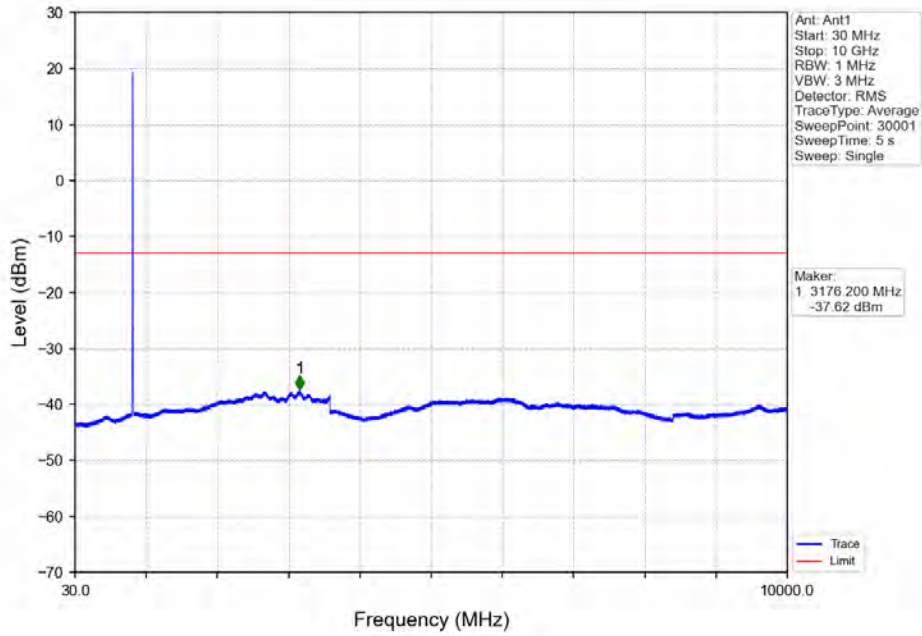

Band5_RMC_HCH_846.6MHz_12.2kbps RMC_NTNV

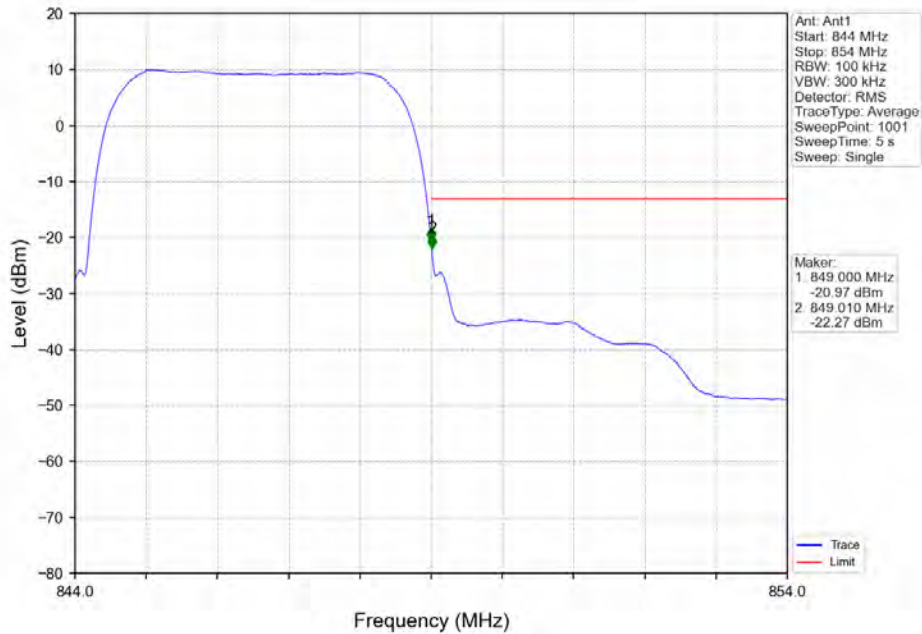



BUREAU
VERITAS

Test Report No.: W7L-P21100026RF13

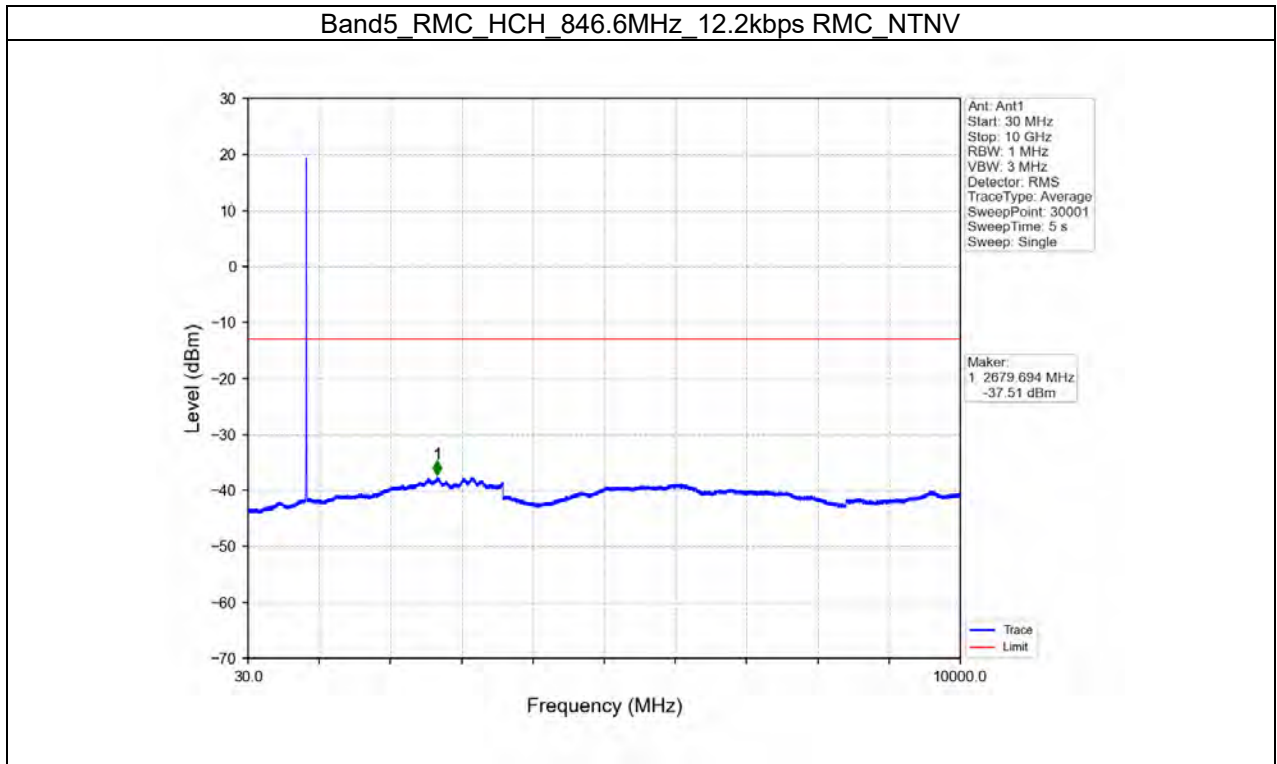



BUREAU
VERITAS

Test Report No.: W7L-P21100026RF13

LTE BAND5

FREQUENCY STABILITY

B5_1.4MHZ

TEST RESULT

Band: 5 / Bandwidth: 1.4MHz									
Modulation	Frequency (MHz)	RB Allocation		Temp. (°C)	Voltage (VDC)	Freq. Error (Hz)	Freq. vs. Rated (ppm)		Verdict
		Size	Offset				Result	Limit	
QPSK	824.7	6	0	20	3.27	-1.70	-0.00	-2.5 to 2.5	Pass
					3.85	-0.13	-0.00	-2.5 to 2.5	Pass
					4.43	-0.47	-0.00	-2.5 to 2.5	Pass
				-30	3.85	1.27	0.00	-2.5 to 2.5	Pass
				-20	3.85	2.56	0.00	-2.5 to 2.5	Pass
				-10	3.85	1.20	0.00	-2.5 to 2.5	Pass
				0	3.85	3.83	0.00	-2.5 to 2.5	Pass
				10	3.85	2.07	0.00	-2.5 to 2.5	Pass
				30	3.85	2.56	0.00	-2.5 to 2.5	Pass
				40	3.85	-0.10	-0.00	-2.5 to 2.5	Pass
	50	3.85	0.24	0.00	-2.5 to 2.5	Pass			
	836.5	6	0	20	3.27	-0.77	-0.00	-2.5 to 2.5	Pass
					3.85	-6.61	-0.01	-2.5 to 2.5	Pass
					4.43	-1.87	-0.00	-2.5 to 2.5	Pass
				-30	3.85	-0.53	-0.00	-2.5 to 2.5	Pass
				-20	3.85	-4.28	-0.01	-2.5 to 2.5	Pass
				-10	3.85	-2.36	-0.00	-2.5 to 2.5	Pass
				0	3.85	-2.60	-0.00	-2.5 to 2.5	Pass
				10	3.85	-2.50	-0.00	-2.5 to 2.5	Pass
				30	3.85	-1.65	-0.00	-2.5 to 2.5	Pass
				40	3.85	-4.36	-0.01	-2.5 to 2.5	Pass
	50	3.85	-2.63	-0.00	-2.5 to 2.5	Pass			
	848.3	6	0	20	3.27	3.65	0.00	-2.5 to 2.5	Pass
					3.85	-1.82	-0.00	-2.5 to 2.5	Pass
					4.43	-4.22	-0.01	-2.5 to 2.5	Pass
				-30	3.85	-5.14	-0.01	-2.5 to 2.5	Pass
				-20	3.85	0.73	0.00	-2.5 to 2.5	Pass
				-10	3.85	-2.36	-0.00	-2.5 to 2.5	Pass
				0	3.85	-3.12	-0.00	-2.5 to 2.5	Pass
				10	3.85	-3.75	-0.00	-2.5 to 2.5	Pass
30				3.85	-2.85	-0.00	-2.5 to 2.5	Pass	
40				3.85	-0.54	-0.00	-2.5 to 2.5	Pass	
50	3.85	-3.20	-0.00	-2.5 to 2.5	Pass				
16QAM	824.7	6	0	20	3.27	-0.80	-0.00	-2.5 to 2.5	Pass
					3.85	1.45	0.00	-2.5 to 2.5	Pass
					4.43	1.90	0.00	-2.5 to 2.5	Pass
				-30	3.85	-1.37	-0.00	-2.5 to 2.5	Pass
				-20	3.85	-4.12	-0.01	-2.5 to 2.5	Pass
				-10	3.85	-0.61	-0.00	-2.5 to 2.5	Pass
0	3.85	-1.90	-0.00	-2.5 to 2.5	Pass				



**BUREAU
VERITAS**

Test Report No.: W7L-P21100026RF13

64QAM	836.5	6	0	10	3.85	-3.32	-0.00	-2.5 to 2.5	Pass
				30	3.85	-0.77	-0.00	-2.5 to 2.5	Pass
				40	3.85	-2.05	-0.00	-2.5 to 2.5	Pass
				50	3.85	6.75	0.01	-2.5 to 2.5	Pass
				20	3.27	-4.42	-0.01	-2.5 to 2.5	Pass
					3.85	-1.14	-0.00	-2.5 to 2.5	Pass
					4.43	0.81	0.00	-2.5 to 2.5	Pass
				-30	3.85	-0.52	-0.00	-2.5 to 2.5	Pass
				-20	3.85	-2.52	-0.00	-2.5 to 2.5	Pass
				-10	3.85	-1.47	-0.00	-2.5 to 2.5	Pass
				0	3.85	-0.86	-0.00	-2.5 to 2.5	Pass
				10	3.85	0.01	0.00	-2.5 to 2.5	Pass
	30	3.85	-0.41	-0.00	-2.5 to 2.5	Pass			
	40	3.85	-2.39	-0.00	-2.5 to 2.5	Pass			
	50	3.85	-1.37	-0.00	-2.5 to 2.5	Pass			
	848.3	6	0	20	3.27	-3.13	-0.00	-2.5 to 2.5	Pass
					3.85	-4.49	-0.01	-2.5 to 2.5	Pass
					4.43	-1.93	-0.00	-2.5 to 2.5	Pass
				-30	3.85	3.30	0.00	-2.5 to 2.5	Pass
				-20	3.85	-0.47	-0.00	-2.5 to 2.5	Pass
				-10	3.85	0.96	0.00	-2.5 to 2.5	Pass
				0	3.85	-1.95	-0.00	-2.5 to 2.5	Pass
				10	3.85	-1.32	-0.00	-2.5 to 2.5	Pass
				30	3.85	-3.65	-0.00	-2.5 to 2.5	Pass
				40	3.85	-3.65	-0.00	-2.5 to 2.5	Pass
				50	3.85	-1.76	-0.00	-2.5 to 2.5	Pass
				824.7	6	0	20	3.27	0.86
	3.85	1.14	0.00					-2.5 to 2.5	Pass
	4.43	-3.58	-0.00					-2.5 to 2.5	Pass
	-30	3.85	-2.83				-0.00	-2.5 to 2.5	Pass
	-20	3.85	0.47				0.00	-2.5 to 2.5	Pass
	-10	3.85	0.96				0.00	-2.5 to 2.5	Pass
	0	3.85	-3.33				-0.00	-2.5 to 2.5	Pass
	10	3.85	-1.65				-0.00	-2.5 to 2.5	Pass
	30	3.85	-0.83				-0.00	-2.5 to 2.5	Pass
	40	3.85	-5.76				-0.01	-2.5 to 2.5	Pass
50	3.85	-0.26	-0.00				-2.5 to 2.5	Pass	
836.5	6	0	20				3.27	-3.98	-0.00
				3.85	-4.46	-0.01	-2.5 to 2.5	Pass	
				4.43	-2.59	-0.00	-2.5 to 2.5	Pass	
			-30	3.85	-0.87	-0.00	-2.5 to 2.5	Pass	
			-20	3.85	-1.12	-0.00	-2.5 to 2.5	Pass	
			-10	3.85	-3.85	-0.00	-2.5 to 2.5	Pass	
			0	3.85	-2.55	-0.00	-2.5 to 2.5	Pass	
			10	3.85	-3.56	-0.00	-2.5 to 2.5	Pass	
			30	3.85	-11.82	-0.01	-2.5 to 2.5	Pass	
			40	3.85	-6.21	-0.01	-2.5 to 2.5	Pass	
			50	3.85	-0.87	-0.00	-2.5 to 2.5	Pass	
			848.3	6	0	20	3.27	-6.14	-0.01
3.85	-3.82	-0.00					-2.5 to 2.5	Pass	
4.43	-1.60	-0.00				-2.5 to 2.5	Pass		
-30	3.85	-0.64				-0.00	-2.5 to 2.5	Pass	
-20	3.85	-2.42	-0.00	-2.5 to 2.5	Pass				



**BUREAU
VERITAS**

Test Report No.: W7L-P21100026RF13

				-10	3.85	-2.16	-0.00	-2.5 to 2.5	Pass
				0	3.85	-5.41	-0.01	-2.5 to 2.5	Pass
				10	3.85	-6.08	-0.01	-2.5 to 2.5	Pass
				30	3.85	-2.93	-0.00	-2.5 to 2.5	Pass
				40	3.85	-4.63	-0.01	-2.5 to 2.5	Pass
				50	3.85	-3.82	-0.00	-2.5 to 2.5	Pass

B5_3MHZ

TEST RESULT

Band: 5 / Bandwidth: 3MHz																
Modulation	Frequency (MHz)	RB Allocation		Temp. (°C)	Voltage (VDC)	Freq. Error (Hz)	Freq. vs. Rated (ppm)		Verdict							
		Size	Offset				Result	Limit								
QPSK	825.5	15	0	20	3.27	-3.85	-0.00	-2.5 to 2.5	Pass							
					3.85	-0.13	-0.00	-2.5 to 2.5	Pass							
					4.43	2.06	0.00	-2.5 to 2.5	Pass							
				836.5	15	0	20	3.85	2.93	0.00	-2.5 to 2.5	Pass				
								-30	3.85	1.22	0.00	-2.5 to 2.5	Pass			
								-20	3.85	1.22	0.00	-2.5 to 2.5	Pass			
							847.5	15	0	-10	3.85	3.33	0.00	-2.5 to 2.5	Pass	
											0	3.85	2.56	0.00	-2.5 to 2.5	Pass
											10	3.85	1.19	0.00	-2.5 to 2.5	Pass
	825.5	15	0							30	3.85	2.32	0.00	-2.5 to 2.5	Pass	
											40	3.85	0.26	0.00	-2.5 to 2.5	Pass
											50	3.85	1.54	0.00	-2.5 to 2.5	Pass
				836.5	15	0				20	3.27	-1.22	-0.00	-2.5 to 2.5	Pass	
											3.85	-5.64	-0.01	-2.5 to 2.5	Pass	
											4.43	-2.72	-0.00	-2.5 to 2.5	Pass	
							847.5	15	0	-30	3.85	-2.62	-0.00	-2.5 to 2.5	Pass	
											-20	3.85	-3.42	-0.00	-2.5 to 2.5	Pass
											-10	3.85	-3.92	-0.00	-2.5 to 2.5	Pass
	825.5	15	0							0	3.85	-1.77	-0.00	-2.5 to 2.5	Pass	
											10	3.85	-1.33	-0.00	-2.5 to 2.5	Pass
											30	3.85	-3.68	-0.00	-2.5 to 2.5	Pass
				836.5	15	0				40	3.85	-5.98	-0.01	-2.5 to 2.5	Pass	
											50	3.85	0.11	0.00	-2.5 to 2.5	Pass
											20	3.27	-1.89	-0.00	-2.5 to 2.5	Pass
							847.5	15	0	20	3.85	-4.95	-0.01	-2.5 to 2.5	Pass	
											4.43	-3.06	-0.00	-2.5 to 2.5	Pass	
											-30	3.85	-1.13	-0.00	-2.5 to 2.5	Pass
825.5	15	0	-20							3.85	-1.40	-0.00	-2.5 to 2.5	Pass		
										-10	3.85	-2.98	-0.00	-2.5 to 2.5	Pass	
										0	3.85	-3.98	-0.00	-2.5 to 2.5	Pass	
			836.5	15	0	10				3.85	-3.18	-0.00	-2.5 to 2.5	Pass		
										30	3.85	-2.58	-0.00	-2.5 to 2.5	Pass	
										40	3.85	-3.85	-0.00	-2.5 to 2.5	Pass	
						847.5	15	0	50	3.85	-3.28	-0.00	-2.5 to 2.5	Pass		
										20	3.27	0.53	0.00	-2.5 to 2.5	Pass	
										3.85	2.03	0.00	-2.5 to 2.5	Pass		
825.5	15	0							20	4.43	0.94	0.00	-2.5 to 2.5	Pass		
										-30	3.85	-0.17	-0.00	-2.5 to 2.5	Pass	
										-20	3.85	0.77	0.00	-2.5 to 2.5	Pass	
			836.5	15	0				-10	3.85	1.49	0.00	-2.5 to 2.5	Pass		



**BUREAU
VERITAS**

Test Report No.: W7L-P21100026RF13

				0	3.85	-0.40	-0.00	-2.5 to 2.5	Pass			
				10	3.85	-0.86	-0.00	-2.5 to 2.5	Pass			
				30	3.85	-3.15	-0.00	-2.5 to 2.5	Pass			
				40	3.85	-1.12	-0.00	-2.5 to 2.5	Pass			
				50	3.85	-0.94	-0.00	-2.5 to 2.5	Pass			
	836.5	15	0	20	3.27	-1.39	-0.00	-2.5 to 2.5	Pass			
					3.85	-1.95	-0.00	-2.5 to 2.5	Pass			
					4.43	-2.03	-0.00	-2.5 to 2.5	Pass			
				-30	3.85	-4.00	-0.00	-2.5 to 2.5	Pass			
				-20	3.85	-3.02	-0.00	-2.5 to 2.5	Pass			
				-10	3.85	-2.59	-0.00	-2.5 to 2.5	Pass			
				0	3.85	0.17	0.00	-2.5 to 2.5	Pass			
				10	3.85	-2.06	-0.00	-2.5 to 2.5	Pass			
				30	3.85	-0.34	-0.00	-2.5 to 2.5	Pass			
				40	3.85	-4.55	-0.01	-2.5 to 2.5	Pass			
				50	3.85	-3.55	-0.00	-2.5 to 2.5	Pass			
				847.5	15	0	20	3.27	-4.91	-0.01	-2.5 to 2.5	Pass
								3.85	-5.88	-0.01	-2.5 to 2.5	Pass
	4.43	-6.65	-0.01					-2.5 to 2.5	Pass			
	-30	3.85	-2.85				-0.00	-2.5 to 2.5	Pass			
	-20	3.85	-4.96				-0.01	-2.5 to 2.5	Pass			
	-10	3.85	-4.08				-0.00	-2.5 to 2.5	Pass			
	0	3.85	-3.83				-0.00	-2.5 to 2.5	Pass			
	10	3.85	-2.56				-0.00	-2.5 to 2.5	Pass			
	30	3.85	-5.96				-0.01	-2.5 to 2.5	Pass			
	40	3.85	-2.07				-0.00	-2.5 to 2.5	Pass			
	50	3.85	-4.09				-0.00	-2.5 to 2.5	Pass			
	64QAM	825.5	15				0	20	3.27	-2.29	-0.00	-2.5 to 2.5
				3.85	-1.17	-0.00			-2.5 to 2.5	Pass		
				4.43	-3.08	-0.00			-2.5 to 2.5	Pass		
				-30	3.85	-2.10		-0.00	-2.5 to 2.5	Pass		
				-20	3.85	0.53		0.00	-2.5 to 2.5	Pass		
				-10	3.85	0.32		0.00	-2.5 to 2.5	Pass		
0				3.85	-2.67	-0.00		-2.5 to 2.5	Pass			
10				3.85	-3.76	-0.00		-2.5 to 2.5	Pass			
30				3.85	-3.79	-0.00		-2.5 to 2.5	Pass			
40				3.85	-5.78	-0.01		-2.5 to 2.5	Pass			
50				3.85	-2.25	-0.00		-2.5 to 2.5	Pass			
836.5				15	0	20		3.27	-2.03	-0.00	-2.5 to 2.5	Pass
								3.85	-2.32	-0.00	-2.5 to 2.5	Pass
		4.43	-1.69				-0.00	-2.5 to 2.5	Pass			
		-30	3.85			-3.15	-0.00	-2.5 to 2.5	Pass			
		-20	3.85			-3.08	-0.00	-2.5 to 2.5	Pass			
		-10	3.85			-2.85	-0.00	-2.5 to 2.5	Pass			
		0	3.85			-4.16	-0.01	-2.5 to 2.5	Pass			
		10	3.85			-5.01	-0.01	-2.5 to 2.5	Pass			
		30	3.85			-5.12	-0.01	-2.5 to 2.5	Pass			
		40	3.85			-4.51	-0.01	-2.5 to 2.5	Pass			
		50	3.85			-6.67	-0.01	-2.5 to 2.5	Pass			
		847.5	15			0	20	3.27	-4.48	-0.01	-2.5 to 2.5	Pass
3.85				-1.25	-0.00			-2.5 to 2.5	Pass			
4.43				-2.32	-0.00			-2.5 to 2.5	Pass			
-30				3.85	-6.67		-0.01	-2.5 to 2.5	Pass			