

FCC TEST REPORT

(Part 15, Subpart E)



Applicant:	Xiaomi Communications Co., Ltd.
Address:	#019, 9th Floor, Building 6, 33 Xi'erqi Middle Road, Haidian District, Beijing, China, 100085

Manufacturer or Supplier:	Xiaomi Communications Co., Ltd.
Address:	#019, 9th Floor, Building 6, 33 Xi'erqi Middle Road, Haidian District, Beijing, China, 100085
Product:	Mobile Phone
Brand Name:	Redmi
Model Name:	2201117SG
FCC ID:	2AFZZ117SG
Date of tests:	Nov. 01, 2021 ~ Nov. 28, 2021

The tests have been carried out according to the requirements of the following standard:

FCC Part 15, Subpart E, Section 15.407

CONCLUSION: The submitted sample was found to COMPLY with the test requirement

Prepared by Simon Wang Engineer / Mobile Department	Approved by Luke Lu Manager / Mobile Department
	
Date: Nov. 29, 2021	Date: Nov. 29, 2021

This report is governed by, and incorporates by reference, CPS Conditions of Service as posted at the date of issuance of this report at <http://www.bureauveritas.com/home/about-us/our-business/cps/about-us/terms-conditions> and is intended for your exclusive use. Any copying or replication of this report to or for any other person or entity, or use of our name or trademark, is permitted only with our prior written permission. This report sets forth our findings solely with respect to the test samples identified herein. The results set forth in this report are not indicative or representative of the quality or characteristics of the lot from which a test sample was taken or any similar or identical product unless specifically and expressly noted. Our report includes all of the tests requested by you and the results thereof based upon the information that you provided to us. Measurement uncertainty is only provided upon request for accredited tests. You have 60 days from date of issuance of this report to notify us of any material error or omission caused by our negligence or if you require measurement uncertainty; provided, however, that such notice shall be in writing and shall specifically address the issue you wish to raise. A failure to raise such issue within the prescribed time shall constitute your unqualified acceptance of the completeness of this report, the tests conducted and the correctness of the report contents.



TABLE OF CONTENTS

RELEASE CONTROL RECORD	5
1 SUMMARY OF TEST RESULTS	6
1.1 MEASUREMENT UNCERTAINTY	6
2 GENERAL INFORMATION.....	7
2.1 GENERAL DESCRIPTION OF EUT	7
2.2 DESCRIPTION OF TEST MODES	9
2.2.1 TEST MODE APPLICABILITY AND TESTED CHANNEL DETAIL.....	11
2.3 DUTY CYCLE OF TEST SIGNAL	16
2.4 DESCRIPTION OF SUPPORT UNITS	16
2.4.1 CONFIGURATION OF SYSTEM UNDER TEST	17
2.5 GENERAL DESCRIPTION OF APPLIED STANDARDS	17
3 TEST TYPES AND RESULTS.....	18
3.1 RADIATED EMISSION AND BANDEDGE MEASUREMENT.....	18
3.1.1 LIMITS OF RADIATED EMISSION AND BANDEDGE MEASUREMENT.....	18
3.1.2 LIMITS OF UNWANTED EMISSION.....	18
3.1.3 TEST INSTRUMENTS.....	19
3.1.4 TEST PROCEDURES	20
3.1.5 DEVIATION FROM TEST STANDARD	20
3.1.6 TEST SETUP	21
3.1.7 EUT OPERATING CONDITION	22
3.1.8 TEST RESULTS	23
3.2 OUT OF BAND EMISSION MEASUREMENT	98
3.2.1 LIMITS OF OUT OF BAND EMISSION MEASUREMENT	98
3.2.2 TEST INSTRUMENTS.....	99
3.2.3 TEST PROCEDURES	99
3.2.4 DEVIATION FROM TEST STANDARD	99
3.2.5 TEST SETUP	99
3.2.6 EUT OPERATING CONDITION	99
3.2.7 TEST RESULTS	100
3.3 CONDUCTED EMISSION MEASUREMENT	101
3.3.1 LIMITS OF CONDUCTED EMISSION MEASUREMENT	101
3.3.2 TEST INSTRUMENTS.....	101
3.3.3 TEST PROCEDURES	101



3.3.4 DEVIATION FROM TEST STANDARD 102

3.3.5 TEST SETUP 102

3.3.6 EUT OPERATING CONDITIONS 102

3.3.7 TEST RESULTS 103

3.4 MAXIMUM CONDUCTED OUTPUT POWER MEASUREMENT 105

3.4.1 LIMITS OF MAXIMUM CONDUCTED OUTPUT POWER MEASUREMENT 105

3.4.2 TEST SETUP 106

3.4.3 TEST INSTRUMENTS 106

3.4.4 TEST PROCEDURE 107

3.4.5 DEVIATION FROM TEST STANDARD 109

3.4.6 EUT OPERATING CONDITIONS 109

3.4.7 TEST RESULTS 110

3.5 MAXIMUM POWER SPECTRAL DENSITY MEASUREMENT 111

3.5.1 LIMITS OF MAXIMUM POWER SPECTRAL DENSITY MEASUREMENT 111

3.5.2 TEST SETUP 111

3.5.3 TEST INSTRUMENTS 111

3.5.4 TEST PROCEDURES 112

3.5.5 DEVIATION FROM TEST STANDARD 112

3.5.6 EUT OPERATING CONDITIONS 112

3.5.7 TEST RESULTS 113

4 PHOTOGRAPHS OF THE TEST CONFIGURATION 114

**5 APPENDIX A – MODIFICATIONS RECORDERS FOR ENGINEERING CHANGES TO THE
EUT BY THE LAB 115**

APPENDIX D: 115

26DB EMISSION BANDWIDTH 115

TEST RESULT 115

TEST GRAPHS 118

99%OCCUPIED CHANNEL BANDWIDTH 149

TEST RESULT 149

TEST GRAPHS 151

6DB EMISSION BANDWIDTH 182

TEST RESULT 182

TEST GRAPHS 183

MAXIMUM CONDUCTED OUTPUT POWER 190

TEST RESULT 190

MAXIMUM POWER SPECTRAL DENSITY 192



Test Report No.: W7L-P21100026RF12

TEST RESULT	192
TEST GRAPHS.....	195
BAND EDGE MEASUREMENTS	226
TEST RESULT	226
TEST GRAPHS.....	229
DUTY CYCLE.....	247
TEST RESULT	247
TEST GRAPHS.....	249



BUREAU
VERITAS

Test Report No.: W7L-P21100026RF12

RELEASE CONTROL RECORD

ISSUE NO.	REASON FOR CHANGE	DATE ISSUED
W7L-P21100026RF12	Original release	Nov. 29, 2021



1 SUMMARY OF TEST RESULTS

The EUT has been tested according to the following specifications:

APPLIED STANDARD: FCC PART 15, SUBPART E		
STANDARD SECTION	TEST TYPE AND LIMIT	RESULT
15.407(b)(6)	AC Power Conducted Emission	Compliance
15.407(b) (1/2/3/4/5)	Radiated Emission & Band Edge Measurement	Compliance
15.407(a/1/2/3)	Maximum conducted output Power	Compliance
15.407(a/1/2/3)	Peak Power Spectral Density	Compliance
15.403(i)	26 dB Bandwidth	Compliance
15.407(e)	6 dB Bandwidth	Compliance
15.203	Antenna Requirement	Compliance

1.1 MEASUREMENT UNCERTAINTY

Where relevant, the following measurement uncertainty levels have been estimated for tests performed on the EUT as specified in CISPR 16-4-2:

MEASUREMENT	UNCERTAINTY
AC Power Conducted emissions	±2.70dB
Radiated emissions (30MHz~1GMHz)	±4.98dB
Radiated emissions (1GMHz ~6GMHz)	±4.70dB
Radiated emissions (6GMHz ~18GMHz)	±4.60dB
Radiated emissions (18GMHz ~40GMHz)	±4.12dB
Conducted emissions	±4.01dB
Occupied Channel Bandwidth	±43.58KHz
Conducted Output power	±2.06dB
Power Spectral Density	±0.85 dB

This uncertainty represents an expanded uncertainty expressed at approximately the 95% confidence level using a coverage factor of k = 2.



2 GENERAL INFORMATION

2.1 GENERAL DESCRIPTION OF EUT

PRODUCT	Mobile Phone
BRAND NAME	Redmi
MODEL NAME	2201117SG
NOMINAL VOLTAGE	5.0V/9.0V/11.0V/12.0V/20.0Vdc(adapter or host equipment) 3.87Vdc (Li-ion, battery)
MODULATION	OFDM
TRANSFER RATE	802.11a: 54.0/ 48.0/ 36.0/ 24.0/ 18.0/ 12.0/ 9.0/ 6.0Mbps 802.11n: up to MCS7 802.11ac: up to 390.0Mbps
OPERATING FREQUENCY	5180 ~ 5240MHz, 5260 ~ 5320MHz, 5500 ~ 5700MHz, 5745 ~ 5825MHz
NUMBER OF CHANNEL	5180 ~ 5240MHz: 4 for 802.11a, 802.11n, 802.11ac (20MHz) 2 for 802.11n, 802.11ac (40MHz) 1 for 802.11ac (80MHz) 5260 ~ 5320MHz: 4 for 802.11a, 802.11n, 802.11ac (20MHz) 2 for 802.11n, 802.11ac (40MHz) 1 for 802.11ac (80MHz) 5500 ~ 5700MHz: 11 for 802.11a, 802.11n, 802.11ac(20MHz) 5 for 802.11n, 802.11ac (40MHz) 2 for 802.11ac (80MHz) 5745 ~ 5825MHz: 4 for 802.11a, 802.11n, 802.11ac (20MHz) 2 for 802.11n, 802.11ac (40MHz) 1 for 802.11ac (80MHz)
AVERAGE POWER	27.04mW for 5180 ~ 5240MHz 28.25mW for 5260 ~ 5320MHz 26.61mW for 5500 ~ 5700MHz 29.85mW for 5745 ~ 5825MHz
ANTENNA TYPE	PIFA Antenna
ANTENNA GAIN	-1.65 dBi for 5180 ~ 5240MHz -1.6 dBi for 5260 ~ 5320MHz -1.3Bi for 5500 ~ 5720MHz -1.46dBi for 5745 ~ 5825MHz
HW VERSION	P1.1
SW VERSION	MIUI12.5
IMEI	868909050035248
I/O PORTS	Refer to user's manual
CABLE SUPPLIED	USB1 cable: unshielded without ferrite, 1.0meter USB2 cable: unshielded without ferrite, 1.0meter



NOTE:

1. For a more detailed features description, please refer to the manufacturer's specifications or the user's manual.
2. The EUT incorporates a SISO function. Physically, the EUT provides one completed transmitter and one receiver.

MODULATION MODE	TX FUNCTION
802.11a	1TX/1RX
802.11n/802.11ac (20MHz)	1TX/1RX
802.11n/802.11ac (40MHz)	1TX/1RX
802.11ac (80MHz)	1TX/1RX

3. For the test results, the EUT had been tested with all conditions. But only the worst case was shown in test report.



2.2 DESCRIPTION OF TEST MODES

FOR 5150 ~ 5250MHz

4 channels are provided for 802.11a, 802.11n, 802.11ac (20MHz):

CHANNEL	FREQUENCY	CHANNEL	FREQUENCY
36	5180 MHz	44	5220 MHz
40	5200 MHz	48	5240 MHz

2 channels are provided for 802.11n, 802.11ac (40MHz):

CHANNEL	FREQUENCY	CHANNEL	FREQUENCY
38	5190 MHz	46	5230 MHz

1 channel is provided for 802.11ac (80MHz):

CHANNEL	FREQUENCY	CHANNEL	FREQUENCY
42	5210 MHz		

FOR 5250 ~ 5350MHz

4 channels are provided for 802.11a, 802.11n, 802.11ac (20MHz):

CHANNEL	FREQUENCY	CHANNEL	FREQUENCY
52	5260 MHz	60	5300 MHz
56	5280 MHz	64	5320 MHz

2 channels are provided for 802.11n, 802.11ac (40MHz):

CHANNEL	FREQUENCY	CHANNEL	FREQUENCY
54	5270 MHz	62	5310 MHz

1 channel is provided for 802.11ac (80MHz):

CHANNEL	FREQUENCY	CHANNEL	FREQUENCY
58	5290 MHz		



FOR 5470 ~ 5725MHz

11 channels are provided for 802.11a, 802.11n, 802.11ac (20MHz):

CHANNEL	FREQUENCY	CHANNEL	FREQUENCY
100	5500 MHz	124	5620MHz
104	5520 MHz	128	5640MHz
108	5540 MHz	132	5660 MHz
112	5560 MHz	136	5680 MHz
116	5580 MHz	140	5700 MHz
120	5600 MHz		

5 channels are provided for 802.11n, 802.11ac (40MHz):

CHANNEL	FREQUENCY	CHANNEL	FREQUENCY
102	5510 MHz	126	5630MHz
110	5550 MHz	134	5670 MHz
118	5590 MHz		

2 channel is provided for 802.11ac (80MHz):

CHANNEL	FREQUENCY	CHANNEL	FREQUENCY
106	5530 MHz		
122	5610 MHz		

FOR 5725 ~ 5850MHz

5 channels are provided for 802.11a, 802.11n, 802.11ac (20MHz):

CHANNEL	FREQUENCY	CHANNEL	FREQUENCY
149	5745 MHz	161	5805 MHz
153	5765 MHz	165	5825 MHz
157	5785 MHz		

2 channels are provided for 802.11n, 802.11ac (40MHz):

CHANNEL	FREQUENCY	CHANNEL	FREQUENCY
159	5795 MHz	159	5795 MHz
151	5755 MHz		

1 channel is provided for 802.11ac (80MHz):

CHANNEL	FREQUENCY	CHANNEL	FREQUENCY
155	5775 MHz		



2.2.1 TEST MODE APPLICABILITY AND TESTED CHANNEL DETAIL

EUT CONFIGURE MODE	APPLICABLE TO				DESCRIPTION
	RE≥1G	RE<1G	PLC	APCM	
A	√	√	√	-	Powered by Adapter with wifi(5G) link
B	-	-	-	√	Powered by Battery with wifi(5G) link
C	-	-	-	-	Powered by USB with wifi(5G) link

Where **RE≥1G**: Radiated Emission above 1GHz **RE<1G**: Radiated Emission below 1GHz
PLC: Power Line Conducted Emission **APCM**: Antenna Port Conducted Measurement

NOTE:
The EUT had been pre-tested on the positioned of each 3 axis. The worst case was found when positioned on **X-plane**.
NOTE: "-" means no effect.

RADIATED EMISSION TEST (BELOW 1GHz):

- Pre-Scan has been conducted to determine the worst-case mode from all possible combinations between available modulations, data rates and antenna ports (if EUT with antenna diversity architecture).
- Following channel(s) was (were) selected for the final test as listed below.

EUT CONFIGURE MODE	MODE	FREQ. BAND (MHz)	AVAILABLE CHANNEL	TESTED CHANNEL	MODULATION	DATA RATE (Mbps)
A	802.11n (20MHz)	5180-5240	36 to 48	48	OFDM	MCS0



RADIATED EMISSION TEST (ABOVE 1GHz):

- Pre-Scan has been conducted to determine the worst-case mode from all possible combinations between available modulations, data rates and antenna ports (if EUT with antenna diversity architecture).
- Following channel(s) was (were) selected for the final test as listed below.

EUT CONFIGURE MODE	MODE	FREQ. BAND (MHz)	AVAILABLE CHANNEL	TESTED CHANNEL	MODULATION	DATA RATE (Mbps)
A	802.11a	5180-5240	36 to 48	36, 40, 48	OFDM	6.0
A	802.11n (20MHz)		36 to 48	36, 40, 48	OFDM	MCS0
A	802.11n (40MHz)		38 to 46	38, 46	OFDM	MCS0
A	802.11ac (20MHz)		36 to 48	36, 40, 48	OFDM	MCS0
A	802.11ac (40MHz)		38 to 46	38, 46	OFDM	MCS0
A	802.11ac (80MHz)		42	42	OFDM	MCS0
A	802.11a	5260-5320	52 to 64	52, 60, 64	OFDM	6.0
A	802.11n (20MHz)		52 to 64	52, 60, 64	OFDM	MCS0
A	802.11n (40MHz)		54 to 62	54, 62	OFDM	MCS0
A	802.11ac (20MHz)		52 to 64	52, 60, 64	OFDM	MCS0
A	802.11ac (40MHz)		54 to 62	54, 62	OFDM	MCS0
A	802.11ac (80MHz)		58	58	OFDM	MCS0
A	802.11a	5500-5700	100 to 140	100, 116, 140	OFDM	6.0
A	802.11n (20MHz)		100 to 140	100, 116, 140	OFDM	MCS0
A	802.11n (40MHz)		102 to 134	102, 110, 134	OFDM	MCS0
A	802.11ac (20MHz)		100 to 140	100, 116, 140	OFDM	MCS0
A	802.11ac (40MHz)		102 to 134	102, 110, 134	OFDM	MCS0
A	802.11ac (80MHz)		106	106	OFDM	MCS0
A	802.11a	5745-5850	149 to 165	100, 116, 140	OFDM	6.0
A	802.11n (20MHz)		149 to 165	100, 116, 140	OFDM	MCS0
A	802.11ac (40MHz)		151 to 159	102, 110, 134	OFDM	MCS0
A	802.11ac (20MHz)		149 to 165	100, 116, 140	OFDM	MCS0
A	802.11n (40MHz)		151 to 159	102, 110, 134	OFDM	MCS0
A	802.11ac (80MHz)		155	106	OFDM	MCS0



POWER LINE CONDUCTED EMISSION TEST:

- Pre-Scan has been conducted to determine the worst-case mode from all possible combinations between available modulations, data rates and antenna ports (if EUT with antenna diversity architecture).
- Following channel(s) was (were) selected for the final test as listed below.

EUT CONFIGURE MODE	MODE	FREQ. BAND (MHz)	AVAILABLE CHANNEL	TESTED CHANNEL	MODULATION	DATA RATE (Mbps)
A	802.11n (40MHz)	5180-5240	36 to 48	48	OFDM	MCS0

BANDEDGE MEASUREMENT:

- Pre-Scan has been conducted to determine the worst-case mode from all possible combinations between available modulations, data rates and antenna ports (if EUT with antenna diversity architecture).
- Following channel(s) was (were) selected for the final test as listed below.

EUT CONFIGURE MODE	MODE	FREQ. BAND (MHz)	AVAILABLE CHANNEL	TESTED CHANNEL	MODULATION	DATA RATE (Mbps)
A	802.11a	5180-5240	36 to 48	36, 48	36 to 48	6.0
A	802.11n (20MHz)		36 to 48	36, 48	36 to 48	MCS0
A	802.11n (40MHz)		38 to 46	38, 46	38 to 46	MCS0
A	802.11ac (20MHz)		36 to 48	36, 48	36 to 48	MCS0
A	802.11ac (40MHz)		38 to 46	38, 46	38 to 46	MCS0
A	802.11ac (80MHz)		42	42	42	MCS0
A	802.11a	5260-5320	52 to 64	52, 64	52 to 64	6.0
A	802.11n (20MHz)		52 to 64	52, 64	52 to 64	MCS0
A	802.11n (40MHz)		54 to 62	54, 62	54 to 62	MCS0
A	802.11ac (20MHz)		52 to 64	52, 64	52 to 64	MCS0
A	802.11ac (40MHz)		54 to 62	54, 62	54 to 62	MCS0
A	802.11ac (80MHz)		58	58	58	MCS0
A	802.11a	5500-5700	100 to 140	100, 116, 140	100 to 140	6.0
A	802.11n (20MHz)		100 to 140	100, 116, 140	100 to 140	MCS0
A	802.11n (40MHz)		102 to 134	102, 110, 134	102 to 134	MCS0
A	802.11ac (20MHz)		100 to 140	100, 116, 140	100 to 140	MCS0
A	802.11ac (40MHz)		102 to 134	102, 110, 134	102 to 134	MCS0
A	802.11ac (80MHz)		106	106	106	MCS0



EUT CONFIGURE MODE	MODE	FREQ. BAND (MHz)	AVAILABLE CHANNEL	TESTED CHANNEL	MODULATION	DATA RATE (Mbps)
A	802.11a	5745-5825	149 to 165	149, 157,165	OFDM	6.0
A	802.11n (20MHz)		149 to 165	149, 157,165	OFDM	MCS0
A	802.11n (40MHz)		151 to 159	151, 159	OFDM	MCS0
A	802.11ac (20MHz)		149 to 165	149, 157,165	OFDM	MCS0
A	802.11ac (40MHz)		151 to 159	151, 159	OFDM	MCS0
A	802.11ac (80MHz)		155	155	OFDM	MCS0

ANTENNA PORT CONDUCTED MEASUREMENT:

- This item includes all test value of each mode, but only includes spectrum plot of worst value of each mode.
- Pre-Scan has been conducted to determine the worst-case mode from all possible combinations between available modulations, data rates and antenna ports (if EUT with antenna diversity architecture).
- Following channel(s) was (were) selected for the final test as listed below.

EUT CONFIGURE MODE	MODE	FREQ. BAND (MHz)	AVAILABLE CHANNEL	TESTED CHANNEL	MODULATION	DATA RATE (Mbps)
A	802.11a	5180-5240	36 to 48	36, 40, 48	OFDM	6.0
A	802.11n (20MHz)		36 to 48	36, 40, 48	OFDM	MCS0
A	802.11n (40MHz)		38 to 46	38, 46	OFDM	MCS0
A	802.11ac (20MHz)		36 to 48	36, 40, 48	OFDM	MCS0
A	802.11ac (40MHz)		38 to 46	38, 46	OFDM	MCS0
A	802.11ac (80MHz)		42	42	OFDM	MCS0
A	802.11a	5260-5320	52 to 64	52, 60, 64	OFDM	6.0
A	802.11n (20MHz)		52 to 64	52, 60, 64	OFDM	MCS0
A	802.11n (40MHz)		54 to 62	54, 62	OFDM	MCS0
A	802.11ac (20MHz)		52 to 64	52, 60, 64	OFDM	MCS0
A	802.11ac (40MHz)		54 to 62	54, 62	OFDM	MCS0
A	802.11ac (80MHz)		58	58	OFDM	MCS0
A	802.11a	5500-5700	100 to 144	100, 116, 140, 144	OFDM	6.0



A	802.11n (20MHz)		100 to 144	100, 116, 140, 144	OFDM	MCS0
A	802.11n (40MHz)		102 to 142	102, 110, 134, 142	OFDM	MCS0
A	802.11ac (20MHz)		100 to 144	100, 116, 140, 144	OFDM	MCS0
A	802.11ac (40MHz)		102 to 142	102, 110, 134, 142	OFDM	MCS0
A	802.11ac (80MHz)		106 to 138	106, 138	OFDM	MCS0
A	802.11a	5745-5850	149 to 165	149, 157,165	OFDM	6.0
A	802.11n (20MHz)		149 to 165	149, 157,165	OFDM	MCS0
A	802.11n (40MHz)		151 to 159	151, 159	OFDM	MCS0
A	802.11ac (20MHz)		149 to 165	149, 157,165	OFDM	MCS0
A	802.11ac (40MHz)		151 to 159	151, 159	OFDM	MCS0
A	802.11ac (80MHz)		155	155	OFDM	MCS0

TEST CONDITION:

APPLICABLE TO	ENVIRONMENTAL CONDITIONS	INPUT POWER	TESTED BY
RE<1G	23deg. C, 70%RH	DC 5V/9V/11V/12V/20V By Adapter	Star Le
RE≥1G	23deg. C, 70%RH	DC 5V/9V/11V/12V/20V By Adapter	Star Le
PLC	25deg. C, 52%RH	DC 5V/9V/11V/12V/20V By Adapter	Jimmy Liu
APCM	25deg. C, 60%RH	DC 3.87V By Battery	Lily Zhao



2.3 DUTY CYCLE OF TEST SIGNAL

Please Refer to Appendix B/C Of this test report.

WORST-CASE DATA:

Measured Duty Cycle		
Mode		Duty Cycle [%]
		ANT1
5GHZ	11a	97.90
	11n20	97.74
	11n40	95.59
	11ac20	97.78
	11ac40	95.59
	11ac80	91.67

Note:

Duty cycle of test signal is < 98%, duty factor shall be considered.

2.4 DESCRIPTION OF SUPPORT UNITS

The EUT has been tested as an independent unit together with other necessary accessories or support units. The following support units or accessories were used to form a representative test configuration during the tests.

NO.	PRODUCT	BRAND	MODEL NO.	SERIAL NO.	FCC ID
1	Desktop	Lenovo	M73 SFF	PC04GRQV	N/A
2	Desktop	Lenovo	M73 SFF	PC06CS27	N/A
3	Laptop	Lenovo	Thnikpad L440	R90FTFKN	N/A

NO.	SIGNAL CABLE DESCRIPTION OF THE ABOVE SUPPORT UNITS
1	AC Line: Unshielded, Detachable 1.5m
2	AC Line: Unshielded, Detachable 1.5m
3	AC Line: Unshielded, Detachable 1.5m



2.4.1 CONFIGURATION OF SYSTEM UNDER TEST

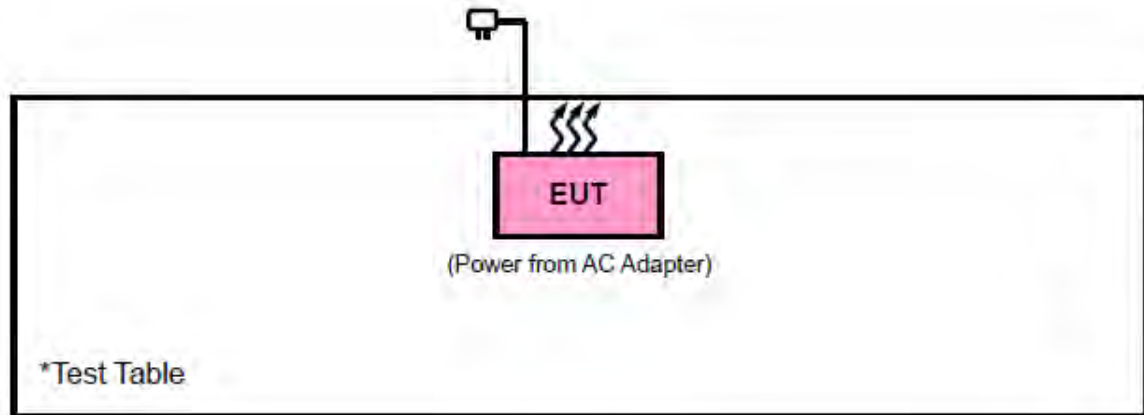

2.5 GENERAL DESCRIPTION OF APPLIED STANDARDS

The EUT is a RF Product. According to the specifications of the manufacturer, it must comply with the requirements of the following standards:

FCC Part 15, Subpart E (15.407)

KDB 789033 D02 General U-NII Test Procedures New Rules v02r01

ANSI C63.10-2013

All test items have been performed and recorded as per the above standards.

NOTE: The EUT is also considered as a kind of computer peripheral, because the connection to computer is necessary for typical use. It has been verified to comply with the requirements of FCC Part 15, Subpart B, Class B (Certification). The test report has been issued separately.



3 TEST TYPES AND RESULTS

3.1 RADIATED EMISSION AND BANDEDGE MEASUREMENT

3.1.1 LIMITS OF RADIATED EMISSION AND BANDEDGE MEASUREMENT

Radiated emissions which fall in the restricted bands must comply with the radiated emission limits specified as below table:

FREQUENCIES (MHz)	FIELD STRENGTH (microvolts/meter)	MEASUREMENT DISTANCE (meters)
0.009 ~ 0.490	2400/F(kHz)	300
0.490 ~ 1.705	24000/F(kHz)	30
1.705 ~ 30.0	30	30
30 ~ 88	100	3
88 ~ 216	150	3
216 ~ 960	200	3
Above 960	500	3

NOTE:

1. The lower limit shall apply at the transition frequencies.
2. Emission level (dBuV/m) = 20 log Emission level (uV/m).
3. For frequencies above 1000MHz, the field strength limits are based on average detector, however, the peak field strength of any emission shall not exceed the maximum permitted average limits, specified above by more than 20dB under any condition of modulation.

3.1.2 LIMITS OF UNWANTED EMISSION

RESTRICTED BANDS	APPLICABLE TO	LIMIT	
	789033 D02 General UNII Test Procedures New Rules v02r01	FIELD STRENGTH AT 3m (dBµV/m)	
		PK : 74	AV : 54
OUT OF THE RESTRICTED BANDS	APPLICABLE TO	EIRP LIMIT (dBm/MHz)	EQUIVALENT FIELD STRENGTH AT 3m (dBµV/m)
	15.407(b)(1)	PK : -27	PK : 68.3
	15.407(b)(2)		
	15.407(b)(3)		
15.407(b)(4)	See note 2 (FCC 16-24)		



NOTE: The following formula is used to convert the equipment isotropic radiated power (eirp) to field strength:

$$E = \frac{1000000 \sqrt{30P}}{3} \mu\text{V/m, where P is the eirp (Watts).}$$

2. All emissions shall be limited to a level of -27 dBm/MHz at 75 MHz or more above or below the band edge increasing linearly to 10 dBm/MHz at 25 MHz above or below the band edge, and from 25 MHz above or below the band edge increasing linearly to a level of 15.6 dBm/MHz at 5 MHz above or below the band edge, and from 5 MHz above or below the band edge increasing linearly to a level of 27 dBm/MHz at the band edge.

3.1.3 TEST INSTRUMENTS

Equipment	Manufacturer	Model No.	Serial No.	Last Cal.	Next Cal.
3m Semi-anechoic Chamber	ETS-LINDGREN	9m*6m*6m	Euroshieldpn-CT0001143-1216	May. 19,20	May. 18,23
Bilog Antenna	ETS-LINDGREN	3143B	00161965	Mar. 05,21	Mar. 04,22
Horn Antenna	ETS-LINDGREN	3117	00168728	Apr. 02, 21	Apr. 01, 22
Horn Antenna (18GHz-40GHz)	N/A	QWH-SL-18-40-K-SG/QMS-00361	15433	Aug. 25, 21	Aug. 24, 22
Test Software	E3	V 9.160323	N/A	N/A	N/A
Test Software	ADT	ADT_Radiated_V7.6.15.9.2	N/A	N/A	N/A
10dB Attenuator	JFW/USA	50HF-010-SMA	1505	Jun. 03,21	Jun. 02,22
MXE EMI Receiver	KEYSIGHT	N9038A-544	MY54450026	Apr. 27,21	Apr. 26,22
Signal Pre-Amplifier	EMSI	EMC 9135	980249	Jun. 02,21	Jun. 01,22
Signal Pre-Amplifier	EMSI	EMC 012645B	980257	Jun. 02,21	Jun. 01,22
Signal Pre-Amplifier	EMSI	EMC 184045B	980259	Apr. 30,21	Apr. 29,22
DC Source	Kikusui/JP	PMX18-5A	0000001	Aug. 25,21	Aug. 24,22
Power Meter	Anritsu	ML2495A	1506002	Feb. 25,21	Feb. 24,22
Power Sensor	Anritsu	MA2411B	1339352	Feb. 25,21	Feb. 24,22
Loop Antenna	Schwarzbeck	FMZB 1519B	1519B-051	Feb 14,20	Feb. 13,23

- NOTE:**
1. The calibration interval of the above test instruments is 12 months or 36 months and the calibrations are traceable to CEPREI/CHINA, GRGT/CHINA and NIM/CHINA.
 2. The test was performed in 3m Chamber.
 3. The FCC Site Registration No. is 525120; The Designation No. is CN1171.



3.1.4 TEST PROCEDURES

- a. The EUT was placed on the top of a rotating table 0.8 meters (for below 1GHz) / 1.5 meters (for above 1GHz) above the ground at 3 meter chamber room for test. The table was rotated 360 degrees to determine the position of the highest radiation.
- b. The EUT was set 3 meters away from the interference-receiving antenna, which was mounted on the top of a variable-height antenna tower.
- c. The antenna is a broadband antenna, and its height is varied from one meter to four meters above the ground to determine the maximum value of the field strength. Both horizontal and vertical polarizations of the antenna are set to make the measurement.
- d. For each suspected emission, the EUT was arranged to its worst case and then the antenna was tuned to heights from 1 meter to 4 meters and the rotatable table was turned from 0 degrees to 360 degrees to find the maximum reading.
- e. The test-receiver system was set to Peak Detect Function and Specified Bandwidth with Maximum Hold Mode.
- f. If the emission level of the EUT in peak mode was 10dB lower than the limit specified, then testing could be stopped and the peak values of the EUT would be reported. Otherwise the emissions that did not have 10dB margin would be re-tested one by one using peak, quasi-peak or average method as specified and then reported in a data sheet.

NOTE:

1. The resolution bandwidth and video bandwidth of test receiver/spectrum analyzer is 120kHz for Peak detection (PK) and Quasi-peak detection (QP) at frequency below 1GHz.
2. The resolution bandwidth of test receiver/spectrum analyzer is 1MHz and video bandwidth is 3MHz for Peak detection at frequency above 1GHz.
3. The resolution bandwidth of test receiver/spectrum analyzer is 1MHz and the video bandwidth is 3MHz for RMS Average (Duty cycle < 98%) for Average detection (AV) at frequency above 1GHz, then the measurement results was added to a correction factor ($10 \log(1/\text{duty cycle})$).
4. The resolution bandwidth of test receiver/spectrum analyzer is 1MHz and the video bandwidth is 10Hz (Duty cycle \geq 98%) for Average detection (AV) at frequency above 1GHz.
5. All modes of operation were investigated and the worst-case emissions are reported.

3.1.5 DEVIATION FROM TEST STANDARD

No deviation.



3.1.6 TEST SETUP

< Frequency Range 9KHz~30MHz >

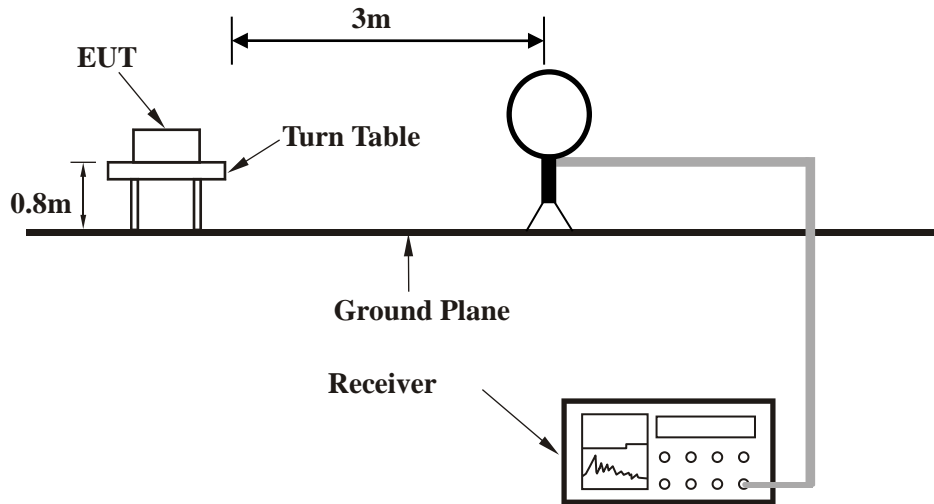

< Frequency Range 30MHz~1GHz >

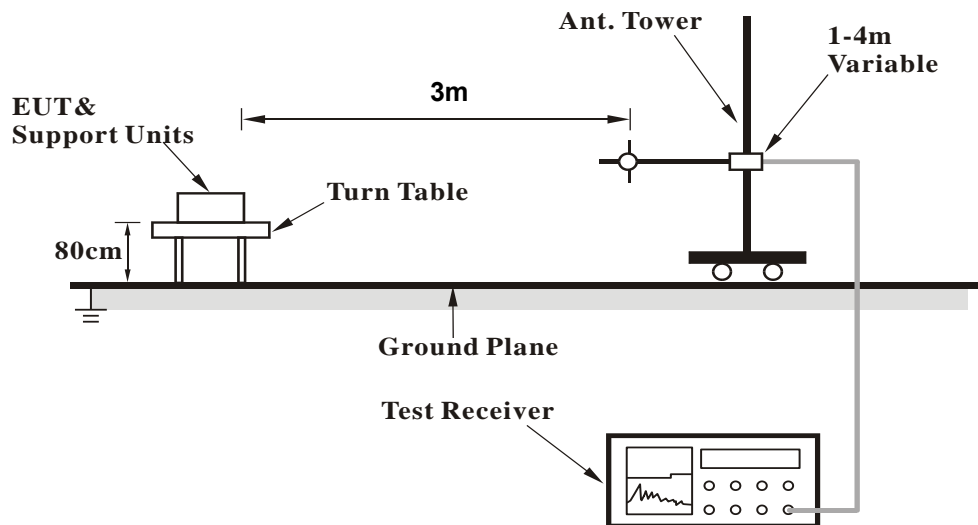



<Frequency Range above 1GHz>

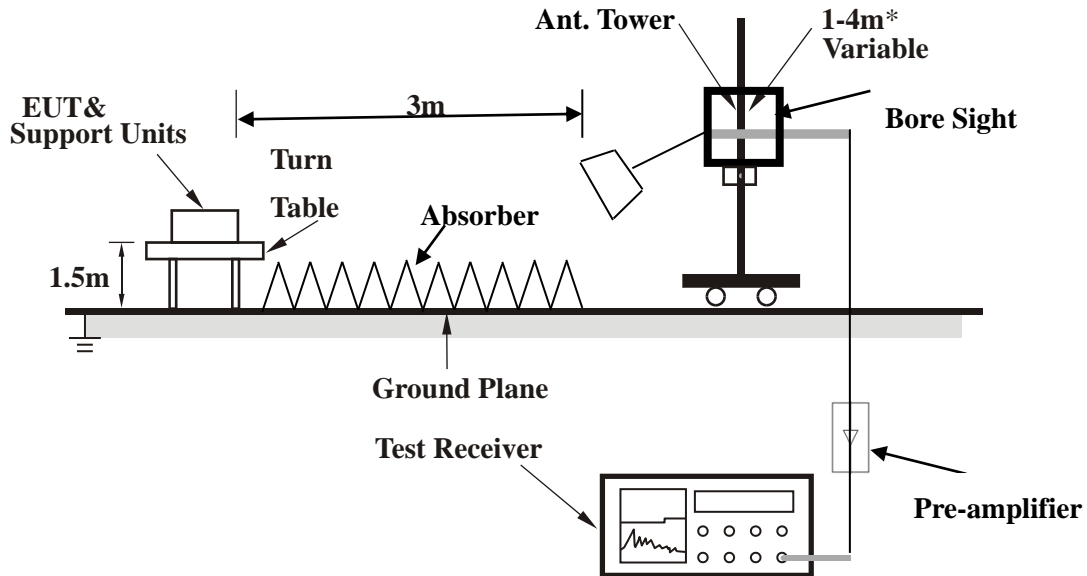

Note: Above 1G is a directional antenna

Depends on the EUT height and the antenna 3dB beamwidth both, refer to section 7.3 of CISPR 16-2-3.

For the actual test configuration, please refer to the attached file (Test Setup Photo).

3.1.7 EUT OPERATING CONDITION

- Set the EUT under full load condition and placed them on a testing table.
- Set the transmitter part of EUT under transmission condition continuously at specific channel frequency.
- The necessary accessories enable the EUT in full functions.



3.1.8 TEST RESULTS

BELOW 1GHz WORST-CASE DATA:

Note: For frequency below 30MHz, the emission was tested 20db below the limit so the data not recorded in the sheet.

30 MHz – 1GHz data:

Band 1

802.11ac (80MHz)

CHANNEL	TX Channel 42	DETECTOR FUNCTION	Quasi-Peak (QP)
FREQUENCY RANGE	30MHz ~ 1GHz		

ANTENNA POLARITY & TEST DISTANCE: HORIZONTAL AT 3 M										
FREQ. (MHz)	EMISSION LEVEL (dBuV/m)	READ LEVEL (dBuV)	LIMIT (dBuV/m)	MARGIN (dB)	ANTENNA FACTOR (dB /m)	CABLE LOSS (dB)	PREAMP FACTOR (dB)	ANTENNA HEIGHT (cm)	TABLE ANGLE (Degree)	REMARK
87.23	19.78	48.03	40	-20.22	7.83	1.19	37.27	300	0	Peak
108.57	22.87	50.6	43.5	-20.63	8.07	1.33	37.13	300	0	Peak
189.08	25.55	49.85	43.5	-17.95	10.56	1.74	36.6	300	0	Peak
295.78	24.18	44.8	46	-21.82	13.93	2.19	36.74	300	0	Peak
422.85	25.35	42.27	46	-20.65	17.31	2.64	36.87	300	0	Peak
594.54	23.99	37.55	46	-22.01	20.59	3.2	37.35	300	0	Peak

REMARKS:

1. Emission level (dBuV/m) = Read level (dBuV) + Correction Factor (dB/m).
2. Correction Factor (dB/m) = Antenna Factor (dB/m) + Cable Factor (dB).
3. The other emission levels were very low against the limit.
4. Margin value = Emission level – Limit value.

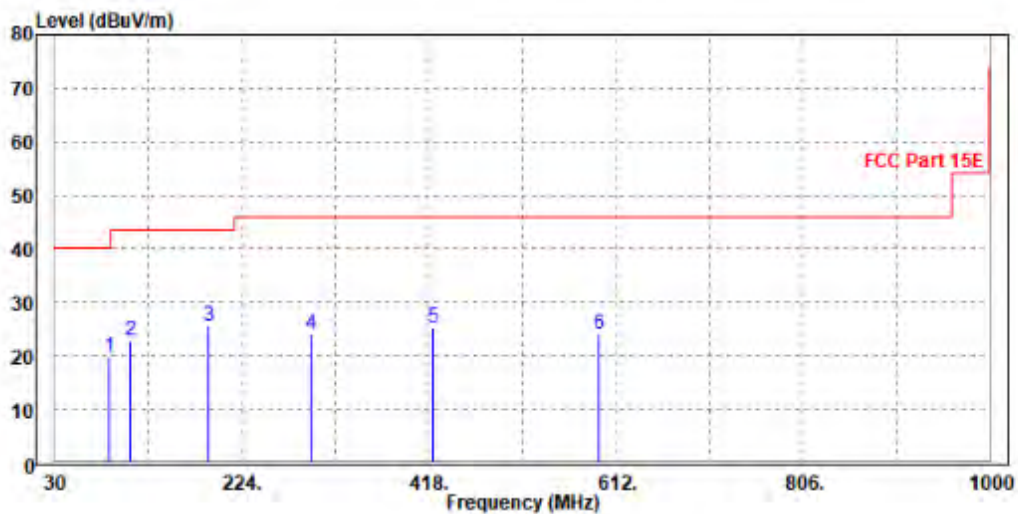



CHANNEL	Channel 42	DETECTOR FUNCTION	Quasi-Peak (QP)
FREQUENCY RANGE	30MHz ~ 1GHz		

ANTENNA POLARITY & TEST DISTANCE: VERTICAL AT 3 M										
FREQ. (MHz)	EMISSION LEVEL (dBuV/m)	READ LEVEL (dBuV)	LIMIT (dBuV/m)	MARGIN (dB)	ANTENNA FACTOR (dB /m)	CABLE LOSS (dB)	PREAMP FACTOR (dB)	ANTENNA HEIGHT (cm)	TABLE ANGLE (Degree)	REMARK
48.43	16.26	43.22	40	-23.74	9.5	0.89	37.35	200	360	Peak
81.41	13.6	41.45	40	-26.4	8.33	1.15	37.33	200	360	Peak
125.06	13.83	41.55	43.5	-29.67	7.9	1.42	37.04	200	360	Peak
158.04	14.35	38.29	43.5	-29.15	11.21	1.6	36.75	200	360	Peak
422.85	19.72	36.32	46	-26.28	17.63	2.64	36.87	200	360	Peak
541.19	24.08	38.34	46	-21.92	19.84	3.05	37.15	200	360	Peak

REMARKS:

1. Emission level (dBuV/m) = Read level (dBuV) + Correction Factor (dB/m).
2. Correction Factor (dB/m) = Antenna Factor (dB/m) + Cable Factor (dB).
3. The other emission levels were very low against the limit.
4. Margin value = Emission level – Limit value.

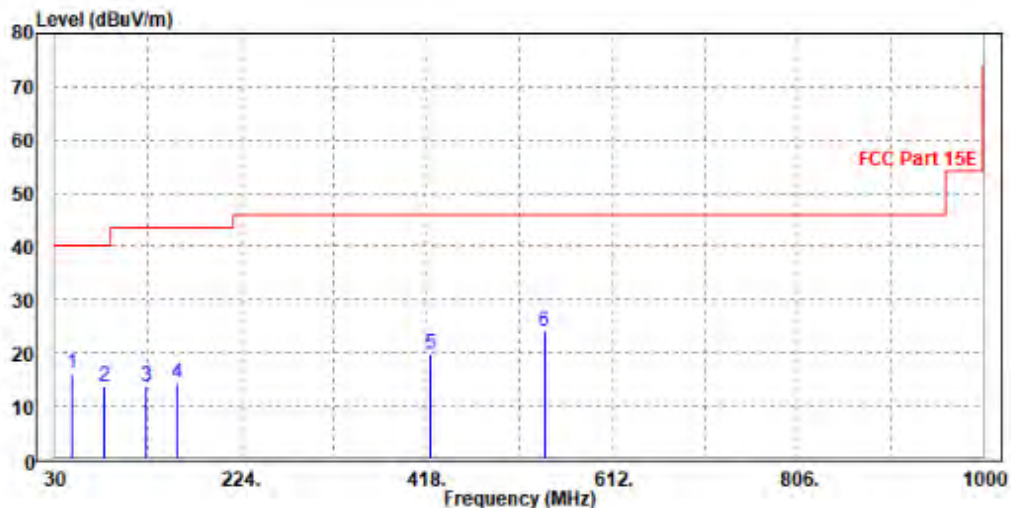



ABOVE 1GHz WORST-CASE DATA:

Note: For higher frequency, the emission is too low to be detected.

Band 1

802.11a

CHANNEL	TX Channel 36	DETECTOR FUNCTION	Peak (PK)
FREQUENCY RANGE	1GHz ~ 40GHz		Average (AV)

ANTENNA POLARITY & TEST DISTANCE: HORIZONTAL AT 3 M

FREQ. (MHz)	EMISSION LEVEL (dBuV/m)	READ LEVEL (dBuV)	LIMIT (dBuV/m)	MARGIN (dB)	ANTENNA FACTOR (dB /m)	CABLE LOSS (dB)	PREAMP FACTOR (dB)	ANTENNA HEIGHT (cm)	TABLE ANGLE (Degree)	REMARK
5150	55.88	58.19	74	-18.12	34.52	9.52	46.35	200	332	Peak
5150	49.61	51.92	54	-4.39	34.52	9.52	46.35	200	332	Average
5180	100.57	102.8	/	/	34.54	9.58	46.35	200	332	Peak
5180	94.63	96.86	/	/	34.54	9.58	46.35	200	332	Average
5350	52.57	54.25	74	-21.43	34.68	9.94	46.3	200	332	Peak
5350	47.61	49.29	54	-6.39	34.68	9.94	46.3	200	332	Average

ANTENNA POLARITY & TEST DISTANCE: VERTICAL AT 3 M

FREQ. (MHz)	EMISSION LEVEL (dBuV/m)	READ LEVEL (dBuV)	LIMIT (dBuV/m)	MARGIN (dB)	ANTENNA FACTOR (dB /m)	CABLE LOSS (dB)	PREAMP FACTOR (dB)	ANTENNA HEIGHT (cm)	TABLE ANGLE (Degree)	REMARK
5150	54.75	56.98	74	-19.25	34.6	9.52	46.35	100	82	Peak
5150	49	51.23	54	-5	34.6	9.52	46.35	100	82	Average
5180	95.84	98.01	/	/	34.6	9.58	46.35	100	82	Peak
5180	88.01	90.18	/	/	34.6	9.58	46.35	100	82	Average
5350	54.48	56.24	74	-19.52	34.6	9.94	46.3	100	82	Peak
5350	48.02	49.78	54	-5.98	34.6	9.94	46.3	100	82	Average

REMARKS:

- Emission Level = Read Level+ Antenna Factor + Cable Loss- Preamp Factor
Margin value = Emission level – Limit value.
- 5180MHz: Fundamental frequency.



CHANNEL	TX Channel 40	DETECTOR FUNCTION	Peak (PK)
FREQUENCY RANGE	1GHz ~ 40GHz		Average (AV)

ANTENNA POLARITY & TEST DISTANCE: HORIZONTAL AT 3 M										
FREQ. (MHz)	EMISSION LEVEL (dBuV/m)	READ LEVEL (dBuV)	LIMIT (dBuV/m)	MARGIN (dB)	ANTENNA FACTOR (dB /m)	CABLE LOSS (dB)	PREAMP FACTOR (dB)	ANTENNA HEIGHT (cm)	TABLE ANGLE (Degree)	REMARK
5150	55.02	57.33	74	-18.98	34.52	9.52	46.35	100	340	Peak
5150	49.07	51.38	54	-4.93	34.52	9.52	46.35	100	340	Average
5200	100.22	102.38	/	/	34.56	9.62	46.34	100	340	Peak
5200	93.66	95.82	/	/	34.56	9.62	46.34	100	340	Average
5350	54.08	55.76	74	-19.92	34.68	9.94	46.3	100	340	Peak
5350	48.05	49.73	54	-5.95	34.68	9.94	46.3	100	340	Average

ANTENNA POLARITY & TEST DISTANCE: VERTICAL AT 3 M										
FREQ. (MHz)	EMISSION LEVEL (dBuV/m)	READ LEVEL (dBuV)	LIMIT (dBuV/m)	MARGIN (dB)	ANTENNA FACTOR (dB /m)	CABLE LOSS (dB)	PREAMP FACTOR (dB)	ANTENNA HEIGHT (cm)	TABLE ANGLE (Degree)	REMARK
5150	57.58	59.81	74	-16.42	34.6	9.52	46.35	100	110	Peak
5150	49.75	51.98	54	-4.25	34.6	9.52	46.35	100	110	Average
5200	97.25	99.37	/	/	34.6	9.62	46.34	100	110	Peak
5200	89.9	92.02	/	/	34.6	9.62	46.34	100	110	Average
5350	52.92	54.68	74	-21.08	34.6	9.94	46.3	100	110	Peak
5350	47.59	49.35	54	-6.41	34.6	9.94	46.3	100	110	Average

REMARKS:

- Emission Level = Read Level+ Antenna Factor + Cable Loss- Preamp Factor
Margin value = Emission level – Limit value.
- 5200MHz: Fundamental frequency.



CHANNEL	TX Channel 48	DETECTOR FUNCTION	Peak (PK)
FREQUENCY RANGE	1GHz ~ 40GHz		Average (AV)

ANTENNA POLARITY & TEST DISTANCE: HORIZONTAL AT 3 M

FREQ. (MHz)	EMISSION LEVEL (dBuV/m)	READ LEVEL (dBuV)	LIMIT (dBuV/m)	MARGIN (dB)	ANTENNA FACTOR (dB /m)	CABLE LOSS (dB)	PREAMP FACTOR (dB)	ANTENNA HEIGHT (cm)	TABLE ANGLE (Degree)	REMARK
5150	55.63	57.94	74	-18.37	34.52	9.52	46.35	100	340	Peak
5150	49.21	51.52	54	-4.79	34.52	9.52	46.35	100	340	Average
5240	102.15	104.18	/	/	34.59	9.71	46.33	100	340	Peak
5240	97.44	99.47	/	/	34.59	9.71	46.33	100	340	Average
5350	55.6	57.28	74	-18.4	34.68	9.94	46.3	100	340	Peak
5350	48.78	50.46	54	-5.22	34.68	9.94	46.3	100	340	Average

ANTENNA POLARITY & TEST DISTANCE: VERTICAL AT 3 M

FREQ. (MHz)	EMISSION LEVEL (dBuV/m)	READ LEVEL (dBuV)	LIMIT (dBuV/m)	MARGIN (dB)	ANTENNA FACTOR (dB /m)	CABLE LOSS (dB)	PREAMP FACTOR (dB)	ANTENNA HEIGHT (cm)	TABLE ANGLE (Degree)	REMARK
5150	57.41	59.64	74	-16.59	34.6	9.52	46.35	100	110	Peak
5150	49.3	51.53	54	-4.7	34.6	9.52	46.35	100	110	Average
5240	96.59	98.61	/	/	34.6	9.71	46.33	100	110	Peak
5240	89.34	91.36	/	/	34.6	9.71	46.33	100	110	Average
5350	54.4	56.16	74	-19.6	34.6	9.94	46.3	100	110	Peak
5350	48.54	50.3	54	-5.46	34.6	9.94	46.3	100	110	Average

REMARKS:

- Emission Level = Read Level+ Antenna Factor + Cable Loss- Preamp Factor
Margin value = Emission level – Limit value.
- 5240MHz: Fundamental frequency.



802.11n (20MHz)

CHANNEL	TX Channel 36	DETECTOR FUNCTION	Peak (PK)
FREQUENCY RANGE	1GHz ~ 40GHz		Average (AV)

ANTENNA POLARITY & TEST DISTANCE: HORIZONTAL AT 3 M

FREQ. (MHz)	EMISSION LEVEL (dBuV/m)	READ LEVEL (dBuV)	LIMIT (dBuV/m)	MARGIN (dB)	ANTENNA FACTOR (dB /m)	CABLE LOSS (dB)	PREAMP FACTOR (dB)	ANTENNA HEIGHT (cm)	TABLE ANGLE (Degree)	REMARK
5150	55.19	57.5	74	-18.81	34.52	9.52	46.35	100	340	Peak
5150	49.89	52.2	54	-4.11	34.52	9.52	46.35	100	340	Average
5180	100.24	102.47	/	/	34.54	9.58	46.35	100	340	Peak
5180	92.43	94.66	/	/	34.54	9.58	46.35	100	340	Average
5350	56.81	58.49	74	-17.19	34.68	9.94	46.3	100	340	Peak
5350	48.51	50.19	54	-5.49	34.68	9.94	46.3	100	340	Average

ANTENNA POLARITY & TEST DISTANCE: VERTICAL AT 3 M

FREQ. (MHz)	EMISSION LEVEL (dBuV/m)	READ LEVEL (dBuV)	LIMIT (dBuV/m)	MARGIN (dB)	ANTENNA FACTOR (dB /m)	CABLE LOSS (dB)	PREAMP FACTOR (dB)	ANTENNA HEIGHT (cm)	TABLE ANGLE (Degree)	REMARK
5150	54.85	57.08	74	-19.15	34.6	9.52	46.35	100	110	Peak
5150	49.49	51.72	54	-4.51	34.6	9.52	46.35	100	110	Average
5180	96.19	98.36	/	/	34.6	9.58	46.35	100	110	Peak
5180	88.64	90.81	/	/	34.6	9.58	46.35	100	110	Average
5350	55.67	57.43	74	-18.33	34.6	9.94	46.3	100	110	Peak
5350	48.31	50.07	54	-5.69	34.6	9.94	46.3	100	110	Average

REMARKS:

- Emission Level = Read Level+ Antenna Factor + Cable Loss- Preamp Factor
Margin value = Emission level – Limit value.
- 5180MHz: Fundamental frequency.



CHANNEL	TX Channel 40	DETECTOR FUNCTION	Peak (PK)
FREQUENCY RANGE	1GHz ~ 40GHz		Average (AV)

ANTENNA POLARITY & TEST DISTANCE: HORIZONTAL AT 3 M

FREQ. (MHz)	EMISSION LEVEL (dBuV/m)	READ LEVEL (dBuV)	LIMIT (dBuV/m)	MARGIN (dB)	ANTENNA FACTOR (dB /m)	CABLE LOSS (dB)	PREAMP FACTOR (dB)	ANTENNA HEIGHT (cm)	TABLE ANGLE (Degree)	REMARK
5150	57.02	59.33	74	-16.98	34.52	9.52	46.35	100	340	Peak
5150	49.24	51.55	54	-4.76	34.52	9.52	46.35	100	340	Average
5200	100.08	102.24	/	/	34.56	9.62	46.34	100	340	Peak
5200	94	96.16	/	/	34.56	9.62	46.34	100	340	Average
5350	55.94	57.62	74	-18.06	34.68	9.94	46.3	100	340	Peak
5350	48.08	49.76	54	-5.92	34.68	9.94	46.3	100	340	Average

ANTENNA POLARITY & TEST DISTANCE: VERTICAL AT 3 M

FREQ. (MHz)	EMISSION LEVEL (dBuV/m)	READ LEVEL (dBuV)	LIMIT (dBuV/m)	MARGIN (dB)	ANTENNA FACTOR (dB /m)	CABLE LOSS (dB)	PREAMP FACTOR (dB)	ANTENNA HEIGHT (cm)	TABLE ANGLE (Degree)	REMARK
5150	54.58	56.81	74	-19.42	34.6	9.52	46.35	100	110	Peak
5150	49.38	51.61	54	-4.62	34.6	9.52	46.35	100	110	Average
5200	95.47	97.59	/	/	34.6	9.62	46.34	100	110	Peak
5200	88.58	90.7	/	/	34.6	9.62	46.34	100	110	Average
5350	55.66	57.42	74	-18.34	34.6	9.94	46.3	100	110	Peak
5350	48.28	50.04	54	-5.72	34.6	9.94	46.3	100	110	Average

REMARKS:

- Emission Level = Read Level+ Antenna Factor + Cable Loss- Preamp Factor
Margin value = Emission level – Limit value.
- 5200MHz: Fundamental frequency.



CHANNEL	TX Channel 48	DETECTOR FUNCTION	Peak (PK)
FREQUENCY RANGE	1GHz ~ 40GHz		Average (AV)

ANTENNA POLARITY & TEST DISTANCE: HORIZONTAL AT 3 M

FREQ. (MHz)	EMISSION LEVEL (dBuV/m)	READ LEVEL (dBuV)	LIMIT (dBuV/m)	MARGIN (dB)	ANTENNA FACTOR (dB /m)	CABLE LOSS (dB)	PREAMP FACTOR (dB)	ANTENNA HEIGHT (cm)	TABLE ANGLE (Degree)	REMARK
5150	55.52	57.83	74	-18.48	34.52	9.52	46.35	100	340	Peak
5150	48.58	50.89	54	-5.42	34.52	9.52	46.35	100	340	Average
5240	101.52	103.55	/	/	34.59	9.71	46.33	100	340	Peak
5240	95.14	97.17	/	/	34.59	9.71	46.33	100	340	Average
5350	53.24	54.92	74	-20.76	34.68	9.94	46.3	100	340	Peak
5350	48.15	49.83	54	-5.85	34.68	9.94	46.3	100	340	Average

ANTENNA POLARITY & TEST DISTANCE: VERTICAL AT 3 M

FREQ. (MHz)	EMISSION LEVEL (dBuV/m)	READ LEVEL (dBuV)	LIMIT (dBuV/m)	MARGIN (dB)	ANTENNA FACTOR (dB /m)	CABLE LOSS (dB)	PREAMP FACTOR (dB)	ANTENNA HEIGHT (cm)	TABLE ANGLE (Degree)	REMARK
5150	55.4	57.63	74	-18.6	34.6	9.52	46.35	100	115	Peak
5150	49.34	51.57	54	-4.66	34.6	9.52	46.35	100	115	Average
5240	97.46	99.48	/	/	34.6	9.71	46.33	100	115	Peak
5240	89.66	91.68	/	/	34.6	9.71	46.33	100	115	Average
5350	53.59	55.35	74	-20.41	34.6	9.94	46.3	100	115	Peak
5350	48.28	50.04	54	-5.72	34.6	9.94	46.3	100	115	Average

REMARKS:

- Emission Level = Read Level+ Antenna Factor + Cable Loss- Preamp Factor
Margin value = Emission level – Limit value.
- 5240MHz: Fundamental frequency.



802.11n (40MHz)

CHANNEL	TX Channel 38	DETECTOR FUNCTION	Peak (PK)
FREQUENCY RANGE	1GHz ~ 40GHz		Average (AV)

ANTENNA POLARITY & TEST DISTANCE: HORIZONTAL AT 3 M										
FREQ. (MHz)	EMISSION LEVEL (dBuV/m)	READ LEVEL (dBuV)	LIMIT (dBuV/m)	MARGIN (dB)	ANTENNA FACTOR (dB /m)	CABLE LOSS (dB)	PREAMP FACTOR (dB)	ANTENNA HEIGHT (cm)	TABLE ANGLE (Degree)	REMARK
5150	57.27	59.58	74	-16.73	34.52	9.52	46.35	103	340	Peak
5150	50.84	53.15	54	-3.16	34.52	9.52	46.35	103	340	Average
5190	98.28	100.47	/	/	34.55	9.6	46.34	103	340	Peak
5190	91.38	93.57	/	/	34.55	9.6	46.34	103	340	Average
5350	53.58	55.26	74	-20.42	34.68	9.94	46.3	103	340	Peak
5350	48.6	50.28	54	-5.4	34.68	9.94	46.3	103	340	Average

ANTENNA POLARITY & TEST DISTANCE: VERTICAL AT 3 M										
FREQ. (MHz)	EMISSION LEVEL (dBuV/m)	READ LEVEL (dBuV)	LIMIT (dBuV/m)	MARGIN (dB)	ANTENNA FACTOR (dB /m)	CABLE LOSS (dB)	PREAMP FACTOR (dB)	ANTENNA HEIGHT (cm)	TABLE ANGLE (Degree)	REMARK
5150	55.39	57.62	74	-18.61	34.6	9.52	46.35	115	120	Peak
5150	50.24	52.47	54	-3.76	34.6	9.52	46.35	115	120	Average
5190	93.12	95.26	/	/	34.6	9.6	46.34	115	120	Peak
5190	85.73	87.87	/	/	34.6	9.6	46.34	115	120	Average
5350	53.93	55.69	74	-20.07	34.6	9.94	46.3	115	120	Peak
5350	48.87	50.63	54	-5.13	34.6	9.94	46.3	115	120	Average

REMARKS:

- Emission Level = Read Level+ Antenna Factor + Cable Loss- Preamp Factor
Margin value = Emission level – Limit value.
- 5190MHz: Fundamental frequency.



CHANNEL	TX Channel 46	DETECTOR FUNCTION	Peak (PK)
FREQUENCY RANGE	1GHz ~ 40GHz		Average (AV)

ANTENNA POLARITY & TEST DISTANCE: HORIZONTAL AT 3 M

FREQ. (MHz)	EMISSION LEVEL (dBuV/m)	READ LEVEL (dBuV)	LIMIT (dBuV/m)	MARGIN (dB)	ANTENNA FACTOR (dB /m)	CABLE LOSS (dB)	PREAMP FACTOR (dB)	ANTENNA HEIGHT (cm)	TABLE ANGLE (Degree)	REMARK
5150	56.62	58.93	74	-17.38	34.52	9.52	46.35	103	340	Peak
5150	49.86	52.17	54	-4.14	34.52	9.52	46.35	103	340	Average
5230	99.26	101.32	/	/	34.58	9.69	46.33	103	340	Peak
5230	92.97	95.03	/	/	34.58	9.69	46.33	103	340	Average
5350	55.85	57.53	74	-18.15	34.68	9.94	46.3	103	340	Peak
5350	48.85	50.53	54	-5.15	34.68	9.94	46.3	103	340	Average

ANTENNA POLARITY & TEST DISTANCE: VERTICAL AT 3 M

FREQ. (MHz)	EMISSION LEVEL (dBuV/m)	READ LEVEL (dBuV)	LIMIT (dBuV/m)	MARGIN (dB)	ANTENNA FACTOR (dB /m)	CABLE LOSS (dB)	PREAMP FACTOR (dB)	ANTENNA HEIGHT (cm)	TABLE ANGLE (Degree)	REMARK
5150	56.03	58.26	74	-17.97	34.6	9.52	46.35	100	120	Peak
5150	48.93	51.16	54	-5.07	34.6	9.52	46.35	100	120	Average
5230	92.72	94.76	/	/	34.6	9.69	46.33	100	120	Peak
5230	86.96	89	/	/	34.6	9.69	46.33	100	120	Average
5350	54.94	56.7	74	-19.06	34.6	9.94	46.3	100	120	Peak
5350	48.59	50.35	54	-5.41	34.6	9.94	46.3	100	120	Average

REMARKS:

- Emission Level = Read Level+ Antenna Factor + Cable Loss- Preamp Factor
Margin value = Emission level – Limit value.
- 5230MHz: Fundamental frequency.



802.11ac (20MHz)

CHANNEL	TX Channel 36	DETECTOR FUNCTION	Peak (PK)
FREQUENCY RANGE	1GHz ~ 40GHz		Average (AV)

ANTENNA POLARITY & TEST DISTANCE: HORIZONTAL AT 3 M

FREQ. (MHz)	EMISSION LEVEL (dBuV/m)	READ LEVEL (dBuV)	LIMIT (dBuV/m)	MARGIN (dB)	ANTENNA FACTOR (dB /m)	CABLE LOSS (dB)	PREAMP FACTOR (dB)	ANTENNA HEIGHT (cm)	TABLE ANGLE (Degree)	REMARK
5150	57.84	60.15	74	-16.16	34.52	9.52	46.35	103	340	Peak
5150	49.52	51.83	54	-4.48	34.52	9.52	46.35	103	340	Average
5180	102.17	104.4	/	/	34.54	9.58	46.35	103	340	Peak
5180	95.12	97.35	/	/	34.54	9.58	46.35	103	340	Average
5350	54.77	56.45	74	-19.23	34.68	9.94	46.3	103	340	Peak
5350	49.23	50.91	54	-4.77	34.68	9.94	46.3	103	340	Average

ANTENNA POLARITY & TEST DISTANCE: VERTICAL AT 3 M

FREQ. (MHz)	EMISSION LEVEL (dBuV/m)	READ LEVEL (dBuV)	LIMIT (dBuV/m)	MARGIN (dB)	ANTENNA FACTOR (dB /m)	CABLE LOSS (dB)	PREAMP FACTOR (dB)	ANTENNA HEIGHT (cm)	TABLE ANGLE (Degree)	REMARK
5150	55.55	57.78	74	-18.45	34.6	9.52	46.35	100	120	Peak
5150	49.18	51.41	54	-4.82	34.6	9.52	46.35	100	120	Average
5180	98.67	100.84	/	/	34.6	9.58	46.35	100	120	Peak
5180	90.65	92.82	/	/	34.6	9.58	46.35	100	120	Average
5350	55.86	57.62	74	-18.14	34.6	9.94	46.3	100	120	Peak
5350	48.05	49.81	54	-5.95	34.6	9.94	46.3	100	120	Average

REMARKS:

- Emission Level = Read Level+ Antenna Factor + Cable Loss- Preamp Factor
Margin value = Emission level – Limit value.
- 5180MHz: Fundamental frequency.



CHANNEL	TX Channel 40	DETECTOR FUNCTION	Peak (PK)
FREQUENCY RANGE	1GHz ~ 40GHz		Average (AV)

ANTENNA POLARITY & TEST DISTANCE: HORIZONTAL AT 3 M

FREQ. (MHz)	EMISSION LEVEL (dBuV/m)	READ LEVEL (dBuV)	LIMIT (dBuV/m)	MARGIN (dB)	ANTENNA FACTOR (dB /m)	CABLE LOSS (dB)	PREAMP FACTOR (dB)	ANTENNA HEIGHT (cm)	TABLE ANGLE (Degree)	REMARK
5150	54.86	57.17	74	-19.14	34.52	9.52	46.35	103	340	Peak
5150	50.12	52.43	54	-3.88	34.52	9.52	46.35	103	340	Average
5200	102.13	104.29	/	/	34.56	9.62	46.34	103	340	Peak
5200	95.88	98.04	/	/	34.56	9.62	46.34	103	340	Average
5350	54.16	55.84	74	-19.84	34.68	9.94	46.3	103	340	Peak
5350	48.07	49.75	54	-5.93	34.68	9.94	46.3	103	340	Average

ANTENNA POLARITY & TEST DISTANCE: VERTICAL AT 3 M

FREQ. (MHz)	EMISSION LEVEL (dBuV/m)	READ LEVEL (dBuV)	LIMIT (dBuV/m)	MARGIN (dB)	ANTENNA FACTOR (dB /m)	CABLE LOSS (dB)	PREAMP FACTOR (dB)	ANTENNA HEIGHT (cm)	TABLE ANGLE (Degree)	REMARK
5150	54.64	56.87	74	-19.36	34.6	9.52	46.35	100	120	Peak
5150	49.2	51.43	54	-4.8	34.6	9.52	46.35	100	120	Average
5200	97.13	99.25	/	/	34.6	9.62	46.34	100	120	Peak
5200	90.39	92.51	/	/	34.6	9.62	46.34	100	120	Average
5350	54.21	55.97	74	-19.79	34.6	9.94	46.3	100	120	Peak
5350	48.2	49.96	54	-5.8	34.6	9.94	46.3	100	120	Average

REMARKS:

- Emission Level = Read Level+ Antenna Factor + Cable Loss- Preamp Factor
Margin value = Emission level – Limit value.
- 5200MHz: Fundamental frequency.



CHANNEL	TX Channel 48	DETECTOR FUNCTION	Peak (PK)
FREQUENCY RANGE	1GHz ~ 40GHz		Average (AV)

ANTENNA POLARITY & TEST DISTANCE: HORIZONTAL AT 3 M

FREQ. (MHz)	EMISSION LEVEL (dBuV/m)	READ LEVEL (dBuV)	LIMIT (dBuV/m)	MARGIN (dB)	ANTENNA FACTOR (dB /m)	CABLE LOSS (dB)	PREAMP FACTOR (dB)	ANTENNA HEIGHT (cm)	TABLE ANGLE (Degree)	REMARK
5150	55.36	57.67	74	-18.64	34.52	9.52	46.35	100	340	Peak
5150	49.37	51.68	54	-4.63	34.52	9.52	46.35	100	340	Average
5240	100.7	102.73	/	/	34.59	9.71	46.33	100	340	Peak
5240	95.97	98	/	/	34.59	9.71	46.33	100	340	Average
5350	57.09	58.77	74	-16.91	34.68	9.94	46.3	100	340	Peak
5350	48.52	50.2	54	-5.48	34.68	9.94	46.3	100	340	Average

ANTENNA POLARITY & TEST DISTANCE: VERTICAL AT 3 M

FREQ. (MHz)	EMISSION LEVEL (dBuV/m)	READ LEVEL (dBuV)	LIMIT (dBuV/m)	MARGIN (dB)	ANTENNA FACTOR (dB /m)	CABLE LOSS (dB)	PREAMP FACTOR (dB)	ANTENNA HEIGHT (cm)	TABLE ANGLE (Degree)	REMARK
5150	55.37	57.6	74	-18.63	34.6	9.52	46.35	100	120	Peak
5150	48.76	50.99	54	-5.24	34.6	9.52	46.35	100	120	Average
5240	96.69	98.71	/	/	34.6	9.71	46.33	100	120	Peak
5240	90.24	92.26	/	/	34.6	9.71	46.33	100	120	Average
5350	55.05	56.81	74	-18.95	34.6	9.94	46.3	100	120	Peak
5350	48.27	50.03	54	-5.73	34.6	9.94	46.3	100	120	Average

REMARKS:

- Emission Level = Read Level+ Antenna Factor + Cable Loss- Preamp Factor
Margin value = Emission level – Limit value.
- 5240MHz: Fundamental frequency.



802.11ac (40MHz)

CHANNEL	TX Channel 38	DETECTOR FUNCTION	Peak (PK)
FREQUENCY RANGE	1GHz ~ 40GHz		Average (AV)

ANTENNA POLARITY & TEST DISTANCE: HORIZONTAL AT 3 M

FREQ. (MHz)	EMISSION LEVEL (dBuV/m)	READ LEVEL (dBuV)	LIMIT (dBuV/m)	MARGIN (dB)	ANTENNA FACTOR (dB /m)	CABLE LOSS (dB)	PREAMP FACTOR (dB)	ANTENNA HEIGHT (cm)	TABLE ANGLE (Degree)	REMARK
5150	57.69	60	74	-16.31	34.52	9.52	46.35	103	340	Peak
5150	50.7	53.01	54	-3.3	34.52	9.52	46.35	103	340	Average
5190	97.88	100.07	/	/	34.55	9.6	46.34	103	340	Peak
5190	92.08	94.27	/	/	34.55	9.6	46.34	103	340	Average
5350	54.19	55.87	74	-19.81	34.68	9.94	46.3	103	340	Peak
5350	49.13	50.81	54	-4.87	34.68	9.94	46.3	103	340	Average

ANTENNA POLARITY & TEST DISTANCE: VERTICAL AT 3 M

FREQ. (MHz)	EMISSION LEVEL (dBuV/m)	READ LEVEL (dBuV)	LIMIT (dBuV/m)	MARGIN (dB)	ANTENNA FACTOR (dB /m)	CABLE LOSS (dB)	PREAMP FACTOR (dB)	ANTENNA HEIGHT (cm)	TABLE ANGLE (Degree)	REMARK
5150	57.09	59.32	74	-16.91	34.6	9.52	46.35	100	120	Peak
5150	49.89	52.12	54	-4.11	34.6	9.52	46.35	100	120	Average
5190	93.25	95.39	/	/	34.6	9.6	46.34	100	120	Peak
5190	86.56	88.7	/	/	34.6	9.6	46.34	100	120	Average
5350	53.81	55.57	74	-20.19	34.6	9.94	46.3	100	120	Peak
5350	48.23	49.99	54	-5.77	34.6	9.94	46.3	100	120	Average

REMARKS:

- Emission Level = Read Level+ Antenna Factor + Cable Loss- Preamp Factor
Margin value = Emission level – Limit value.
- 5190MHz: Fundamental frequency.



CHANNEL	TX Channel 46	DETECTOR FUNCTION	Peak (PK)
FREQUENCY RANGE	1GHz ~ 40GHz		Average (AV)

ANTENNA POLARITY & TEST DISTANCE: HORIZONTAL AT 3 M

FREQ. (MHz)	EMISSION LEVEL (dBuV/m)	READ LEVEL (dBuV)	LIMIT (dBuV/m)	MARGIN (dB)	ANTENNA FACTOR (dB /m)	CABLE LOSS (dB)	PREAMP FACTOR (dB)	ANTENNA HEIGHT (cm)	TABLE ANGLE (Degree)	REMARK
5150	54.28	56.59	74	-19.72	34.52	9.52	46.35	103	340	Peak
5150	49.91	52.22	54	-4.09	34.52	9.52	46.35	103	340	Average
5230	96.6	98.66	/	/	34.58	9.69	46.33	103	340	Peak
5230	92.43	94.49	/	/	34.58	9.69	46.33	103	340	Average
5350	54.74	56.42	74	-19.26	34.68	9.94	46.3	103	340	Peak
5350	48.37	50.05	54	-5.63	34.68	9.94	46.3	103	340	Average

ANTENNA POLARITY & TEST DISTANCE: VERTICAL AT 3 M

FREQ. (MHz)	EMISSION LEVEL (dBuV/m)	READ LEVEL (dBuV)	LIMIT (dBuV/m)	MARGIN (dB)	ANTENNA FACTOR (dB /m)	CABLE LOSS (dB)	PREAMP FACTOR (dB)	ANTENNA HEIGHT (cm)	TABLE ANGLE (Degree)	REMARK
5150	53.92	56.15	74	-20.08	34.6	9.52	46.35	100	120	Peak
5150	49.1	51.33	54	-4.9	34.6	9.52	46.35	100	120	Average
5230	91.99	94.03	/	/	34.6	9.69	46.33	100	120	Peak
5230	86.03	88.07	/	/	34.6	9.69	46.33	100	120	Average
5350	54.3	56.06	74	-19.7	34.6	9.94	46.3	100	120	Peak
5350	48.59	50.35	54	-5.41	34.6	9.94	46.3	100	120	Average

REMARKS:

- Emission Level = Read Level+ Antenna Factor + Cable Loss- Preamp Factor
Margin value = Emission level – Limit value.
- 5230MHz: Fundamental frequency.



802.11ac (80MHz)

CHANNEL	TX Channel 42	DETECTOR FUNCTION	Peak (PK)
FREQUENCY RANGE	1GHz ~ 40GHz		Average (AV)

ANTENNA POLARITY & TEST DISTANCE: HORIZONTAL AT 3 M										
FREQ. (MHz)	EMISSION LEVEL (dBuV/m)	READ LEVEL (dBuV)	LIMIT (dBuV/m)	MARGIN (dB)	ANTENNA FACTOR (dB /m)	CABLE LOSS (dB)	PREAMP FACTOR (dB)	ANTENNA HEIGHT (cm)	TABLE ANGLE (Degree)	REMARK
5150	55.06	57.37	74	-18.94	34.52	9.52	46.35	103	340	Peak
5150	50.89	53.2	54	-3.11	34.52	9.52	46.35	103	340	Average
5210	92.08	94.21	/	/	34.57	9.64	46.34	103	340	Peak
5210	87.26	89.39	/	/	34.57	9.64	46.34	103	340	Average
5350	53.98	55.66	74	-20.02	34.68	9.94	46.3	103	340	Peak
5350	49.28	50.96	54	-4.72	34.68	9.94	46.3	103	340	Average

ANTENNA POLARITY & TEST DISTANCE: VERTICAL AT 3 M										
FREQ. (MHz)	EMISSION LEVEL (dBuV/m)	READ LEVEL (dBuV)	LIMIT (dBuV/m)	MARGIN (dB)	ANTENNA FACTOR (dB /m)	CABLE LOSS (dB)	PREAMP FACTOR (dB)	ANTENNA HEIGHT (cm)	TABLE ANGLE (Degree)	REMARK
5150	54.74	56.97	74	-19.26	34.6	9.52	46.35	100	120	Peak
5150	50.63	52.86	54	-3.37	34.6	9.52	46.35	100	120	Average
5210	88.44	90.54	/	/	34.6	9.64	46.34	100	120	Peak
5210	83.2	85.3	/	/	34.6	9.64	46.34	100	120	Average
5350	53.27	55.03	74	-20.73	34.6	9.94	46.3	100	120	Peak
5350	49.12	50.88	54	-4.88	34.6	9.94	46.3	100	120	Average

REMARKS:

- Emission Level = Read Level+ Antenna Factor + Cable Loss- Preamp Factor
Margin value = Emission level – Limit value.
- 5210MHz: Fundamental frequency.



Band 2

802.11a

CHANNEL	TX Channel 52	DETECTOR FUNCTION	Peak (PK)
FREQUENCY RANGE	1GHz ~ 40GHz		Average (AV)

ANTENNA POLARITY & TEST DISTANCE: HORIZONTAL AT 3 M

FREQ. (MHz)	EMISSION LEVEL (dBuV/m)	READ LEVEL (dBuV)	LIMIT (dBuV/m)	MARGIN (dB)	ANTENNA FACTOR (dB /m)	CABLE LOSS (dB)	PREAMP FACTOR (dB)	ANTENNA HEIGHT (cm)	TABLE ANGLE (Degree)	REMARK
5150	55.38	57.69	74	-18.62	34.52	9.52	46.35	100	340	Peak
5150	49.14	51.45	54	-4.86	34.52	9.52	46.35	100	340	Average
5260	102.49	104.45	/	/	34.61	9.75	46.32	100	340	Peak
5260	96.5	98.46	/	/	34.61	9.75	46.32	100	340	Average
5350	53.9	55.58	74	-20.1	34.68	9.94	46.3	100	340	Peak
5350	48.66	50.34	54	-5.34	34.68	9.94	46.3	100	340	Average

ANTENNA POLARITY & TEST DISTANCE: VERTICAL AT 3 M

FREQ. (MHz)	EMISSION LEVEL (dBuV/m)	READ LEVEL (dBuV)	LIMIT (dBuV/m)	MARGIN (dB)	ANTENNA FACTOR (dB /m)	CABLE LOSS (dB)	PREAMP FACTOR (dB)	ANTENNA HEIGHT (cm)	TABLE ANGLE (Degree)	REMARK
5150	57.3	59.53	74	-16.7	34.6	9.52	46.35	100	120	Peak
5150	49.06	51.29	54	-4.94	34.6	9.52	46.35	100	120	Average
5260	96.04	98.01	/	/	34.6	9.75	46.32	100	120	Peak
5260	88.76	90.73	/	/	34.6	9.75	46.32	100	120	Average
5350	54.64	56.4	74	-19.36	34.6	9.94	46.3	100	120	Peak
5350	48.61	50.37	54	-5.39	34.6	9.94	46.3	100	120	Average

REMARKS:

- Emission Level = Read Level+ Antenna Factor + Cable Loss- Preamp Factor
Margin value = Emission level – Limit value.
- 5260MHz: Fundamental frequency.



CHANNEL	TX Channel 60	DETECTOR FUNCTION	Peak (PK)
FREQUENCY RANGE	1GHz ~ 40GHz		Average (AV)

ANTENNA POLARITY & TEST DISTANCE: HORIZONTAL AT 3 M

FREQ. (MHz)	EMISSION LEVEL (dBuV/m)	READ LEVEL (dBuV)	LIMIT (dBuV/m)	MARGIN (dB)	ANTENNA FACTOR (dB /m)	CABLE LOSS (dB)	PREAMP FACTOR (dB)	ANTENNA HEIGHT (cm)	TABLE ANGLE (Degree)	REMARK
5150	56.1	58.41	74	-17.9	34.52	9.52	46.35	100	340	Peak
5150	49.31	51.62	54	-4.69	34.52	9.52	46.35	100	340	Average
5300	102.38	104.22	/	/	34.64	9.83	46.31	100	340	Peak
5300	96.43	98.27	/	/	34.64	9.83	46.31	100	340	Average
5350	54.65	56.33	74	-19.35	34.68	9.94	46.3	100	340	Peak
5350	48.89	50.57	54	-5.11	34.68	9.94	46.3	100	340	Average

ANTENNA POLARITY & TEST DISTANCE: VERTICAL AT 3 M

FREQ. (MHz)	EMISSION LEVEL (dBuV/m)	READ LEVEL (dBuV)	LIMIT (dBuV/m)	MARGIN (dB)	ANTENNA FACTOR (dB /m)	CABLE LOSS (dB)	PREAMP FACTOR (dB)	ANTENNA HEIGHT (cm)	TABLE ANGLE (Degree)	REMARK
5150	55.13	57.36	74	-18.87	34.6	9.52	46.35	100	140	Peak
5150	49.06	51.29	54	-4.94	34.6	9.52	46.35	100	140	Average
5300	94.8	96.68	/	/	34.6	9.83	46.31	100	140	Peak
5300	88.11	89.99	/	/	34.6	9.83	46.31	100	140	Average
5350	53.9	55.66	74	-20.1	34.6	9.94	46.3	100	140	Peak
5350	48.6	50.36	54	-5.4	34.6	9.94	46.3	100	140	Average

REMARKS:

- Emission Level = Read Level+ Antenna Factor + Cable Loss- Preamp Factor
Margin value = Emission level – Limit value.
- 5300MHz: Fundamental frequency.



CHANNEL	TX Channel 64	DETECTOR FUNCTION	Peak (PK)
FREQUENCY RANGE	1GHz ~ 40GHz		Average (AV)

ANTENNA POLARITY & TEST DISTANCE: HORIZONTAL AT 3 M

FREQ. (MHz)	EMISSION LEVEL (dBuV/m)	READ LEVEL (dBuV)	LIMIT (dBuV/m)	MARGIN (dB)	ANTENNA FACTOR (dB /m)	CABLE LOSS (dB)	PREAMP FACTOR (dB)	ANTENNA HEIGHT (cm)	TABLE ANGLE (Degree)	REMARK
5150	56.76	59.07	74	-17.24	34.52	9.52	46.35	100	340	Peak
5150	49.52	51.83	54	-4.48	34.52	9.52	46.35	100	340	Average
5320	101.49	103.25	/	/	34.66	9.88	46.3	100	340	Peak
5320	95.44	97.2	/	/	34.66	9.88	46.3	100	340	Average
5350	54.57	56.25	74	-19.43	34.68	9.94	46.3	100	340	Peak
5350	48.89	50.57	54	-5.11	34.68	9.94	46.3	100	340	Average

ANTENNA POLARITY & TEST DISTANCE: VERTICAL AT 3 M

FREQ. (MHz)	EMISSION LEVEL (dBuV/m)	READ LEVEL (dBuV)	LIMIT (dBuV/m)	MARGIN (dB)	ANTENNA FACTOR (dB /m)	CABLE LOSS (dB)	PREAMP FACTOR (dB)	ANTENNA HEIGHT (cm)	TABLE ANGLE (Degree)	REMARK
5150	56.61	58.84	74	-17.39	34.6	9.52	46.35	100	137	Peak
5150	49.61	51.84	54	-4.39	34.6	9.52	46.35	100	137	Average
5320	96.6	98.42	/	/	34.6	9.88	46.3	100	137	Peak
5320	87.06	88.88	/	/	34.6	9.88	46.3	100	137	Average
5350	53.74	55.5	74	-20.26	34.6	9.94	46.3	100	137	Peak
5350	48.98	50.74	54	-5.02	34.6	9.94	46.3	100	137	Average

REMARKS:

- Emission Level = Read Level+ Antenna Factor + Cable Loss- Preamp Factor
Margin value = Emission level – Limit value.
- 5320MHz: Fundamental frequency.



802.11n (20MHz)

CHANNEL	TX Channel 52	DETECTOR FUNCTION	Peak (PK)
FREQUENCY RANGE	1GHz ~ 40GHz		Average (AV)

ANTENNA POLARITY & TEST DISTANCE: HORIZONTAL AT 3 M

FREQ. (MHz)	EMISSION LEVEL (dBuV/m)	READ LEVEL (dBuV)	LIMIT (dBuV/m)	MARGIN (dB)	ANTENNA FACTOR (dB /m)	CABLE LOSS (dB)	PREAMP FACTOR (dB)	ANTENNA HEIGHT (cm)	TABLE ANGLE (Degree)	REMARK
5150	55.15	57.46	74	-18.85	34.52	9.52	46.35	100	340	Peak
5150	49.03	51.34	54	-4.97	34.52	9.52	46.35	100	340	Average
5260	101.69	103.65	/	/	34.61	9.75	46.32	100	340	Peak
5260	96.75	98.71	/	/	34.61	9.75	46.32	100	340	Average
5350	55.19	56.87	74	-18.81	34.68	9.94	46.3	100	340	Peak
5350	48.65	50.33	54	-5.35	34.68	9.94	46.3	100	340	Average

ANTENNA POLARITY & TEST DISTANCE: VERTICAL AT 3 M

FREQ. (MHz)	EMISSION LEVEL (dBuV/m)	READ LEVEL (dBuV)	LIMIT (dBuV/m)	MARGIN (dB)	ANTENNA FACTOR (dB /m)	CABLE LOSS (dB)	PREAMP FACTOR (dB)	ANTENNA HEIGHT (cm)	TABLE ANGLE (Degree)	REMARK
5150	55.01	57.24	74	-18.99	34.6	9.52	46.35	100	120	Peak
5150	49.23	51.46	54	-4.77	34.6	9.52	46.35	100	120	Average
5260	95.41	97.38	/	/	34.6	9.75	46.32	100	120	Peak
5260	88.59	90.56	/	/	34.6	9.75	46.32	100	120	Average
5350	55.14	56.9	74	-18.86	34.6	9.94	46.3	100	120	Peak
5350	48.29	50.05	54	-5.71	34.6	9.94	46.3	100	120	Average

REMARKS:

- Emission Level = Read Level+ Antenna Factor + Cable Loss- Preamp Factor
Margin value = Emission level – Limit value.
- 5260MHz: Fundamental frequency.



CHANNEL	TX Channel 60	DETECTOR FUNCTION	Peak (PK)
FREQUENCY RANGE	1GHz ~ 40GHz		Average (AV)

ANTENNA POLARITY & TEST DISTANCE: HORIZONTAL AT 3 M

FREQ. (MHz)	EMISSION LEVEL (dBuV/m)	READ LEVEL (dBuV)	LIMIT (dBuV/m)	MARGIN (dB)	ANTENNA FACTOR (dB /m)	CABLE LOSS (dB)	PREAMP FACTOR (dB)	ANTENNA HEIGHT (cm)	TABLE ANGLE (Degree)	REMARK
5150	56.74	59.05	74	-17.26	34.52	9.52	46.35	100	340	Peak
5150	49.24	51.55	54	-4.76	34.52	9.52	46.35	100	340	Average
5300	101.87	103.71	/	/	34.64	9.83	46.31	100	340	Peak
5300	95.84	97.68	/	/	34.64	9.83	46.31	100	340	Average
5350	54.25	55.93	74	-19.75	34.68	9.94	46.3	100	340	Peak
5350	48.39	50.07	54	-5.61	34.68	9.94	46.3	100	340	Average

ANTENNA POLARITY & TEST DISTANCE: VERTICAL AT 3 M

FREQ. (MHz)	EMISSION LEVEL (dBuV/m)	READ LEVEL (dBuV)	LIMIT (dBuV/m)	MARGIN (dB)	ANTENNA FACTOR (dB /m)	CABLE LOSS (dB)	PREAMP FACTOR (dB)	ANTENNA HEIGHT (cm)	TABLE ANGLE (Degree)	REMARK
5150	54.66	56.89	74	-19.34	34.6	9.52	46.35	100	135	Peak
5150	50.38	52.61	54	-3.62	34.6	9.52	46.35	100	135	Average
5300	94.8	96.68	/	/	34.6	9.83	46.31	100	135	Peak
5300	88.76	90.64	/	/	34.6	9.83	46.31	100	135	Average
5350	55	56.76	74	-19	34.6	9.94	46.3	100	135	Peak
5350	48.16	49.92	54	-5.84	34.6	9.94	46.3	100	135	Average

REMARKS:

- Emission Level = Read Level+ Antenna Factor + Cable Loss- Preamp Factor
Margin value = Emission level – Limit value.
- 5300MHz: Fundamental frequency.



CHANNEL	TX Channel 64	DETECTOR FUNCTION	Peak (PK)
FREQUENCY RANGE	1GHz ~ 40GHz		Average (AV)

ANTENNA POLARITY & TEST DISTANCE: HORIZONTAL AT 3 M

FREQ. (MHz)	EMISSION LEVEL (dBuV/m)	READ LEVEL (dBuV)	LIMIT (dBuV/m)	MARGIN (dB)	ANTENNA FACTOR (dB /m)	CABLE LOSS (dB)	PREAMP FACTOR (dB)	ANTENNA HEIGHT (cm)	TABLE ANGLE (Degree)	REMARK
5150	56.09	58.4	74	-17.91	34.52	9.52	46.35	100	340	Peak
5150	48.6	50.91	54	-5.4	34.52	9.52	46.35	100	340	Average
5320	101.78	103.54	/	/	34.66	9.88	46.3	100	340	Peak
5320	94.95	96.71	/	/	34.66	9.88	46.3	100	340	Average
5350	56.89	58.57	74	-17.11	34.68	9.94	46.3	100	340	Peak
5350	49.49	51.17	54	-4.51	34.68	9.94	46.3	100	340	Average

ANTENNA POLARITY & TEST DISTANCE: VERTICAL AT 3 M

FREQ. (MHz)	EMISSION LEVEL (dBuV/m)	READ LEVEL (dBuV)	LIMIT (dBuV/m)	MARGIN (dB)	ANTENNA FACTOR (dB /m)	CABLE LOSS (dB)	PREAMP FACTOR (dB)	ANTENNA HEIGHT (cm)	TABLE ANGLE (Degree)	REMARK
5150	54.14	56.37	74	-19.86	34.6	9.52	46.35	100	135	Peak
5150	49.35	51.58	54	-4.65	34.6	9.52	46.35	100	135	Average
5320	93.29	95.11	/	/	34.6	9.88	46.3	100	135	Peak
5320	85.79	87.61	/	/	34.6	9.88	46.3	100	135	Average
5350	53.81	55.57	74	-20.19	34.6	9.94	46.3	100	135	Peak
5350	48.35	50.11	54	-5.65	34.6	9.94	46.3	100	135	Average

REMARKS:

- Emission Level = Read Level+ Antenna Factor + Cable Loss- Preamp Factor
Margin value = Emission level – Limit value.
- 5320MHz: Fundamental frequency.



802.11n (40MHz)

CHANNEL	TX Channel 54	DETECTOR FUNCTION	Peak (PK)
FREQUENCY RANGE	1GHz ~ 40GHz		Average (AV)

ANTENNA POLARITY & TEST DISTANCE: HORIZONTAL AT 3 M										
FREQ. (MHz)	EMISSION LEVEL (dBuV/m)	READ LEVEL (dBuV)	LIMIT (dBuV/m)	MARGIN (dB)	ANTENNA FACTOR (dB /m)	CABLE LOSS (dB)	PREAMP FACTOR (dB)	ANTENNA HEIGHT (cm)	TABLE ANGLE (Degree)	REMARK
5150	56.49	58.8	74	-17.51	34.52	9.52	46.35	100	340	Peak
5150	49.23	51.54	54	-4.77	34.52	9.52	46.35	100	340	Average
5270	97.92	99.85	/	/	34.62	9.77	46.32	100	340	Peak
5270	92.75	94.68	/	/	34.62	9.77	46.32	100	340	Average
5350	56.11	57.79	74	-17.89	34.68	9.94	46.3	100	340	Peak
5350	48.81	50.49	54	-5.19	34.68	9.94	46.3	100	340	Average

ANTENNA POLARITY & TEST DISTANCE: VERTICAL AT 3 M										
FREQ. (MHz)	EMISSION LEVEL (dBuV/m)	READ LEVEL (dBuV)	LIMIT (dBuV/m)	MARGIN (dB)	ANTENNA FACTOR (dB /m)	CABLE LOSS (dB)	PREAMP FACTOR (dB)	ANTENNA HEIGHT (cm)	TABLE ANGLE (Degree)	REMARK
5150	55.08	57.31	74	-18.92	34.6	9.52	46.35	100	137	Peak
5150	49.83	52.06	54	-4.17	34.6	9.52	46.35	100	137	Average
5270	92.06	94.01	/	/	34.6	9.77	46.32	100	137	Peak
5270	86.46	88.41	/	/	34.6	9.77	46.32	100	137	Average
5350	54.84	56.6	74	-19.16	34.6	9.94	46.3	100	137	Peak
5350	48.5	50.26	54	-5.5	34.6	9.94	46.3	100	137	Average

REMARKS:

- Emission Level = Read Level+ Antenna Factor + Cable Loss- Preamp Factor
Margin value = Emission level – Limit value.
- 5270MHz: Fundamental frequency.



CHANNEL	TX Channel 62	DETECTOR FUNCTION	Peak (PK)
FREQUENCY RANGE	1GHz ~ 40GHz		Average (AV)

ANTENNA POLARITY & TEST DISTANCE: HORIZONTAL AT 3 M

FREQ. (MHz)	EMISSION LEVEL (dBuV/m)	READ LEVEL (dBuV)	LIMIT (dBuV/m)	MARGIN (dB)	ANTENNA FACTOR (dB /m)	CABLE LOSS (dB)	PREAMP FACTOR (dB)	ANTENNA HEIGHT (cm)	TABLE ANGLE (Degree)	REMARK
5150	54.89	57.2	74	-19.11	34.52	9.52	46.35	100	340	Peak
5150	49.87	52.18	54	-4.13	34.52	9.52	46.35	100	340	Average
5310	96.54	98.35	/	/	34.65	9.85	46.31	100	340	Peak
5310	92.64	94.45	/	/	34.65	9.85	46.31	100	340	Average
5350	54.51	56.19	74	-19.49	34.68	9.94	46.3	100	340	Peak
5350	49.39	51.07	54	-4.61	34.68	9.94	46.3	100	340	Average

ANTENNA POLARITY & TEST DISTANCE: VERTICAL AT 3 M

FREQ. (MHz)	EMISSION LEVEL (dBuV/m)	READ LEVEL (dBuV)	LIMIT (dBuV/m)	MARGIN (dB)	ANTENNA FACTOR (dB /m)	CABLE LOSS (dB)	PREAMP FACTOR (dB)	ANTENNA HEIGHT (cm)	TABLE ANGLE (Degree)	REMARK
5150	55.34	57.57	74	-18.66	34.6	9.52	46.35	100	137	Peak
5150	50.1	52.33	54	-3.9	34.6	9.52	46.35	100	137	Average
5310	92.86	94.72	/	/	34.6	9.85	46.31	100	137	Peak
5310	86.84	88.7	/	/	34.6	9.85	46.31	100	137	Average
5350	54.93	56.69	74	-19.07	34.6	9.94	46.3	100	137	Peak
5350	48.7	50.46	54	-5.3	34.6	9.94	46.3	100	137	Average

REMARKS:

- Emission Level = Read Level+ Antenna Factor + Cable Loss- Preamp Factor
Margin value = Emission level – Limit value.
- 5310MHz: Fundamental frequency.



802.11ac (20MHz)

CHANNEL	TX Channel 52	DETECTOR FUNCTION	Peak (PK)
FREQUENCY RANGE	1GHz ~ 40GHz		Average (AV)

ANTENNA POLARITY & TEST DISTANCE: HORIZONTAL AT 3 M

FREQ. (MHz)	EMISSION LEVEL (dBuV/m)	READ LEVEL (dBuV)	LIMIT (dBuV/m)	MARGIN (dB)	ANTENNA FACTOR (dB /m)	CABLE LOSS (dB)	PREAMP FACTOR (dB)	ANTENNA HEIGHT (cm)	TABLE ANGLE (Degree)	REMARK
5150	54.55	56.86	74	-19.45	34.52	9.52	46.35	100	340	Peak
5150	50.09	52.4	54	-3.91	34.52	9.52	46.35	100	340	Average
5260	102.56	104.52	/	/	34.61	9.75	46.32	100	340	Peak
5260	95.73	97.69	/	/	34.61	9.75	46.32	100	340	Average
5350	54.15	55.83	74	-19.85	34.68	9.94	46.3	100	340	Peak
5350	48.93	50.61	54	-5.07	34.68	9.94	46.3	100	340	Average

ANTENNA POLARITY & TEST DISTANCE: VERTICAL AT 3 M

FREQ. (MHz)	EMISSION LEVEL (dBuV/m)	READ LEVEL (dBuV)	LIMIT (dBuV/m)	MARGIN (dB)	ANTENNA FACTOR (dB /m)	CABLE LOSS (dB)	PREAMP FACTOR (dB)	ANTENNA HEIGHT (cm)	TABLE ANGLE (Degree)	REMARK
5150	56.62	58.85	74	-17.38	34.6	9.52	46.35	100	115	Peak
5150	50.19	52.42	54	-3.81	34.6	9.52	46.35	100	115	Average
5260	97.25	99.22	/	/	34.6	9.75	46.32	100	115	Peak
5260	90.81	92.78	/	/	34.6	9.75	46.32	100	115	Average
5350	55.36	57.12	74	-18.64	34.6	9.94	46.3	100	115	Peak
5350	49.48	51.24	54	-4.52	34.6	9.94	46.3	100	115	Average

REMARKS:

- Emission Level = Read Level+ Antenna Factor + Cable Loss- Preamp Factor
Margin value = Emission level – Limit value.
- 5260MHz: Fundamental frequency.



CHANNEL	TX Channel 60	DETECTOR FUNCTION	Peak (PK)
FREQUENCY RANGE	1GHz ~ 40GHz		Average (AV)

ANTENNA POLARITY & TEST DISTANCE: HORIZONTAL AT 3 M

FREQ. (MHz)	EMISSION LEVEL (dBuV/m)	READ LEVEL (dBuV)	LIMIT (dBuV/m)	MARGIN (dB)	ANTENNA FACTOR (dB /m)	CABLE LOSS (dB)	PREAMP FACTOR (dB)	ANTENNA HEIGHT (cm)	TABLE ANGLE (Degree)	REMARK
5150	57.42	59.73	74	-16.58	34.52	9.52	46.35	100	340	Peak
5150	49.54	51.85	54	-4.46	34.52	9.52	46.35	100	340	Average
5300	102.65	104.49	/	/	34.64	9.83	46.31	100	340	Peak
5300	96.18	98.02	/	/	34.64	9.83	46.31	100	340	Average
5350	54.43	56.11	74	-19.57	34.68	9.94	46.3	100	340	Peak
5350	49	50.68	54	-5	34.68	9.94	46.3	100	340	Average

ANTENNA POLARITY & TEST DISTANCE: VERTICAL AT 3 M

FREQ. (MHz)	EMISSION LEVEL (dBuV/m)	READ LEVEL (dBuV)	LIMIT (dBuV/m)	MARGIN (dB)	ANTENNA FACTOR (dB /m)	CABLE LOSS (dB)	PREAMP FACTOR (dB)	ANTENNA HEIGHT (cm)	TABLE ANGLE (Degree)	REMARK
5150	54.99	57.22	74	-19.01	34.6	9.52	46.35	100	137	Peak
5150	50.44	52.67	54	-3.56	34.6	9.52	46.35	100	137	Average
5300	95.81	97.69	/	/	34.6	9.83	46.31	100	137	Peak
5300	89.65	91.53	/	/	34.6	9.83	46.31	100	137	Average
5350	55.93	57.69	74	-18.07	34.6	9.94	46.3	100	137	Peak
5350	48.67	50.43	54	-5.33	34.6	9.94	46.3	100	137	Average

REMARKS:

- Emission Level = Read Level+ Antenna Factor + Cable Loss- Preamp Factor
Margin value = Emission level – Limit value.
- 5300MHz: Fundamental frequency.



CHANNEL	TX Channel 64	DETECTOR FUNCTION	Peak (PK)
FREQUENCY RANGE	1GHz ~ 40GHz		Average (AV)

ANTENNA POLARITY & TEST DISTANCE: HORIZONTAL AT 3 M

FREQ. (MHz)	EMISSION LEVEL (dBuV/m)	READ LEVEL (dBuV)	LIMIT (dBuV/m)	MARGIN (dB)	ANTENNA FACTOR (dB /m)	CABLE LOSS (dB)	PREAMP FACTOR (dB)	ANTENNA HEIGHT (cm)	TABLE ANGLE (Degree)	REMARK
5150	55.24	57.55	74	-18.76	34.52	9.52	46.35	100	340	Peak
5150	49.55	51.86	54	-4.45	34.52	9.52	46.35	100	340	Average
5320	102.07	103.83	/	/	34.66	9.88	46.3	100	340	Peak
5320	96.05	97.81	/	/	34.66	9.88	46.3	100	340	Average
5350	55.58	57.26	74	-18.42	34.68	9.94	46.3	100	340	Peak
5350	48.82	50.5	54	-5.18	34.68	9.94	46.3	100	340	Average

ANTENNA POLARITY & TEST DISTANCE: VERTICAL AT 3 M

FREQ. (MHz)	EMISSION LEVEL (dBuV/m)	READ LEVEL (dBuV)	LIMIT (dBuV/m)	MARGIN (dB)	ANTENNA FACTOR (dB /m)	CABLE LOSS (dB)	PREAMP FACTOR (dB)	ANTENNA HEIGHT (cm)	TABLE ANGLE (Degree)	REMARK
5150	56.17	58.4	74	-17.83	34.6	9.52	46.35	100	137	Peak
5150	50.04	52.27	54	-3.96	34.6	9.52	46.35	100	137	Average
5320	95.4	97.22	/	/	34.6	9.88	46.3	100	137	Peak
5320	88.49	90.31	/	/	34.6	9.88	46.3	100	137	Average
5350	55.82	57.58	74	-18.18	34.6	9.94	46.3	100	137	Peak
5350	48.4	50.16	54	-5.6	34.6	9.94	46.3	100	137	Average

REMARKS:

- Emission Level = Read Level+ Antenna Factor + Cable Loss- Preamp Factor
Margin value = Emission level – Limit value.
- 5320MHz: Fundamental frequency.



802.11ac (40MHz)

CHANNEL	TX Channel 54	DETECTOR FUNCTION	Peak (PK)
FREQUENCY RANGE	1GHz ~ 40GHz		Average (AV)

ANTENNA POLARITY & TEST DISTANCE: HORIZONTAL AT 3 M

FREQ. (MHz)	EMISSION LEVEL (dBuV/m)	READ LEVEL (dBuV)	LIMIT (dBuV/m)	MARGIN (dB)	ANTENNA FACTOR (dB /m)	CABLE LOSS (dB)	PREAMP FACTOR (dB)	ANTENNA HEIGHT (cm)	TABLE ANGLE (Degree)	REMARK
5150	55.17	57.48	74	-18.83	34.52	9.52	46.35	100	340	Peak
5150	49.89	52.2	54	-4.11	34.52	9.52	46.35	100	340	Average
5270	99.24	101.17	/	/	34.62	9.77	46.32	100	340	Peak
5270	93.58	95.51	/	/	34.62	9.77	46.32	100	340	Average
5350	54.54	56.22	74	-19.46	34.68	9.94	46.3	100	340	Peak
5350	48.99	50.67	54	-5.01	34.68	9.94	46.3	100	340	Average

ANTENNA POLARITY & TEST DISTANCE: VERTICAL AT 3 M

FREQ. (MHz)	EMISSION LEVEL (dBuV/m)	READ LEVEL (dBuV)	LIMIT (dBuV/m)	MARGIN (dB)	ANTENNA FACTOR (dB /m)	CABLE LOSS (dB)	PREAMP FACTOR (dB)	ANTENNA HEIGHT (cm)	TABLE ANGLE (Degree)	REMARK
5150	54.83	57.06	74	-19.17	34.6	9.52	46.35	100	115	Peak
5150	49.93	52.16	54	-4.07	34.6	9.52	46.35	100	115	Average
5270	92.94	94.89	/	/	34.6	9.77	46.32	100	115	Peak
5270	87.13	89.08	/	/	34.6	9.77	46.32	100	115	Average
5350	54.2	55.96	74	-19.8	34.6	9.94	46.3	100	115	Peak
5350	48.55	50.31	54	-5.45	34.6	9.94	46.3	100	115	Average

REMARKS:

- Emission Level = Read Level+ Antenna Factor + Cable Loss- Preamp Factor
Margin value = Emission level – Limit value.
- 5270MHz: Fundamental frequency.



CHANNEL	TX Channel 62	DETECTOR FUNCTION	Peak (PK)
FREQUENCY RANGE	1GHz ~ 40GHz		Average (AV)

ANTENNA POLARITY & TEST DISTANCE: HORIZONTAL AT 3 M

FREQ. (MHz)	EMISSION LEVEL (dBuV/m)	READ LEVEL (dBuV)	LIMIT (dBuV/m)	MARGIN (dB)	ANTENNA FACTOR (dB /m)	CABLE LOSS (dB)	PREAMP FACTOR (dB)	ANTENNA HEIGHT (cm)	TABLE ANGLE (Degree)	REMARK
5150	55.92	58.23	74	-18.08	34.52	9.52	46.35	100	340	Peak
5150	50.03	52.34	54	-3.97	34.52	9.52	46.35	100	340	Average
5310	99.4	101.21	/	/	34.65	9.85	46.31	100	340	Peak
5310	93.57	95.38	/	/	34.65	9.85	46.31	100	340	Average
5350	55.57	57.25	74	-18.43	34.68	9.94	46.3	100	340	Peak
5350	49.63	51.31	54	-4.37	34.68	9.94	46.3	100	340	Average

ANTENNA POLARITY & TEST DISTANCE: VERTICAL AT 3 M

FREQ. (MHz)	EMISSION LEVEL (dBuV/m)	READ LEVEL (dBuV)	LIMIT (dBuV/m)	MARGIN (dB)	ANTENNA FACTOR (dB /m)	CABLE LOSS (dB)	PREAMP FACTOR (dB)	ANTENNA HEIGHT (cm)	TABLE ANGLE (Degree)	REMARK
5150	55.08	57.31	74	-18.92	34.6	9.52	46.35	100	137	Peak
5150	50.1	52.33	54	-3.9	34.6	9.52	46.35	100	137	Average
5310	91.82	93.68	/	/	34.6	9.85	46.31	100	137	Peak
5310	86.3	88.16	/	/	34.6	9.85	46.31	100	137	Average
5350	55.88	57.64	74	-18.12	34.6	9.94	46.3	100	137	Peak
5350	48.87	50.63	54	-5.13	34.6	9.94	46.3	100	137	Average

REMARKS:

- Emission Level = Read Level+ Antenna Factor + Cable Loss- Preamp Factor
Margin value = Emission level – Limit value.
- 5310MHz: Fundamental frequency.



802.11ac (80MHz)

CHANNEL	TX Channel 58	DETECTOR FUNCTION	Peak (PK)
FREQUENCY RANGE	1GHz ~ 40GHz		Average (AV)

ANTENNA POLARITY & TEST DISTANCE: HORIZONTAL AT 3 M										
FREQ. (MHz)	EMISSION LEVEL (dBuV/m)	READ LEVEL (dBuV)	LIMIT (dBuV/m)	MARGIN (dB)	ANTENNA FACTOR (dB /m)	CABLE LOSS (dB)	PREAMP FACTOR (dB)	ANTENNA HEIGHT (cm)	TABLE ANGLE (Degree)	REMARK
5150	54.54	56.85	74	-19.46	34.52	9.52	46.35	100	340	Peak
5150	50.38	52.69	54	-3.62	34.52	9.52	46.35	100	340	Average
5290	94.47	96.34	/	/	34.63	9.81	46.31	100	340	Peak
5290	88.63	90.5	/	/	34.63	9.81	46.31	100	340	Average
5350	55.26	56.94	74	-18.74	34.68	9.94	46.3	100	340	Peak
5350	50.76	52.44	54	-3.24	34.68	9.94	46.3	100	340	Average

ANTENNA POLARITY & TEST DISTANCE: VERTICAL AT 3 M										
FREQ. (MHz)	EMISSION LEVEL (dBuV/m)	READ LEVEL (dBuV)	LIMIT (dBuV/m)	MARGIN (dB)	ANTENNA FACTOR (dB /m)	CABLE LOSS (dB)	PREAMP FACTOR (dB)	ANTENNA HEIGHT (cm)	TABLE ANGLE (Degree)	REMARK
5150	54.37	56.6	74	-19.63	34.6	9.52	46.35	100	137	Peak
5150	49.83	52.06	54	-4.17	34.6	9.52	46.35	100	137	Average
5290	86.66	88.56	/	/	34.6	9.81	46.31	100	137	Peak
5290	81.99	83.89	/	/	34.6	9.81	46.31	100	137	Average
5350	56.04	57.8	74	-17.96	34.6	9.94	46.3	100	137	Peak
5350	50.31	52.07	54	-3.69	34.6	9.94	46.3	100	137	Average

REMARKS:

- Emission Level = Read Level+ Antenna Factor + Cable Loss- Preamp Factor
Margin value = Emission level – Limit value.
- 5290MHz: Fundamental frequency.



Band 3

802.11a

CHANNEL	TX Channel 100	DETECTOR FUNCTION	Peak (PK)
FREQUENCY RANGE	1GHz ~ 40GHz		Average (AV)

ANTENNA POLARITY & TEST DISTANCE: HORIZONTAL AT 3 M										
FREQ. (MHz)	EMISSION LEVEL (dBuV/m)	READ LEVEL (dBuV)	LIMIT (dBuV/m)	MARGIN (dB)	ANTENNA FACTOR (dB /m)	CABLE LOSS (dB)	PREAMP FACTOR (dB)	ANTENNA HEIGHT (cm)	TABLE ANGLE (Degree)	REMARK
5460	56.21	57.53	74	-17.79	34.77	10.17	46.26	100	340	Peak
5460	49.25	50.57	54	-4.75	34.77	10.17	46.26	100	340	Average
5470	55.05	56.34	68.3	-13.25	34.78	10.19	46.26	100	340	Peak
5500	100.43	101.62	/	/	34.8	10.26	46.25	100	340	Peak
5500	94.1	95.29	/	/	34.8	10.26	46.25	100	340	Average
ANTENNA POLARITY & TEST DISTANCE: VERTICAL AT 3 M										
FREQ. (MHz)	EMISSION LEVEL (dBuV/m)	READ LEVEL (dBuV)	LIMIT (dBuV/m)	MARGIN (dB)	ANTENNA FACTOR (dB /m)	CABLE LOSS (dB)	PREAMP FACTOR (dB)	ANTENNA HEIGHT (cm)	TABLE ANGLE (Degree)	REMARK
5460	55.03	56.52	74	-18.97	34.6	10.17	46.26	100	280	Peak
5460	50.17	51.66	54	-3.83	34.6	10.17	46.26	100	280	Average
5470	55.79	57.26	68.3	-12.51	34.6	10.19	46.26	100	280	Peak
5500	96.5	97.89	/	/	34.6	10.26	46.25	100	280	Peak
5500	90.45	91.84	/	/	34.6	10.26	46.25	100	280	Average

REMARKS:

- Emission Level = Read Level+ Antenna Factor + Cable Loss- Preamp Factor
Margin value = Emission level – Limit value.
- 5500MHz: Fundamental frequency.
- #: Out of restricted band.



CHANNEL	TX Channel 116	DETECTOR FUNCTION	Peak (PK)
FREQUENCY RANGE	1GHz ~ 40GHz		Average (AV)

ANTENNA POLARITY & TEST DISTANCE: HORIZONTAL AT 3 M

FREQ. (MHz)	EMISSION LEVEL (dBuV/m)	READ LEVEL (dBuV)	LIMIT (dBuV/m)	MARGIN (dB)	ANTENNA FACTOR (dB /m)	CABLE LOSS (dB)	PREAMP FACTOR (dB)	ANTENNA HEIGHT (cm)	TABLE ANGLE (Degree)	REMARK
5460	55.12	56.44	74	-18.88	34.77	10.17	46.26	100	340	Peak
5460	48.7	50.02	54	-5.3	34.77	10.17	46.26	100	340	Average
5470	54.62	55.91	68.3	-13.68	34.78	10.19	46.26	100	340	Peak
5580	101.93	102.67	/	/	34.9	10.59	46.23	100	340	Peak
5580	95.46	96.2	/	/	34.9	10.59	46.23	100	340	Average

ANTENNA POLARITY & TEST DISTANCE: VERTICAL AT 3 M

FREQ. (MHz)	EMISSION LEVEL (dBuV/m)	READ LEVEL (dBuV)	LIMIT (dBuV/m)	MARGIN (dB)	ANTENNA FACTOR (dB /m)	CABLE LOSS (dB)	PREAMP FACTOR (dB)	ANTENNA HEIGHT (cm)	TABLE ANGLE (Degree)	REMARK
5460	54.99	56.48	74	-19.01	34.6	10.17	46.26	100	115	Peak
5460	48.6	50.09	54	-5.4	34.6	10.17	46.26	100	115	Average
5470	55.78	57.25	68.3	-12.52	34.6	10.19	46.26	100	115	Peak
5580	98.61	99.55	/	/	34.7	10.59	46.23	100	115	Peak
5580	92.25	93.19	/	/	34.7	10.59	46.23	100	115	Average

REMARKS:

- Emission Level = Read Level+ Antenna Factor + Cable Loss- Preamp Factor
Margin value = Emission level – Limit value.
- 5580MHz: Fundamental frequency.
- #: Out of restricted band.



CHANNEL	TX Channel 140	DETECTOR FUNCTION	Peak (PK)
FREQUENCY RANGE	1GHz ~ 40GHz		Average (AV)

ANTENNA POLARITY & TEST DISTANCE: HORIZONTAL AT 3 M										
FREQ. (MHz)	EMISSION LEVEL (dBuV/m)	READ LEVEL (dBuV)	LIMIT (dBuV/m)	MARGIN (dB)	ANTENNA FACTOR (dB /m)	CABLE LOSS (dB)	PREAMP FACTOR (dB)	ANTENNA HEIGHT (cm)	TABLE ANGLE (Degree)	REMARK
5700	102.46	102.52	/	/	35.04	11.09	46.19	100	340	Peak
5700	96.26	96.32	/	/	35.04	11.09	46.19	100	340	Average
5725	57.79	57.71	68.3	-10.51	35.07	11.2	46.19	100	340	Peak
ANTENNA POLARITY & TEST DISTANCE: VERTICAL AT 3 M										
FREQ. (MHz)	EMISSION LEVEL (dBuV/m)	READ LEVEL (dBuV)	LIMIT (dBuV/m)	MARGIN (dB)	ANTENNA FACTOR (dB /m)	CABLE LOSS (dB)	PREAMP FACTOR (dB)	ANTENNA HEIGHT (cm)	TABLE ANGLE (Degree)	REMARK
5700	97.89	98.15	/	/	34.84	11.09	46.19	100	137	Peak
5700	91.86	92.12	/	/	34.84	11.09	46.19	100	137	Average
5725	57.97	58.09	68.3	-10.33	34.87	11.2	46.19	100	137	Peak

REMARKS:

1. Emission Level = Read Level+ Antenna Factor + Cable Loss- Preamp Factor
Margin value = Emission level – Limit value.
2. 5700MHz: Fundamental frequency.
3. #: Out of restricted band.



802.11n (20MHz)

CHANNEL	TX Channel 100	DETECTOR FUNCTION	Peak (PK)
FREQUENCY RANGE	1GHz ~ 40GHz		Average (AV)

ANTENNA POLARITY & TEST DISTANCE: HORIZONTAL AT 3 M										
FREQ. (MHz)	EMISSION LEVEL (dBuV/m)	READ LEVEL (dBuV)	LIMIT (dBuV/m)	MARGIN (dB)	ANTENNA FACTOR (dB /m)	CABLE LOSS (dB)	PREAMP FACTOR (dB)	ANTENNA HEIGHT (cm)	TABLE ANGLE (Degree)	REMARK
5460	53.91	55.23	74	-20.09	34.77	10.17	46.26	100	330	Peak
5460	48.55	49.87	54	-5.45	34.77	10.17	46.26	100	330	Average
5470	55.71	57	68.3	-12.59	34.78	10.19	46.26	100	330	Peak
5500	99.01	100.2	/	/	34.8	10.26	46.25	100	330	Peak
5500	91.8	92.99	/	/	34.8	10.26	46.25	100	330	Average
ANTENNA POLARITY & TEST DISTANCE: VERTICAL AT 3 M										
FREQ. (MHz)	EMISSION LEVEL (dBuV/m)	READ LEVEL (dBuV)	LIMIT (dBuV/m)	MARGIN (dB)	ANTENNA FACTOR (dB /m)	CABLE LOSS (dB)	PREAMP FACTOR (dB)	ANTENNA HEIGHT (cm)	TABLE ANGLE (Degree)	REMARK
5460	54.19	55.68	74	-19.81	34.6	10.17	46.26	100	265	Peak
5460	48.23	49.72	54	-5.77	34.6	10.17	46.26	100	265	Average
5470	55.97	57.44	68.3	-12.33	34.6	10.19	46.26	100	265	Peak
5500	93.06	94.45	/	/	34.6	10.26	46.25	100	265	Peak
5500	86.04	87.43	/	/	34.6	10.26	46.25	100	265	Average

REMARKS:

- Emission Level = Read Level+ Antenna Factor + Cable Loss- Preamp Factor
Margin value = Emission level – Limit value.
- 5500MHz: Fundamental frequency.
- #: Out of restricted band.



CHANNEL	TX Channel 116	DETECTOR FUNCTION	Peak (PK)
FREQUENCY RANGE	1GHz ~ 40GHz		Average (AV)

ANTENNA POLARITY & TEST DISTANCE: HORIZONTAL AT 3 M

FREQ. (MHz)	EMISSION LEVEL (dBuV/m)	READ LEVEL (dBuV)	LIMIT (dBuV/m)	MARGIN (dB)	ANTENNA FACTOR (dB /m)	CABLE LOSS (dB)	PREAMP FACTOR (dB)	ANTENNA HEIGHT (cm)	TABLE ANGLE (Degree)	REMARK
5460	54.47	55.79	74	-19.53	34.77	10.17	46.26	100	330	Peak
5460	48.44	49.76	54	-5.56	34.77	10.17	46.26	100	330	Average
5470	55.69	56.98	68.3	-12.61	34.78	10.19	46.26	100	330	Peak
5580	99.42	100.16	/	/	34.9	10.59	46.23	100	330	Peak
5580	93.2	93.94	/	/	34.9	10.59	46.23	100	330	Average

ANTENNA POLARITY & TEST DISTANCE: VERTICAL AT 3 M

FREQ. (MHz)	EMISSION LEVEL (dBuV/m)	READ LEVEL (dBuV)	LIMIT (dBuV/m)	MARGIN (dB)	ANTENNA FACTOR (dB /m)	CABLE LOSS (dB)	PREAMP FACTOR (dB)	ANTENNA HEIGHT (cm)	TABLE ANGLE (Degree)	REMARK
5460	56.33	57.82	74	-17.67	34.6	10.17	46.26	100	265	Peak
5460	48.3	49.79	54	-5.7	34.6	10.17	46.26	100	265	Average
5470	54.12	55.59	68.3	-14.18	34.6	10.19	46.26	100	265	Peak
5580	94.01	94.95	/	/	34.7	10.59	46.23	100	265	Peak
5580	87.48	88.42	/	/	34.7	10.59	46.23	100	265	Average

REMARKS:

- Emission Level = Read Level+ Antenna Factor + Cable Loss- Preamp Factor
Margin value = Emission level – Limit value.
- 5580MHz: Fundamental frequency.
- #: Out of restricted band.



CHANNEL	TX Channel 140	DETECTOR FUNCTION	Peak (PK)
FREQUENCY RANGE	1GHz ~ 40GHz		Average (AV)

ANTENNA POLARITY & TEST DISTANCE: HORIZONTAL AT 3 M										
FREQ. (MHz)	EMISSION LEVEL (dBuV/m)	READ LEVEL (dBuV)	LIMIT (dBuV/m)	MARGIN (dB)	ANTENNA FACTOR (dB /m)	CABLE LOSS (dB)	PREAMP FACTOR (dB)	ANTENNA HEIGHT (cm)	TABLE ANGLE (Degree)	REMARK
5700	100.77	100.83	/	/	35.04	11.09	46.19	100	330	Peak
5700	95.02	95.08	/	/	35.04	11.09	46.19	100	330	Average
5725	56.82	56.74	68.3	-11.48	35.07	11.2	46.19	100	330	Peak
ANTENNA POLARITY & TEST DISTANCE: VERTICAL AT 3 M										
FREQ. (MHz)	EMISSION LEVEL (dBuV/m)	READ LEVEL (dBuV)	LIMIT (dBuV/m)	MARGIN (dB)	ANTENNA FACTOR (dB /m)	CABLE LOSS (dB)	PREAMP FACTOR (dB)	ANTENNA HEIGHT (cm)	TABLE ANGLE (Degree)	REMARK
5700	96.8	97.06	/	/	34.84	11.09	46.19	100	165	Peak
5700	88.57	88.83	/	/	34.84	11.09	46.19	100	165	Average
5725	57.56	57.68	68.3	-10.74	34.87	11.2	46.19	100	165	Peak

REMARKS:

- Emission Level = Read Level+ Antenna Factor + Cable Loss- Preamp Factor
Margin value = Emission level – Limit value.
- 5700MHz: Fundamental frequency.
- #: Out of restricted band.



802.11n (40MHz)

CHANNEL	TX Channel 102	DETECTOR FUNCTION	Peak (PK)
FREQUENCY RANGE	1GHz ~ 40GHz		Average (AV)

ANTENNA POLARITY & TEST DISTANCE: HORIZONTAL AT 3 M

FREQ. (MHz)	EMISSION LEVEL (dBuV/m)	READ LEVEL (dBuV)	LIMIT (dBuV/m)	MARGIN (dB)	ANTENNA FACTOR (dB /m)	CABLE LOSS (dB)	PREAMP FACTOR (dB)	ANTENNA HEIGHT (cm)	TABLE ANGLE (Degree)	REMARK
5460	54	55.32	74	-20	34.77	10.17	46.26	100	330	Peak
5460	48.89	50.21	54	-5.11	34.77	10.17	46.26	100	330	Average
5470	53.9	55.19	68.3	-14.4	34.78	10.19	46.26	100	330	Peak
5510	93.46	94.6	/	/	34.81	10.3	46.25	100	330	Peak
5510	89.71	90.85	/	/	34.81	10.3	46.25	100	330	Average

ANTENNA POLARITY & TEST DISTANCE: VERTICAL AT 3 M

FREQ. (MHz)	EMISSION LEVEL (dBuV/m)	READ LEVEL (dBuV)	LIMIT (dBuV/m)	MARGIN (dB)	ANTENNA FACTOR (dB /m)	CABLE LOSS (dB)	PREAMP FACTOR (dB)	ANTENNA HEIGHT (cm)	TABLE ANGLE (Degree)	REMARK
5460	54.19	55.68	74	-19.81	34.6	10.17	46.26	100	260	Peak
5460	47.77	49.26	54	-6.23	34.6	10.17	46.26	100	260	Average
5470	55.63	57.1	68.3	-12.67	34.6	10.19	46.26	100	260	Peak
5510	88.65	89.99	/	/	34.61	10.3	46.25	100	260	Peak
5510	83.83	85.17	/	/	34.61	10.3	46.25	100	260	Average

REMARKS:

- Emission Level = Read Level+ Antenna Factor + Cable Loss- Preamp Factor
Margin value = Emission level – Limit value.
- 5510MHz: Fundamental frequency.
- #: Out of restricted band.



CHANNEL	TX Channel 110	DETECTOR FUNCTION	Peak (PK)
FREQUENCY RANGE	1GHz ~ 40GHz		Average (AV)

ANTENNA POLARITY & TEST DISTANCE: HORIZONTAL AT 3 M

FREQ. (MHz)	EMISSION LEVEL (dBuV/m)	READ LEVEL (dBuV)	LIMIT (dBuV/m)	MARGIN (dB)	ANTENNA FACTOR (dB /m)	CABLE LOSS (dB)	PREAMP FACTOR (dB)	ANTENNA HEIGHT (cm)	TABLE ANGLE (Degree)	REMARK
5460	55.77	57.09	74	-18.23	34.77	10.17	46.26	100	330	Peak
5460	49.21	50.53	54	-4.79	34.77	10.17	46.26	100	330	Average
5470	53.96	55.25	68.3	-14.34	34.78	10.19	46.26	100	330	Peak
5550	94	94.91	/	/	34.86	10.47	46.24	100	330	Peak
5550	90.27	91.18	/	/	34.86	10.47	46.24	100	330	Average

ANTENNA POLARITY & TEST DISTANCE: VERTICAL AT 3 M

FREQ. (MHz)	EMISSION LEVEL (dBuV/m)	READ LEVEL (dBuV)	LIMIT (dBuV/m)	MARGIN (dB)	ANTENNA FACTOR (dB /m)	CABLE LOSS (dB)	PREAMP FACTOR (dB)	ANTENNA HEIGHT (cm)	TABLE ANGLE (Degree)	REMARK
5460	53.12	54.61	74	-20.88	34.6	10.17	46.26	100	260	Peak
5460	48.15	49.64	54	-5.85	34.6	10.17	46.26	100	260	Average
5470	54.03	55.5	68.3	-14.27	34.6	10.19	46.26	100	260	Peak
5550	90.09	91.2	/	/	34.66	10.47	46.24	100	260	Peak
5550	85.46	86.57	/	/	34.66	10.47	46.24	100	260	Average

REMARKS:

- Emission Level = Read Level+ Antenna Factor + Cable Loss- Preamp Factor
Margin value = Emission level – Limit value.
- 5500MHz: Fundamental frequency.
- #: Out of restricted band.



CHANNEL	TX Channel 134	DETECTOR FUNCTION	Peak (PK)
FREQUENCY RANGE	1GHz ~ 40GHz		Average (AV)

ANTENNA POLARITY & TEST DISTANCE: HORIZONTAL AT 3 M

FREQ. (MHz)	EMISSION LEVEL (dBuV/m)	READ LEVEL (dBuV)	LIMIT (dBuV/m)	MARGIN (dB)	ANTENNA FACTOR (dB /m)	CABLE LOSS (dB)	PREAMP FACTOR (dB)	ANTENNA HEIGHT (cm)	TABLE ANGLE (Degree)	REMARK
5670	97.08	97.31	/	/	35	10.97	46.2	100	330	Peak
5670	92.33	92.56	/	/	35	10.97	46.2	100	330	Average
5725	58.32	58.24	68.3	-9.98	35.07	11.2	46.19	100	330	Peak

ANTENNA POLARITY & test distance: Vertical at 3 m

FREQ. (MHz)	EMISSION LEVEL (dBuV/m)	READ LEVEL (dBuV)	LIMIT (dBuV/m)	MARGIN (dB)	ANTENNA FACTOR (dB /m)	CABLE LOSS (dB)	PREAMP FACTOR (dB)	ANTENNA HEIGHT (cm)	TABLE ANGLE (Degree)	REMARK
5670	88.61	89.04	/	/	34.8	10.97	46.2	100	260	Peak
5670	85.28	85.71	/	/	34.8	10.97	46.2	100	260	Average
5725	55.57	55.69	68.3	-12.73	34.87	11.2	46.19	100	260	Peak

REMARKS:

- Emission Level = Read Level+ Antenna Factor + Cable Loss- Preamp Factor
Margin value = Emission level – Limit value.
- 5670MHz: Fundamental frequency.
- #: Out of restricted band.



802.11ac (20MHz)

CHANNEL	TX Channel 100	DETECTOR FUNCTION	Peak (PK)
FREQUENCY RANGE	1GHz ~ 40GHz		Average (AV)

ANTENNA POLARITY & TEST DISTANCE: HORIZONTAL AT 3 M										
FREQ. (MHz)	EMISSION LEVEL (dBuV/m)	READ LEVEL (dBuV)	LIMIT (dBuV/m)	MARGIN (dB)	ANTENNA FACTOR (dB /m)	CABLE LOSS (dB)	PREAMP FACTOR (dB)	ANTENNA HEIGHT (cm)	TABLE ANGLE (Degree)	REMARK
5460	55.64	56.96	74	-18.36	34.77	10.17	46.26	100	330	Peak
5460	48.87	50.19	54	-5.13	34.77	10.17	46.26	100	330	Average
5470	53.95	55.24	68.3	-14.35	34.78	10.19	46.26	100	330	Peak
5500	98.9	100.09	/	/	34.8	10.26	46.25	100	330	Peak
5500	92.6	93.79	/	/	34.8	10.26	46.25	100	330	Average

ANTENNA POLARITY & TEST DISTANCE: VERTICAL AT 3 M										
FREQ. (MHz)	EMISSION LEVEL (dBuV/m)	READ LEVEL (dBuV)	LIMIT (dBuV/m)	MARGIN (dB)	ANTENNA FACTOR (dB /m)	CABLE LOSS (dB)	PREAMP FACTOR (dB)	ANTENNA HEIGHT (cm)	TABLE ANGLE (Degree)	REMARK
5460	53.57	55.06	74	-20.43	34.6	10.17	46.26	100	270	Peak
5460	48.91	50.4	54	-5.09	34.6	10.17	46.26	100	270	Average
5470	55.84	57.31	68.3	-12.46	34.6	10.19	46.26	100	270	Peak
5500	93.54	94.93	/	/	34.6	10.26	46.25	100	270	Peak
5500	87.73	89.12	/	/	34.6	10.26	46.25	100	270	Average

REMARKS:

- Emission Level = Read Level+ Antenna Factor + Cable Loss- Preamp Factor
Margin value = Emission level – Limit value.
- 5500MHz: Fundamental frequency.
- #: Out of restricted band.