



RF TEST REPORT

Applicant Xiaomi Communications Co., Ltd.
FCC ID 2AFZZ117BPG
Product Mobile Phone
Brand POCO
Model 2207117BPG
Report No. R2206A0560-R2
Issue Date July 5, 2022

TA Technology (Shanghai) Co., Ltd. tested the above equipment in accordance with the requirements in **FCC CFR47 Part 2 (2021)/ FCC CFR 47 Part 24E (2021)**. The test results show that the equipment tested is capable of demonstrating compliance with the requirements as documented in this report.

Prepared by: Xu Ying

Approved by: Xu Kai

TA Technology (Shanghai) Co., Ltd.

Building 3, No.145, Jintang Rd, Tangzhen Industry Park, Pudong Shanghai, China

TEL: +86-021-50791141/2/3

FAX: +86-021-50791141/2/3-8000



TABLE OF CONTENT

1. Test Laboratory	4
1.1. Notes of the test report	4
1.2. Test facility	4
1.3. Testing Location	4
2. General Description of Equipment under Test	5
2.3. Applicant and Manufacturer Information	5
2.4. General information	5
3. Applied Standards	7
4. Test Configuration	8
5. Test Case Results	10
5.1. RF Power Output and Effective Isotropic Radiated Power	10
5.2. Occupied Bandwidth	17
5.3. Band Edge Compliance	31
5.4. Peak-to-Average Power Ratio (PAPR)	46
5.5. Frequency Stability	49
5.6. Spurious Emissions at Antenna Terminals	55
5.7. Radiates Spurious Emission	61
6. Main Test Instruments	69
ANNEX A: The EUT Appearance	70
ANNEX B: Test Setup Photos	71
ANNEX C: Product Change Description	72

Summary of measurement results

No.	Test Case	Clause in FCC rules	Verdict
1	RF Power Output and Effective Isotropic Radiated Power	2.1046 24.232(c)	PASS
2	Occupied Bandwidth	2.1049	PASS
3	Band Edge Compliance	2.1051 /24.238(a)	PASS
4	Peak-to-Average Power Ratio	24.232/KDB 971168 D01(5.7)	PASS
5	Frequency Stability	2.1055 / 24.235	PASS
6	Spurious Emissions at Antenna Terminals	2.1051 / 24.238(a)	PASS
7	Radiates Spurious Emission	2.1053 / 24.238(a)	PASS
Date of Testing: February 8, 2021 ~ March 3, 2021			
Date of Sample Received: February 7, 2021			
Note: All indications of Pass/Fail in this report are opinions expressed by TA Technology (Shanghai) Co., Ltd. based on interpretations and/or observations of test results. Measurement Uncertainties were not taken into account and are published for informational purposes only.			

2207117BPG (Report No.: R2206A0560-R2) is a variant model of M2101K7BNY (Report No.: R2101A0095-R2). Test values all duplicated from Original for variant. There is no tested in the report.

The difference between model 2207117BPG and M2101K7BNY are shown in the table below:

Item	Original	Variant
Brand	Redmi	POCO
Model	M2101K7BNY	2207117BPG
Hardware Version	P2	P1.1
Software Version	MIUI 12	MIUI 13
RAM	8G+128G; 6G+128G; 6G+64G	4+64G;4+128G; 6+128G
Accessory	USB cable L23220、H23220、 B23220	USB cable L23230、 H23230、B23230
Color	--	add blue version

The detailed product change description please refers to the *Difference Declaration Letter*.



1. Test Laboratory

1.1. Notes of the test report

This report shall not be reproduced in full or partial, without the written approval of **TA technology (shanghai) co., Ltd.** The results documented in this report apply only to the tested sample, under the conditions and modes of operation as described herein. Measurement Uncertainties were not taken into account and are published for informational purposes only. This report is written to support regulatory compliance of the applicable standards stated above.

1.2. Test facility

FCC (Designation number: CN1179, Test Firm Registration Number: 446626)

TA Technology (Shanghai) Co., Ltd. has been listed on the US Federal Communications Commission list of test facilities recognized to perform measurements.

A2LA (Certificate Number: 3857.01)

TA Technology (Shanghai) Co., Ltd. has been listed by American Association for Laboratory Accreditation to perform measurement.

1.3. Testing Location

Company: TA Technology (Shanghai) Co., Ltd.
Address: Building 3, No.145, Jintang Rd, Tangzhen Industry Park, Pudong
City: Shanghai
Post code: 201201
Country: P. R. China
Contact: Xu Kai
Telephone: +86-021-50791141/2/3
Fax: +86-021-50791141/2/3-8000
Website: <http://www.ta-shanghai.com>
E-mail: xukai@ta-shanghai.com

2. General Description of Equipment under Test

2.1. Applicant and Manufacturer Information

Applicant	Xiaomi Communications Co., Ltd.
Applicant address	#019, 9th Floor, Building 6, 33 Xi'erqi Middle Road, Haidian District, Beijing, China, 100085
Manufacturer	Xiaomi Communications Co., Ltd.
Manufacturer address	#019, 9th Floor, Building 6, 33 Xi'erqi Middle Road, Haidian District, Beijing, China, 100085

2.2. General information

EUT Description				
Model	2207117BPG			
IMEI	Original	IMEI 1: 869421050050226 IMEI 2: 869421050050234		
	Variant	IMEI 1: 867701060029563 IMEI 2: 867701060029571		
Hardware Version	P1.1			
Software Version	MIUI 13			
Power Supply	Battery / AC adapter			
Antenna Type	Fixed Internal Antenna			
Antenna Gain	Band	Frequency (MHz)	Main Antenna (dBi)	Second Antenna (dBi)
	GSM1900/ WCDMA	1850	-3.0	-1.2
		1870	-3.5	-1.8
	Band II/ LTE Band 2	1890	-3.5	-1.8
		1910	-3.6	-2.1
Memory	6G+128G; 4G+64G; 4G+128G			
Test Mode(s)	GSM1900; WCDMA Band II; LTE Band 2;			
Test Modulation	(GSM/GPRS)GMSK, (EGPRS) GMSK/ 8PSK; (WCDMA) BPSK, QPSK, 16QAM; (LTE) QPSK, 16QAM, 64QAM, 256QAM(DL only);			
GPRS Multislot Class	12			
EGPRS Multislot Class	12			
HSDPA UE Category	24			
HSUPA UE Category	7			
LTE Release	R12			
Maximum E.I.R.P	GSM 1900:	28.00 dBm		
	WCDMA Band II:	21.81 dBm		



	LTE Band 2:	23.20 dBm	
Rated Power Supply Voltage	3.87V		
Supply Voltage	Minimum: 3.6V Maximum: 4.45V		
Operating Temperature	Lowest: 0°C Highest: +40°C		
Extreme Temperature	Lowest: -30°C Highest: +50°C		
Operating Frequency Range(s)	Band	Tx (MHz)	Rx (MHz)
	GSM1900	1850 ~ 1910	1930 ~ 1990
	WCDMA Band II	1850 ~ 1910	1930 ~ 1990
	LTE Band 2	1850 ~ 1910	1930 ~ 1990
Note: 1. The EUT is sent from the applicant to TA and the information of the EUT is declared by the applicant.			

3. Applied Standards

According to the specifications of the manufacturer, it must comply with the requirements of the following standards:

Test standards:

FCC CFR 47 Part 24E (2021)

ANSI C63.26-2015

Reference standard:

FCC CFR47 Part 2 (2021)

KDB 971168 D01 Power Meas License Digital Systems v03r01

4. Test Configuration

There is more than one SIM card slot, each one should be applied throughout the compliance test respectively, and however, only the worst case (SIM 1) will be recorded in this report.

Radiated measurements are performed by rotating the EUT in three different orthogonal test planes. EUT stand-up position (Z axis), lie-down position (X, Y axis). Receiver antenna polarization (horizontal and vertical), the worst emission was found in position (Z axis, horizontal polarization) and the worst case was recorded.

All mode and data rates and positions and RB size and modulations were investigated. Subsequently, only the worst case emissions are reported.

The following testing in GSM/WCDMA/LTE is set based on the maximum RF Output Power.

Test modes are chosen to be reported as the worst case configuration below:

Test items	Modes/Modulation	
	GSM 1900	WCDMA Band II
RF Power Output and Effective Isotropic Radiated Power	GSM GPRS EGPRS	RMC HSDPA/HSUPA DC-HSDPA/HSPA+
Occupied Bandwidth	GSM GPRS(1Tx slot) EGPRS(1Tx slot)	RMC
Band Edge Compliance	GSM GPRS(1Tx slot) EGPRS(1Tx slot)	RMC
Peak-to-Average Power Ratio	GSM GPRS(1Tx slot) EGPRS(1Tx slot)	RMC
Frequency Stability	GSM GPRS(1Tx slot) EGPRS(1Tx slot)	RMC
Spurious Emissions at Antenna Terminals	GSM	RMC
Radiates Spurious Emission	GSM	RMC

Test modes are chosen to be reported as the worst case configuration below for LTE Band 2:

Test items	Bandwidth (MHz)						Modulation		RB			Test Channel		
	1.4	3	5	10	15	20	QPSK	16QAM/ 64QAM	1	50%	100%	L	M	H
RF Power Output and Effective Isotropic Radiated Power	O	O	O	O	O	O	O	O	O	O	O	O	O	O
Occupied Bandwidth	O	O	O	O	O	O	O	O	-	-	O	O	O	O
Band Edge Compliance	O	O	O	O	O	O	O	O	O	-	O	O	-	O
Peak-to-Average Power Ratio	O	O	O	O	O	O	O	O	-	-	O	O	O	O
Frequency Stability	O	O	O	O	O	O	O	O	O	-	-	-	O	-
Spurious Emissions at Antenna Terminals	O	O	O	O	O	O	O	-	O	-	-	O	O	O
Radiates Spurious Emission	O	-	O	-	-	O	O	-	O	-	-	-	O	-
Note	1. The mark "O" means that this configuration is chosen for testing. 2. The mark "-" means that this configuration is not testing.													

5. Test Case Results

5.1.RF Power Output and Effective Isotropic Radiated Power

Ambient condition

Temperature	Relative humidity	Pressure
23°C ~25°C	45%~50%	101.5kPa

Methods of Measurement

During the process of the testing, The EUT was connected to the Base Station Simulator with a known loss. The EUT is controlled by the Base Station Simulator test set to ensure max power transmission with proper modulation.

ERP can then be calculated as follows:

$$\text{EIRP (dBm)} = \text{Output Power (dBm)} - \text{Losses (dB)} + \text{Antenna Gain (dBi)}$$

where:dBd refers to gain relative to an ideal dipole.

$$\text{EIRP (dBm)} = \text{ERP (dBm)} + 2.15 \text{ (dB.)}$$

Test Setup

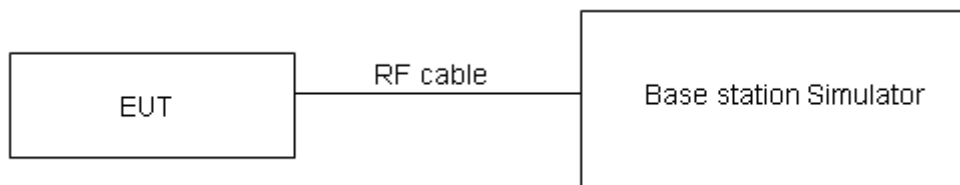

Limits

No specific RF power output requirements in part 2.1046.

Rule Part 24.232(c) Mobile and portable stations are limited to 2 watts EIRP.

Rule Part 24.232(e) Peak transmit power must be measured over any interval of continuous transmission using instrumentation calibrated in terms of an rms-equivalent voltage.

Limit	$\leq 2 \text{ W}$ (33 dBm)
-------	-----------------------------

Measurement Uncertainty

The assessed measurement uncertainty to ensure 95% confidence level for the normal distribution is with the coverage factor $k = 2$, $U = 0.4 \text{ dB}$ for RF power output, $k = 2$, $U = 1.19 \text{ dB}$ for EIRP.

Test Results

GSM 1900		Maximum Output Power (dBm)			EIRP (dBm) Main Antenna			EIRP (dBm) Second antenna		
		Channel 512	Channel 661	Channel 810	Channel 512	Channel 661	Channel 810	Channel 512	Channel 661	Channel 810
		1850.2 (MHz)	1880 (MHz)	1909.8 (MHz)	1850.2 (MHz)	1880 (MHz)	1909.8 (MHz)	1850.2 (MHz)	1880 (MHz)	1909.8 (MHz)
GSM (GMSK)	Results	29.20	29.37	29.45	26.20	25.87	25.85	28.00	27.57	27.35
GPRS (GMSK)	1TXslot	29.17	29.38	29.43	26.17	25.88	25.83	27.97	27.58	27.33
	2TXslots	26.59	26.93	27.09	23.59	23.43	23.49	25.39	25.13	24.99
	3TXslots	25.05	25.42	25.59	22.05	21.92	21.99	23.85	23.62	23.49
	4TXslots	23.48	23.88	24.09	20.48	20.38	20.49	22.28	22.08	21.99
EGPRS (8PSK)	1TXslot	26.17	26.34	26.40	23.17	22.84	22.80	24.97	24.54	24.30
	2TXslots	23.66	23.88	23.97	20.66	20.38	20.37	22.46	22.08	21.87
	3TXslots	21.91	22.17	22.29	18.91	18.67	18.69	20.71	20.37	20.19
	4TXslots	20.68	20.81	20.93	17.68	17.31	17.33	19.48	19.01	18.83



WCDMA Band II		Maximum Output Power (dBm)			EIRP (dBm) Main Antenna			EIRP (dBm) Second antenna		
		Channel 9262	Channel 9400	Channel 9538	Channel 9262	Channel 9400	Channel 9538	Channel 9262	Channel 9400	Channel 9538
		1852.4 (MHz)	1880 (MHz)	1907.6 (MHz)	1852.4 (MHz)	1880 (MHz)	1907.6 (MHz)	1852.4 (MHz)	1880 (MHz)	1907.6 (MHz)
RMC		23.01	23.12	23.10	20.01	19.62	19.50	21.81	21.32	21.00
HSDPA	Sub - Test 1	21.63	21.54	21.48	18.63	18.04	17.88	20.43	19.74	19.38
	Sub - Test 2	21.39	21.74	21.50	18.39	18.24	17.90	20.19	19.94	19.40
	Sub - Test 3	21.67	21.56	21.66	18.67	18.06	18.06	20.47	19.76	19.56
	Sub - Test 4	21.51	21.72	21.44	18.51	18.22	17.84	20.31	19.92	19.34
HSUPA	Sub - Test 1	19.97	20.00	19.94	16.97	16.50	16.34	18.77	18.20	17.84
	Sub - Test 2	20.11	20.16	20.10	17.11	16.66	16.50	18.91	18.36	18.00
	Sub - Test 3	20.95	21.06	21.08	17.95	17.56	17.48	19.75	19.26	18.98
	Sub - Test 4	19.57	19.54	19.60	16.57	16.04	16.00	18.37	17.74	17.50
	Sub - Test 5	21.03	21.14	21.00	18.03	17.64	17.40	19.83	19.34	18.90
DC-HSDPA	Sub - Test 1	21.67	21.46	21.64	18.67	17.96	18.04	20.47	19.66	19.54
	Sub - Test 2	21.41	21.46	21.74	18.41	17.96	18.14	20.21	19.66	19.64
	Sub - Test 3	21.51	21.64	21.52	18.51	18.14	17.92	20.31	19.84	19.42
	Sub - Test 4	21.35	21.72	21.64	18.35	18.22	18.04	20.15	19.92	19.54
HSPA+	16QAM	21.90	22.03	22.00	18.90	18.53	18.40	20.70	20.23	19.90



LTE Band 2				Maximum Output Power(dBm)			EIRP (dBm) Main Antenna			EIRP (dBm) Second antenna		
BW	Modulation	RB size	RB offset	Channel/Frequency(MHz)								
				18607/1850.7	18900/1880	19193/1909.3	18607/1850.7	18900/1880	19193/1909.3	18607/1850.7	18900/1880	19193/1909.3
1.4MHz	QPSK	1	0	24.25	24.21	24.15	21.25	20.71	20.55	23.05	22.41	22.05
		1	2	24.40	24.33	24.35	21.40	20.83	20.75	23.20	22.53	22.25
		1	5	24.18	24.09	24.20	21.18	20.59	20.60	22.98	22.29	22.10
		3	0	24.06	24.44	24.29	21.06	20.94	20.69	22.86	22.64	22.19
		3	2	24.22	24.34	24.29	21.22	20.84	20.69	23.02	22.54	22.19
		3	3	24.21	24.30	24.31	21.21	20.80	20.71	23.01	22.50	22.21
		6	0	23.25	23.38	23.30	20.25	19.88	19.70	22.05	21.58	21.20
	16QAM	1	0	23.61	23.38	23.41	20.61	19.88	19.81	22.41	21.58	21.31
		1	2	23.59	23.80	22.71	20.59	20.30	19.11	22.39	22.00	20.61
		1	5	23.65	23.73	23.44	20.65	20.23	19.84	22.45	21.93	21.34
		3	0	23.40	23.29	23.29	20.40	19.79	19.69	22.20	21.49	21.19
		3	2	23.39	23.31	23.41	20.39	19.81	19.81	22.19	21.51	21.31
		3	3	23.36	23.41	23.40	20.36	19.91	19.80	22.16	21.61	21.30
		6	0	22.41	22.43	22.43	19.41	18.93	18.83	21.21	20.63	20.33
	64QAM	1	0	22.36	22.41	22.45	19.36	18.91	18.85	21.16	20.61	20.35
		1	2	22.54	22.61	22.52	19.54	19.11	18.92	21.34	20.81	20.42
		1	5	22.38	22.47	22.34	19.38	18.97	18.74	21.18	20.67	20.24
		3	0	22.45	22.49	22.38	19.45	18.99	18.78	21.25	20.69	20.28
		3	2	22.42	22.45	22.32	19.42	18.95	18.72	21.22	20.65	20.22
		3	3	22.44	22.50	22.34	19.44	19.00	18.74	21.24	20.70	20.24
		6	0	21.36	21.56	21.47	18.36	18.06	17.87	20.16	19.76	19.37
BW	Modulation	RB size	RB offset	Channel/Frequency(MHz)								
				18615/1851.5	18900/1880	19185/1908.5	18615/1851.5	18900/1880	19185/1908.5	18615/1851.5	18900/1880	19185/1908.5
3MHz	QPSK	1	0	24.27	24.25	24.18	21.27	20.75	20.58	23.07	22.45	22.08
		1	7	24.38	24.36	24.39	21.38	20.86	20.79	23.18	22.56	22.29
		1	14	24.21	24.14	24.24	21.21	20.64	20.64	23.01	22.34	22.14
		8	0	23.16	23.56	23.42	20.16	20.06	19.82	21.96	21.76	21.32
		8	4	23.34	23.44	23.41	20.34	19.94	19.81	22.14	21.64	21.31
		8	7	23.31	23.41	23.41	20.31	19.91	19.81	22.11	21.61	21.31
		15	0	23.25	23.42	23.33	20.25	19.92	19.73	22.05	21.62	21.23
	16QAM	1	0	23.64	23.40	23.44	20.64	19.90	19.84	22.44	21.60	21.34



		1	7	23.62	23.80	22.75	20.62	20.30	19.15	22.42	22.00	20.65
		1	14	23.67	23.77	23.47	20.67	20.27	19.87	22.47	21.97	21.37
		8	0	22.51	22.42	22.41	19.51	18.92	18.81	21.31	20.62	20.31
		8	4	22.50	22.44	22.53	19.50	18.94	18.93	21.30	20.64	20.43
		8	7	22.46	22.53	22.53	19.46	19.03	18.93	21.26	20.73	20.43
		15	0	22.44	22.47	22.46	19.44	18.97	18.86	21.24	20.67	20.36
	64QAM	1	0	22.39	22.43	22.48	19.39	18.93	18.88	21.19	20.63	20.38
		1	7	22.57	22.61	22.54	19.57	19.11	18.94	21.37	20.81	20.44
		1	14	22.40	22.46	22.37	19.40	18.96	18.77	21.20	20.66	20.27
		8	0	21.56	21.62	21.50	18.56	18.12	17.90	20.36	19.82	19.40
		8	4	21.53	21.58	21.44	18.53	18.08	17.84	20.33	19.78	19.34
		8	7	21.54	21.62	21.47	18.54	18.12	17.87	20.34	19.82	19.37
		15	0	21.39	21.60	21.50	18.39	18.10	17.90	20.19	19.80	19.40
	BW	Modulation	RB size	RB offset	Channel/Frequency(MHz)							
18625/ 1852.5					18900/ 1880	19175/ 1907.5	18625/ 1852.5	18900/ 1880	19175/ 1907.5	18625/ 1852.5	18900/ 1880	19175/ 1907.5
5MHz	QPSK	1	0	24.24	24.23	24.14	21.24	20.73	20.54	23.04	22.43	22.04
		1	13	24.36	24.32	24.36	21.36	20.82	20.76	23.16	22.52	22.26
		1	24	24.18	24.09	24.20	21.18	20.59	20.60	22.98	22.29	22.10
		12	0	23.13	23.51	23.38	20.13	20.01	19.78	21.93	21.71	21.28
		12	6	23.32	23.40	23.36	20.32	19.90	19.76	22.12	21.60	21.26
		12	13	23.29	23.39	23.37	20.29	19.89	19.77	22.09	21.59	21.27
		25	0	23.25	23.41	23.31	20.25	19.91	19.71	22.05	21.61	21.21
	16QAM	1	0	23.61	23.36	23.41	20.61	19.86	19.81	22.41	21.56	21.31
		1	13	23.59	23.78	22.72	20.59	20.28	19.12	22.39	21.98	20.62
		1	24	23.64	23.75	23.43	20.64	20.25	19.83	22.44	21.95	21.33
		12	0	22.49	22.38	22.38	19.49	18.88	18.78	21.29	20.58	20.28
		12	6	22.47	22.39	22.49	19.47	18.89	18.89	21.27	20.59	20.39
		12	13	22.43	22.48	22.49	19.43	18.98	18.89	21.23	20.68	20.39
		25	0	22.42	22.43	22.41	19.42	18.93	18.81	21.22	20.63	20.31
	64QAM	1	0	22.36	22.43	22.45	19.36	18.93	18.85	21.16	20.63	20.35
		1	13	22.54	22.63	22.51	19.54	19.13	18.91	21.34	20.83	20.41
		1	24	22.41	22.44	22.33	19.41	18.94	18.73	21.21	20.64	20.23
		12	0	21.54	21.58	21.51	18.54	18.08	17.91	20.34	19.78	19.41
		12	6	21.50	21.53	21.40	18.50	18.03	17.80	20.30	19.73	19.30
		12	13	21.51	21.57	21.43	18.51	18.07	17.83	20.31	19.77	19.33
		25	0	21.37	21.56	21.45	18.37	18.06	17.85	20.17	19.76	19.35



BW	Modulation	RB size	RB offset	Channel/Frequency(MHz)								
				18650/1855	18900/1880	19150/1905	18650/1855	18900/1880	19150/1905	18650/1855	18900/1880	19150/1905
10MHz	QPSK	1	0	24.26	24.24	24.17	21.26	20.74	20.57	23.06	22.44	22.07
		1	25	24.39	24.37	24.40	21.39	20.87	20.80	23.19	22.57	22.30
		1	49	24.20	24.13	24.23	21.20	20.63	20.63	23.00	22.33	22.13
		25	0	23.16	23.56	23.42	20.16	20.06	19.82	21.96	21.76	21.32
		25	13	23.35	23.45	23.40	20.35	19.95	19.80	22.15	21.65	21.30
		25	25	23.31	23.43	23.42	20.31	19.93	19.82	22.11	21.63	21.32
		50	0	23.29	23.43	23.35	20.29	19.93	19.75	22.09	21.63	21.25
	16QAM	1	0	23.63	23.39	23.43	20.63	19.89	19.83	22.43	21.59	21.33
		1	25	23.62	23.82	22.75	20.62	20.32	19.15	22.42	22.02	20.65
		1	49	23.67	23.77	23.46	20.67	20.27	19.86	22.47	21.97	21.36
		25	0	22.52	22.43	22.42	19.52	18.93	18.82	21.32	20.63	20.32
		25	13	22.49	22.43	22.52	19.49	18.93	18.92	21.29	20.63	20.42
		25	25	22.46	22.53	22.53	19.46	19.03	18.93	21.26	20.73	20.43
		50	0	22.45	22.48	22.45	19.45	18.98	18.85	21.25	20.68	20.35
	64QAM	1	0	22.38	22.42	22.47	19.38	18.92	18.87	21.18	20.62	20.37
		1	25	22.57	22.63	22.54	19.57	19.13	18.94	21.37	20.83	20.44
		1	49	22.40	22.46	22.36	19.40	18.96	18.76	21.20	20.66	20.26
		25	0	21.57	21.63	21.51	18.57	18.13	17.91	20.37	19.83	19.41
		25	13	21.52	21.57	21.43	18.52	18.07	17.83	20.32	19.77	19.33
		25	25	21.54	21.62	21.47	18.54	18.12	17.87	20.34	19.82	19.37
		50	0	21.40	21.61	21.49	18.40	18.11	17.89	20.20	19.81	19.39
BW	Modulation	RB size	RB offset	Channel/Frequency(MHz)								
				18675/1857.5	18900/1880	19125/1902.5	18675/1857.5	18900/1880	19125/1902.5	18675/1857.5	18900/1880	19125/1902.5
15MHz	QPSK	1	0	24.25	24.20	24.15	21.25	20.70	20.55	23.05	22.40	22.05
		1	38	24.37	24.36	24.37	21.37	20.86	20.77	23.17	22.56	22.27
		1	74	24.17	24.08	24.19	21.17	20.58	20.59	22.97	22.28	22.09
		36	0	23.14	23.52	23.39	20.14	20.02	19.79	21.94	21.72	21.29
		36	18	23.32	23.40	23.36	20.32	19.90	19.76	22.12	21.60	21.26
		36	39	23.28	23.40	23.38	20.28	19.90	19.78	22.08	21.60	21.28
		75	0	23.27	23.39	23.30	20.27	19.89	19.70	22.07	21.59	21.20
	16QAM	1	0	23.58	23.37	23.41	20.58	19.87	19.81	22.38	21.57	21.31
		1	38	23.60	23.79	22.73	20.60	20.29	19.13	22.40	21.99	20.63
		1	74	23.64	23.73	23.43	20.64	20.23	19.83	22.44	21.93	21.33



		36	0	22.49	22.41	22.39	19.49	18.91	18.79	21.29	20.61	20.29	
		36	18	22.46	22.38	22.48	19.46	18.88	18.88	21.26	20.58	20.38	
		36	39	22.44	22.49	22.50	19.44	18.99	18.90	21.24	20.69	20.40	
		75	0	22.42	22.43	22.41	19.42	18.93	18.81	21.22	20.63	20.31	
	64QAM	1	0	22.33	22.40	22.45	19.33	18.90	18.85	21.13	20.60	20.35	
		1	38	22.55	22.60	22.52	19.55	19.10	18.92	21.35	20.80	20.42	
		1	74	22.41	22.45	22.37	19.41	18.95	18.77	21.21	20.65	20.27	
		36	0	21.56	21.65	21.52	18.56	18.15	17.92	20.36	19.85	19.42	
		36	18	21.50	21.54	21.42	18.50	18.04	17.82	20.30	19.74	19.32	
		36	39	21.52	21.58	21.44	18.52	18.08	17.84	20.32	19.78	19.34	
		75	0	21.37	21.56	21.45	18.37	18.06	17.85	20.17	19.76	19.35	
	BW	Modulation	RB size	RB offset	Channel/Frequency(MHz)								
					18700/1860	18900/1880	19100/1900	18700/1860	18900/1880	19100/1900	18700/1860	18900/1880	19100/1900
20MHz	QPSK	1	0	24.22	24.16	24.12	21.22	20.66	20.52	23.02	22.36	22.02	
		1	50	24.36	24.32	24.35	21.36	20.82	20.75	23.16	22.52	22.25	
		1	99	24.15	24.07	24.16	21.15	20.57	20.56	22.95	22.27	22.06	
		50	0	23.11	23.47	23.35	20.11	19.97	19.75	21.91	21.67	21.25	
		50	25	23.30	23.36	23.33	20.30	19.86	19.73	22.10	21.56	21.23	
		50	50	23.25	23.35	23.34	20.25	19.85	19.74	22.05	21.55	21.24	
		100	0	23.24	23.34	23.26	20.24	19.84	19.66	22.04	21.54	21.16	
	16QAM	1	0	23.31	23.33	23.36	20.31	19.83	19.76	22.11	21.53	21.26	
		1	50	23.56	23.77	22.69	20.56	20.27	19.09	22.36	21.97	20.59	
		1	99	23.62	23.70	23.41	20.62	20.20	19.81	22.42	21.90	21.31	
		50	0	22.46	22.37	22.36	19.46	18.87	18.76	21.26	20.57	20.26	
		50	25	22.43	22.36	22.45	19.43	18.86	18.85	21.23	20.56	20.35	
		50	50	22.41	22.44	22.46	19.41	18.94	18.86	21.21	20.64	20.36	
		100	0	22.40	22.39	22.38	19.40	18.89	18.78	21.20	20.59	20.28	
	64QAM	1	0	22.31	22.36	22.40	19.31	18.86	18.80	21.11	20.56	20.30	
		1	50	22.51	22.58	22.48	19.51	19.08	18.88	21.31	20.78	20.38	
		1	99	22.35	22.39	22.31	19.35	18.89	18.71	21.15	20.59	20.21	
		50	0	21.51	21.57	21.45	18.51	18.07	17.85	20.31	19.77	19.35	
		50	25	21.46	21.50	21.36	18.46	18.00	17.76	20.26	19.70	19.26	
		50	50	21.49	21.53	21.40	18.49	18.03	17.80	20.29	19.73	19.30	
		100	0	21.35	21.52	21.42	18.35	18.02	17.82	20.15	19.72	19.32	

5.2.Occupied Bandwidth

Ambient condition

Temperature	Relative humidity	Pressure
23°C ~25°C	45%~50%	101.5kPa

Method of Measurement

The EUT was connected to Spectrum Analyzer and Base Station Simulator via power Splitter. The occupied bandwidth is measured using spectrum analyzer.

RBW is set to 6.2kHz, VBW is set to 20kHz for GSM 1900,

RBW is set to 51 kHz, VBW is set to 160kHz for WCDMA Band II,

RBW is set to 30 kHz, VBW is set to 91kHz for LTE Band 2 (1.4MHz),

RBW is set to 62 kHz, VBW is set to 180 kHz for LTE Band 2 (3MHz),

RBW is set to 100 kHz, VBW is set to 300 kHz for LTE Band 2 (5MHz),

RBW is set to 200 kHz, VBW is set to 620kHz for LTE Band 2 (10MHz),

RBW is set to 300kHz,VBW is set to 910kHz for LTE Band 2 (15MHz).

RBW is set to 430kHz,VBW is set to 1.2MHz for LTE Band 2 (20MHz).

99% power and -26dBc occupied bandwidths are recorded. Spectrum analyzer plots are included on the following pages.

Test Setup

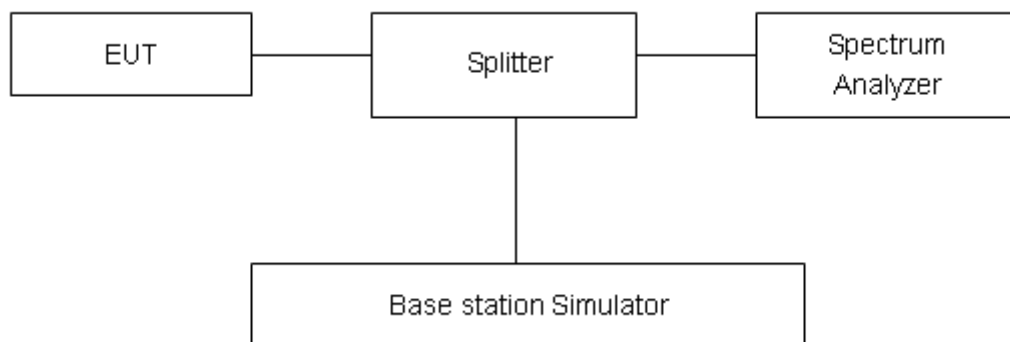

Limits

No specific occupied bandwidth requirements in part 2.1049.

Measurement Uncertainty

The assessed measurement uncertainty to ensure 95% confidence level for the normal distribution is with the coverage factor $k = 2$, $U = 624\text{Hz}$.



Test Result

Mode	Channel	Frequency (MHz)	99% Power Bandwidth (MHz)	-26dBc Bandwidth(MHz)
GSM 1900 (GMSK)	512	1850.2	0.2462	0.3149
	661	1880.0	0.2427	0.3000
	810	1909.8	0.2462	0.2981
GPRS 1900 (GMSK)	512	1850.2	0.2428	0.3192
	661	1880.0	0.2474	0.3151
	810	1909.8	0.2430	0.3160
EGPRS 1900 (8PSK)	512	1850.2	0.2443	0.2990
	661	1880.0	0.2464	0.3110
	810	1909.8	0.2399	0.3090
WCDMA Band II (RMC)	9262	1852.4	4.1487	4.6480
	9400	1880	4.1538	4.6600
	9538	1907.6	4.1613	4.6590

LTE Band 2					
Modulation	Bandwidth (MHz)	Channel	Frequency (MHz)	99% Power Bandwidth(MHz)	-26dBc Bandwidth(MHz)
QPSK	1.4	18607	1850.7	1.1043	1.254
		18900	1880.0	1.0961	1.268
		19193	1909.3	1.0949	1.267
	3	18615	1851.5	2.6870	2.957
		18900	1880	2.6782	2.957
		19185	1908.5	2.6904	2.939
	5	18625	1852.5	4.5094	4.899
		18900	1880	4.5133	4.872
		19175	1907.5	4.5096	4.894
	10	18650	1855	8.9673	9.645
		18900	1880	8.9814	9.683
		19150	1905	8.9926	9.703
	15	18675	1857.5	13.4670	14.600
		18900	1880	13.4720	14.420
		19125	1902.5	13.4540	14.530
	20	18700	1860	17.8860	19.050
		18900	1880	18.0030	19.280



		19100	1900	17.9230	19.210
16QAM	1.4	18607	1850.7	1.0986	1.277
		18900	1880.0	1.1018	1.272
		19193	1909.3	1.0908	1.254
	3	18615	1851.5	2.6886	2.949
		18900	1880	2.6928	2.954
		19185	1908.5	2.6904	2.980
	5	18625	1852.5	4.5105	4.846
		18900	1880	4.5053	4.874
		19175	1907.5	4.5127	4.888
	10	18650	1855	8.9714	9.620
		18900	1880	8.9899	9.726
		19150	1905	8.9468	9.695
	15	18675	1857.5	13.4330	14.500
		18900	1880	13.4490	14.540
		19125	1902.5	13.4590	14.380
	20	18700	1860	17.8680	19.210
		18900	1880	18.0030	19.380
		19100	1900	17.9450	19.330
64QAM	1.4	18607	1850.7	1.0996	1.283
		18900	1880	1.0995	1.273
		19193	1909.3	1.0892	1.269
	3	18615	1851.5	2.6864	2.977
		18900	1880	2.6883	2.978
		19185	1908.5	2.6879	2.953
	5	18625	1852.5	4.5183	4.897
		18900	1880	4.5080	4.902
		19175	1907.5	4.5021	4.855
	10	18650	1855	8.9750	9.739
		18900	1880	8.9768	9.664
		19150	1905	8.9909	9.713
	15	18675	1857.5	13.4960	14.390
		18900	1880	13.4840	14.390
		19125	1902.5	13.4620	14.530
	20	18700	1860	17.8860	19.430
		18900	1880	18.0280	19.200
		19100	1900	17.9180	19.250

GSM1900 GSM CH-Low



GSM1900 GPRS CH-Low



GSM 1900 GSM CH-Middle



GSM 1900 GPRS CH-Middle



GSM 1900 GSM CH-High



GSM 1900 GPRS CH-High



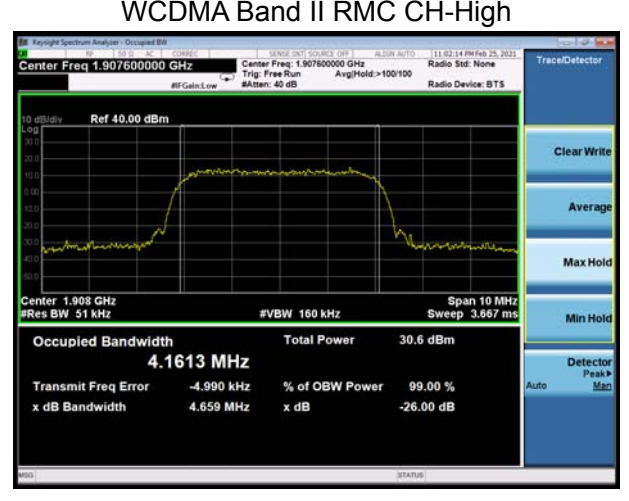
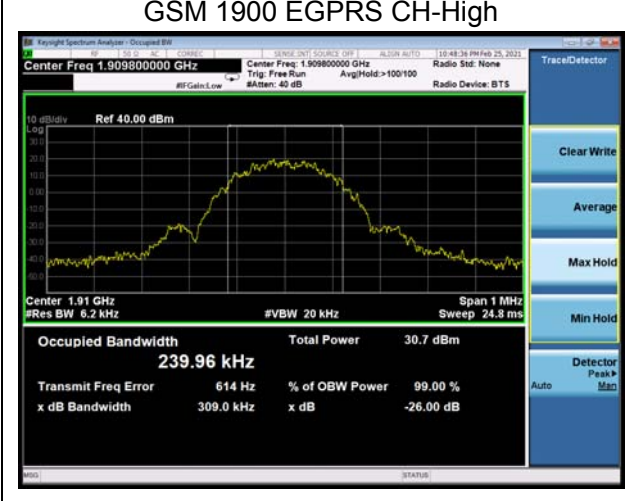
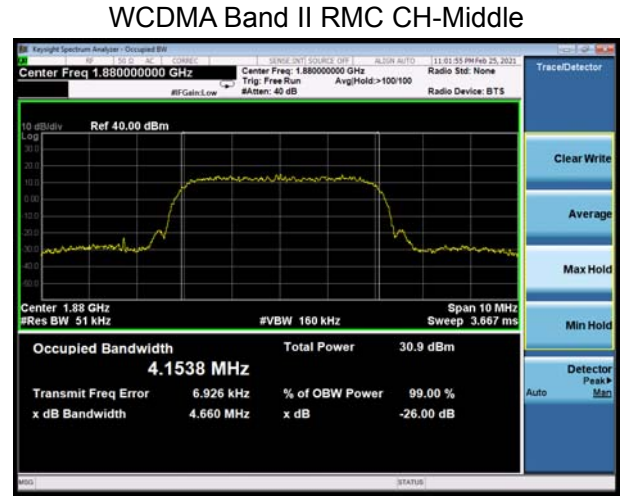
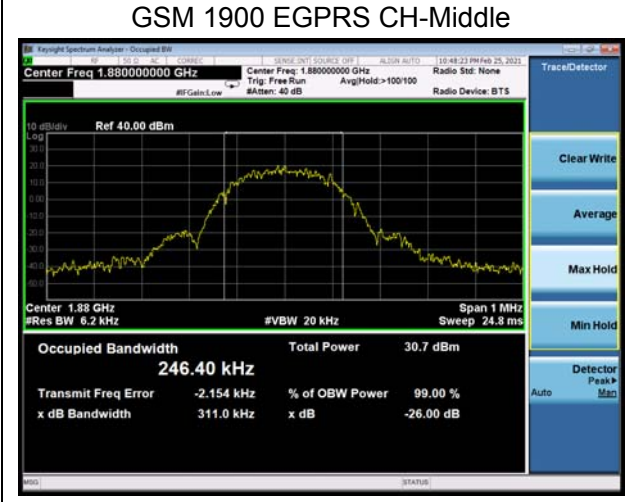
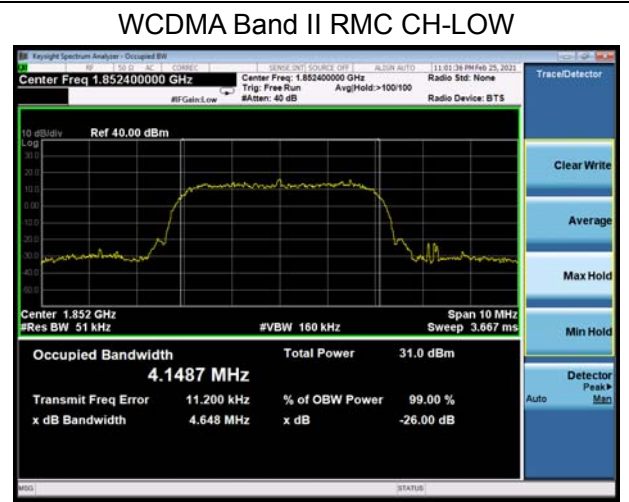



LTE Band 2 1.4MHz QPSK CH-Low

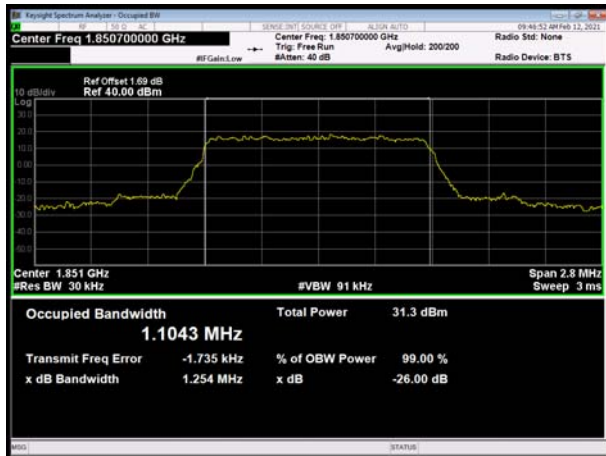

LTE Band 2 3MHz QPSK CH-Low

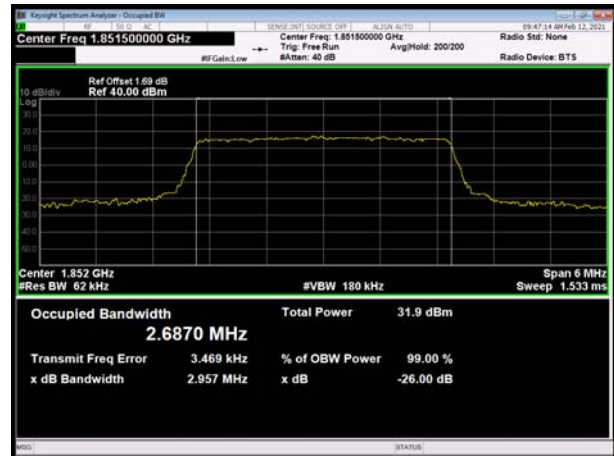

LTE Band 2 1.4MHz QPSK CH-Middle



LTE Band 2 3MHz QPSK CH-Middle

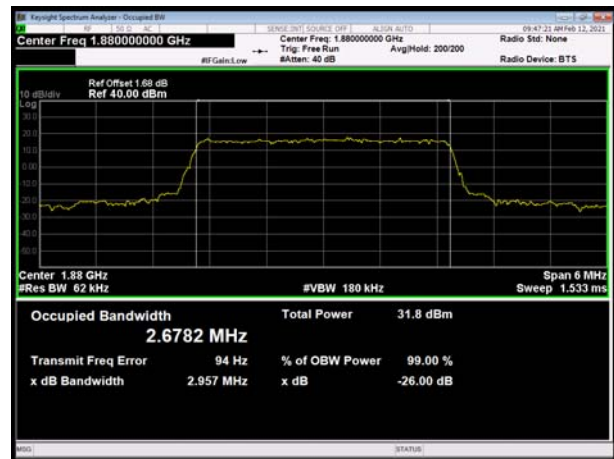

LTE Band 2 1.4MHz QPSK CH-High

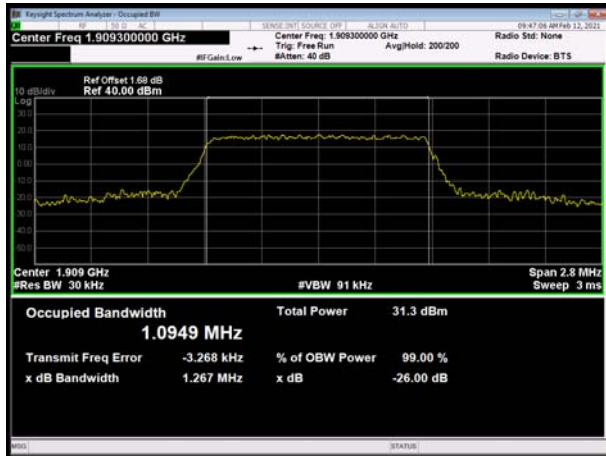

LTE Band 2 3MHz QPSK CH-High

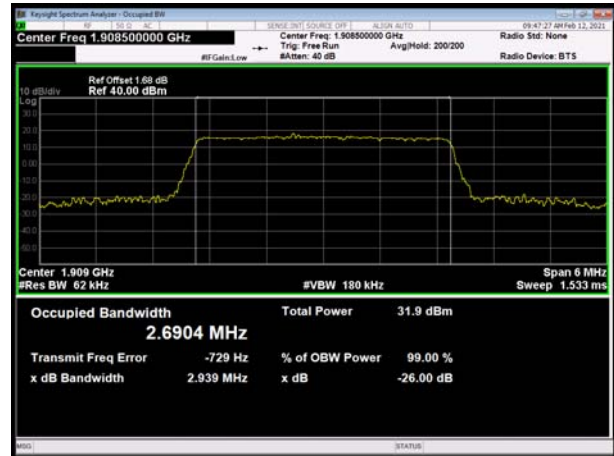



LTE Band 2 5MHz QPSK CH-Low

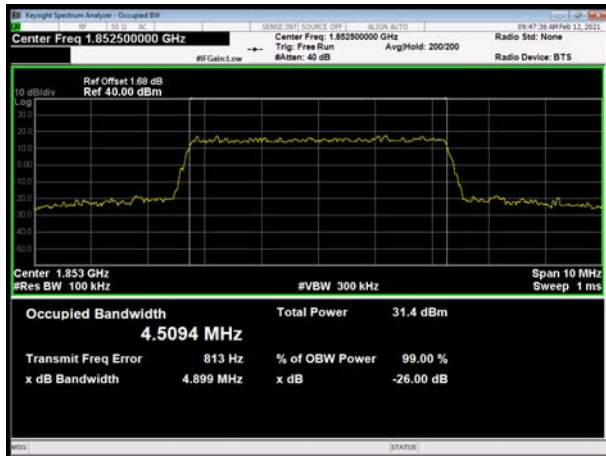

LTE Band 2 10MHz QPSK CH-Low

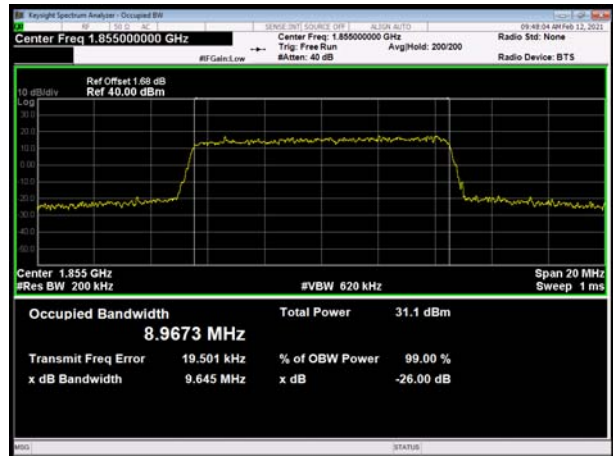

LTE Band 2 5MHz QPSK CH-Middle

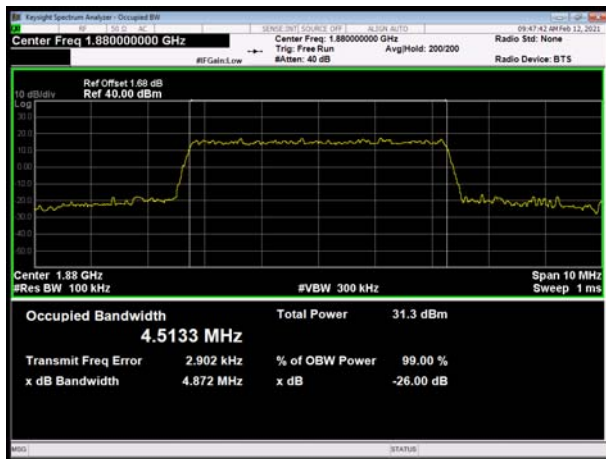

LTE Band 2 10MHz QPSK CH-Middle



LTE Band 2 5MHz QPSK CH-High



LTE Band 2 10MHz QPSK CH-High

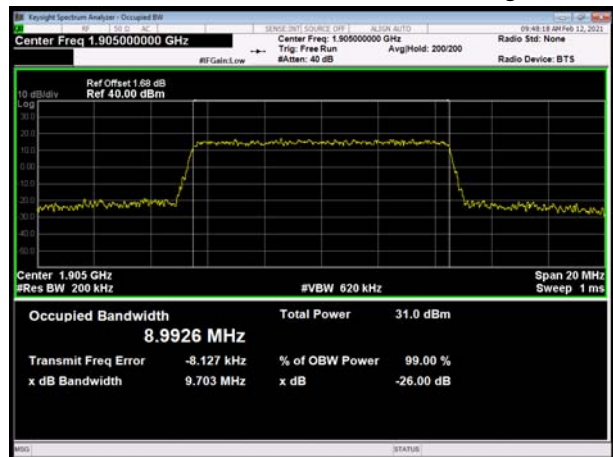



LTE Band 2 15MHz QPSK CH-Low

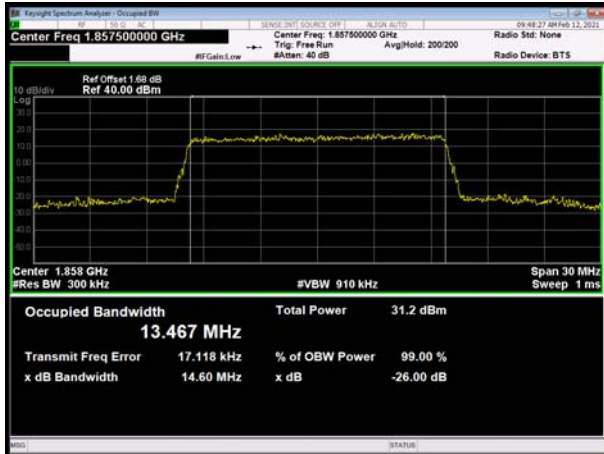

LTE Band 2 20MHz QPSK CH-Low

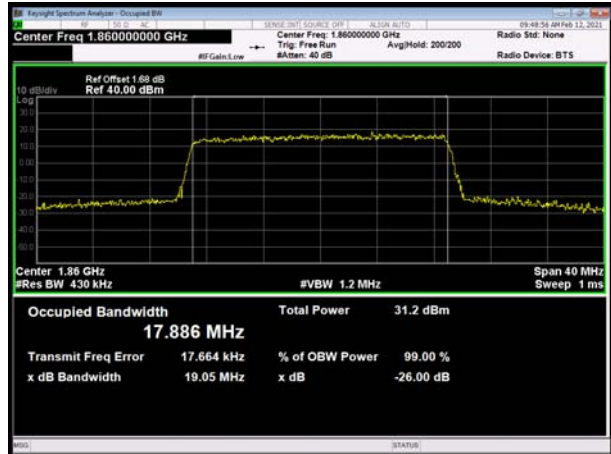

LTE Band 2 15MHz QPSK CH-Middle

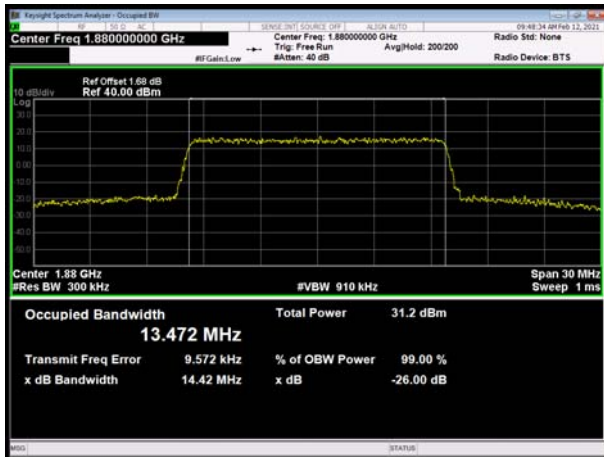

LTE Band 2 20MHz QPSK CH-Middle

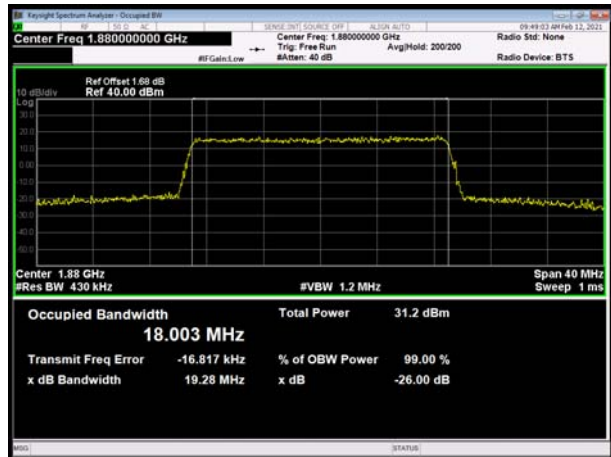

LTE Band 2 15MHz QPSK CH-High

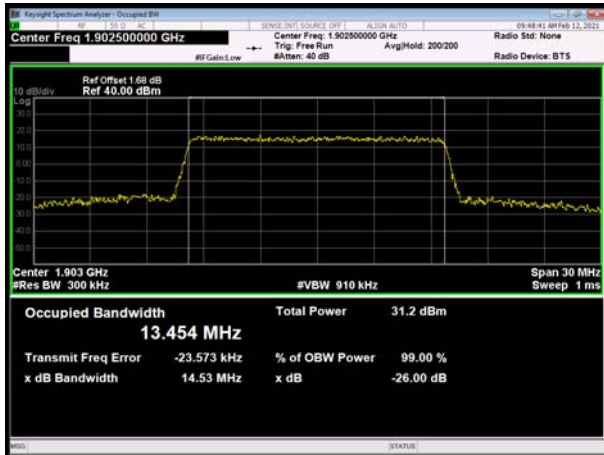

LTE Band 2 20MHz QPSK CH-High

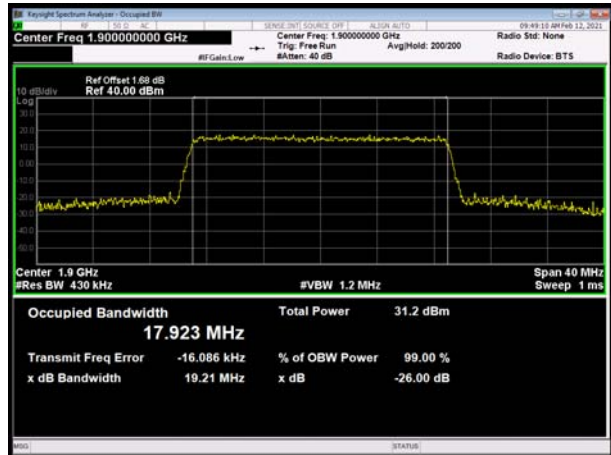

LTE Band 2 1.4MHz 16QAM CH-Low



LTE Band 2 3MHz 16QAM CH-Low

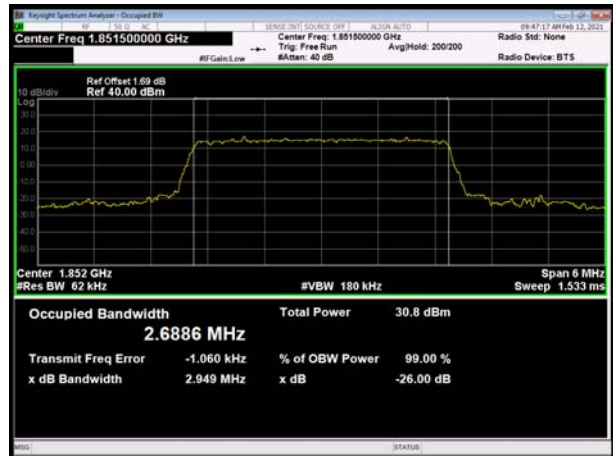

LTE Band 2 1.4MHz 16QAM CH-Middle

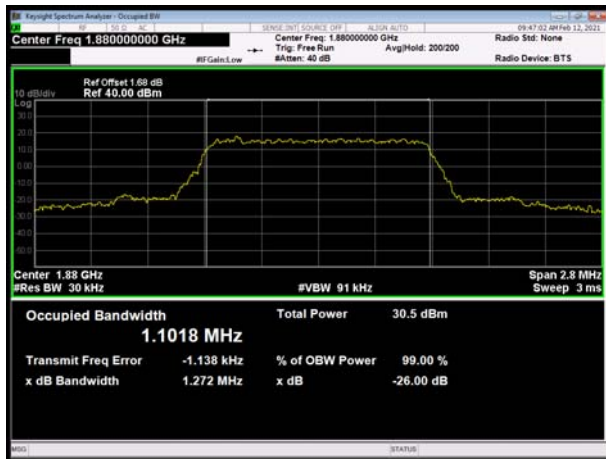

LTE Band 2 3MHz 16QAM CH-Middle

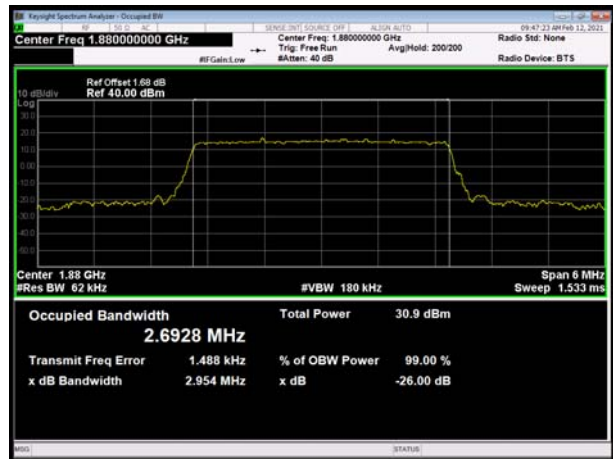

LTE Band 2 1.4MHz 16QAM CH-High

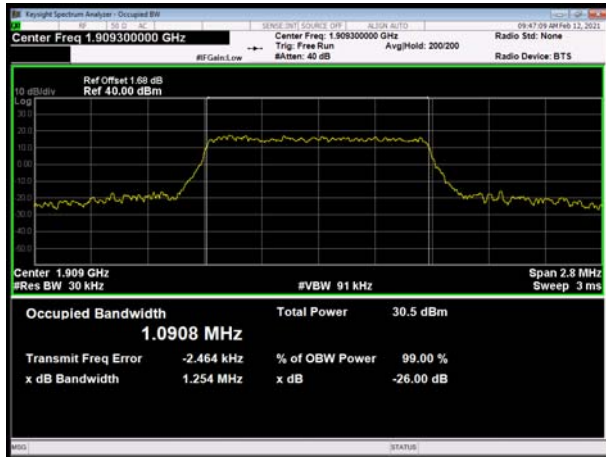

LTE Band 2 3MHz 16QAM CH-High

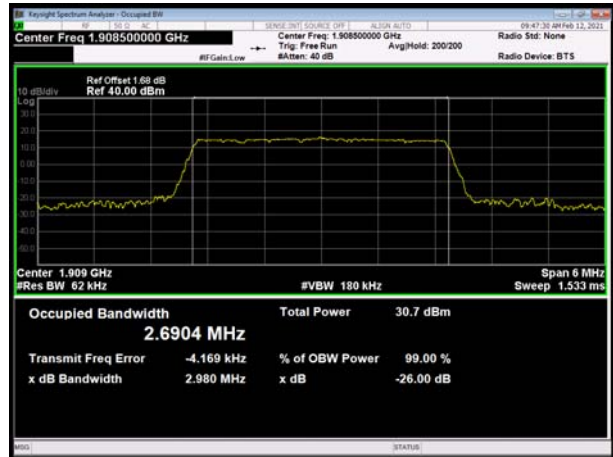



LTE Band 2 5MHz 16QAM CH-Low

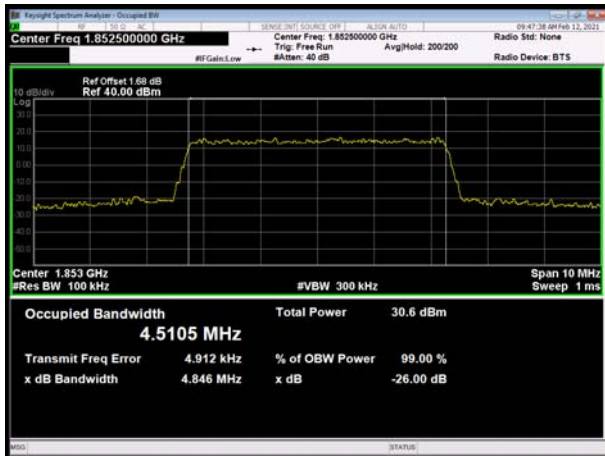

LTE Band 2 10MHz 16QAM CH-Low

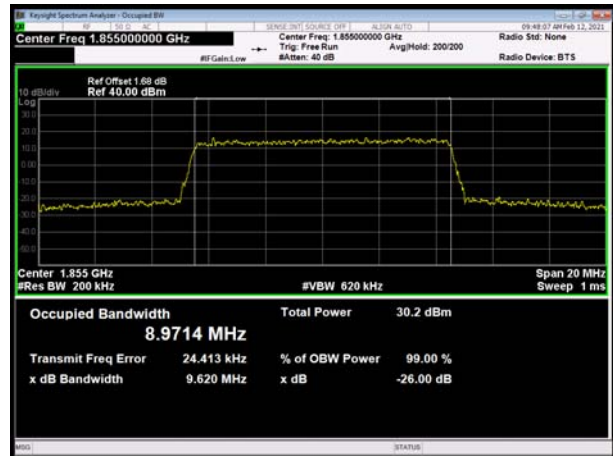

LTE Band 2 5MHz 16QAM CH-Middle

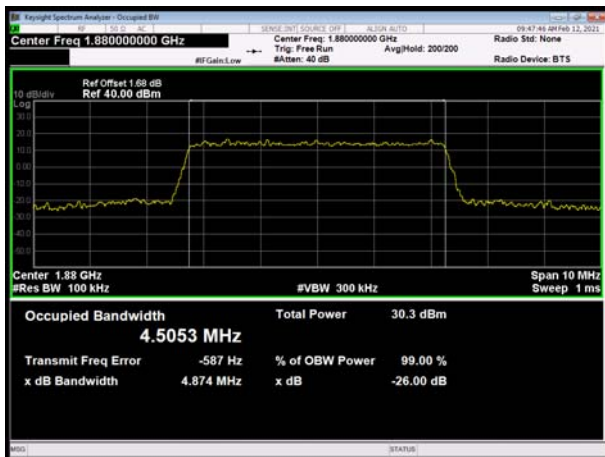

LTE Band 2 10MHz 16QAM CH-Middle



LTE Band 2 5MHz 16QAM CH-High

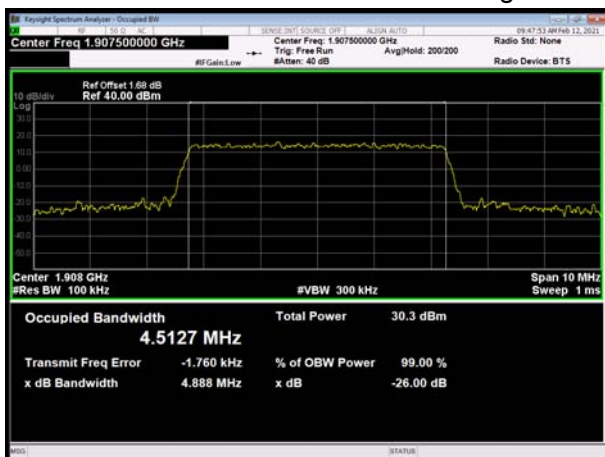

LTE Band 2 10MHz 16QAM CH-High

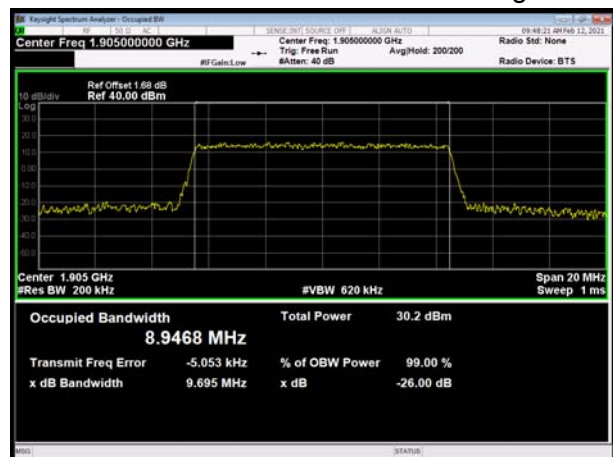

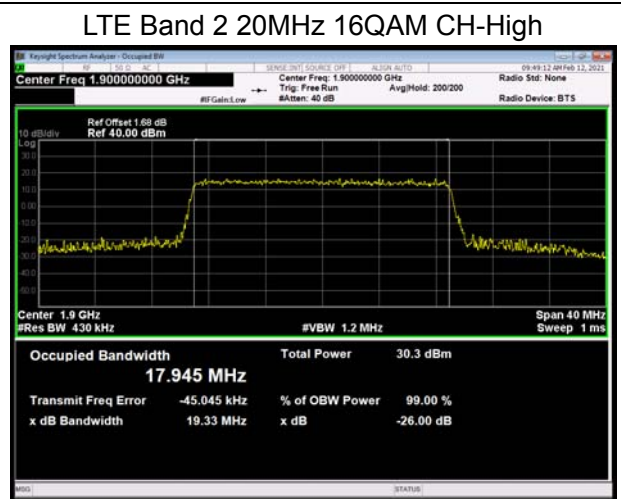
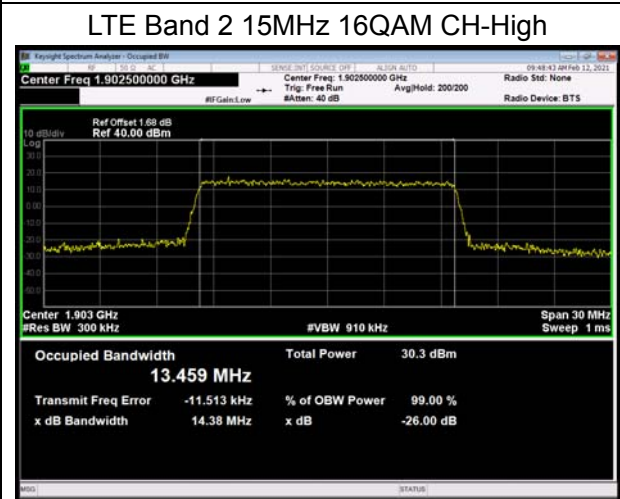
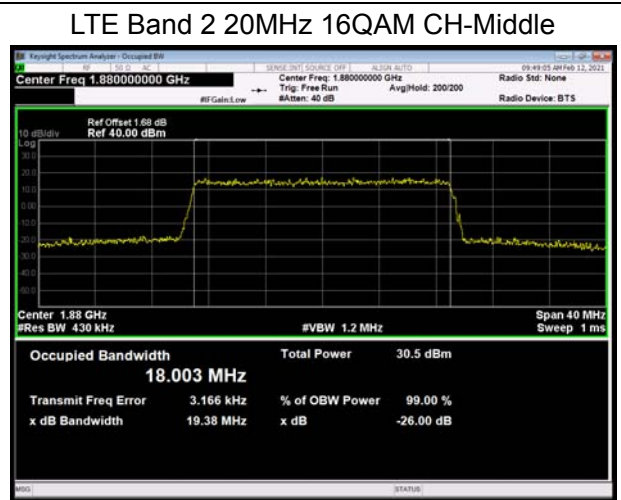
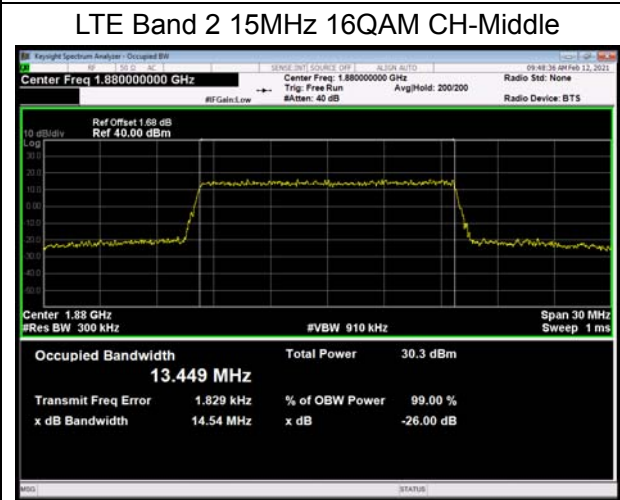
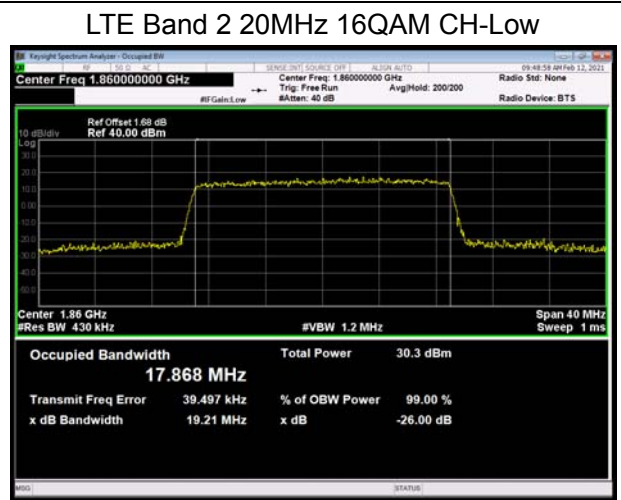
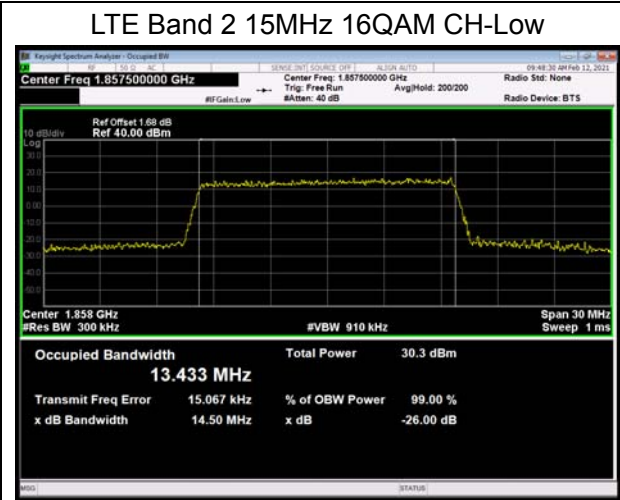

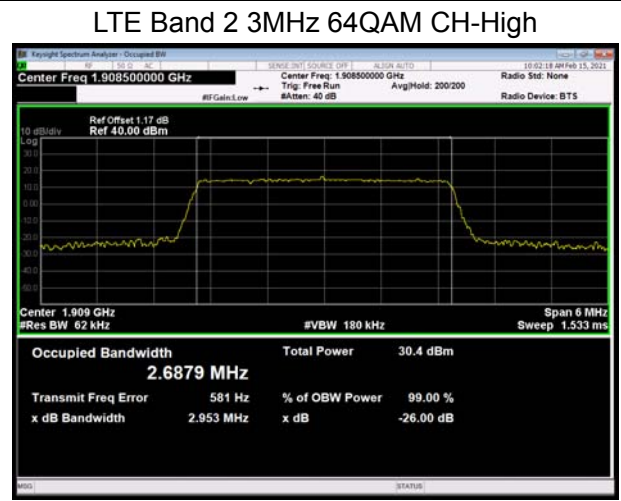
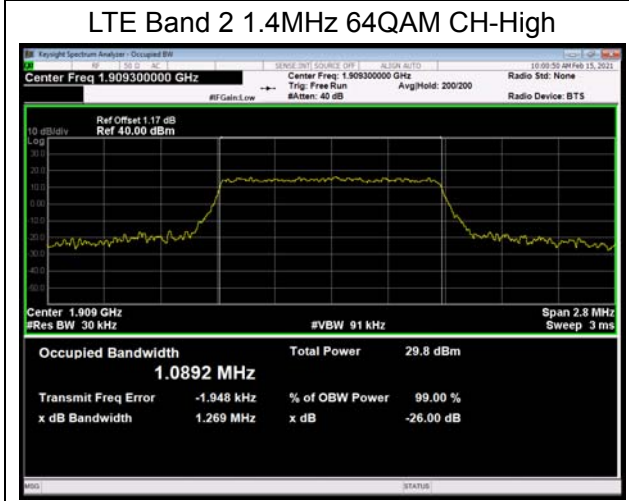
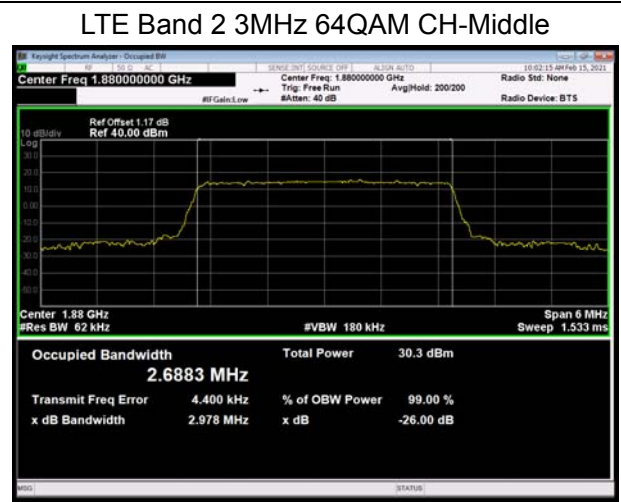
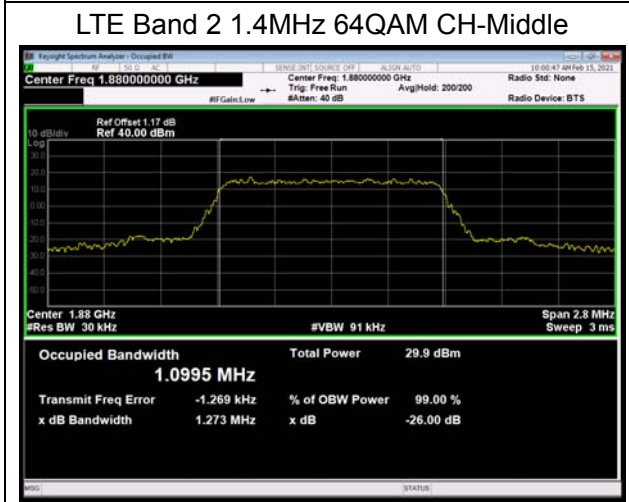
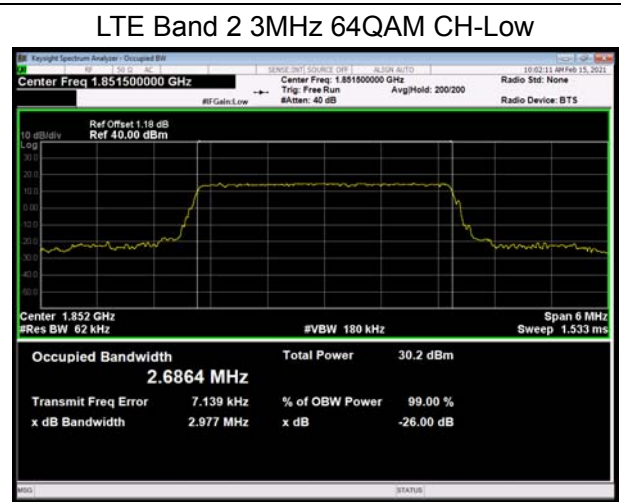
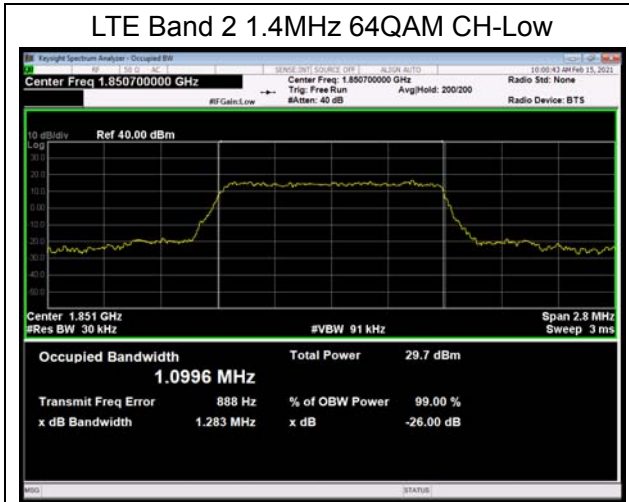



LTE Band 2 5MHz 64QAM CH-Low

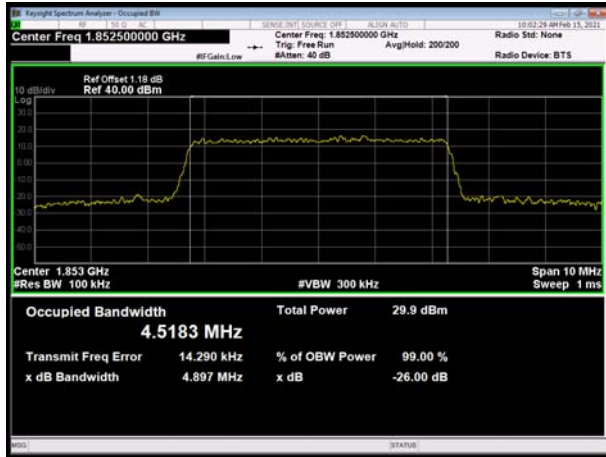

LTE Band 2 10MHz 64QAM CH-Low

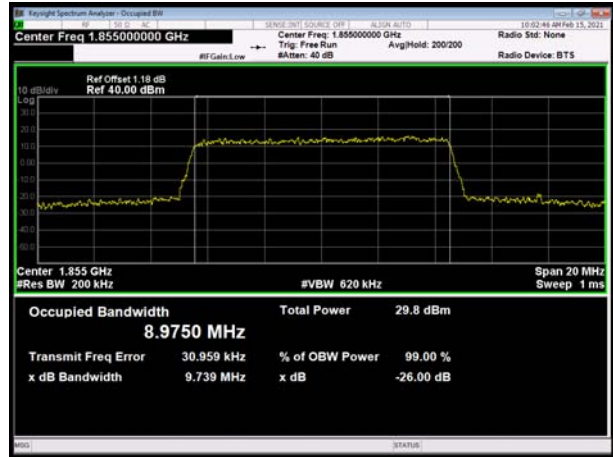

LTE Band 2 5MHz 64QAM CH-Middle

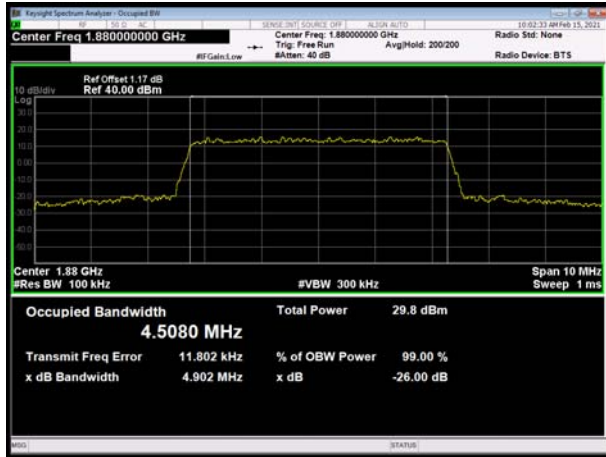

LTE Band 2 10MHz 64QAM CH-Middle

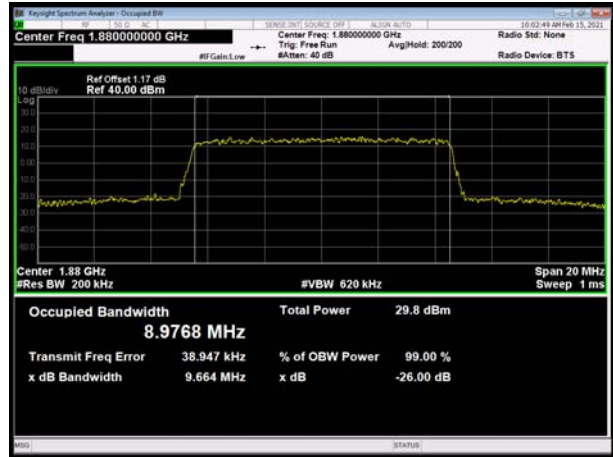

LTE Band 2 5MHz 64QAM CH-High

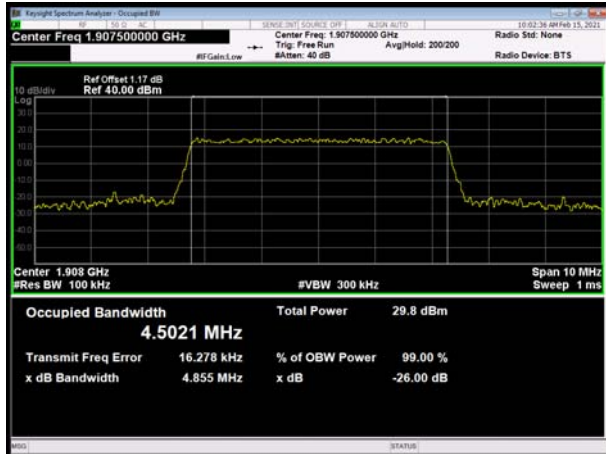

LTE Band 2 10MHz 64QAM CH-High

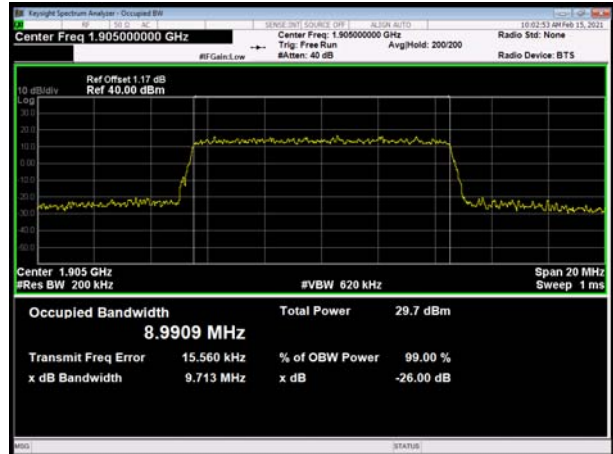

LTE Band 2 15MHz 64QAM CH-Low

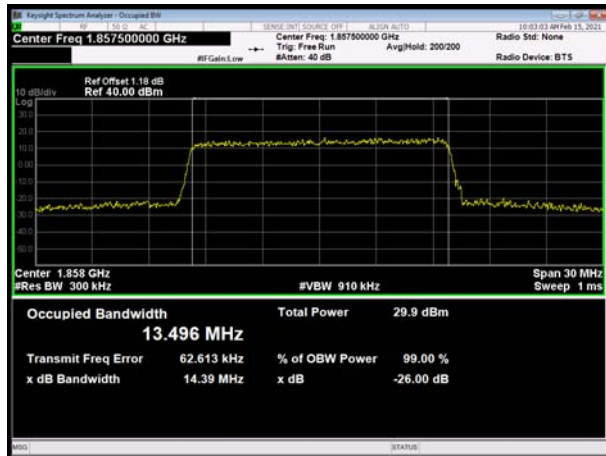

LTE Band 2 20MHz 64QAM CH-Low

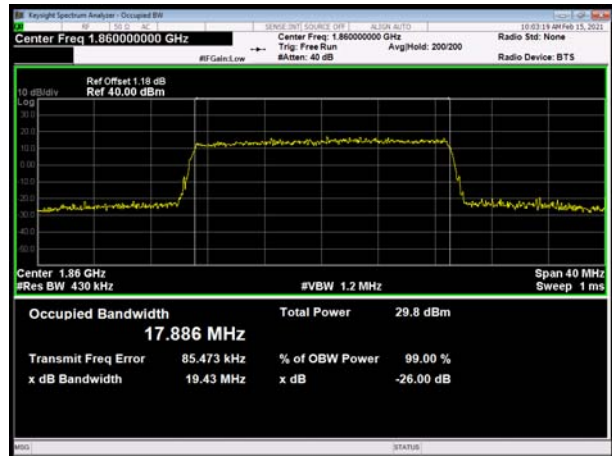

LTE Band 2 15MHz 64QAM CH-Middle

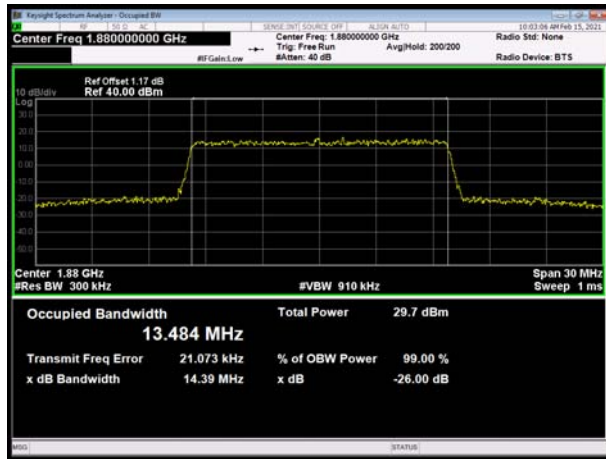

LTE Band 2 20MHz 64QAM CH-Middle



LTE Band 2 15MHz 64QAM CH-High

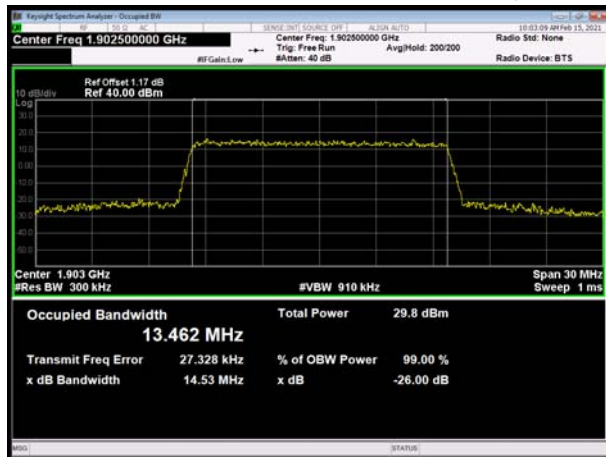

LTE Band 2 20MHz 64QAM CH-High



5.3. Band Edge Compliance

Ambient condition

Temperature	Relative humidity	Pressure
23°C ~25°C	45%~50%	101.5kPa

Method of Measurement

The EUT was connected to Spectrum Analyzer and Base Station Simulator via power Splitter. The band edge of the lowest and highest channels were measured. The Average detector is used and RBW is set to 6.2kHz, VBW is set to 20kHz for GSM 1900, RBW is set to 51kHz, VBW is set to 160kHz for WCDMA Band II, RBW is set to 15kHz, VBW is set to 43kHz for LTE Band 2/25 (1.4MHz), RBW is set to 30kHz, VBW is set to 91kHz for LTE Band 2/25 (3MHz), RBW is set to 51kHz, VBW is set to 150kHz for LTE Band 2/25 (5MHz), RBW is set to 100kHz, VBW is set to 300kHz for LTE Band 2/25 (10MHz), RBW is set to 150kHz, VBW is set to 470kHz for LTE Band 2/25 (15MHz), RBW is set to 200kHz, VBW is set to 620kHz for LTE Band 2/25 (20MHz).

Spectrum analyzer plots are included on the following pages.

Test Setup

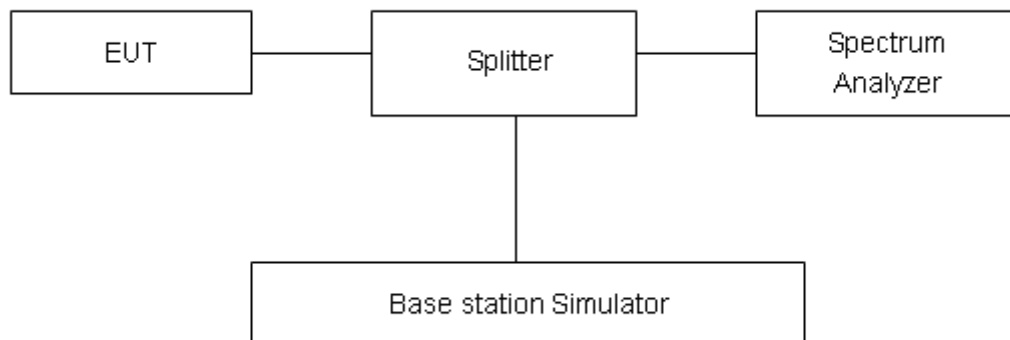

Limits

Rule Part 24.238(a) specifies that “on any frequency outside a licensee's frequency block, the power of any emission shall be attenuated below the transmitter power (P) by at least 43 + 10 log10 (P) dB.”

Limit	-13 dBm
-------	---------

Measurement Uncertainty

The assessed measurement uncertainty to ensure 95% confidence level for the normal distribution is with the coverage factor $k = 1.96$, $U=0.684$ dB.



Test Result:

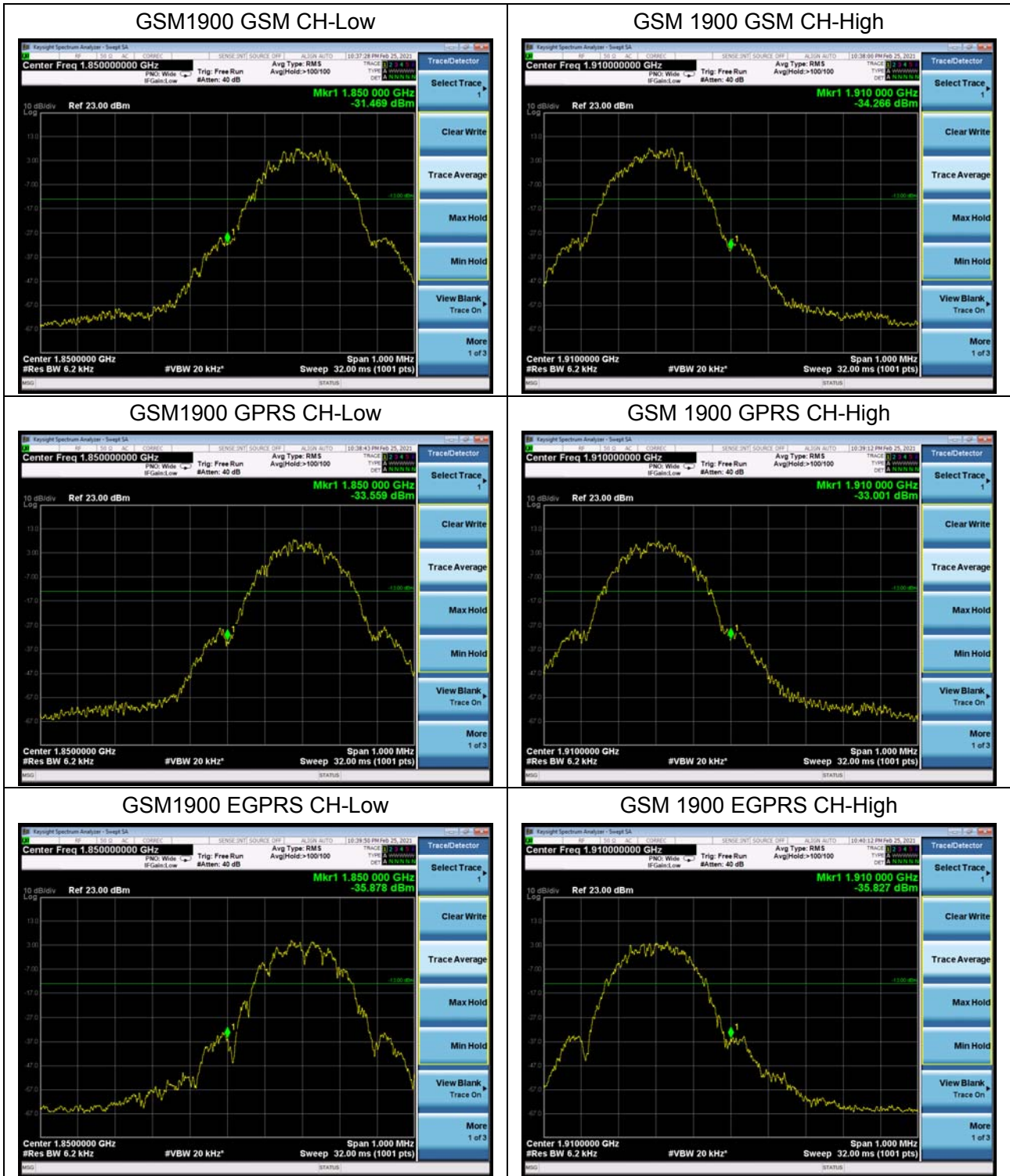

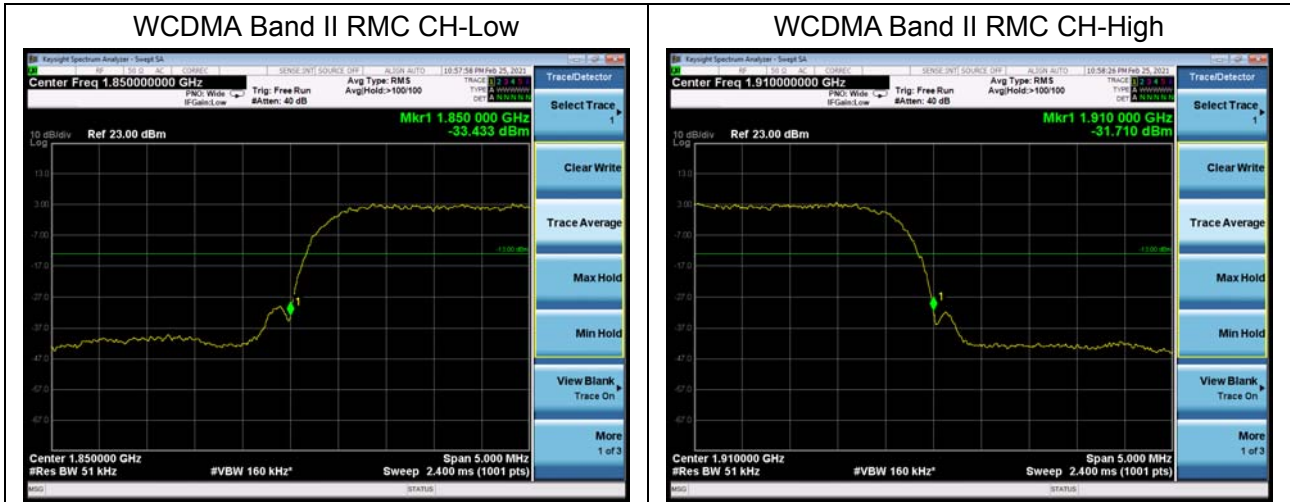



LTE Band 2 1.4MHz QPSK 1RB CH-Low

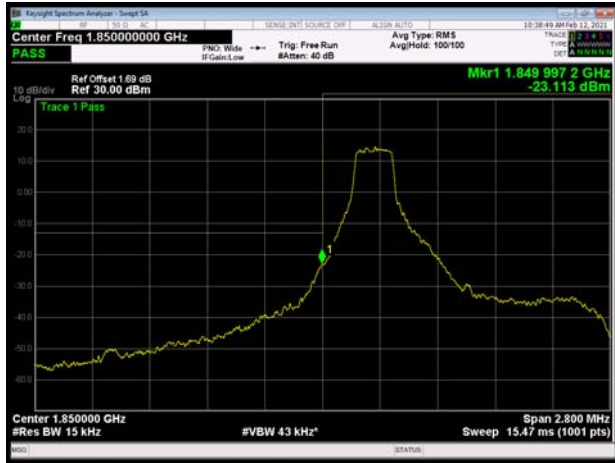

LTE Band 2 1.4MHz QPSK 1RB CH-High



LTE Band 2 1.4MHz QPSK 100%RB CH-Low



LTE Band 2 1.4MHz QPSK 100%RB CH-High



LTE Band 2 3MHz QPSK 1RB CH-Low

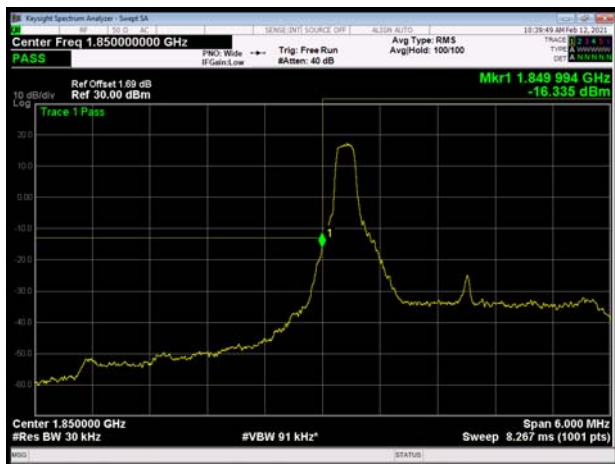

LTE Band 2 3MHz QPSK 1RB CH-High

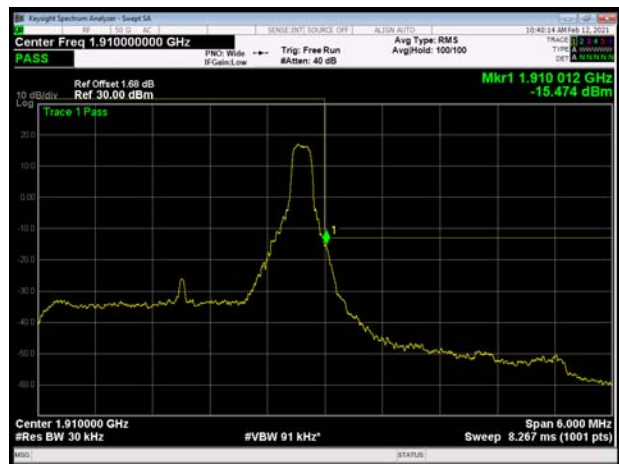

LTE Band 2 3MHz QPSK 100%RB CH-Low

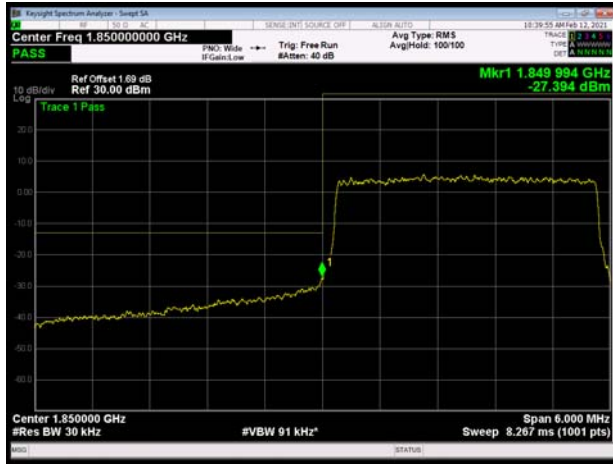

LTE Band 2 3MHz QPSK 100%RB CH-High

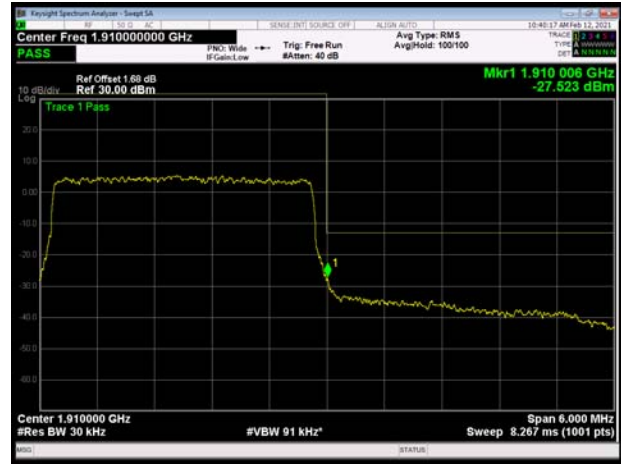

LTE Band 2 5MHz QPSK 1RB CH-Low

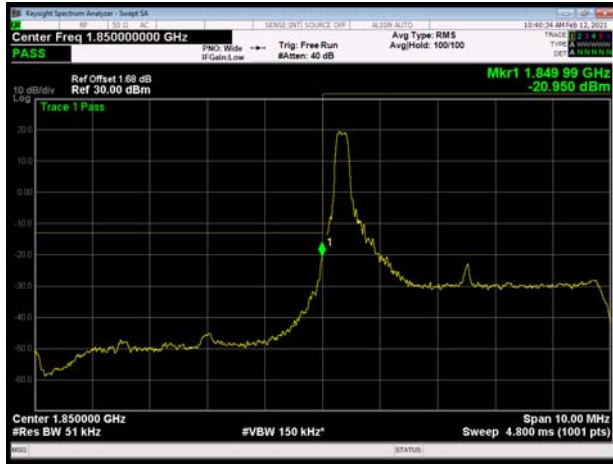

LTE Band 2 5MHz QPSK 1RB CH-High

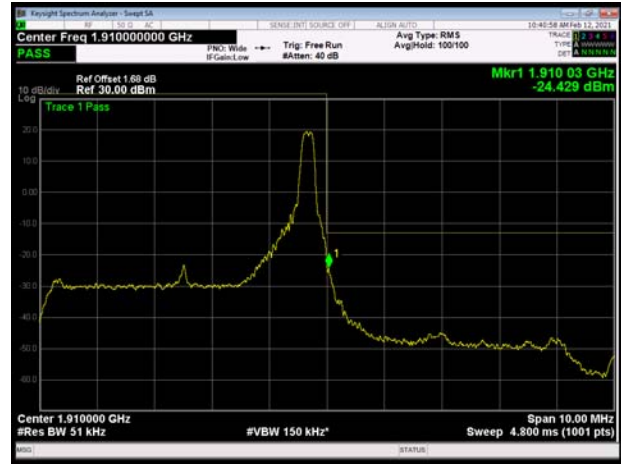

LTE Band 2 5MHz QPSK 100%RB CH-Low



LTE Band 2 5MHz QPSK 100%RB CH-High





LTE Band 2 10MHz QPSK 1RB CH-Low

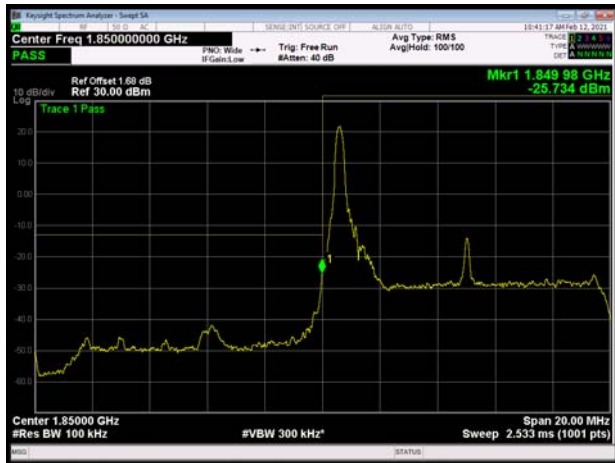

LTE Band 2 10MHz QPSK 1RB CH-High

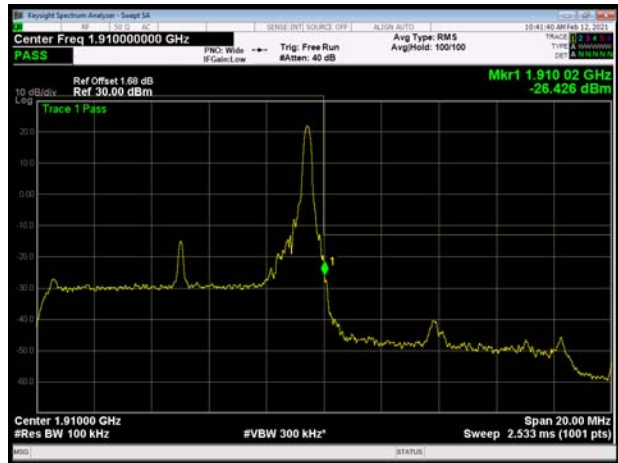

LTE Band 2 10MHz QPSK 100%RB CH-Low

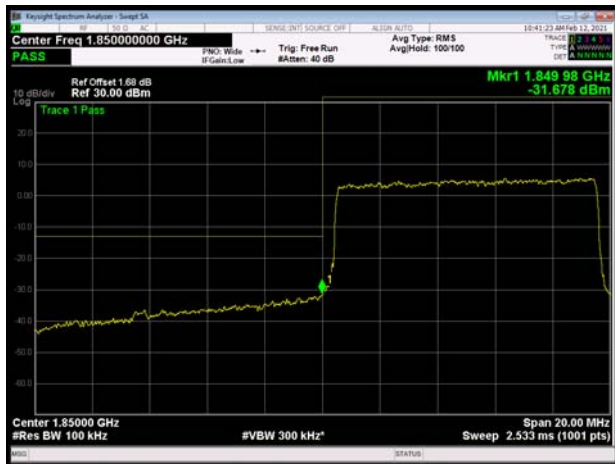

LTE Band 2 10MHz QPSK 100%RB CH-High



LTE Band 2 15MHz QPSK 1RB CH-Low

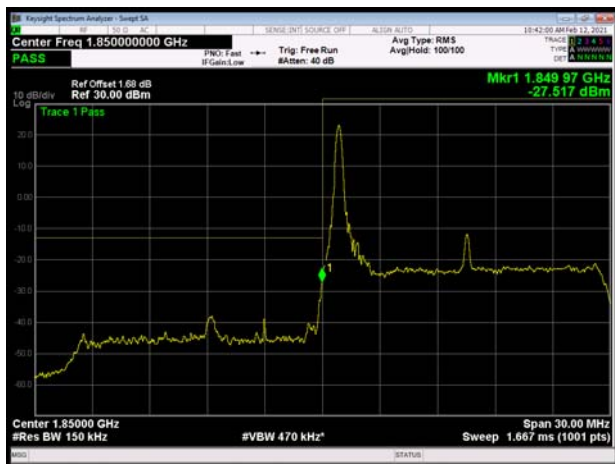

LTE Band 2 15MHz QPSK 1RB CH-High

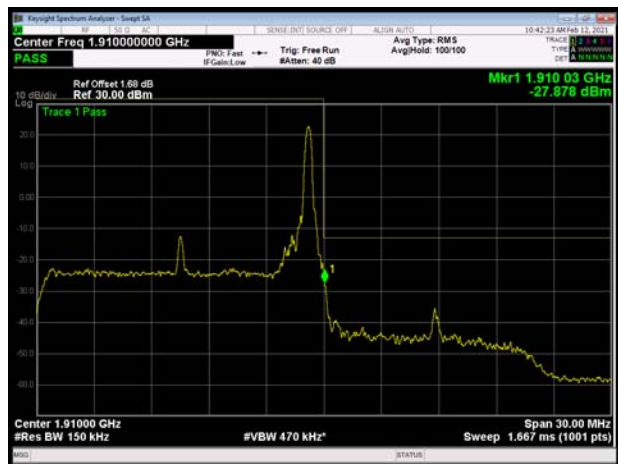



LTE Band 2 15MHz QPSK 100%RB CH-Low

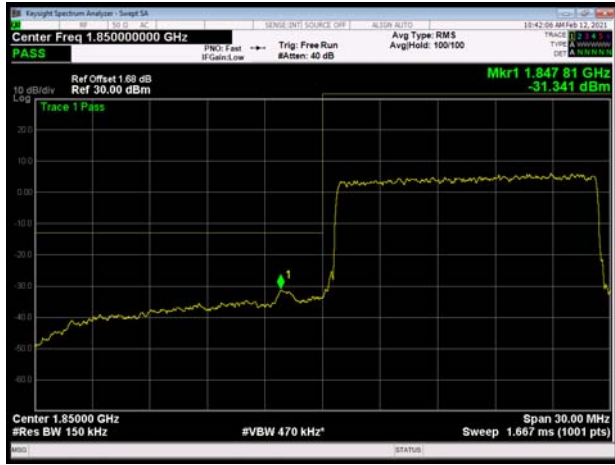

LTE Band 2 15MHz QPSK 100%RB CH-High



LTE Band 2 20MHz QPSK 1RB CH-Low

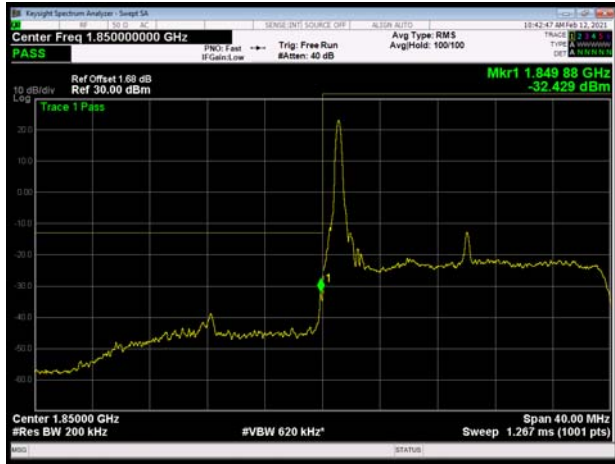

LTE Band 2 20MHz QPSK 1RB CH-High

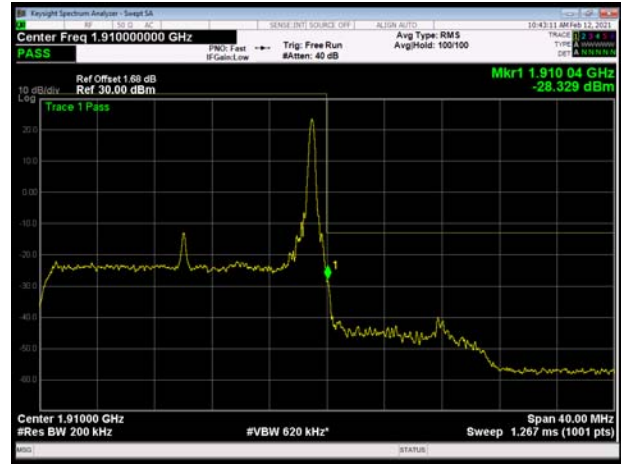

LTE Band 2 20MHz QPSK 100%RB CH-Low

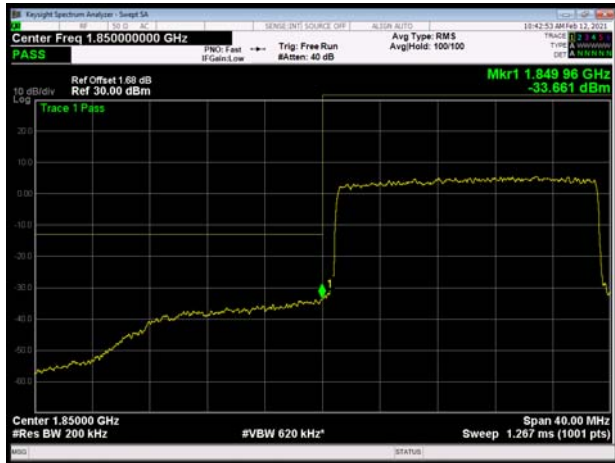

LTE Band 2 20MHz QPSK 100%RB CH-High





LTE Band 2 1.4MHz 16QAM 1RB CH-Low



LTE Band 2 1.4MHz 16QAM 1RB CH-High



LTE Band 2 1.4MHz 16QAM 100%RB CH-Low



LTE Band 2 1.4MHz 16QAM 100%RB CH-High



LTE Band 2 3MHz 16QAM 1RB CH-Low

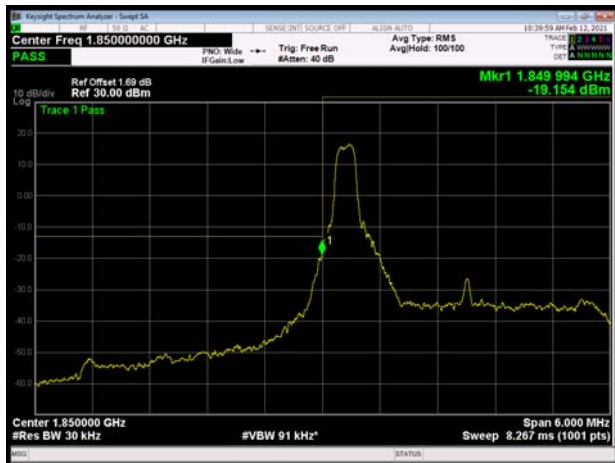

LTE Band 2 3MHz 16QAM 1RB CH-High

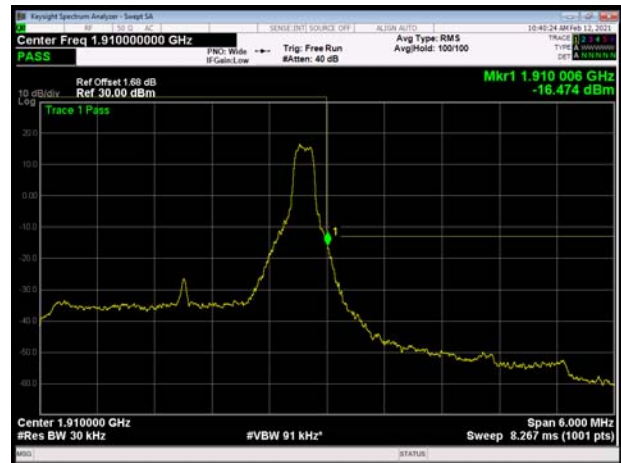



LTE Band 2 3MHz 16QAM 100%RB CH-Low

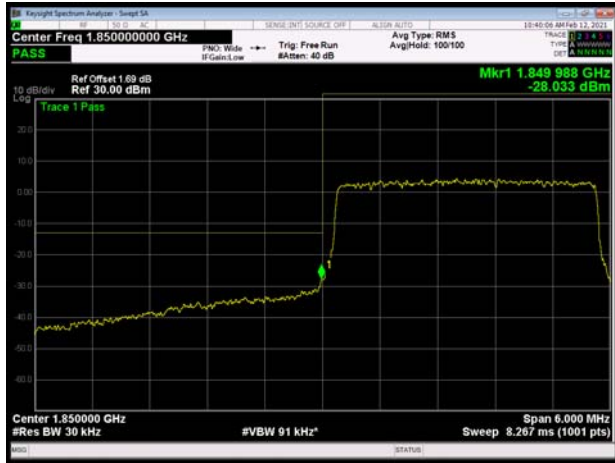

LTE Band 2 3MHz 16QAM 100%RB CH-High



LTE Band 2 5MHz 16QAM 1RB CH-Low

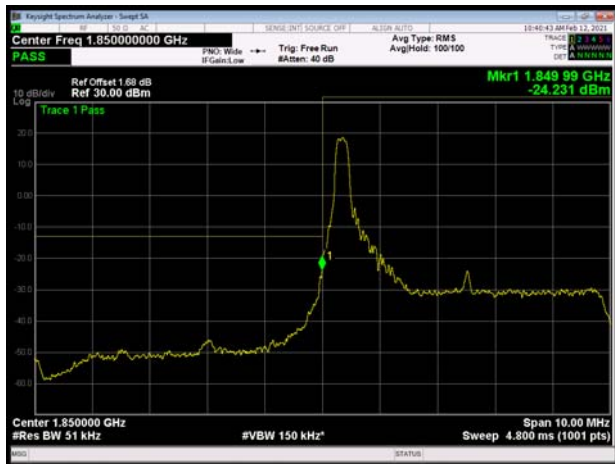

LTE Band 2 5MHz 16QAM 1RB CH-High

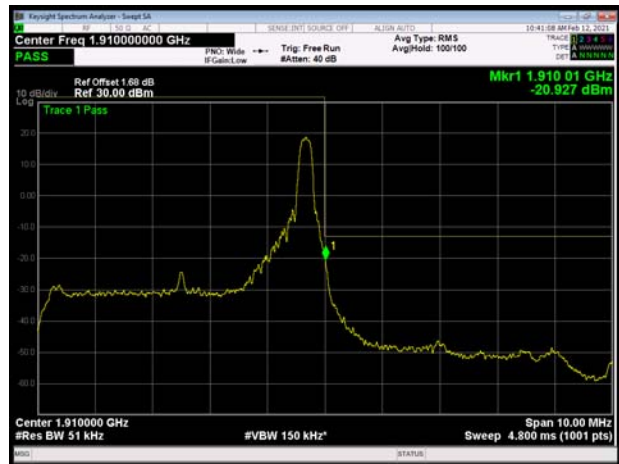

LTE Band 2 5MHz 16QAM 100%RB CH-Low



LTE Band 2 5MHz 16QAM 100%RB CH-High

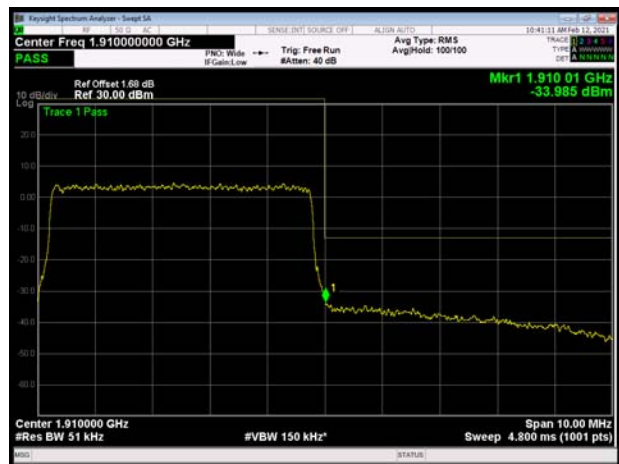



LTE Band 2 10MHz 16QAM 1RB CH-Low

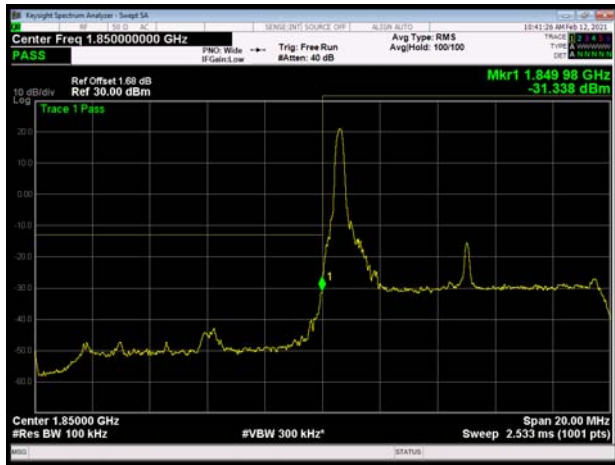

LTE Band 2 10MHz 16QAM 1RB CH-High

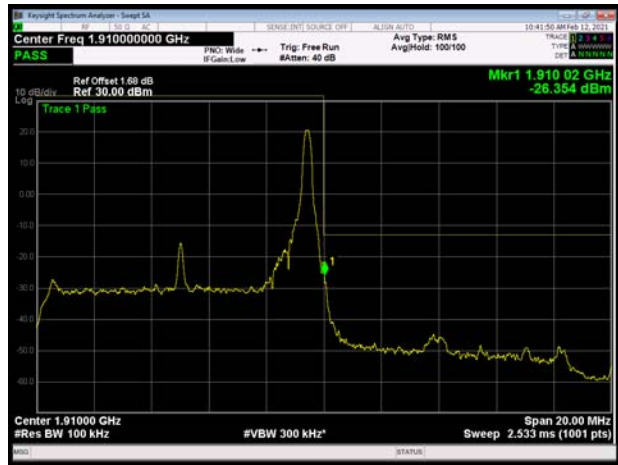

LTE Band 2 10MHz 16QAM 100%RB CH-Low



LTE Band 2 10MHz 16QAM 100%RB CH-High



LTE Band 2 15MHz 16QAM 1RB CH-Low

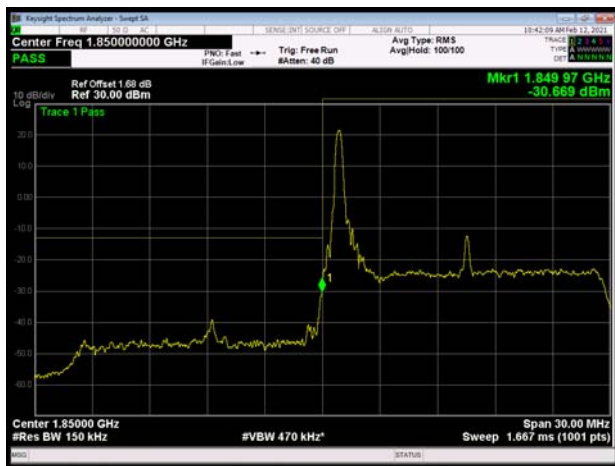

LTE Band 2 15MHz 16QAM 1RB CH-High

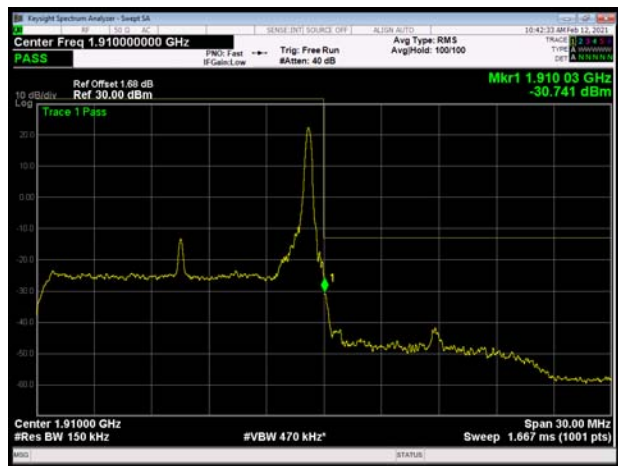



LTE Band 2 15MHz 16QAM 100%RB CH-Low

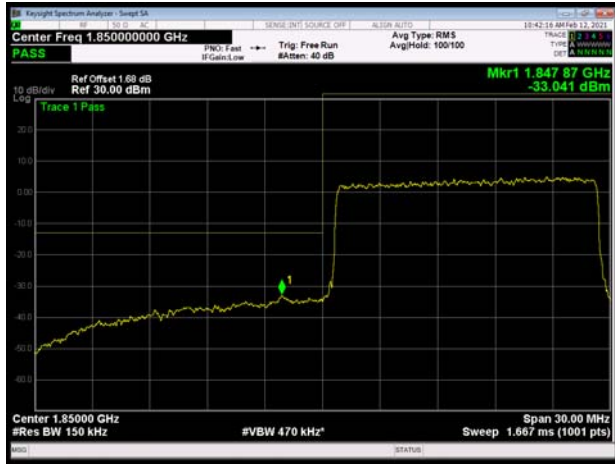

LTE Band 2 15MHz 16QAM 100%RB CH-High

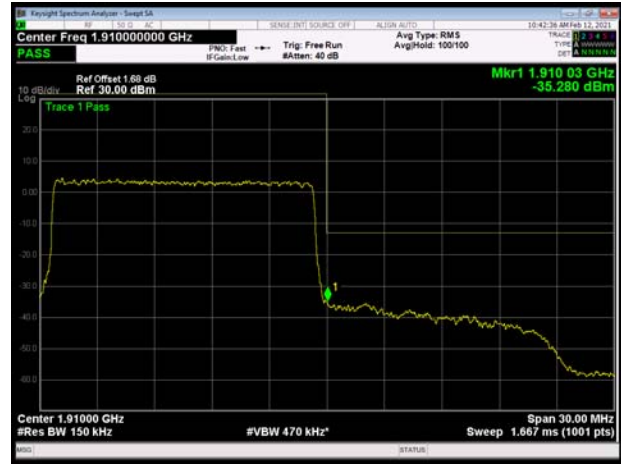

LTE Band 2 20MHz 16QAM 1RB CH-Low

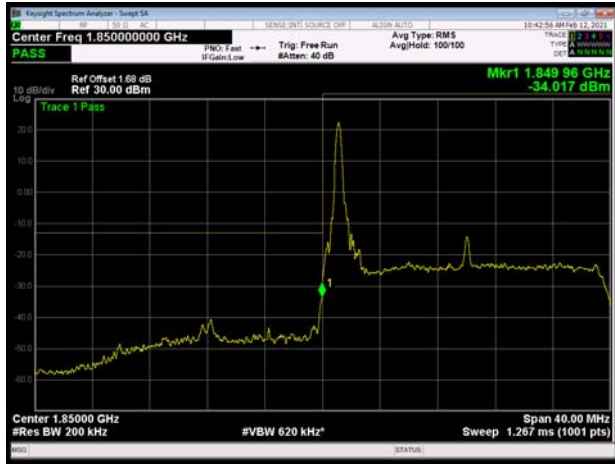

LTE Band 2 20MHz 16QAM 1RB CH-High

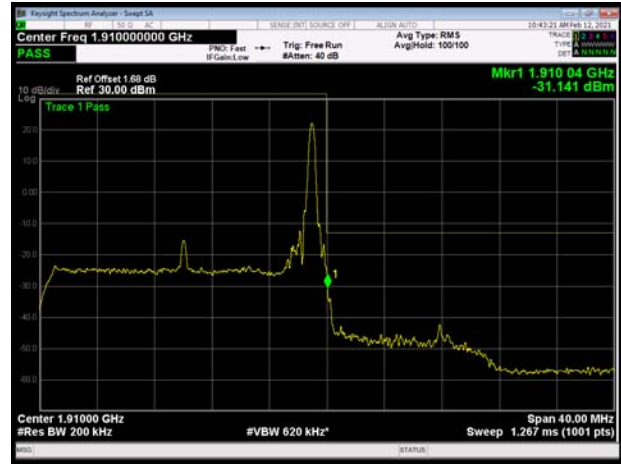

LTE Band 2 20MHz 16QAM 100%RB CH-Low

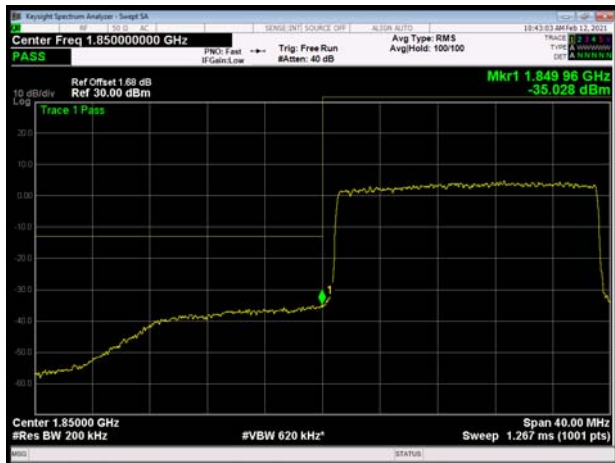

LTE Band 2 20MHz 16QAM 100%RB CH-High





LTE Band 2 1.4MHz 64QAM 1RB CH-Low

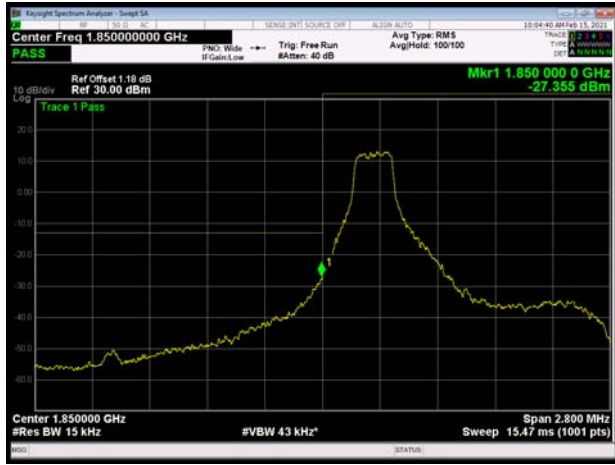

LTE Band 2 1.4MHz 64QAM 1RB CH-High

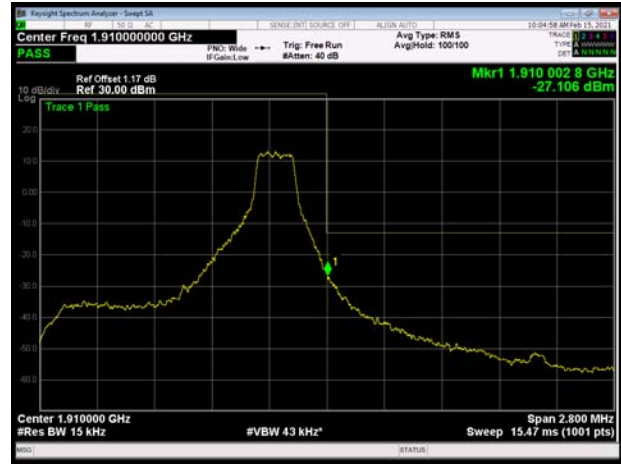

LTE Band 2 1.4MHz 64QAM 100%RB CH-Low

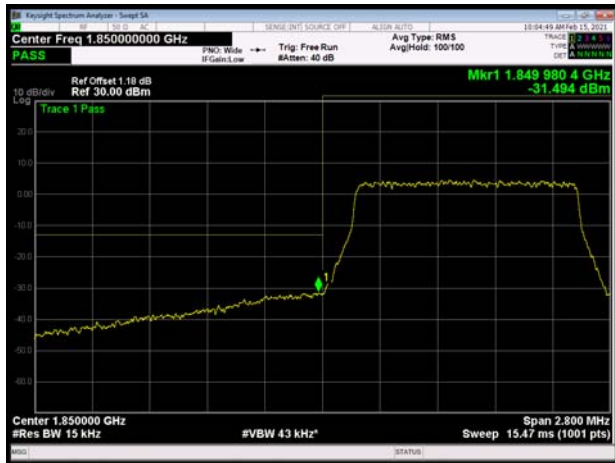

LTE Band 2 1.4MHz 64QAM 100%RB CH-High



LTE Band 2 3MHz 64QAM 1RB CH-Low

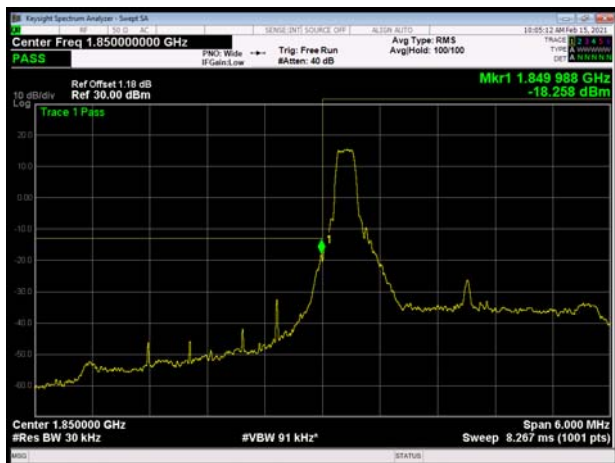

LTE Band 2 3MHz 64QAM 1RB CH-High

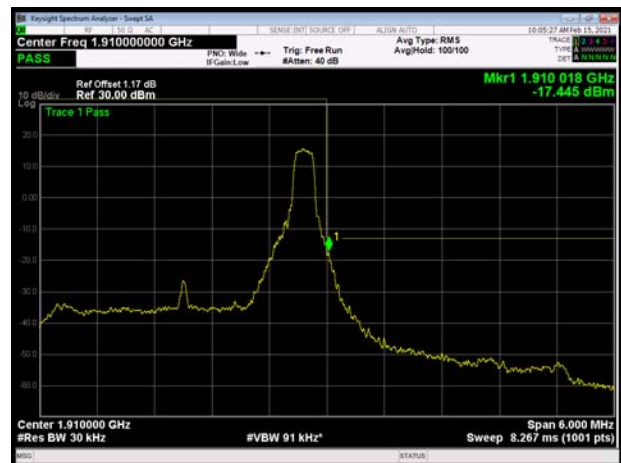



LTE Band 2 3MHz 64QAM 100%RB CH-Low

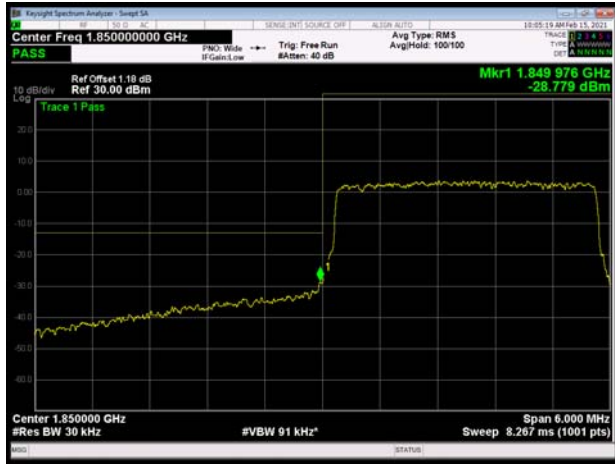

LTE Band 2 3MHz 64QAM 100%RB CH-High



LTE Band 2 5MHz 64QAM 1RB CH-Low

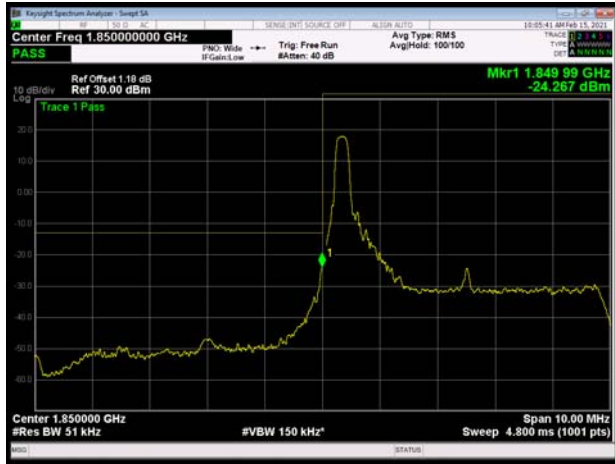

LTE Band 2 5MHz 64QAM 1RB CH-High

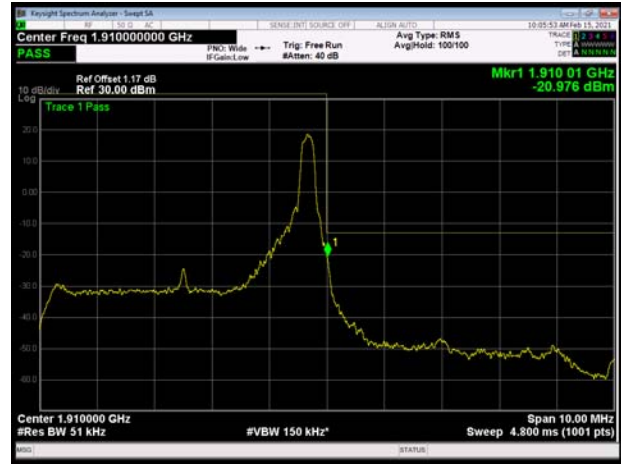

LTE Band 2 5MHz 64QAM 100%RB CH-Low

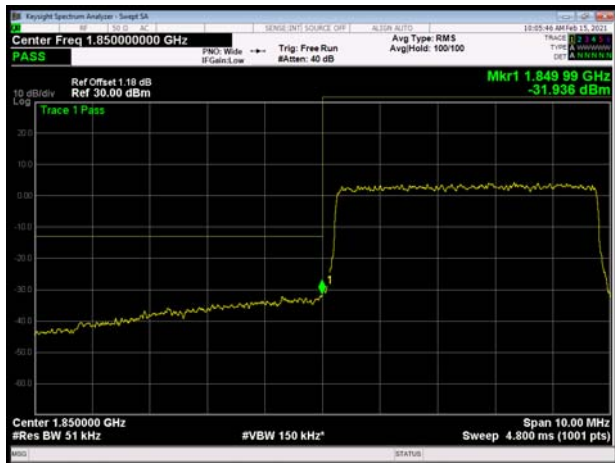

LTE Band 2 5MHz 64QAM 100%RB CH-High





LTE Band 2 10MHz 64QAM 1RB CH-Low

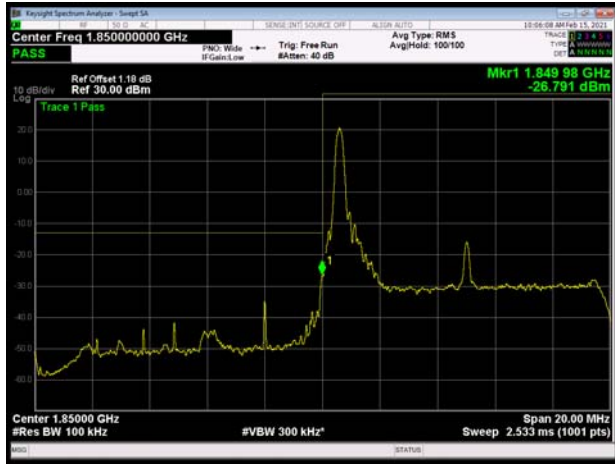

LTE Band 2 10MHz 64QAM 1RB CH-High

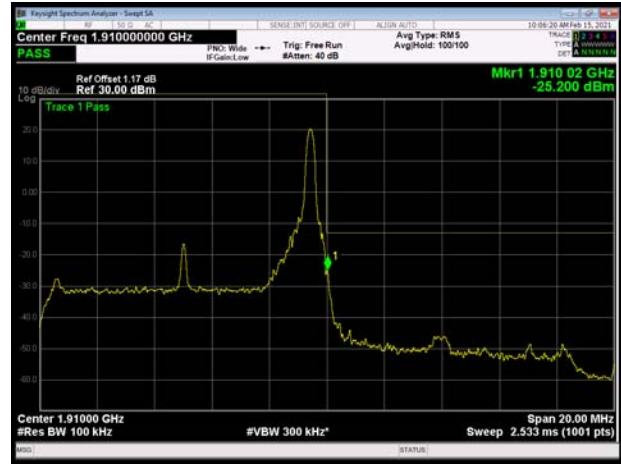

LTE Band 2 10MHz 64QAM 100%RB CH-Low

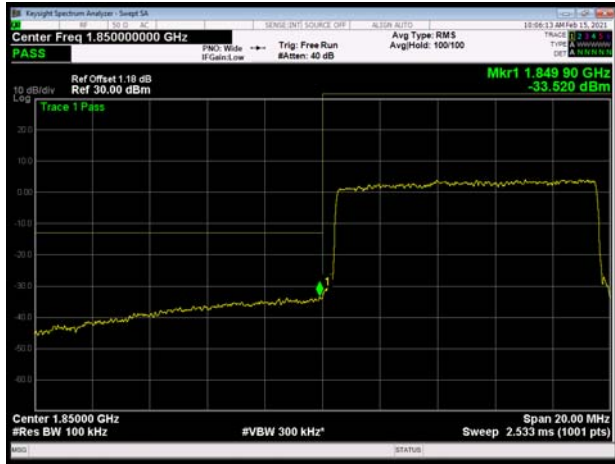

LTE Band 2 10MHz 64QAM 100%RB CH-High



LTE Band 2 15MHz 64QAM 1RB CH-Low

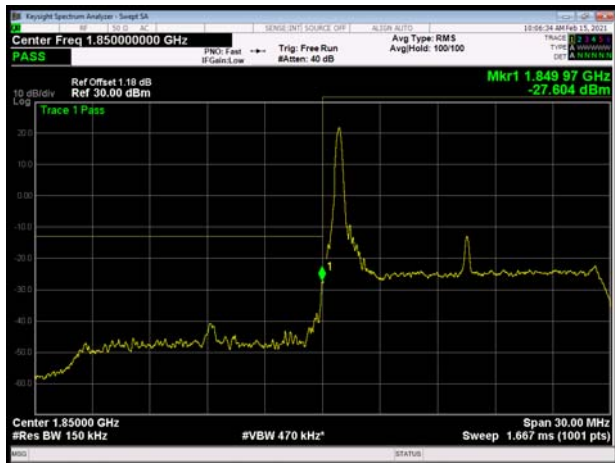

LTE Band 2 15MHz 64QAM 1RB CH-High

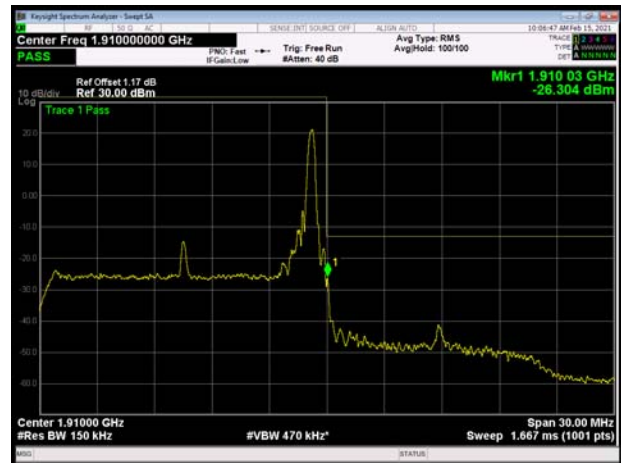



LTE Band 2 15MHz 64QAM 100%RB CH-Low

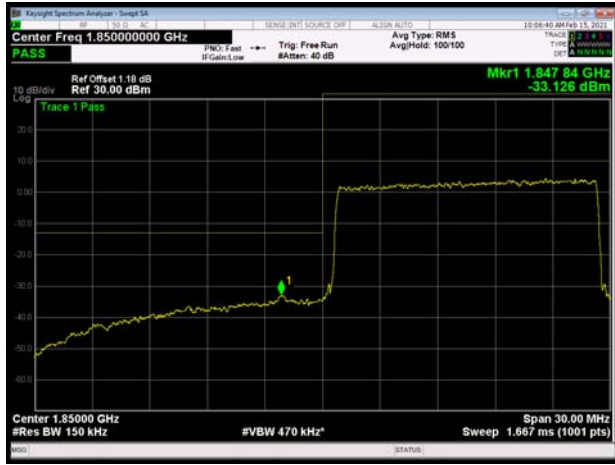

LTE Band 2 15MHz 64QAM 100%RB CH-High



LTE Band 2 20MHz 64QAM 1RB CH-Low

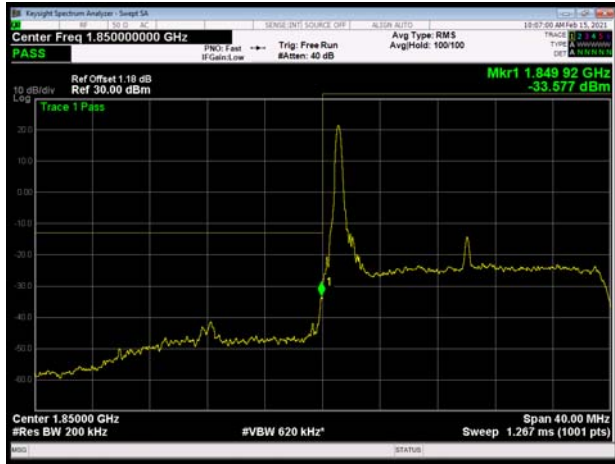

LTE Band 2 20MHz 64QAM 1RB CH-High

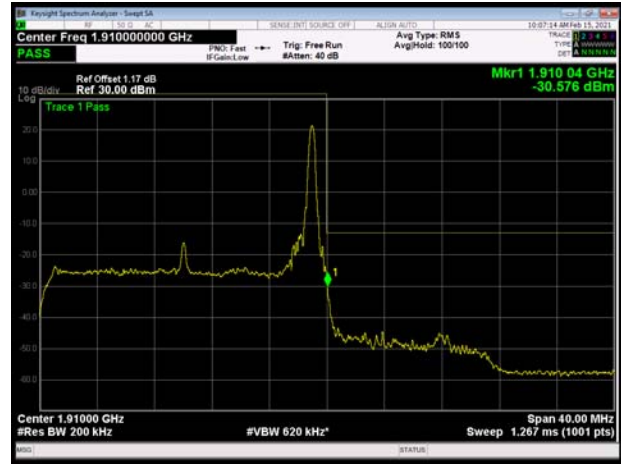

LTE Band 2 20MHz 64QAM 100%RB CH-Low



LTE Band 2 20MHz 64QAM 100%RB CH-High



5.4. Peak-to-Average Power Ratio (PAPR)

Ambient condition

Temperature	Relative humidity	Pressure
23°C ~25°C	45%~50%	101.5kPa

Methods of Measurement

Measure the total peak power and record as PPk. And measure the total average power and record as PAvg. Both the peak and average power levels must be expressed in the same logarithmic units (e.g., dBm). Determine the PAPR from:

$$PAPR (dB) = PPk (dBm) - PAvg (dBm).$$

Test Setup

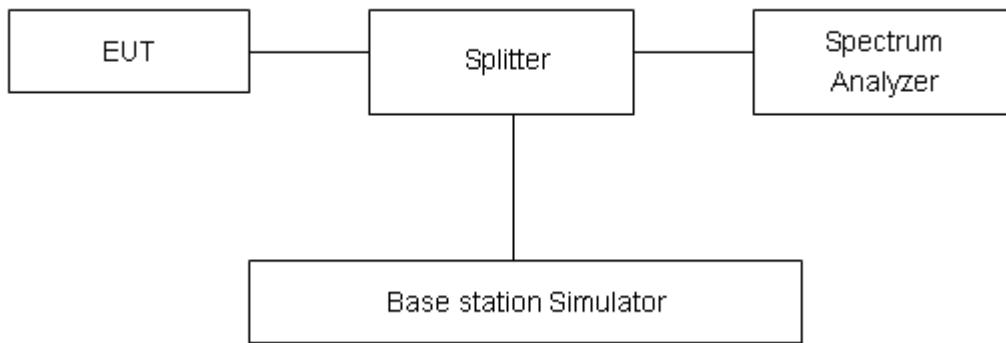

Limits

In measuring transmissions in this band using an average power technique, the peak-to-average ratio (PAR) of the transmission may not exceed 13 dB in 24.232(d).

Measurement Uncertainty

The assessed measurement uncertainty to ensure 95% confidence level for the normal distribution is with the coverage factor $k = 2$, $U = 0.4$ dB.



Test Results

Mode	Channel	Frequency (MHz)	Peak(dBm)	Avg(dBm)	PAPR(dB)	Limit(dB)	Conclusion
GSM 1900 (GMSK)	512	1850.2	31.24	29.20	2.04	≤13	PASS
	661	1880	31.50	29.37	2.13	≤13	PASS
	810	1909.8	31.54	29.45	2.09	≤13	PASS
GPRS 1900 (GMSK)	512	1850.2	31.29	29.17	2.12	≤13	PASS
	661	1880	31.45	29.38	2.07	≤13	PASS
	810	1909.8	31.46	29.43	2.03	≤13	PASS
EGPRS 1900 (8PSK)	512	1850.2	28.51	26.17	2.34	≤13	PASS
	661	1880	28.60	26.34	2.26	≤13	PASS
	810	1909.8	28.71	26.40	2.31	≤13	PASS
WCDMA Band II (RMC)	9262	1852.4	25.18	21.02	4.16	≤13	PASS
	9400	1880	25.25	21.29	3.96	≤13	PASS
	9538	1907.6	24.80	20.51	4.29	≤13	PASS

LTE Band 2								
Modulation	Bandwidth (MHz)	Channel	Frequency (MHz)	Peak (dBm)	Avg (dBm)	PAPR (dB)	Limit (dB)	Conclusion
QPSK	1.4	18607	1850.7	28.35	23.25	5.10	≤13	PASS
		18900	1880.0	28.79	23.20	5.59	≤13	PASS
		19193	1909.3	27.76	23.26	4.50	≤13	PASS
	3	18615	1851.5	28.40	23.18	5.22	≤13	PASS
		18900	1880	28.63	23.14	5.49	≤13	PASS
		19185	1908.5	27.89	23.20	4.69	≤13	PASS
	5	18625	1852.5	28.55	23.28	5.27	≤13	PASS
		18900	1880	28.82	23.25	5.57	≤13	PASS
		19175	1907.5	28.06	23.27	4.79	≤13	PASS
	10	18650	1855	28.65	23.34	5.31	≤13	PASS
		18900	1880	28.87	23.28	5.59	≤13	PASS
		19150	1905	28.33	23.30	5.03	≤13	PASS
	15	18675	1857.5	28.97	23.36	5.61	≤13	PASS
		18900	1880	29.24	23.35	5.89	≤13	PASS
		19125	1902.5	28.84	23.40	5.44	≤13	PASS
20	18700	1860	28.59	23.21	5.38	≤13	PASS	
	18900	1880	29.03	23.37	5.66	≤13	PASS	
	19100	1900	28.69	23.32	5.37	≤13	PASS	
16QAM	1.4	18607	1850.7	28.17	22.25	5.92	≤13	PASS
		18900	1880.0	28.48	22.24	6.24	≤13	PASS



	3	19193	1909.3	27.71	22.28	5.43	≤13	PASS
		18615	1851.5	28.21	22.23	5.98	≤13	PASS
		18900	1880	28.57	22.19	6.38	≤13	PASS
		19185	1908.5	27.84	22.24	5.60	≤13	PASS
	5	18625	1852.5	28.34	22.33	6.01	≤13	PASS
		18900	1880	28.70	22.33	6.37	≤13	PASS
		19175	1907.5	27.98	22.32	5.66	≤13	PASS
	10	18650	1855	28.52	22.38	6.14	≤13	PASS
		18900	1880	28.70	22.33	6.37	≤13	PASS
		19150	1905	28.25	22.34	5.91	≤13	PASS
	15	18675	1857.5	28.64	22.37	6.27	≤13	PASS
		18900	1880	28.85	22.33	6.52	≤13	PASS
		19125	1902.5	28.47	22.38	6.09	≤13	PASS
	20	18700	1860	28.48	22.26	6.22	≤13	PASS
		18900	1880	28.83	22.41	6.42	≤13	PASS
19100		1900	28.50	22.35	6.15	≤13	PASS	
64QAM	1.4	18607	1850.7	27.81	21.81	6.00	≤13	PASS
		18900	1880.0	28.17	21.78	6.39	≤13	PASS
		19193	1909.3	27.15	21.72	5.43	≤13	PASS
	3	18615	1851.5	27.80	21.71	6.09	≤13	PASS
		18900	1880	28.12	21.69	6.43	≤13	PASS
		19185	1908.5	27.33	21.70	5.63	≤13	PASS
	5	18625	1852.5	27.93	21.86	6.07	≤13	PASS
		18900	1880	28.21	21.84	6.37	≤13	PASS
		19175	1907.5	27.48	21.82	5.66	≤13	PASS
	10	18650	1855	28.02	21.86	6.16	≤13	PASS
		18900	1880	28.22	21.83	6.39	≤13	PASS
		19150	1905	27.71	21.81	5.90	≤13	PASS
	15	18675	1857.5	28.15	21.88	6.27	≤13	PASS
		18900	1880	28.35	21.84	6.51	≤13	PASS
		19125	1902.5	28.01	21.87	6.14	≤13	PASS
	20	18700	1860	28.03	21.77	6.26	≤13	PASS
		18900	1880	28.35	21.92	6.43	≤13	PASS
		19100	1900	28.04	21.84	6.20	≤13	PASS

5.5. Frequency Stability

Ambient condition

Temperature	Relative humidity	Pressure
23°C ~25°C	45%~50%	101.5kPa

Method of Measurement

Frequency Stability (Temperature Variation)

The temperature inside the climate chamber is varied from -30°C to +50°C in 10°C step size,

(1) With all power removed, the temperature was decreased to 0°C and permitted to stabilize for three hours.

(2) Measure the carrier frequency with the test equipment in a “call mode”. These measurements should be made within 1 minute of powering up the mobile station, to prevent significant self warming.

(3) Repeat the above measurements at 10°C increments from -30°C to +50°C. Allow at least 1.5 hours at each temperature, un-powered, before making measurements.

Frequency Stability (Voltage Variation)

The frequency stability shall be measured with variation of primary supply voltage as follows:

Primary Supply Voltage: The primary supply voltage is varied from 85% to 115% of the nominal value for non hand-carried battery and AC powered equipment. For hand-carried, battery-powered equipment, primary supply voltage is reduced to the battery operating end point which shall be specified by the manufacturer.

This transceiver is specified to operate with an input voltage of between 3.6 V and 4.45 V, with a nominal voltage of 3.87V.

Test setup

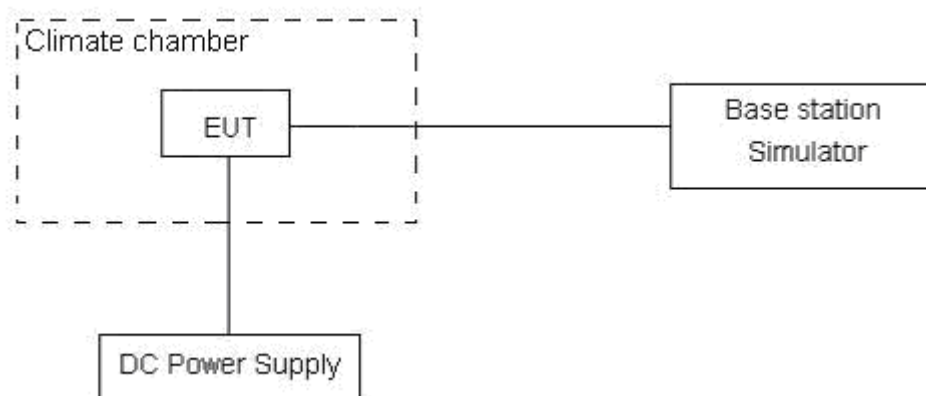

**Limits**

The frequency stability shall be sufficient to ensure that the fundamental emission stays within the authorized frequency block

Measurement Uncertainty

The assessed measurement uncertainty to ensure 99.75% confidence level for the normal distribution is with the coverage factor $k = 3$, $U = 0.01\text{ppm}$.

Test Result

GSM 1900						
Condition		Freq.Error (Hz)	Freq.Error (Hz)	Frequency Stability (ppm)	Frequency Stability (ppm)	Verdict
Temperature	Voltage	GMSK	8PSK	GMSK	8PSK	
Normal (25°C)	Normal	8.21	14.00	0.00437	0.00745	PASS
Extreme (50°C)		16.91	12.32	0.00900	0.00655	PASS
Extreme (40°C)		1.97	14.33	0.00105	0.00762	PASS
Extreme (30°C)		7.61	13.71	0.00405	0.00729	PASS
Extreme (20°C)		2.50	5.88	0.00133	0.00313	PASS
Extreme (10°C)		11.65	3.74	0.00620	0.00199	PASS
Extreme (0°C)		14.79	9.60	0.00787	0.00511	PASS
Extreme (-10°C)		13.25	8.62	0.00705	0.00459	PASS
Extreme (-20°C)		14.40	1.94	0.00766	0.00103	PASS
Extreme (-30°C)		13.06	1.56	0.00695	0.00083	PASS
25°C	LV	13.28	15.49	0.00706	0.00824	PASS
	HV	4.33	13.37	0.00230	0.00711	PASS

WCDMA Band II						
Condition		Freq.Error (Hz)	Freq.Error (Hz)	Frequency Stability (ppm)	Frequency Stability (ppm)	Verdict
Temperature	Voltage	BPSK	QPSK	BPSK	QPSK	
Normal (25°C)	Normal	6.00	4.25	0.00319	0.00226	PASS
Extreme (50°C)		14.16	1.29	0.00753	0.00068	PASS
Extreme (40°C)		10.10	5.06	0.00537	0.00269	PASS
Extreme (30°C)		9.29	12.45	0.00494	0.00662	PASS
Extreme (20°C)		7.21	13.35	0.00383	0.00710	PASS
Extreme (10°C)		12.70	13.05	0.00675	0.00694	PASS
Extreme (0°C)		6.74	11.20	0.00358	0.00596	PASS
Extreme (-10°C)		12.31	11.53	0.00655	0.00613	PASS
Extreme (-20°C)		9.77	5.95	0.00520	0.00317	PASS
Extreme (-30°C)		6.80	8.21	0.00362	0.00437	PASS
25°C	LV	14.17	13.80	0.00754	0.00734	PASS
	HV	1.04	17.79	0.00055	0.00946	PASS



LTE Band 2								
Condition		Freq.Error (Hz)	Freq.Error (Hz)	Freq.Error (Hz)	Frequency Stability (ppm)	Frequency Stability (ppm)	Frequency Stability (ppm)	Verdict
BANDWIDTH	1.4MHz							
Temperature	Voltage	64QAM	16QAM	QPSK	64QAM	16QAM	QPSK	
Normal (25°C)	Normal	1.51	5.25	4.32	0.00080	0.00279	0.00230	PASS
Extreme (50°C)		14.65	4.20	3.63	0.00779	0.00223	0.00193	PASS
Extreme (40°C)		3.38	15.21	4.21	0.00180	0.00809	0.00224	PASS
Extreme (30°C)		7.33	1.08	16.93	0.00390	0.00057	0.00901	PASS
Extreme (20°C)		4.10	10.82	15.13	0.00218	0.00576	0.00805	PASS
Extreme (10°C)		4.47	11.61	12.64	0.00238	0.00617	0.00672	PASS
Extreme (0°C)		11.89	3.79	16.83	0.00633	0.00202	0.00895	PASS
Extreme (-10°C)		2.90	8.13	11.71	0.00154	0.00432	0.00623	PASS
Extreme (-20°C)		3.69	9.98	5.17	0.00196	0.00531	0.00275	PASS
Extreme (-30°C)		11.82	10.85	14.27	0.00629	0.00577	0.00759	PASS
25°C	LV	14.09	5.64	4.32	0.00749	0.00300	0.00230	PASS
	HV	1.62	6.87	5.81	0.00086	0.00366	0.00309	PASS
Condition		Freq.Error (Hz)	Freq.Error (Hz)	Freq.Error (Hz)	Frequency Stability (ppm)	Frequency Stability (ppm)	Frequency Stability (ppm)	Verdict
BANDWIDTH	3MHz							
Temperature	Voltage	64QAM	16QAM	QPSK	64QAM	16QAM	QPSK	
Normal (25°C)	Normal	4.31	17.15	4.23	0.00229	0.00912	0.00225	PASS
Extreme (50°C)		15.99	8.43	5.19	0.00851	0.00448	0.00276	PASS
Extreme (40°C)		1.45	15.98	1.97	0.00077	0.00850	0.00105	PASS
Extreme (30°C)		1.66	10.74	5.31	0.00088	0.00571	0.00282	PASS
Extreme (20°C)		1.20	15.73	17.14	0.00064	0.00836	0.00912	PASS
Extreme (10°C)		3.64	13.93	12.11	0.00194	0.00741	0.00644	PASS
Extreme (0°C)		6.69	8.18	6.45	0.00356	0.00435	0.00343	PASS
Extreme (-10°C)		10.00	12.59	5.31	0.00532	0.00670	0.00282	PASS
Extreme (-20°C)		15.39	7.82	17.17	0.00818	0.00416	0.00913	PASS
Extreme (-30°C)		11.97	10.65	7.40	0.00637	0.00567	0.00394	PASS
25°C	LV	8.33	3.89	2.45	0.00443	0.00207	0.00130	PASS
	HV	4.45	4.02	13.74	0.00237	0.00214	0.00731	PASS
Condition		Freq.Error (Hz)	Freq.Error (Hz)	Freq.Error (Hz)	Frequency Stability (ppm)	Frequency Stability (ppm)	Frequency Stability (ppm)	Verdict
BANDWIDTH	5MHz							
Temperature	Voltage	64QAM	16QAM	QPSK	64QAM	16QAM	QPSK	
Normal (25°C)	Normal	3.85	15.10	2.40	0.00205	0.00803	0.00128	PASS
Extreme (50°C)		7.84	16.97	11.30	0.00417	0.00903	0.00601	PASS
Extreme (40°C)		16.78	1.79	11.00	0.00892	0.00095	0.00585	PASS
Extreme (30°C)		1.84	2.16	3.22	0.00098	0.00115	0.00171	PASS
Extreme (20°C)		17.89	4.47	17.70	0.00952	0.00238	0.00942	PASS
Extreme (10°C)		15.17	4.56	2.41	0.00807	0.00242	0.00128	PASS



Extreme (0°C)		1.01	2.01	11.41	0.00054	0.00107	0.00607	PASS
Extreme (-10°C)		12.45	7.94	8.15	0.00662	0.00423	0.00433	PASS
Extreme (-20°C)		5.45	15.27	12.38	0.00290	0.00812	0.00658	PASS
Extreme (-30°C)		2.84	10.48	1.51	0.00151	0.00557	0.00080	PASS
25°C	LV	17.81	10.75	8.80	0.00947	0.00572	0.00468	PASS
	HV	7.96	17.00	15.31	0.00424	0.00904	0.00814	PASS
Condition		Freq.Error (Hz)	Freq.Error (Hz)	Freq.Error (Hz)	Frequency Stability (ppm)	Frequency Stability (ppm)	Frequency Stability (ppm)	Verdict
BANDWIDTH	10MHz							
Temperature	Voltage	64QAM	16QAM	QPSK	64QAM	16QAM	QPSK	
Normal (25°C)	Normal	11.89	7.40	7.07	0.00633	0.00394	0.00376	PASS
Extreme (50°C)		10.71	15.94	9.31	0.00570	0.00848	0.00495	PASS
Extreme (40°C)		9.23	13.33	7.40	0.00491	0.00709	0.00394	PASS
Extreme (30°C)		11.22	3.40	14.97	0.00597	0.00181	0.00796	PASS
Extreme (20°C)		12.25	6.49	6.88	0.00652	0.00345	0.00366	PASS
Extreme (10°C)		16.02	2.17	15.24	0.00852	0.00115	0.00811	PASS
Extreme (0°C)		16.03	1.03	2.31	0.00853	0.00055	0.00123	PASS
Extreme (-10°C)		11.24	2.29	11.54	0.00598	0.00122	0.00614	PASS
Extreme (-20°C)		3.30	13.59	15.30	0.00176	0.00723	0.00814	PASS
Extreme (-30°C)		5.26	15.63	14.18	0.00280	0.00831	0.00754	PASS
25°C		LV	14.07	1.41	1.27	0.00748	0.00075	0.00067
	HV	14.89	7.12	10.24	0.00792	0.00379	0.00544	PASS
Condition		Freq.Error (Hz)	Freq.Error (Hz)	Freq.Error (Hz)	Frequency Stability (ppm)	Frequency Stability (ppm)	Frequency Stability (ppm)	Verdict
BANDWIDTH	15MHz							
Temperature	Voltage	64QAM	16QAM	QPSK	64QAM	16QAM	QPSK	
Normal (25°C)	Normal	9.82	14.75	8.64	0.00522	0.00785	0.00460	PASS
Extreme (50°C)		3.34	14.87	14.58	0.00177	0.00791	0.00775	PASS
Extreme (40°C)		7.60	10.41	1.32	0.00404	0.00554	0.00070	PASS
Extreme (30°C)		1.77	9.79	9.12	0.00094	0.00521	0.00485	PASS
Extreme (20°C)		16.72	11.03	13.42	0.00889	0.00586	0.00714	PASS
Extreme (10°C)		12.00	14.77	8.63	0.00638	0.00786	0.00459	PASS
Extreme (0°C)		5.15	3.51	13.64	0.00274	0.00187	0.00725	PASS
Extreme (-10°C)		15.42	17.22	9.83	0.00820	0.00916	0.00523	PASS
Extreme (-20°C)		15.09	7.55	2.59	0.00803	0.00402	0.00138	PASS
Extreme (-30°C)		2.45	14.43	14.12	0.00130	0.00768	0.00751	PASS
25°C		LV	17.12	6.36	14.18	0.00911	0.00339	0.00754
	HV	16.49	15.13	3.71	0.00877	0.00805	0.00198	PASS
Condition		Freq.Error (Hz)	Freq.Error (Hz)	Freq.Error (Hz)	Frequency Stability (ppm)	Frequency Stability (ppm)	Frequency Stability (ppm)	Verdict
BANDWIDTH	20MHz							
Temperature	Voltage	64QAM	16QAM	QPSK	64QAM	16QAM	QPSK	
Normal (25°C)	Normal	4.96	6.65	9.23	0.00264	0.00353	0.00491	PASS



Extreme (50°C)		5.85	8.22	11.26	0.00311	0.00437	0.00599	PASS
Extreme (40°C)		14.76	14.60	7.73	0.00785	0.00776	0.00411	PASS
Extreme (30°C)		16.82	12.60	5.51	0.00895	0.00670	0.00293	PASS
Extreme (20°C)		4.01	1.55	6.43	0.00213	0.00083	0.00342	PASS
Extreme (10°C)		3.23	3.60	4.21	0.00172	0.00192	0.00224	PASS
Extreme (0°C)		10.63	13.76	13.33	0.00565	0.00732	0.00709	PASS
Extreme (-10°C)		11.70	2.51	4.87	0.00622	0.00133	0.00259	PASS
Extreme (-20°C)		15.36	10.49	1.19	0.00817	0.00558	0.00063	PASS
Extreme (-30°C)		15.24	7.73	4.77	0.00811	0.00411	0.00254	PASS
25°C	LV	3.49	3.31	5.95	0.00186	0.00176	0.00317	PASS
	HV	3.01	6.14	3.14	0.00160	0.00327	0.00167	PASS

5.6. Spurious Emissions at Antenna Terminals

Ambient condition

Temperature	Relative humidity	Pressure
23°C ~25°C	45%~50%	101.5kPa

Method of Measurement

The EUT was connected to Spectrum Analyzer and Base Station Simulator via power Splitter. The measurement is carried out using a spectrum analyzer. The spectrum analyzer scans from 9kHz to the 10th harmonic of the carrier. The peak detector is used.

RBW is set to 100kHz, VBW is set to 300kHz for 30MHz~1GHz

RBW is set to 1MHz, VBW is set to 3MHz for above 1GHz, Sweep is set to ATUO.

RBW is set to 1 kHz (0.009MHz~ 0.15 MHz),

RBW is set to 10 kHz (0.15 MHz~ 30 MHz)

RBW is set to 100 kHz (30MHz~1000 MHz)

RBW is set to 1000 kHz (above 1000MHz)

The modulation mode and RB allocation refer to section 5.1, using the maximum output power configuration.

Test setup

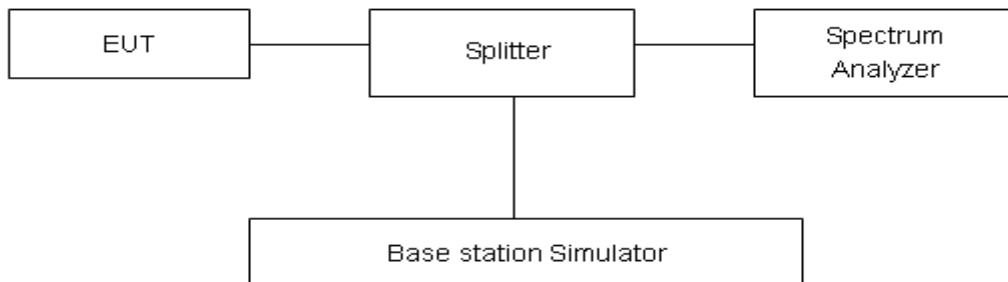

Limits

Rule Part 24.238(a) specifies that “on any frequency outside a licensee’s frequency block, the power of any emission shall be attenuated below the transmitter power (P) by at least 43 + 10 log₁₀ (P) dB.”

Limit	-13 dBm
-------	---------

Measurement Uncertainty

The assessed measurement uncertainty to ensure 99.75% confidence level for the normal distribution is with the coverage factor $k = 1.96$.

Frequency	Uncertainty
9kHz-1GHz	0.684 dB
1GHz-20GHz	1.407 dB



Test Result

Sweep the whole frequency band through the range from 9kHz to the 10th harmonic of the carrier, the emissions more than 20 dB below the limit are not reported.

The signal beyond the limit is carrier.

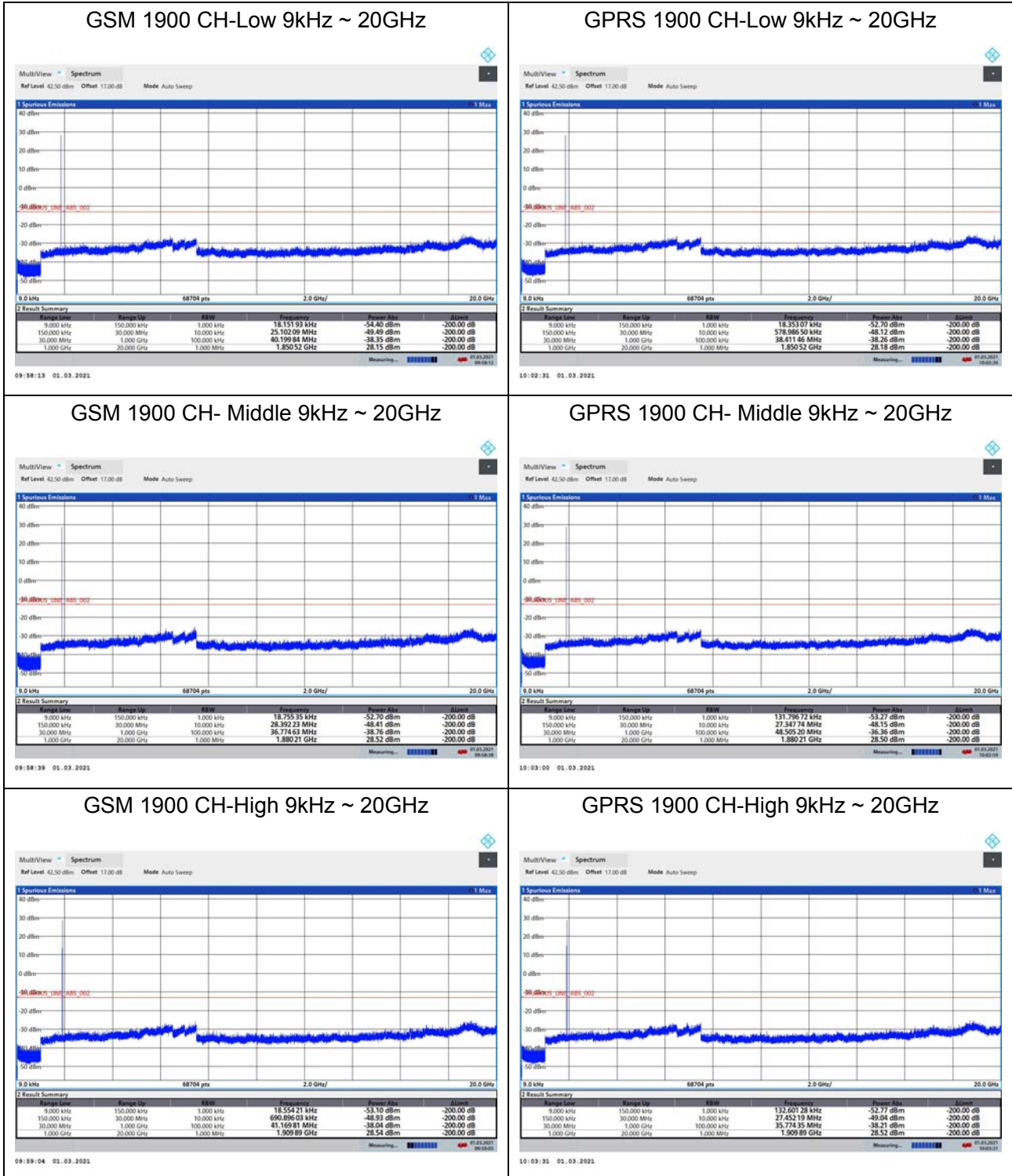



EGPRS 1900 CH-Low 9kHz ~ 20GHz

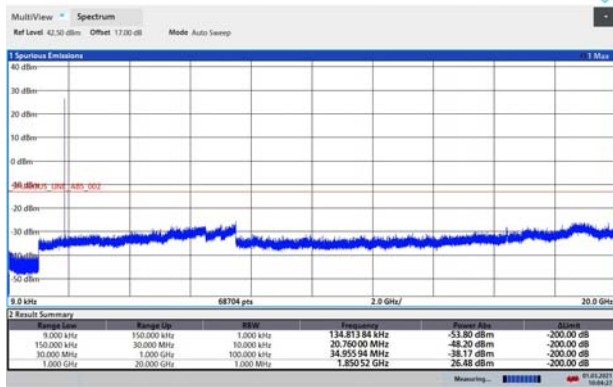

10:04:27 01.03.2021

WCDMA BAND II CH-Low 9kHz ~ 20GHz

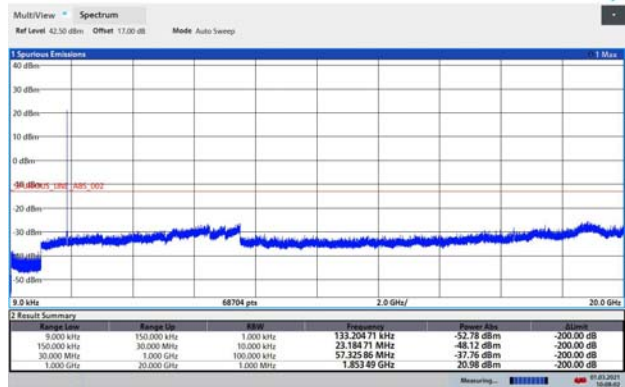

10:09:03 01.03.2021

EGPRS 1900 CH- Middle 9kHz ~ 20GHz

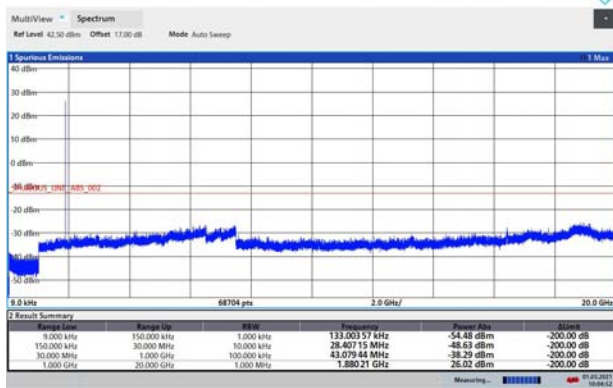

10:04:53 01.03.2021

WCDMA BAND II CH- Middle 9kHz ~ 20GHz

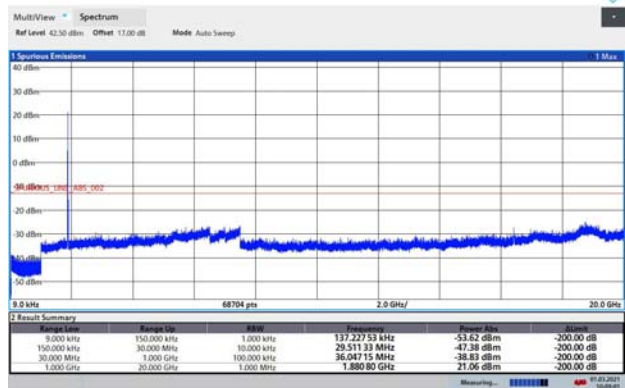

10:09:01 01.03.2021

EGPRS 1900 CH-High 9kHz ~ 20GHz

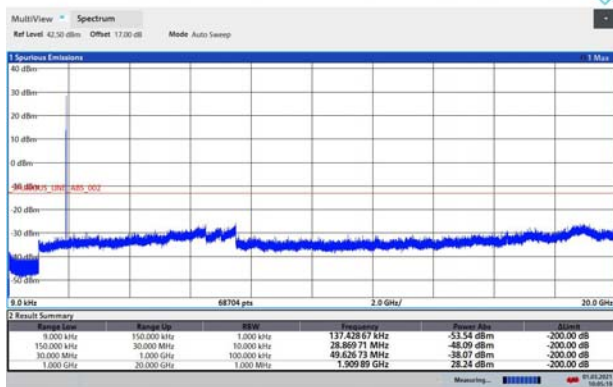

10:05:20 01.03.2021

WCDMA BAND II CH-High 9kHz ~ 20GHz

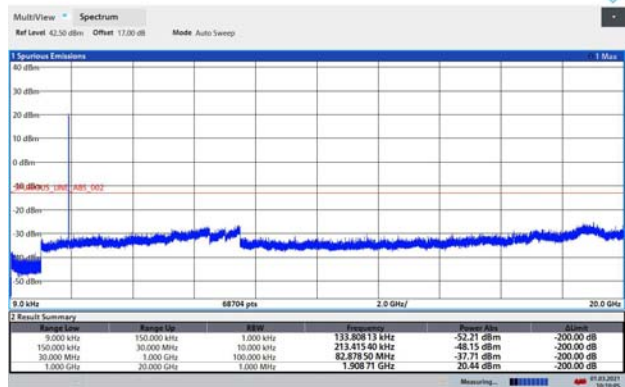

10:10:05 01.03.2021



LTE Band 2 1.4MHz CH-Low 9kHz~20GHz

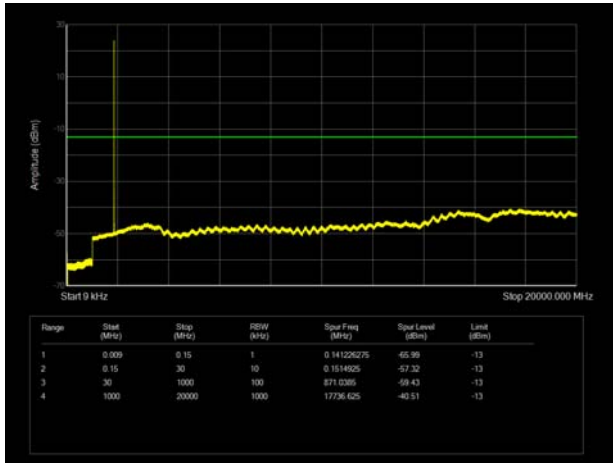

LTE Band 2 3MHz CH-Low 9kHz~20GHz

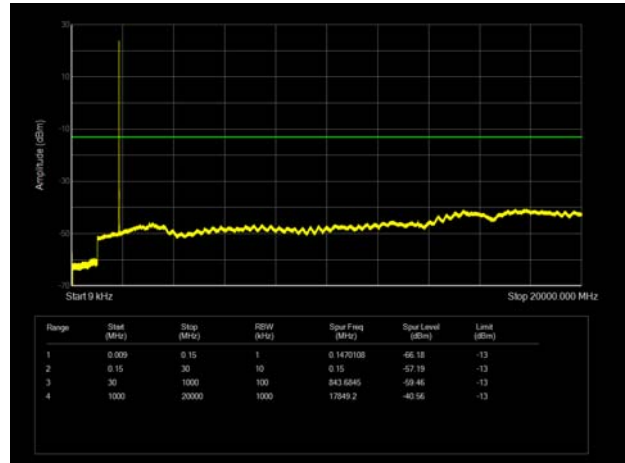

LTE Band 2 1.4MHz CH-Middle 9kHz~20GHz

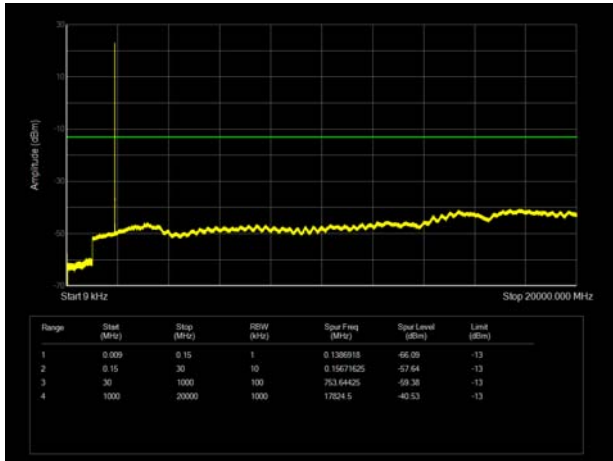

LTE Band 2 3MHz CH-Middle 9kHz~20GHz

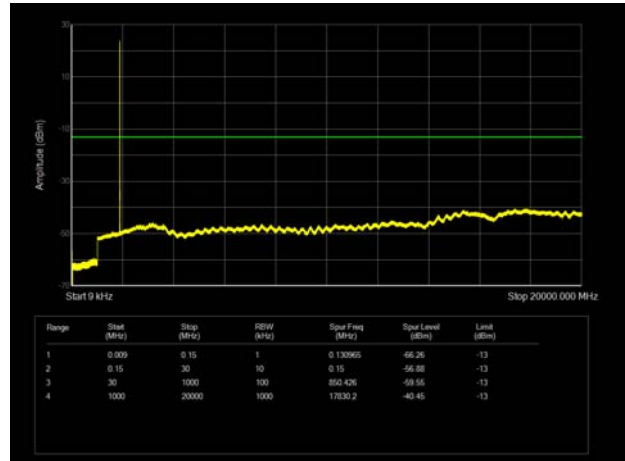

LTE Band 2 1.4MHz CH-High 9kHz~20GHz

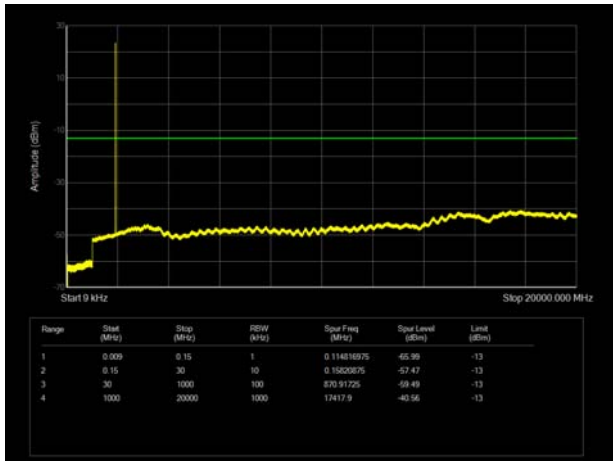

LTE Band 2 3MHz CH-High 9kHz~20GHz

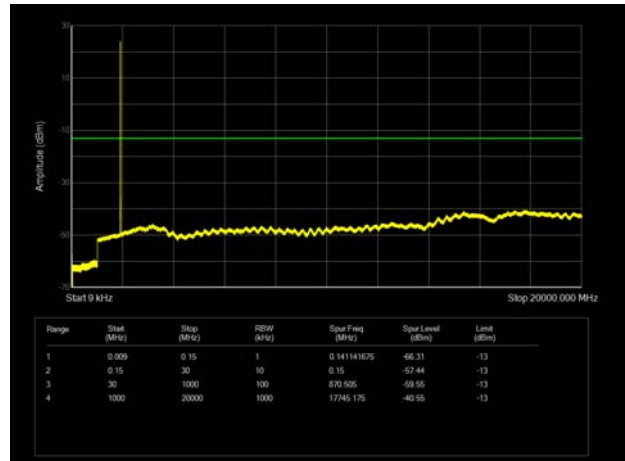



LTE Band 2 5MHz CH-Low 9kHz~20GHz

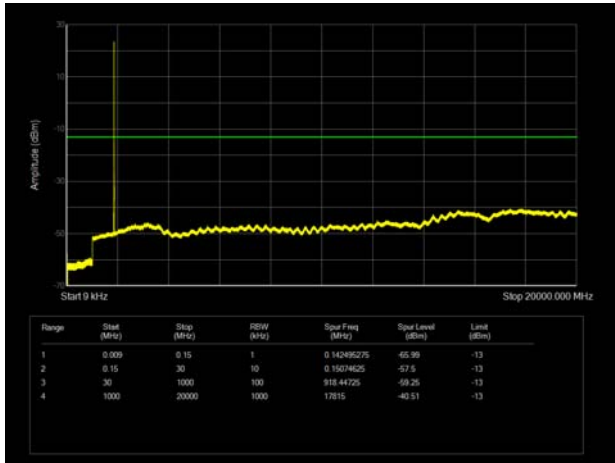

LTE Band 2 10MHz CH-Low 9kHz~20GHz

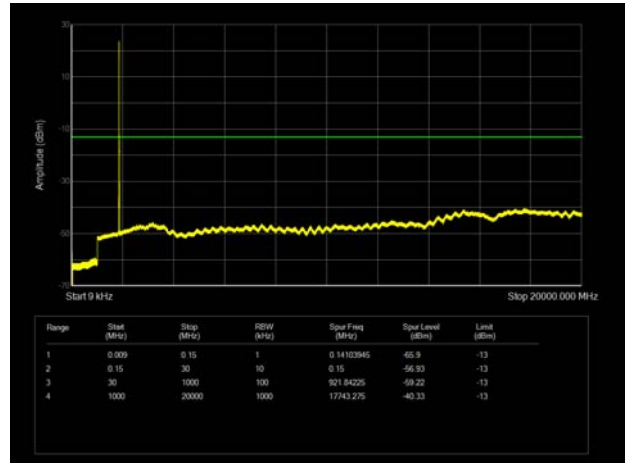

LTE Band 2 5MHz CH-Middle 9kHz~20GHz

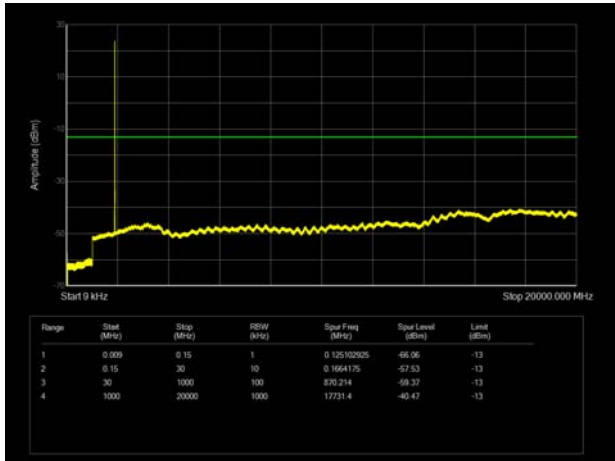

LTE Band 2 10MHz CH-Middle 9kHz~20GHz

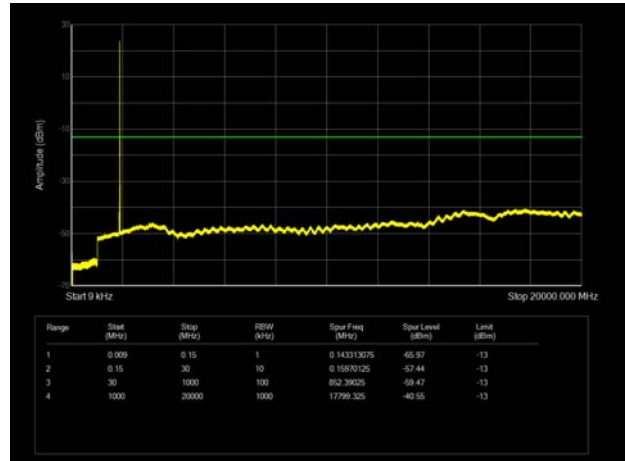

LTE Band 2 5MHz CH-High 9kHz~20GHz

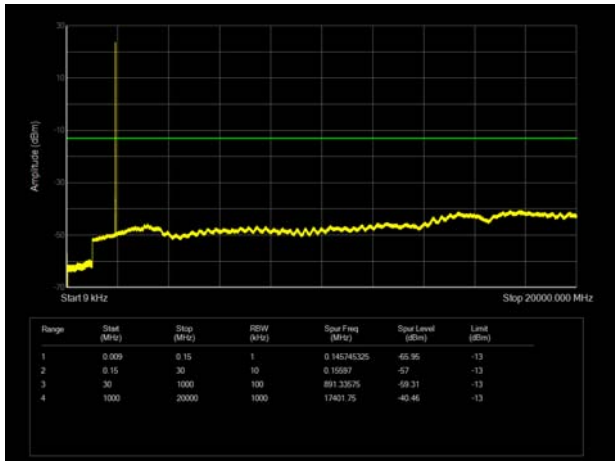

LTE Band 2 10MHz CH-High 9kHz~20GHz

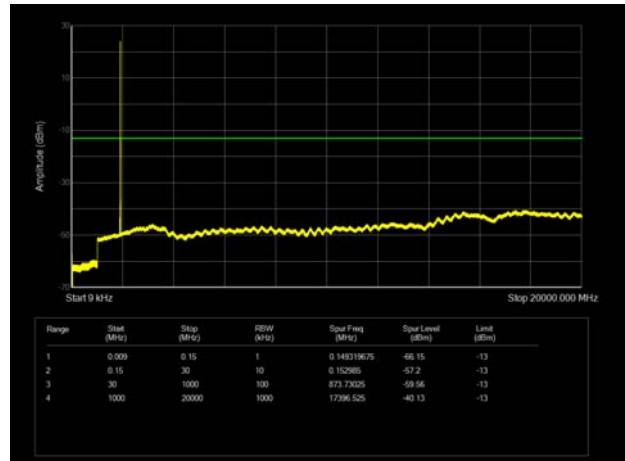

LTE Band 2 15MHz CH-Low 9kHz~20GHz

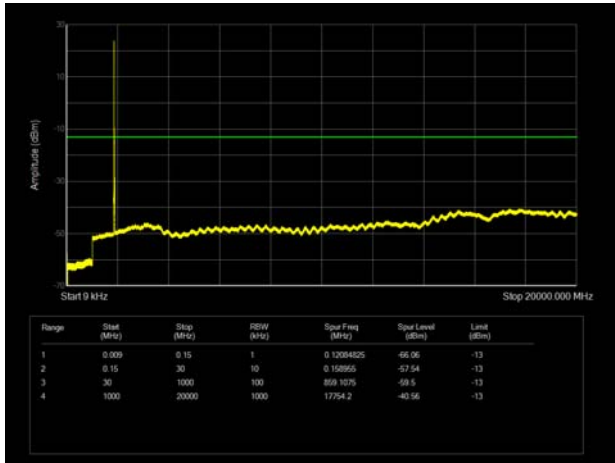

LTE Band 2 20MHz CH-Low 9kHz~20GHz

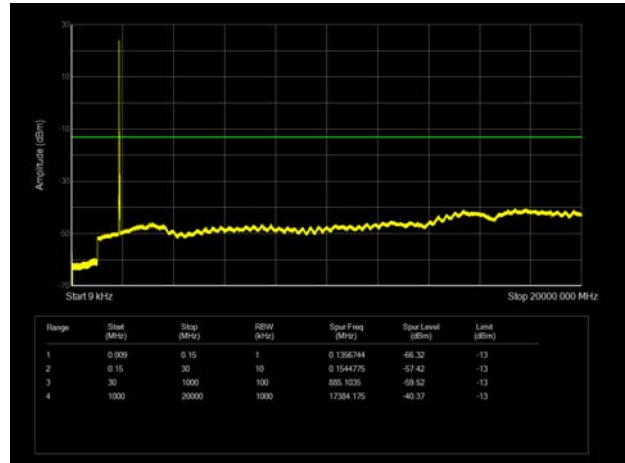

LTE Band 2 15MHz CH-Middle 9kHz~20GHz

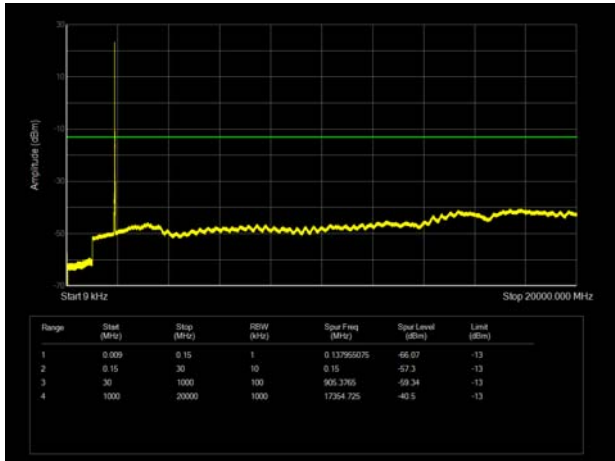

LTE Band 2 20MHz CH-Middle 9kHz~20GHz

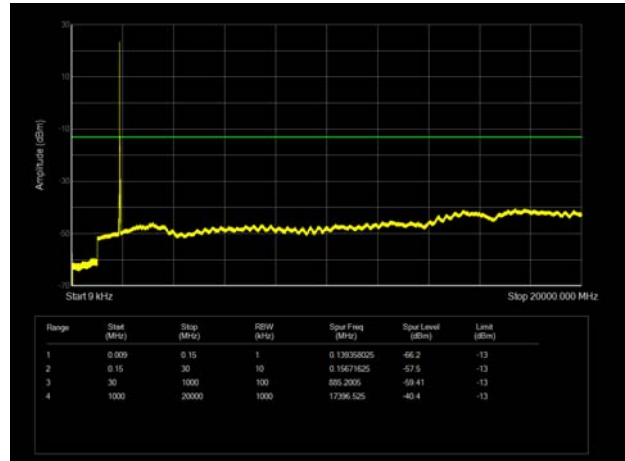

LTE Band 2 15MHz CH-High 9kHz~20GHz

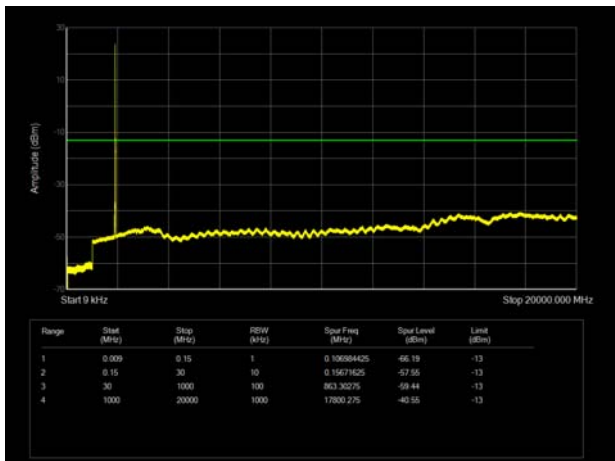

LTE Band 2 20MHz CH-High 9kHz~20GHz

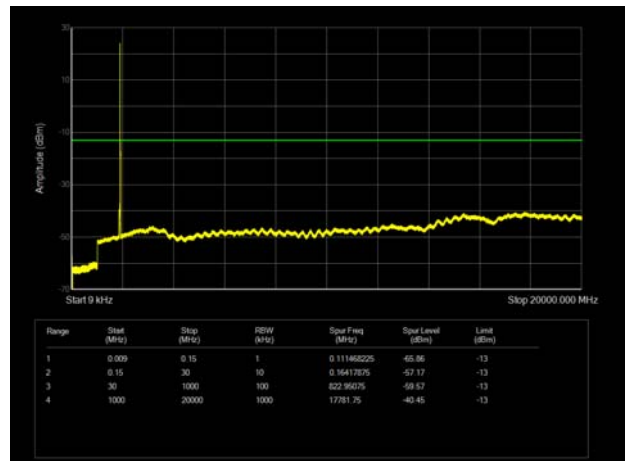

5.7. Radiates Spurious Emission

Ambient condition

Temperature	Relative humidity	Pressure
23°C ~25°C	45%~50%	101.5kPa

Method of Measurement

- The testing follows FCC KDB 971168 v03r01 Section 5.8 and ANSI C63.26 (2015).
- Below 1GHz: The EUT is placed on a turntable 0.8 meters above the ground in the chamber, 3 meter away from the antenna. The maximal emission value is acquired by adjusting the antenna height, polarisation and turntable azimuth. Normally, the height range of antenna is 1 m to 4 m, the azimuth range of turntable is 0° to 360°, and the receive antenna has two polarizations Vertical (V) and Horizontal (H). Above 1GHz: (Note: the FCC's permission to use 1.5m as an alternative per TCBC Conf call of Dec. 2, 2014.) The EUT is placed on a turntable 1.5 meters above the ground in the chamber, 3 meter away from the antenna. The maximal emission value is acquired by adjusting the antenna height, polarisation and turntable azimuth. Normally, the height range of antenna is 1 m to 4 m, the azimuth range of turntable is 0° to 360°, and the receive antenna has two polarizations Vertical (V) and Horizontal (H).
- A loop antenna, A log-periodic antenna or horn antenna shall be substituted in place of the EUT. The log-periodic antenna will be driven by a signal generator and the level will be adjusted till the same power value on the spectrum analyzer or receiver. The level of the spurious emissions can be calculated through the level of the signal generator, cable loss, the gain of the substitution antenna and the reading of the spectrum analyzer or receiver.
- The EUT is then put into continuously transmitting mode at its maximum power level during the test. Set Test Receiver or Spectrum RBW=200Hz,VBW=600Hz for 9kHz-150kHz , RBW=10kHz, VBW=30kHz 150kHz-30MHz , RBW=100kHz,VBW=300kHz for 30MHz to 1GHz and RBW=1MHz, VBW=3MHz for above 1GHz, And the maximum value of the receiver should be recorded as (Pr).
- The EUT shall be replaced by a substitution antenna. In the chamber, an substitution antenna for the frequency band of interest is placed at the reference point of the chamber. An RF Signal source for the frequency band of interest is connected to the substitution antenna with a cable that has been constructed to not interfere with the radiation pattern of the antenna. A power (PMea) is applied to the input of the substitution antenna, and adjust the level of the signal generator output until the value of the receiver reach the previously recorded (Pr). The power of signal source (PMea) is recorded. The test should be performed by rotating the test item and adjusting the receiving antenna polarization.
- A amplifier should be connected to the Signal Source output port. And the cable should be connect between the Amplifier and the Substitution Antenna. The cable loss (Pcl) ,the Substitution Antenna Gain (Ga) and the Amplifier Gain (PAg) should be recorded after test.
- The measurement results are obtained as described below:
 $Power(EIRP)=PMea- PAg - Pcl + Ga$
 The measurement results are amend as described below:
 $Power(EIRP)=PMea- Pcl + Ga$
- This value is EIRP since the measurement is calibrated using an antenna of known gain (2.15 dBi)

and known input power. ERP can be calculated from EIRP by subtracting the gain of the dipole, $ERP = EIRP - 2.15\text{dBi}$.

The modulation mode and RB allocation refer to section 5.1, using the maximum output power configuration.

Test setup

9KHz ~ 30MHz

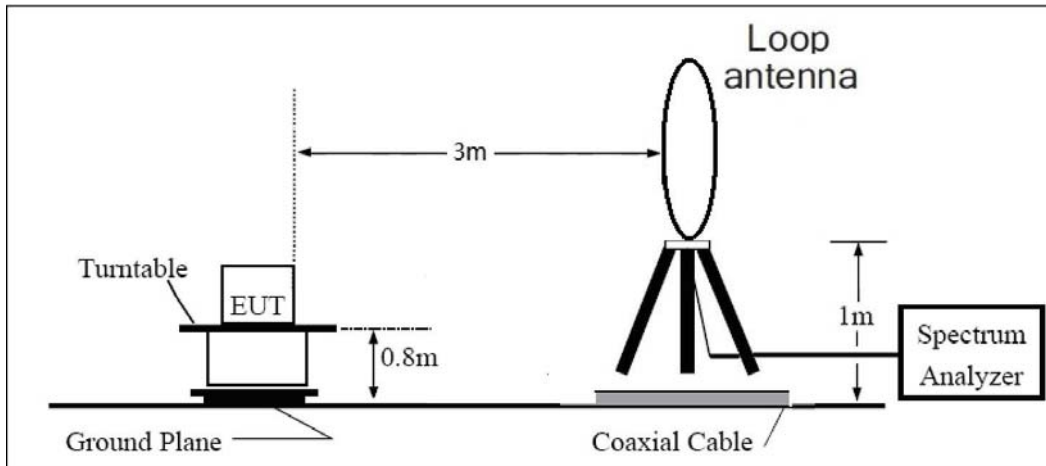

30MHz ~ 1GHz

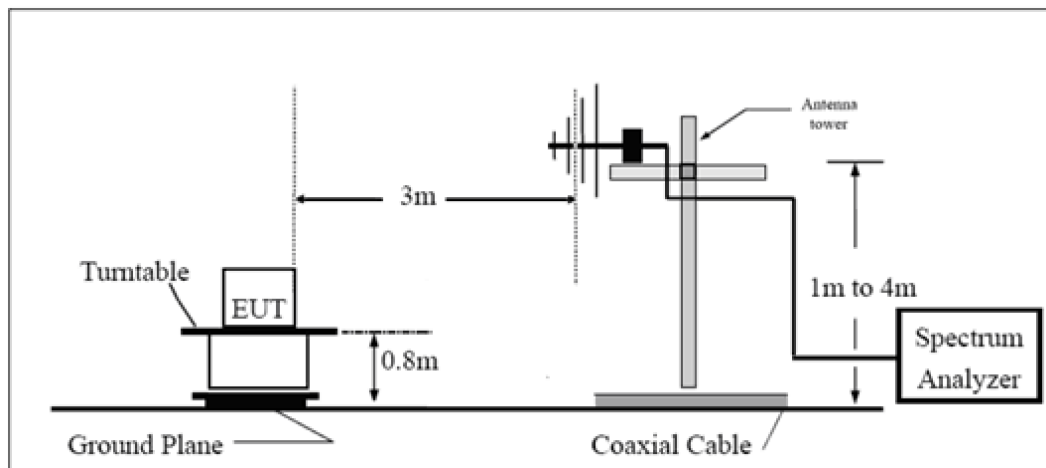

Above 1GHz

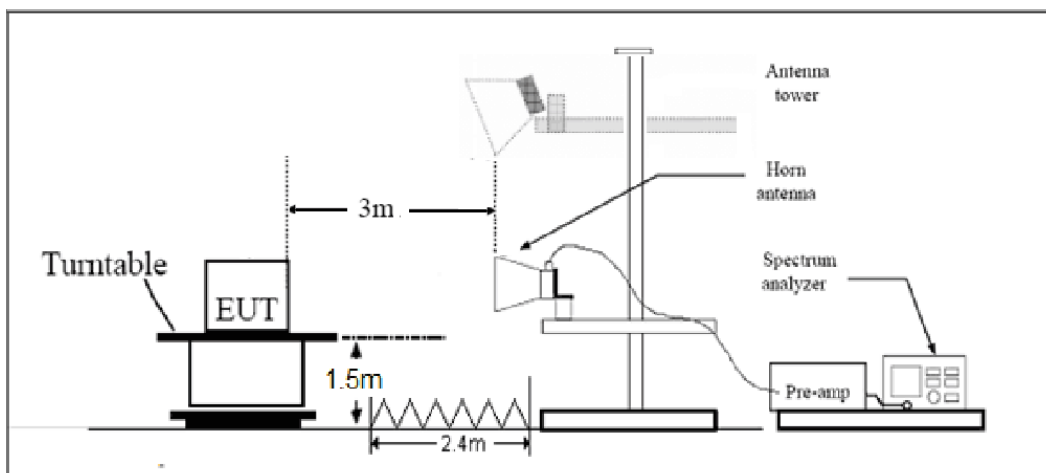



Note: Area side: 2.4mX3.6m

Limits

Rule Part 24.238(a) specifies that “on any frequency outside a licensee's frequency block, the power of any emission shall be attenuated below the transmitter power (P) by at least $43 + 10 \log_{10}(P)$ dB.”

Limit	-13 dBm
-------	---------

Measurement Uncertainty

The assessed measurement uncertainty to ensure 95% confidence level for the normal distribution is with the coverage factor $k = 1.96$, $U = 3.55$ dB.

Test Result

Sweep the whole frequency band through the range from 9kHz to the 10th harmonic of the carrier, the emissions below the noise floor will not be recorded in the report.

Main antenna

GSM 1900 CH-Middle

Harmonic	Frequency (MHz)	SG (dBm)	Cable Loss (dB)	Gain (dBi)	Antenna Polarization	EIRP Level (dBm)	Limit (dBm)	Margin (dB)	Azimuth (deg)
2	3760.00	-63.66	2.60	12.50	Horizontal	-55.91	-13.00	42.91	90
3	5640.00	-59.14	3.30	12.50	Horizontal	-52.09	-13.00	39.09	135
4	7520.00	-53.68	4.20	12.20	Horizontal	-47.83	-13.00	34.83	45
5	9400.00	-49.23	4.30	11.10	Horizontal	-44.58	-13.00	31.58	225
6	11280.00	-44.80	5.90	11.90	Horizontal	-40.95	-13.00	27.95	90
7	13160.00	-44.26	5.70	14.00	Horizontal	-38.11	-13.00	25.11	180
8	15040.00	-51.60	5.80	13.10	Horizontal	-46.45	-13.00	33.45	45
9	16920.00	-47.43	6.10	14.60	Horizontal	-41.08	-13.00	28.08	0
10	18800.00	-	-	-	-	-	-	-	-

Note: 1.The other Spurious RF Radiated emissions level is no more than noise floor.
 2. The worst emission was found in the antenna is Horizontal position.

WCDMA Band II CH-Middle

Harmonic	Frequency (MHz)	SG (dBm)	Cable Loss (dB)	Gain (dBi)	Antenna Polarization	EIRP Level (dBm)	Limit (dBm)	Margin (dB)	Azimuth (deg)
2	3760.00	-64.37	2.60	12.50	Horizontal	-56.62	-13.00	43.62	45
3	5640.00	-58.82	3.30	12.50	Horizontal	-51.77	-13.00	38.77	315
4	7520.00	-55.10	4.20	12.20	Horizontal	-49.25	-13.00	36.25	90
5	9400.00	-50.27	4.30	11.10	Horizontal	-45.62	-13.00	32.62	225
6	11280.00	-47.38	5.90	11.90	Horizontal	-43.53	-13.00	30.53	45
7	13160.00	-48.95	5.70	14.00	Horizontal	-42.80	-13.00	29.80	180
8	15040.00	-52.05	5.80	13.10	Horizontal	-46.90	-13.00	33.90	45
9	16920.00	-48.70	6.10	14.60	Horizontal	-42.35	-13.00	29.35	90
10	18800.00	-	-	-	-	-	-	-	-

Note: 1.The other Spurious RF Radiated emissions level is no more than noise floor.
 2. The worst emission was found in the antenna is Horizontal position.



LTE Band 2 1.4MHz CH-Middle

Harmonic	Frequency (MHz)	SG (dBm)	Cable Loss (dB)	Gain (dBi)	Antenna Polarization	EIRP Level (dBm)	Limit (dBm)	Margin (dB)	Azimuth (deg)
2	3759.00	-61.79	2.60	12.50	Horizontal	-54.04	-13.00	41.04	180
3	5638.88	-43.54	3.30	12.50	Horizontal	-36.49	-13.00	23.49	225
4	7520.00	-54.90	4.20	12.20	Horizontal	-49.05	-13.00	36.05	270
5	9400.00	-51.23	4.30	11.10	Horizontal	-46.58	-13.00	33.58	315
6	11280.00	-45.78	5.90	11.90	Horizontal	-41.93	-13.00	28.93	180
7	13160.00	-50.04	5.70	14.00	Horizontal	-43.89	-13.00	30.89	225
8	15040.00	-51.93	5.80	13.10	Horizontal	-46.78	-13.00	33.78	45
9	16920.00	-50.23	6.10	14.60	Horizontal	-43.88	-13.00	30.88	135
10	18800.00	-	-	-	-	-	-	-	-

Note: 1.The other Spurious RF Radiated emissions level is no more than noise floor.
2. The worst emission was found in the antenna is Horizontal position.

LTE Band 2 5MHz CH-Middle

Harmonic	Frequency (MHz)	SG (dBm)	Cable Loss (dB)	Gain (dBi)	Antenna Polarization	EIRP Level (dBm)	Limit (dBm)	Margin (dB)	Azimuth (deg)
2	3755.63	-56.94	2.60	12.50	Horizontal	-49.19	-13.00	36.19	135
3	5633.63	-46.94	3.30	12.50	Horizontal	-39.89	-13.00	26.89	180
4	7520.00	-54.95	4.20	12.20	Horizontal	-49.10	-13.00	36.10	225
5	9400.00	-51.21	4.30	11.10	Horizontal	-46.56	-13.00	33.56	315
6	11280.00	-47.02	5.90	11.90	Horizontal	-43.17	-13.00	30.17	45
7	13160.00	-50.66	5.70	14.00	Horizontal	-44.51	-13.00	31.51	0
8	15040.00	-51.14	5.80	13.10	Horizontal	-45.99	-13.00	32.99	45
9	16920.00	-51.00	6.10	14.60	Horizontal	-44.65	-13.00	31.65	90
10	18800.00	-	-	-	-	-	-	-	-

Note: 1.The other Spurious RF Radiated emissions level is no more than noise floor.
2. The worst emission was found in the antenna is Horizontal position.

LTE Band 2 20MHz CH-Middle

Harmonic	Frequency (MHz)	SG (dBm)	Cable Loss (dB)	Gain (dBi)	Antenna Polarization	EIRP Level (dBm)	Limit (dBm)	Margin (dB)	Azimuth (deg)
2	3742.13	-58.74	2.60	12.50	Horizontal	-50.99	-13.00	37.99	135
3	5613.38	-50.41	3.30	12.50	Horizontal	-43.36	-13.00	30.36	225
4	7484.63	-55.27	4.20	12.20	Horizontal	-49.42	-13.00	36.42	315
5	9400.00	-50.71	4.30	11.10	Horizontal	-46.06	-13.00	33.06	90
6	11280.00	-47.24	5.90	11.90	Horizontal	-43.39	-13.00	30.39	180
7	13160.00	-50.36	5.70	14.00	Horizontal	-44.21	-13.00	31.21	45
8	15040.00	-51.27	5.80	13.10	Horizontal	-46.12	-13.00	33.12	2700
9	16920.00	-50.22	6.10	14.60	Horizontal	-43.87	-13.00	30.87	225
10	18800.00	-	-	-	-	-	-	-	-

Note: 1.The other Spurious RF Radiated emissions level is no more than noise floor.
2. The worst emission was found in the antenna is Horizontal position.

Second antenna

GSM 1900 CH-Middle

Harmonic	Frequency (MHz)	SG (dBm)	Cable Loss (dB)	Gain (dBi)	Antenna Polarization	EIRP Level (dBm)	Limit (dBm)	Margin (dB)	Azimuth (deg)
2	3760.00	-63.41	2.60	12.50	Horizontal	-55.66	-13.00	42.66	90
3	5640.00	-60.20	3.30	12.50	Horizontal	-53.15	-13.00	40.15	45
4	7520.00	-54.17	4.20	12.20	Horizontal	-48.32	-13.00	35.32	315
5	9400.00	-49.12	4.30	11.10	Horizontal	-44.47	-13.00	31.47	180
6	11280.00	-45.78	5.90	11.90	Horizontal	-41.93	-13.00	28.93	255
7	13160.00	-42.30	5.70	14.00	Horizontal	-36.15	-13.00	23.15	135
8	15040.00	-50.73	5.80	13.10	Horizontal	-45.58	-13.00	32.58	45
9	16920.00	-47.76	6.10	14.60	Horizontal	-41.41	-13.00	28.41	90
10	18800.00	-	-	-	-	-	-	-	-

Note: 1.The other Spurious RF Radiated emissions level is no more than noise floor.
2. The worst emission was found in the antenna is Horizontal position.

WCDMA Band II CH-Middle

Harmonic	Frequency (MHz)	SG (dBm)	Cable Loss (dB)	Gain (dBi)	Antenna Polarization	EIRP Level (dBm)	Limit (dBm)	Margin (dB)	Azimuth (deg)
2	3760.00	-63.41	2.60	12.50	Horizontal	-55.66	-13.00	42.66	0
3	5640.00	-59.24	3.30	12.50	Horizontal	-52.19	-13.00	39.19	45
4	7520.00	-54.56	4.20	12.20	Horizontal	-48.71	-13.00	35.71	90
5	9400.00	-49.88	4.30	11.10	Horizontal	-45.23	-13.00	32.23	315
6	11280.00	-47.65	5.90	11.90	Horizontal	-43.80	-13.00	30.80	225
7	13160.00	-48.78	5.70	14.00	Horizontal	-42.63	-13.00	29.63	135
8	15040.00	-50.55	5.80	13.10	Horizontal	-45.40	-13.00	32.40	45
9	16920.00	-47.44	6.10	14.60	Horizontal	-41.09	-13.00	28.09	90
10	18800.00	-	-	-	-	-	-	-	-

Note: 1.The other Spurious RF Radiated emissions level is no more than noise floor.
2. The worst emission was found in the antenna is Horizontal position.

LTE Band 2 1.4MHz CH-Middle

Harmonic	Frequency (MHz)	SG (dBm)	Cable Loss (dB)	Gain (dBi)	Antenna Polarization	EIRP Level (dBm)	Limit (dBm)	Margin (dB)	Azimuth (deg)
2	3759.00	-61.28	2.60	12.50	Horizontal	-53.53	-13.00	40.53	270
3	5638.88	-49.30	3.30	12.50	Horizontal	-42.25	-13.00	29.25	0
4	7520.00	-54.05	4.20	12.20	Horizontal	-48.20	-13.00	35.20	45
5	9400.00	-48.48	4.30	11.10	Horizontal	-43.83	-13.00	30.83	315
6	11280.00	-46.75	5.90	11.90	Horizontal	-42.90	-13.00	29.90	90
7	13160.00	-47.27	5.70	14.00	Horizontal	-41.12	-13.00	28.12	45
8	15040.00	-51.75	5.80	13.10	Horizontal	-46.60	-13.00	33.60	225
9	16920.00	-47.47	6.10	14.60	Horizontal	-41.12	-13.00	28.12	90
10	18800.00	-	-	-	-	-	-	-	-

Note: 1.The other Spurious RF Radiated emissions level is no more than noise floor.
2. The worst emission was found in the antenna is Horizontal position.

LTE Band 2 5MHz CH-Middle

Harmonic	Frequency (MHz)	SG (dBm)	Cable Loss (dB)	Gain (dBi)	Antenna Polarization	EIRP Level (dBm)	Limit (dBm)	Margin (dB)	Azimuth (deg)
2	3755.63	-61.28	2.60	12.50	Horizontal	-53.53	-13.00	40.53	0
3	5633.63	-40.74	3.30	12.50	Horizontal	-33.69	-13.00	20.69	45
4	7520.00	-54.51	4.20	12.20	Horizontal	-48.66	-13.00	35.66	45
5	9400.00	-49.06	4.30	11.10	Horizontal	-44.41	-13.00	31.41	315
6	11280.00	-46.23	5.90	11.90	Horizontal	-42.38	-13.00	29.38	90
7	13160.00	-47.11	5.70	14.00	Horizontal	-40.96	-13.00	27.96	45
8	15040.00	-51.88	5.80	13.10	Horizontal	-46.73	-13.00	33.73	225
9	16920.00	-47.55	6.10	14.60	Horizontal	-41.20	-13.00	28.20	90
10	18800.00	-	-	-	-	-	-	-	-

Note: 1.The other Spurious RF Radiated emissions level is no more than noise floor.
2. The worst emission was found in the antenna is Horizontal position.

LTE Band 2 20MHz CH-Middle

Harmonic	Frequency (MHz)	SG (dBm)	Cable Loss (dB)	Gain (dBi)	Antenna Polarization	EIRP Level (dBm)	Limit (dBm)	Margin (dB)	Azimuth (deg)
2	3742.13	-63.10	2.60	12.50	Horizontal	-55.35	-13.00	42.35	315
3	5613.38	-58.53	3.30	12.50	Horizontal	-51.48	-13.00	38.48	90
4	7484.63	-53.16	4.20	12.20	Horizontal	-47.31	-13.00	34.31	270
5	9400.00	-49.40	4.30	11.10	Horizontal	-44.75	-13.00	31.75	225
6	11280.00	-47.15	5.90	11.90	Horizontal	-43.30	-13.00	30.30	45
7	13160.00	-47.86	5.70	14.00	Horizontal	-41.71	-13.00	28.71	315
8	15040.00	-51.16	5.80	13.10	Horizontal	-46.01	-13.00	33.01	90
9	16920.00	-47.70	6.10	14.60	Horizontal	-41.35	-13.00	28.35	225
10	18800.00	-	-	-	-	-	-	-	-

Note: 1.The other Spurious RF Radiated emissions level is no more than noise floor.
2. The worst emission was found in the antenna is Horizontal position.

6. Main Test Instruments

Name	Manufacturer	Type	Serial Number	Calibration Date	Expiration Date
Base Station Simulator	R&S	CMU200	118133	2020-05-17	2021-05-16
Base Station Simulator	R&S	CMW500	113824	2020-05-18	2021-05-17
Power Splitter	Hua Xiang	SHX-GF2-2-13	10120101	/	/
Spectrum Analyzer	Key sight	N9010A	MY50210259	2020-05-18	2021-05-17
Universal Radio Communication Tester	Key sight	E5515C	MY48367192	2020-05-27	2021-05-26
Signal Analyzer	R&S	FSV30	100815	2020-12-13	2021-12-12
Loop Antenna	SCHWARZBECK	FMZB1519	1519-047	2020-04-02	2023-04-01
TRILOG Broadband Antenna	SCHWARZBECK	VULB 9163	391	2019-12-16	2021-12-15
Horn Antenna	R&S	HF907	102723	2018-08-11	2021-08-10
Horn Antenna	ETS-Lindgren	3160-09	00102643	2018-06-20	2021-06-19
Signal generator	R&S	SMB 100A	102594	2020-05-18	2021-05-17
Climatic Chamber	ESPEC	SU-242	93000506	2020-12-13	2021-12-12
Preamplifier	R&S	SCU18	102327	2020-05-18	2021-05-17
MOB COMMS DC SUPPLY	Keysight	66319D	MY43004105	2020-05-18	2021-05-17
RF Cable	Agilent	SMA 15cm	0001	2020-12-10	2021-06-11
Software	R&S	EMC32	9.26.0	/	/

*****END OF REPORT *****



ANNEX A: The EUT Appearance

The EUT Appearance are submitted separately.



ANNEX B: Test Setup Photos

The Test Setup Photos are submitted separately.



ANNEX C: Product Change Description

The Product Change Description are submitted separately.