



RF TEST REPORT

Applicant Xiaomi Communications Co., Ltd.
FCC ID 2AFZZ117BPG
Product Mobile Phone
Brand POCO
Model 2207117BPG
Report No. R2206A0560-R1
Issue Date July 4, 2022

TA Technology (Shanghai) Co., Ltd. tested the above equipment in accordance with the requirements in **FCC CFR47 Part 2 (2021)/ FCC CFR 47 Part 22H (2021)**. The test results show that the equipment tested is capable of demonstrating compliance with the requirements as documented in this report.

Prepared by: Xu Ying

Approved by: Xu Kai

TA Technology (Shanghai) Co., Ltd.

Building 3, No.145, Jintang Rd, Tangzhen Industry Park, Pudong Shanghai, China

TEL: +86-021-50791141/2/3

FAX: +86-021-50791141/2/3-8000



TABLE OF CONTENT

1. Test Laboratory	4
1.1. Notes of the Test Report	4
1.2. Test facility	4
1.3. Testing Location	4
2. General Description of Equipment under Test.....	5
2.1. Applicant and Manufacturer Information	5
2.2. General Information.....	5
3. Applied Standards	7
4. Test Configuration.....	8
5. Test Case Results.....	10
5.1. RF Power Output and Effective Radiated Power	10
5.2. Occupied Bandwidth	15
5.3. Band Edge Compliance.....	26
5.4. Peak-to-Average Power Ratio (PAPR)	37
5.5. Frequency Stability.....	41
5.6. Spurious Emissions at Antenna Terminals	45
5.7. Radiates Spurious Emission	50
6. Main Test Instruments	59
ANNEX A: The EUT Appearance	60
ANNEX B: Test Setup Photos	61
ANNEX C: Product Change Description	62

Summary of measurement results

No.	Test Case	Clause in FCC rules	Verdict
1	RF Power Output and Effective Radiated Power	2.1046 22.913(a)(5)	PASS
2	Occupied Bandwidth	2.1049	PASS
3	Band Edge Compliance	2.1051 / 22.917(a)	PASS
4	Peak-to-Average Power Ratio	22.913(d)/ KDB 971168 D01(5.7)	PASS
5	Frequency Stability	2.1055 / 22.355	PASS
6	Spurious Emissions at Antenna Terminals	2.1051 / 22.917(a)	PASS
7	Radiates Spurious Emission	2.1053 / 22.917 (a)	PASS

Date of Testing: February 8, 2021 ~ March 3, 2021

Date of Sample Received: February 7, 2021

Note: PASS: The EUT complies with the essential requirements in the standard.

FAIL: The EUT does not comply with the essential requirements in the standard.

All indications of Pass/Fail in this report are opinions expressed by TA Technology (Shanghai) Co., Ltd. based on interpretations and/or observations of test results. Measurement Uncertainties were not taken into account and are published for informational purposes only.

2207117BPG (Report No.: R2206A0560-R1) is a variant model of M2101K7BNY (Report No.: R2101A0095-R1). Test values all duplicated from Original for variant. There is no tested in the report.

The difference between model 2207117BPG and M2101K7BNY are shown in the table below:

Item	Original	Variant
Brand	Redmi	POCO
Model	M2101K7BNY	2207117BPG
Hardware Version	P2	P1.1
Software Version	MIUI 12	MIUI 13
RAM	8G+128G; 6G+128G; 6G+64G	4+64G;4+128G; 6+128G
Accessory	USB cable L23220、H23220、 B23220	USB cable L23230、 H23230、B23230
Color	--	add blue version

The detailed product change description please refers to the *Difference Declaration Letter*.



1. Test Laboratory

1.1. Notes of the Test Report

This report shall not be reproduced in full or partial, without the written approval of **TA technology (shanghai) co., Ltd.** The results documented in this report apply only to the tested sample, under the conditions and modes of operation as described herein. Measurement Uncertainties were not taken into account and are published for informational purposes only. This report is written to support regulatory compliance of the applicable standards stated above.

1.2. Test facility

FCC (Designation number: CN1179, Test Firm Registration Number: 446626)

TA Technology (Shanghai) Co., Ltd. has been listed on the US Federal Communications Commission list of test facilities recognized to perform measurements.

A2LA (Certificate Number: 3857.01)

TA Technology (Shanghai) Co., Ltd. has been listed by American Association for Laboratory Accreditation to perform measurement.

1.3. Testing Location

Company: TA Technology (Shanghai) Co., Ltd.
Address: Building 3, No.145, Jintang Rd, Tangzhen Industry Park, Pudong
City: Shanghai
Post code: 201201
Country: P. R. China
Contact: Xu Kai
Telephone: +86-021-50791141/2/3
Fax: +86-021-50791141/2/3-8000
Website: <http://www.ta-shanghai.com>
E-mail: xukai@ta-shanghai.com

2. General Description of Equipment under Test

2.1. Applicant and Manufacturer Information

Applicant	Xiaomi Communications Co., Ltd.
Applicant address	#019, 9th Floor, Building 6, 33 Xi'erqi Middle Road, Haidian District, Beijing, China, 100085
Manufacturer	Xiaomi Communications Co., Ltd.
Manufacturer address	#019, 9th Floor, Building 6, 33 Xi'erqi Middle Road, Haidian District, Beijing, China, 100085

2.2. General Information

EUT Description				
Model	2207117BPG			
IMEI	Original	IMEI 1: 869421050050226 IMEI 2: 869421050050234		
	Variant	IMEI 1: 867701060029563 IMEI 2: 867701060029571		
Hardware Version	P1.1			
Software Version	MIUI 13			
Power Supply	Battery / AC adapter			
Antenna Type	Fixed Internal Antenna			
Antenna Gain	Band	Frequency (MHz)	Main Antenna (dBi)	Second Antenna (dBi)
	GSM850/ WCDMA Band V/ LTE Band 5	820	-5.11	-3.86
		830	-3.41	-4.06
		840	-3.56	-3.97
		850	-3.12	-4.40
Memory	6G+128G; 4G+64G; 4G+128G			
Test Mode(s)	GSM 850; WCDMA Band V; LTE Band 5;			
Test Modulation	(GSM/GPRS) GMSK, (EGPRS) GMSK/ 8PSK; (WCDMA) BPSK, QPSK, 16QAM; (LTE) QPSK, 16QAM, 64QAM, 256QAM(DL only);			
GPRS Multislot Class	12			
EGPRS Multislot Class	12			
HSDPA UE Category	24			
HSUPA UE Category	7			
LTE Release	R12			
Maximum E.R.P.	GSM 850:	26.90 dBm		
	WCDMA Band V:	17.71 dBm		



	LTE Band 5:	18.85 dBm	
Rated Power Supply Voltage	3.87V		
Supply Voltage	Minimum: 3.6V Maximum: 4.45V		
Operating Temperature	Lowest: 0°C Highest: +40°C		
Extreme Temperature	Lowest: -30°C Highest: +50°C		
Operating Frequency Range(s)	Band	Tx (MHz)	Rx (MHz)
	GSM850	824 ~ 849	869 ~ 894
	WCDMA Band V	824 ~ 849	869 ~ 894
	LTE Band 5	824 ~ 849	869 ~ 894
Note: 1. The EUT is sent from the applicant to TA and the information of the EUT is declared by the applicant.			



3. Applied Standards

According to the specifications of the manufacturer, it must comply with the requirements of the following standards:

Test standards:

FCC CFR 47 Part 22H (2021)

ANSI C63.26-2015

Reference standard:

FCC CFR47 Part 2 (2021)

KDB 971168 D01 Power Meas License Digital Systems v03r01

4. Test Configuration

There is more than one SIM card slot, each one should be applied throughout the compliance test respectively, and however, only the worst case (SIM 1) will be recorded in this report.

Radiated measurements are performed by rotating the EUT in three different orthogonal test planes. EUT stand-up position (Z axis), lie-down position (X, Y axis). Receiver antenna polarization (horizontal and vertical), the worst emission was found in position (Z axis, horizontal polarization) and the worst case was recorded.

All mode and data rates and positions and RB size and modulations were investigated.

Subsequently, only the worst case emissions are reported.

The following testing in GSM/WCDMA/LTE is set based on the maximum RF Output Power.

Test modes are chosen to be reported as the worst case configuration below:

Test items	Modes/Modulation	
	GSM 850	WCDMA Band V
RF Power Output and Effective Radiated power	GSM GPRS EGPRS	RMC HSDPA/HSUPA DC-HSDPA/HSPA+
Occupied Bandwidth	GSM GPRS(1Tx slot) EGPRS(1Tx slot)	RMC
Band Edge Compliance	GSM GPRS(1Tx slot) EGPRS(1Tx slot)	RMC
Peak-to-Average Power Ratio	GSM GPRS(1Tx slot) EGPRS(1Tx slot)	RMC
Frequency Stability	GSM GPRS(1Tx slot) EGPRS(1Tx slot)	RMC
Spurious Emissions at Antenna Terminals	GSM	RMC
Radiates Spurious Emission	GSM	RMC



Test modes are chosen as the worst case configuration below for LTE Band 5.

Test items	Bandwidth (MHz)				Modulation			RB			Test Channel		
	1.4	3	5	10	QPSK	16QAM	64QAM	1	50%	100%	L	M	H
RF power output and Effective Radiated power	○	○	○	○	○	○	○	○	○	○	○	○	○
Occupied Bandwidth	○	○	○	○	○	○	○	-	-	○	○	○	○
Band Edge Compliance	○	○	○	○	○	○	○	○	-	○	○	-	○
Peak-to-Average Power Ratio	○	○	○	○	○	○	○	-	-	○	○	○	○
Frequency Stability	○	○	○	○	○	○	○	○	-	-	-	○	-
Spurious Emissions at Antenna Terminals	○	○	○	○	○	-	-	○	-	-	○	○	○
Radiates Spurious Emission	○	-	○	○	○	-	-	○	-	-	-	○	-
Note	1. The mark "○" means that this configuration is chosen for testing. 2. The mark "-" means that this configuration is not testing.												

5. Test Case Results

5.1. RF Power Output and Effective Radiated Power

Ambient condition

Temperature	Relative humidity	Pressure
23°C ~25°C	45%~50%	101.5kPa

Methods of Measurement

During the process of the testing, The EUT was connected to the Base Station Simulator with a known loss. The EUT is controlled by the Base Station Simulator test set to ensure max power transmission with proper modulation.

ERP can then be calculated as follows:

$$\text{EIRP (dBm)} = \text{Output Power (dBm)} - \text{Losses (dB)} + \text{Antenna Gain (dBi)}$$

where:dBd refers to gain relative to an ideal dipole.

$$\text{EIRP (dBm)} = \text{ERP (dBm)} + 2.15 \text{ (dB)}.$$

Test Setup

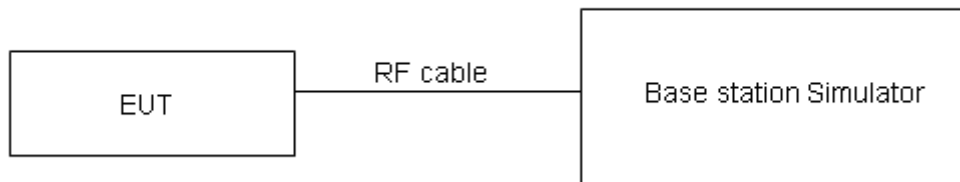

Limits

No specific RF power output requirements in part 2.1046.

Rule Part 22.913(a)(5) specifies that "Mobile/portable stations are limited to 7 watts ERP".

Limit	≤ 7 W (38.45 dBm)
-------	-------------------

Measurement Uncertainty

The assessed measurement uncertainty to ensure 95% confidence level for the normal distribution is with the coverage factor $k = 2$, $U = 0.4$ dB for RF power output, $k = 2$, $U = 1.19$ dB for ERP.



Test Results

GSM 850		Maximum Output Power (dBm)			ERP (dBm) Main Antenna			ERP (dBm) Second antenna		
		Channel 128	Channel 190	Channel 251	Channel 128	Channel 190	Channel 251	Channel 128	Channel 190	Channel 251
		824.2 (MHz)	836.6 (MHz)	848.8 (MHz)	824.2 (MHz)	836.6 (MHz)	848.8 (MHz)	824.2 (MHz)	836.6 (MHz)	848.8 (MHz)
GSM (GMSK)	Results	32.16	32.13	32.13	24.90	26.42	26.86	26.15	26.01	25.58
GPRS/EGPRS (GMSK)	1TXslot	32.16	32.13	32.17	24.90	26.42	26.90	26.15	26.01	25.62
	2TXslots	30.04	30.10	29.90	22.78	24.39	24.63	24.03	23.98	23.35
	3TXslots	28.29	28.19	28.16	21.03	22.48	22.89	22.28	22.07	21.61
	4TXslots	26.39	26.27	26.22	19.13	20.56	20.95	20.38	20.15	19.67
EGPRS (8PSK)	1TXslot	26.99	27.28	27.32	19.73	21.57	22.05	20.98	21.16	20.77
	2TXslots	24.34	24.83	24.88	17.08	19.12	19.61	18.33	18.71	18.33
	3TXslots	23.10	23.25	23.35	15.84	17.54	18.08	17.09	17.13	16.80
	4TXslots	21.85	21.92	21.91	14.59	16.21	16.64	15.84	15.80	15.36

WCDMA Band V		Maximum Output Power (dBm)			ERP (dBm) Main Antenna			ERP (dBm) Second antenna		
		Channel 4132	Channel 4183	Channel 4233	Channel 4132	Channel 4183	Channel 4233	Channel 4132	Channel 4183	Channel 4233
		826.4 (MHz)	836.6 (MHz)	846.6 (MHz)	826.4 (MHz)	836.6 (MHz)	846.6 (MHz)	826.4 (MHz)	836.6 (MHz)	846.6 (MHz)
RMC		23.07	23.03	22.98	17.51	17.32	17.71	16.86	16.91	16.43
HSDPA	Sub - Test 1	21.41	21.63	21.40	15.85	15.92	16.13	15.20	15.51	14.85
	Sub - Test 2	21.59	21.63	21.36	16.03	15.92	16.09	15.38	15.51	14.81
	Sub - Test 3	21.55	21.43	21.40	15.99	15.72	16.13	15.34	15.31	14.85
	Sub - Test 4	21.41	21.63	21.48	15.85	15.92	16.21	15.20	15.51	14.93
HSUPA	Sub - Test 1	20.53	20.55	20.46	14.97	14.84	15.19	14.32	14.43	13.91
	Sub - Test 2	20.47	20.55	20.58	14.91	14.84	15.31	14.26	14.43	14.03
	Sub - Test 3	21.73	21.67	21.60	16.17	15.96	16.33	15.52	15.55	15.05
	Sub - Test 4	19.67	19.49	19.48	14.11	13.78	14.21	13.46	13.37	12.93
	Sub - Test 5	20.97	20.89	20.96	15.41	15.18	15.69	14.76	14.77	14.41
DC-HSDPA	Sub - Test 1	21.67	21.59	21.58	16.11	15.88	16.31	15.46	15.47	15.03
	Sub - Test 2	21.63	21.49	21.40	16.07	15.78	16.13	15.42	15.37	14.85
	Sub - Test 3	21.53	21.53	21.36	15.97	15.82	16.09	15.32	15.41	14.81
	Sub - Test 4	21.61	21.69	21.60	16.05	15.98	16.33	15.40	15.57	15.05
HSPA+	16QAM	21.96	21.94	21.88	16.40	16.23	16.61	15.75	15.82	15.33



LTE Band 5				Maximum Output Power(dBm)			ERP (dBm) Main Antenna			ERP (dBm) Second antenna		
BW	Modulation	RB size	RB offset	Channel/Frequency(MHz)								
				20407 /824.7	20525 /836.5	20643 /848.3	20407 /824.7	20525 /836.5	20643 /848.3	20407 /824.7	20525 /836.5	20643 /848.3
1.4MHz	QPSK	1	0	23.99	23.92	24.02	16.73	18.21	18.75	17.98	17.80	17.47
		1	2	24.07	23.97	24.06	16.81	18.26	18.79	18.06	17.85	17.51
		1	5	23.96	23.91	24.07	16.70	18.20	18.80	17.95	17.79	17.52
		3	0	24.02	23.97	24.01	16.76	18.26	18.74	18.01	17.85	17.46
		3	2	24.07	24.02	24.06	16.81	18.31	18.79	18.06	17.90	17.51
		3	3	23.98	23.99	24.00	16.72	18.28	18.73	17.97	17.87	17.45
		6	0	23.13	23.14	23.27	15.87	17.43	18.00	17.12	17.02	16.72
	16QAM	1	0	23.06	23.06	22.80	15.80	17.35	17.53	17.05	16.94	16.25
		1	2	23.12	23.12	22.87	15.86	17.41	17.60	17.11	17.00	16.32
		1	5	23.06	23.09	22.82	15.80	17.38	17.55	17.05	16.97	16.27
		3	0	23.16	23.21	23.14	15.90	17.50	17.87	17.15	17.09	16.59
		3	2	23.15	23.24	23.20	15.89	17.53	17.93	17.14	17.12	16.65
		3	3	23.13	23.22	23.16	15.87	17.51	17.89	17.12	17.10	16.61
		6	0	22.27	22.25	22.35	15.01	16.54	17.08	16.26	16.13	15.80
	64QAM	1	0	22.36	22.30	22.34	15.10	16.59	17.07	16.35	16.18	15.79
		1	2	22.26	22.21	22.24	15.00	16.50	16.97	16.25	16.09	15.69
		1	5	22.36	22.34	22.35	15.10	16.63	17.08	16.35	16.22	15.80
		3	0	22.00	21.92	22.01	14.74	16.21	16.74	15.99	15.80	15.46
		3	2	22.11	22.03	22.08	14.85	16.32	16.81	16.10	15.91	15.53
		3	3	22.25	22.18	22.20	14.99	16.47	16.93	16.24	16.06	15.65
		6	0	21.07	21.01	21.06	13.81	15.30	15.79	15.06	14.89	14.51
BW	Modulation	RB size	RB offset	Channel/Frequency(MHz)								
				20415 /825.5	20525 /836.5	20635 /847.5	20415 /825.5	20525 /836.5	20635 /847.5	20415 /825.5	20525 /836.5	20635 /847.5
3MHz	QPSK	1	0	23.87	23.77	23.84	18.31	18.06	18.57	17.66	17.65	17.29
		1	7	23.87	23.87	23.97	18.31	18.16	18.70	17.66	17.75	17.42
		1	14	23.79	23.82	23.95	18.23	18.11	18.68	17.58	17.70	17.40
		8	0	23.09	23.05	23.09	17.53	17.34	17.82	16.88	16.93	16.54
		8	4	23.08	23.09	23.16	17.52	17.38	17.89	16.87	16.97	16.61
		8	7	23.02	23.06	23.10	17.46	17.35	17.83	16.81	16.94	16.55
		15	0	23.00	23.04	23.07	17.44	17.33	17.80	16.79	16.92	16.52
	16QAM	1	0	23.18	23.00	22.69	17.62	17.29	17.42	16.97	16.88	16.14



		1	7	23.22	23.00	22.77	17.66	17.29	17.50	17.01	16.88	16.22
		1	14	23.17	22.95	22.68	17.61	17.24	17.41	16.96	16.83	16.13
		8	0	21.99	22.02	21.96	16.43	16.31	16.69	15.78	15.90	15.41
		8	4	22.03	22.06	22.07	16.47	16.35	16.80	15.82	15.94	15.52
		8	7	21.99	21.97	22.01	16.43	16.26	16.74	15.78	15.85	15.46
		15	0	22.01	21.94	22.08	16.45	16.23	16.81	15.80	15.82	15.53
	64QAM	1	0	22.33	22.29	22.34	16.77	16.58	17.07	16.12	16.17	15.79
		1	7	22.27	22.20	22.24	16.71	16.49	16.97	16.06	16.08	15.69
		1	14	22.39	22.32	22.38	16.83	16.61	17.11	16.18	16.20	15.83
		8	0	21.11	21.08	21.15	15.55	15.37	15.88	14.90	14.96	14.60
		8	4	21.19	21.12	21.18	15.63	15.41	15.91	14.98	15.00	14.63
		8	7	21.33	21.26	21.30	15.77	15.55	16.03	15.12	15.14	14.75
		15	0	21.08	21.01	21.04	15.52	15.30	15.77	14.87	14.89	14.49
	BW	Modulation	RB size	RB offset	Channel/Frequency(MHz)							
20425 /826.5					20525 /836.5	20625 /846.5	20425 /826.5	20525 /836.5	20625 /846.5	20425 /826.5	20525 /836.5	20625 /846.5
5MHz	QPSK	1	0	24.08	24.04	24.03	18.52	18.33	18.76	17.87	17.92	17.48
		1	13	24.11	24.11	24.12	18.55	18.40	18.85	17.90	17.99	17.57
		1	24	24.07	24.08	24.10	18.51	18.37	18.83	17.86	17.96	17.55
		12	0	23.06	23.09	23.11	17.50	17.38	17.84	16.85	16.97	16.56
		12	6	23.11	23.19	23.12	17.55	17.48	17.85	16.90	17.07	16.57
		12	13	23.08	23.12	23.04	17.52	17.41	17.77	16.87	17.00	16.49
		25	0	23.06	23.09	23.09	17.50	17.38	17.82	16.85	16.97	16.54
	16QAM	1	0	23.52	23.35	23.26	17.96	17.64	17.99	17.31	17.23	16.71
		1	13	23.55	23.36	23.35	17.99	17.65	18.08	17.34	17.24	16.80
		1	24	23.56	23.29	23.31	18.00	17.58	18.04	17.35	17.17	16.76
		12	0	22.03	21.99	22.12	16.47	16.28	16.85	15.82	15.87	15.57
		12	6	22.08	22.07	22.14	16.52	16.36	16.87	15.87	15.95	15.59
		12	13	22.04	22.03	22.04	16.48	16.32	16.77	15.83	15.91	15.49
		25	0	22.03	22.12	22.03	16.47	16.41	16.76	15.82	16.00	15.48
	64QAM	1	0	22.36	22.32	22.34	16.80	16.61	17.07	16.15	16.20	15.79
		1	13	22.26	22.23	22.23	16.70	16.52	16.96	16.05	16.11	15.68
		1	24	22.39	22.31	22.34	16.83	16.60	17.07	16.18	16.19	15.79
		12	0	21.09	21.01	21.14	15.53	15.30	15.87	14.88	14.89	14.59
		12	6	21.19	21.11	21.16	15.63	15.40	15.89	14.98	14.99	14.61
		12	13	21.32	21.25	21.29	15.76	15.54	16.02	15.11	15.13	14.74
		25	0	21.08	21.01	21.04	15.52	15.30	15.77	14.87	14.89	14.49



BW	Modulation	RB size	RB offset	Channel/Frequency(MHz)								
				20450 /829	20525 /836.5	20600 /844	20450 /829	20525 /836.5	20600 /844	20450 /829	20525 /836.5	20600 /844
10MHz	QPSK	1	0	24.16	24.12	24.15	18.60	18.41	18.44	17.95	18.00	18.03
		1	25	24.22	24.15	24.19	18.66	18.44	18.48	18.01	18.03	18.07
		1	49	24.12	24.15	24.20	18.56	18.44	18.49	17.91	18.03	18.08
		25	0	23.05	23.06	23.10	17.49	17.35	17.39	16.84	16.94	16.98
		25	13	23.16	23.18	23.15	17.60	17.47	17.44	16.95	17.06	17.03
		25	25	23.07	23.16	23.02	17.51	17.45	17.31	16.86	17.04	16.90
		50	0	23.11	23.12	23.08	17.55	17.41	17.37	16.90	17.00	16.96
	16QAM	1	0	22.97	23.47	23.27	17.41	17.76	17.56	16.76	17.35	17.15
		1	25	23.02	23.49	23.27	17.46	17.78	17.56	16.81	17.37	17.15
		1	49	22.98	23.49	23.30	17.42	17.78	17.59	16.77	17.37	17.18
		25	0	22.07	22.13	22.05	16.51	16.42	16.34	15.86	16.01	15.93
		25	13	22.16	22.18	22.17	16.60	16.47	16.46	15.95	16.06	16.05
		25	25	22.06	22.18	22.04	16.50	16.47	16.33	15.85	16.06	15.92
		50	0	22.09	22.10	22.08	16.53	16.39	16.37	15.88	15.98	15.96
	64QAM	1	0	22.31	22.25	22.29	16.75	16.54	16.58	16.10	16.13	16.17
		1	25	22.23	22.18	22.20	16.67	16.47	16.49	16.02	16.06	16.08
		1	49	22.33	22.26	22.32	16.77	16.55	16.61	16.12	16.14	16.20
		25	0	21.06	21.00	21.08	15.50	15.29	15.37	14.85	14.88	14.96
		25	13	21.15	21.08	21.12	15.59	15.37	15.41	14.94	14.96	15.00
		25	25	21.30	21.21	21.26	15.74	15.50	15.55	15.09	15.09	15.14
		50	0	21.06	20.97	21.01	15.50	15.26	15.30	14.85	14.85	14.89

5.2. Occupied Bandwidth

Ambient condition

Temperature	Relative humidity	Pressure
23°C ~25°C	45%~50%	101.5kPa

Method of Measurement

The EUT was connected to Spectrum Analyzer and Base Station Simulator via power Splitter. The occupied bandwidth is measured using spectrum analyzer.

RBW is set to 6.2kHz, VBW is set to 20kHz for GSM 850,

RBW is set to 51kHz, VBW is set to 160kHz for WCDMA Band V,

RBW is set to 30 kHz, VBW is set to 91kHz for LTE Band 5 (1.4MHz),

RBW is set to 62 kHz, VBW is set to 180kHz for LTE Band 5 (3MHz),

RBW is set to 100 kHz, VBW is set to 300kHz for LTE Band 5 (5MHz),

RBW is set to 200 kHz, VBW is set to 620kHz for LTE Band 5 (10MHz),

99% power and -26dBc occupied bandwidths are recorded. Spectrum analyzer plots are included on the following pages.

Test Setup

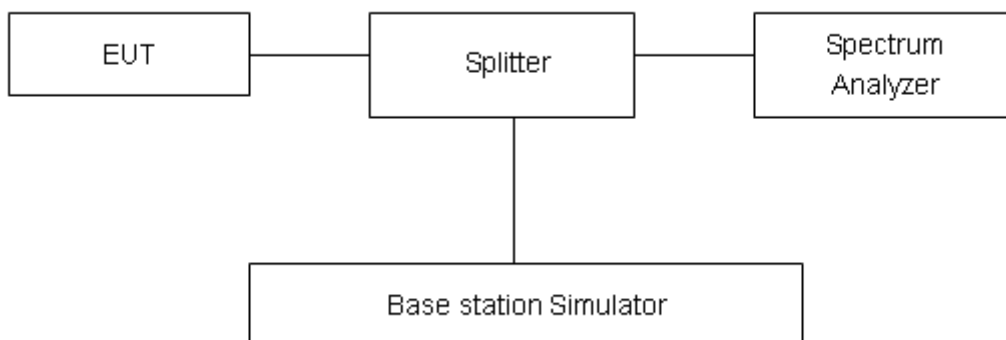

Limits

No specific occupied bandwidth requirements in part 2.1049.

Measurement Uncertainty

The assessed measurement uncertainty to ensure 95% confidence level for the normal distribution is with the coverage factor $k = 2$, $U = 624\text{Hz}$.

Test Result

Mode	Channel	Frequency (MHz)	99% Power Bandwidth (MHz)	-26dBc Bandwidth(MHz)
GSM 850 (GMSK)	128	824.2	0.2472	0.3096
	190	836.6	0.2417	0.3068
	251	848.8	0.2476	0.3208
GPRS 850 (GMSK)	128	824.2	0.2469	0.3098
	190	836.6	0.2394	0.3014
	251	848.8	0.2519	0.3126
EGPRS 850 (8PSK)	128	824.2	0.2442	0.3006
	190	836.6	0.2419	0.2931
	251	848.8	0.2397	0.3056
WCDMA Band V (RMC)	4132	826.4	4.1488	4.6850
	4183	836.6	4.1529	4.6970
	4233	846.6	4.1696	4.6900



LTE Band 5						
RB	Modulation	Bandwidth (MHz)	Channel	Frequency (MHz)	99% Power Bandwidth(MHz)	-26dBc Bandwidth(MHz)
100%	QPSK	1.4	20407	824.7	1.0952	1.265
			20525	836.5	1.0911	1.255
			20643	848.3	1.0916	1.288
		3	20415	825.5	2.6927	2.972
			20525	836.5	2.6982	2.952
			20635	847.5	2.6968	2.957
		5	20425	826.5	4.5095	4.939
			20525	836.5	4.5015	4.906
			20625	846.5	4.4991	4.887
		10	20450	829	8.9494	9.634
			20525	836.5	8.9875	9.623
			20600	844	8.9632	9.752
	16QAM	1.4	20407	824.7	1.0999	1.269
			20525	836.5	1.0985	1.282
			20643	848.3	1.0926	1.259
		3	20415	825.5	2.6937	2.973
			20525	836.5	2.6932	2.986
			20635	847.5	2.6891	3.004
		5	20425	826.5	4.5030	4.906
			20525	836.5	4.5178	4.875
			20625	846.5	4.5140	4.946
		10	20450	829	8.9459	9.702
			20525	836.5	8.9911	9.689
			20600	844	8.9718	9.751
	64QAM	1.4	20407	824.7	1.0960	1.273
			20525	836.5	1.1002	1.286
			20643	848.3	1.0910	1.274
		3	20415	825.5	2.6955	2.979
			20525	836.5	2.6830	2.988
			20635	847.5	2.6750	2.945
5		20425	826.5	4.5088	4.895	
		20525	836.5	4.4982	4.898	
		20625	846.5	4.5076	4.931	
10		20450	829	8.9945	9.536	
		20525	836.5	8.9749	9.717	
		20600	844	8.9835	9.663	

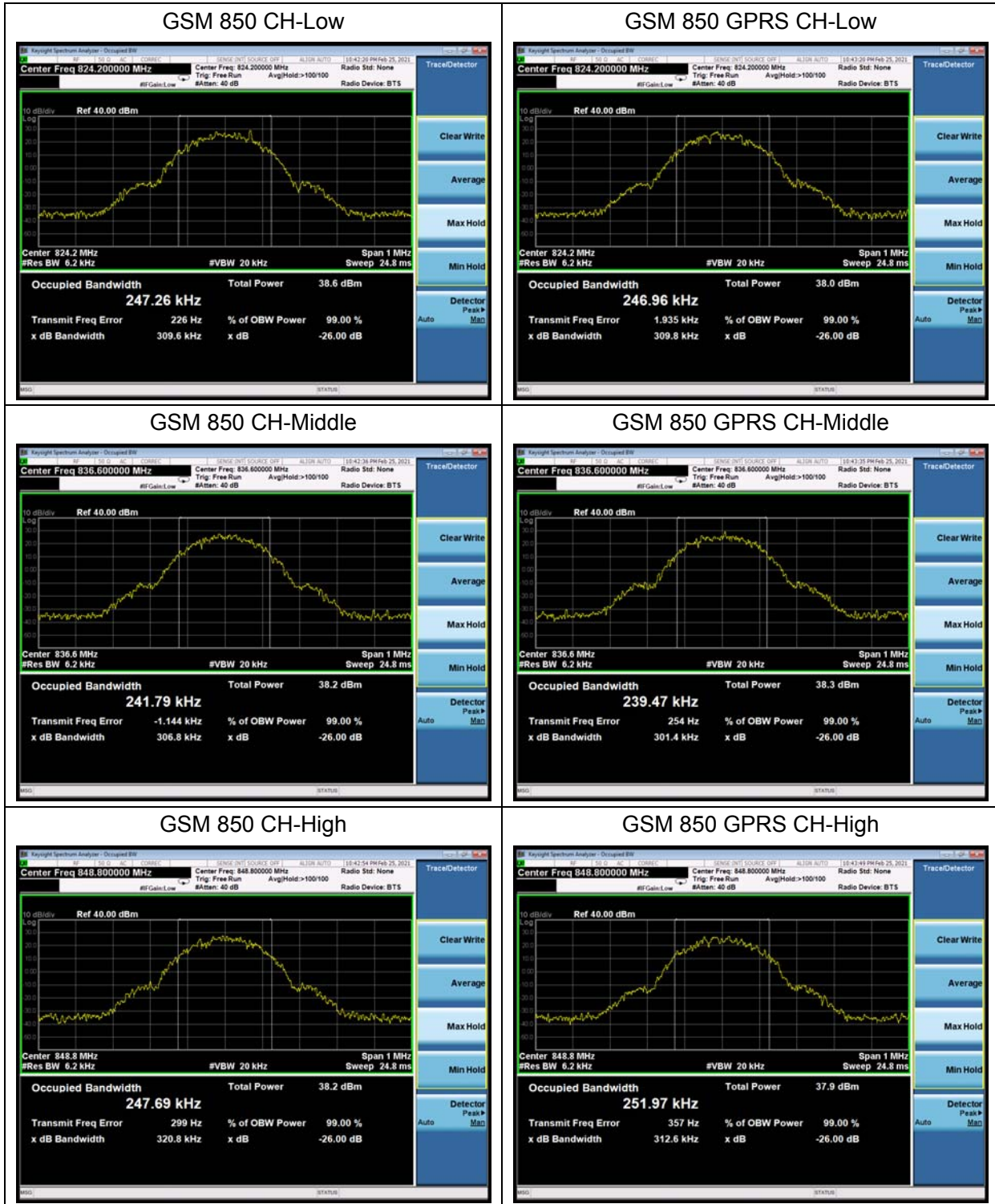

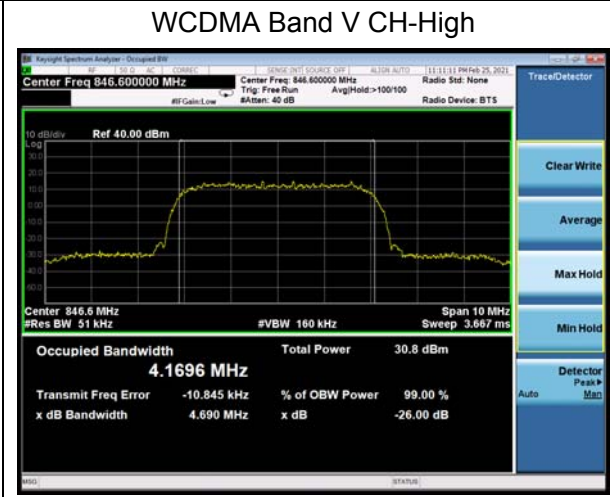
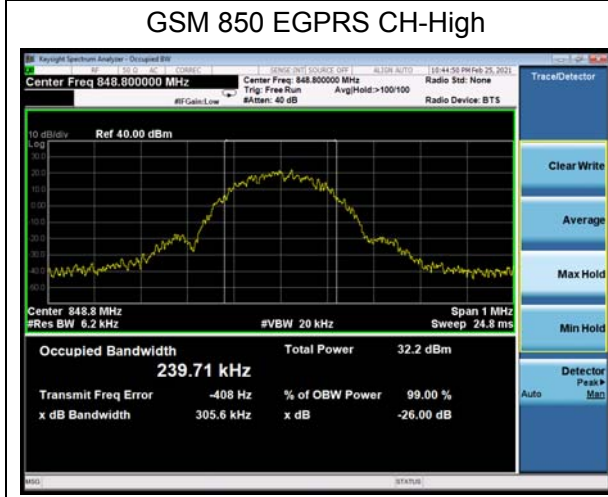
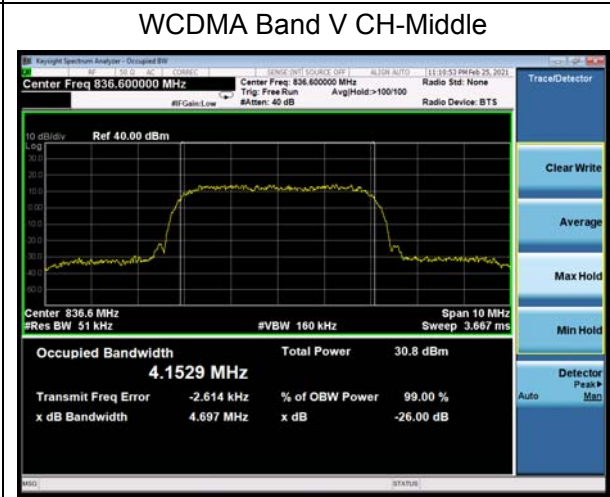
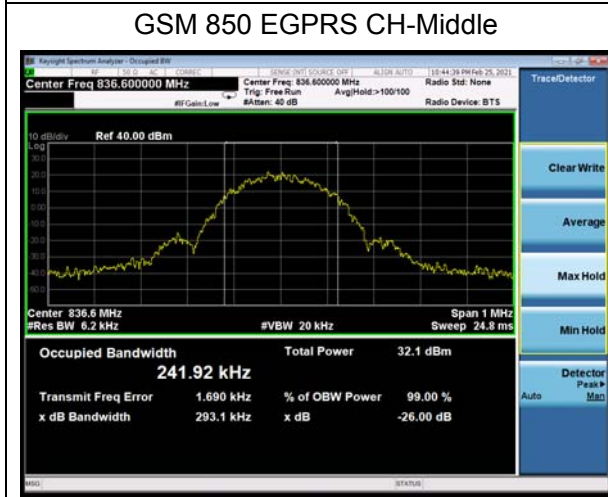
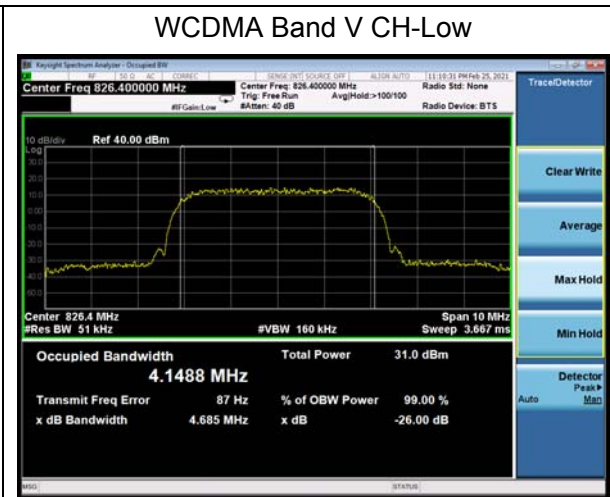
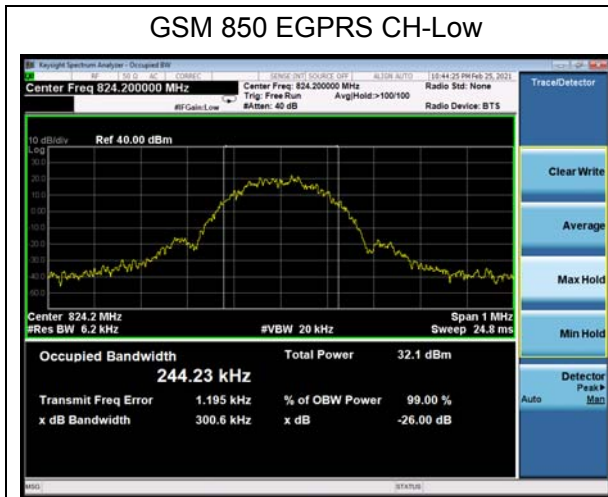



LTE Band 5 QPSK 1.4MHz CH-Low



LTE Band 5 QPSK 3MHz CH-Low



LTE Band 5 QPSK 1.4MHz CH-Middle



LTE Band 5 QPSK 3MHz CH-Middle



LTE Band 5 QPSK 1.4MHz CH-High

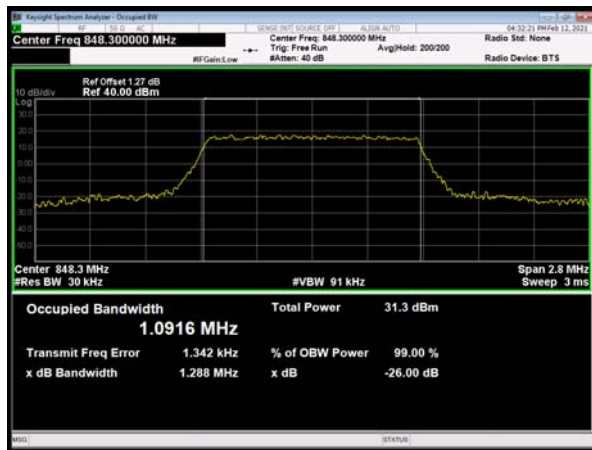

LTE Band 5 QPSK 3MHz CH-High



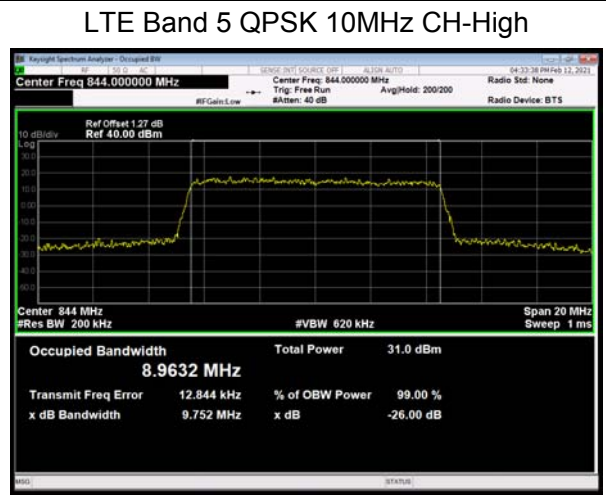
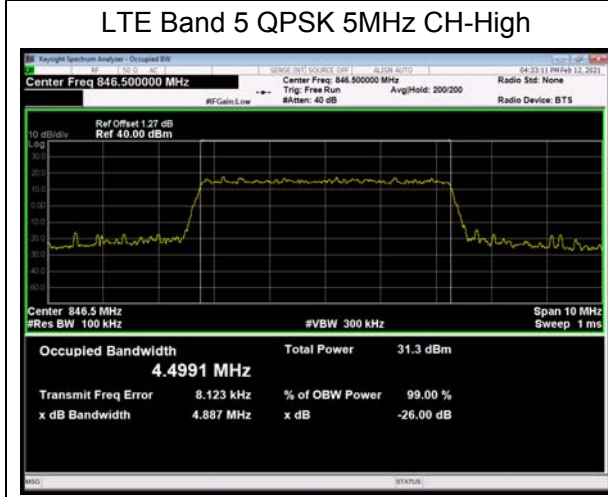
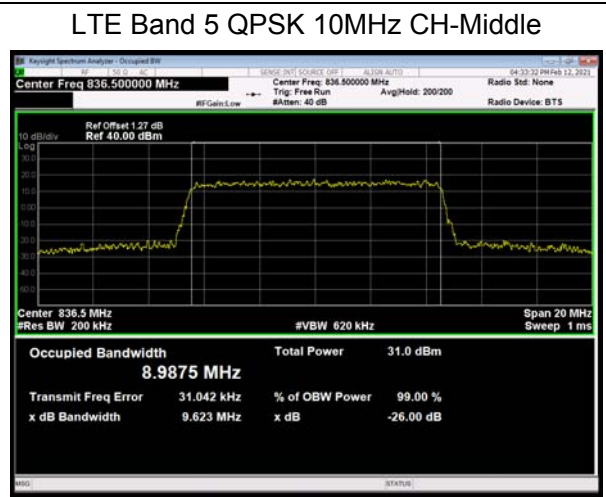
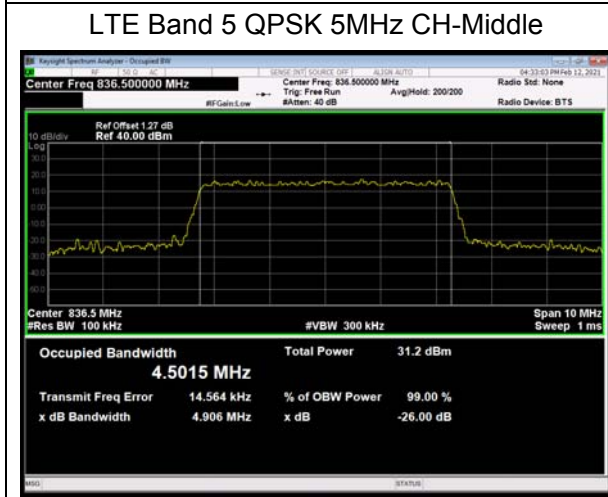
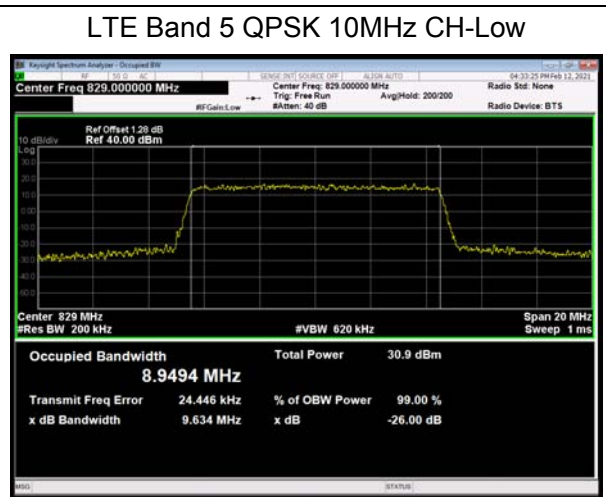
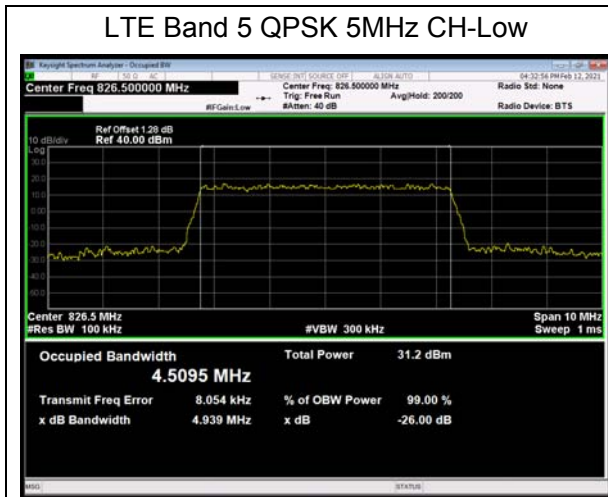

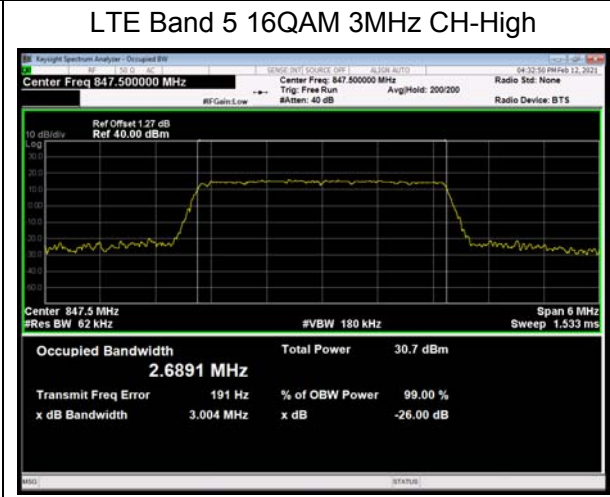
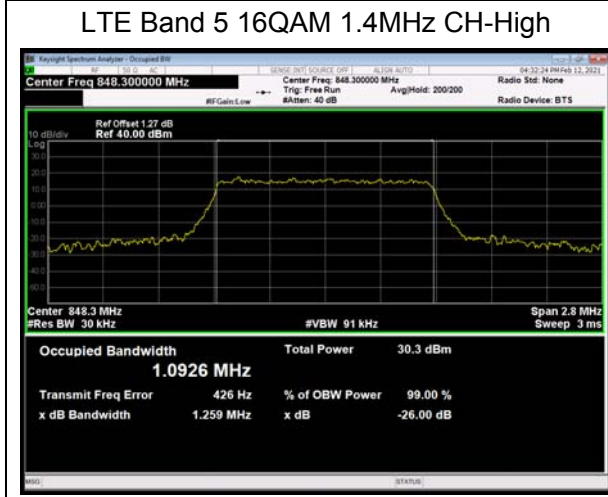
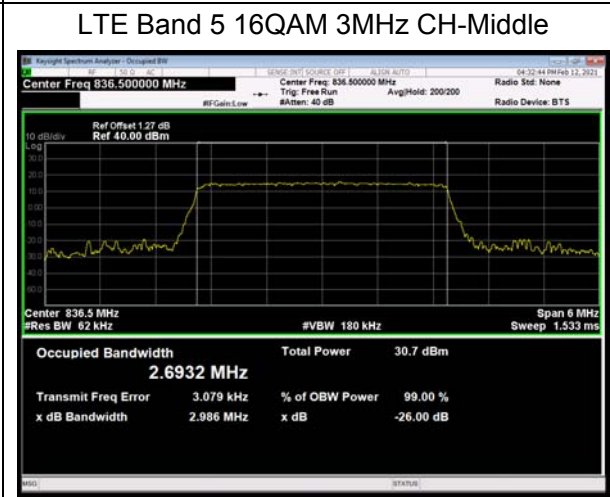
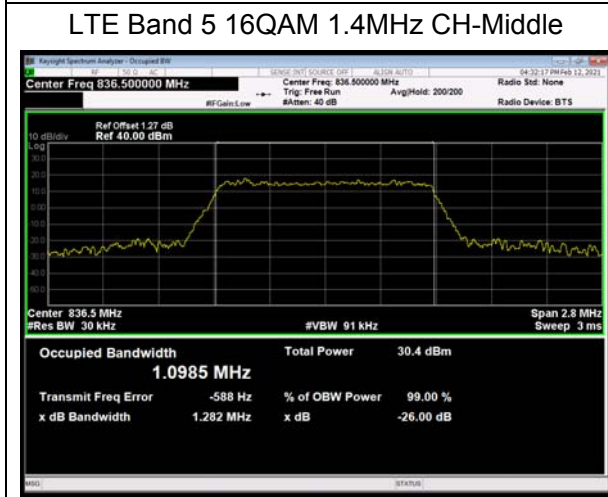
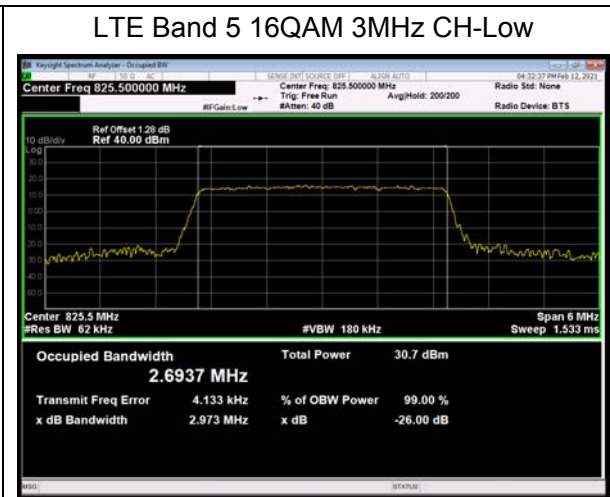
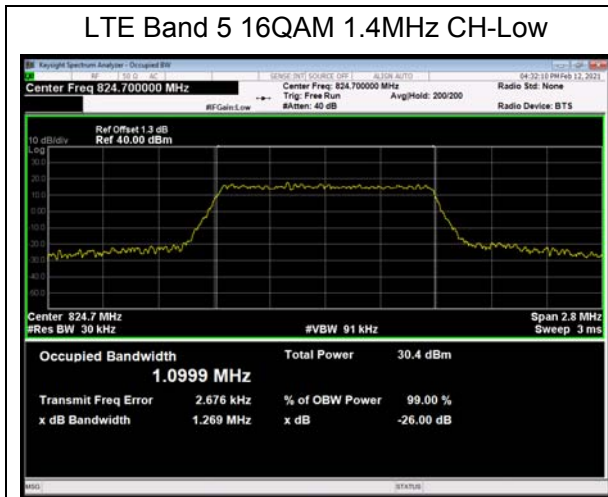

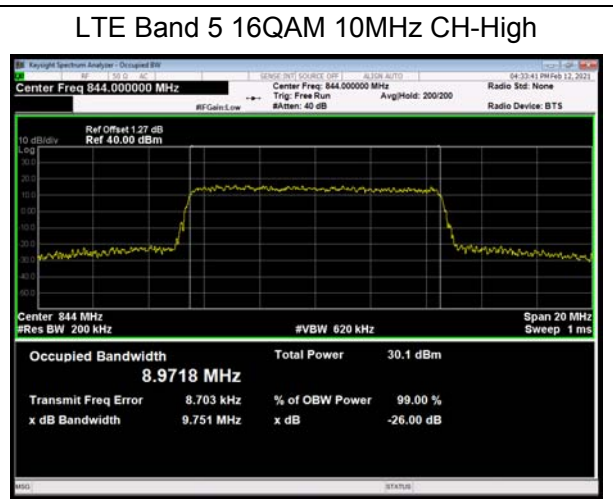
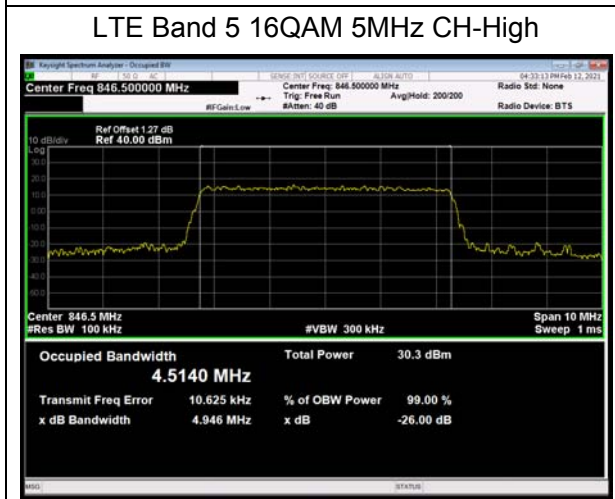
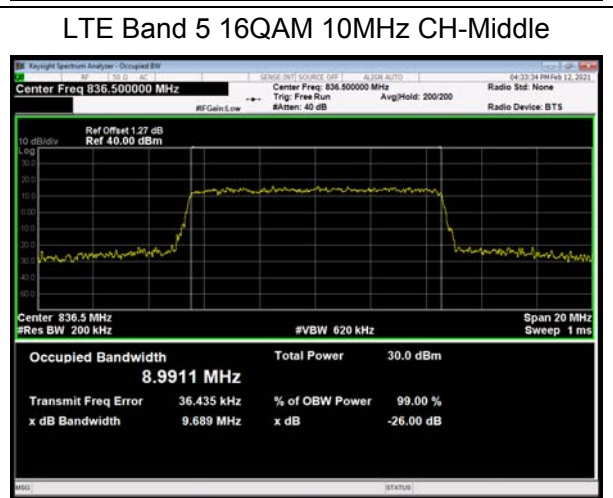
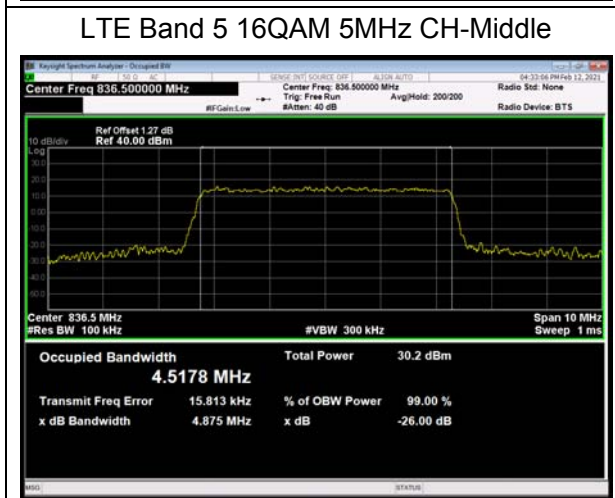
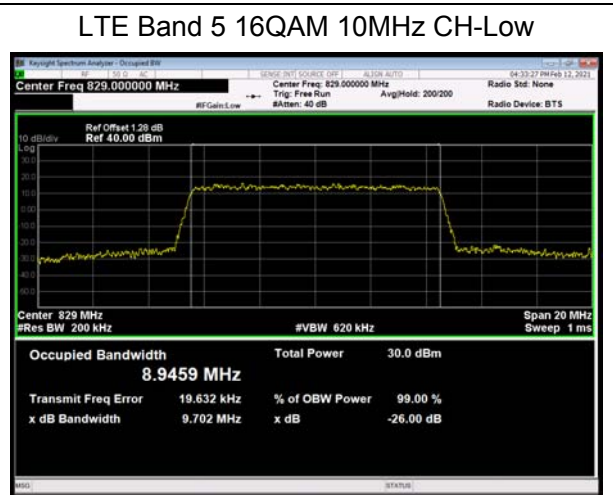
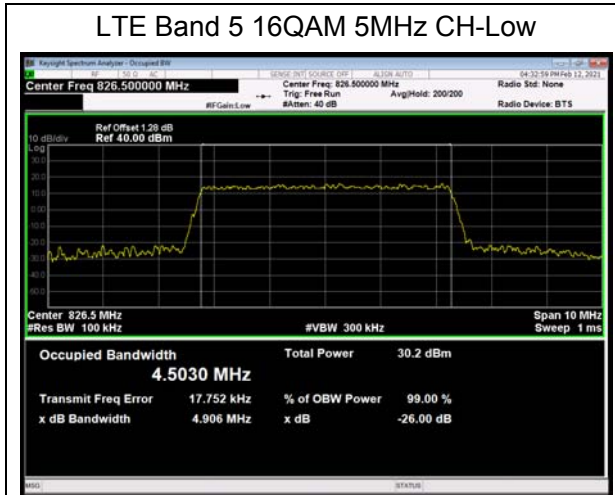

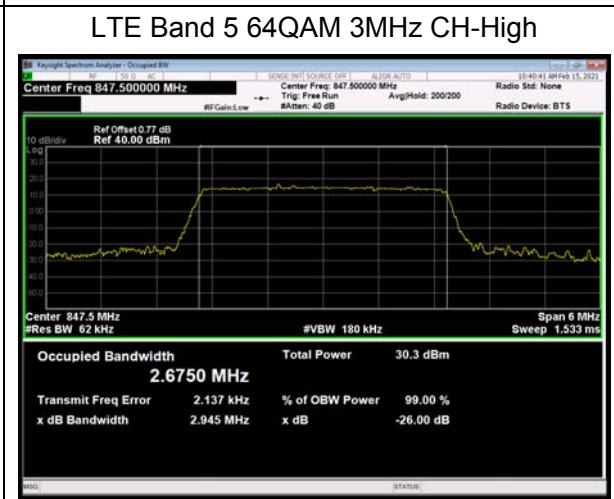
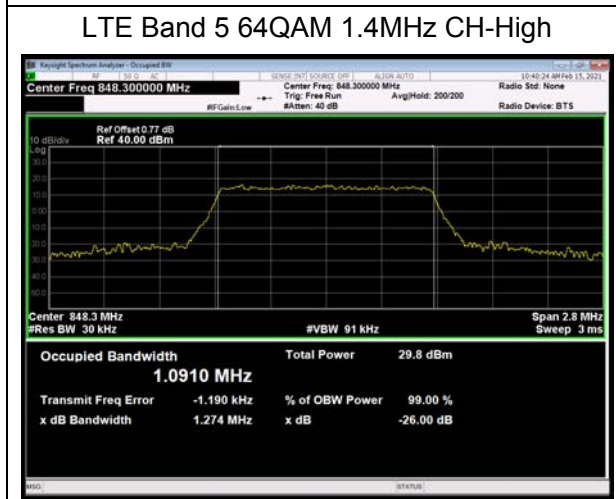
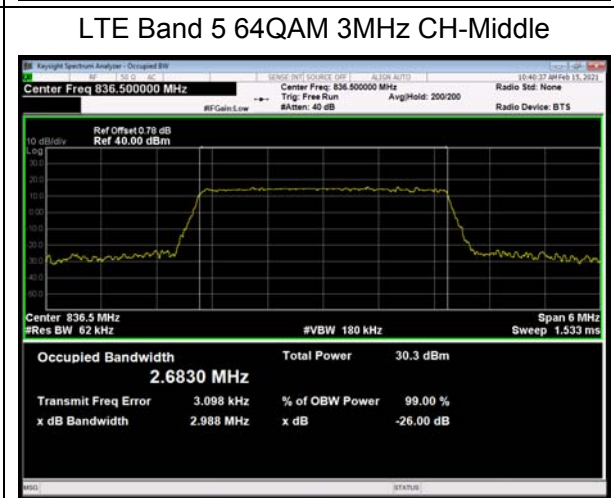
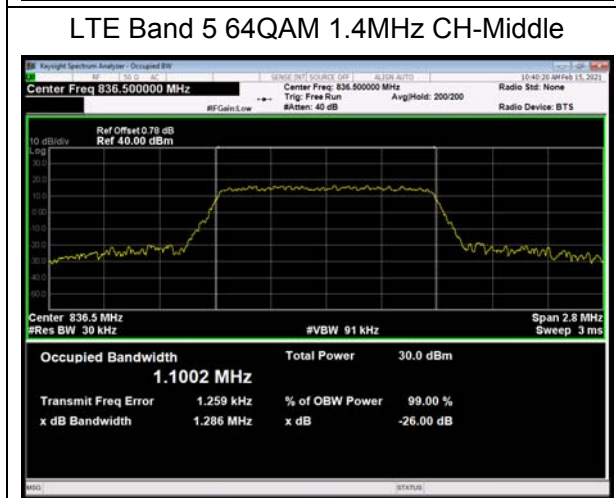
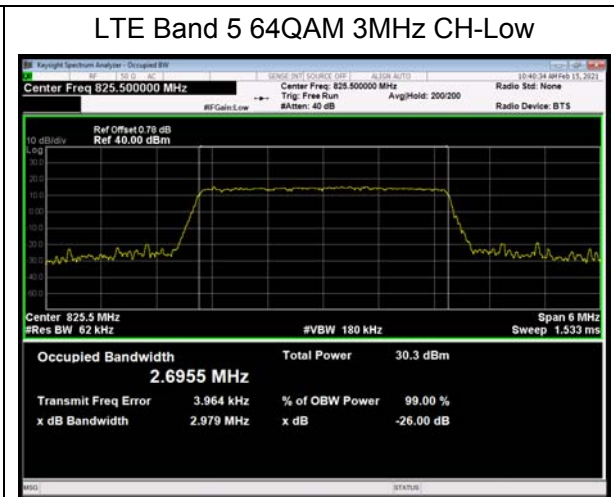
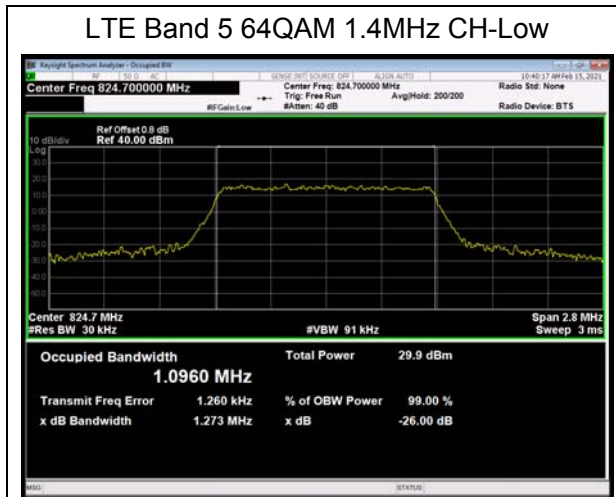

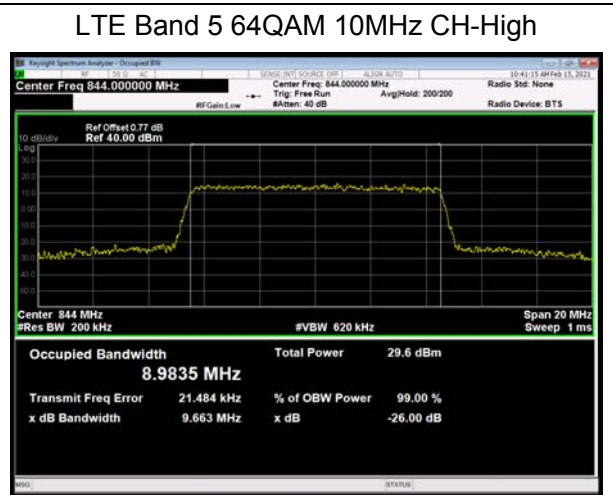
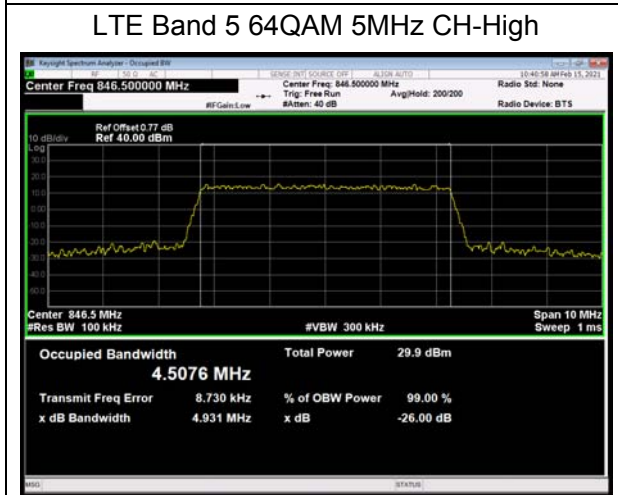
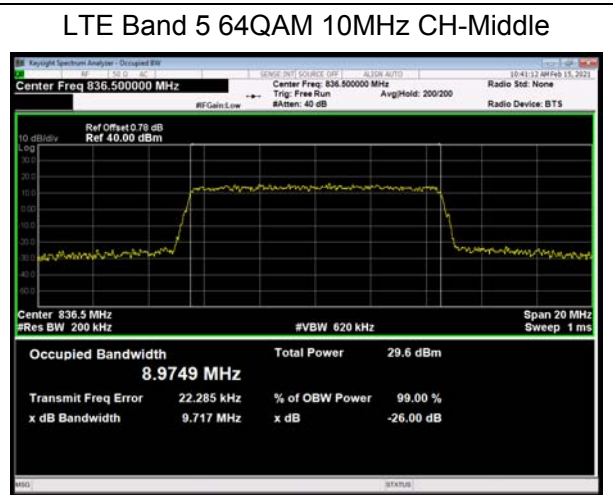
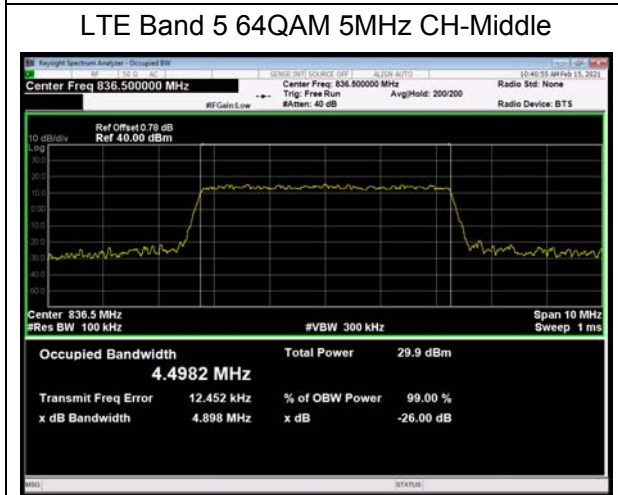
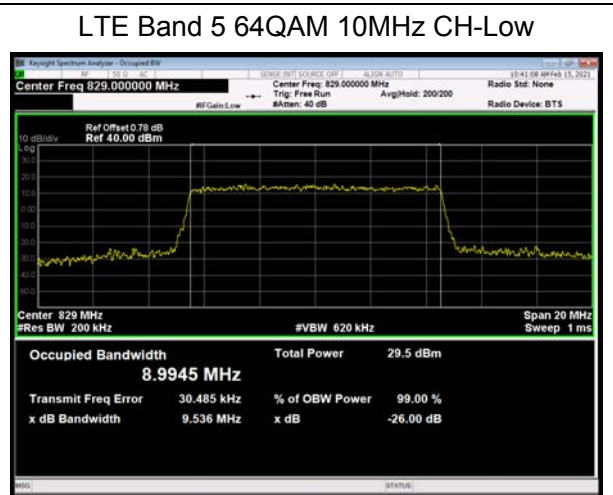
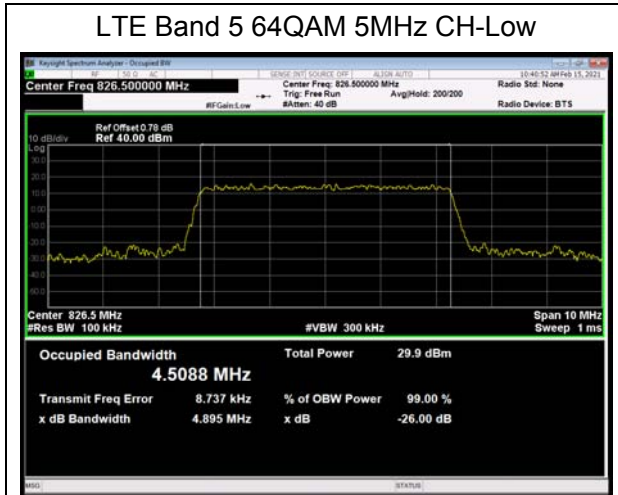

5.3. Band Edge Compliance

Ambient condition

Temperature	Relative humidity	Pressure
23°C ~25°C	45%~50%	101.5kPa

Method of Measurement

The EUT was connected to Spectrum Analyzer and Base Station Simulator via power Splitter. The band edge of the lowest and highest channels were measured. The average detector is used.

RBW is set to 6.2kHz,VBW is set to 20kHz for GSM 850,

RBW is set to 51kHz,VBW is set to 160kHz for WCDMA Band V,

RBW is set to 15kHz, VBW is set to 43kHz for LTE Band 5 (1.4MHz),

RBW is set to 30kHz,VBW is set to 91kHz for LTE Band 5 (3MHz),

RBW is set to 51kHz,VBW is set to 150kHz for LTE Band 5 (5MHz),

RBW is set to 100kHz,VBW is set to 300kHz for LTE Band 56(10MHz),

Spectrum analyzer plots are included on the following pages.

Test Setup

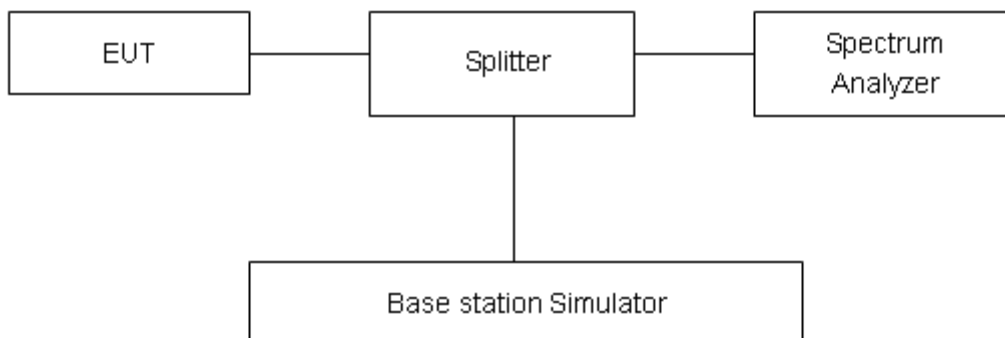

Limits

Rule Part 22.917(a) specifies that “The power of any emission outside of the authorized operating frequency ranges must be attenuated below the transmitting power (P) by a factor of at least 43 + 10 log(P) dB.”

Limit	-13 dBm
-------	---------

Measurement Uncertainty

The assessed measurement uncertainty to ensure 95% confidence level for the normal distribution is with the coverage factor $k = 1.96$, $U=0.684$ dB.

Test Result:

GSM 850 CH-Low

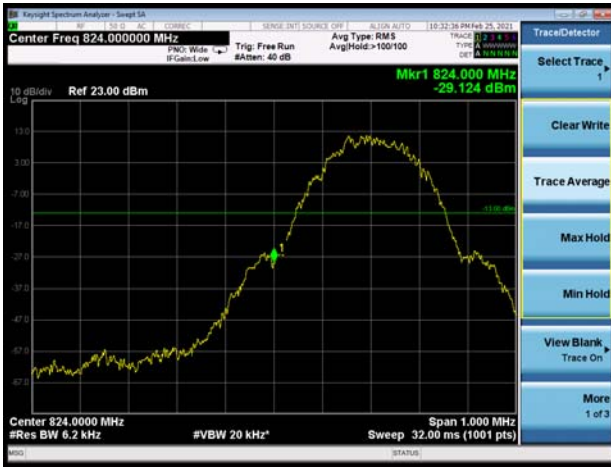

GSM 850 CH-High

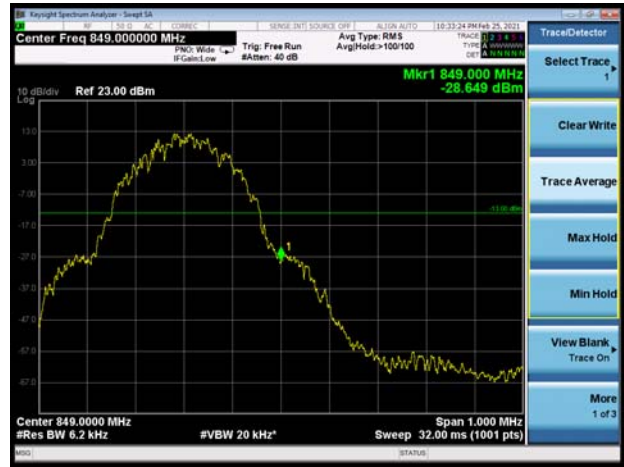

GSM 850 GPRS CH-Low

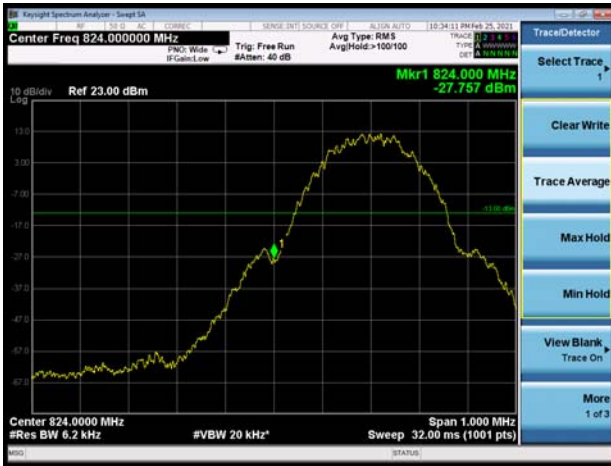

GSM 850 GPRS CH-High



GSM 850 EGPRS CH-Low

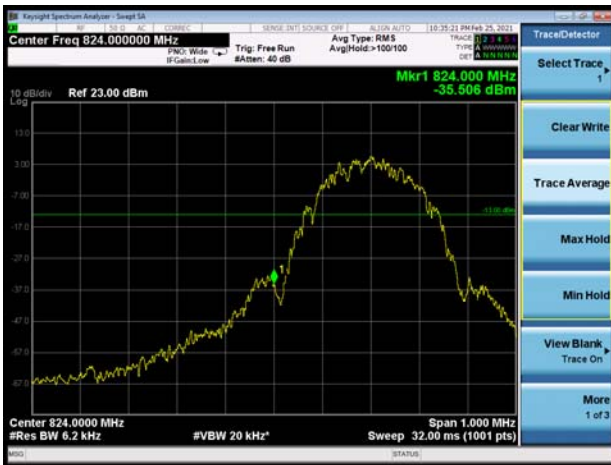

GSM 850 EGPRS CH-High

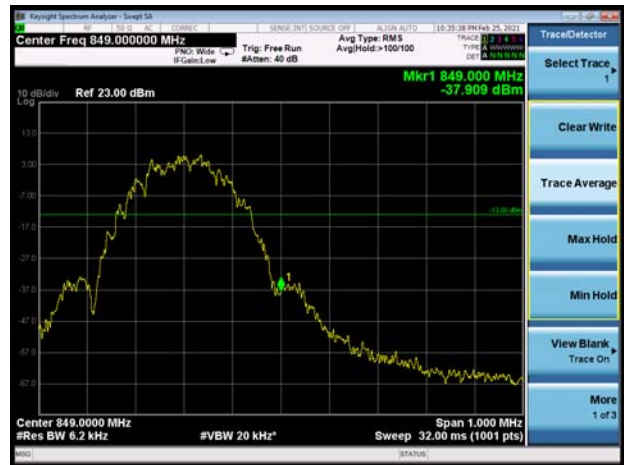



WCDMA Band V CH-Low



WCDMA Band V CH-High



LTE Band 5 QPSK 1.4MHz CH-Low 1RB

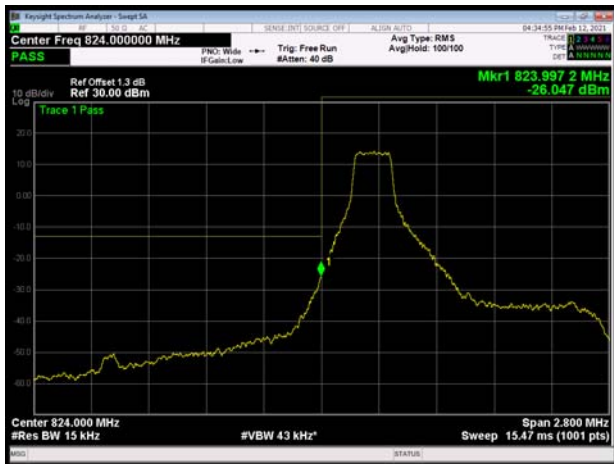

LTE Band 5 QPSK 1.4MHz CH-High 1RB

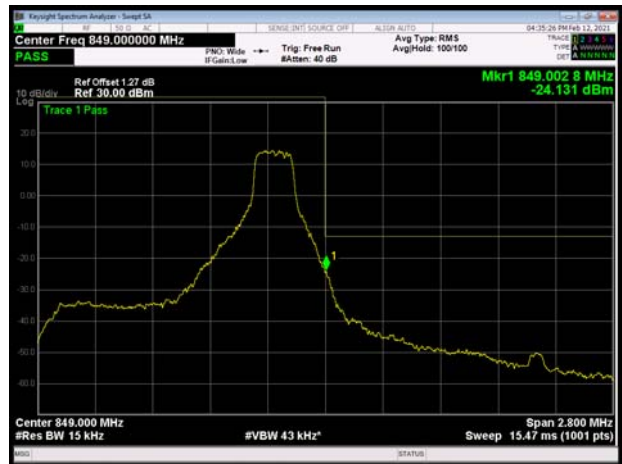

LTE Band 5 QPSK 1.4MHz CH-Low 100%RB

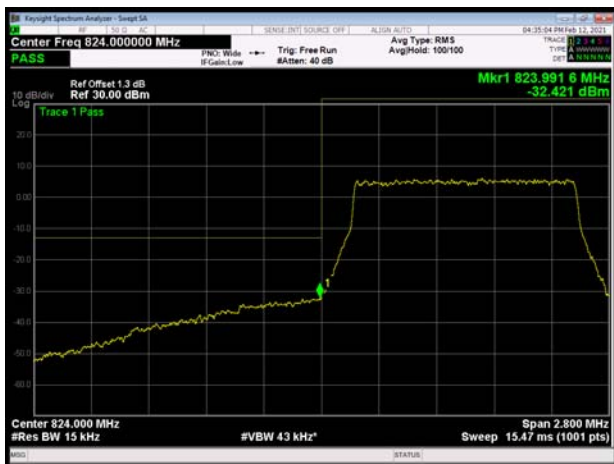

LTE Band 5 QPSK 1.4MHz CH-High 100%RB



LTE Band 5 QPSK 3MHz CH-Low 1RB

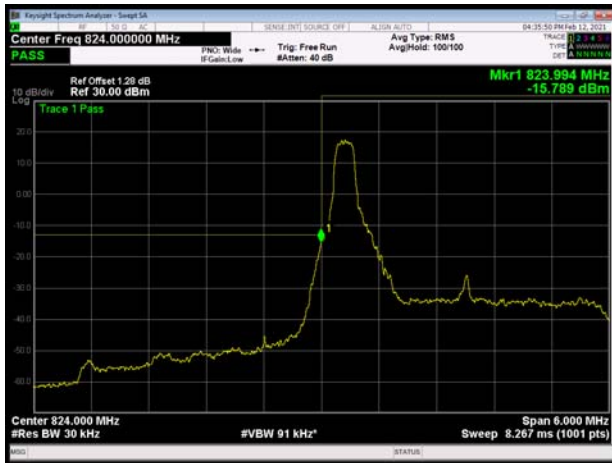

LTE Band 5 QPSK 3MHz CH-High 1RB

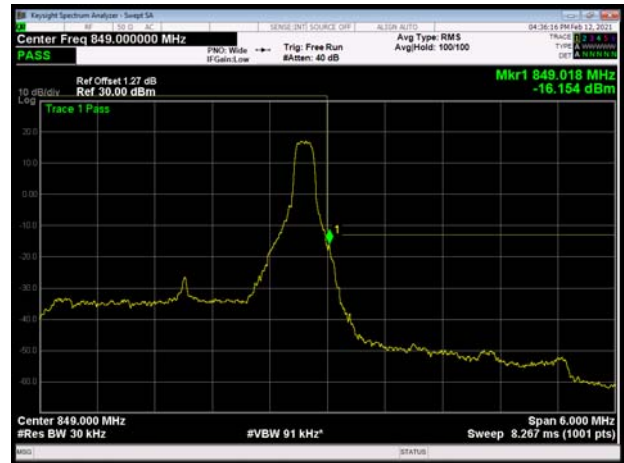

LTE Band 5 QPSK 3MHz CH-Low 100%RB

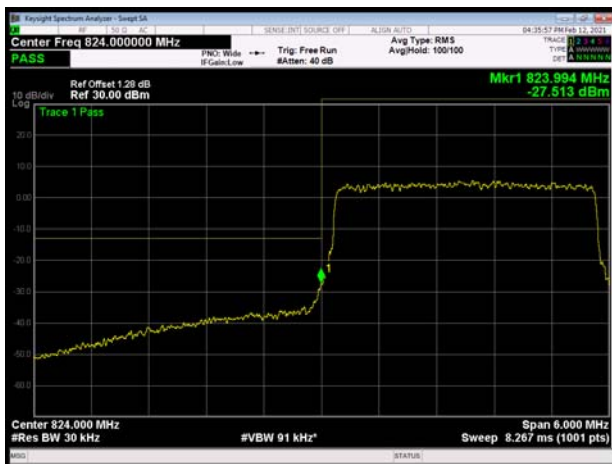

LTE Band 5 QPSK 3MHz CH-High 100%RB



LTE Band 5 QPSK 5MHz CH-Low 1RB

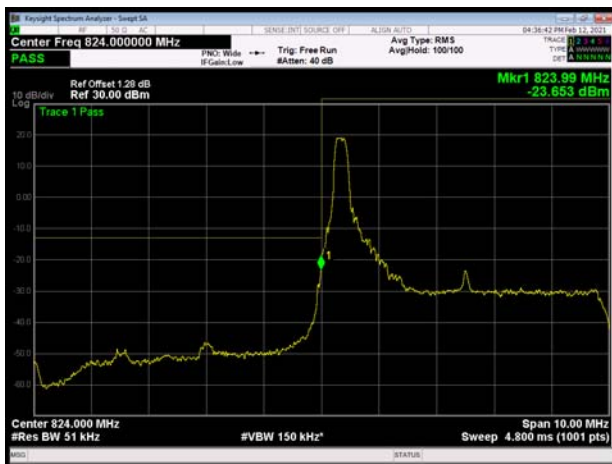

LTE Band 5 QPSK 5MHz CH-High 1RB

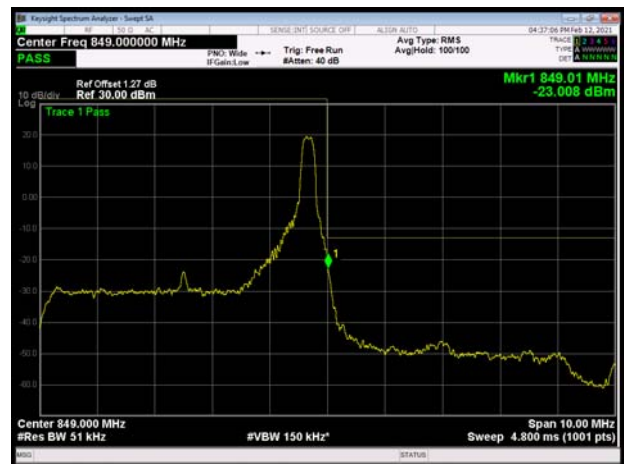



LTE Band 5 QPSK 5MHz CH-Low 100%RB

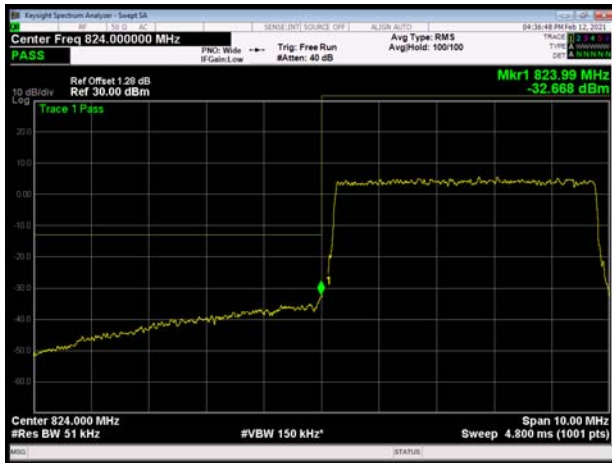

LTE Band 5 QPSK 5MHz CH-High 100%RB



LTE Band 5 QPSK 10MHz CH-Low 1RB

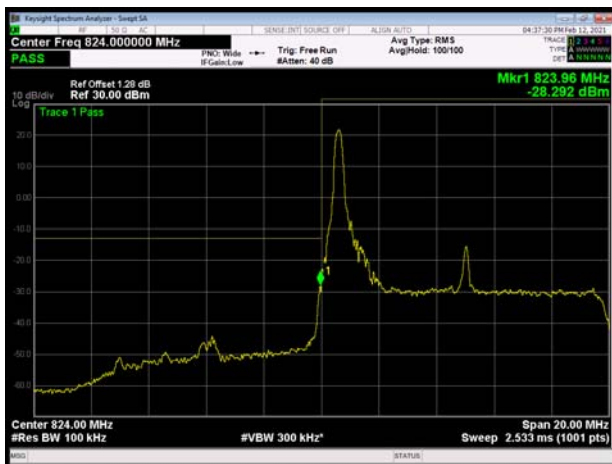

LTE Band 5 QPSK 10MHz CH-High 1RB

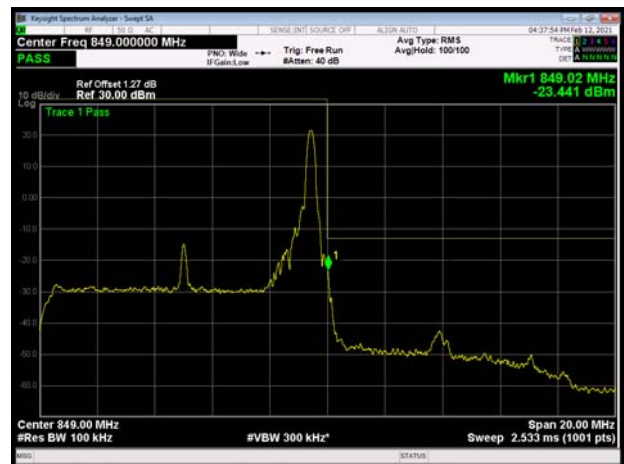

LTE Band 5 QPSK 10MHz CH-Low 100%RB

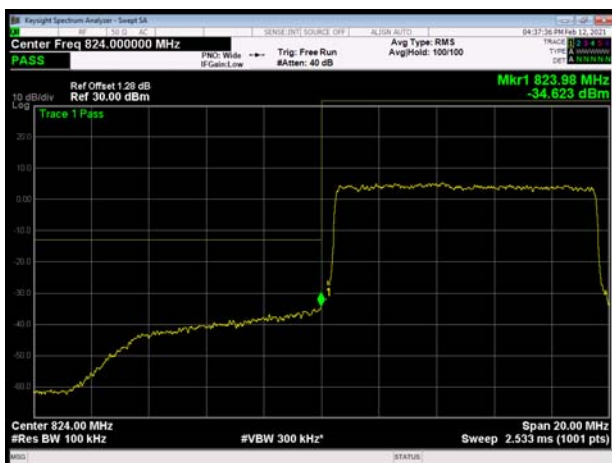

LTE Band 5 QPSK 10MHz CH-High 100%RB

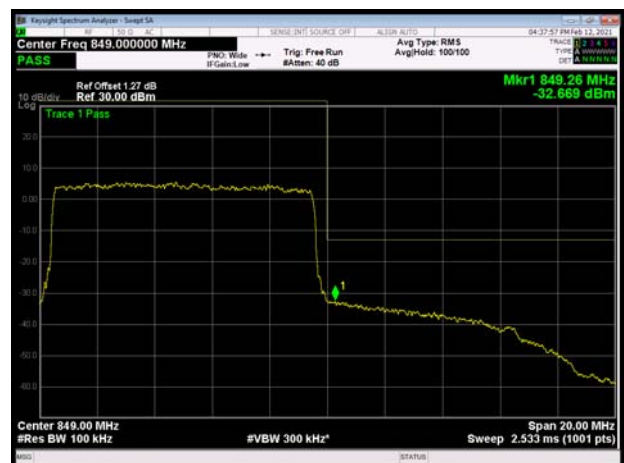



LTE Band 5 16QAM 1.4MHz CH-Low 1RB

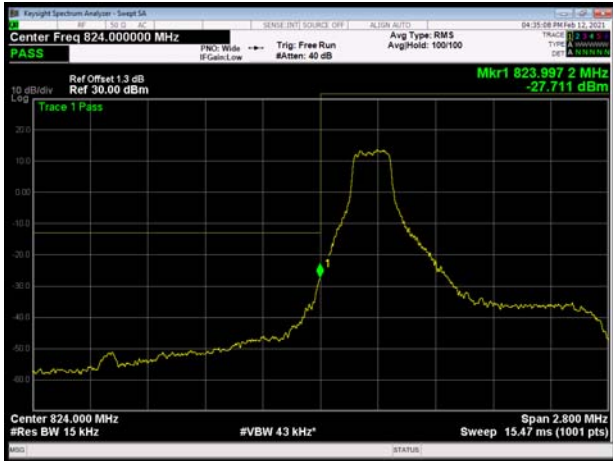

LTE Band 5 16QAM 1.4MHz CH-High 1RB

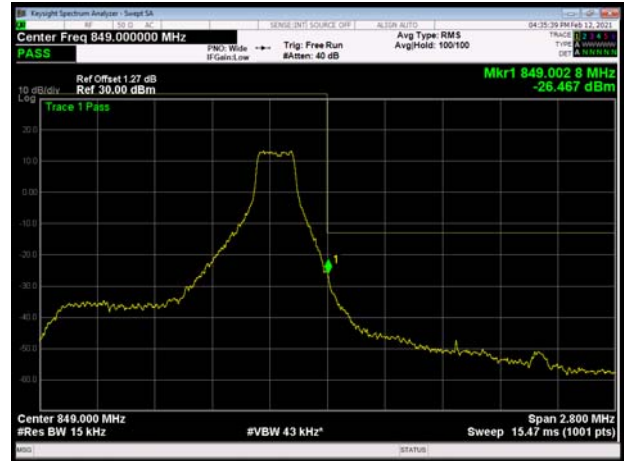

LTE Band 5 16QAM 1.4MHz CH-Low 100%RB



LTE Band 5 16QAM 1.4MHz CH-High 100%RB

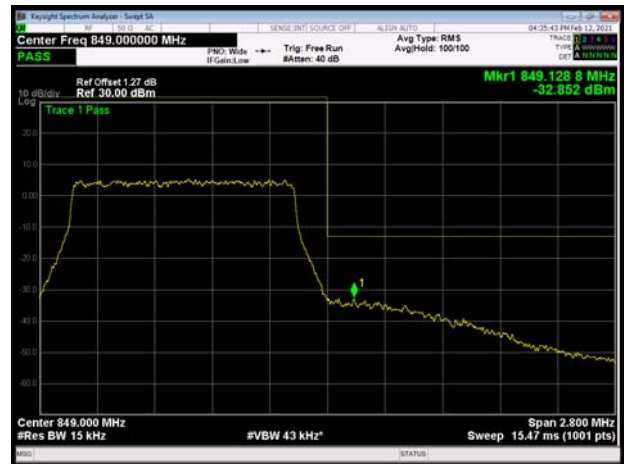

LTE Band 5 16QAM 3MHz CH-Low 1RB

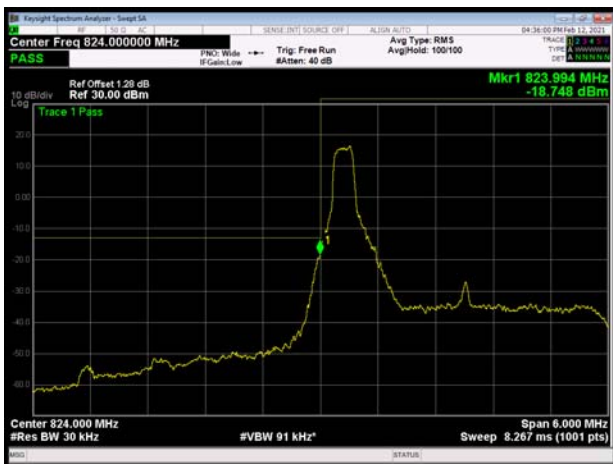

LTE Band 5 16QAM 3MHz CH-High 1RB

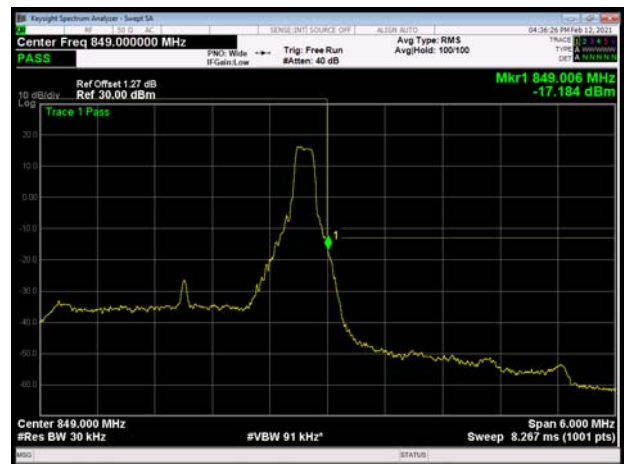



LTE Band 5 16QAM 3MHz CH-Low 100%RB

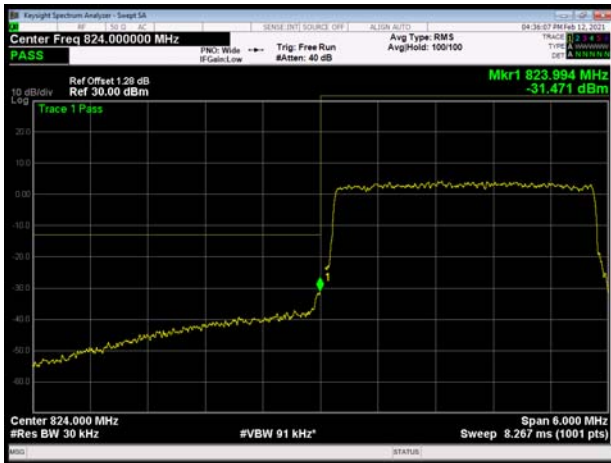

LTE Band 5 16QAM 3MHz CH-High 100%RB



LTE Band 5 16QAM 5MHz CH-Low 1RB

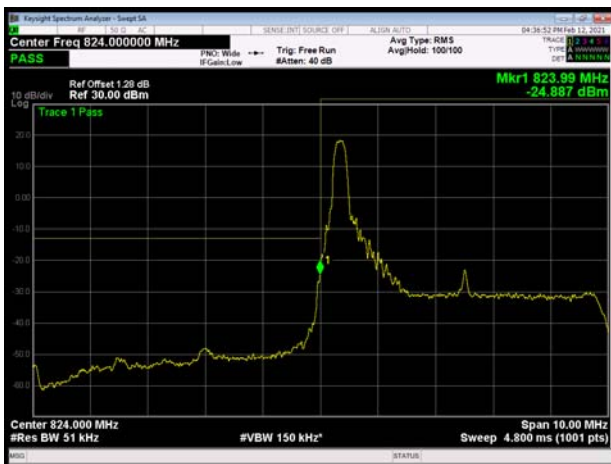

LTE Band 5 16QAM 5MHz CH-High 1RB

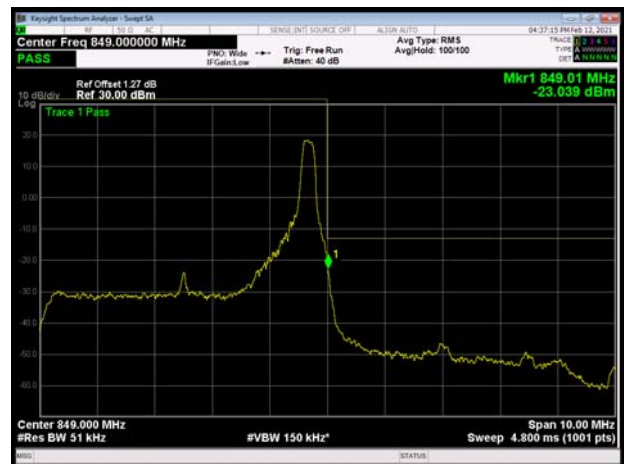

LTE Band 5 16QAM 5MHz CH-Low 100%RB

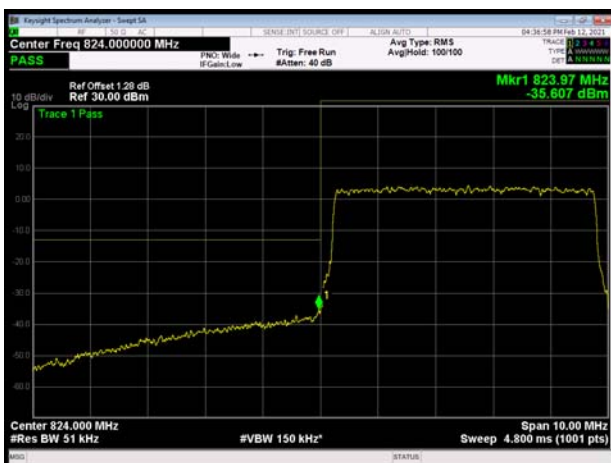

LTE Band 5 16QAM 5MHz CH-High 100%RB

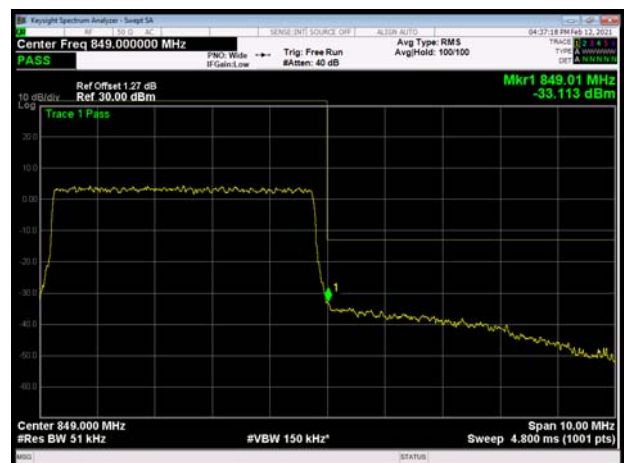



LTE Band 5 16QAM 10MHz CH-Low 1RB

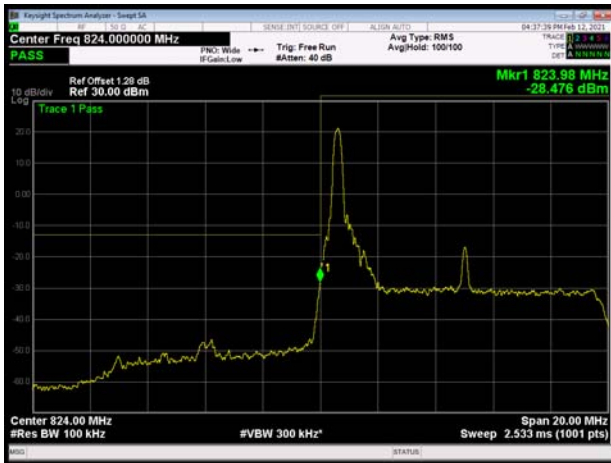

LTE Band 5 16QAM 10MHz CH-High 1RB

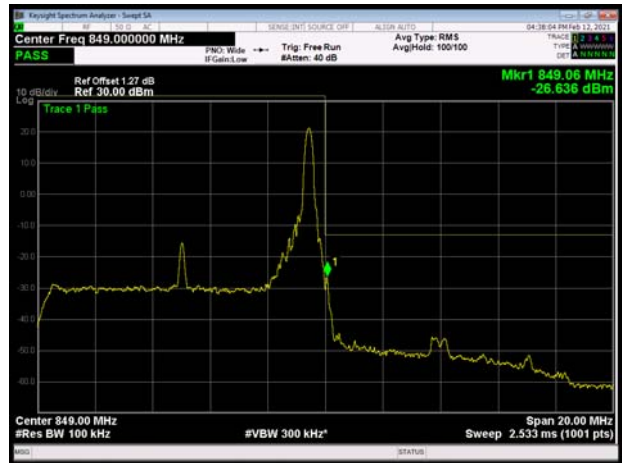

LTE Band 5 16QAM 10MHz CH-Low 100%RB

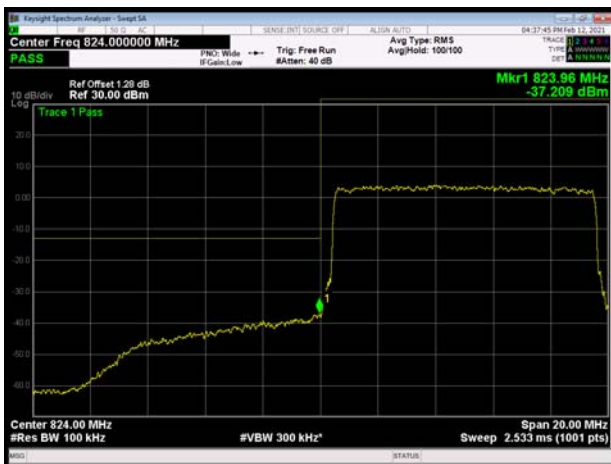

LTE Band 5 16QAM 10MHz CH-High 100%RB

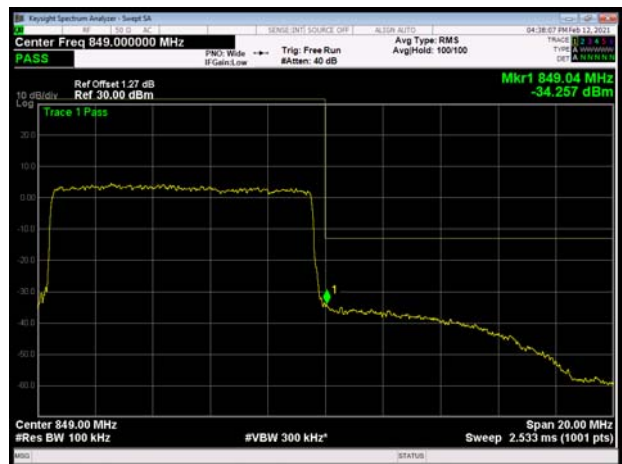



LTE Band 5 16QAM 1.4MHz CH-Low 1RB

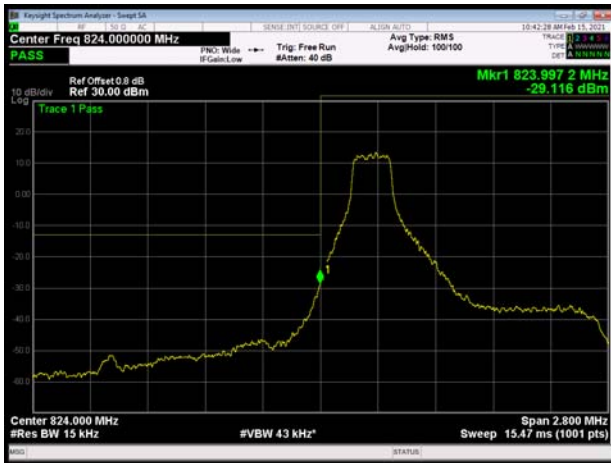

LTE Band 5 16QAM 1.4MHz CH-High 1RB

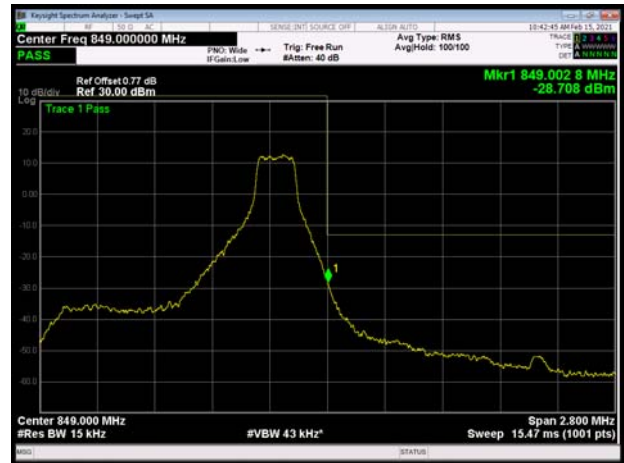

LTE Band 5 16QAM 1.4MHz CH-Low 100%RB

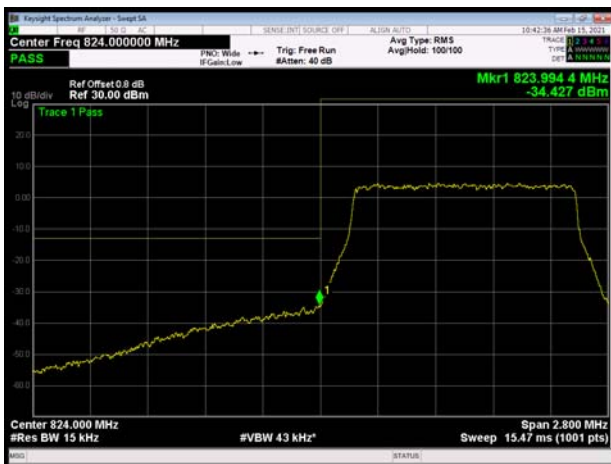

LTE Band 5 16QAM 1.4MHz CH-High 100%RB

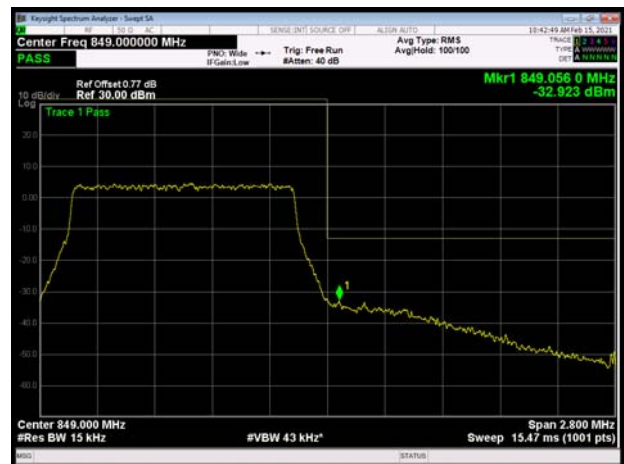

LTE Band 5 16QAM 3MHz CH-Low 1RB

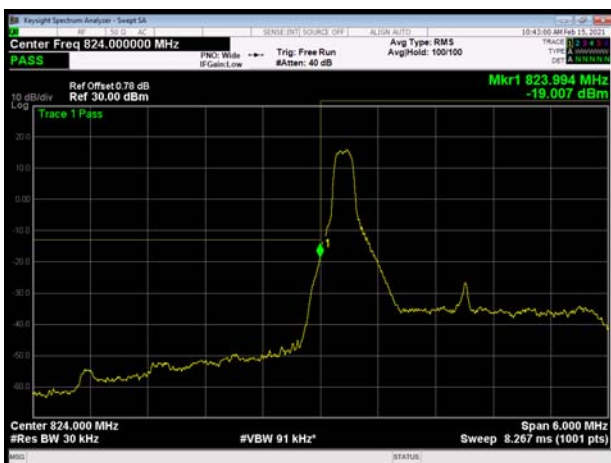

LTE Band 5 16QAM 3MHz CH-High 1RB

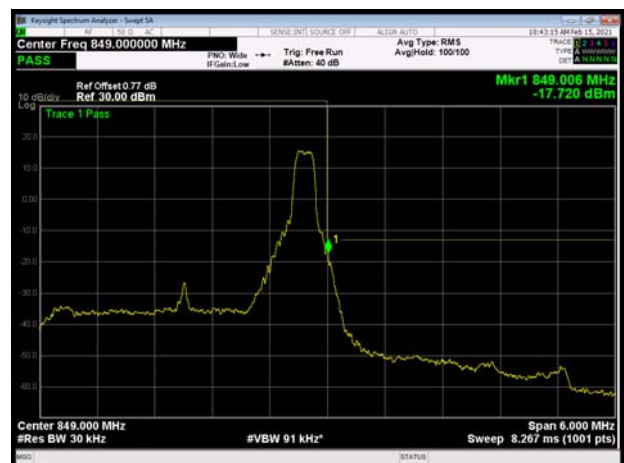



LTE Band 5 16QAM 3MHz CH-Low 100%RB

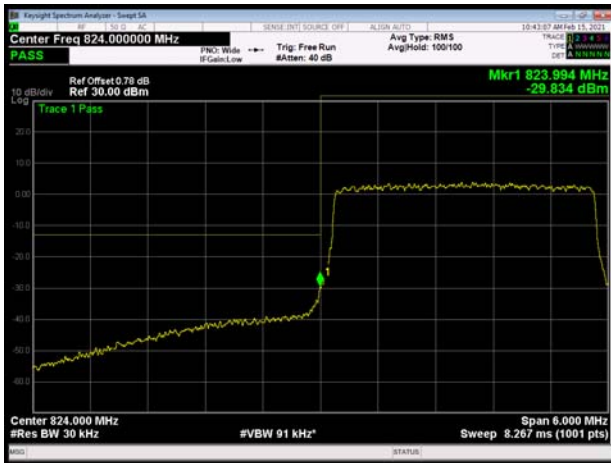

LTE Band 5 16QAM 3MHz CH-High 100%RB



LTE Band 5 16QAM 5MHz CH-Low 1RB

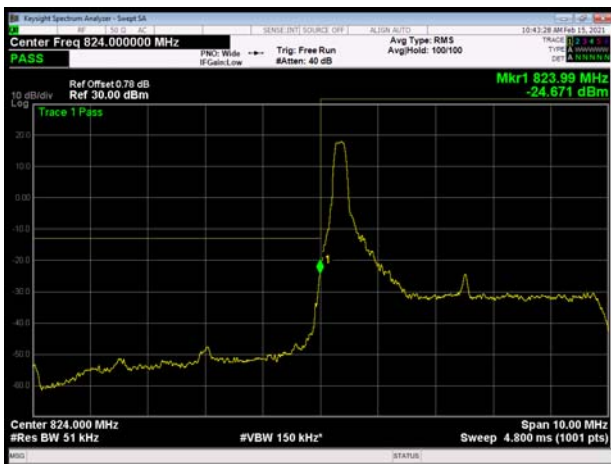

LTE Band 5 16QAM 5MHz CH-High 1RB

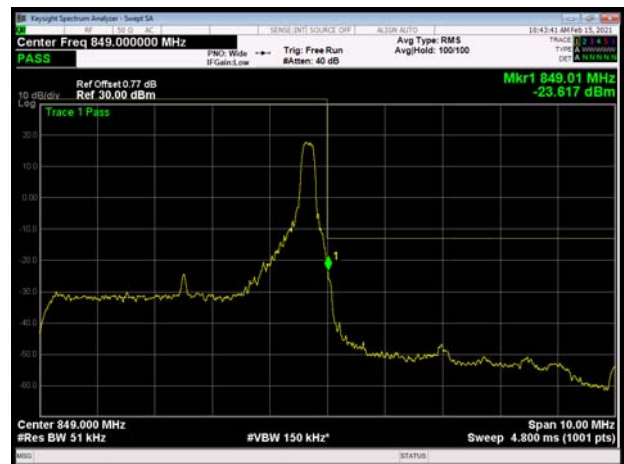

LTE Band 5 16QAM 5MHz CH-Low 100%RB

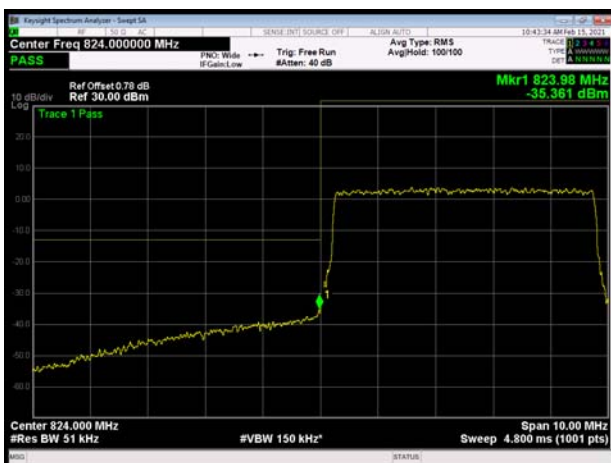

LTE Band 5 16QAM 5MHz CH-High 100%RB

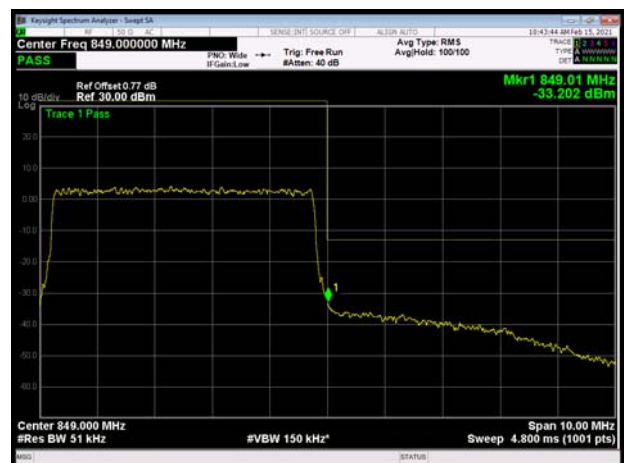



LTE Band 5 16QAM 10MHz CH-Low 1RB

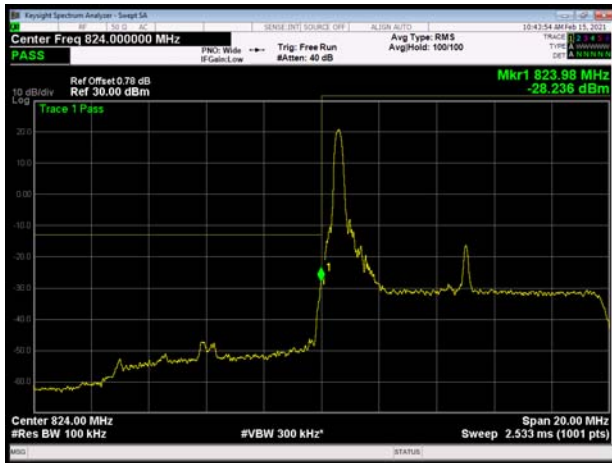

LTE Band 5 16QAM 10MHz CH-High 1RB

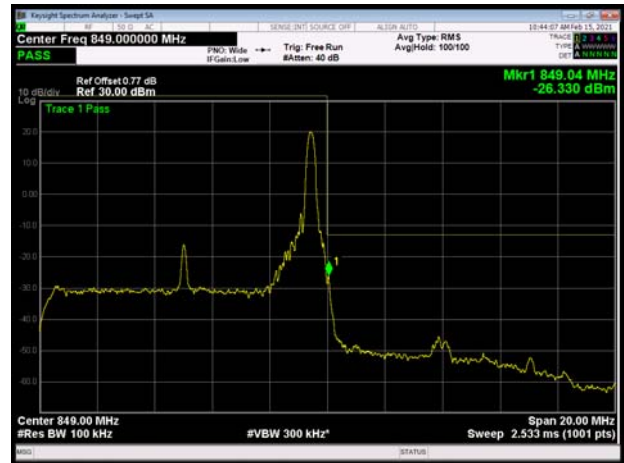

LTE Band 5 16QAM 10MHz CH-Low 100%RB

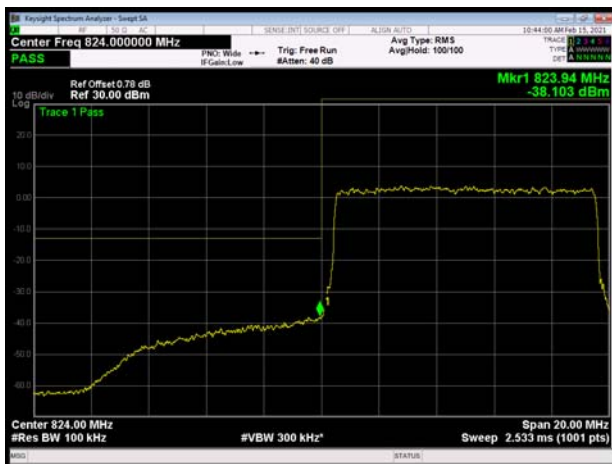

LTE Band 5 16QAM 10MHz CH-High 100%RB

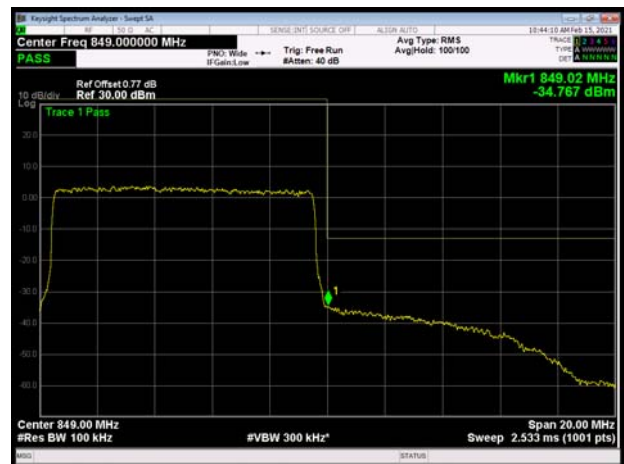

5.4. Peak-to-Average Power Ratio (PAPR)

Ambient condition

Temperature	Relative humidity	Pressure
23°C ~25°C	45%~50%	101.5kPa

Methods of Measurement

Measure the total peak power and record as P_{Pk} . And measure the total average power and record as P_{Avg} . Both the peak and average power levels must be expressed in the same logarithmic units (e.g., dBm). Determine the PAPR from:

$$PAPR (dB) = P_{Pk} (dBm) - P_{Avg} (dBm).$$

Test Setup

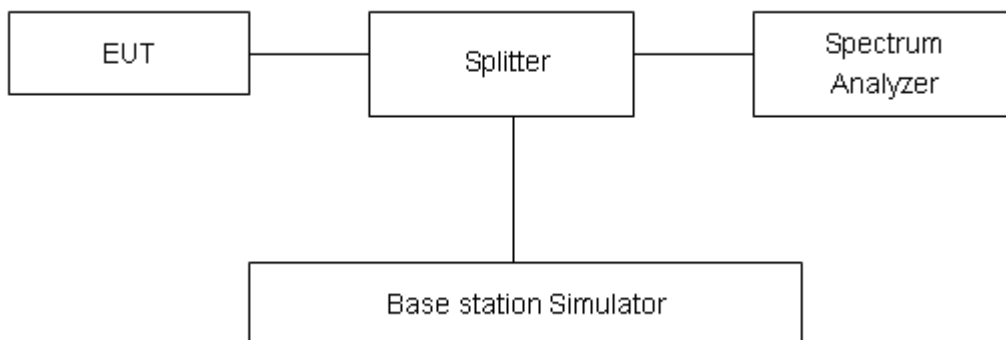

Limits

According to the Sec. 22.913(d), The peak-to-average ratio (PAR) of the transmission must not exceed 13 dB.

Measurement Uncertainty

The assessed measurement uncertainty to ensure 95% confidence level for the normal distribution is with the coverage factor $k = 2$, $U = 0.4$ dB.

Test Results

Mode	Channel	Frequency (MHz)	Peak (dBm)	Avg (dBm)	PAPR (dB)	Limit (dB)	Conclusion
GSM 850 (GMSK)	128	824.2	33.51	32.16	1.35	≤13	PASS
	190	836.6	33.37	32.13	1.24	≤13	PASS
	251	848.8	33.42	32.13	1.29	≤13	PASS
GPRS 850 (GMSK)	128	824.2	33.54	32.16	1.38	≤13	PASS
	190	836.6	33.47	32.13	1.34	≤13	PASS
	251	848.8	33.42	32.17	1.25	≤13	PASS
EGPRS 850 (8PSK)	128	824.2	29.14	26.99	2.15	≤13	PASS
	190	836.6	29.62	27.28	2.34	≤13	PASS
	251	848.8	29.60	27.32	2.28	≤13	PASS
WCDMA Band V (RMC)	4132	826.4	25.57	21.70	3.87	≤13	PASS
	4183	836.6	25.49	21.20	4.29	≤13	PASS
	4233	846.6	25.38	20.92	4.46	≤13	PASS

LTE Band 5								
Modulation	Bandwidth (MHz)	Channel	Frequency (MHz)	Peak (dBm)	Avg (dBm)	PAPR (dB)	Limit (dB)	Conclusion
QPSK	1.4	20407	824.7	28.14	23.29	4.85	≤13	PASS
		20525	836.5	28.17	23.29	4.88	≤13	PASS
		20643	848.3	28.08	23.36	4.72	≤13	PASS
	3	20415	825.5	28.06	23.10	4.96	≤13	PASS
		20525	836.5	28.03	23.13	4.90	≤13	PASS
		20635	847.5	27.97	23.15	4.82	≤13	PASS
	5	20425	826.5	28.21	23.16	5.05	≤13	PASS
		20525	836.5	28.18	23.21	4.97	≤13	PASS
		20625	846.5	28.18	23.21	4.97	≤13	PASS
	10	20450	829	28.23	23.18	5.05	≤13	PASS
		20525	836.5	28.19	23.24	4.95	≤13	PASS
		20600	844	28.12	23.22	4.90	≤13	PASS
16QAM	1.4	20407	824.7	27.96	22.25	5.71	≤13	PASS
		20525	836.5	27.95	22.29	5.66	≤13	PASS
		20643	848.3	27.91	22.35	5.56	≤13	PASS
	3	20415	825.5	27.95	22.09	5.86	≤13	PASS
		20525	836.5	27.87	22.10	5.77	≤13	PASS
		20635	847.5	27.88	22.16	5.72	≤13	PASS
	5	20425	826.5	27.97	22.18	5.79	≤13	PASS
		20525	836.5	28.00	22.21	5.79	≤13	PASS
		20625	846.5	27.92	22.21	5.71	≤13	PASS
	10	20450	829	27.98	22.16	5.82	≤13	PASS
		20525	836.5	27.99	22.21	5.78	≤13	PASS
		20600	844	27.93	22.19	5.74	≤13	PASS
64QAM	1.4	20407	824.7	27.62	21.87	5.75	≤13	PASS
		20525	836.5	27.48	21.85	5.63	≤13	PASS
		20643	848.3	27.48	21.88	5.60	≤13	PASS
	3	20415	825.5	27.52	21.69	5.83	≤13	PASS
		20525	836.5	27.48	21.68	5.80	≤13	PASS
		20635	847.5	27.39	21.63	5.76	≤13	PASS
	5	20425	826.5	27.59	21.76	5.83	≤13	PASS
		20525	836.5	27.59	21.79	5.80	≤13	PASS
		20625	846.5	27.50	21.73	5.77	≤13	PASS
	10	20450	829	27.63	21.71	5.92	≤13	PASS
		20525	836.5	27.55	21.75	5.80	≤13	PASS



		20600	844	27.47	21.68	5.79	≤13	PASS
--	--	-------	-----	-------	-------	------	-----	------

5.5. Frequency Stability

Ambient condition

Temperature	Relative humidity	Pressure
23°C ~25°C	45%~50%	101.5kPa

Method of Measurement

Frequency Stability (Temperature Variation)

The temperature inside the climate chamber is varied from -30°C to +50°C in 10°C step size,

(1) With all power removed, the temperature was decreased to 0°C and permitted to stabilize for three hours.

(2) Measure the carrier frequency with the test equipment in a “call mode”. These measurements should be made within 1 minute of powering up the mobile station, to prevent significant self warming.

(3) Repeat the above measurements at 10°C increments from -30°C to +50°C. Allow at least 1.5 hours at each temperature, un-powered, before making measurements.

Frequency Stability (Voltage Variation)

The frequency stability shall be measured with variation of primary supply voltage as follows:

Primary Supply Voltage: The primary supply voltage is varied from 85% to 115% of the nominal value for non hand-carried battery and AC powered equipment. For hand-carried, battery-powered equipment, primary supply voltage is reduced to the battery operating end point which shall be specified by the manufacturer.

This transceiver is specified to operate with an input voltage of between 3.6 V and 4.45 V, with a nominal voltage of 3.87V.

Test setup

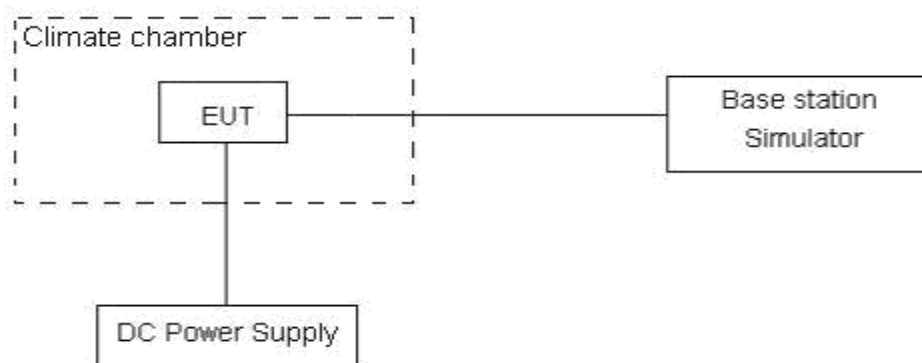

Limits

According to the Sec. 22.355, the frequency stability of the carrier shall be accurate to within 2.5 ppm of the received frequency for mobile stations.

Limits	≤ 2.5 ppm
--------	-----------

Measurement Uncertainty

The assessed measurement uncertainty to ensure 99.75% confidence level for the normal distribution is with the coverage factor $k = 3$, $U = 0.01\text{ppm}$.



Test Result

GSM850

Condition		Freq.Error (Hz)	Freq.Error (Hz)	Frequency Stability (ppm)	Frequency Stability (ppm)	Verdict
Temperature	Voltage	GMSK	8PSK	GMSK	8PSK	
Normal (25°C)	Normal	2.60	9.22	0.00138	0.00491	PASS
Extreme (50°C)		7.72	9.27	0.00411	0.00493	PASS
Extreme (40°C)		6.16	16.17	0.00328	0.00860	PASS
Extreme (30°C)		16.49	7.33	0.00877	0.00390	PASS
Extreme (20°C)		10.30	15.74	0.00548	0.00837	PASS
Extreme (10°C)		16.80	7.40	0.00894	0.00394	PASS
Extreme (0°C)		16.92	1.29	0.00900	0.00069	PASS
Extreme (-10°C)		13.99	16.51	0.00744	0.00878	PASS
Extreme (-20°C)		9.73	4.63	0.00517	0.00246	PASS
Extreme (-30°C)		11.29	13.83	0.00601	0.00736	PASS
25°C	LV	7.06	13.39	0.00375	0.00712	PASS
	HV	13.30	10.81	0.00707	0.00575	PASS

WCDMA Band V

Condition		Freq.Error (Hz)	Freq.Error (Hz)	Frequency Stability (ppm)	Frequency Stability (ppm)	Verdict
Temperature	Voltage	BPSK	QPSK	BPSK	QPSK	
Normal (25°C)	Normal	12.87	1.62	0.00684	0.00086	PASS
Extreme (50°C)		10.01	3.81	0.00532	0.00203	PASS
Extreme (40°C)		7.21	13.97	0.00384	0.00743	PASS
Extreme (30°C)		1.23	16.61	0.00066	0.00883	PASS
Extreme (20°C)		6.33	10.02	0.00337	0.00533	PASS
Extreme (10°C)		6.11	13.47	0.00325	0.00717	PASS
Extreme (0°C)		9.89	17.18	0.00526	0.00914	PASS
Extreme (-10°C)		6.07	5.10	0.00323	0.00271	PASS
Extreme (-20°C)		5.88	12.38	0.00313	0.00658	PASS
Extreme (-30°C)		10.82	12.56	0.00575	0.00668	PASS
25°C	LV	11.66	1.38	0.00620	0.00074	PASS
	HV	7.37	17.03	0.00392	0.00906	PASS



LTE Band 5

Condition		Freq.Error (Hz)	Freq.Error (Hz)	Freq.Error (Hz)	Frequency Stability (ppm)	Frequency Stability (ppm)	Frequency Stability (ppm)	Verdict
BANDWIDTH	1.4MHz							
Temperature	Voltage	64QAM	16QAM	QPSK	64QAM	16QAM	QPSK	
Normal (25°C)	Normal	14.61	15.94	8.79	0.00777	0.00848	0.00468	PASS
Extreme (50°C)		17.77	7.57	14.89	0.00945	0.00403	0.00792	PASS
Extreme (40°C)		10.19	17.87	10.33	0.00542	0.00951	0.00549	PASS
Extreme (30°C)		16.47	1.37	13.61	0.00876	0.00073	0.00724	PASS
Extreme (20°C)		17.63	3.06	12.50	0.00938	0.00163	0.00665	PASS
Extreme (10°C)		2.89	6.88	1.21	0.00154	0.00366	0.00064	PASS
Extreme (0°C)		3.19	17.04	8.58	0.00170	0.00906	0.00457	PASS
Extreme (-10°C)		7.36	15.66	4.90	0.00392	0.00833	0.00260	PASS
Extreme (-20°C)		12.09	6.71	5.97	0.00643	0.00357	0.00318	PASS
Extreme (-30°C)		12.76	11.39	13.44	0.00679	0.00606	0.00715	PASS
25°C	LV	7.16	9.12	16.23	0.00381	0.00485	0.00863	PASS
	HV	2.02	8.11	9.29	0.00108	0.00431	0.00494	PASS
Condition		Freq.Error (Hz)	Freq.Error (Hz)	Freq.Error (Hz)	Frequency Stability (ppm)	Frequency Stability (ppm)	Frequency Stability (ppm)	Verdict
BANDWIDTH	3MHz							
Temperature	Voltage	64QAM	16QAM	QPSK	64QAM	16QAM	QPSK	
Normal (25°C)	Normal	14.54	13.23	4.16	0.00774	0.00704	0.00221	PASS
Extreme (50°C)		16.94	12.26	17.21	0.00901	0.00652	0.00915	PASS
Extreme (40°C)		1.22	8.22	8.97	0.00065	0.00437	0.00477	PASS
Extreme (30°C)		14.32	9.37	9.33	0.00762	0.00498	0.00496	PASS
Extreme (20°C)		9.84	3.66	16.88	0.00524	0.00194	0.00898	PASS
Extreme (10°C)		4.19	3.52	3.22	0.00223	0.00187	0.00171	PASS
Extreme (0°C)		10.80	12.80	17.30	0.00574	0.00681	0.00920	PASS
Extreme (-10°C)		13.59	12.95	6.67	0.00723	0.00689	0.00355	PASS
Extreme (-20°C)		16.67	7.77	6.24	0.00887	0.00413	0.00332	PASS
Extreme (-30°C)		15.10	1.76	8.98	0.00803	0.00093	0.00478	PASS
25°C	LV	4.58	4.25	15.79	0.00244	0.00226	0.00840	PASS
	HV	11.71	5.96	2.29	0.00623	0.00317	0.00122	PASS
Condition		Freq.Error (Hz)	Freq.Error (Hz)	Freq.Error (Hz)	Frequency Stability (ppm)	Frequency Stability (ppm)	Frequency Stability (ppm)	Verdict



BANDWIDTH	5MHz							
Temperature	Voltage	64QAM	16QAM	QPSK	64QAM	16QAM	QPSK	
Normal (25°C)	Normal	15.46	6.38	14.04	0.00823	0.00339	0.00747	PASS
Extreme (50°C)		17.84	17.70	10.96	0.00949	0.00942	0.00583	PASS
Extreme (40°C)		11.99	16.70	1.70	0.00638	0.00888	0.00090	PASS
Extreme (30°C)		14.61	13.44	16.03	0.00777	0.00715	0.00853	PASS
Extreme (20°C)		8.48	14.49	1.43	0.00451	0.00771	0.00076	PASS
Extreme (10°C)		9.51	8.73	13.14	0.00506	0.00464	0.00699	PASS
Extreme (0°C)		16.38	16.03	11.68	0.00871	0.00853	0.00621	PASS
Extreme (-10°C)		2.84	16.77	9.84	0.00151	0.00892	0.00523	PASS
Extreme (-20°C)		17.83	10.21	11.67	0.00949	0.00543	0.00621	PASS
Extreme (-30°C)		5.45	3.87	13.48	0.00290	0.00206	0.00717	PASS
25°C		LV	7.85	16.01	2.95	0.00418	0.00852	0.00157
	HV	12.74	1.09	8.93	0.00677	0.00058	0.00475	PASS
Condition		Freq.Error (Hz)	Freq.Error (Hz)	Freq.Error (Hz)	Frequency Stability (ppm)	Frequency Stability (ppm)	Frequency Stability (ppm)	Verdict
BANDWIDTH	10MHz							
Temperature	Voltage	64QAM	16QAM	QPSK	64QAM	16QAM	QPSK	
Normal (25°C)	Normal	17.53	11.33	15.34	0.00933	0.00603	0.00816	PASS
Extreme (50°C)		6.46	17.34	12.19	0.00343	0.00922	0.00649	PASS
Extreme (40°C)		14.06	17.18	8.44	0.00748	0.00914	0.00449	PASS
Extreme (30°C)		16.11	3.10	9.81	0.00857	0.00165	0.00522	PASS
Extreme (20°C)		4.88	16.44	15.97	0.00260	0.00875	0.00849	PASS
Extreme (10°C)		9.20	4.66	14.70	0.00489	0.00248	0.00782	PASS
Extreme (0°C)		7.07	6.16	10.01	0.00376	0.00328	0.00533	PASS
Extreme (-10°C)		8.12	6.16	8.39	0.00432	0.00328	0.00447	PASS
Extreme (-20°C)		4.09	6.14	17.22	0.00218	0.00327	0.00916	PASS
Extreme (-30°C)		13.72	7.94	14.10	0.00730	0.00423	0.00750	PASS
25°C		LV	16.07	5.74	7.21	0.00855	0.00305	0.00384
	HV	6.82	11.55	6.10	0.00363	0.00614	0.00324	PASS

5.6. Spurious Emissions at Antenna Terminals

Ambient condition

Temperature	Relative humidity	Pressure
23°C ~25°C	45%~50%	101.5kPa

Method of Measurement

The EUT was connected to Spectrum Analyzer and Base Station Simulator via power Splitter. The measurement is carried out using a spectrum analyzer. The spectrum analyzer scans from 9kHz to the 10th harmonic of the carrier.

The peak detector is used. RBW are set to 100 kHz and VBW are set to 300 kHz for below 1G, RBW are set to 1MHz and VBW are set to 3MHz for above 1G, Sweep is set to ATUO.

RBW is set to 1 kHz (0.009MHz~ 0.15 MHz),

RBW is set to 10 kHz (0.15 MHz~ 30 MHz)

RBW is set to 100 kHz (30MHz~1000 MHz)

RBW is set to 1000 kHz (above 1000MHz)

The modulation mode and RB allocation refer to section 5.1, using the maximum output power configuration.

Test setup

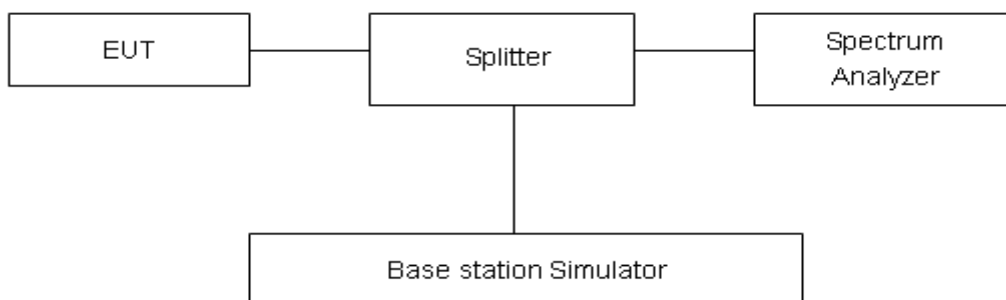

Limits

Rule Part 22.917(a) specifies that “The power of any emission outside of the authorized operating frequency ranges must be attenuated below the transmitting power (P) by a factor of at least 43 + 10 log (P) dB.”

Limit	-13 dBm

Measurement Uncertainty

The assessed measurement uncertainty to ensure 99.75% confidence level for the normal distribution is with the coverage factor $k = 1.96$.

Frequency	Uncertainty
9kHz-1GHz	0.684 dB
1GHz-18GHz	1.407 dB

Test Result

Sweep the whole frequency band through the range from 9kHz to the 10th harmonic of the carrier, the emissions more than 20 dB below the limit are not reported.

The signal beyond the limit is carrier.

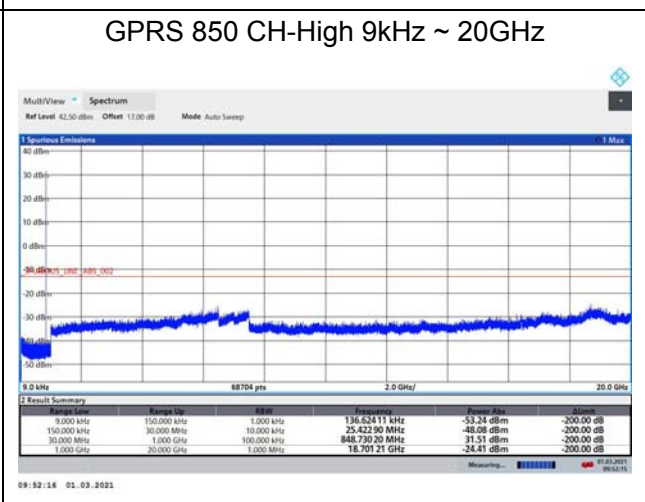
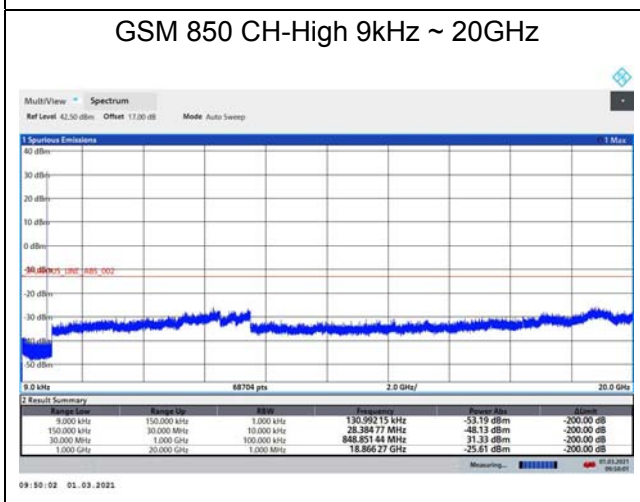
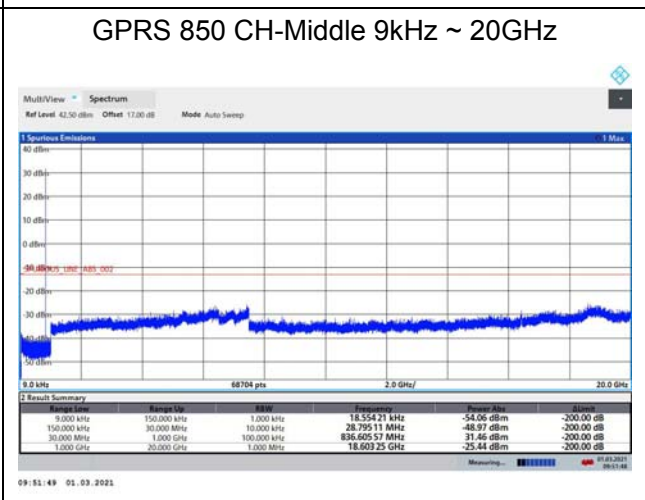
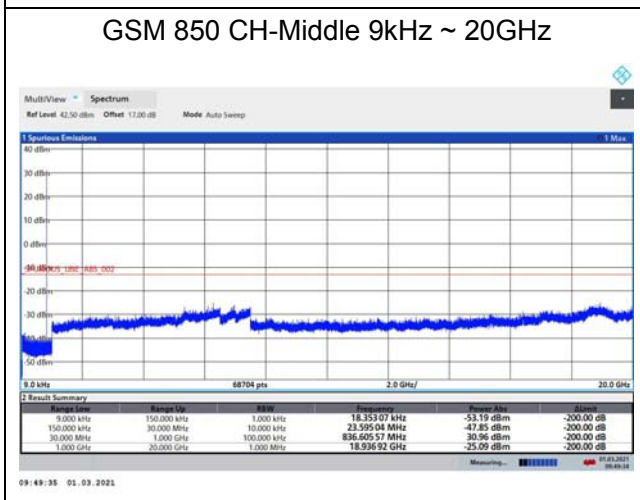
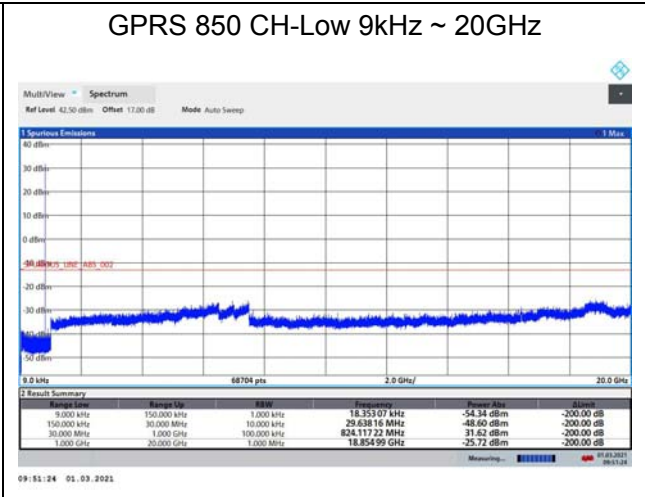
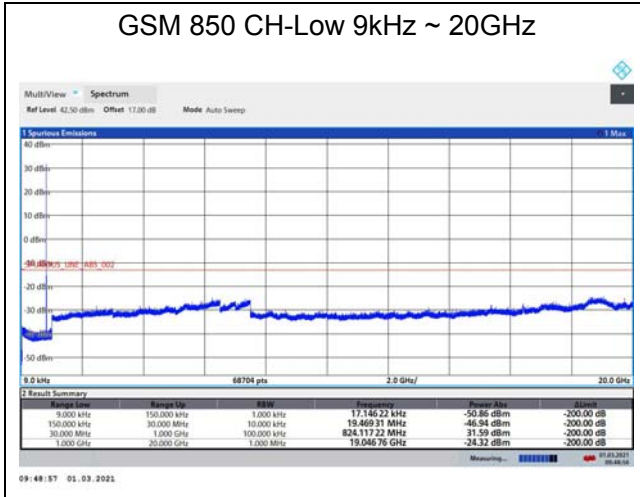



EGPRS 850 CH-Low 9kHz ~ 20GHz

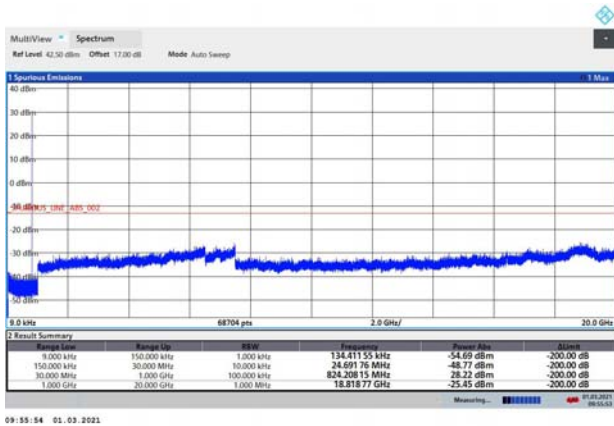

09:55:54 01.03.2021

WCDMA BAND V CH-Low 9kHz ~ 20GHz

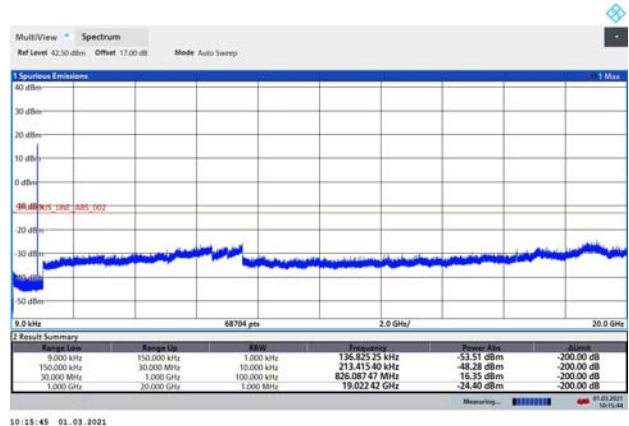

10:15:45 01.03.2021

EGPRS 850 CH-Middle 9kHz ~ 20GHz

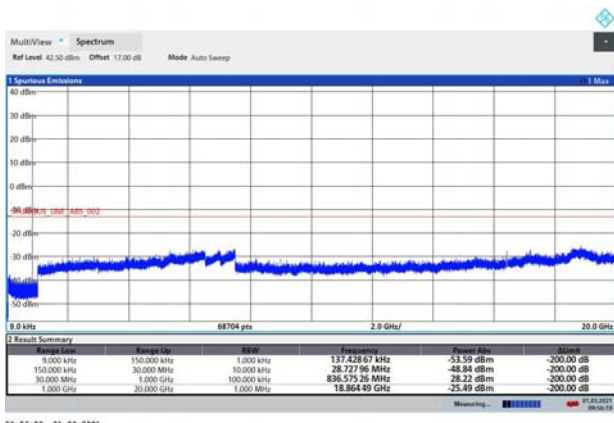

09:56:20 01.03.2021

WCDMA BAND V CH-Middle 9kHz ~ 20GHz

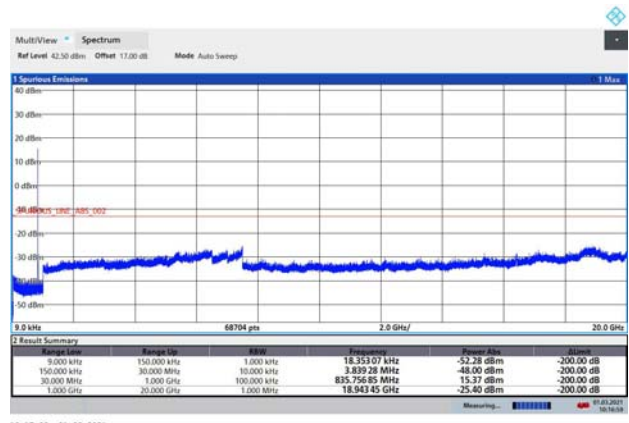

10:17:00 01.03.2021

EGPRS 850 CH-High 9kHz ~ 20GHz

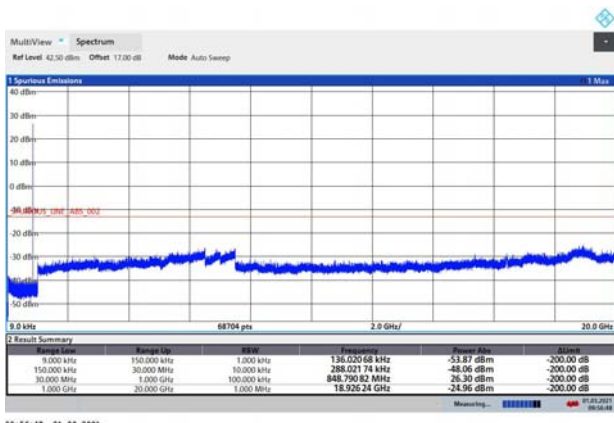

09:56:48 01.03.2021

WCDMA BAND V CH-High 9kHz ~ 20GHz

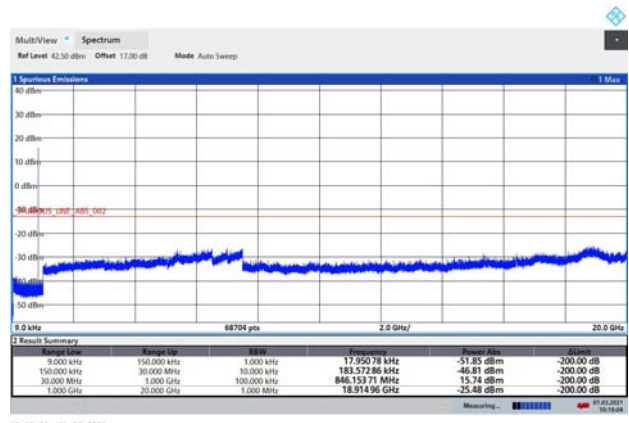

10:18:04 01.03.2021

LTE Band 5 1.4MHz CH-Low 9kHz~10GHz

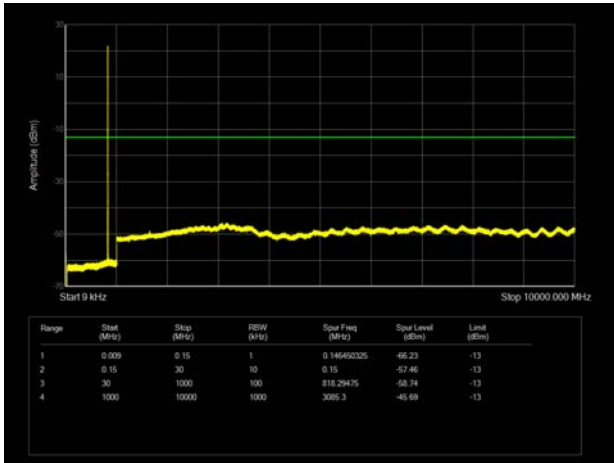

LTE Band 5 3MHz CH-Low 9kHz~10GHz

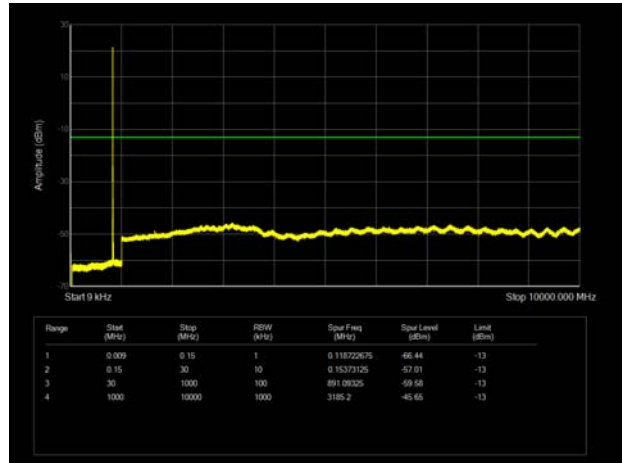

LTE Band 5 1.4MHz CH-Middle 9kHz~10GHz

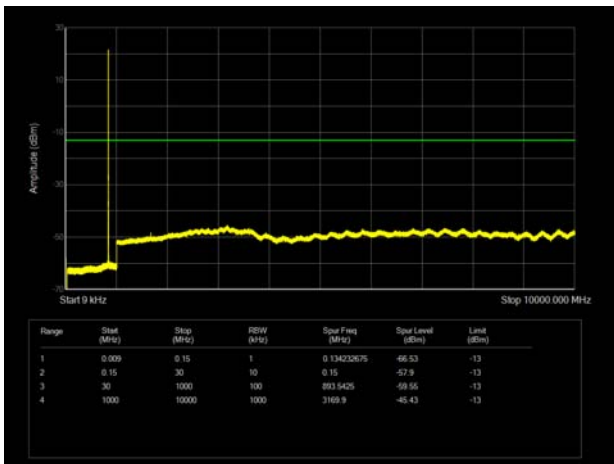

LTE Band 5 3MHz CH-Middle 9kHz~10GHz

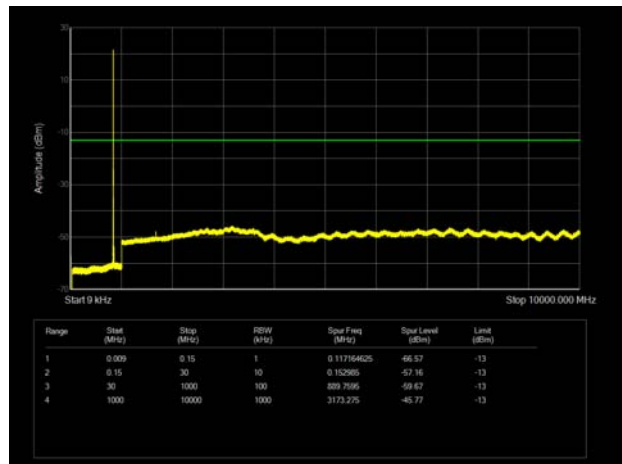

LTE Band 5 1.4MHz CH-High 9kHz~10GHz

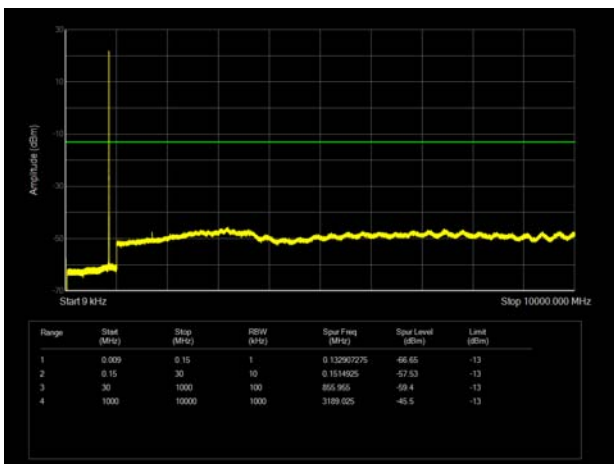

LTE Band 5 3MHz CH-High 9kHz~10GHz

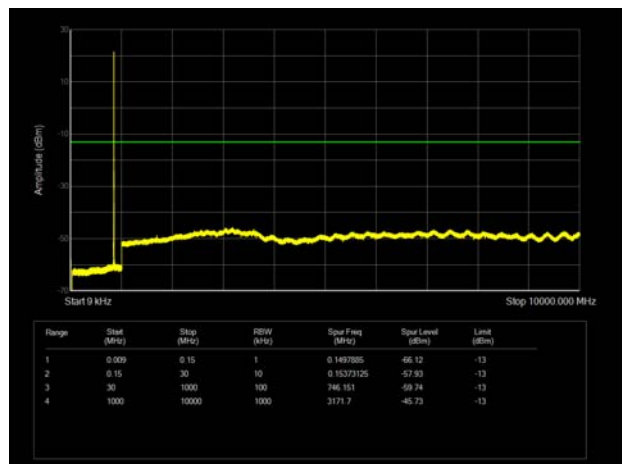

LTE Band 5 5MHz CH-Low 9kHz~10GHz

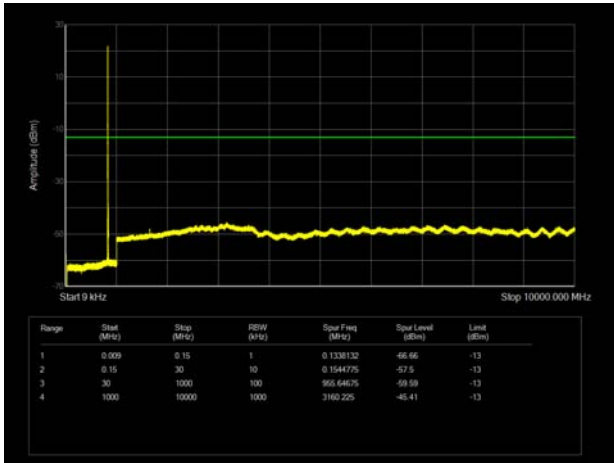

LTE Band 5 10MHz CH-Low 9kHz~10GHz

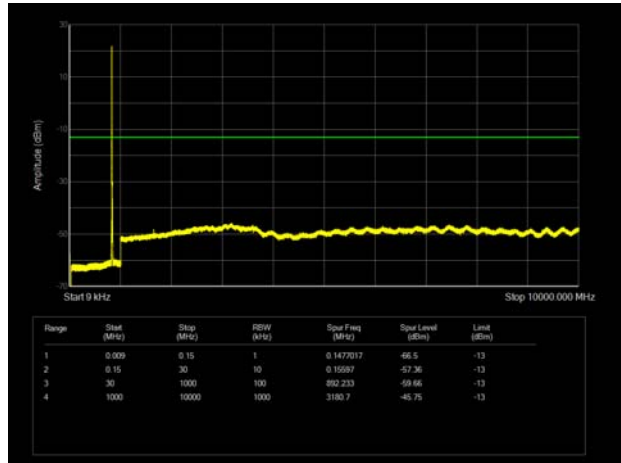

LTE Band 5 5MHz CH-Middle 9kHz~10GHz

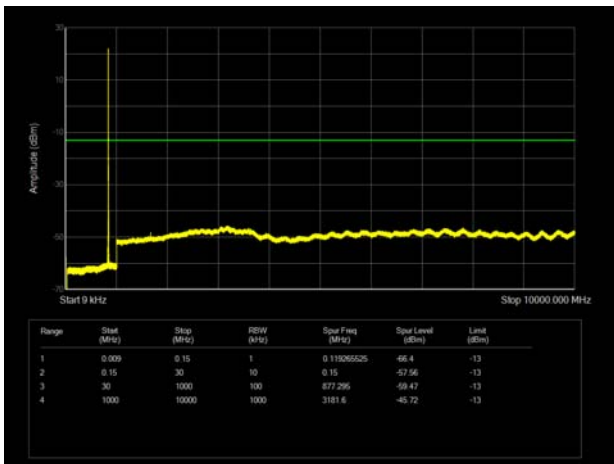

LTE Band 5 10MHz CH-Middle 9kHz~10GHz

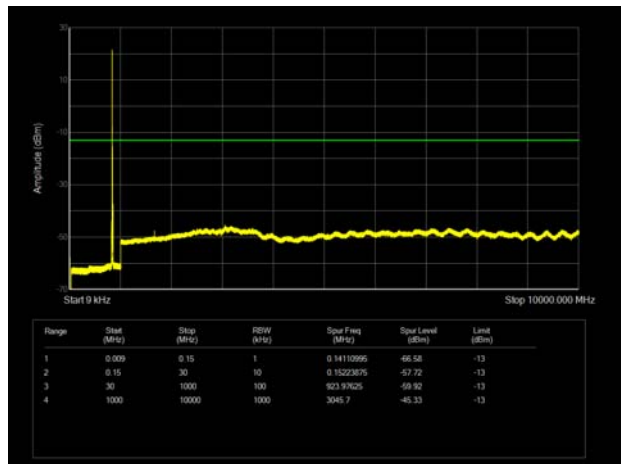

LTE Band 5 5MHz CH-High 9kHz~10GHz

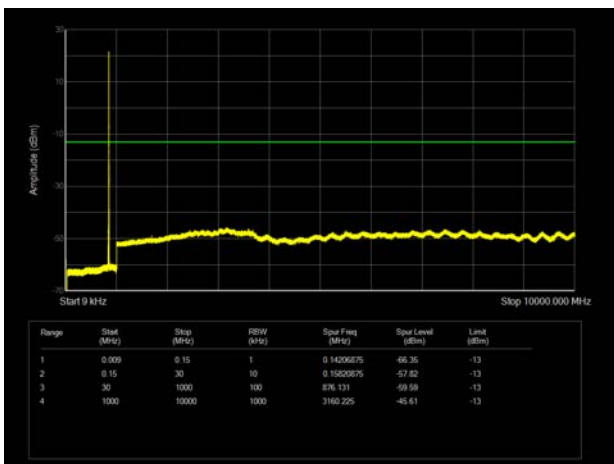

LTE Band 5 10MHz CH-High 9kHz~10GHz

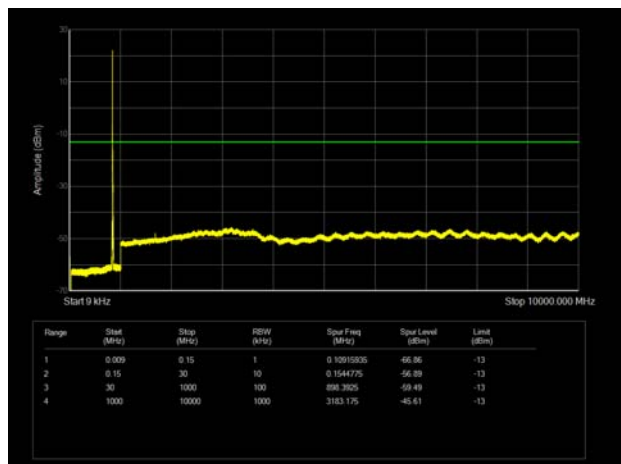

5.7. Radiates Spurious Emission

Ambient condition

Temperature	Relative humidity	Pressure
23°C ~25°C	45%~50%	101.5kPa

Method of Measurement

1. The testing follows FCC KDB 971168 v03r01 Section 5.8 and ANSI C63.26 (2015).
2. Below 1GHz: The EUT is placed on a turntable 0.8 meters above the ground in the chamber, 3 meter away from the antenna. The maximal emission value is acquired by adjusting the antenna height, polarisation and turntable azimuth. Normally, the height range of antenna is 1 m to 4 m, the azimuth range of turntable is 0° to 360°, and the receive antenna has two polarizations Vertical (V) and Horizontal (H). Above 1GHz: (Note: the FCC's permission to use 1.5m as an alternative per TCBC Conf call of Dec. 2, 2014.) The EUT is placed on a turntable 1.5 meters above the ground in the chamber, 3 meter away from the antenna. The maximal emission value is acquired by adjusting the antenna height, polarisation and turntable azimuth. Normally, the height range of antenna is 1 m to 4 m, the azimuth range of turntable is 0° to 360°, and the receive antenna has two polarizations Vertical (V) and Horizontal (H).
3. A loop antenna, A log-periodic antenna or horn antenna shall be substituted in place of the EUT. The log-periodic antenna will be driven by a signal generator and the level will be adjusted till the same power value on the spectrum analyzer or receiver. The level of the spurious emissions can be calculated through the level of the signal generator, cable loss, the gain of the substitution antenna and the reading of the spectrum analyzer or receiver.
4. The EUT is then put into continuously transmitting mode at its maximum power level during the test. Set Test Receiver or Spectrum RBW=200Hz,VBW=600Hz for 9kHz-150kHz , RBW=10kHz, VBW=30kHz 150kHz-30MHz , RBW=100kHz,VBW=300kHz for 30MHz to 1GHz and RBW=1MHz, VBW=3MHz for above 1GHz, And the maximum value of the receiver should be recorded as (Pr).
5. The EUT shall be replaced by a substitution antenna. In the chamber, an substitution antenna for the frequency band of interest is placed at the reference point of the chamber. An RF Signal source for the frequency band of interest is connected to the substitution antenna with a cable that has been constructed to not interfere with the radiation pattern of the antenna. A power (PMea) is applied to the input of the substitution antenna, and adjust the level of the signal generator output until the value of the receiver reach the previously recorded (Pr). The power of signal source (PMea) is recorded. The test should be performed by rotating the test item and adjusting the receiving antenna polarization.
6. A amplifier should be connected to the Signal Source output port. And the cable should be connect between the Amplifier and the Substitution Antenna. The cable loss (Pcl) ,the Substitution Antenna Gain (Ga) and the Amplifier Gain (PAg) should be recorded after test.
7. The measurement results are obtained as described below:
Power(EIRP)=PMea- PAg - Pcl + Ga
The measurement results are amend as described below:
Power(EIRP)=PMea- Pcl + Ga
8. This value is EIRP since the measurement is calibrated using an antenna of known gain (2.15 dBi)

and known input power. ERP can be calculated from EIRP by subtracting the gain of the dipole, $ERP = EIRP - 2.15\text{dBi}$.

The modulation mode and RB allocation refer to section 5.1, using the maximum output power configuration.

Test setup

9KHz ~ 30MHz

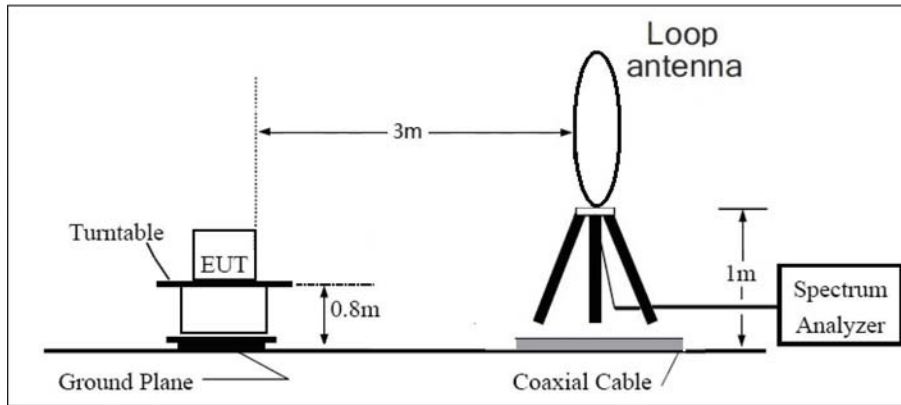

30MHz ~ 1GHz

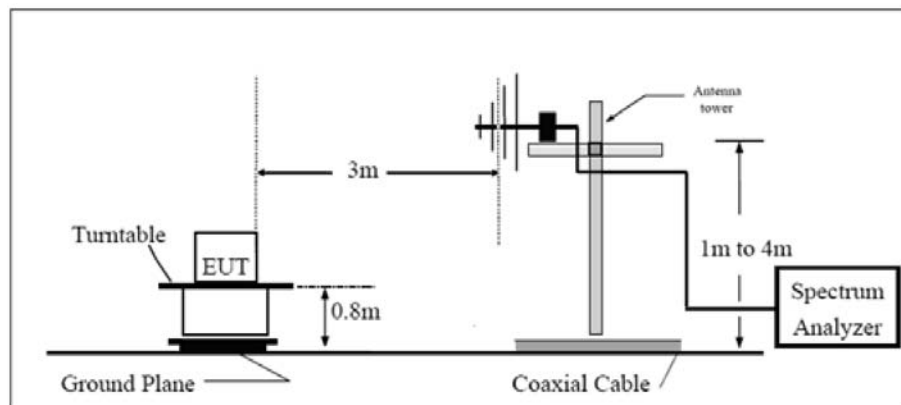

Above 1GHz

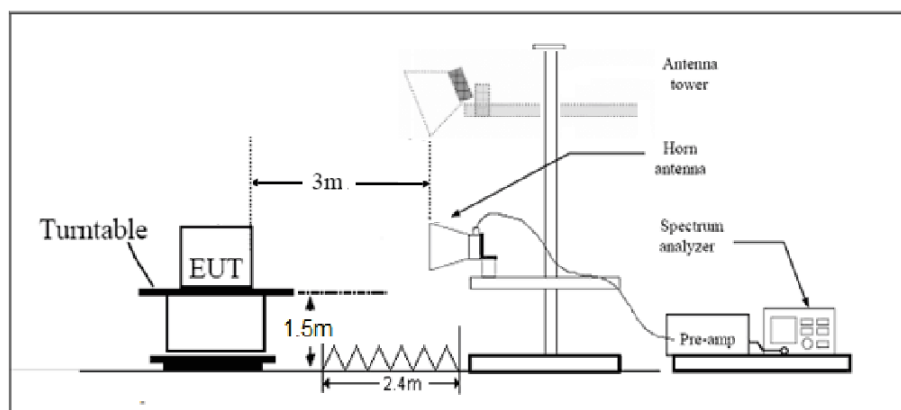

Note: Area side: 2.4mX3.6m

**Limits**

Rule Part 22.917(a) specifies that “The power of any emission outside of the authorized operating frequency ranges must be attenuated below the transmitting power (P) by a factor of at least $43 + 10 \log (P)$ dB.”

Limit	-13 dBm
-------	---------

Measurement Uncertainty

The assessed measurement uncertainty to ensure 95% confidence level for the normal distribution is with the coverage factor $k = 1.96$, $U = 3.55$ dB.

Test Result

Sweep the whole frequency band through the range from 9kHz to the 10th harmonic of the carrier, the emissions below the noise floor will not be recorded in the report.

Main antenna

GSM 850 CH-Middle

Harmonic	Frequency (MHz)	SG (dBm)	Cable Loss (dB)	Gain (dBi)	Antenna Polarization	ERP Level (dBm)	Limit (dBm)	Margin (dB)	Azimuth (deg)
2	1673.20	-48.21	1.70	8.70	Horizontal	-43.36	-13.00	30.36	90
3	2509.31	-45.33	2.30	12.00	Horizontal	-37.78	-13.00	24.78	45
4	3346.40	-60.66	2.70	12.70	Horizontal	-52.81	-13.00	39.81	45
5	4183.00	-62.68	3.00	12.50	Horizontal	-55.33	-13.00	42.33	90
6	5019.60	-59.22	3.40	12.50	Horizontal	-52.27	-13.00	39.27	315
7	5856.20	-60.02	3.40	12.80	Horizontal	-52.77	-13.00	39.77	180
8	6692.80	-57.81	4.10	11.50	Horizontal	-52.56	-13.00	39.56	225
9	7529.40	-54.98	4.20	12.20	Horizontal	-49.13	-13.00	36.13	225
10	8366.00	-54.45	4.30	12.50	Horizontal	-48.40	-13.00	35.40	45

Note: 1.The other Spurious RF Radiated emissions level is no more than noise floor.
 2.The worst emission was found in the antenna is Horizontal position.

WCDMA Band V CH-Middle

Harmonic	Frequency (MHz)	SG (dBm)	Cable Loss (dB)	Gain (dBi)	Antenna Polarization	ERP Level (dBm)	Limit (dBm)	Margin (dB)	Azimuth (deg)
2	1673.20	-66.37	1.70	8.70	Horizontal	-61.52	-13.00	48.52	45
3	2509.80	-50.63	2.30	12.00	Horizontal	-43.08	-13.00	30.08	180
4	3346.40	-66.08	2.70	12.70	Horizontal	-58.23	-13.00	45.23	135
5	4183.00	-62.67	3.00	12.50	Horizontal	-55.32	-13.00	42.32	45
6	5019.60	-58.78	3.40	12.50	Horizontal	-51.83	-13.00	38.83	90
7	5856.20	-59.32	3.40	12.80	Horizontal	-52.07	-13.00	39.07	45
8	6692.80	-57.04	4.10	11.50	Horizontal	-51.79	-13.00	38.79	225
9	7529.40	-55.27	4.20	12.20	Horizontal	-49.42	-13.00	36.42	315
10	8366.00	-54.38	4.30	12.50	Horizontal	-48.33	-13.00	35.33	45

Note: 1.The other Spurious RF Radiated emissions level is no more than noise floor.
 2.The worst emission was found in the antenna is Horizontal position.

LTE Band 5 1.4MHz CH-Middle

Harmonic	Frequency (MHz)	SG (dBm)	Cable Loss (dB)	Gain (dBi)	Antenna Polarization	ERP Level (dBm)	Limit (dBm)	Margin (dB)	Azimuth (deg)
2	1673.00	-55.01	1.70	8.70	Horizontal	-50.16	-13.00	37.16	45
3	2509.50	-53.52	2.30	12.00	Horizontal	-45.97	-13.00	32.97	225
4	3346.00	-67.00	2.70	12.70	Horizontal	-59.15	-13.00	46.15	45
5	4182.50	-63.29	3.00	12.50	Horizontal	-55.94	-13.00	42.94	225
6	5019.00	-61.05	3.40	12.50	Horizontal	-54.10	-13.00	41.10	315
7	5855.50	-60.82	3.40	12.80	Horizontal	-53.57	-13.00	40.57	270
8	6692.00	-56.07	4.10	11.50	Horizontal	-50.82	-13.00	37.82	45
9	7528.50	-54.79	4.20	12.20	Horizontal	-48.94	-13.00	35.94	90
10	8365.00	-54.70	4.30	12.50	Horizontal	-48.65	-13.00	35.65	0

Note: 1.The other Spurious RF Radiated emissions level is no more than noise floor.
 2.The worst emission was found in the antenna is Horizontal position.

LTE Band 5 5MHz CH-Middle

Harmonic	Frequency (MHz)	SG (dBm)	Cable Loss (dB)	Gain (dBi)	Antenna Polarization	ERP Level (dBm)	Limit (dBm)	Margin (dB)	Azimuth (deg)
2	1668.60	-56.38	1.70	8.70	Horizontal	-51.53	-13.00	38.53	180
3	2503.30	-53.44	2.30	12.00	Horizontal	-45.89	-13.00	32.89	90
4	3466.20	-66.39	2.70	12.70	Horizontal	-58.54	-13.00	45.54	90
5	4215.90	-63.19	3.00	12.50	Horizontal	-55.84	-13.00	42.84	135
6	5165.60	-60.19	3.40	12.50	Horizontal	-53.24	-13.00	40.24	315
7	5815.30	-60.88	3.40	12.80	Horizontal	-53.63	-13.00	40.63	45
8	6765.00	-56.65	4.10	11.50	Horizontal	-51.40	-13.00	38.40	225
9	7614.70	-55.66	4.20	12.20	Horizontal	-49.81	-13.00	36.81	315
10	8464.40	-55.53	4.30	12.50	Horizontal	-49.48	-13.00	36.48	270

Note: 1.The other Spurious RF Radiated emissions level is no more than noise floor.
 2.The worst emission was found in the antenna is Horizontal position.



LTE Band 5 10MHz CH-Middle

Harmonic	Frequency (MHz)	SG (dBm)	Cable Loss (dB)	Gain (dBi)	Antenna Polarization	ERP Level (dBm)	Limit (dBm)	Margin (dB)	Azimuth (deg)
2	1664.40	-56.69	1.70	8.70	Horizontal	-51.84	-13.00	38.84	135
3	2496.60	-53.56	2.30	12.00	Horizontal	-46.01	-13.00	33.01	315
4	3346.00	-66.36	2.70	12.70	Horizontal	-58.51	-13.00	45.51	315
5	4182.50	-63.94	3.00	12.50	Horizontal	-56.59	-13.00	43.59	270
6	5019.00	-60.29	3.40	12.50	Horizontal	-53.34	-13.00	40.34	45
7	5855.50	-60.99	3.40	12.80	Horizontal	-53.74	-13.00	40.74	90
8	6692.00	-56.34	4.10	11.50	Horizontal	-51.09	-13.0	38.09	0
9	7528.50	-54.80	4.20	12.20	Horizontal	-48.95	-13.00	35.95	90
10	8365.00	-53.54	4.30	12.50	Horizontal	-47.49	-13.00	34.49	135

Note: 1.The other Spurious RF Radiated emissions level is no more than noise floor.

2.The worst emission was found in the antenna is Horizontal position.

Second antenna

GSM 850 CH-Middle

Harmonic	Frequency (MHz)	SG (dBm)	Cable Loss (dB)	Gain (dBi)	Antenna Polarization	ERP Level (dBm)	Limit (dBm)	Margin (dB)	Azimuth (deg)
2	1673.20	-62.84	1.70	8.70	Horizontal	-57.99	-13.00	44.99	90
3	2509.31	-50.40	2.30	12.00	Horizontal	-42.85	-13.00	29.85	315
4	3346.40	-61.18	2.70	12.70	Horizontal	-53.33	-13.00	40.33	90
5	4183.00	-60.18	3.00	12.50	Horizontal	-52.83	-13.00	39.83	45
6	5019.60	-58.63	3.40	12.50	Horizontal	-51.68	-13.00	38.68	315
7	5856.20	-59.31	3.40	12.80	Horizontal	-52.06	-13.00	39.06	225
8	6692.80	-56.89	4.10	11.50	Horizontal	-51.64	-13.00	38.64	45
9	7529.40	-54.25	4.20	12.20	Horizontal	-48.40	-13.00	35.40	180
10	8366.00	-54.72	4.30	12.50	Horizontal	-48.67	-13.00	35.67	45

Note: 1.The other Spurious RF Radiated emissions level is no more than noise floor.
 2.The worst emission was found in the antenna is Horizontal position.

WCDMA Band V CH-Middle

Harmonic	Frequency (MHz)	SG (dBm)	Cable Loss (dB)	Gain (dBi)	Antenna Polarization	ERP Level (dBm)	Limit (dBm)	Margin (dB)	Azimuth (deg)
2	1673.20	-68.31	1.70	8.70	Horizontal	-63.46	-13.00	50.46	90
3	2509.80	-66.03	2.30	12.00	Horizontal	-58.48	-13.00	45.48	45
4	3346.40	-66.32	2.70	12.70	Horizontal	-58.47	-13.00	45.47	315
5	4183.00	-62.58	3.00	12.50	Horizontal	-55.23	-13.00	42.23	45
6	5019.60	-58.80	3.40	12.50	Horizontal	-51.85	-13.00	38.85	225
7	5856.20	-59.98	3.40	12.80	Horizontal	-52.73	-13.00	39.73	180
8	6692.80	-57.03	4.10	11.50	Horizontal	-51.78	-13.00	38.78	315
9	7529.40	-54.92	4.20	12.20	Horizontal	-49.07	-13.00	36.07	45
10	8366.00	-53.69	4.30	12.50	Horizontal	-47.64	-13.00	34.64	45

Note: 1.The other Spurious RF Radiated emissions level is no more than noise floor.
 2.The worst emission was found in the antenna is Horizontal position.

LTE Band 5 1.4MHz CH-Middle

Harmonic	Frequency (MHz)	SG (dBm)	Cable Loss (dB)	Gain (dBi)	Antenna Polarization	ERP Level (dBm)	Limit (dBm)	Margin (dB)	Azimuth (deg)
2	1673.00	-64.52	1.70	8.70	Horizontal	-59.67	-13.00	46.67	90
3	2509.50	-44.57	2.30	12.00	Horizontal	-37.02	-13.00	24.02	270
4	3346.00	-65.81	2.70	12.70	Horizontal	-57.96	-13.00	44.96	180
5	4182.50	-62.59	3.00	12.50	Horizontal	-55.24	-13.00	42.24	90
6	5019.00	-58.14	3.40	12.50	Horizontal	-51.19	-13.00	38.19	45
7	5855.50	-60.17	3.40	12.80	Horizontal	-52.92	-13.00	39.92	225
8	6692.00	-56.40	4.10	11.50	Horizontal	-51.15	-13.00	38.15	90
9	7528.50	-54.13	4.20	12.20	Horizontal	-48.28	-13.00	35.28	45
10	8365.00	-53.77	4.30	12.50	Horizontal	-47.72	-13.00	34.72	90

Note: 1.The other Spurious RF Radiated emissions level is no more than noise floor.
 2.The worst emission was found in the antenna is Horizontal position.

LTE Band 5 5MHz CH-Middle

Harmonic	Frequency (MHz)	SG (dBm)	Cable Loss (dB)	Gain (dBi)	Antenna Polarization	ERP Level (dBm)	Limit (dBm)	Margin (dB)	Azimuth (deg)
2	1668.60	-64.13	1.70	8.70	Horizontal	-59.28	-13.00	46.28	45
3	2503.30	-48.79	2.30	12.00	Horizontal	-41.24	-13.00	28.24	315
4	3466.20	-64.48	2.70	12.70	Horizontal	-56.63	-13.0	43.63	225
5	4215.90	-62.22	3.00	12.50	Horizontal	-54.87	-13.0	41.87	45
6	5165.60	-57.64	3.40	12.50	Horizontal	-50.69	-13.0	37.69	90
7	5815.30	-59.08	3.40	12.80	Horizontal	-51.83	-13.0	38.83	225
8	6765.00	-57.65	4.10	11.50	Horizontal	-52.40	-13.0	39.40	0
9	7614.70	-54.03	4.20	12.20	Horizontal	-48.18	-13.0	35.18	90
10	8464.40	-53.58	4.30	12.50	Horizontal	-47.53	-13.0	34.53	45

Note: 1.The other Spurious RF Radiated emissions level is no more than noise floor.
 2.The worst emission was found in the antenna is Horizontal position.



LTE Band 5 10MHz CH-Middle

Harmonic	Frequency (MHz)	SG (dBm)	Cable Loss (dB)	Gain (dBi)	Antenna Polarization	ERP Level (dBm)	Limit (dBm)	Margin (dB)	Azimuth (deg)
2	1664.40	-59.48	1.70	8.70	Horizontal	-54.63	-13.00	41.63	315
3	2496.60	-46.13	2.30	12.00	Horizontal	-38.58	-13.00	25.58	90
4	3346.00	-65.14	2.70	12.70	Horizontal	-57.29	-13.00	44.29	135
5	4182.50	-57.74	3.00	12.50	Horizontal	-50.39	-13.00	37.39	0
6	5019.00	-57.40	3.40	12.50	Horizontal	-50.45	-13.00	37.45	90
7	5855.50	-59.78	3.40	12.80	Horizontal	-52.53	-13.00	39.53	45
8	6692.00	-57.01	4.10	11.50	Horizontal	-51.76	-13.00	38.76	315
9	7528.50	-53.99	4.20	12.20	Horizontal	-48.14	-13.00	35.14	225
10	8365.00	-54.32	4.30	12.50	Horizontal	-48.27	-13.00	35.27	180

Note: 1.The other Spurious RF Radiated emissions level is no more than noise floor.

2.The worst emission was found in the antenna is Horizontal position.

6. Main Test Instruments

Name	Manufacturer	Type	Serial Number	Calibration Date	Expiration Date
Base Station Simulator	R&S	CMW500	113824	2020-05-18	2021-05-17
Power Splitter	Hua Xiang	SHX-GF2-2-13	10120101	/	/
Spectrum Analyzer	Key sight	N9010A	MY50210259	2020-05-18	2021-05-17
Universal Radio Communication Tester	Key sight	E5515C	MY48367192	2020-05-27	2021-05-26
Signal Analyzer	R&S	FSV30	100815	2020-12-13	2021-12-12
Loop Antenna	SCHWARZBECK	FMZB1519	1519-047	2020-04-02	2023-04-01
TRILOG Broadband Antenna	SCHWARZBECK	VULB 9163	391	2019-12-16	2021-12-15
Horn Antenna	R&S	HF907	102723	2018-08-11	2021-08-10
Horn Antenna	ETS-Lindgren	3160-09	00102643	2018-06-20	2021-06-19
Signal generator	R&S	SMB 100A	102594	2020-05-18	2021-05-17
Climatic Chamber	ESPEC	SU-242	93000506	2020-12-13	2021-12-12
Preamplifier	R&S	SCU18	102327	2020-05-18	2021-05-17
MOB COMMS DC SUPPLY	Keysight	66319D	MY43004105	2020-05-18	2021-05-17
RF Cable	Agilent	SMA 15cm	0001	2020-12-10	2021-06-11
Software	R&S	EMC32	9.26.0	/	/

*****END OF REPORT *****



ANNEX A: The EUT Appearance

The EUT Appearance are submitted separately.



ANNEX B: Test Setup Photos

The Test Setup Photos are submitted separately.



ANNEX C: Product Change Description

The Product Change Description are submitted separately.