



RF TEST REPORT

Applicant Xiaomi Communications Co., Ltd.
FCC ID 2AFZZ1119DG
Product Mobile Phone
Brand Redmi
Model 21061119DG
Report No. R2106A0482-R2
Issue Date July 24, 2021

TA Technology (Shanghai) Co., Ltd. tested the above equipment in accordance with the requirements in **FCC CFR47 Part 2 (2020)/ FCC CFR 47 Part 24E (2020)**. The test results show that the equipment tested is capable of demonstrating compliance with the requirements as documented in this report.

Prepared by: Peng Tao

Approved by: Kai Xu

TA Technology (Shanghai) Co., Ltd.

No.145, Jintang Rd, Tangzhen Industry Park, Pudong Shanghai, China

TEL: +86-021-50791141/2/3

FAX: +86-021-50791141/2/3-8000



TABLE OF CONTENT

1. Test Laboratory	4
1.1. Notes of the test report	4
1.2. Test facility	4
1.3. Testing Location	4
2. General Description of Equipment under Test	5
2.3. Applicant and Manufacturer Information	5
2.4. General information	5
3. Applied Standards	7
4. Test Configuration	8
5. Test Case Results	10
5.1. RF Power Output and Effective Isotropic Radiated Power	10
5.2. Occupied Bandwidth	16
5.3. Band Edge Compliance	31
5.4. Peak-to-Average Power Ratio (PAPR)	46
5.5. Frequency Stability	50
5.6. Spurious Emissions at Antenna Terminals	56
5.7. Radiates Spurious Emission	62
6. Main Test Instruments	71
ANNEX A: The EUT Appearance	72
ANNEX B: Test Setup Photos	73



Summary of measurement results

No.	Test Case	Clause in FCC rules	Verdict
1	RF Power Output and Effective Isotropic Radiated Power	2.1046 24.232(c)	PASS
2	Occupied Bandwidth	2.1049	PASS
3	Band Edge Compliance	2.1051 /24.238(a)	PASS
4	Peak-to-Average Power Ratio	24.232/KDB 971168 D01(5.7)	PASS
5	Frequency Stability	2.1055 / 24.235	PASS
6	Spurious Emissions at Antenna Terminals	2.1051 / 24.238(a)	PASS
7	Radiates Spurious Emission	2.1053 / 24.238(a)	PASS

Date of Testing: June 26, 2021 ~ July 8, 2021
Date of Sample Received: June 22, 2021

Note: PASS: The EUT complies with the essential requirements in the standard.
FAIL: The EUT does not comply with the essential requirements in the standard.

All indications of Pass/Fail in this report are opinions expressed by TA Technology (Shanghai) Co., Ltd. based on interpretations and/or observations of test results. Measurement Uncertainties were not taken into account and are published for informational purposes only.



1. Test Laboratory

1.1. Notes of the test report

This report shall not be reproduced in full or partial, without the written approval of **TA technology (shanghai) co., Ltd.** The results documented in this report apply only to the tested sample, under the conditions and modes of operation as described herein. Measurement Uncertainties were not taken into account and are published for informational purposes only. This report is written to support regulatory compliance of the applicable standards stated above.

1.2. Test facility

FCC (Designation number: CN1179, Test Firm Registration Number: 446626)

TA Technology (Shanghai) Co., Ltd. has been listed on the US Federal Communications Commission list of test facilities recognized to perform measurements.

A2LA (Certificate Number: 3857.01)

TA Technology (Shanghai) Co., Ltd. has been listed by American Association for Laboratory Accreditation to perform measurement.

1.3. Testing Location

Company: TA Technology (Shanghai) Co., Ltd.
Address: No.145, Jintang Rd, Tangzhen Industry Park, Pudong
City: Shanghai
Post code: 201201
Country: P. R. China
Contact: Xu Kai
Telephone: +86-021-50791141/2/3
Fax: +86-021-50791141/2/3-8000
Website: <http://www.ta-shanghai.com>
E-mail: xukai@ta-shanghai.com

2. General Description of Equipment under Test

2.3. Applicant and Manufacturer Information

Applicant	Xiaomi Communications Co., Ltd.
Applicant address	#019, 9th Floor, Building 6, 33 Xi'erqi Middle Road, Haidian District, Beijing, China, 100085
Manufacturer	Xiaomi Communications Co., Ltd.
Manufacturer address	#019, 9th Floor, Building 6, 33 Xi'erqi Middle Road, Haidian District, Beijing, China, 100085

2.4. General information

EUT Description			
Model	21061119DG		
IMEI	IMEI 868393050034644 IMEI 868393050034651		
Hardware Version	P1.1		
Software Version	MIUI12.5		
Power Supply	Battery / AC adapter		
Antenna Type	PIFA Antenna		
Memory	4G+64G; 6G+128G; 4G+128G		
Antenna Gain		Main Antenna	Second Antenna
	GSM 1900:	0 dBi	-0.4dBi
	WCDMA Band II:	0 dBi	-0.4 dBi
	LTE Band 2:	0 dBi	-0.4 dBi
Test Mode(s)	GSM1900; WCDMA Band II; LTE Band 2;		
Test Modulation	(GSM/GPRS)GMSK, (EGPRS) GMSK/ 8PSK; (WCDMA) BPSK, QPSK,16QAM; (LTE)QPSK,16QAM		
GPRS Multislot Class	12		
EGPRS Multislot Class	12		
HSDPA UE Category	24		
HSUPA UE Category	7		
LTE Category	7		
Maximum E.I.R.P	GSM 1900:	29.49 dBm	
	WCDMA Band II:	23.92 dBm	
	LTE Band 2:	24.59 dBm	
Rated Power Supply Voltage	3.87V		
Operating Voltage	Minimum: 3.6V Maximum: 4.45V		
Operating Temperature	Lowest: 0°C Highest: +40°C		



Extreme Temperature	Lowest: -30°C Highest: +50°C		
Operating Frequency Range(s)	Band	Tx (MHz)	Rx (MHz)
	GSM1900	1850 ~ 1910	1930 ~ 1990
	WCDMA Band II	1850 ~ 1910	1930 ~ 1990
	LTE Band 2	1850 ~ 1910	1930 ~ 1990
Note: 1. The EUT is sent from the applicant to TA and the information of the EUT is declared by the applicant.			



3. Applied Standards

According to the specifications of the manufacturer, it must comply with the requirements of the following standards:

Test standards:

FCC CFR 47 Part 24E (2020)

ANSI C63.26 (2015)

Reference standard:

FCC CFR47 Part 2 (2020)

KDB 971168 D01 Power Meas License Digital Systems v03r01

4. Test Configuration

There is more than one SIM card slot, each one should be applied throughout the compliance test respectively, and however, only the worst case (SIM 1) will be recorded in this report.

Radiated measurements are performed by rotating the EUT in three different orthogonal test planes. EUT stand-up position (Z axis), lie-down position (X, Y axis). Receiver antenna polarization (horizontal and vertical), the worst emission was found in position (Z axis, horizontal polarization) and the worst case was recorded.

All mode and data rates and positions and RB size and modulations were investigated. Subsequently, only the worst case emissions are reported.

The following testing in GSM/WCDMA/LTE is set based on the maximum RF Output Power.

Test modes are chosen to be reported as the worst case configuration below:

Test items	Modes/Modulation	
	GSM 1900	WCDMA Band II
RF Power Output and Effective Isotropic Radiated Power	GSM GPRS EGPRS	RMC HSDPA/HSUPA DC-HSDPA/HSPA+
Occupied Bandwidth	GSM GPRS(1Tx slot) EGPRS(1Tx slot)	RMC
Band Edge Compliance	GSM GPRS(1Tx slot) EGPRS(1Tx slot)	RMC
Peak-to-Average Power Ratio	GSM GPRS(1Tx slot) EGPRS(1Tx slot)	RMC
Frequency Stability	GSM GPRS(1Tx slot) EGPRS(1Tx slot)	RMC
Spurious Emissions at Antenna Terminals	GSM	RMC
Radiates Spurious Emission	GSM	RMC



Test modes are chosen to be reported as the worst case configuration below for LTE Band 2

Test items	Bandwidth (MHz)						Modulation		RB			Test Channel		
	1.4	3	5	10	15	20	QPSK	16QAM/ 64QAM	1	50%	100%	L	M	H
RF Power Output and Effective Isotropic Radiated Power	O	O	O	O	O	O	O	O	O	O	O	O	O	O
Occupied Bandwidth	O	O	O	O	O	O	O	O	-	-	O	O	O	O
Band Edge Compliance	O	O	O	O	O	O	O	O	O	-	O	O	-	O
Peak-to-Average Power Ratio	O	O	O	O	O	O	O	O	-	-	O	O	O	O
Frequency Stability	O	O	O	O	O	O	O	O	O	-	-	-	O	-
Spurious Emissions at Antenna Terminals	O	O	O	O	O	O	O	-	O	-	-	O	O	O
Radiates Spurious Emission	O	-	O	-	-	O	O	-	O	-	-	-	O	-
Note	1. The mark "O" means that this configuration is chosen for testing. 2. The mark "-" means that this configuration is not testing.													

5. Test Case Results

5.1.RF Power Output and Effective Isotropic Radiated Power

Ambient condition

Temperature	Relative humidity	Pressure
23°C ~25°C	45%~50%	101.5kPa

Methods of Measurement

During the process of the testing, The EUT was connected to the Base Station Simulator with a known loss. The EUT is controlled by the Base Station Simulator test set to ensure max power transmission with proper modulation.

ERP can then be calculated as follows:

$$\text{EIRP (dBm)} = \text{Output Power (dBm)} - \text{Losses (dB)} + \text{Antenna Gain (dBi)}$$

where:dBd refers to gain relative to an ideal dipole.

$$\text{EIRP (dBm)} = \text{ERP (dBm)} + 2.15 \text{ (dB.)}$$

Test Setup

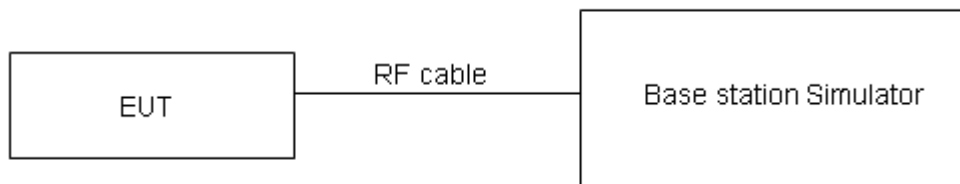

Limits

No specific RF power output requirements in part 2.1046.

Rule Part 24.232(c) Mobile and portable stations are limited to 2 watts EIRP.

Rule Part 24.232(e) Peak transmit power must be measured over any interval of continuous transmission using instrumentation calibrated in terms of an rms-equivalent voltage.

Limit	$\leq 2 \text{ W}$ (33 dBm)
-------	-----------------------------

Measurement Uncertainty

The assessed measurement uncertainty to ensure 95% confidence level for the normal distribution is with the coverage factor $k = 2$, $U = 0.4 \text{ dB}$ for RF power output, $k = 2$, $U = 1.19 \text{ dB}$ for EIRP.



Test Results

GSM 1900		Maximum Output Power (dBm)			EIRP (dBm) (Main antenna)			EIRP (dBm) (Second antenna)		
		Channel 512	Channel 661	Channel 810	Channel 512	Channel 661	Channel 810	Channel 512	Channel 661	Channel 810
		1850.2 (MHz)	1880 (MHz)	1909.8 (MHz)	1850.2 (MHz)	1880 (MHz)	1909.8 (MHz)	1850.2 (MHz)	1880 (MHz)	1909.8 (MHz)
GSM	Results	29.49	29.30	29.20	29.49	29.30	29.20	29.09	28.90	28.80
GPRS/EGPRS (GMSK)	1TXslot	29.49	29.29	29.20	29.49	29.29	29.20	29.09	28.89	28.80
	2TXslots	28.77	28.58	28.53	28.77	28.58	28.53	28.37	28.18	28.13
	3TXslots	27.03	26.83	26.81	27.03	26.83	26.81	26.63	26.43	26.41
	4TXslots	25.96	25.77	25.75	25.96	25.77	25.75	25.56	25.37	25.35
EGPRS (8PSK)	1TXslot	26.08	25.93	25.88	26.08	25.93	25.88	25.68	25.53	25.48
	2TXslots	24.89	24.65	24.67	24.89	24.65	24.67	24.49	24.25	24.27
	3TXslots	22.79	22.44	22.61	22.79	22.44	22.61	22.39	22.04	22.21
	4TXslots	21.36	21.34	21.32	21.36	21.34	21.32	20.96	20.94	20.92

WCDMA Band II		Maximum Output Power (dBm)			EIRP (dBm) (Main antenna)			EIRP (dBm) (Second antenna)		
		Channel 9262	Channel 9400	Channel 9538	Channel 9262	Channel 9400	Channel 9538	Channel 9262	Channel 9400	Channel 9538
		1852.4 (MHz)	1880 (MHz)	1907.6 (MHz)	1852.4 (MHz)	1880 (MHz)	1907.6 (MHz)	1852.4 (MHz)	1880 (MHz)	1907.6 (MHz)
RMC		23.92	23.90	23.88	23.92	23.90	23.88	23.52	23.50	23.48
AMR		23.76	23.73	23.73	23.76	23.73	23.73	23.36	23.33	23.33
HSDPA	Subtest 1	23.34	23.32	23.30	23.34	23.32	23.30	22.94	22.92	22.90
	Subtest 2	23.33	23.31	23.29	23.33	23.31	23.29	22.93	22.91	22.89
	Subtest 3	22.82	22.80	22.78	22.82	22.80	22.78	22.42	22.40	22.38
	Subtest 4	22.81	22.79	22.77	22.81	22.79	22.77	22.41	22.39	22.37
HSUPA	Subtest 1	23.30	23.28	23.26	23.30	23.28	23.26	22.90	22.88	22.86
	Subtest 2	22.29	22.27	22.25	22.29	22.27	22.25	21.89	21.87	21.85
	Subtest 3	22.77	22.76	22.74	22.77	22.76	22.74	22.37	22.36	22.34
	Subtest 4	22.26	22.25	22.23	22.26	22.25	22.23	21.86	21.85	21.83
	Subtest 5	23.25	23.24	23.22	23.25	23.24	23.22	22.85	22.84	22.82
DC-HSDPA	Subtest 1	23.26	23.26	23.22	23.26	23.26	23.22	22.86	22.86	22.82
	Subtest 2	23.25	23.25	23.21	23.25	23.25	23.21	22.85	22.85	22.81
	Subtest 3	22.83	22.74	22.72	22.83	22.74	22.72	22.43	22.34	22.32
	Subtest 4	22.82	22.73	22.71	22.82	22.73	22.71	22.42	22.33	22.31
HSPA+	16QAM	22.81	22.81	22.79	22.81	22.81	22.79	22.41	22.41	22.39



LTE Band 2				Maximum Output Power(dBm)			EIRP (dBm) (Main antenna)			EIRP (dBm) (Second antenna)		
BW	Modulation	RB size	RB offset	Channel/Frequency(MHz)								
				18607/1850.7	18900/1880	19193/1909.3	18607/1850.7	18900/1880	19193/1909.3	18607/1850.7	18900/1880	19193/1909.3
1.4MHz	QPSK	1	0	24.36	24.20	24.12	24.36	24.20	24.12	23.96	23.80	23.72
		1	2	24.59	24.38	24.52	24.59	24.38	24.52	24.19	23.98	24.12
		1	5	24.44	24.19	24.41	24.44	24.19	24.41	24.04	23.79	24.01
		3	0	24.26	24.20	24.27	24.26	24.20	24.27	23.86	23.80	23.87
		3	2	24.19	24.28	24.33	24.19	24.28	24.33	23.79	23.88	23.93
		3	3	24.17	24.20	24.32	24.17	24.20	24.32	23.77	23.80	23.92
		6	0	23.25	23.27	23.40	23.25	23.27	23.40	22.85	22.87	23.00
	16QAM	1	0	23.67	23.35	23.35	23.67	23.35	23.35	23.27	22.95	22.95
		1	2	23.65	23.55	23.66	23.65	23.55	23.66	23.25	23.15	23.26
		1	5	23.38	23.46	23.35	23.38	23.46	23.35	22.98	23.06	22.95
		3	0	23.27	23.11	23.30	23.27	23.11	23.30	22.87	22.71	22.90
		3	2	23.29	23.26	23.32	23.29	23.26	23.32	22.89	22.86	22.92
		3	3	23.19	23.25	23.27	23.19	23.25	23.27	22.79	22.85	22.87
		6	0	22.27	22.26	22.43	22.27	22.26	22.43	21.87	21.86	22.03
	64QAM	1	0	22.35	22.27	22.33	22.35	22.27	22.33	21.95	21.87	21.93
		1	2	22.22	22.16	22.33	22.22	22.16	22.33	21.82	21.76	21.93
		1	5	22.25	22.35	22.24	22.25	22.35	22.24	21.85	21.95	21.84
		3	0	22.30	22.20	22.31	22.30	22.20	22.31	21.90	21.80	21.91
		3	2	22.29	22.27	22.35	22.29	22.27	22.35	21.89	21.87	21.95
		3	3	22.32	22.21	22.40	22.32	22.21	22.40	21.92	21.81	22.00
		6	0	21.32	21.32	21.55	21.32	21.32	21.55	20.92	20.92	21.15
BW	Modulation	RB size	RB offset	Channel/Frequency(MHz)								
				18615/1851.5	18900/1880	19185/1908.5	18615/1851.5	18900/1880	19185/1908.5	18615/1851.5	18900/1880	19185/1908.5
3MHz	QPSK	1	0	24.38	24.24	24.15	24.38	24.24	24.15	23.98	23.84	23.75
		1	7	24.57	24.41	24.56	24.57	24.41	24.56	24.17	24.01	24.16
		1	14	24.47	24.24	24.45	24.47	24.24	24.45	24.07	23.84	24.05
		8	0	23.36	23.32	23.40	23.36	23.32	23.40	22.96	22.92	23.00
		8	4	23.31	23.38	23.45	23.31	23.38	23.45	22.91	22.98	23.05
		8	7	23.27	23.31	23.42	23.27	23.31	23.42	22.87	22.91	23.02
		15	0	23.25	23.31	23.43	23.25	23.31	23.43	22.85	22.91	23.03
	16QAM	1	0	23.70	23.37	23.38	23.70	23.37	23.38	23.30	22.97	22.98



		1	7	23.68	23.55	23.70	23.68	23.55	23.70	23.28	23.15	23.30
		1	14	23.40	23.50	23.38	23.40	23.50	23.38	23.00	23.10	22.98
		8	0	22.38	22.24	22.42	22.38	22.24	22.42	21.98	21.84	22.02
		8	4	22.40	22.39	22.44	22.40	22.39	22.44	22.00	21.99	22.04
		8	7	22.29	22.37	22.40	22.29	22.37	22.40	21.89	21.97	22.00
		15	0	22.30	22.30	22.46	22.30	22.30	22.46	21.90	21.90	22.06
	64QAM	1	0	22.38	22.29	22.36	22.38	22.29	22.36	21.98	21.89	21.96
		1	7	22.25	22.16	22.35	22.25	22.16	22.35	21.85	21.76	21.95
		1	14	22.27	22.34	22.27	22.27	22.34	22.27	21.87	21.94	21.87
		8	0	21.41	21.33	21.43	21.41	21.33	21.43	21.01	20.93	21.03
		8	4	21.40	21.40	21.47	21.40	21.40	21.47	21.00	21.00	21.07
		8	7	21.42	21.33	21.53	21.42	21.33	21.53	21.02	20.93	21.13
		15	0	21.35	21.36	21.58	21.35	21.36	21.58	20.95	20.96	21.18
	BW	Modulation	RB size	RB offset	Channel/Frequency(MHz)							
18625/ 1852.5					18900/ 1880	19175/ 1907.5	18625/ 1852.5	18900/ 1880	19175/ 1907.5	18625/ 1852.5	18900/ 1880	19175/ 1907.5
5MHz	QPSK	1	0	24.35	24.22	24.11	24.35	24.22	24.11	23.95	23.82	23.71
		1	13	24.55	24.37	24.53	24.55	24.37	24.53	24.15	23.97	24.13
		1	24	24.44	24.19	24.41	24.44	24.19	24.41	24.04	23.79	24.01
		12	0	23.33	23.27	23.36	23.33	23.27	23.36	22.93	22.87	22.96
		12	6	23.29	23.34	23.40	23.29	23.34	23.40	22.89	22.94	23.00
		12	13	23.25	23.29	23.38	23.25	23.29	23.38	22.85	22.89	22.98
		25	0	23.25	23.30	23.41	23.25	23.30	23.41	22.85	22.90	23.01
	16QAM	1	0	23.67	23.33	23.35	23.67	23.33	23.35	23.27	22.93	22.95
		1	13	23.65	23.53	23.67	23.65	23.53	23.67	23.25	23.13	23.27
		1	24	23.37	23.48	23.34	23.37	23.48	23.34	22.97	23.08	22.94
		12	0	22.36	22.20	22.39	22.36	22.20	22.39	21.96	21.80	21.99
		12	6	22.37	22.34	22.40	22.37	22.34	22.40	21.97	21.94	22.00
		12	13	22.26	22.32	22.36	22.26	22.32	22.36	21.86	21.92	21.96
		25	0	22.28	22.26	22.41	22.28	22.26	22.41	21.88	21.86	22.01
	64QAM	1	0	22.35	22.29	22.33	22.35	22.29	22.33	21.95	21.89	21.93
		1	13	22.22	22.18	22.32	22.22	22.18	22.32	21.82	21.78	21.92
		1	24	22.28	22.32	22.23	22.28	22.32	22.23	21.88	21.92	21.83
		12	0	21.39	21.29	21.44	21.39	21.29	21.44	20.99	20.89	21.04
		12	6	21.37	21.35	21.43	21.37	21.35	21.43	20.97	20.95	21.03
		12	13	21.39	21.28	21.49	21.39	21.28	21.49	20.99	20.88	21.09
		25	0	21.33	21.32	21.53	21.33	21.32	21.53	20.93	20.92	21.13



BW	Modulation	RB size	RB offset	Channel/Frequency(MHz)								
				18650/1855	18900/1880	19150/1905	18650/1855	18900/1880	19150/1905	18650/1855	18900/1880	19150/1905
10MHz	QPSK	1	0	24.37	24.23	24.14	24.37	24.23	24.14	23.97	23.83	23.74
		1	25	24.58	24.42	24.57	24.58	24.42	24.57	24.18	24.02	24.17
		1	49	24.46	24.23	24.44	24.46	24.23	24.44	24.06	23.83	24.04
		25	0	23.36	23.32	23.40	23.36	23.32	23.40	22.96	22.92	23.00
		25	13	23.32	23.39	23.44	23.32	23.39	23.44	22.92	22.99	23.04
		25	25	23.27	23.33	23.43	23.27	23.33	23.43	22.87	22.93	23.03
		50	0	23.29	23.32	23.45	23.29	23.32	23.45	22.89	22.92	23.05
	16QAM	1	0	23.69	23.36	23.37	23.69	23.36	23.37	23.29	22.96	22.97
		1	25	23.68	23.57	23.70	23.68	23.57	23.70	23.28	23.17	23.30
		1	49	23.40	23.50	23.37	23.40	23.50	23.37	23.00	23.10	22.97
		25	0	22.39	22.25	22.43	22.39	22.25	22.43	21.99	21.85	22.03
		25	13	22.39	22.38	22.43	22.39	22.38	22.43	21.99	21.98	22.03
		25	25	22.29	22.37	22.40	22.29	22.37	22.40	21.89	21.97	22.00
		50	0	22.31	22.31	22.45	22.31	22.31	22.45	21.91	21.91	22.05
	64QAM	1	0	22.37	22.28	22.35	22.37	22.28	22.35	21.97	21.88	21.95
		1	25	22.25	22.18	22.35	22.25	22.18	22.35	21.85	21.78	21.95
		1	49	22.27	22.34	22.26	22.27	22.34	22.26	21.87	21.94	21.86
		25	0	21.42	21.34	21.44	21.42	21.34	21.44	21.02	20.94	21.04
		25	13	21.39	21.39	21.46	21.39	21.39	21.46	20.99	20.99	21.06
		25	25	21.42	21.33	21.53	21.42	21.33	21.53	21.02	20.93	21.13
		50	0	21.36	21.37	21.57	21.36	21.37	21.57	20.96	20.97	21.17
BW	Modulation	RB size	RB offset	Channel/Frequency(MHz)								
				18675/1857.5	18900/1880	19125/1902.5	18675/1857.5	18900/1880	19125/1902.5	18675/1857.5	18900/1880	19125/1902.5
15MHz	QPSK	1	0	24.36	24.19	24.12	24.36	24.19	24.12	23.96	23.79	23.72
		1	38	24.56	24.41	24.54	24.56	24.41	24.54	24.16	24.01	24.14
		1	74	24.43	24.18	24.40	24.43	24.18	24.40	24.03	23.78	24.00
		36	0	23.34	23.28	23.37	23.34	23.28	23.37	22.94	22.88	22.97
		36	18	23.29	23.34	23.40	23.29	23.34	23.40	22.89	22.94	23.00
		36	39	23.24	23.30	23.39	23.24	23.30	23.39	22.84	22.90	22.99
		75	0	23.27	23.28	23.40	23.27	23.28	23.40	22.87	22.88	23.00
	16QAM	1	0	23.64	23.34	23.35	23.64	23.34	23.35	23.24	22.94	22.95
		1	38	23.66	23.54	23.68	23.66	23.54	23.68	23.26	23.14	23.28
		1	74	23.37	23.46	23.34	23.37	23.46	23.34	22.97	23.06	22.94



		36	0	22.36	22.23	22.40	22.36	22.23	22.40	21.96	21.83	22.00
		36	18	22.36	22.33	22.39	22.36	22.33	22.39	21.96	21.93	21.99
		36	39	22.27	22.33	22.37	22.27	22.33	22.37	21.87	21.93	21.97
		75	0	22.28	22.26	22.41	22.28	22.26	22.41	21.88	21.86	22.01
	64QAM	1	0	22.32	22.26	22.33	22.32	22.26	22.33	21.92	21.86	21.93
		1	38	22.23	22.15	22.33	22.23	22.15	22.33	21.83	21.75	21.93
		1	74	22.28	22.33	22.27	22.28	22.33	22.27	21.88	21.93	21.87
		36	0	21.41	21.36	21.45	21.41	21.36	21.45	21.01	20.96	21.05
		36	18	21.37	21.36	21.45	21.37	21.36	21.45	20.97	20.96	21.05
		36	39	21.40	21.29	21.50	21.40	21.29	21.50	21.00	20.89	21.10
		75	0	21.33	21.32	21.53	21.33	21.32	21.53	20.93	20.92	21.13
BW	Modulation	RB size	RB offset	Channel/Frequency(MHz)								
				18700/1860	18900/1880	19100/1900	18700/1860	18900/1880	19100/1900	18700/1860	18900/1880	19100/1900
20MHz	QPSK	1	0	24.33	24.15	24.09	24.33	24.15	24.09	23.93	23.75	23.69
		1	50	24.55	24.37	24.52	24.55	24.37	24.52	24.15	23.97	24.12
		1	99	24.41	24.17	24.37	24.41	24.17	24.37	24.01	23.77	23.97
		50	0	23.31	23.23	23.33	23.31	23.23	23.33	22.91	22.83	22.93
		50	25	23.27	23.30	23.37	23.27	23.30	23.37	22.87	22.90	22.97
		50	50	23.21	23.25	23.35	23.21	23.25	23.35	22.81	22.85	22.95
		100	0	23.24	23.23	23.36	23.24	23.23	23.36	22.84	22.83	22.96
	16QAM	1	0	23.63	23.30	23.30	23.63	23.30	23.30	23.23	22.90	22.90
		1	50	23.62	23.52	23.64	23.62	23.52	23.64	23.22	23.12	23.24
		1	99	23.35	23.43	23.32	23.35	23.43	23.32	22.95	23.03	22.92
		50	0	22.33	22.19	22.37	22.33	22.19	22.37	21.93	21.79	21.97
		50	25	22.33	22.31	22.36	22.33	22.31	22.36	21.93	21.91	21.96
		50	50	22.24	22.28	22.33	22.24	22.28	22.33	21.84	21.88	21.93
		100	0	22.26	22.22	22.38	22.26	22.22	22.38	21.86	21.82	21.98
	64QAM	1	0	22.30	22.22	22.28	22.30	22.22	22.28	21.90	21.82	21.88
		1	50	22.19	22.13	22.29	22.19	22.13	22.29	21.79	21.73	21.89
		1	99	22.22	22.27	22.21	22.22	22.27	22.21	21.82	21.87	21.81
		50	0	21.36	21.28	21.38	21.36	21.28	21.38	20.96	20.88	20.98
		50	25	21.33	21.32	21.39	21.33	21.32	21.39	20.93	20.92	20.99
		50	50	21.37	21.24	21.46	21.37	21.24	21.46	20.97	20.84	21.06
		100	0	21.31	21.28	21.50	21.31	21.28	21.50	20.91	20.88	21.10

5.2.Occupied Bandwidth

Ambient condition

Temperature	Relative humidity	Pressure
23°C ~25°C	45%~50%	101.5kPa

Method of Measurement

The EUT was connected to Spectrum Analyzer and Base Station Simulator via power Splitter. The occupied bandwidth is measured using spectrum analyzer.

RBW is set to 3kHz, VBW is set to 10kHz for GSM 1900,

RBW is set to 51 kHz, VBW is set to 160kHz for WCDMA Band II,

RBW is set to 30 kHz, VBW is set to 91kHz for LTE Band 2 (1.4MHz),

RBW is set to 62 kHz, VBW is set to 180 kHz for LTE Band 2 (3MHz),

RBW is set to 100 kHz, VBW is set to 300 kHz for LTE Band 2(5MHz),

RBW is set to 200 kHz, VBW is set to 620kHz for LTE Band 2 (10MHz),

RBW is set to 300kHz,VBW is set to 910kHz for LTE Band 2 (15MHz).

RBW is set to 430kHz,VBW is set to 1.2MHz for LTE Band 2 (20MHz).

99% power and -26dBc occupied bandwidths are recorded. Spectrum analyzer plots are included on the following pages.

Test Setup

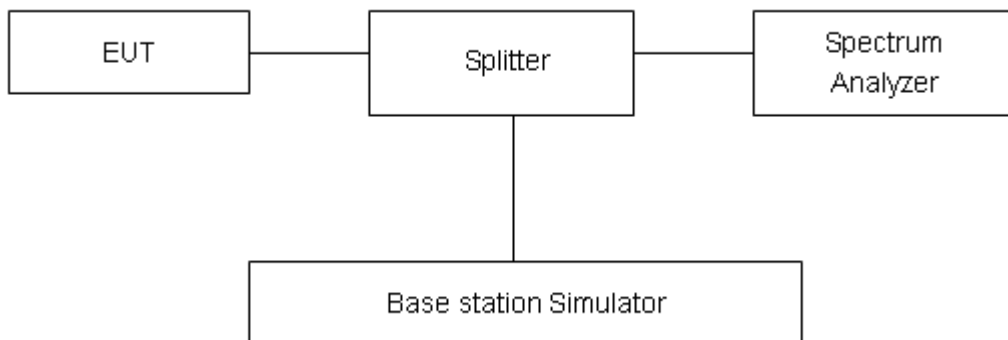

Limits

No specific occupied bandwidth requirements in part 2.1049.

Measurement Uncertainty

The assessed measurement uncertainty to ensure 95% confidence level for the normal distribution is with the coverage factor $k = 2$, $U = 624\text{Hz}$.



Test Result

Mode	Channel	Frequency (MHz)	99% Power Bandwidth (MHz)	-26dBc Bandwidth(MHz)
GSM 1900 (GMSK)	512	1850.2	0.251	0.314
	661	1880	0.246	0.316
	810	1909.8	0.247	0.308
GPRS 1900 (GMSK)	512	1850.2	0.246	0.320
	661	1880	0.247	0.305
	810	1909.8	0.247	0.312
EGPRS 1900 (8PSK)	512	1850.2	0.245	0.315
	661	1880	0.247	0.307
	810	1909.8	0.243	0.314
WCDMA Band II (RMC)	9262	1852.4	4.170	4.695
	9400	1880	4.162	4.676
	9538	1907.6	4.159	4.672

LTE Band 2					
Modulation	Bandwidth (MHz)	Channel	Frequency (MHz)	99% Power Bandwidth(MHz)	-26dBc Bandwidth(MHz)
QPSK	1.4	18607	1850.7	1.093	1.307
		18900	1880	1.094	1.290
		19193	1909.3	1.096	1.306
	3	18615	1851.5	2.683	2.912
		18900	1880	2.689	2.917
		19185	1908.5	2.689	2.926
	5	18625	1852.5	4.516	4.942
		18900	1880	4.513	4.891
		19175	1907.5	4.512	4.915
	10	18650	1855	8.983	9.706
		18900	1880	9.003	9.639
		19150	1905	8.999	9.770
	15	18675	1857.5	13.440	14.460
		18900	1880	13.483	14.530



		19125	1902.5	13.482	14.430	
	20	18700	1860	17.981	19.430	
		18900	1880	17.958	19.390	
		19100	1900	17.969	19.140	
16QAM	1.4	18607	1850.7	1.100	1.273	
		18900	1880	1.100	1.299	
		19193	1909.3	1.092	1.275	
	3	18615	1851.5	2.684	2.911	
		18900	1880	2.689	2.928	
		19185	1908.5	2.678	2.942	
	5	18625	1852.5	4.512	4.907	
		18900	1880	4.510	4.905	
		19175	1907.5	4.502	4.935	
	10	18650	1855	8.982	9.674	
		18900	1880	8.979	9.682	
		19150	1905	8.991	9.618	
	15	18675	1857.5	13.439	14.450	
		18900	1880	13.512	14.390	
		19125	1902.5	13.502	14.440	
	20	18700	1860	18.002	19.280	
		18900	1880	17.968	19.190	
		19100	1900	17.948	19.370	
	64QAM	1.4	18607	1850.7	1.100	1.281
			18900	1880	1.092	1.280
			19193	1909.3	1.090	1.261
3		18615	1851.5	2.680	2.936	
		18900	1880	2.681	2.904	
		19185	1908.5	2.691	2.891	
5		18625	1852.5	4.506	4.892	
		18900	1880	4.521	4.926	
		19175	1907.5	4.517	4.971	
10		18650	1855	9.001	9.578	
		18900	1880	8.989	9.688	
		19150	1905	8.987	9.709	



	15	18675	1857.5	13.498	14.374
		18900	1880	13.503	14.657
		19125	1902.5	13.440	14.451
	20	18700	1860	17.957	19.251
		18900	1880	17.982	19.282
		19100	1900	17.934	19.307



GSM1900 GSM CH-Low



GSM1900 GPRS CH-Low

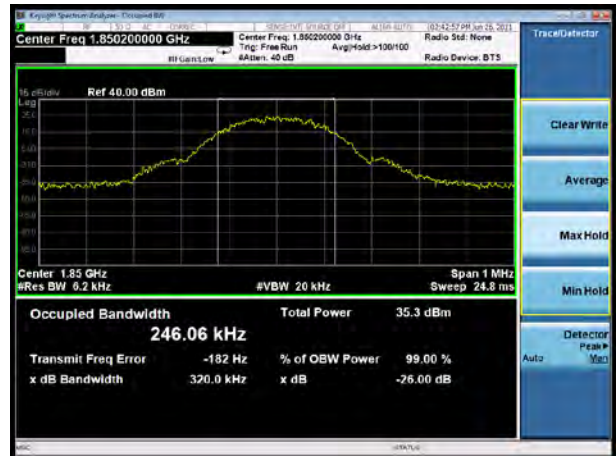

GSM 1900 GSM CH-Middle

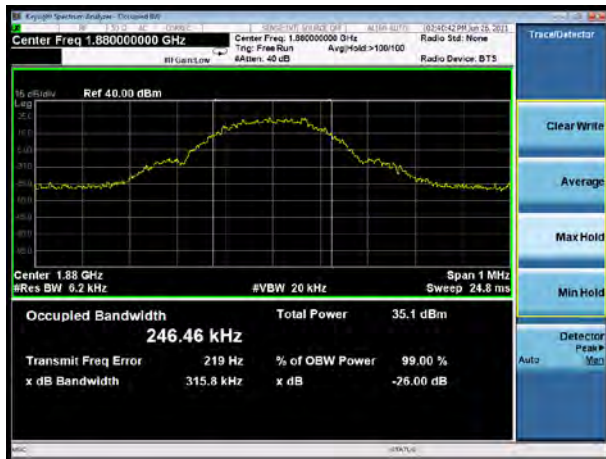

GSM 1900 GPRS CH-Middle



GSM 1900 GSM CH-High

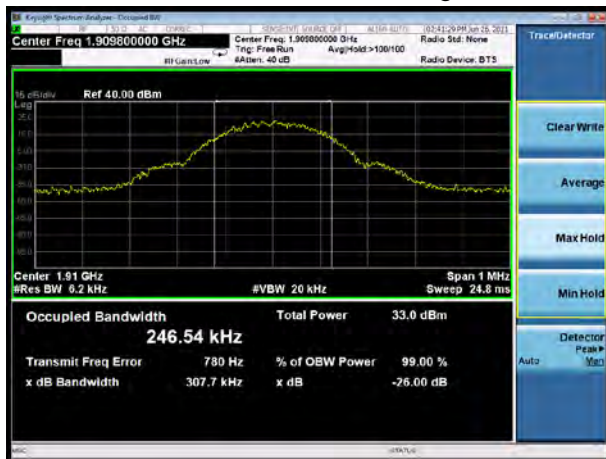

GSM 1900 GPRS CH-High

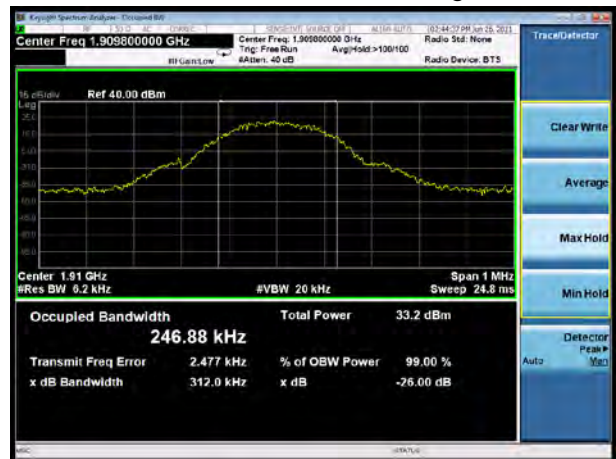

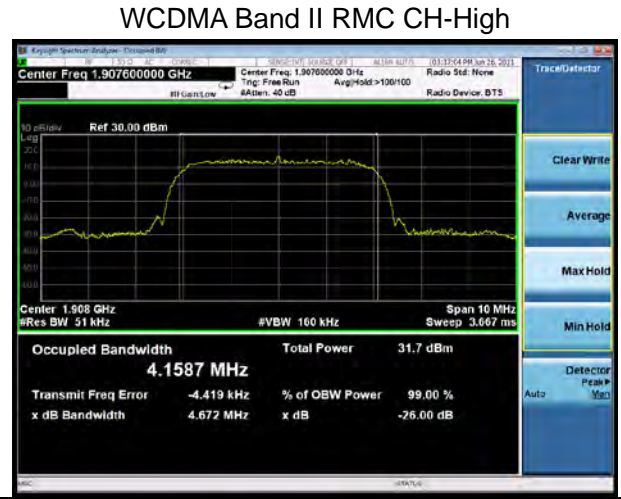
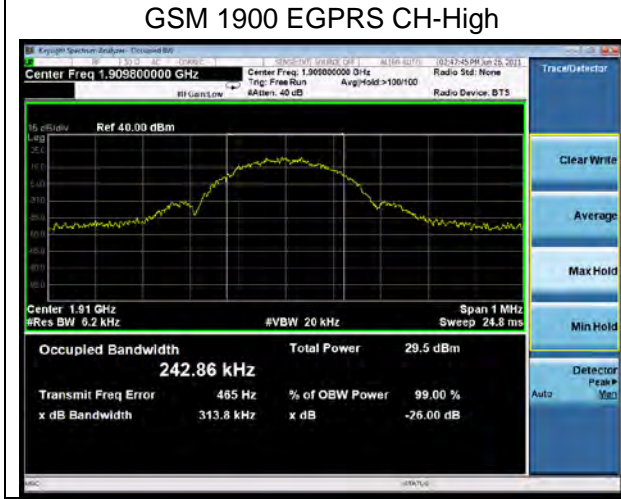
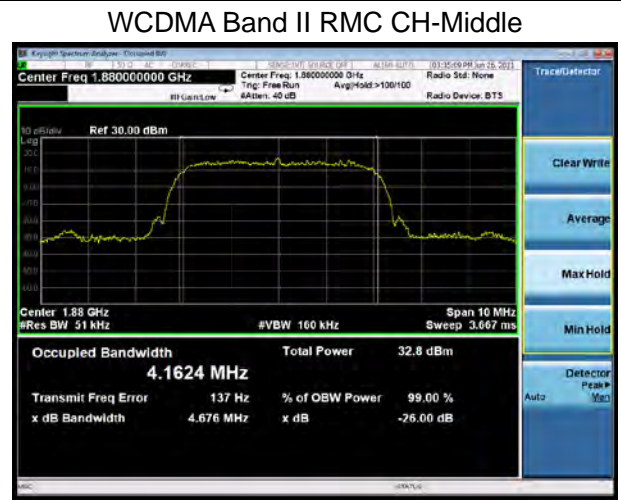
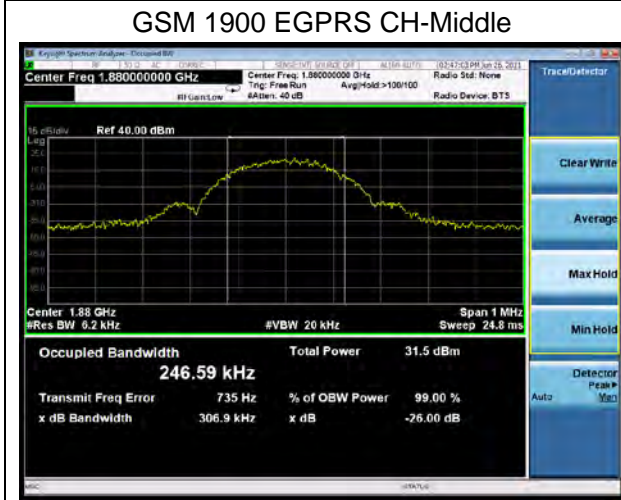
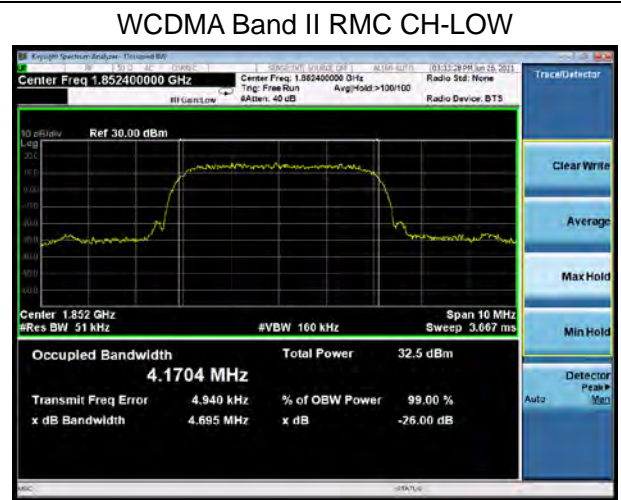
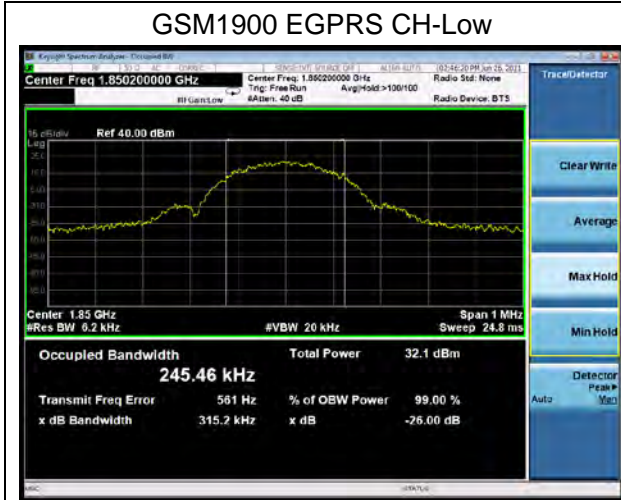

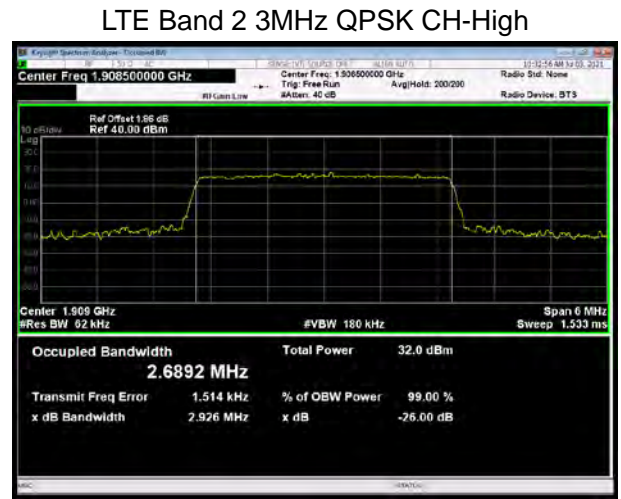
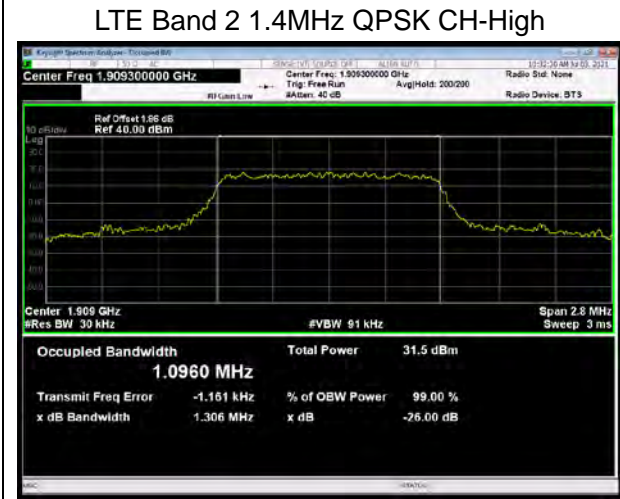
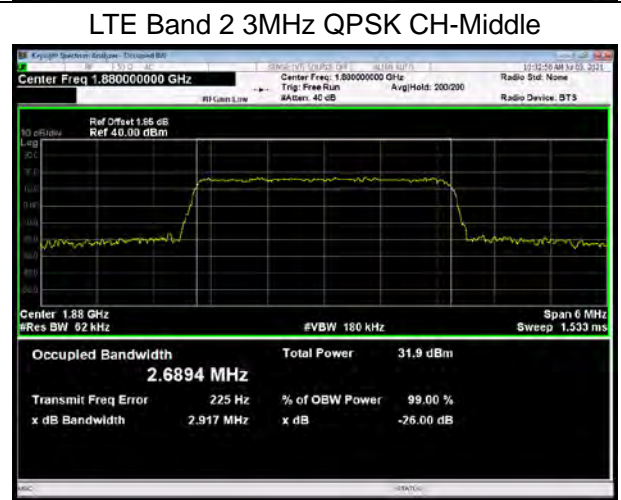
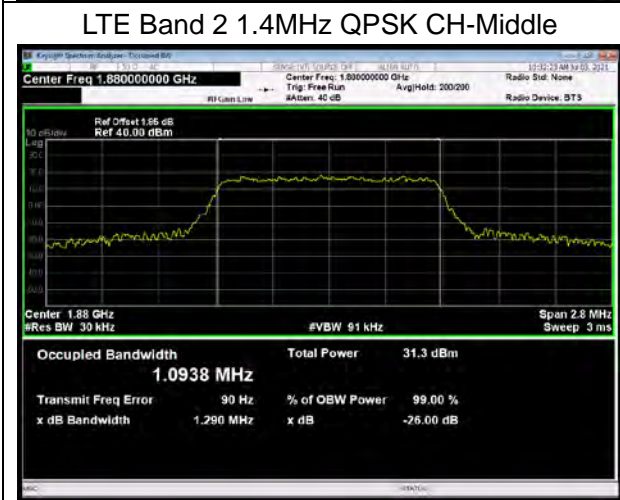
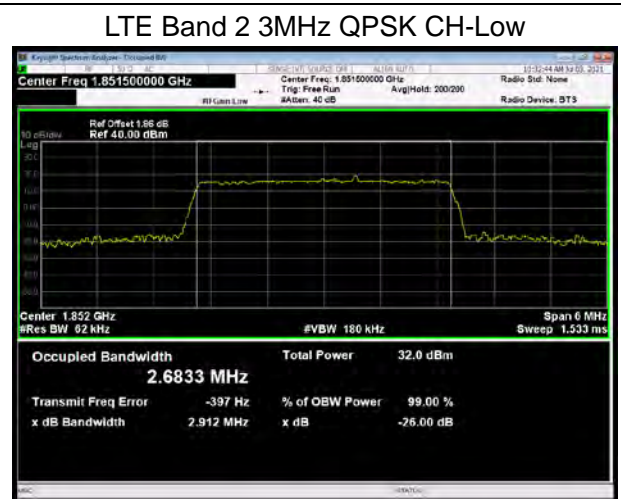
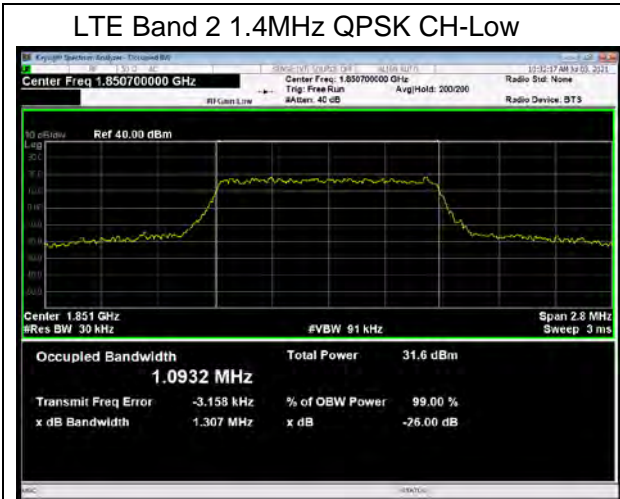

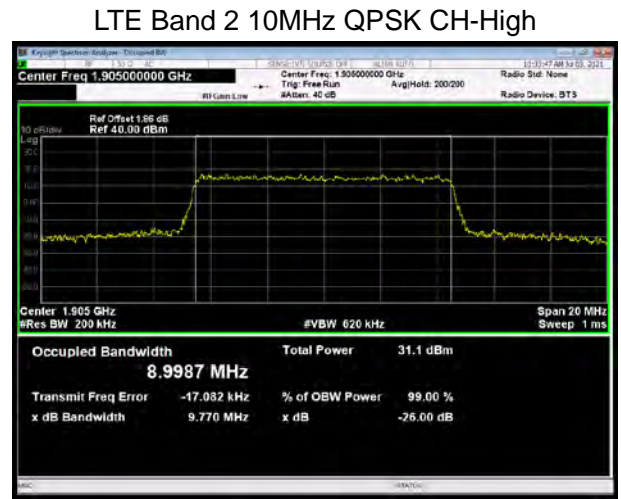
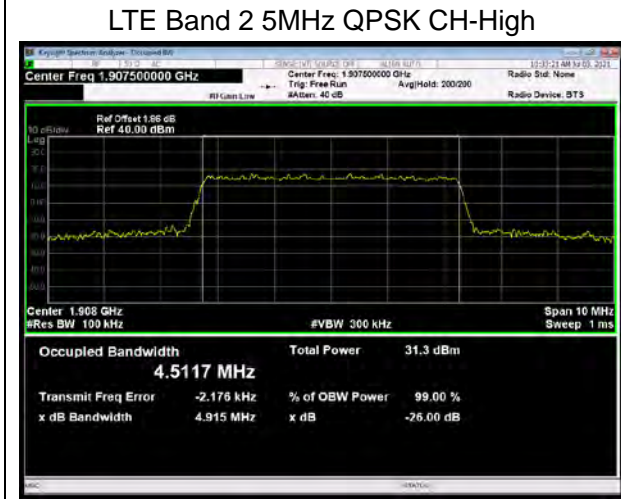
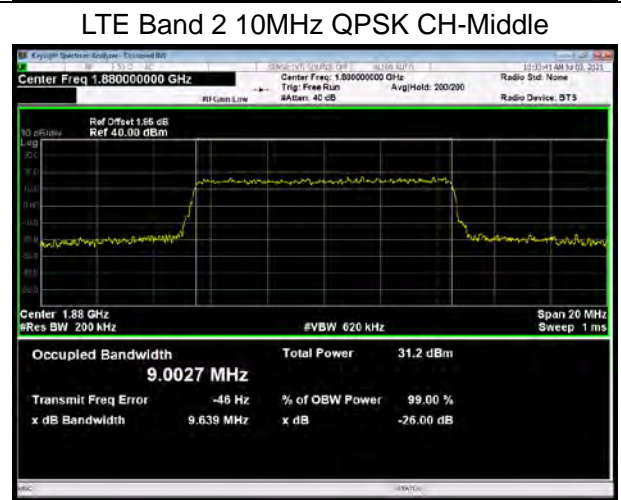
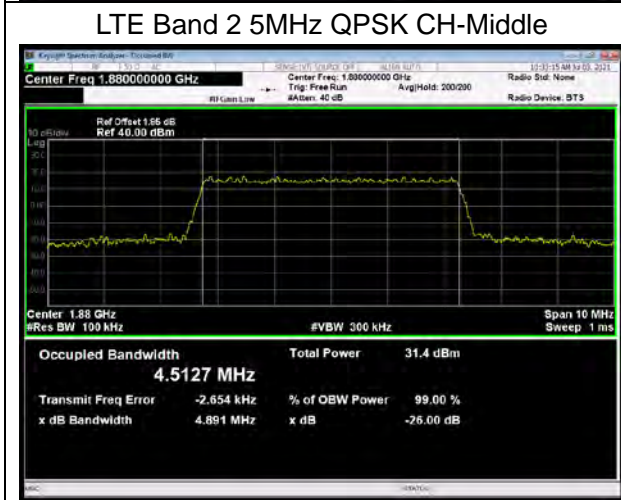
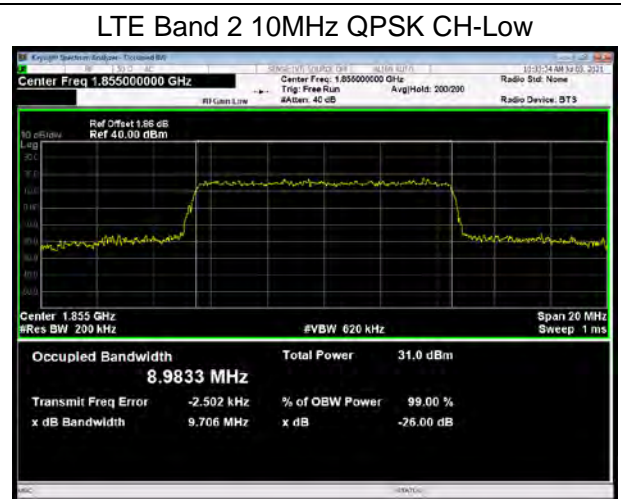
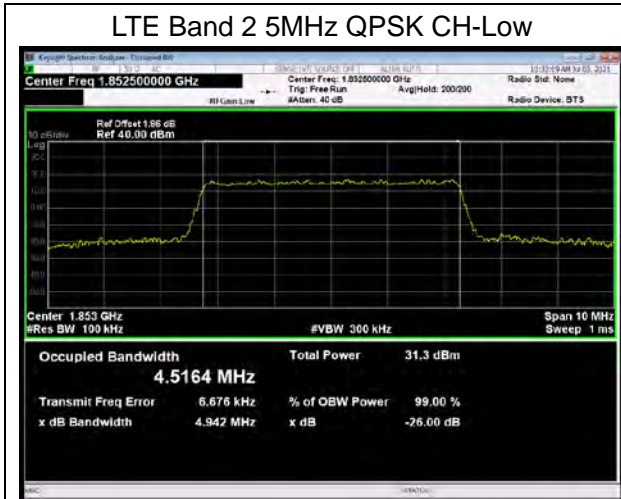

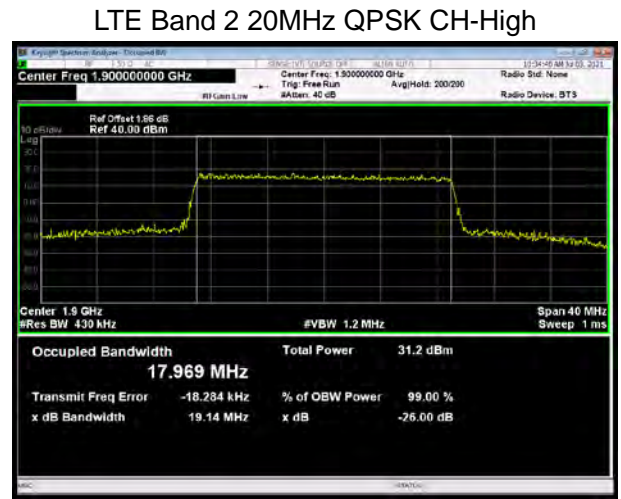
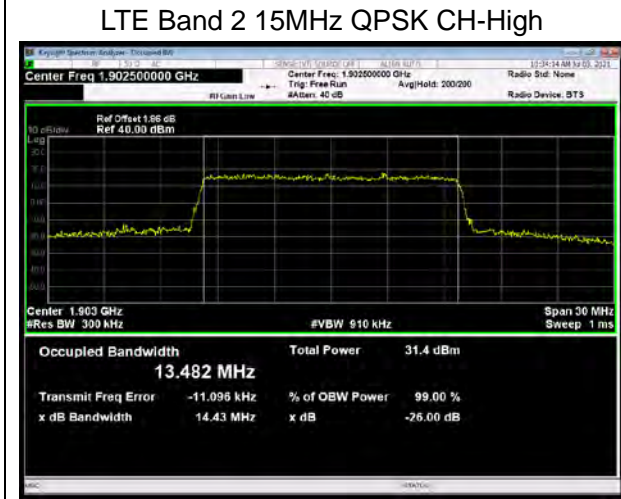
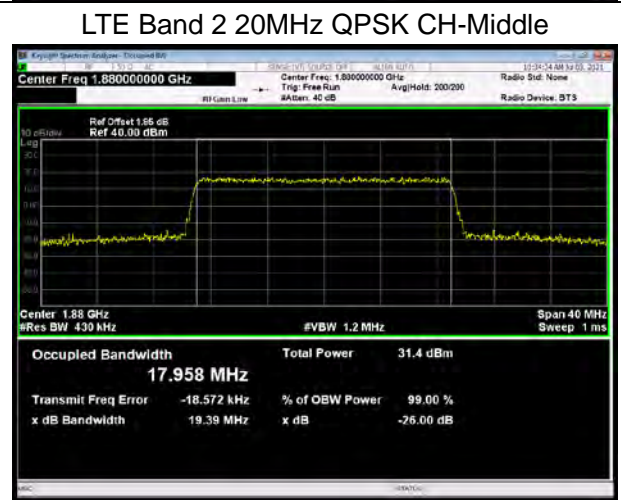
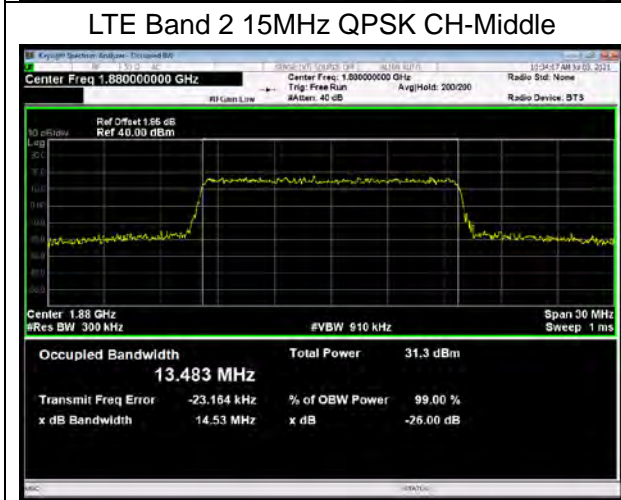
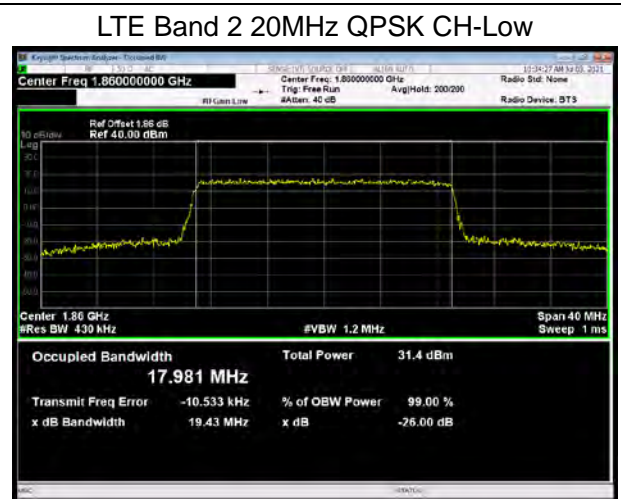
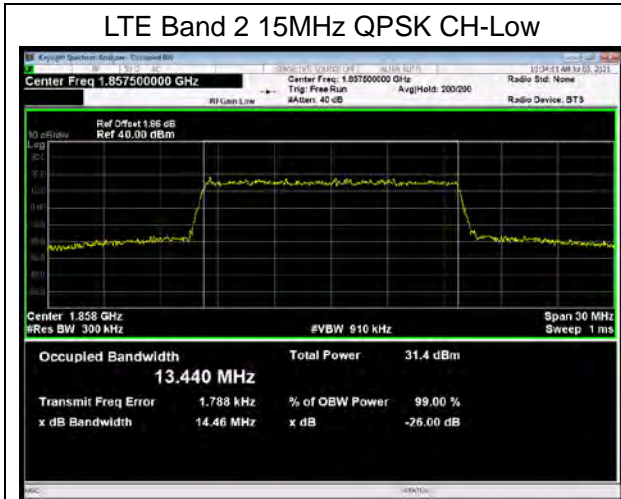

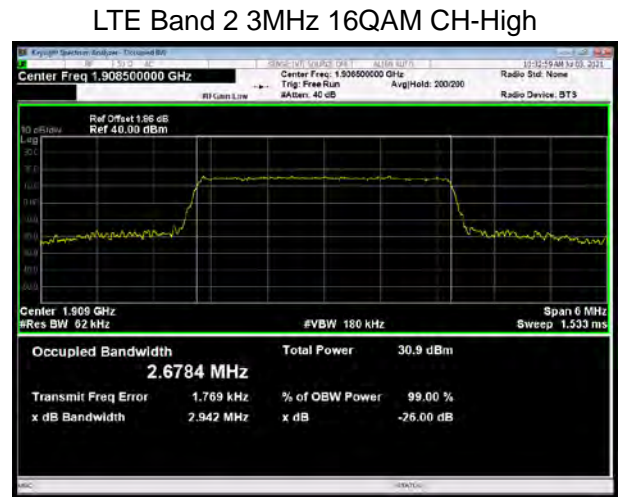
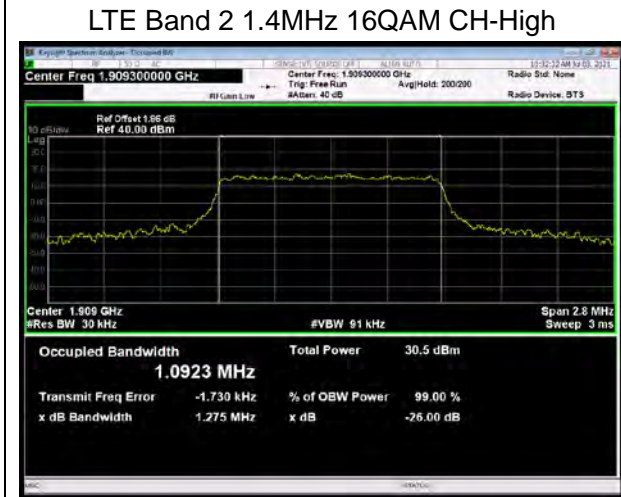
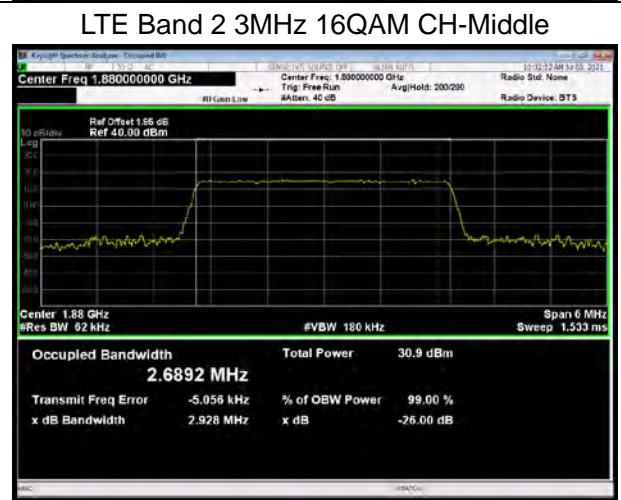
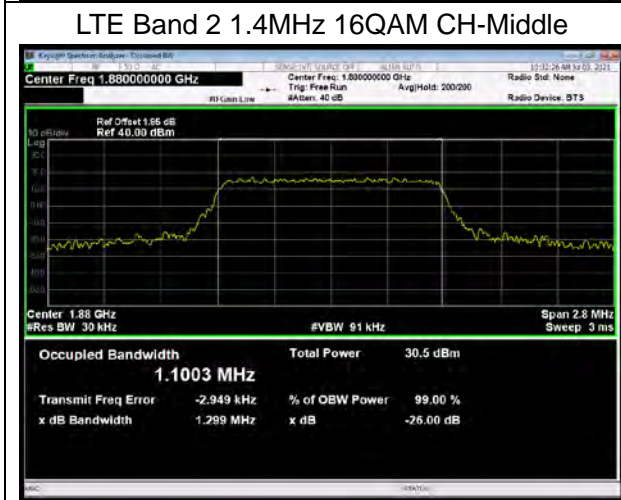
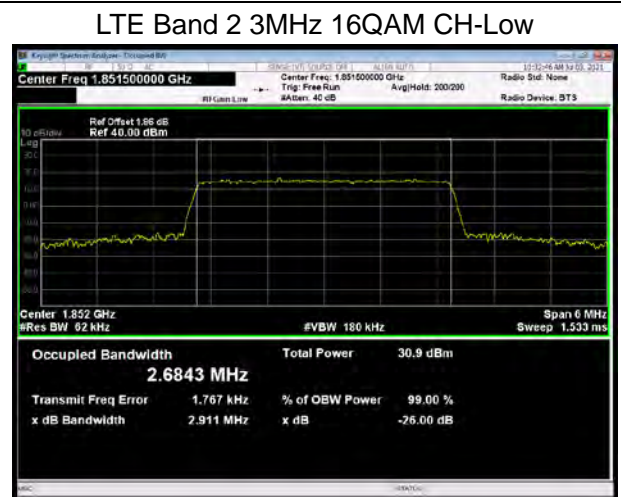
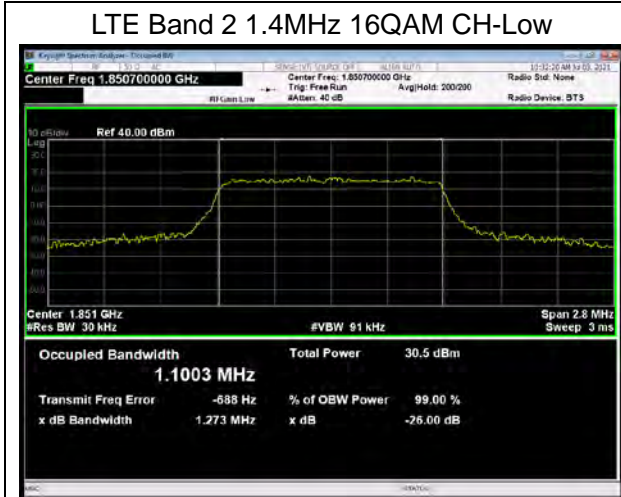

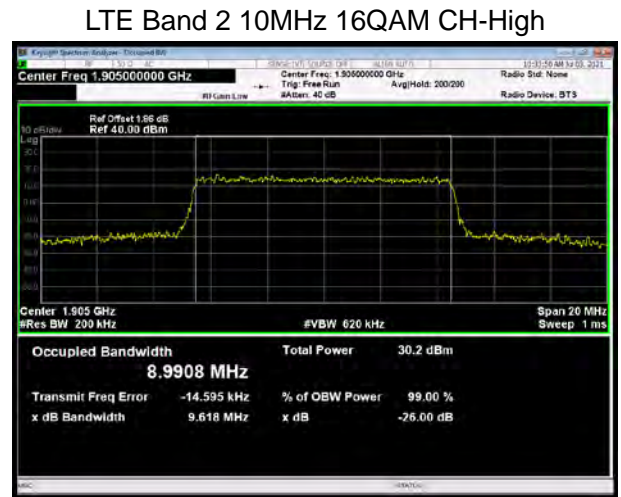
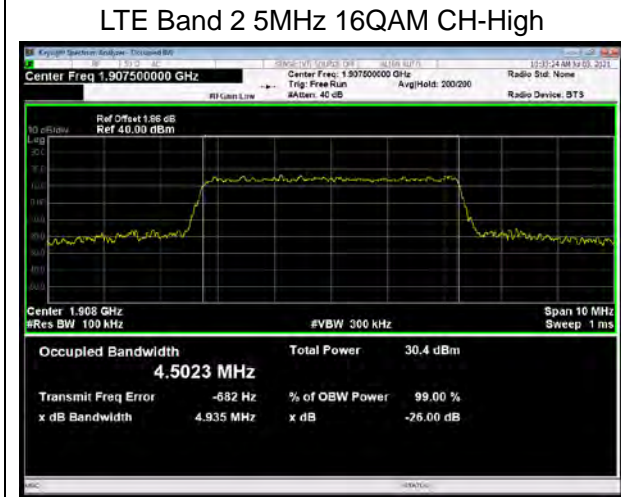
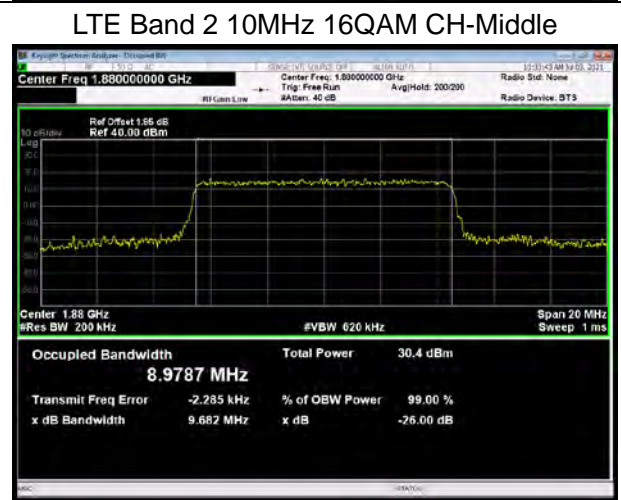
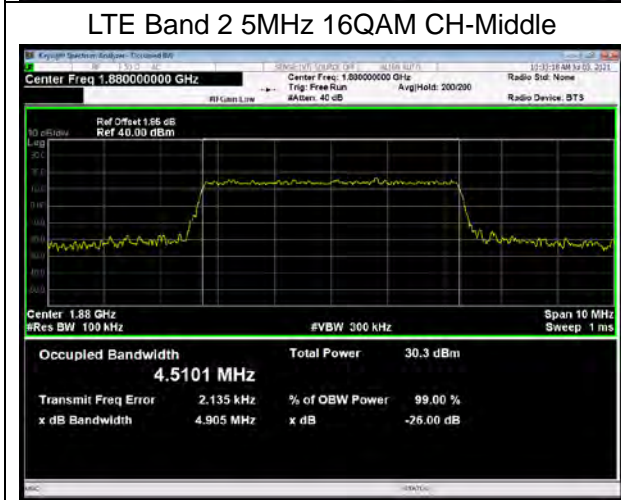
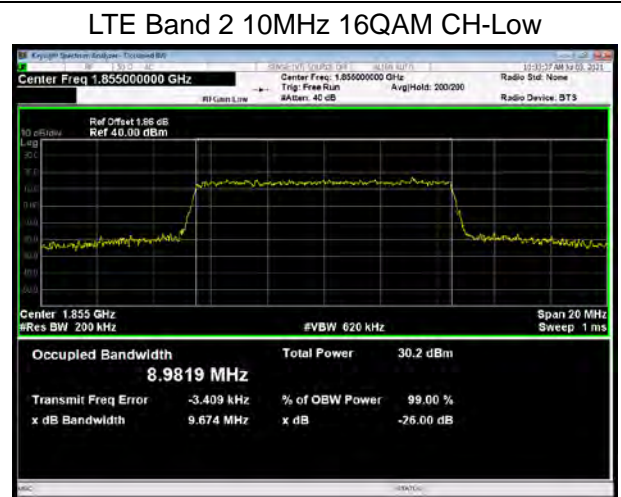
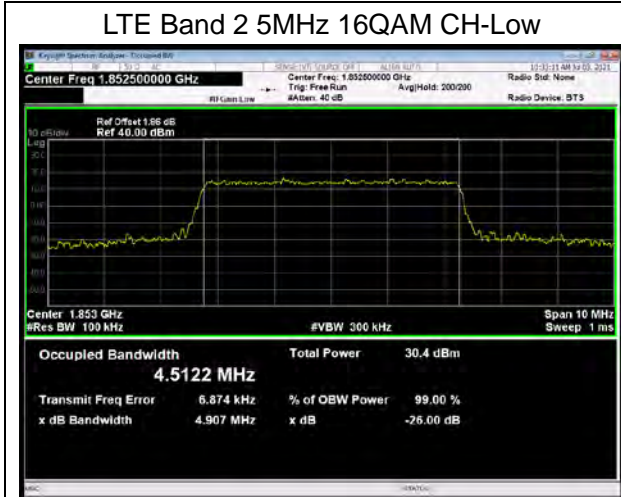

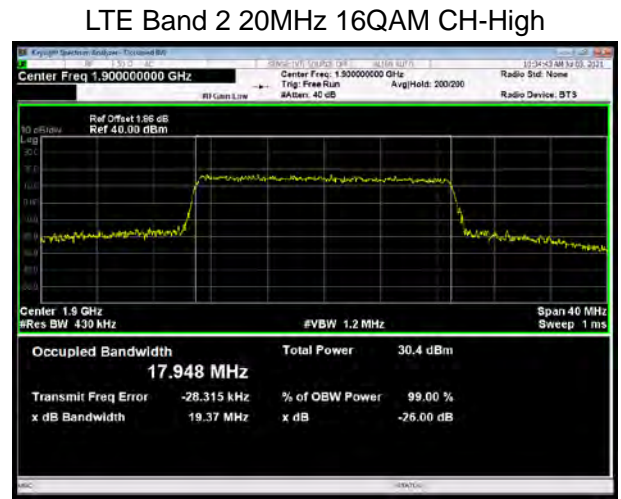
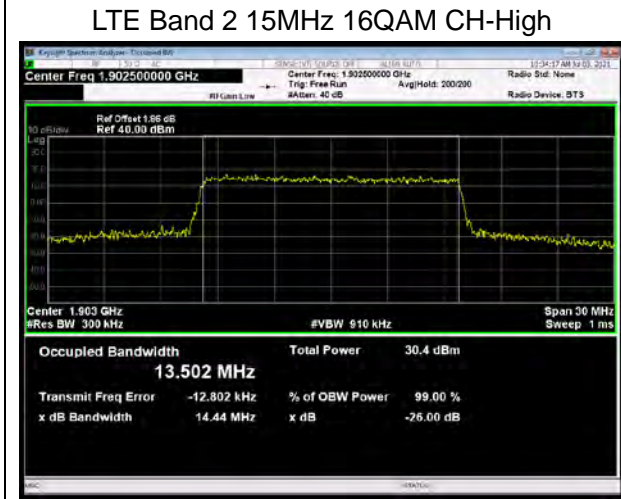
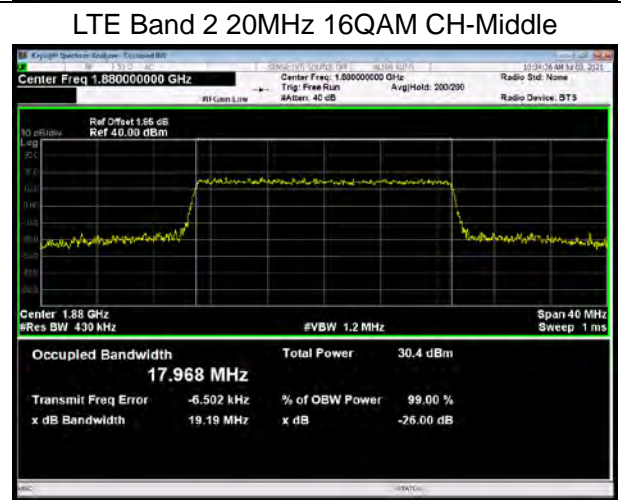
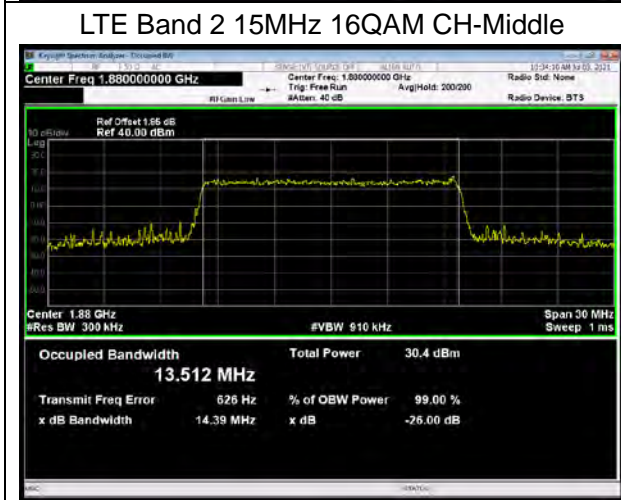
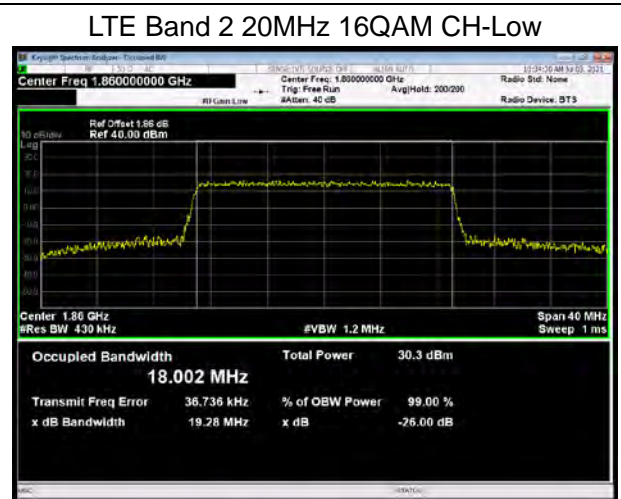
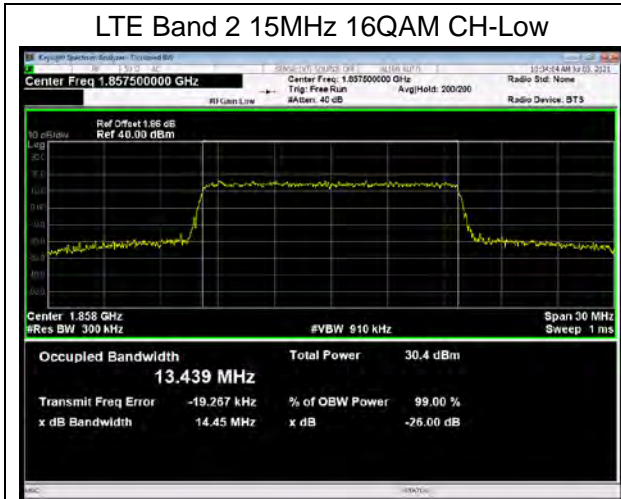



LTE Band 2 1.4MHz 64QAM CH-Low

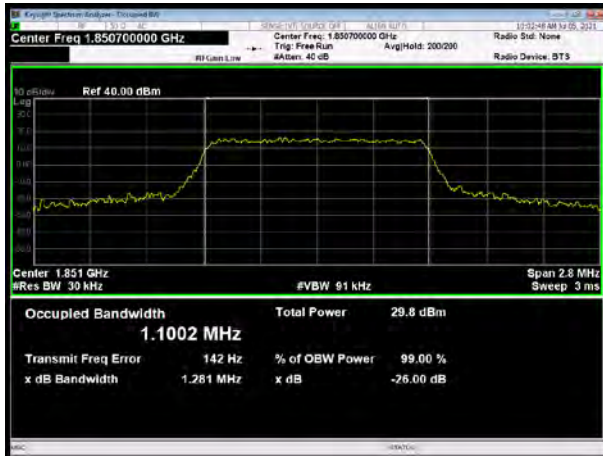

LTE Band 2 3MHz 64QAM CH-Low

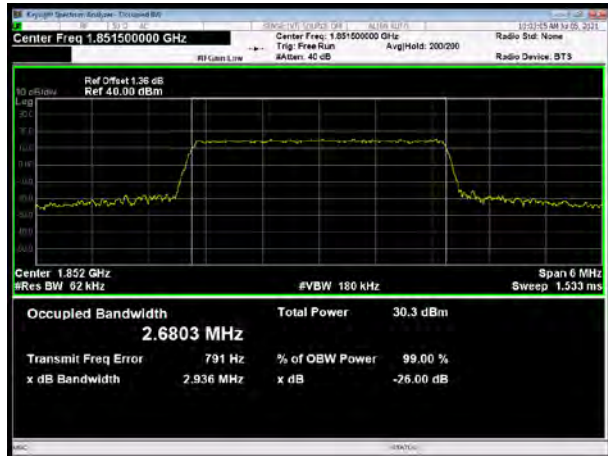

LTE Band 2 1.4MHz 64QAM CH-Middle

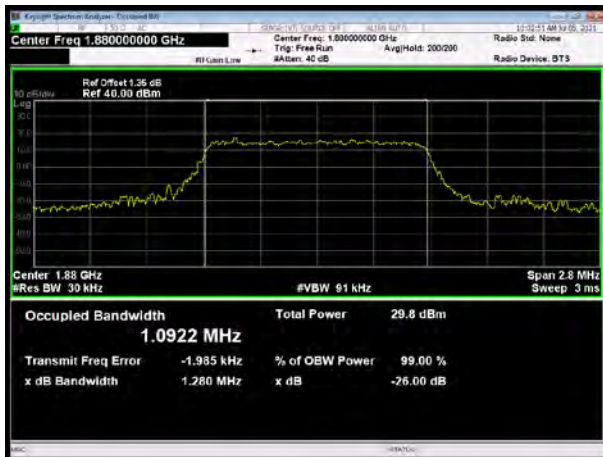

LTE Band 2 3MHz 64QAM CH-Middle

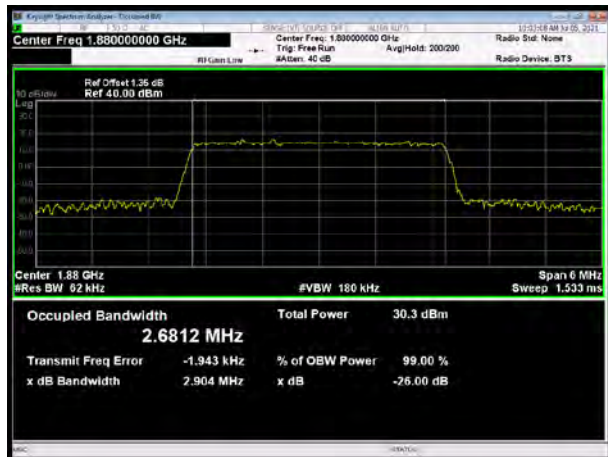

LTE Band 2 1.4MHz 64QAM CH-High

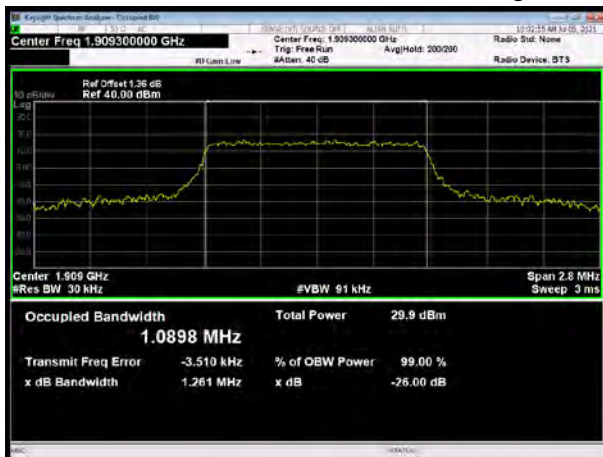

LTE Band 2 3MHz 64QAM CH-High

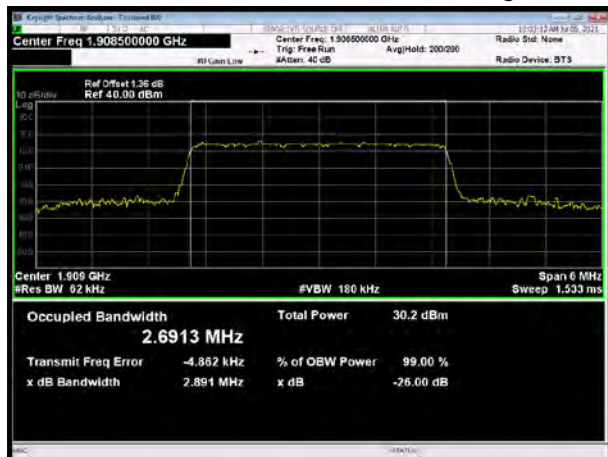

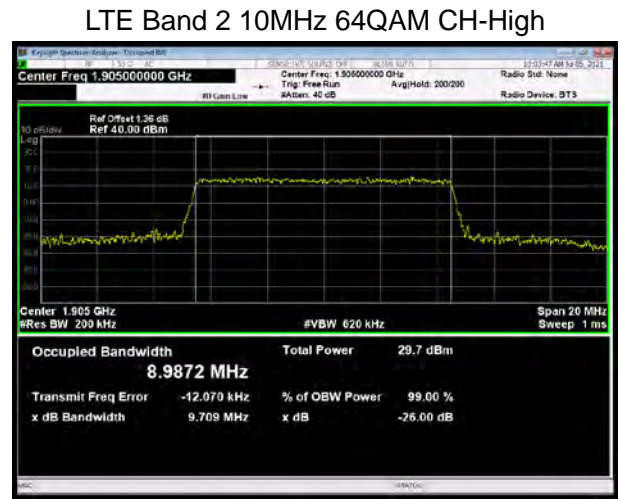
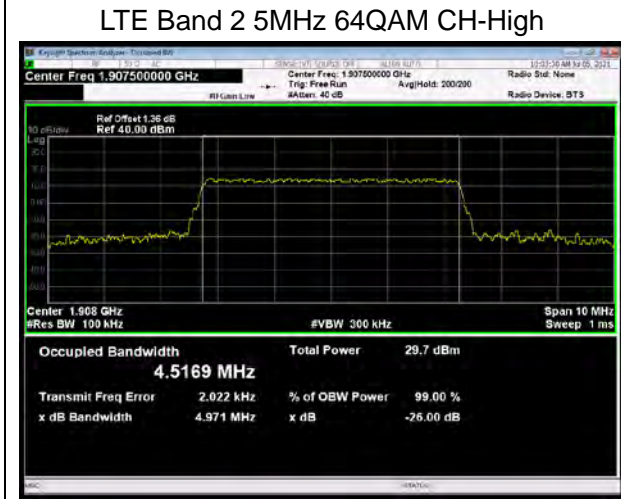
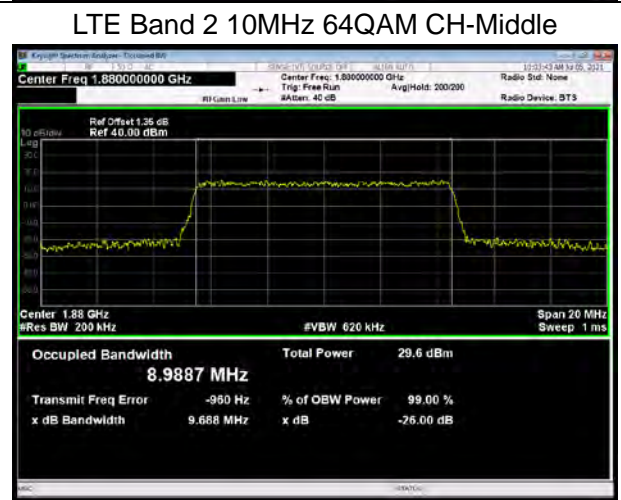
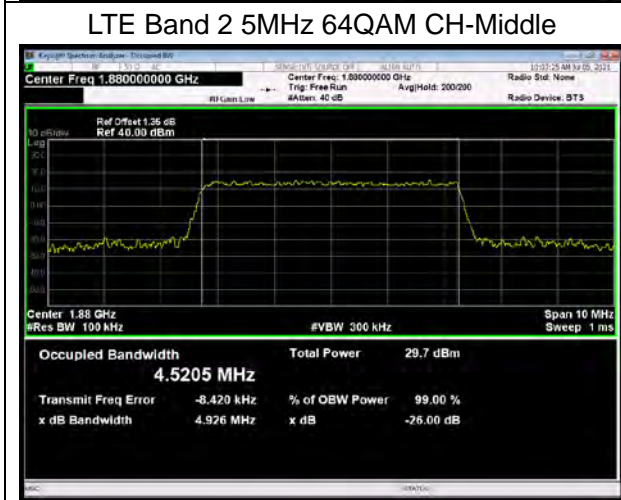
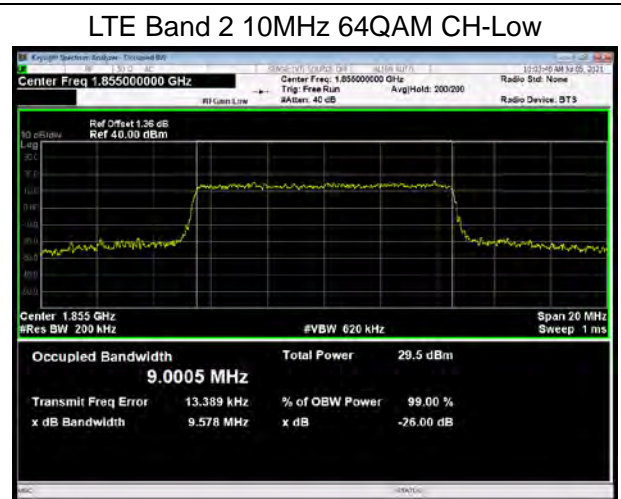
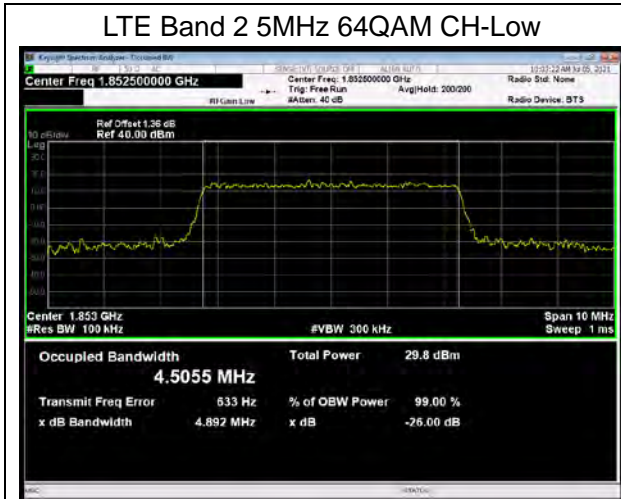



LTE Band 2 15MHz 64QAM CH-Low

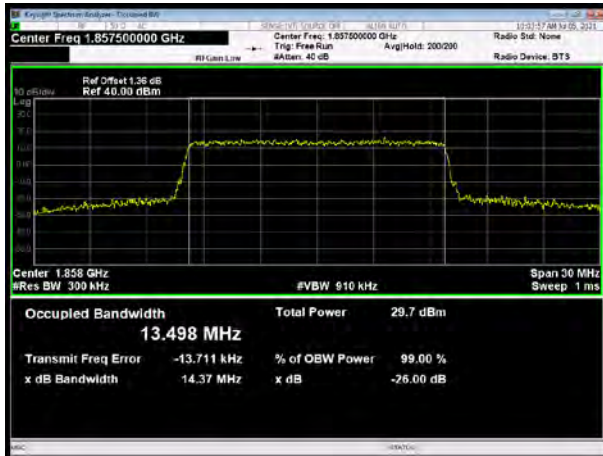

LTE Band 2 20MHz 64QAM CH-Low

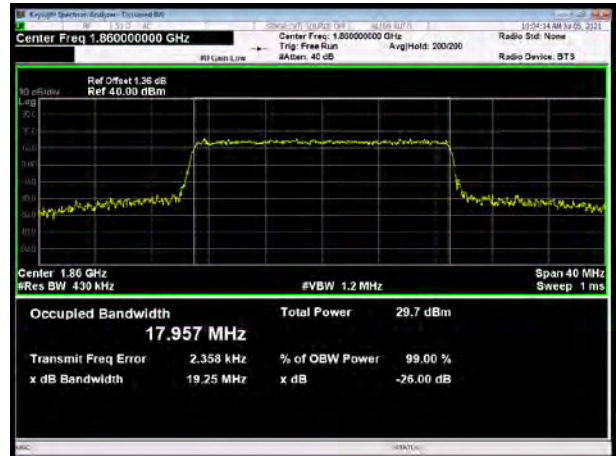

LTE Band 2 15MHz 64QAM CH-Middle

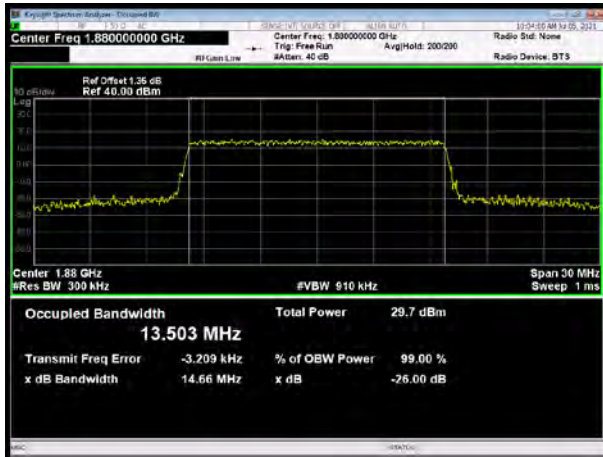

LTE Band 2 20MHz 64QAM CH-Middle

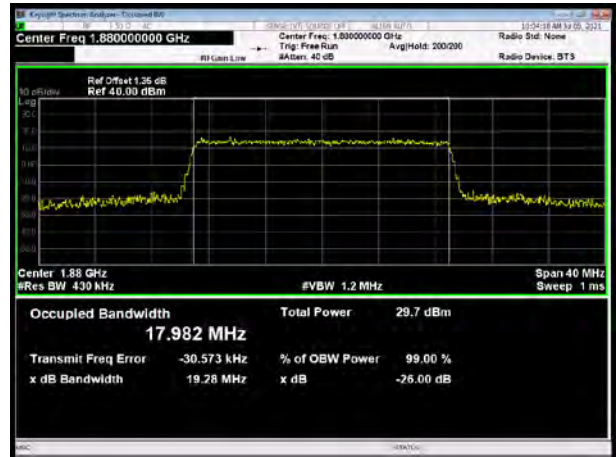

LTE Band 2 15MHz 64QAM CH-High

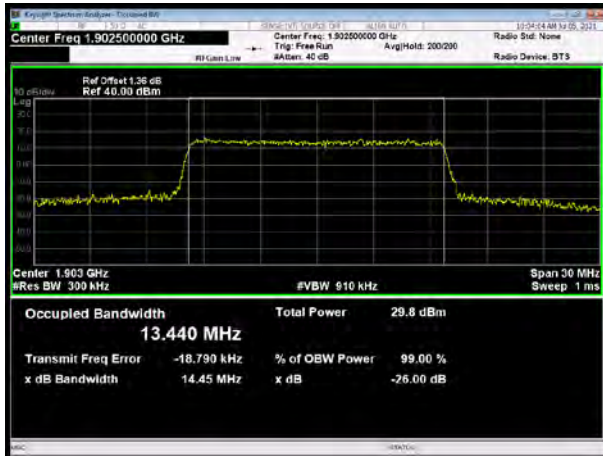

LTE Band 2 20MHz 64QAM CH-High

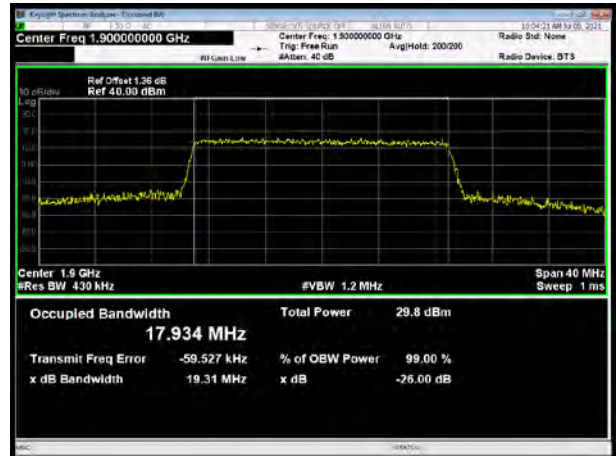

5.3. Band Edge Compliance

Ambient condition

Temperature	Relative humidity	Pressure
23°C ~25°C	45%~50%	101.5kPa

Method of Measurement

The EUT was connected to Spectrum Analyzer and Base Station Simulator via power Splitter. The band edge of the lowest and highest channels were measured. The Average detector is used and RBW is set to 6.2kHz, VBW is set to 20kHz for GSM 1900, RBW is set to 51kHz, VBW is set to 160kHz for WCDMA Band II, RBW is set to 15kHz, VBW is set to 43kHz for LTE Band 2 (1.4MHz), RBW is set to 33kHz, VBW is set to 100kHz for LTE Band 2 (3MHz), RBW is set to 51kHz, VBW is set to 150kHz for LTE Band 2 (5MHz), RBW is set to 100kHz, VBW is set to 300kHz for LTE Band 2 (10MHz), RBW is set to 150kHz, VBW is set to 470kHz for LTE Band 2 (15MHz), RBW is set to 200kHz, VBW is set to 620kHz for LTE Band 2 (20MHz). Spectrum analyzer plots are included on the following pages.

Test Setup

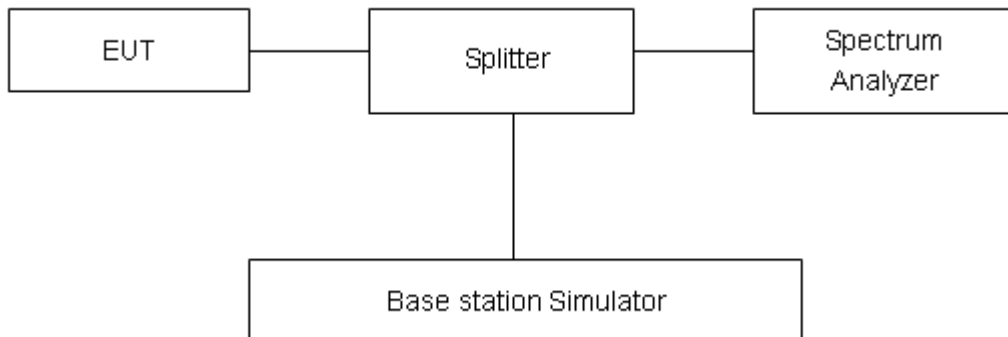

Limits

Rule Part 24.238(a) specifies that “on any frequency outside a licensee's frequency block, the power of any emission shall be attenuated below the transmitter power (P) by at least $43 + 10 \log_{10}(P)$ dB.”

Limit	-13 dBm
-------	---------

Measurement Uncertainty

The assessed measurement uncertainty to ensure 95% confidence level for the normal distribution is with the coverage factor $k = 1.96$, $U=0.684$ dB.



Test Result:

GSM1900 GSM CH-Low



GSM 1900 GSM CH-High



GSM1900 GPRS CH-Low



GSM 1900 GPRS CH-High



GSM1900 EGPRS CH-Low



GSM 1900 EGPRS CH-High

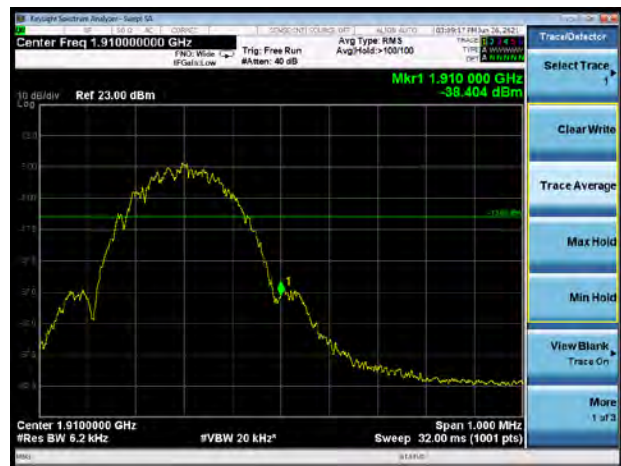



WCDMA Band II RMC CH-Low



WCDMA Band II RMC CH-High



LTE Band 2 1.4MHz QPSK 1RB CH-Low

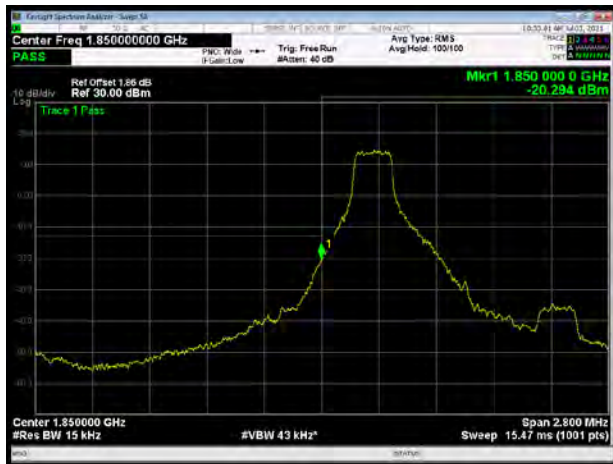

LTE Band 2 1.4MHz QPSK 1RB CH-High



LTE Band 2 1.4MHz QPSK 100%RB CH-Low



LTE Band 2 1.4MHz QPSK 100%RB CH-High





LTE Band 2 3MHz QPSK 1RB CH-Low

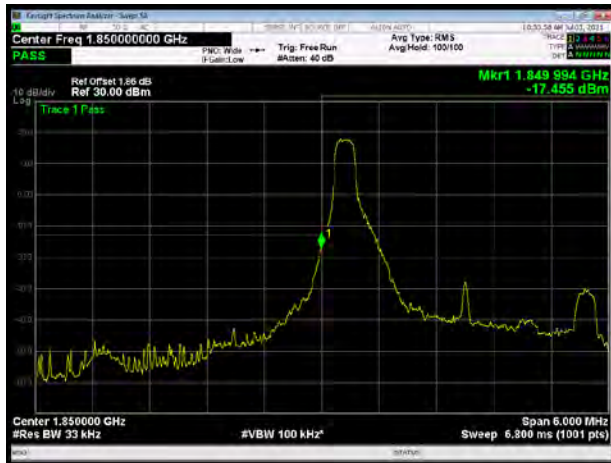

LTE Band 2 3MHz QPSK 1RB CH-High

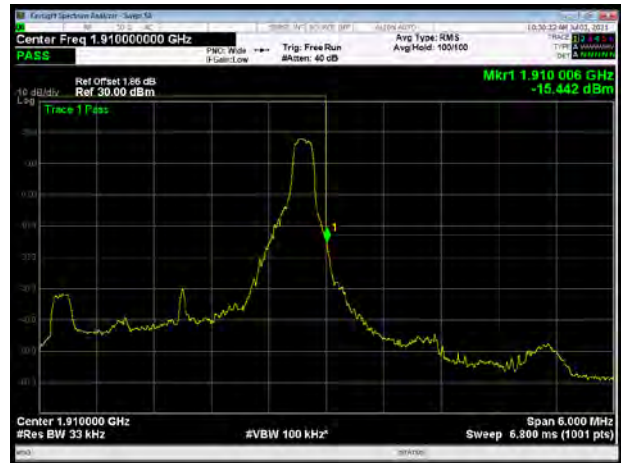

LTE Band 2 3MHz QPSK 100%RB CH-Low



LTE Band 2 3MHz QPSK 100%RB CH-High



LTE Band 2 5MHz QPSK 1RB CH-Low



LTE Band 2 5MHz QPSK 1RB CH-High

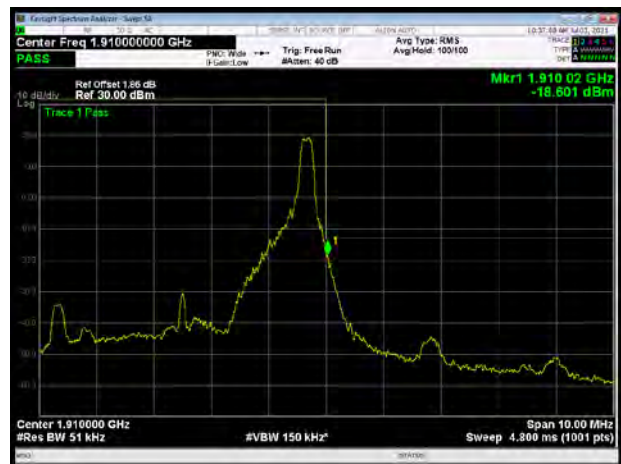



LTE Band 2 5MHz QPSK 100%RB CH-Low



LTE Band 2 5MHz QPSK 100%RB CH-High



LTE Band 2 10MHz QPSK 1RB CH-Low

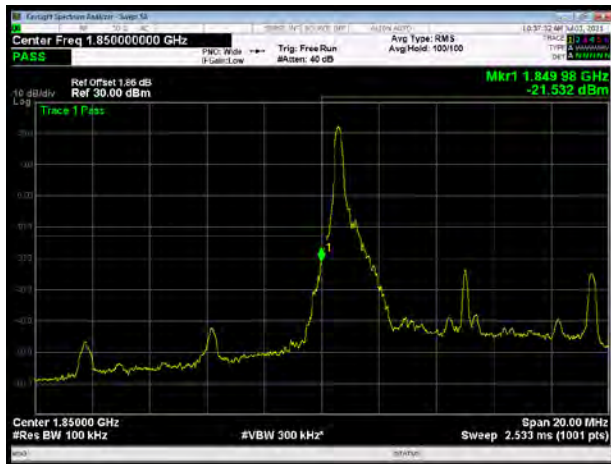

LTE Band 2 10MHz QPSK 1RB CH-High

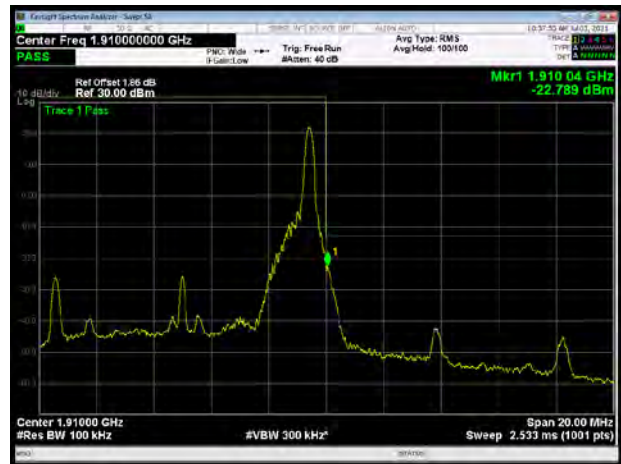

LTE Band 2 10MHz QPSK 100%RB CH-Low



LTE Band 2 10MHz QPSK 100%RB CH-High

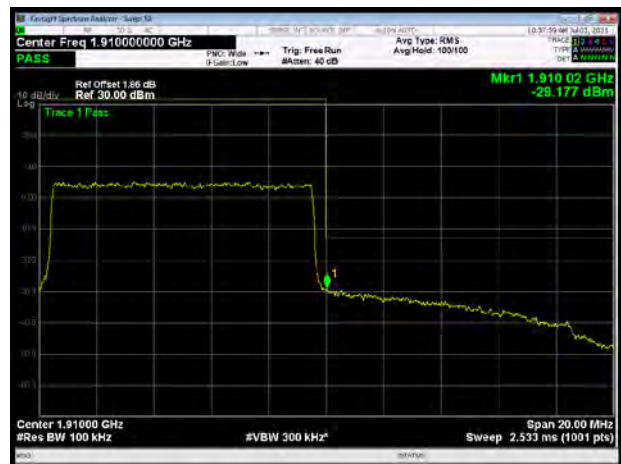



LTE Band 2 15MHz QPSK 1RB CH-Low



LTE Band 2 15MHz QPSK 1RB CH-High



LTE Band 2 15MHz QPSK 100%RB CH-Low

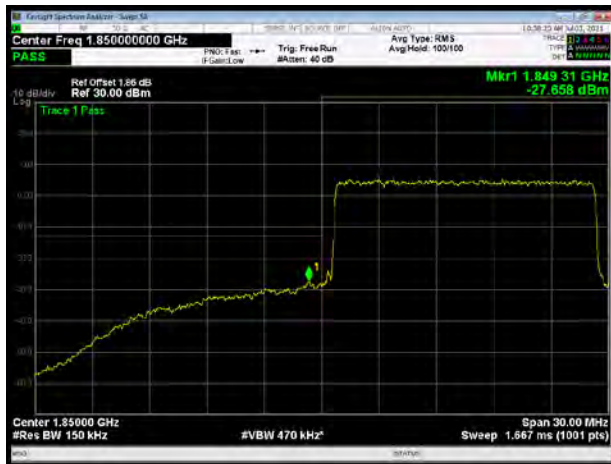

LTE Band 2 15MHz QPSK 100%RB CH-High

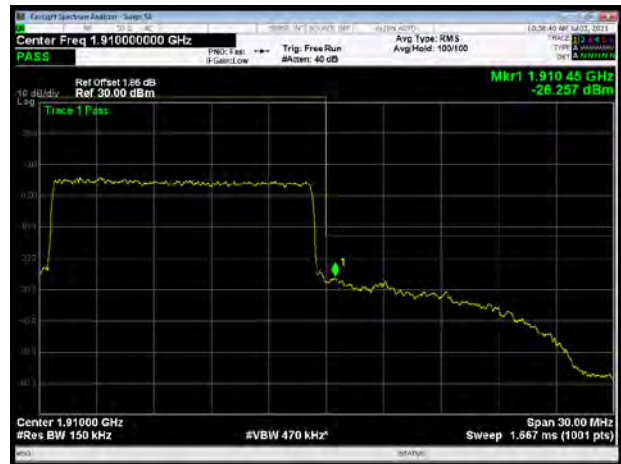

LTE Band 2 20MHz QPSK 1RB CH-Low

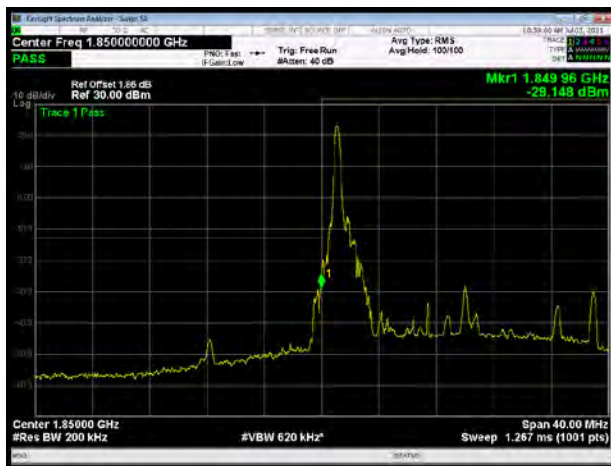

LTE Band 2 20MHz QPSK 1RB CH-High

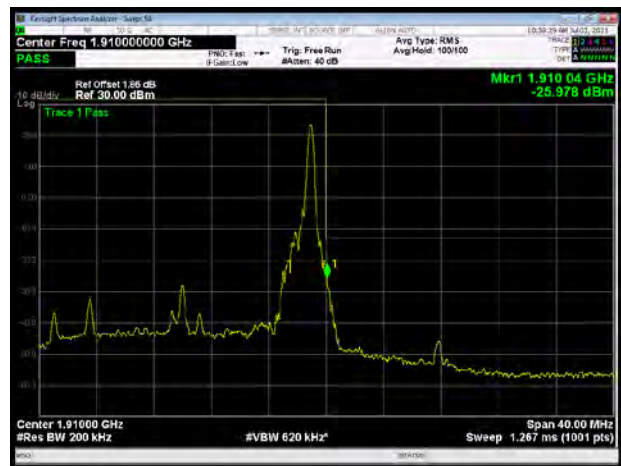



LTE Band 2 20MHz QPSK 100%RB CH-Low



LTE Band 2 20MHz QPSK 100%RB CH-High



LTE Band 2 1.4MHz 16QAM 1RB CH-Low

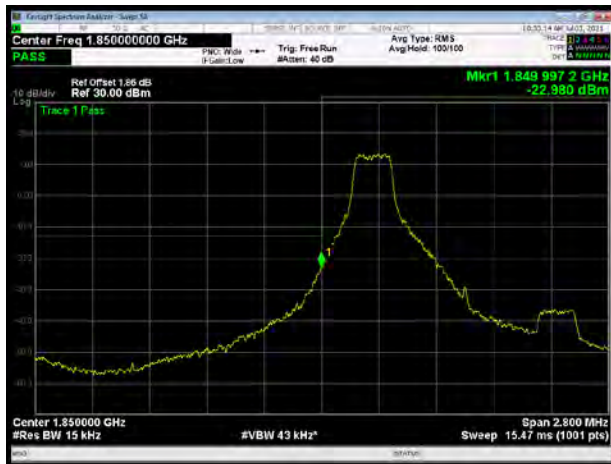

LTE Band 2 1.4MHz 16QAM 1RB CH-High



LTE Band 2 1.4MHz 16QAM 100%RB CH-Low

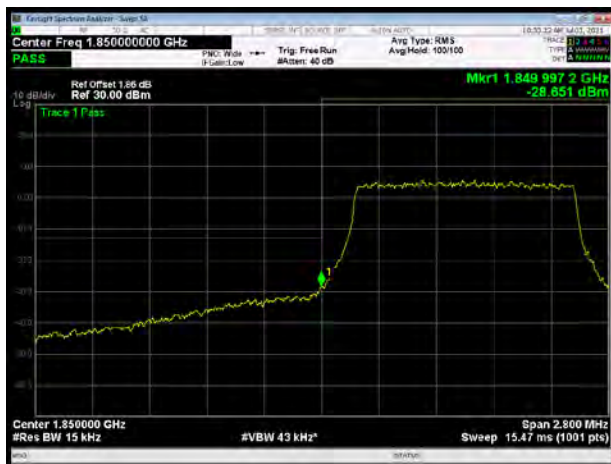

LTE Band 2 1.4MHz 16QAM 100%RB CH-High





LTE Band 2 3MHz 16QAM 1RB CH-Low

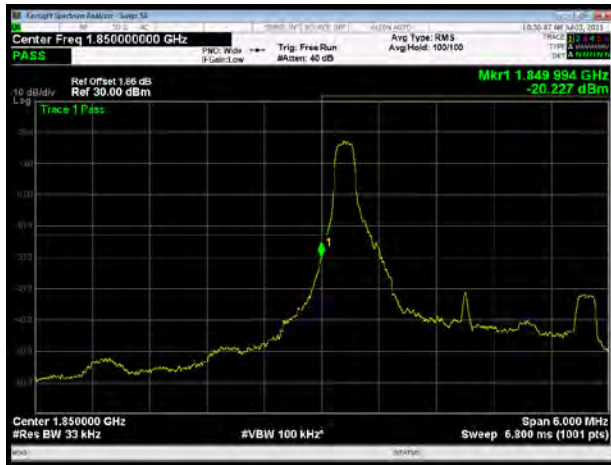

LTE Band 2 3MHz 16QAM 1RB CH-High

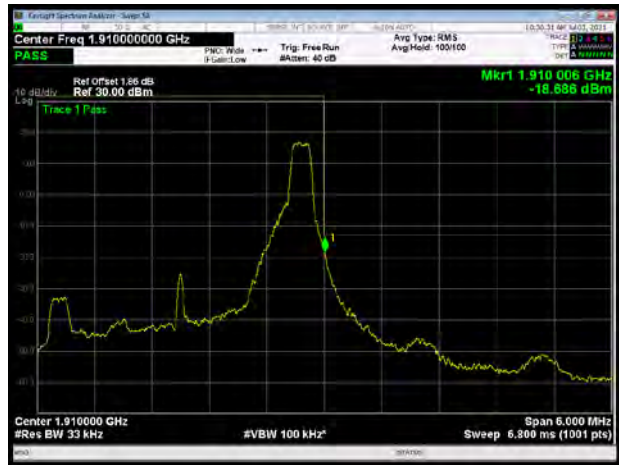

LTE Band 2 3MHz 16QAM 100%RB CH-Low



LTE Band 2 3MHz 16QAM 100%RB CH-High



LTE Band 2 5MHz 16QAM 1RB CH-Low



LTE Band 2 5MHz 16QAM 1RB CH-High

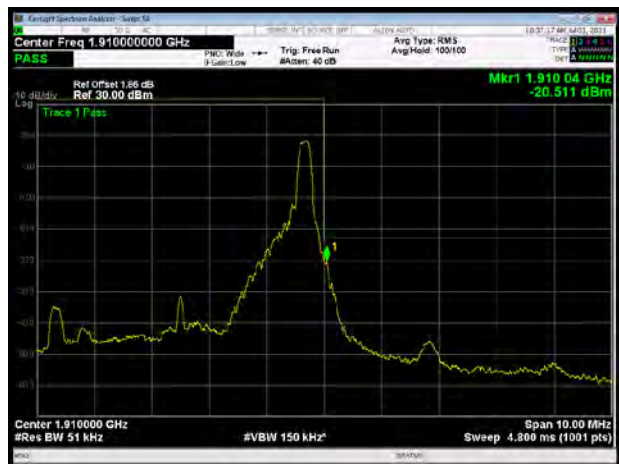



LTE Band 2 5MHz 16QAM 100%RB CH-Low

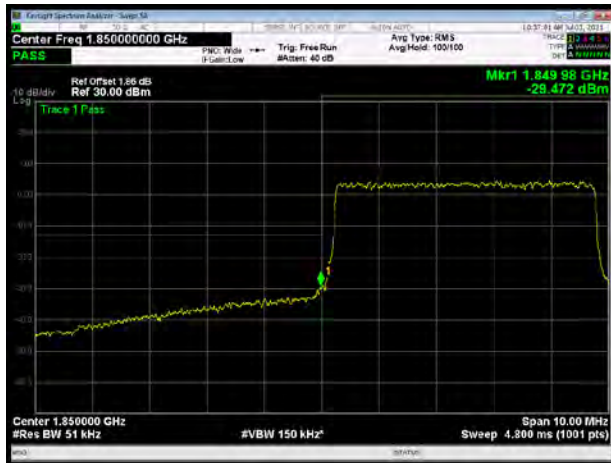

LTE Band 2 5MHz 16QAM 100%RB CH-High



LTE Band 2 10MHz 16QAM 1RB CH-Low

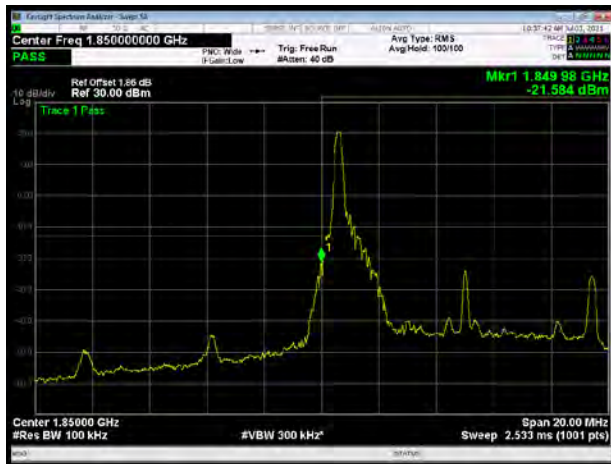

LTE Band 2 10MHz 16QAM 1RB CH-High

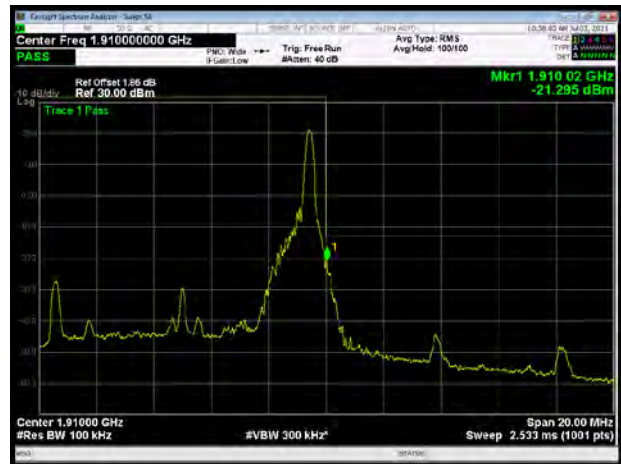

LTE Band 2 10MHz 16QAM 100%RB CH-Low

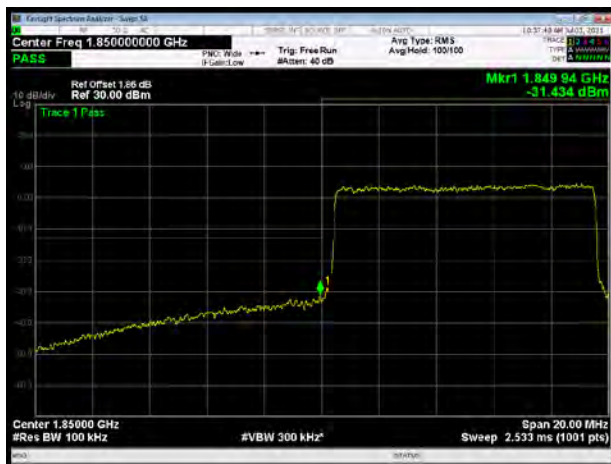

LTE Band 2 10MHz 16QAM 100%RB CH-High





LTE Band 2 15MHz 16QAM 1RB CH-Low



LTE Band 2 15MHz 16QAM 1RB CH-High

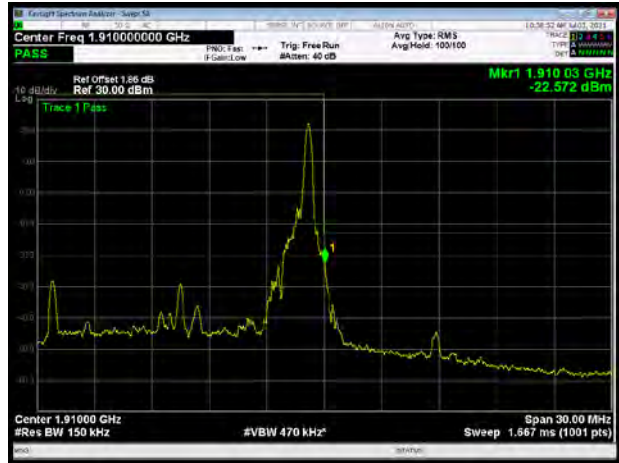

LTE Band 2 15MHz 16QAM 100%RB CH-Low



LTE Band 2 15MHz 16QAM 100%RB CH-High



LTE Band 2 20MHz 16QAM 1RB CH-Low

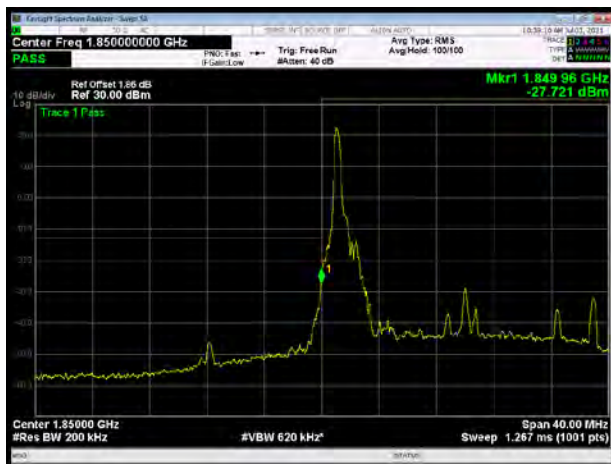

LTE Band 2 20MHz 16QAM 1RB CH-High

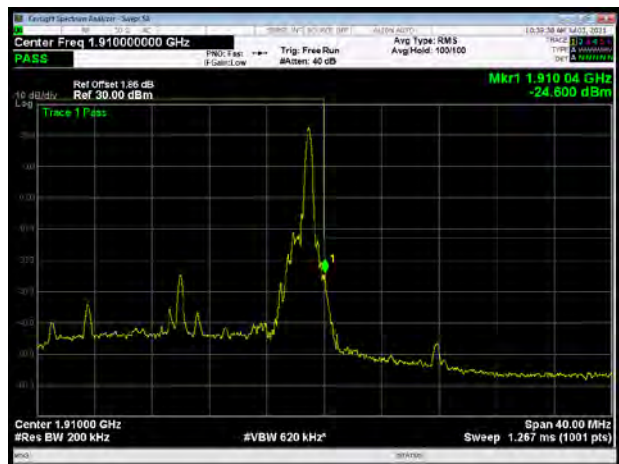



LTE Band 2 20MHz 16QAM 100%RB CH-Low

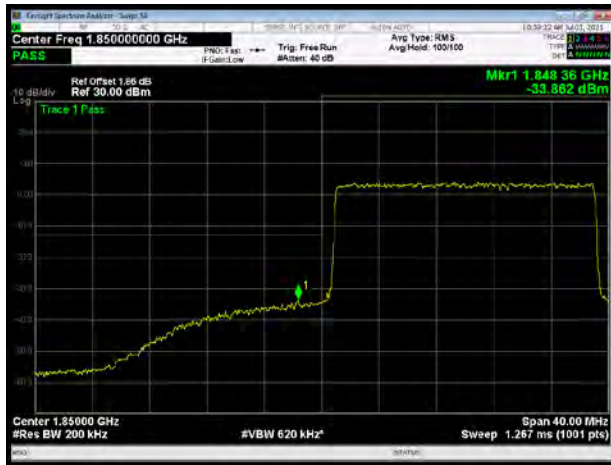

LTE Band 2 20MHz 16QAM 100%RB CH-High



LTE Band 2 1.4MHz 64QAM 1RB CH-Low

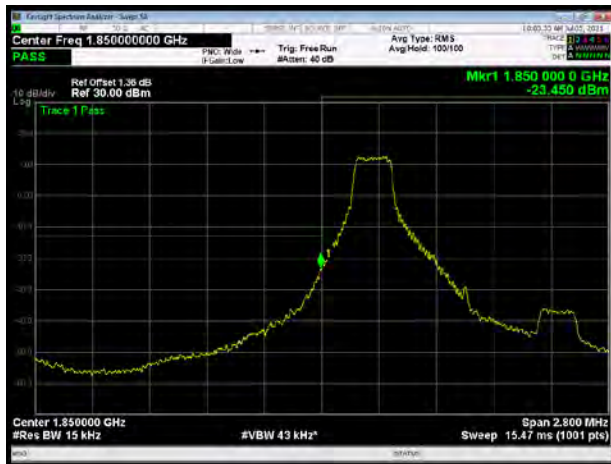

LTE Band 2 1.4MHz 64QAM 1RB CH-High

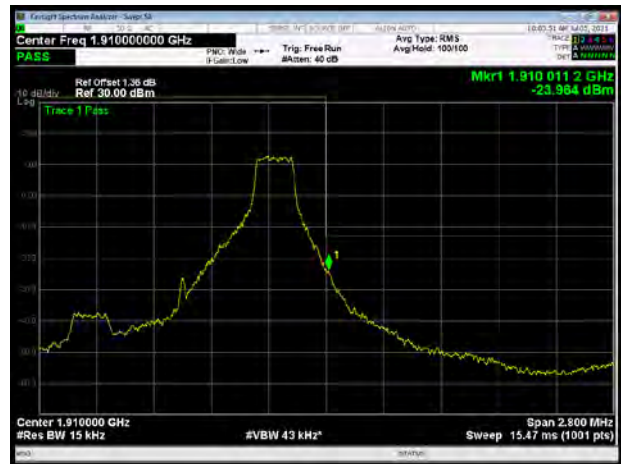

LTE Band 2 1.4MHz 64QAM 100%RB CH-Low



LTE Band 2 1.4MHz 64QAM 100%RB CH-High





LTE Band 2 3MHz 64QAM 1RB CH-Low



LTE Band 2 3MHz 64QAM 1RB CH-High



LTE Band 2 3MHz 64QAM 100%RB CH-Low

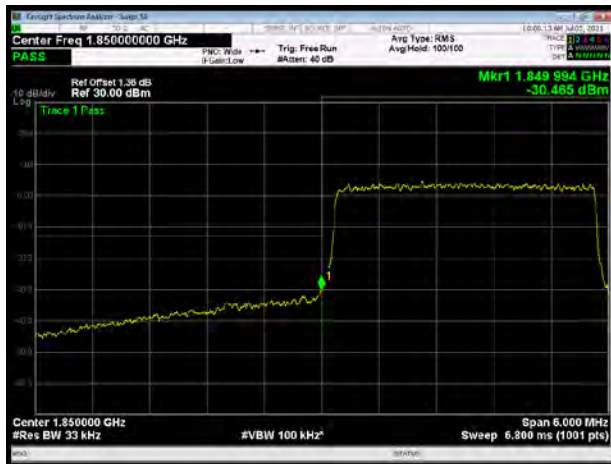

LTE Band 2 3MHz 64QAM 100%RB CH-High



LTE Band 2 5MHz 64QAM 1RB CH-Low

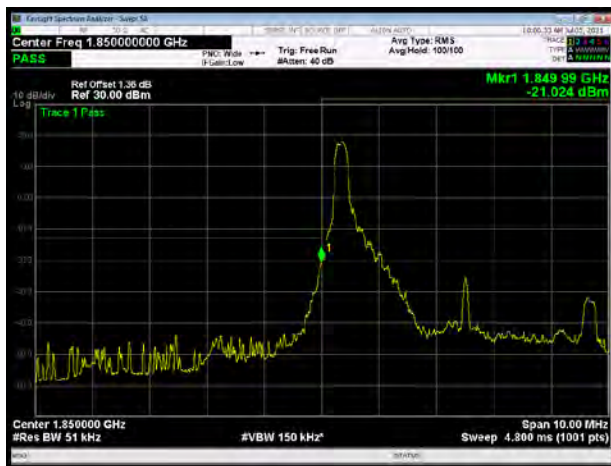

LTE Band 2 5MHz 64QAM 1RB CH-High

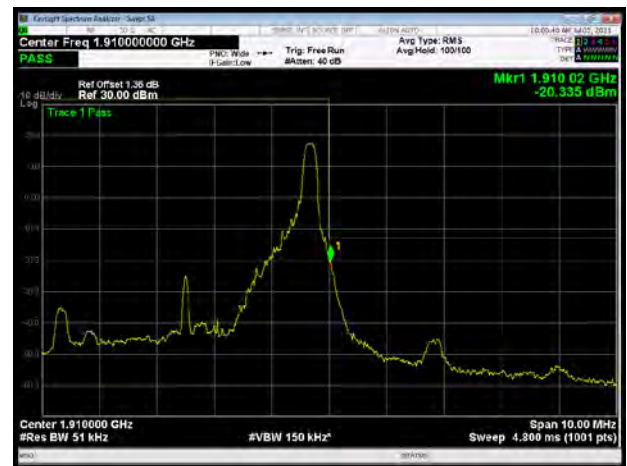



LTE Band 2 5MHz 64QAM 100%RB CH-Low



LTE Band 2 5MHz 64QAM 100%RB CH-High



LTE Band 2 10MHz 64QAM 1RB CH-Low

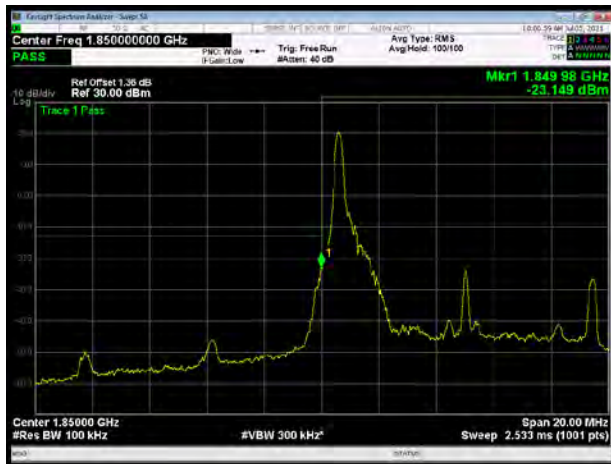

LTE Band 2 10MHz 64QAM 1RB CH-High

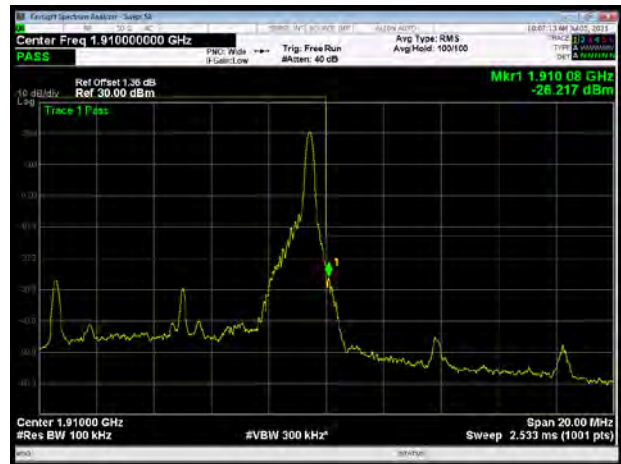

LTE Band 2 10MHz 64QAM 100%RB CH-Low

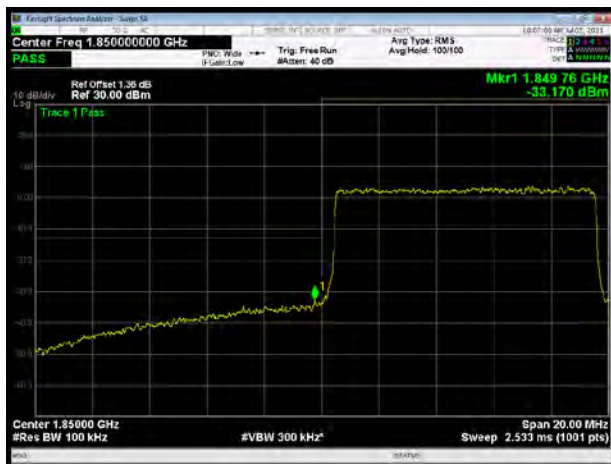

LTE Band 2 10MHz 64QAM 100%RB CH-High





LTE Band 2 15MHz 64QAM 1RB CH-Low



LTE Band 2 15MHz 64QAM 1RB CH-High



LTE Band 2 15MHz 64QAM 100%RB CH-Low

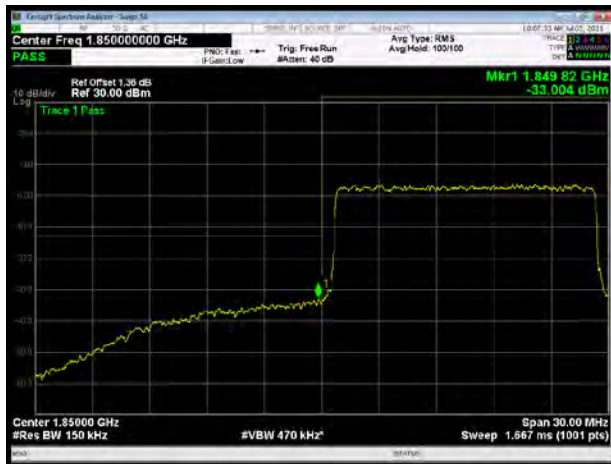

LTE Band 2 15MHz 64QAM 100%RB CH-High



LTE Band 2 20MHz 64QAM 1RB CH-Low



LTE Band 2 20MHz 64QAM 1RB CH-High

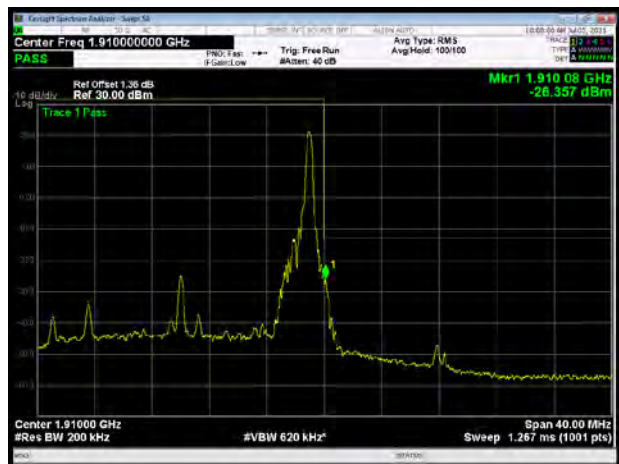



LTE Band 2 20MHz 64QAM 100%RB CH-Low

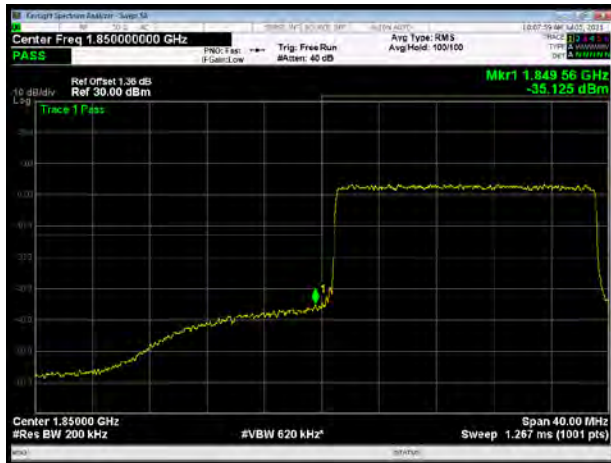

LTE Band 2 20MHz 64QAM 100%RB CH-High

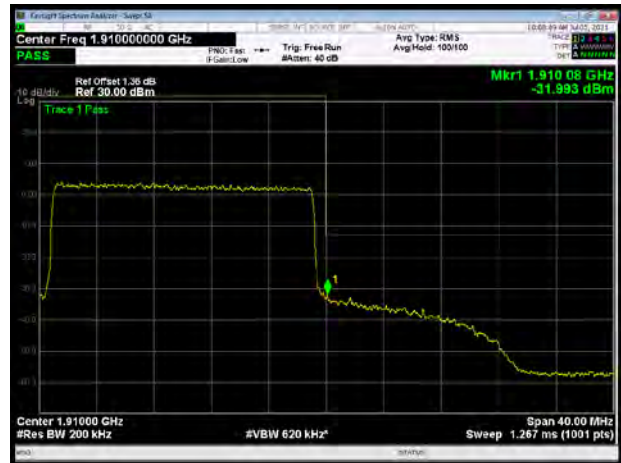

5.4. Peak-to-Average Power Ratio (PAPR)

Ambient condition

Temperature	Relative humidity	Pressure
23°C ~25°C	45%~50%	101.5kPa

Methods of Measurement

Measure the total peak power and record as PPk. And measure the total average power and record as PAvg. Both the peak and average power levels must be expressed in the same logarithmic units (e.g., dBm). Determine the PAPR from:

$$\text{PAPR (dB)} = \text{PPk (dBm)} - \text{PAvg (dBm)}.$$

Test Setup

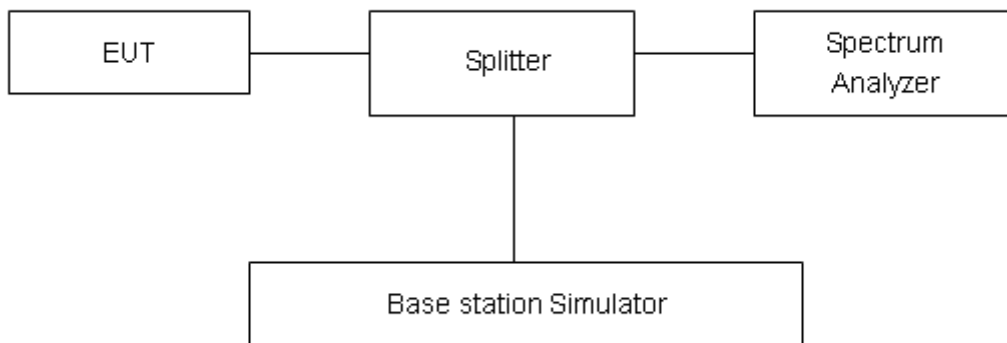

Limits

In measuring transmissions in this band using an average power technique, the peak-to-average ratio (PAR) of the transmission may not exceed 13 dB in 24.232(d).

Measurement Uncertainty

The assessed measurement uncertainty to ensure 95% confidence level for the normal distribution is with the coverage factor $k = 2$, $U = 0.4$ dB.

**Test Results**

Mode	Channel	Frequency (MHz)	Peak(dBm)	Avg(dBm)	PAPR(dB)	Limit(dB)	Conclusion
GSM 1900 (GMSK)	512	1850.2	29.54	26.94	2.60	≤13	PASS
	661	1880	29.16	26.56	2.60	≤13	PASS
	810	1909.8	27.37	24.77	2.60	≤13	PASS
GPRS 1900 (GMSK)	512	1850.2	29.58	26.97	2.61	≤13	PASS
	661	1880	29.19	26.59	2.60	≤13	PASS
	810	1909.8	27.38	24.77	2.61	≤13	PASS
EGPRS 1900 (8PSK)	512	1850.2	29.08	23.34	5.74	≤13	PASS
	661	1880	28.74	23.01	5.73	≤13	PASS
	810	1909.8	26.77	21.01	5.76	≤13	PASS
WCDMA Band II (RMC)	9262	1852.4	26.63	23.73	2.90	≤13	PASS
	9400	1880	26.62	23.66	2.96	≤13	PASS
	9538	1907.6	25.33	22.46	2.87	≤13	PASS



LTE Band 2								
Modulation	Bandwidth (MHz)	Channel	Frequency (MHz)	Peak (dBm)	Avg (dBm)	PAPR (dB)	Limit (dB)	Conclusion
QPSK	1.4	18607	1850.7	27.55	23.44	4.11	≤13	PASS
		18900	1880.0	27.78	23.40	4.38	≤13	PASS
		19193	1909.3	27.31	23.46	3.85	≤13	PASS
	3	18615	1851.5	27.63	23.35	4.28	≤13	PASS
		18900	1880	27.81	23.33	4.48	≤13	PASS
		19185	1908.5	27.41	23.35	4.06	≤13	PASS
	5	18625	1852.5	27.70	23.36	4.34	≤13	PASS
		18900	1880	27.93	23.36	4.57	≤13	PASS
		19175	1907.5	27.60	23.35	4.25	≤13	PASS
	10	18650	1855	27.81	23.37	4.44	≤13	PASS
		18900	1880	27.97	23.37	4.60	≤13	PASS
		19150	1905	27.85	23.38	4.47	≤13	PASS
	15	18675	1857.5	28.32	23.44	4.88	≤13	PASS
		18900	1880	28.41	23.47	4.94	≤13	PASS
		19125	1902.5	28.28	23.52	4.76	≤13	PASS
	20	18700	1860	28.30	23.28	5.02	≤13	PASS
		18900	1880	28.37	23.34	5.03	≤13	PASS
		19100	1900	28.17	23.34	4.83	≤13	PASS
16QAM	1.4	18607	1850.7	27.36	22.33	5.03	≤13	PASS
		18900	1880.0	27.58	22.31	5.27	≤13	PASS
		19193	1909.3	27.19	22.39	4.80	≤13	PASS
	3	18615	1851.5	27.47	22.32	5.15	≤13	PASS
		18900	1880	27.70	22.31	5.39	≤13	PASS
		19185	1908.5	27.53	22.35	4.97	≤13	PASS
	5	18625	1852.5	27.74	22.36	5.17	≤13	PASS
		18900	1880	27.45	22.36	5.38	≤13	PASS
		19175	1907.5	27.64	22.32	5.13	≤13	PASS
	10	18650	1855	27.82	22.36	5.28	≤13	PASS
		18900	1880	27.71	22.37	5.45	≤13	PASS
		19150	1905	27.97	22.38	5.33	≤13	PASS
	15	18675	1857.5	28.06	22.39	5.58	≤13	PASS
		18900	1880	27.99	22.41	5.65	≤13	PASS
		19125	1902.5	27.99	22.46	5.53	≤13	PASS
	20	18700	1860	28.08	22.28	5.80	≤13	PASS
		18900	1880	28.15	22.36	5.79	≤13	PASS
		19100	1900	28.00	22.38	5.62	≤13	PASS
64QAM	1.4	18607	1850.7	26.78	21.70	5.08	≤13	PASS
		18900	1880.0	27.04	21.70	5.34	≤13	PASS
		19193	1909.3	26.65	21.77	4.88	≤13	PASS



	3	18615	1851.5	26.92	21.75	5.17	≤13	PASS
		18900	1880	27.17	21.67	5.50	≤13	PASS
		19185	1908.5	26.81	21.69	5.12	≤13	PASS
	5	18625	1852.5	26.98	21.72	5.26	≤13	PASS
		18900	1880	27.19	21.70	5.49	≤13	PASS
		19175	1907.5	26.99	21.74	5.25	≤13	PASS
	10	18650	1855	27.11	21.75	5.36	≤13	PASS
		18900	1880	27.29	21.74	5.55	≤13	PASS
		19150	1905	27.18	21.78	5.40	≤13	PASS
	15	18675	1857.5	27.44	21.75	5.69	≤13	PASS
		18900	1880	27.52	21.76	5.76	≤13	PASS
		19125	1902.5	27.41	21.82	5.59	≤13	PASS
	20	18700	1860	27.49	21.68	5.81	≤13	PASS
		18900	1880	27.55	21.72	5.83	≤13	PASS
		19100	1900	27.42	21.73	5.69	≤13	PASS

5.5. Frequency Stability

Ambient condition

Temperature	Relative humidity	Pressure
23°C ~25°C	45%~50%	101.5kPa

Method of Measurement

Frequency Stability (Temperature Variation)

The temperature inside the climate chamber is varied from -30°C to +50°C in 10°C step size,

(1) With all power removed, the temperature was decreased to 0°C and permitted to stabilize for three hours.

(2) Measure the carrier frequency with the test equipment in a “call mode”. These measurements should be made within 1 minute of powering up the mobile station, to prevent significant self warming.

(3) Repeat the above measurements at 10°C increments from -30°C to +50°C. Allow at least 1.5 hours at each temperature, un-powered, before making measurements.

Frequency Stability (Voltage Variation)

The frequency stability shall be measured with variation of primary supply voltage as follows:

Primary Supply Voltage: The primary supply voltage is varied from 85% to 115% of the nominal value for non hand-carried battery and AC powered equipment. For hand-carried, battery-powered equipment, primary supply voltage is reduced to the battery operating end point which shall be specified by the manufacturer.

This transceiver is specified to operate with an input voltage of between 3.6 V and 4.45 V, with a nominal voltage of 3.87V.

Test setup

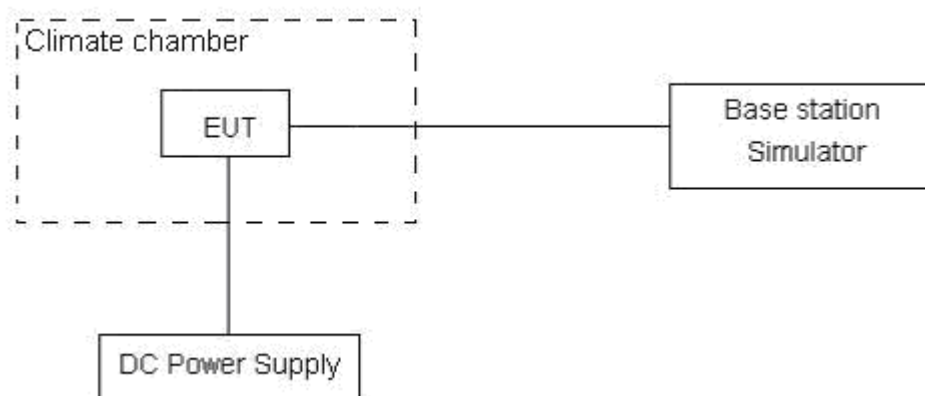

**Limits**

The frequency stability shall be sufficient to ensure that the fundamental emission stays within the authorized frequency block

Measurement Uncertainty

The assessed measurement uncertainty to ensure 99.75% confidence level for the normal distribution is with the coverage factor $k = 3$, $U = 0.01\text{ppm}$.

Test Result

GSM 1900						
Condition		Freq.Error (Hz)	Freq.Error (Hz)	Frequency Stability (ppm)	Frequency Stability (ppm)	Verdict
Temperature	Voltage	GMSK	8PSK	GMSK	8PSK	
Normal (25°C)	Normal	13.49	14.24	0.00718	0.00758	PASS
Extreme (50°C)		3.64	3.97	0.00194	0.00211	PASS
Extreme (40°C)		10.18	14.40	0.00542	0.00766	PASS
Extreme (30°C)		8.27	15.24	0.00440	0.00811	PASS
Extreme (20°C)		14.55	4.99	0.00774	0.00266	PASS
Extreme (10°C)		9.75	14.08	0.00519	0.00749	PASS
Extreme (0°C)		6.86	10.25	0.00365	0.00545	PASS
Extreme (-10°C)		6.68	3.06	0.00355	0.00163	PASS
Extreme (-20°C)		3.39	17.90	0.00180	0.00952	PASS
Extreme (-30°C)		5.95	8.47	0.00317	0.00451	PASS
25°C	LV	14.43	6.25	0.00767	0.00332	PASS
	HV	15.82	12.16	0.00842	0.00647	PASS

WCDMA B2						
Condition		Freq.Error (Hz)	Freq.Error (Hz)	Frequency Stability (ppm)	Frequency Stability (ppm)	Verdict
Temperature	Voltage	BPSK	QPSK	BPSK	QPSK	
Normal (25°C)	Normal	7.78	13.22	0.00414	0.00703	PASS
Extreme (50°C)		1.04	14.86	0.00055	0.00791	PASS
Extreme (40°C)		10.82	6.85	0.00575	0.00364	PASS
Extreme (30°C)		16.44	14.57	0.00875	0.00775	PASS
Extreme (20°C)		14.99	11.03	0.00797	0.00587	PASS
Extreme (10°C)		9.98	3.36	0.00531	0.00179	PASS
Extreme (0°C)		17.22	5.08	0.00916	0.00270	PASS
Extreme (-10°C)		4.51	1.09	0.00240	0.00058	PASS
Extreme (-20°C)		1.28	17.36	0.00068	0.00923	PASS
Extreme (-30°C)		5.86	11.35	0.00312	0.00604	PASS
25°C	LV	14.44	17.05	0.00768	0.00907	PASS
	HV	3.37	15.44	0.00179	0.00821	PASS



LTE Band 2(1880MHz)

Condition		Freq.Error (Hz)	Freq.Error (Hz)	Freq.Error (Hz)	Frequency Stability (ppm)	Frequency Stability (ppm)	Frequency Stability (ppm)	Verdict
BANDWIDTH	1.4MHz							
Temperature	Voltage	64QAM	16QAM	QPSK	64QAM	16QAM	QPSK	
Normal (25°C)	Normal	5.04	1.79	7.41	0.00268	0.00095	0.00394	PASS
Extreme (50°C)		13.47	1.49	6.11	0.00717	0.00079	0.00325	PASS
Extreme (40°C)		15.39	7.83	6.64	0.00819	0.00417	0.00353	PASS
Extreme (30°C)		16.12	3.70	2.46	0.00857	0.00197	0.00131	PASS
Extreme (20°C)		10.95	2.08	8.02	0.00582	0.00111	0.00426	PASS
Extreme (10°C)		14.08	14.81	15.12	0.00749	0.00788	0.00804	PASS
Extreme (0°C)		14.28	6.67	13.70	0.00759	0.00355	0.00729	PASS
Extreme (-10°C)		7.46	17.55	12.49	0.00397	0.00933	0.00664	PASS
Extreme (-20°C)		8.88	16.24	2.28	0.00472	0.00864	0.00122	PASS
Extreme (-30°C)		16.69	14.29	17.39	0.00888	0.00760	0.00925	PASS
25°C		LV	7.74	3.64	2.09	0.00412	0.00194	0.00111
	HV	9.79	13.75	8.77	0.00521	0.00731	0.00466	PASS
Condition		Freq.Error (Hz)	Freq.Error (Hz)	Freq.Error (Hz)	Frequency Stability (ppm)	Frequency Stability (ppm)	Frequency Stability (ppm)	Verdict
BANDWIDTH	3MHz							
Temperature	Voltage	64QAM	16QAM	QPSK	64QAM	16QAM	QPSK	
Normal (25°C)	Normal	1.35	10.93	6.74	0.00072	0.00581	0.00358	PASS
Extreme (50°C)		10.64	3.81	5.05	0.00566	0.00202	0.00269	PASS
Extreme (40°C)		16.52	10.23	11.36	0.00879	0.00544	0.00604	PASS
Extreme (30°C)		2.45	7.34	9.80	0.00130	0.00391	0.00522	PASS
Extreme (20°C)		2.23	7.09	15.30	0.00119	0.00377	0.00814	PASS
Extreme (10°C)		10.56	10.33	12.19	0.00562	0.00550	0.00648	PASS
Extreme (0°C)		5.25	5.86	3.47	0.00279	0.00312	0.00184	PASS
Extreme (-10°C)		13.71	10.06	7.28	0.00729	0.00535	0.00387	PASS
Extreme (-20°C)		14.14	12.53	4.88	0.00752	0.00667	0.00260	PASS
Extreme (-30°C)		17.55	12.93	16.57	0.00934	0.00688	0.00881	PASS
25°C		LV	7.89	10.36	2.16	0.00420	0.00551	0.00115
	HV	12.16	16.41	2.34	0.00647	0.00873	0.00124	PASS



LTE Band 2(1880MHz)

Condition		Freq.Error (Hz)	Freq.Error (Hz)	Freq.Error (Hz)	Frequency Stability (ppm)	Frequency Stability (ppm)	Frequency Stability (ppm)	Verdict
BANDWIDTH	5MHz							
Temperature	Voltage	64QAM	16QAM	QPSK	64QAM	16QAM	QPSK	
Normal (25°C)	Normal	7.78	1.43	10.19	0.00414	0.00076	0.00542	PASS
Extreme (50°C)		12.85	3.98	12.52	0.00683	0.00211	0.00666	PASS
Extreme (40°C)		9.78	4.43	3.72	0.00520	0.00236	0.00198	PASS
Extreme (30°C)		10.33	1.66	6.73	0.00549	0.00089	0.00358	PASS
Extreme (20°C)		4.83	15.39	14.03	0.00257	0.00819	0.00746	PASS
Extreme (10°C)		17.05	17.13	13.56	0.00907	0.00911	0.00721	PASS
Extreme (0°C)		15.20	9.60	6.61	0.00809	0.00511	0.00352	PASS
Extreme (-10°C)		1.41	2.36	7.22	0.00075	0.00126	0.00384	PASS
Extreme (-20°C)		13.34	12.55	15.90	0.00709	0.00668	0.00846	PASS
Extreme (-30°C)		8.39	3.34	13.90	0.00446	0.00178	0.00739	PASS
25°C		LV	15.64	14.65	9.98	0.00832	0.00779	0.00531
	HV	8.27	7.89	3.08	0.00440	0.00420	0.00164	PASS
Condition		Freq.Error (Hz)	Freq.Error (Hz)	Freq.Error (Hz)	Frequency Stability (ppm)	Frequency Stability (ppm)	Frequency Stability (ppm)	Verdict
BANDWIDTH	10MHz							
Temperature	Voltage	64QAM	16QAM	QPSK	64QAM	16QAM	QPSK	
Normal (25°C)	Normal	15.65	1.13	3.65	0.00832	0.00060	0.00194	PASS
Extreme (50°C)		16.11	16.41	9.08	0.00857	0.00873	0.00483	PASS
Extreme (40°C)		7.54	9.60	15.82	0.00401	0.00511	0.00841	PASS
Extreme (30°C)		4.43	11.70	15.81	0.00236	0.00622	0.00841	PASS
Extreme (20°C)		13.10	17.28	4.50	0.00697	0.00919	0.00240	PASS
Extreme (10°C)		1.57	9.93	13.87	0.00084	0.00528	0.00738	PASS
Extreme (0°C)		13.74	6.57	9.02	0.00731	0.00350	0.00480	PASS
Extreme (-10°C)		13.16	1.54	10.45	0.00700	0.00082	0.00556	PASS
Extreme (-20°C)		9.16	11.53	4.71	0.00487	0.00613	0.00250	PASS
Extreme (-30°C)		6.70	3.77	11.25	0.00357	0.00200	0.00598	PASS
25°C		LV	8.15	1.52	10.90	0.00434	0.00081	0.00580
	HV	3.53	12.75	17.09	0.00188	0.00678	0.00909	PASS



LTE Band 2(1880MHz)

Condition		Freq.Error (Hz)	Freq.Error (Hz)	Freq.Error (Hz)	Frequency Stability (ppm)	Frequency Stability (ppm)	Frequency Stability (ppm)	Verdict
BANDWIDTH	15MHz							
Temperature	Voltage	64QAM	16QAM	QPSK	64QAM	16QAM	QPSK	
Normal (25°C)	Normal	1.72	6.45	6.78	0.00092	0.00343	0.00361	PASS
Extreme (50°C)		15.09	13.01	11.36	0.00803	0.00692	0.00604	PASS
Extreme (40°C)		16.03	1.63	16.67	0.00852	0.00087	0.00887	PASS
Extreme (30°C)		10.66	14.87	12.51	0.00567	0.00791	0.00666	PASS
Extreme (20°C)		16.24	1.39	11.28	0.00864	0.00074	0.00600	PASS
Extreme (10°C)		9.49	12.09	12.18	0.00505	0.00643	0.00648	PASS
Extreme (0°C)		5.82	7.70	7.52	0.00310	0.00410	0.00400	PASS
Extreme (-10°C)		15.51	16.03	1.26	0.00825	0.00853	0.00067	PASS
Extreme (-20°C)		17.18	13.30	12.21	0.00914	0.00708	0.00649	PASS
Extreme (-30°C)		3.23	4.01	17.49	0.00172	0.00213	0.00930	PASS
25°C	LV	11.95	13.65	16.64	0.00635	0.00726	0.00885	PASS
	HV	15.82	15.77	1.67	0.00842	0.00839	0.00089	PASS
Condition		Freq.Error (Hz)	Freq.Error (Hz)	Freq.Error (Hz)	Frequency Stability (ppm)	Frequency Stability (ppm)	Frequency Stability (ppm)	Verdict
BANDWIDTH	20MHz							
Temperature	Voltage	64QAM	16QAM	QPSK	64QAM	16QAM	QPSK	
Normal (25°C)	Normal	10.15	7.43	16.99	0.00540	0.00395	0.00904	PASS
Extreme (50°C)		6.99	3.21	10.71	0.00372	0.00171	0.00570	PASS
Extreme (40°C)		8.20	16.20	13.64	0.00436	0.00862	0.00726	PASS
Extreme (30°C)		12.18	1.55	10.85	0.00648	0.00082	0.00577	PASS
Extreme (20°C)		10.86	11.30	6.07	0.00578	0.00601	0.00323	PASS
Extreme (10°C)		3.35	6.23	12.07	0.00178	0.00331	0.00642	PASS
Extreme (0°C)		15.86	1.89	13.08	0.00843	0.00101	0.00696	PASS
Extreme (-10°C)		6.33	12.54	17.88	0.00337	0.00667	0.00951	PASS
Extreme (-20°C)		16.33	10.30	17.47	0.00869	0.00548	0.00929	PASS
Extreme (-30°C)		8.38	11.93	6.41	0.00445	0.00635	0.00341	PASS
25°C	LV	15.19	4.14	13.50	0.00808	0.00220	0.00718	PASS
	HV	11.89	15.14	12.76	0.00632	0.00805	0.00679	PASS

5.6. Spurious Emissions at Antenna Terminals

Ambient condition

Temperature	Relative humidity	Pressure
23°C ~25°C	45%~50%	101.5kPa

Method of Measurement

The EUT was connected to Spectrum Analyzer and Base Station Simulator via power Splitter. The measurement is carried out using a spectrum analyzer. The spectrum analyzer scans from 9kHz to the 10th harmonic of the carrier. The peak detector is used.

RBW is set to 100kHz, VBW is set to 300kHz for 30MHz~1GHz

RBW is set to 1MHz, VBW is set to 3MHz for above 1GHz, Sweep is set to ATUO.

RBW is set to 1 kHz (0.009MHz~ 0.15 MHz),

RBW is set to 10 kHz (0.15 MHz~ 30 MHz)

RBW is set to 100 kHz (30MHz~1000 MHz)

RBW is set to 1000 kHz (above 1000MHz)

The modulation mode and RB allocation refer to section 5.1, using the maximum output power configuration.

Test setup

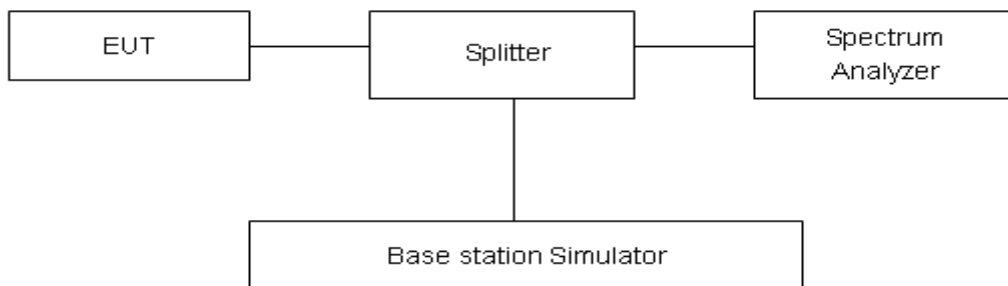

Limits

Rule Part 24.238(a) specifies that “on any frequency outside a licensee’s frequency block, the power of any emission shall be attenuated below the transmitter power (P) by at least 43 + 10 log₁₀ (P) dB.”

Limit	-13 dBm
-------	---------

Measurement Uncertainty

The assessed measurement uncertainty to ensure 99.75% confidence level for the normal distribution is with the coverage factor $k = 1.96$.

Frequency	Uncertainty
9kHz-1GHz	0.684 dB
1GHz-20GHz	1.407 dB



Test Result

Sweep the whole frequency band through the range from 9kHz to the 10th harmonic of the carrier, the emissions more than 20 dB below the limit are not reported.

The signal beyond the limit is carrier.

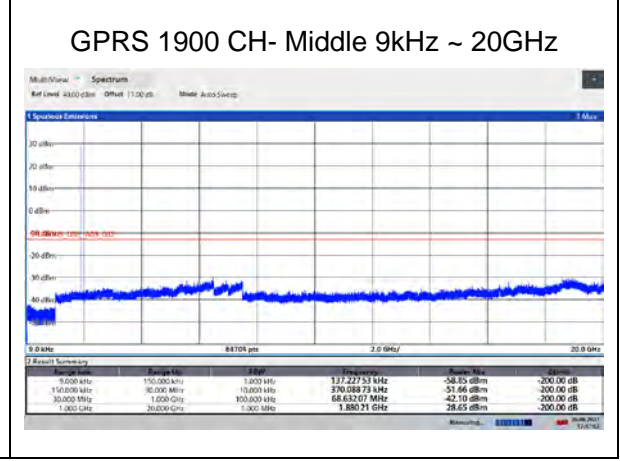
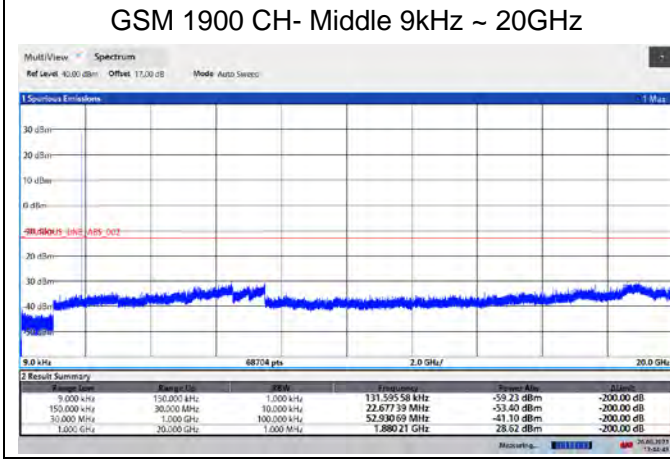
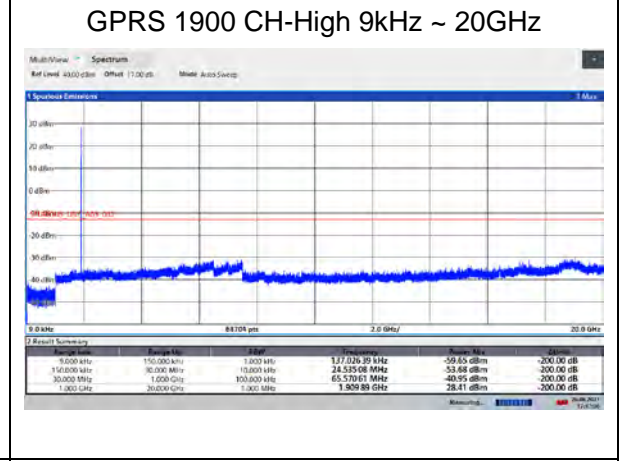
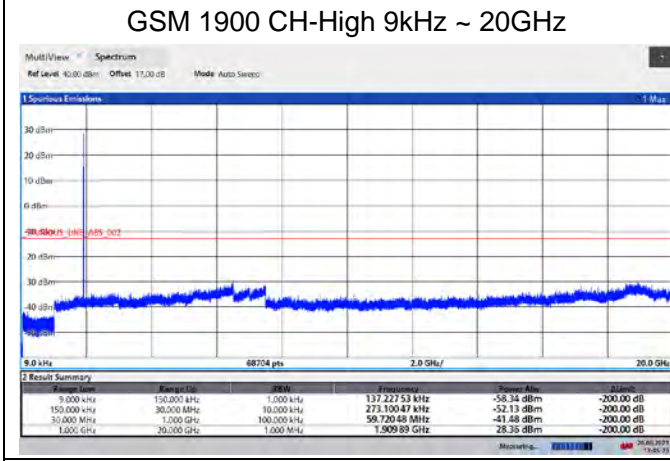
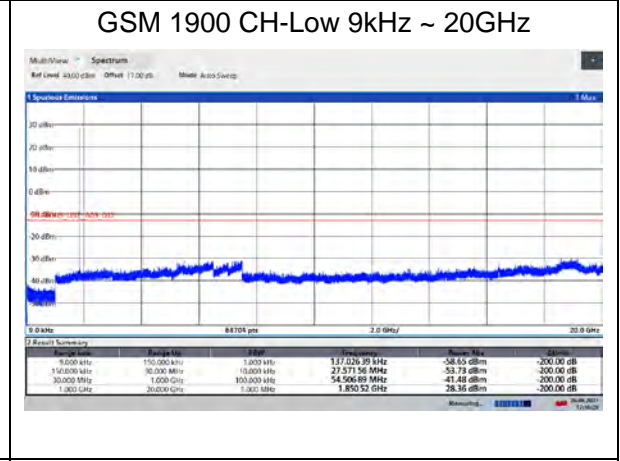
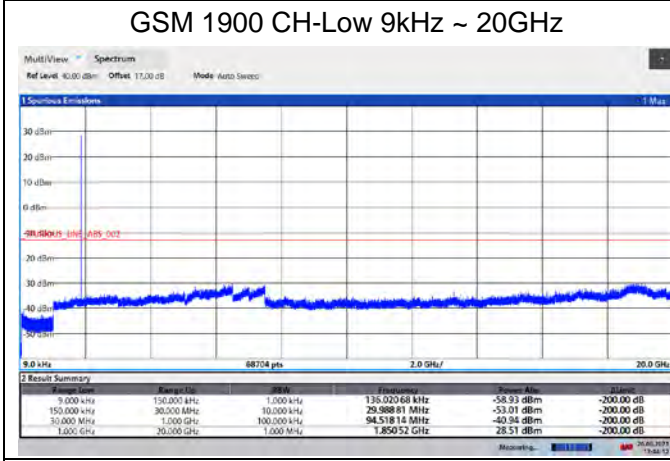



EGPRS 1900 CH-Low 9kHz ~ 20GHz

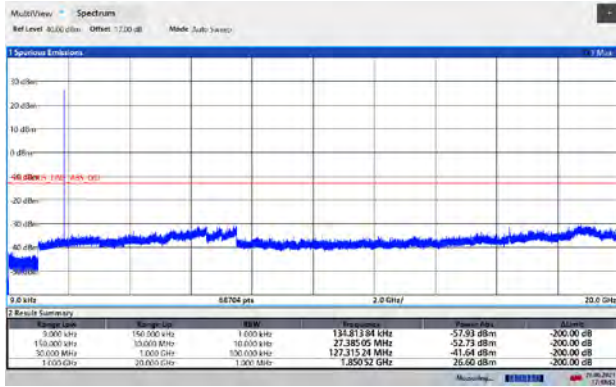

WCDMA BAND II CH-Low 9kHz ~ 20GHz

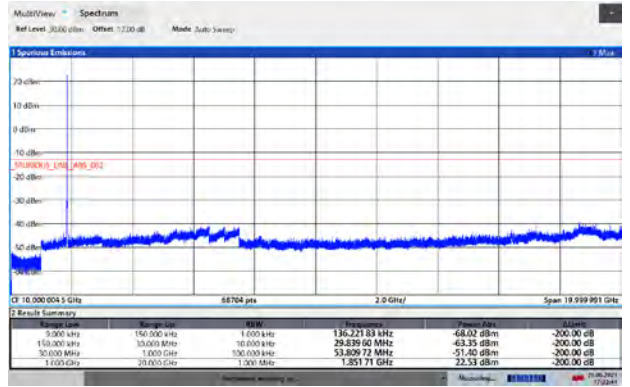

EGPRS 1900 CH-High 9kHz ~ 20GHz

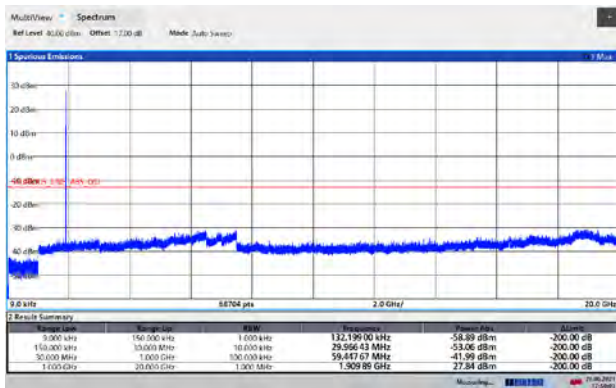

WCDMA BAND II CH-High 9kHz ~ 20GHz

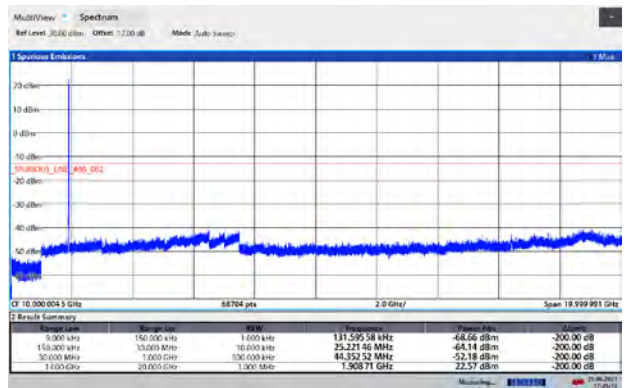

EGPRS 1900 CH- Middle 9kHz ~ 20GHz

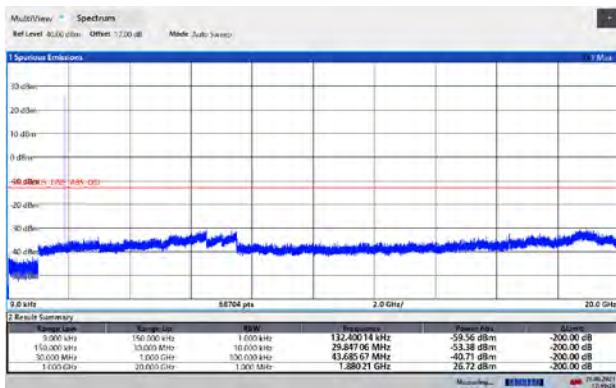

WCDMA BAND II CH- Middle 9kHz ~ 20GHz

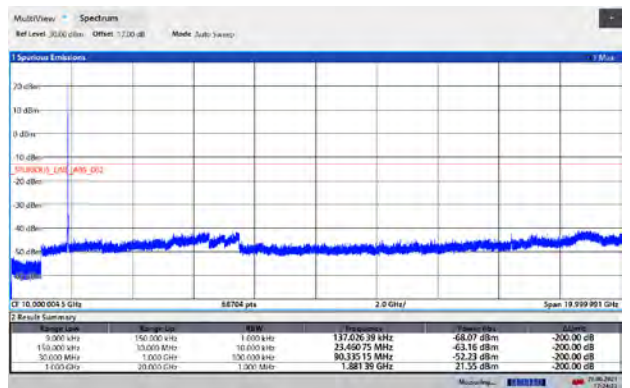

LTE Band 2 1.4MHz CH-Low 9kHz~20GHz

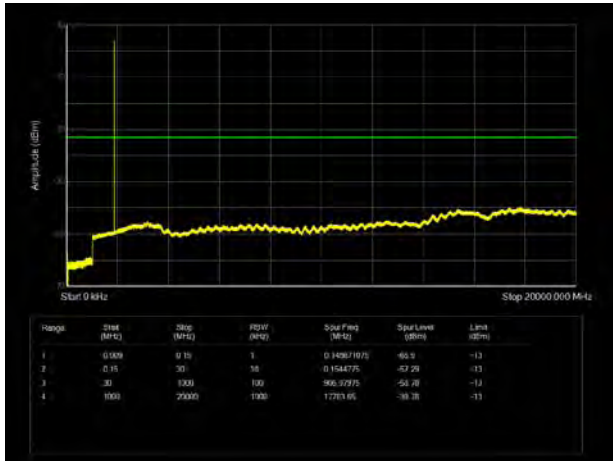

LTE Band 2 3MHz CH-Low 9kHz~20GHz

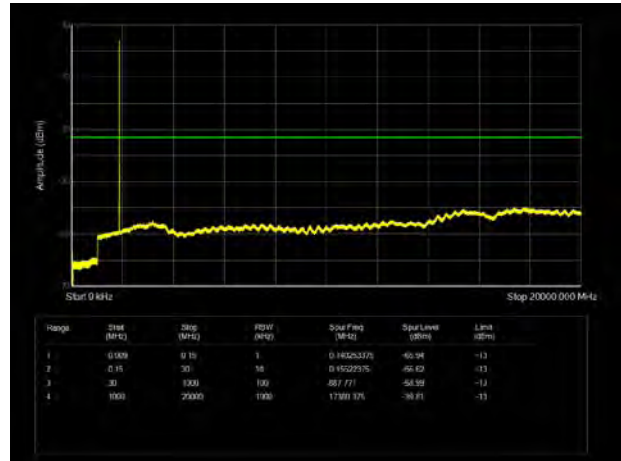

LTE Band 2 1.4MHz CH-Middle 9kHz~20GHz

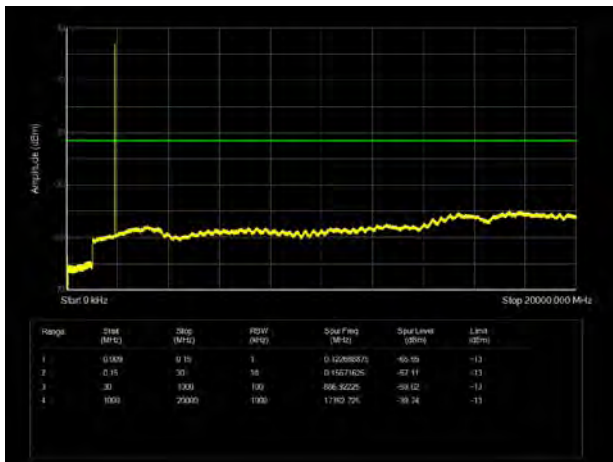

LTE Band 2 3MHz CH-Middle 9kHz~20GHz

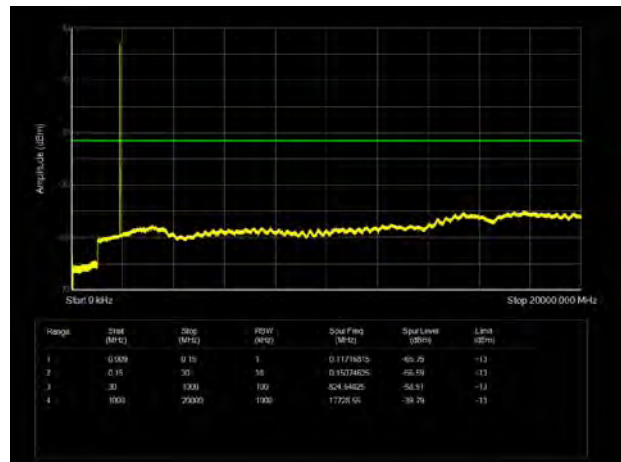

LTE Band 2 1.4MHz CH-High 9kHz~20GHz

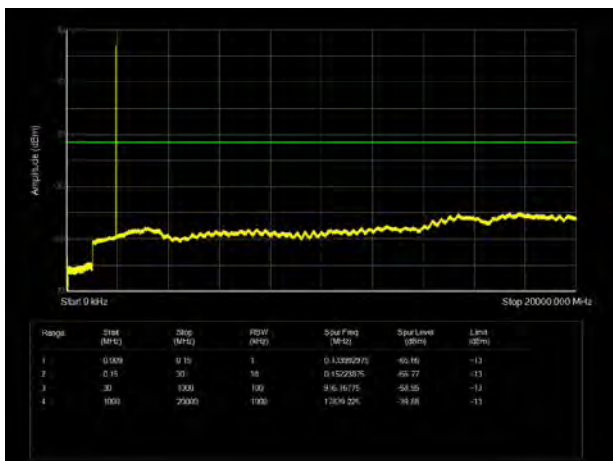

LTE Band 2 3MHz CH-High 9kHz~20GHz

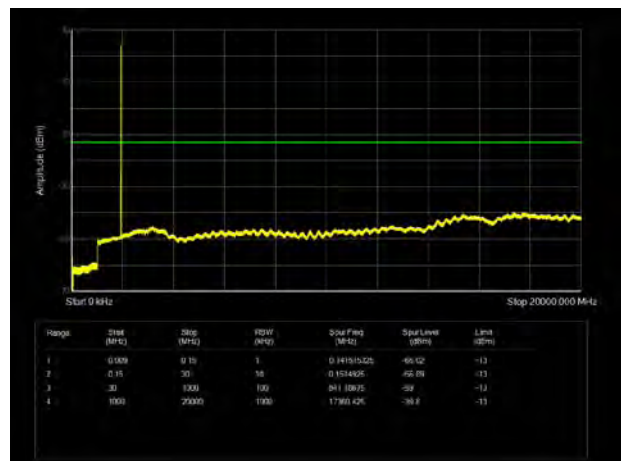

LTE Band 2 5MHz CH-Low 9kHz~20GHz

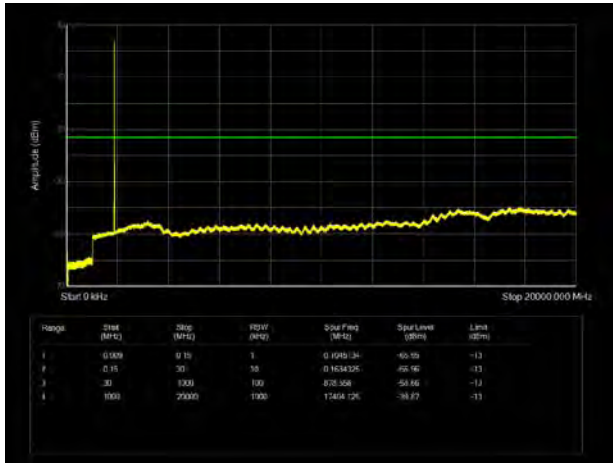

LTE Band 2 10MHz CH-Low 9kHz~20GHz

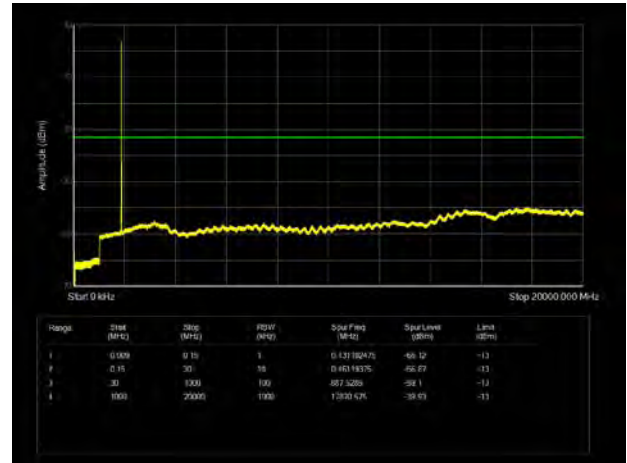

LTE Band 2 5MHz CH-Middle 9kHz~20GHz

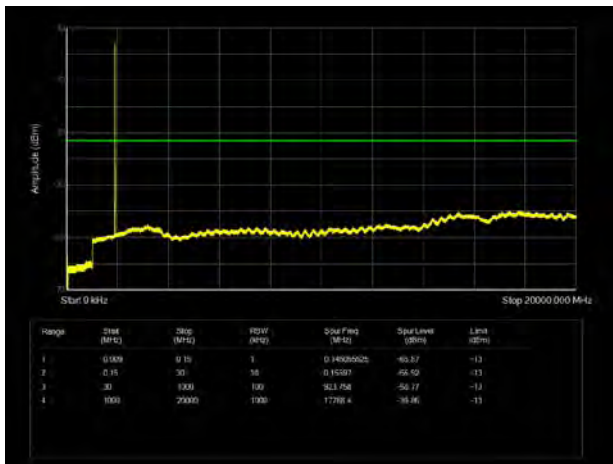

LTE Band 2 10MHz CH-Middle 9kHz~20GHz

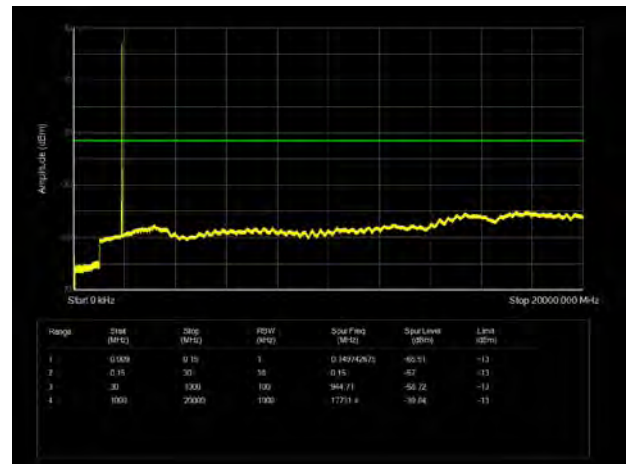

LTE Band 2 5MHz CH-High 9kHz~20GHz

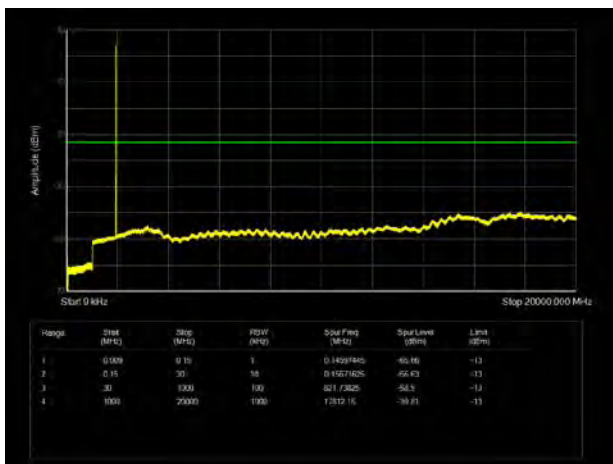

LTE Band 2 10MHz CH-High 9kHz~20GHz

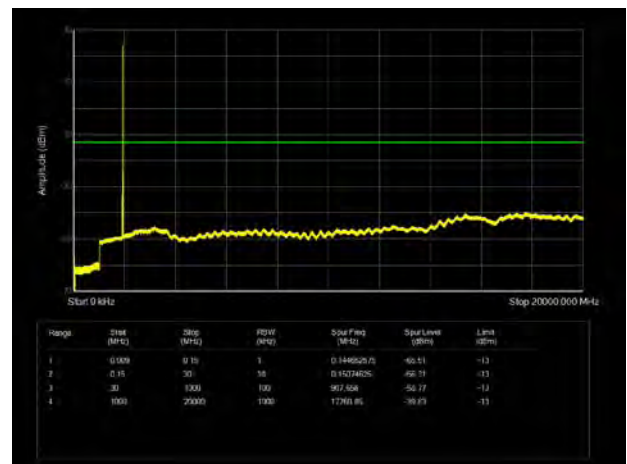

LTE Band 2 15MHz CH-Low 9kHz~20GHz

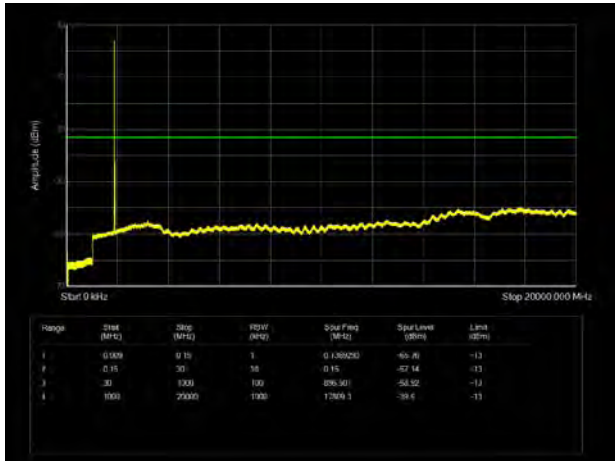

LTE Band 2 20MHz CH-Low 9kHz~20GHz

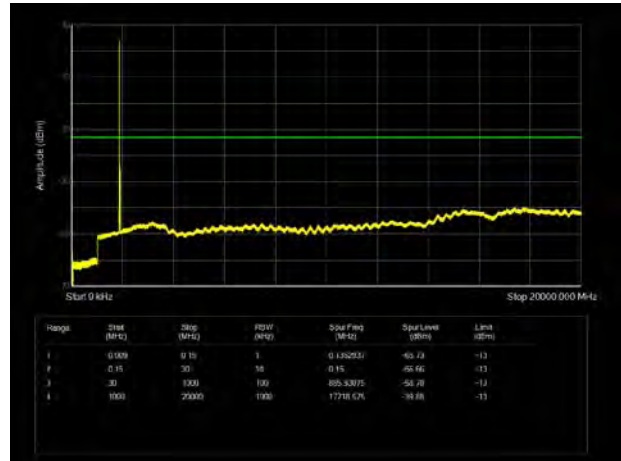

LTE Band 2 15MHz CH-Middle 9kHz~20GHz

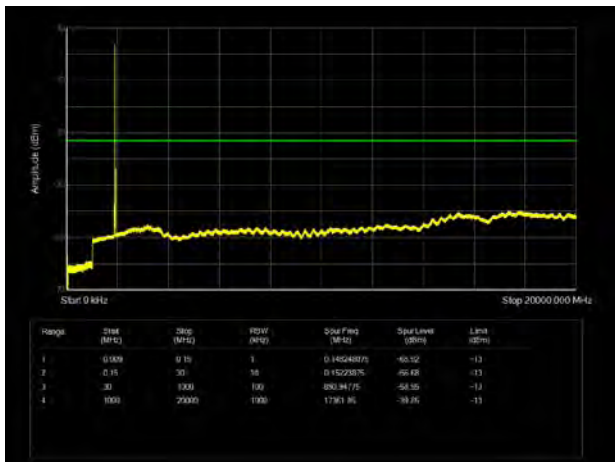

LTE Band 2 20MHz CH-Middle 9kHz~20GHz

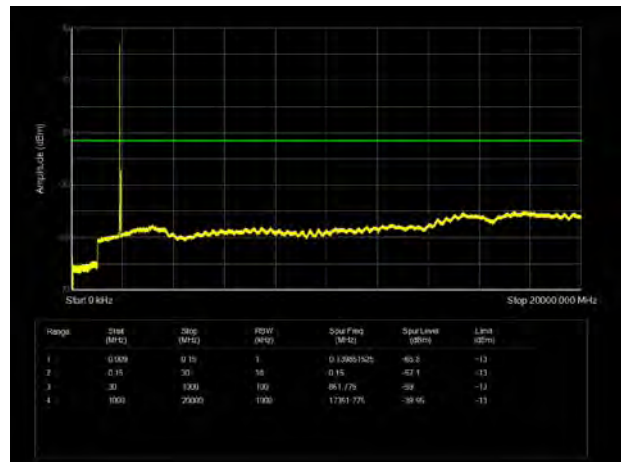

LTE Band 2 15MHz CH-High 9kHz~20GHz

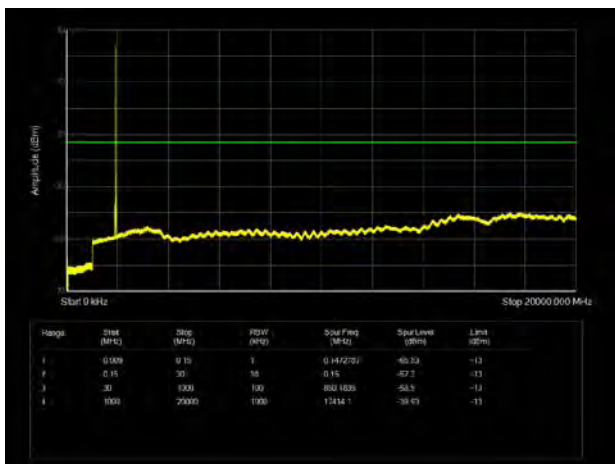

LTE Band 2 20MHz CH-High 9kHz~20GHz

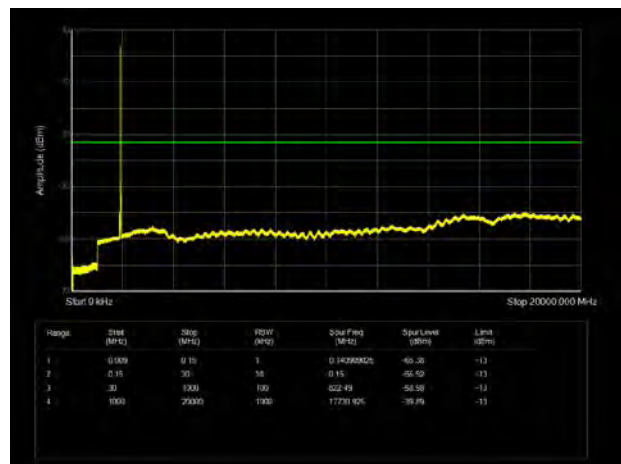

5.7. Radiates Spurious Emission

Ambient condition

Temperature	Relative humidity	Pressure
23°C ~25°C	45%~50%	101.5kPa

Method of Measurement

1. The testing follows FCC KDB 971168 v03r01 Section 5.8 and ANSI C63.26 (2015).
2. Below 1GHz: The EUT is placed on a turntable 0.8 meters above the ground in the chamber, 3 meter away from the antenna. The maximal emission value is acquired by adjusting the antenna height, polarisation and turntable azimuth. Normally, the height range of antenna is 1 m to 4 m, the azimuth range of turntable is 0° to 360°, and the receive antenna has two polarizations Vertical (V) and Horizontal (H). Above 1GHz: (Note: the FCC's permission to use 1.5m as an alternative per TCBC Conf call of Dec. 2, 2014.) The EUT is placed on a turntable 1.5 meters above the ground in the chamber, 3 meter away from the antenna. The maximal emission value is acquired by adjusting the antenna height, polarisation and turntable azimuth. Normally, the height range of antenna is 1 m to 4 m, the azimuth range of turntable is 0° to 360°, and the receive antenna has two polarizations Vertical (V) and Horizontal (H).
3. A loop antenna, A log-periodic antenna or horn antenna shall be substituted in place of the EUT. The log-periodic antenna will be driven by a signal generator and the level will be adjusted till the same power value on the spectrum analyzer or receiver. The level of the spurious emissions can be calculated through the level of the signal generator, cable loss, the gain of the substitution antenna and the reading of the spectrum analyzer or receiver.
4. The EUT is then put into continuously transmitting mode at its maximum power level during the test. Set Test Receiver or Spectrum RBW=1MHz, VBW=3MHz, and the maximum value of the receiver should be recorded as (Pr).
5. The EUT shall be replaced by a substitution antenna. In the chamber, an substitution antenna for the frequency band of interest is placed at the reference point of the chamber. An RF Signal source for the frequency band of interest is connected to the substitution antenna with a cable that has been constructed to not interfere with the radiation pattern of the antenna. A power (PMea) is applied to the input of the substitution antenna, and adjust the level of the signal generator output until the value of the receiver reach the previously recorded (Pr). The power of signal source (PMea) is recorded. The test should be performed by rotating the test item and adjusting the receiving antenna polarization.
6. A amplifier should be connected to the Signal Source output port. And the cable should be connect between the Amplifier and the Substitution Antenna. The cable loss (Pcl) ,the Substitution Antenna Gain (Ga) and the Amplifier Gain (PAG) should be recorded after test.
7. The measurement results are obtained as described below:
$$\text{Power(EIRP)} = \text{PMea} - \text{PAG} - \text{Pcl} + \text{Ga}$$
The measurement results are amend as described below:
$$\text{Power(EIRP)} = \text{PMea} - \text{Pcl} + \text{Ga}$$
8. This value is EIRP since the measurement is calibrated using an antenna of known gain (2.15 dBi) and known input power. ERP can be calculated from EIRP by subtracting the gain of the dipole, ERP

= EIRP-2.15dBi.

The modulation mode and RB allocation refer to section 5.1, using the maximum output power configuration.

Test setup

9KHz ~ 30MHz

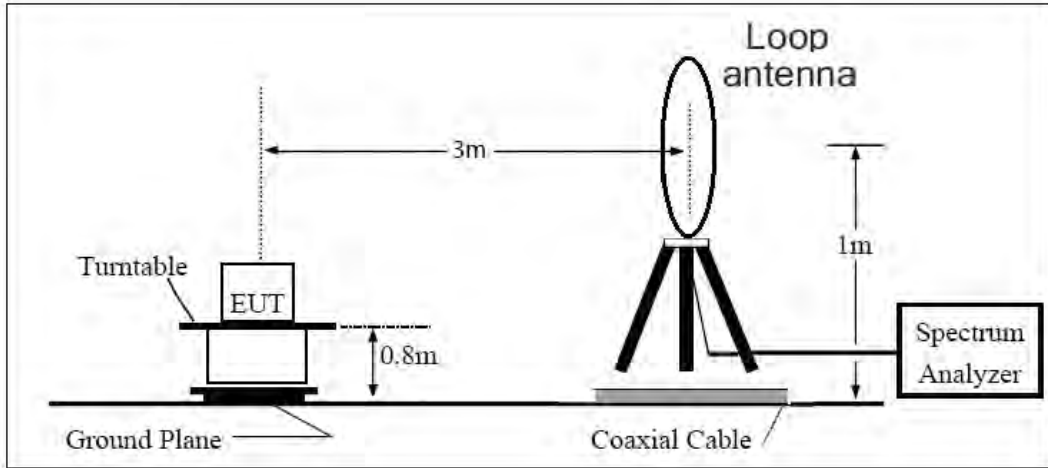

30MHz ~ 1GHz

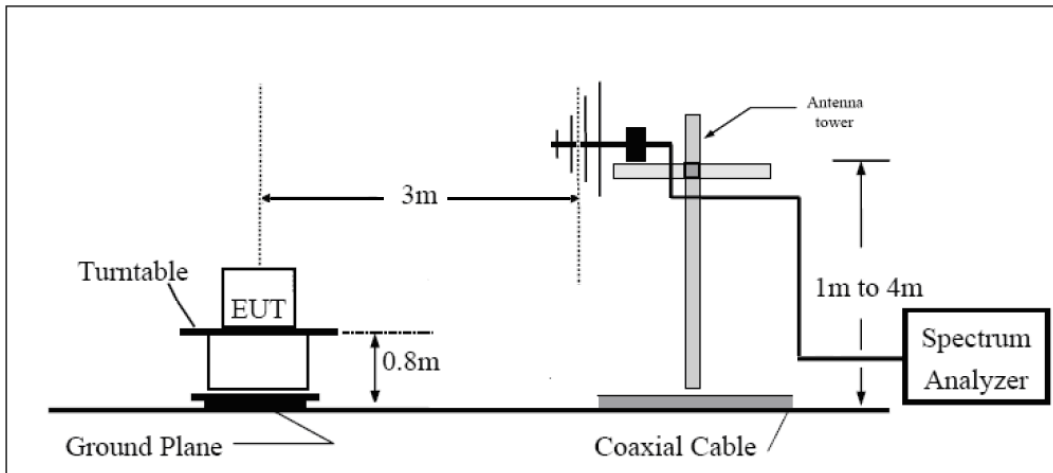

Above 1GHz

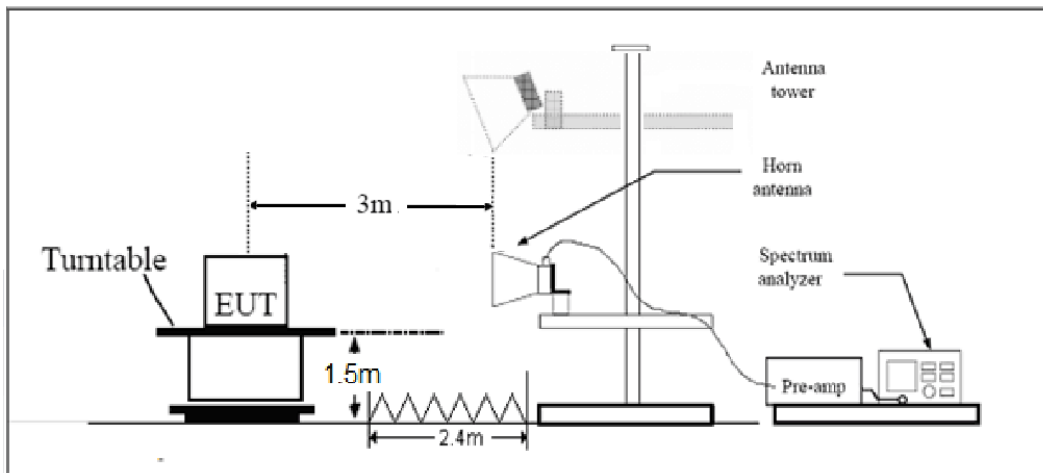

Note: Area side: 2.4mX3.6m

**Limits**

Rule Part 24.238(a) specifies that “on any frequency outside a licensee's frequency block, the power of any emission shall be attenuated below the transmitter power (P) by at least $43 + 10 \log_{10}(P)$ dB.”

Limit	-13 dBm
-------	---------

Measurement Uncertainty

The assessed measurement uncertainty to ensure 95% confidence level for the normal distribution is with the coverage factor $k = 1.96$, $U = 3.55$ dB.

Test Result

Sweep the whole frequency band through the range from 9kHz to the 10th harmonic of the carrier, the emissions below the noise floor will not be recorded in the report.

Main Antenna

GSM 1900 CH-Middle

Harmonic	Frequency (MHz)	SG (dBm)	Cable Loss (dB)	Gain (dBi)	Antenna Polarization	EIRP Level (dBm)	Limit (dBm)	Margin (dB)	Azimuth (deg)
2	3760.00	-57.57	2.60	12.50	Horizontal	-47.67	-13.00	34.67	45
3	5640.00	-55.48	3.30	12.50	Horizontal	-46.28	-13.00	33.28	225
4	7520.00	-56.31	4.20	12.20	Horizontal	-48.31	-13.00	35.31	0
5	9400.00	-52.82	4.30	11.10	Horizontal	-46.02	-13.00	33.02	135
6	11280.00	-49.88	5.90	11.90	Horizontal	-43.88	-13.00	30.88	45
7	13160.00	-50.49	5.70	14.00	Horizontal	-42.19	-13.00	29.19	0
8	15040.00	-46.37	5.80	13.10	Horizontal	-39.07	-13.00	26.07	135
9	16920.00	-49.40	6.10	14.60	Horizontal	-40.90	-13.00	27.90	45
10	18800.00	/	6.00	10.10	Horizontal	/	-13.00	/	/

Note: 1. The other Spurious RF Radiated emissions level is no more than noise floor.
 2. The worst emission was found in the antenna is Horizontal position.

WCDMA Band II CH-Middle

Harmonic	Frequency (MHz)	SG (dBm)	Cable Loss (dB)	Gain (dBi)	Antenna Polarization	EIRP Level (dBm)	Limit (dBm)	Margin (dB)	Azimuth (deg)
2	3760.00	-64.73	2.60	12.50	Horizontal	-54.83	-13.00	41.83	45
3	5640.00	-60.44	3.30	12.50	Horizontal	-51.24	-13.00	38.24	180
4	7520.00	-56.83	4.20	12.20	Horizontal	-48.83	-13.00	35.83	45
5	9400.00	-49.14	4.30	11.10	Horizontal	-42.34	-13.00	29.34	225
6	11280.00	-48.27	5.90	11.90	Horizontal	-42.27	-13.00	29.27	90
7	13160.00	-50.83	5.70	14.00	Horizontal	-42.53	-13.00	29.53	45
8	15040.00	-45.69	5.80	13.10	Horizontal	-38.39	-13.00	25.39	315
9	16920.00	-48.51	6.10	14.60	Horizontal	-40.01	-13.00	27.01	90
10	18800.00	/	6.00	10.10	/	/	-13.00	/	/

Note: 1. The other Spurious RF Radiated emissions level is no more than noise floor.
 2. The worst emission was found in the antenna is Horizontal position.



LTE Band 2 1.4MHz CH-Middle

Harmonic	Frequency (MHz)	SG (dBm)	Cable Loss (dB)	Gain (dBi)	Antenna Polarization	EIRP Level (dBm)	Limit (dBm)	Margin (dB)	Azimuth (deg)
2	3759.00	-59.70	2.60	12.50	Horizontal	-49.80	-13.00	36.80	225
3	5638.88	-36.69	3.30	12.50	Horizontal	-27.49	-13.00	14.49	45
4	7520.00	-54.34	4.20	12.20	Horizontal	-46.34	-13.00	33.34	135
5	9400.00	-49.17	4.30	11.10	Horizontal	-42.37	-13.00	29.37	45
6	11280.00	-46.80	5.90	11.90	Horizontal	-40.80	-13.00	27.80	0
7	13160.00	-49.16	5.70	14.00	Horizontal	-40.86	-13.00	27.86	135
8	15040.00	-43.80	5.80	13.10	Horizontal	-36.50	-13.00	23.50	45
9	16920.00	-46.96	6.10	14.60	Horizontal	-38.46	-13.00	25.46	225
10	18800.00	/	6.00	10.10	Horizontal	/	-13.00	/	/

Note: 1.The other Spurious RF Radiated emissions level is no more than noise floor.
2. The worst emission was found in the antenna is Horizontal position.

LTE Band 2 5MHz CH-Middle

Harmonic	Frequency (MHz)	SG (dBm)	Cable Loss (dB)	Gain (dBi)	Antenna Polarization	EIRP Level (dBm)	Limit (dBm)	Margin (dB)	Azimuth (deg)
2	3755.63	-58.75	2.60	12.50	Horizontal	-48.85	-13.00	35.85	135
3	5633.63	-34.77	3.30	12.50	Horizontal	-25.57	-13.00	12.57	0
4	7520.00	-54.96	4.20	12.20	Horizontal	-46.96	-13.00	33.96	225
5	9400.00	-49.31	4.30	11.10	Horizontal	-42.51	-13.00	29.51	90
6	11280.00	-46.22	5.90	11.90	Horizontal	-40.22	-13.00	27.22	0
7	13160.00	-48.50	5.70	14.00	Horizontal	-40.20	-13.00	27.20	135
8	15040.00	-44.15	5.80	13.10	Horizontal	-36.85	-13.00	23.85	45
9	16920.00	-46.17	6.10	14.60	Horizontal	-37.67	-13.00	24.67	225
10	18800.00	/	6.00	10.10	Horizontal	/	-13.00	/	/

Note: 1.The other Spurious RF Radiated emissions level is no more than noise floor.
2. The worst emission was found in the antenna is Horizontal position.



LTE Band 2 20MHz CH-Middle

Harmonic	Frequency (MHz)	SG (dBm)	Cable Loss (dB)	Gain (dBi)	Antenna Polarization	EIRP Level (dBm)	Limit (dBm)	Margin (dB)	Azimuth (deg)
2	3742.13	-57.84	2.60	12.50	Horizontal	-47.94	-13.00	34.94	135
3	5613.38	-34.78	3.30	12.50	Horizontal	-25.58	-13.00	12.58	0
4	7484.63	-54.88	4.20	12.20	Horizontal	-46.88	-13.00	33.88	45
5	9400.00	-48.57	4.30	11.10	Horizontal	-41.77	-13.00	28.77	135
6	11280.00	-47.76	5.90	11.90	Horizontal	-41.76	-13.00	28.76	90
7	13160.00	-48.82	5.70	14.00	Horizontal	-40.52	-13.00	27.52	225
8	15040.00	-43.69	5.80	13.10	Horizontal	-36.39	-13.00	23.39	135
9	16920.00	-47.06	6.10	14.60	Horizontal	-38.56	-13.00	25.56	0
10	18800.00	/	6.00	10.10	Horizontal	/	-13.00	/	/

Note: 1.The other Spurious RF Radiated emissions level is no more than noise floor.
2. The worst emission was found in the antenna is Horizontal position.

**Second Antenna**

Harmonic	Frequency (MHz)	SG (dBm)	Cable Loss (dB)	Gain (dBi)	Antenna Polarization	EIRP Level (dBm)	Limit (dBm)	Margin (dB)	Azimuth (deg)
2	3760.00	-58.50	2.60	12.50	Horizontal	-48.60	-13.00	35.60	0
3	5640.00	-45.57	3.30	12.50	Horizontal	-36.37	-13.00	23.37	225
4	7520.00	-57.04	4.20	12.20	Horizontal	-49.04	-13.00	36.04	45
5	9400.00	-52.68	4.30	11.10	Horizontal	-45.88	-13.00	32.88	135
6	11280.00	-48.87	5.90	11.90	Horizontal	-42.87	-13.00	29.87	0
7	13160.00	-52.18	5.70	14.00	Horizontal	-43.88	-13.00	30.88	45
8	15040.00	-47.37	5.80	13.10	Horizontal	-40.07	-13.00	27.07	225
9	16920.00	-49.25	6.10	14.60	Horizontal	-40.75	-13.00	27.75	135
10	18800.00	/	6.00	10.10	Horizontal	/	-13.00	/	/

Note: 1.The other Spurious RF Radiated emissions level is no more than noise floor.
2. The worst emission was found in the antenna is Horizontal position.

WCDMA Band II CH-Middle

Harmonic	Frequency (MHz)	SG (dBm)	Cable Loss (dB)	Gain (dBi)	Antenna Polarization	EIRP Level (dBm)	Limit (dBm)	Margin (dB)	Azimuth (deg)
2	3760.00	-67.45	2.60	12.50	Horizontal	-57.55	-13.00	44.55	45
3	5640.00	-60.86	3.30	12.50	Horizontal	-51.66	-13.00	38.66	0
4	7520.00	-57.33	4.20	12.20	Horizontal	-49.33	-13.00	36.33	225
5	9400.00	-53.21	4.30	11.10	Horizontal	-46.41	-13.00	33.41	135
6	11280.00	-50.75	5.90	11.90	Horizontal	-44.75	-13.00	31.75	45
7	13160.00	-52.53	5.70	14.00	Horizontal	-44.23	-13.00	31.23	0
8	15040.00	-47.62	5.80	13.10	Horizontal	-40.32	-13.00	27.32	90
9	16920.00	-50.76	6.10	14.60	Horizontal	-42.26	-13.00	29.26	90
10	18800.00	/	6.00	10.10	/	/	-13.00	/	/

Note: 1.The other Spurious RF Radiated emissions level is no more than noise floor.
2. The worst emission was found in the antenna is Horizontal position.



LTE Band 2 1.4MHz CH-Middle

Harmonic	Frequency (MHz)	SG (dBm)	Cable Loss (dB)	Gain (dBi)	Antenna Polarization	EIRP Level (dBm)	Limit (dBm)	Margin (dB)	Azimuth (deg)
2	3759.00	-66.24	2.60	12.50	Horizontal	-56.34	-13.00	43.34	0
3	5638.88	-37.73	3.30	12.50	Horizontal	-28.53	-13.00	15.53	45
4	7520.00	-58.30	4.20	12.20	Horizontal	-50.30	-13.00	37.30	225
5	9400.00	-53.52	4.30	11.10	Horizontal	-46.72	-13.00	33.72	135
6	11280.00	-50.89	5.90	11.90	Horizontal	-44.89	-13.00	31.89	90
7	13160.00	-53.77	5.70	14.00	Horizontal	-45.47	-13.00	32.47	135
8	15040.00	-48.27	5.80	13.10	Horizontal	-40.97	-13.00	27.97	45
9	16920.00	-53.84	6.10	14.60	Horizontal	-45.34	-13.00	32.34	45
10	18800.00	/	6.00	10.10	Horizontal	/	-13.00	/	/

Note: 1.The other Spurious RF Radiated emissions level is no more than noise floor.
2. The worst emission was found in the antenna is Horizontal position.

LTE Band 2 5MHz CH-Middle

Harmonic	Frequency (MHz)	SG (dBm)	Cable Loss (dB)	Gain (dBi)	Antenna Polarization	EIRP Level (dBm)	Limit (dBm)	Margin (dB)	Azimuth (deg)
2	3755.63	-66.41	2.60	12.50	Horizontal	-56.51	-13.00	43.51	135
3	5633.63	-40.90	3.30	12.50	Horizontal	-31.70	-13.00	18.70	45
4	7520.00	-57.48	4.20	12.20	Horizontal	-49.48	-13.00	36.48	225
5	9400.00	-54.24	4.30	11.10	Horizontal	-47.44	-13.00	34.44	45
6	11280.00	-51.88	5.90	11.90	Horizontal	-45.88	-13.00	32.88	0
7	13160.00	-53.39	5.70	14.00	Horizontal	-45.09	-13.00	32.09	225
8	15040.00	-47.75	5.80	13.10	Horizontal	-40.45	-13.00	27.45	135
9	16920.00	-51.99	6.10	14.60	Horizontal	-43.49	-13.00	30.49	45
10	18800.00	/	6.00	10.10	Horizontal	/	-13.00	/	/

Note: 1.The other Spurious RF Radiated emissions level is no more than noise floor.
2. The worst emission was found in the antenna is Horizontal position.



LTE Band 2 20MHz CH-Middle

Harmonic	Frequency (MHz)	SG (dBm)	Cable Loss (dB)	Gain (dBi)	Antenna Polarization	EIRP Level (dBm)	Limit (dBm)	Margin (dB)	Azimuth (deg)
2	3742.13	-65.89	2.60	12.50	Horizontal	-55.99	-13.00	42.99	135
3	5613.38	-40.55	3.30	12.50	Horizontal	-31.35	-13.00	18.35	45
4	7484.63	-56.88	4.20	12.20	Horizontal	-48.88	-13.00	35.88	135
5	9400.00	-52.34	4.30	11.10	Horizontal	-45.54	-13.00	32.54	0
6	11280.00	-51.70	5.90	11.90	Horizontal	-45.70	-13.00	32.70	45
7	13160.00	-52.83	5.70	14.00	Horizontal	-44.53	-13.00	31.53	45
8	15040.00	-47.30	5.80	13.10	Horizontal	-40.00	-13.00	27.00	0
9	16920.00	-50.53	6.10	14.60	Horizontal	-42.03	-13.00	29.03	135
10	18800.00	/	6.00	10.10	Horizontal	/	-13.00	/	/

Note: 1. The other Spurious RF Radiated emissions level is no more than noise floor.
2. The worst emission was found in the antenna is Horizontal position.



6. Main Test Instruments

Name	Manufacturer	Type	Serial Number	Calibration Date	Expiration Date
Base Station Simulator	R&S	CMU200	118133	2021-05-15	2022-05-14
Power Splitter	Hua Xiang	SHX-GF2-2-13	10120101	/	/
Spectrum Analyzer	Key sight	N9010A	MY50210259	2021-05-15	2022-05-14
Universal Radio Communication Tester	Key sight	E5515C	MY48367192	2021-5-15	2022-5-14
Signal Analyzer	R&S	FSV3030	101411	2020-12-13	2021-12-12
Loop Antenna	SCHWARZBECK	FMZB1519	1519-047	2020-04-02	2023-04-01
TRILOG Broadband Antenna	SCHWARZBECK	VULB 9163	391	2019-12-16	2022-12-15
Horn Antenna	R&S	HF907	102723	2018-08-11	2021-08-10
Horn Antenna	ETS-Lindgren	3160-09	00102643	2018-06-20	2023-06-19
Signal generator	R&S	SMB 100A	102594	2021-05-15	2022-05-14
Climatic Chamber	ESPEC	SU-242	93000506	2020-12-13	2021-12-12
Preamplifier	R&S	SCU18	102327	2021-05-15	2022-05-14
MOB COMMS DC SUPPLY	Keysight	66319D	MY43004105	2021-06-09	2021-12-08
RF Cable	Agilent	SMA 15cm	0001	2021-06-09	2021-12-08
Software	R&S	EMC32	9.26.0	/	/

*****END OF REPORT *****



ANNEX A: The EUT Appearance

The EUT Appearance are submitted separately.



ANNEX B: Test Setup Photos

The Test Setup Photos are submitted separately.