



RF TEST REPORT

Applicant Xiaomi Communications Co., Ltd.
FCC ID 2AFZZ1119AG
Product Mobile Phone
Model 21061119AG
Report No. R2105A0395-R6
Issue Date June 28, 2021

TA Technology (Shanghai) Co., Ltd. tested the above equipment in accordance with the requirements in **FCC CFR47 Part 15E (2020)**. The test results show that the equipment tested is capable of demonstrating compliance with the requirements as documented in this report.

Peng Tao

Prepared by: Peng Tao

Kai Xu

Approved by: Kai Xu

TA Technology (Shanghai) Co., Ltd.

No.145, Jintang Rd, Tangzhen Industry Park, Pudong Shanghai, China

TEL: +86-021-50791141/2/3

FAX: +86-021-50791141/2/3-8000



TABLE OF CONTENT

1. Test Laboratory	4
1.1. Notes of the test report.....	4
1.2. Test facility	4
1.3. Testing Location	4
2. General Description of Equipment under Test.....	5
2.1. Applicant and Manufacturer Information.....	5
2.2. General information.....	5
3. Applied Standards	6
4. Test Configuration	7
5. Test Case Results	9
5.1. Occupied Bandwidth	9
5.2. Average Power Output.....	27
5.3. Frequency Stability.....	34
5.4. Power Spectral Density.....	38
5.5. Unwanted Emission	54
5.6. Conducted Emission	140
6. Main Test Instruments.....	143
ANNEX A: The EUT Appearance	144
ANNEX B: Test Setup Photos	145

Summary of measurement results

Number	Test Case	Clause in FCC rules	Verdict
1	Average output power	15.407(a)	PASS
2	Occupied bandwidth	15.407(e)	PASS
3	Frequency stability	15.407(g)	PASS
4	Power spectral density	15.407(a)	PASS
5	Unwanted Emissions	15.407(b)	PASS
6	Conducted Emissions	15.207	PASS

Date of Testing: May 30, 2021 ~ June 17, 2021
Date of Sample Received: May 25, 2021

Note: PASS: The EUT complies with the essential requirements in the standard.
FAIL: The EUT does not comply with the essential requirements in the standard.
All indications of Pass/Fail in this report are opinions expressed by TA Technology (Shanghai) Co., Ltd. based on interpretations and/or observations of test results. Measurement Uncertainties were not taken into account and are published for informational purposes only.



1. Test Laboratory

1.1. Notes of the test report

This report shall not be reproduced in full or partial, without the written approval of **TA technology (shanghai) co., Ltd.** The results documented in this report apply only to the tested sample, under the conditions and modes of operation as described herein. Measurement Uncertainties were not taken into account and are published for informational purposes only. This report is written to support regulatory compliance of the applicable standards stated above.

1.2. Test facility

FCC (Designation number: CN1179, Test Firm Registration Number: 446626)

TA Technology (Shanghai) Co., Ltd. has been listed on the US Federal Communications Commission list of test facilities recognized to perform electromagnetic emissions measurements.

A2LA (Certificate Number: 3857.01)

TA Technology (Shanghai) Co., Ltd. has been listed by American Association for Laboratory Accreditation to perform electromagnetic emission measurement.

1.3. Testing Location

Company: TA Technology (Shanghai) Co., Ltd.
Address: No.145, Jintang Rd, Tangzhen Industry Park, Pudong
City: Shanghai
Post code: 201201
Country: P. R. China
Contact: Xu Kai
Telephone: +86-021-50791141/2/3
Fax: +86-021-50791141/2/3-8000
Website: <http://www.ta-shanghai.com>
E-mail: xukai@ta-shanghai.com

2. General Description of Equipment under Test

2.1. Applicant and Manufacturer Information

Applicant	Xiaomi Communications Co., Ltd.
Applicant address	#019, 9th Floor, Building 6, 33 Xi'erqi Middle Road, Haidian District, Beijing, China, 100085
Manufacturer	Xiaomi Communications Co., Ltd.
Manufacturer address	#019, 9th Floor, Building 6, 33 Xi'erqi Middle Road, Haidian District, Beijing, China, 100085

2.2. General information

EUT Description		
Model	21061119AG	
IMEI	IMEI 1: 863461050011766 IMEI 2: 863461050011774	
Hardware Version	P1.1	
Software Version	MIUI12.5	
Power Supply	Battery / AC adapter	
Antenna Type	PIFA Antenna	
Antenna Gain	U-NII-1	0.2dBi
	U-NII-2A	0.2dBi
	U-NII-2C	0dBi
	U-NII-3	0.2dBi
Test Band	U-NII-1(5150MHz-5250MHz) U-NII-2A(5250MHz-5350MHz) U-NII-2C(5470MHz-5725MHz) U-NII-3(5725MHz-5850MHz)	
Modulation Type	802.11a/n (HT20/HT40) : OFDM 802.11ac (VHT20/VHT40/VHT80): OFDM	
Max. Conducted Power	15.21dBm	
Operating Frequency Range(s)	U-NII-1: 5150MHz-5250MHz U-NII-2A:5250MHz -5350MHz U-NII-2C:5470MHz-5725MHz U-NII-3: 5725MHz -5850MHz	
Extreme temperature range:	-10° C to 60° C	
Operating temperature range:	-10° C to 60° C	
Operating voltage range:	3.6 V to 4.45 V	
State DC voltage:	3.87V	
Note:1. The EUT is sent from the applicant to TA and the information of the EUT is declared by the applicant.		



3. Applied Standards

According to the specifications of the manufacturer, it must comply with the requirements of the following standards:

Test standards:

FCC CFR47 Part 15E (2020) Unlicensed National Information Infrastructure Devices

ANSI C63.10 (2013)

Reference standard:

KDB 789033 D02 General UNII Test Procedures New Rules v02r01

4. Test Configuration

Test Mode

The EUT has been associated with peripherals and configuration operated in a manner tended to maximize its emission characteristics in a typical application.

The radiated emission was measured in the following position: EUT stand-up position (Z axis), lie-down position (X, Y axis). The worst emission was found in stand-up position (Z axis) and the worst case was recorded.

In order to find the worst case condition, Pre-tests are needed at the presence of different data rate. Preliminary tests have been done on all the configuration for confirming worst case. Data rate below means worst-case rate of each test item.

Worst-case data rates are shown as following table.

Mode	Data Rate
802.11a	6 Mbps
802.11n HT20	MCS0
802.11n HT40	MCS0
802.11ac VHT20	MCS0
802.11ac VHT40	MCS0
802.11ac VHT80	MCS0

Wireless Technology and Frequency Range

Wireless Technology		Bandwidth	Channel	Frequency	
Wi-Fi	U-NII-1	20 MHz	36	5180MHz	
			40	5200MHz	
			44	5220MHz	
			48	5240MHz	
		40 MHz	38	5190MHz	
			46	5230MHz	
	U-NII-2A	80 MHz	42	5210MHz	
			20 MHz	52	5260MHz
				56	5280MHz
		60		5300MHz	
		64		5320MHz	
		40 MHz	54	5270MHz	
			62	5310MHz	
		80 MHz	58	5290MHz	
U-NII-2C	20 MHz		100	5500MHz	



			104	5520MHz		
			108	5540MHz		
			112	5560MHz		
			116	5580MHz		
			120	5600MHz		
			124	5620MHz		
			128	5640MHz		
			132	5660MHz		
			136	5680MHz		
			140	5700MHz		
			144	5720MHz		
			40 MHz			102
	110	5550MHz				
	118	5590MHz				
	126	5630MHz				
	134	5670MHz				
	142	5710MHz				
	80 MHz			106	5530MHz	
				122	5610MHz	
				138	5690MHz	
	U-NII-3	20 MHz		149	5745MHz	
				153	5765MHz	
				157	5785MHz	
				161	5805MHz	
				165	5825MHz	
		40 MHz			151	5755MHz
					159	5795MHz
		80 MHz			155	5775MHz
		Does this device support TPC Function? <input type="checkbox"/> Yes <input checked="" type="checkbox"/> No				
	Does this device support TDWR Band? <input checked="" type="checkbox"/> Yes <input type="checkbox"/> No					

5. Test Case Results

5.1. Occupied Bandwidth

Ambient condition

Temperature	Relative humidity	Pressure
23°C ~25°C	45%~50%	101.5kPa

Method of Measurement

The EUT was connected to the spectrum analyzer through an external attenuator (20dB) and a known loss cable.

For U-NII-1/U-NII-2A/U-NII-2C, set RBW \approx 1% OCB kHz, VBW \geq 3 \times RBW, measure the maximum width of the emission that is constrained by the frequencies associated with the two outermost amplitude points (upper and lower frequencies) that are attenuated by 26 dB relative to the maximum level measured in the fundamental emission.

For U-NII-3, Set RBW = 100 kHz, VBW \geq 3 \times RBW, measure the maximum width of the emission that is constrained by the frequencies associated with the two outermost amplitude points (upper and lower frequencies) that are attenuated by 6 dB relative to the maximum level measured in the fundamental emission.

Note: The automatic bandwidth measurement capability of a spectrum analyzer or EMI receiver may be employed if it implements the functionality described above.

Use the 99 % power bandwidth function of the instrument

Test Setup

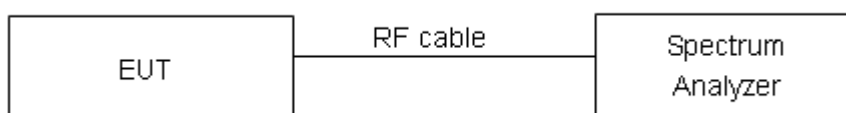

Limits

Rule FCC Part §15.407(e)

Within the 5.725-5.85 GHz band, the minimum 6 dB bandwidth of U-NII devices shall be at least 500 kHz.

Measurement Uncertainty

The assessed measurement uncertainty to ensure 95% confidence level for the normal distribution is with the coverage factor $k = 2$, $U = 936$ Hz.

**Test Results:****U-NII-1**

Mode	Carrier frequency (MHz)	99% bandwidth (MHz)	Minimum 26 dB bandwidth (MHz)	Conclusion
802.11a	5180	16.39	19.63	PASS
	5200	16.403	19.65	PASS
	5240	16.361	19.86	PASS
802.11n HT20	5180	17.51	19.82	PASS
	5200	17.532	19.96	PASS
	5240	17.527	20.08	PASS
802.11n HT40	5190	35.951	40.55	PASS
	5230	35.962	40.40	PASS
802.11ac VHT20	5180	17.506	19.84	PASS
	5200	17.554	19.90	PASS
	5240	17.539	19.96	PASS
802.11ac VHT40	5190	35.899	39.83	PASS
	5230	35.96	40.43	PASS
802.11ac VHT80	5210	75.332	80.63	PASS

U-NII-2A

Mode	Carrier frequency (MHz)	99% bandwidth (MHz)	Minimum 26 dB bandwidth (MHz)	Conclusion
802.11a	5260	16.403	19.43	PASS
	5300	16.398	19.61	PASS
	5320	16.359	19.46	PASS
802.11n HT20	5260	17.517	20.25	PASS
	5300	17.544	19.96	PASS
	5320	17.525	20.02	PASS
802.11n HT40	5270	35.931	40.07	PASS
	5310	35.977	40.41	PASS
802.11ac VHT20	5260	17.528	20.09	PASS
	5300	17.549	20.19	PASS
	5320	17.528	19.90	PASS
802.11ac VHT40	5270	35.856	40.22	PASS
	5310	35.893	40.54	PASS
802.11ac VHT80	5290	75.210	80.52	PASS



U-NII-2C

Mode	Carrier frequency (MHz)	99% bandwidth (MHz)	Minimum 26 dB bandwidth (MHz)	Conclusion
802.11a	5500	16.367	19.63	PASS
	5600	16.368	19.44	PASS
	5700	16.357	19.81	PASS
	5720	16.361	19.74	PASS
802.11n HT20	5500	17.523	20.00	PASS
	5600	17.523	20.06	PASS
	5700	17.549	19.97	PASS
	5720	17.539	20.04	PASS
802.11n HT40	5510	35.897	40.36	PASS
	5590	35.886	40.08	PASS
	5670	35.891	39.91	PASS
	5710	36.008	40.20	PASS
802.11ac VHT20	5500	17.517	20.14	PASS
	5600	17.520	19.87	PASS
	5700	17.512	20.03	PASS
	5720	17.536	20.07	PASS
802.11ac VHT40	5510	35.878	40.25	PASS
	5590	35.863	40.45	PASS
	5670	35.835	39.95	PASS
	5710	35.992	40.23	PASS
802.11ac VHT80	5530	75.170	80.39	PASS
	5610	75.225	80.48	PASS
	5690	75.151	80.33	PASS



U-NII-3

Mode	Carrier frequency (MHz)	99% bandwidth (MHz)	Minimum 6 dB bandwidth (MHz)	Limit (kHz)	Conclusion
802.11a	5745	16.386	15.06	500	PASS
	5785	16.383	15.02	500	PASS
	5825	16.352	14.45	500	PASS
802.11n HT20	5745	17.518	12.83	500	PASS
	5785	17.546	15.44	500	PASS
	5825	17.531	12.83	500	PASS
802.11n HT40	5755	35.905	35.09	500	PASS
	5795	35.972	35.08	500	PASS
802.11ac VHT20	5745	17.529	15.00	500	PASS
	5785	17.551	14.48	500	PASS
	5825	17.511	13.84	500	PASS
802.11ac VHT40	5755	35.887	35.03	500	PASS
	5795	35.983	35.08	500	PASS
802.11ac VHT80	5775	75.295	75.08	500	PASS



U-NII-1, 802.11a
Carrier frequency (MHz): 5180



U-NII-1, 802.11n HT20
Carrier frequency (MHz): 5180

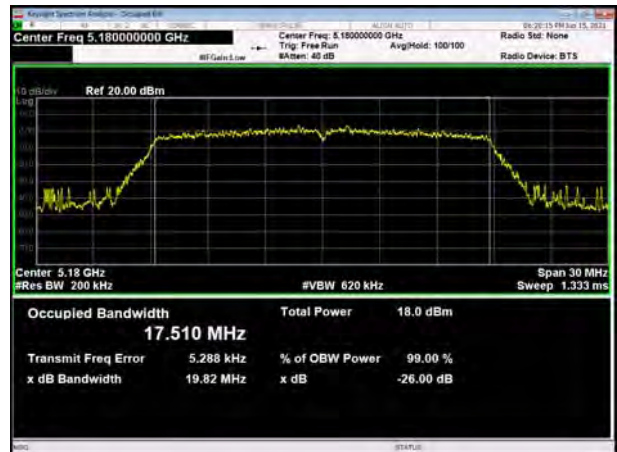

U-NII-1, 802.11a
Carrier frequency (MHz): 5200



U-NII-1, 802.11n HT20
Carrier frequency (MHz): 5200

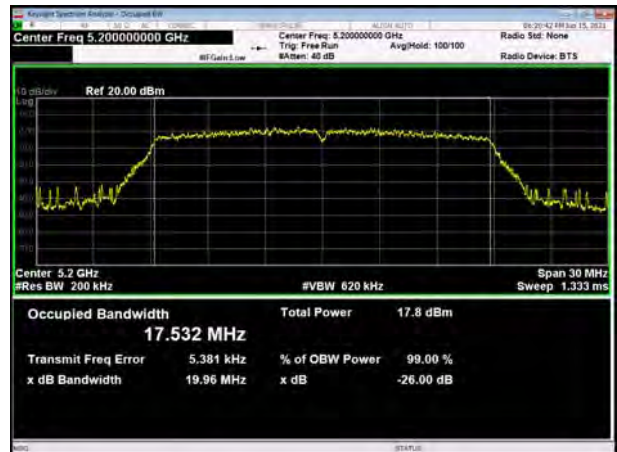

U-NII-1, 802.11a
Carrier frequency (MHz):5240



U-NII-1, 802.11n HT20
Carrier frequency (MHz):5240



U-NII-1, 802.11n HT40
Carrier frequency (MHz): 5190



U-NII-1, 802.11ac VHT20
Carrier frequency (MHz): 5180

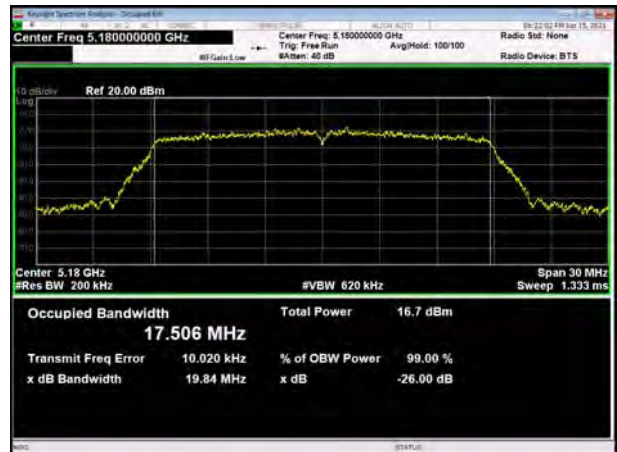

U-NII-1, 802.11n HT40
Carrier frequency (MHz): 5230



U-NII-1, 802.11ac VHT20
Carrier frequency (MHz): 5200

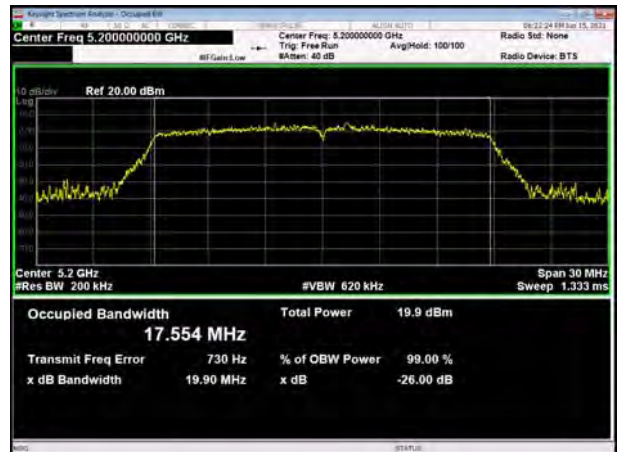

U-NII-1, 802.11ac VHT40
Carrier frequency (MHz): 5190



U-NII-1, 802.11ac VHT20
Carrier frequency (MHz): 5240





U-NII-1, 802.11ac VHT40
Carrier frequency (MHz): 5230

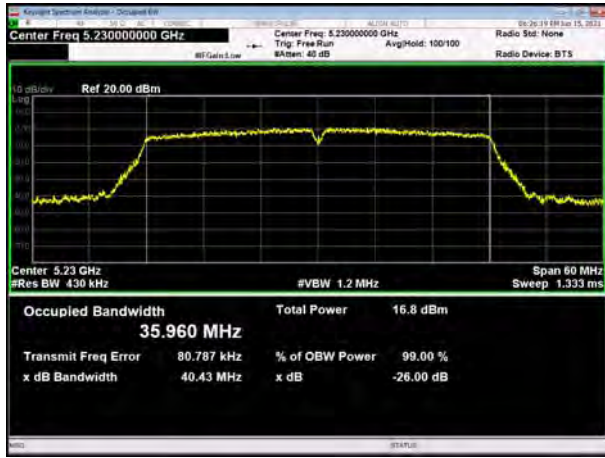

U-NII-1, 802.11ac VHT80
Carrier frequency (MHz): 5210

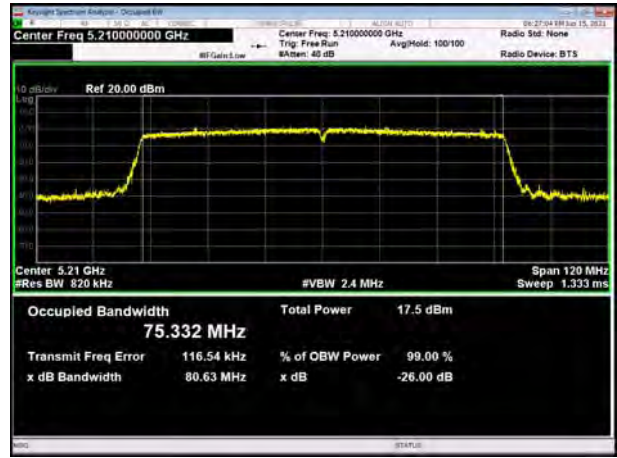

U-NII-2A, 802.11a
Carrier frequency (MHz): 5260

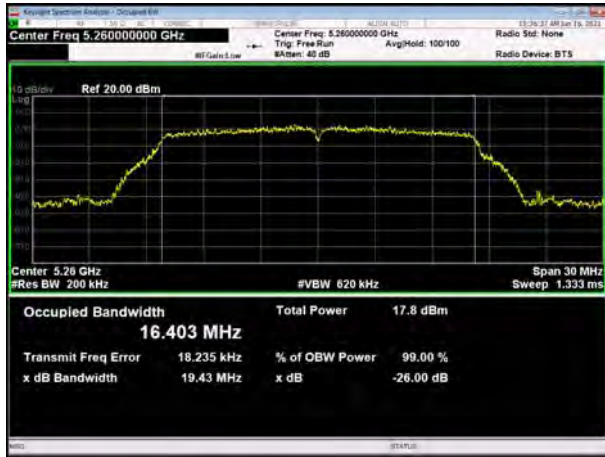

U-NII-2A, 802.11n HT20
Carrier frequency (MHz): 5260



U-NII-2A, 802.11a
Carrier frequency (MHz): 5300

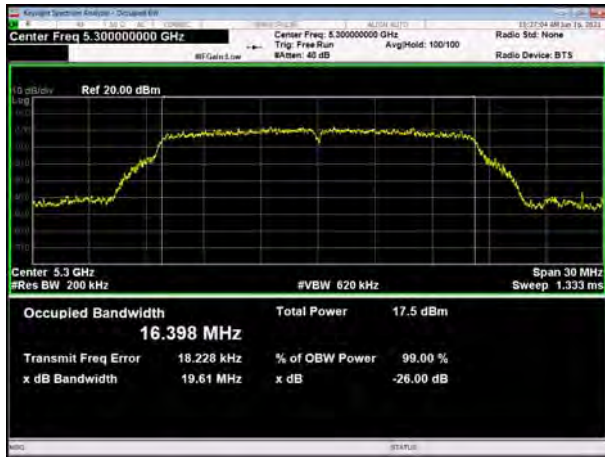

U-NII-2A, 802.11n HT20
Carrier frequency (MHz): 5300





U-NII-2A, 802.11a
Carrier frequency (MHz):5320



U-NII-2A, 802.11n HT20
Carrier frequency (MHz):5320

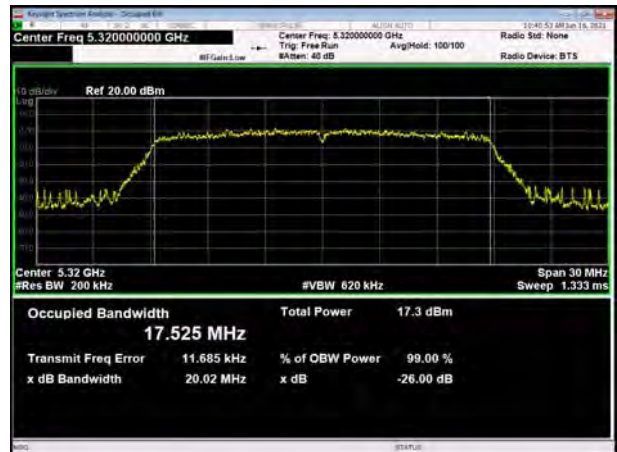

U-NII-2A, 802.11n HT40
Carrier frequency (MHz): 5270



U-NII-2A, 802.11ac VHT20
Carrier frequency (MHz):5260

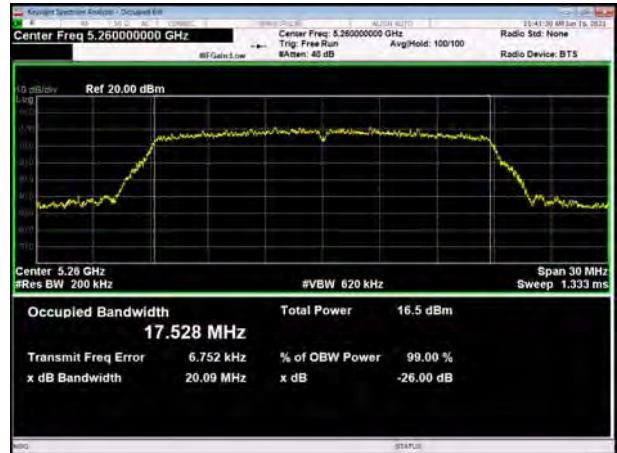

U-NII-2A, 802.11n HT40
Carrier frequency (MHz): 5310



U-NII-2A, 802.11ac VHT20
Carrier frequency (MHz): 5300





U-NII-2A, 802.11ac VHT40
Carrier frequency (MHz): 5270

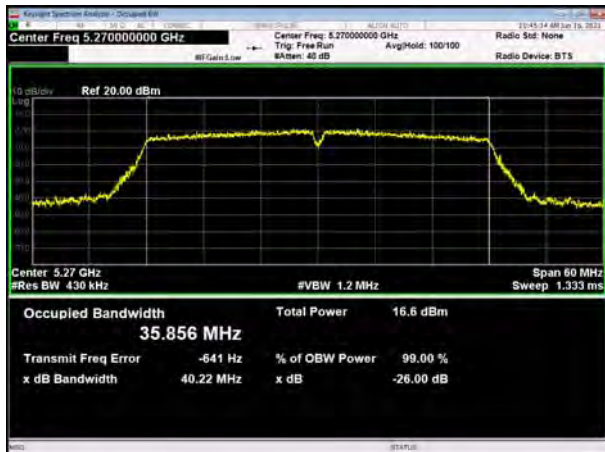

U-NII-2A, 802.11ac VHT20
Carrier frequency (MHz): 5320

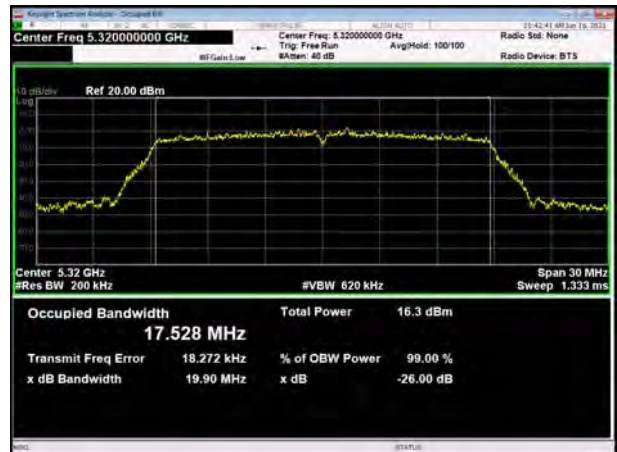

U-NII-2A, 802.11ac VHT40
Carrier frequency (MHz): 5310



U-NII-2A, 802.11ac VHT80
Carrier frequency (MHz): 5290

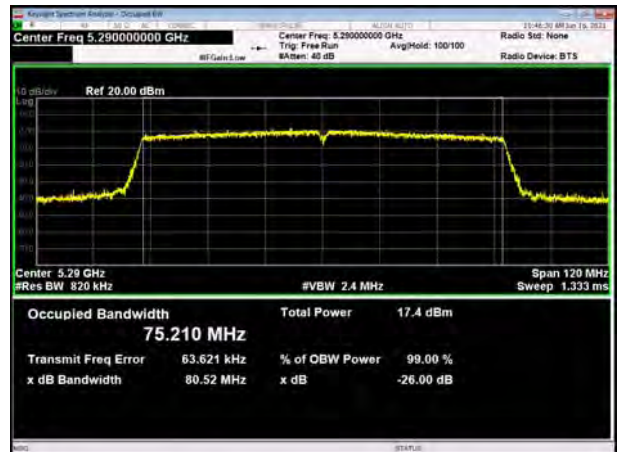

U-NII-2C, 802.11a
Carrier frequency (MHz): 5500



U-NII-2C, 802.11n HT20
Carrier frequency (MHz): 5500



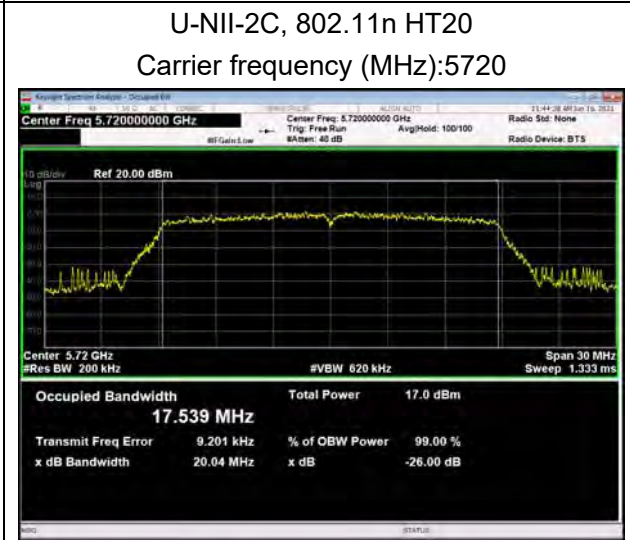
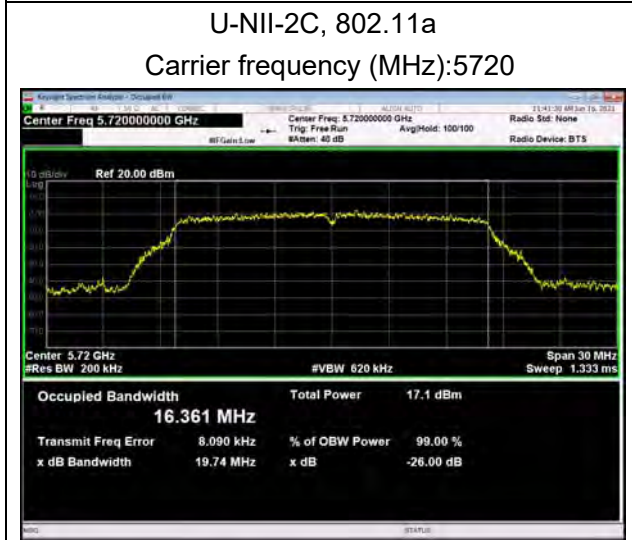
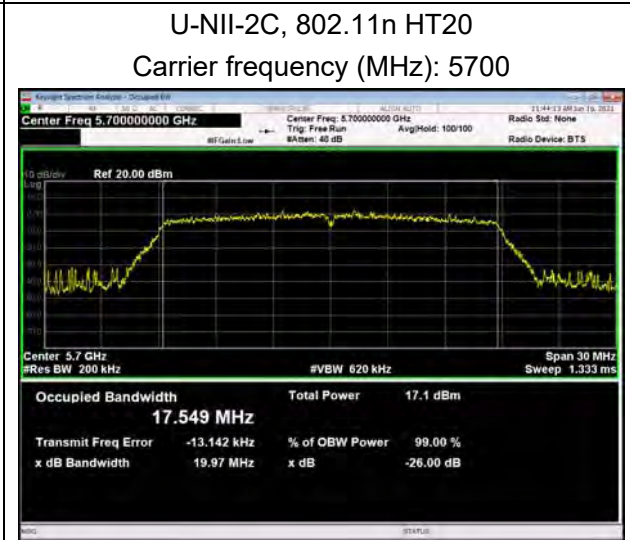
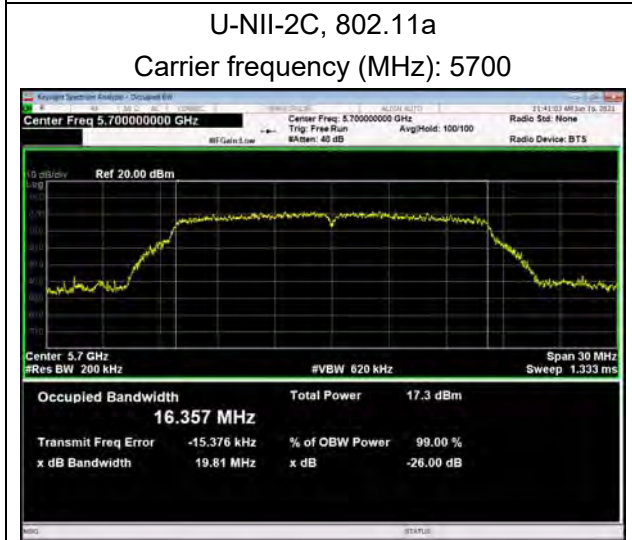
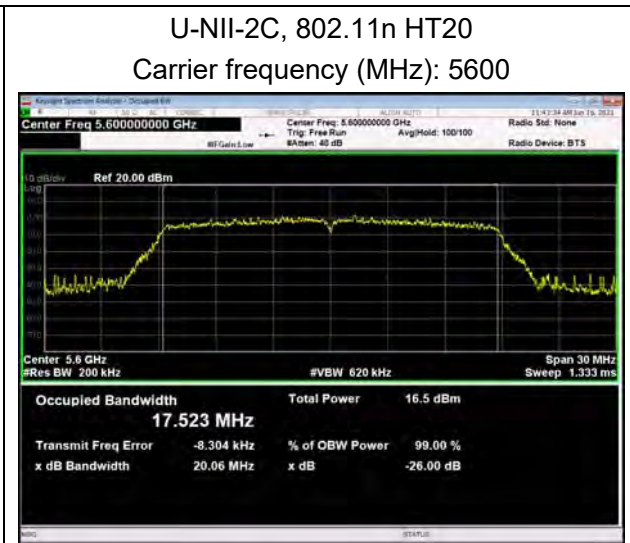
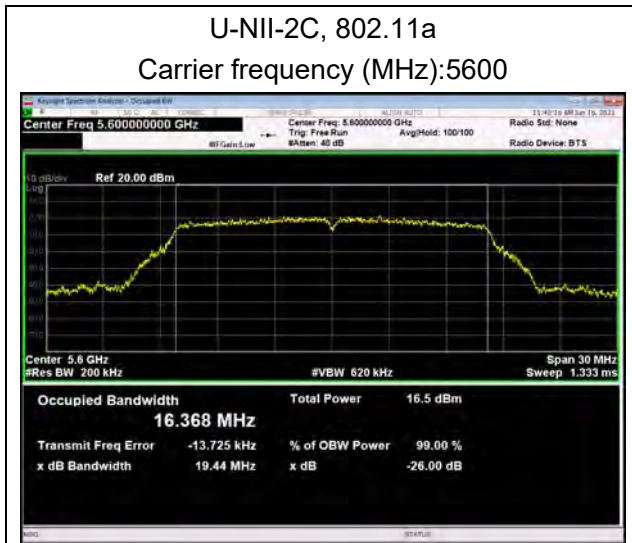



U-NII-2C, 802.11n HT40
Carrier frequency (MHz): 5510

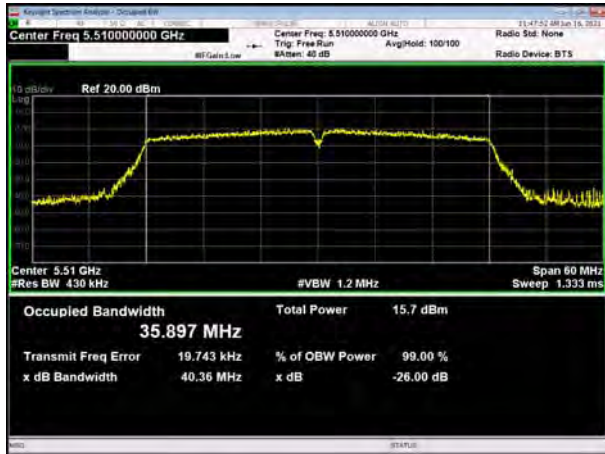

U-NII-2C, 802.11ac VHT20
Carrier frequency (MHz): 5500

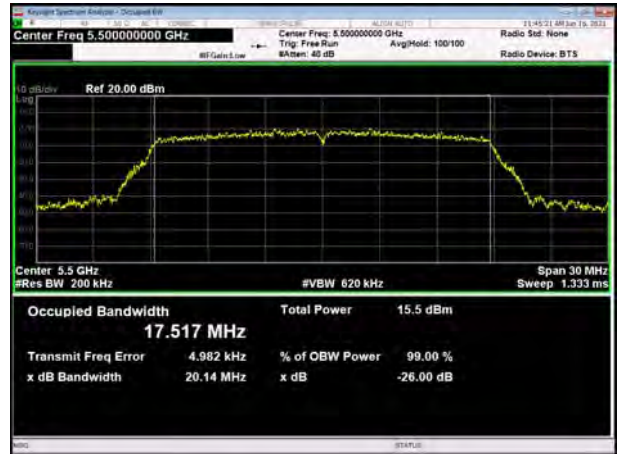

U-NII-2C, 802.11n HT40
Carrier frequency (MHz): 5590



U-NII-2C, 802.11ac VHT20
Carrier frequency (MHz): 5600

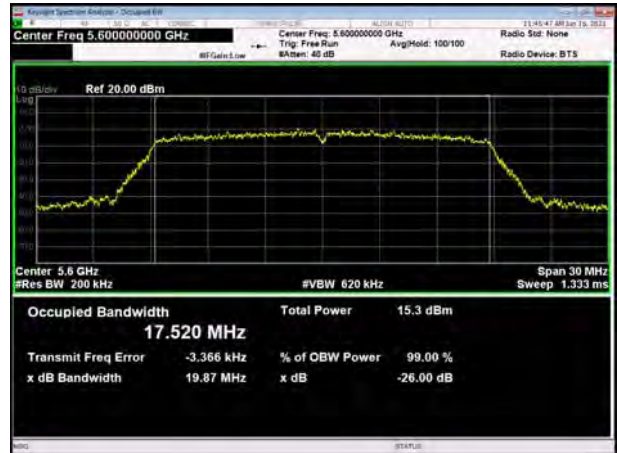

U-NII-2C, 802.11n HT40
Carrier frequency (MHz): 5670



U-NII-2C, 802.11ac VHT20
Carrier frequency (MHz): 5700





U-NII-2C, 802.11n HT40
Carrier frequency (MHz): 5710



U-NII-2C, 802.11ac VHT20
Carrier frequency (MHz): 5720

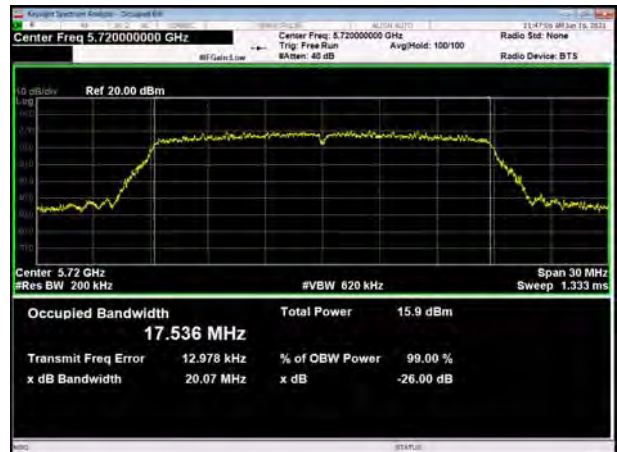

U-NII-2C, 802.11ac VHT40
Carrier frequency (MHz): 5510



U-NII-2C, 802.11ac VHT80
Carrier frequency (MHz): 5530

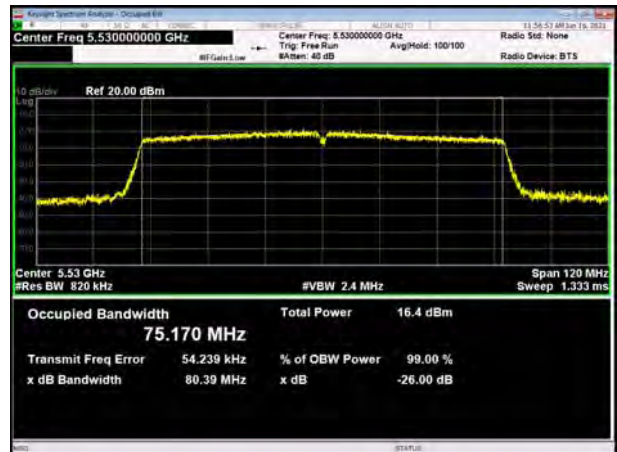

U-NII-2C, 802.11ac VHT40
Carrier frequency (MHz): 5590



U-NII-2C, 802.11ac VHT80
Carrier frequency (MHz): 5610





U-NII-2C, 802.11ac VHT40
Carrier frequency (MHz): 56700



U-NII-2C, 802.11ac VHT80
Carrier frequency (MHz): 5690

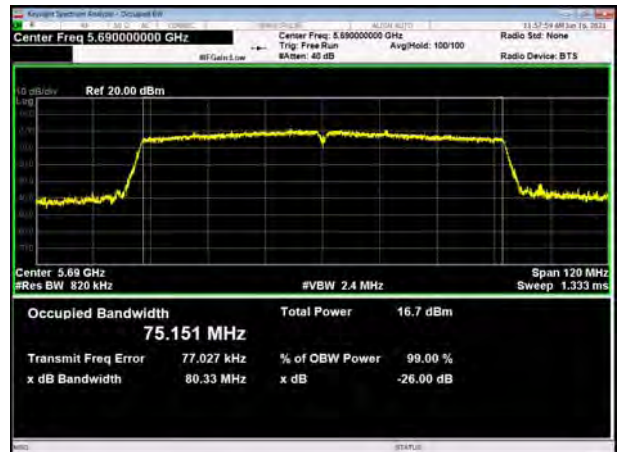

U-NII-2C, 802.11ac VHT40
Carrier frequency (MHz): 5710

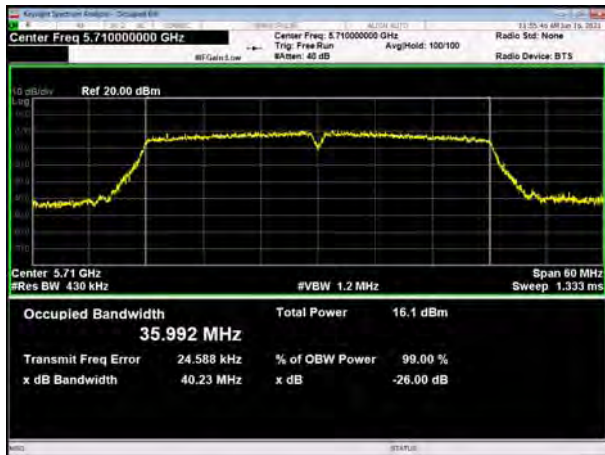



99% bandwidth

U-NII-3, 802.11a
Carrier frequency (MHz): 5745



U-NII-3, 802.11n HT20
Carrier frequency (MHz): 5745

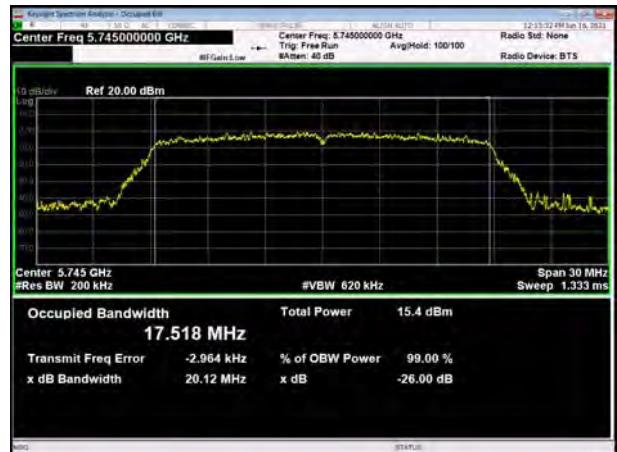

U-NII-3, 802.11a
Carrier frequency (MHz): 5785



U-NII-3, 802.11n HT20
Carrier frequency (MHz): 5785

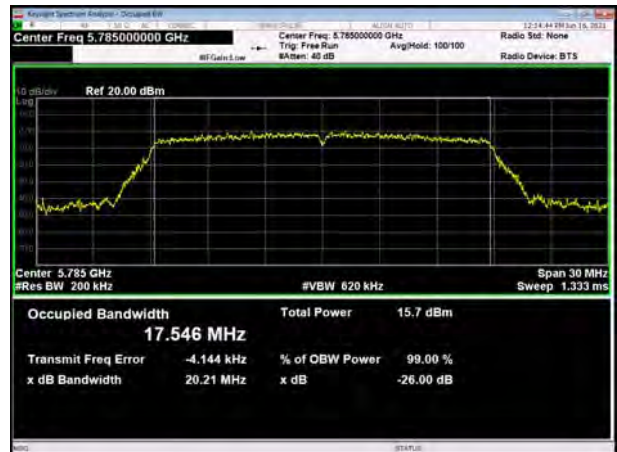

U-NII-3, 802.11a
Carrier frequency (MHz): 5825



U-NII-3, 802.11n HT20
Carrier frequency (MHz): 5825



U-NII-3, 802.11n HT40
Carrier frequency (MHz): 5755



U-NII-3, 802.11ac VHT20
Carrier frequency (MHz): 5745

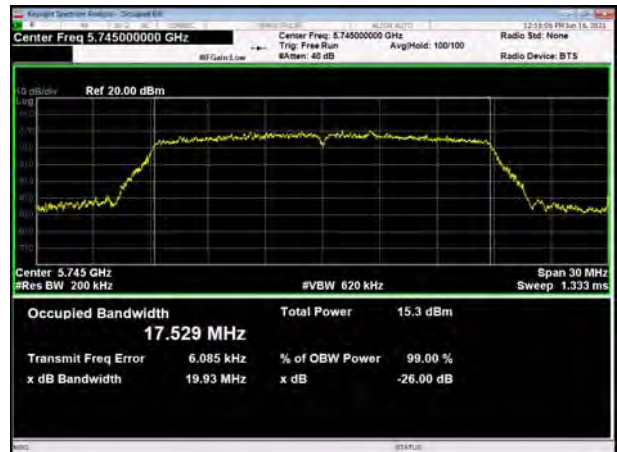

U-NII-3, 802.11n HT40
Carrier frequency (MHz): 5795



U-NII-3, 802.11ac VHT20
Carrier frequency (MHz): 5785

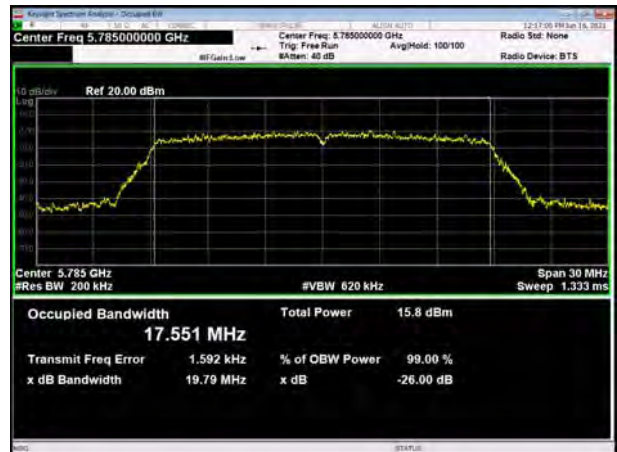

U-NII-3, 802.11ac VHT40
Carrier frequency (MHz): 5755



U-NII-3, 802.11ac VHT20
Carrier frequency (MHz): 5825

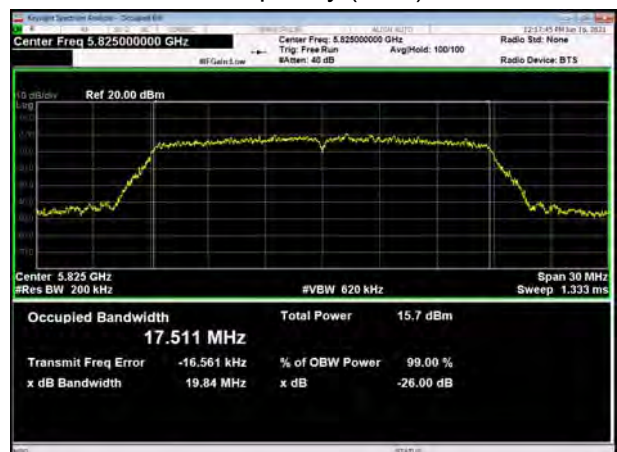



U-NII-3, 802.11ac VHT40
Carrier frequency (MHz): 5795



U-NII-3, 802.11ac VHT80
Carrier frequency (MHz): 5775

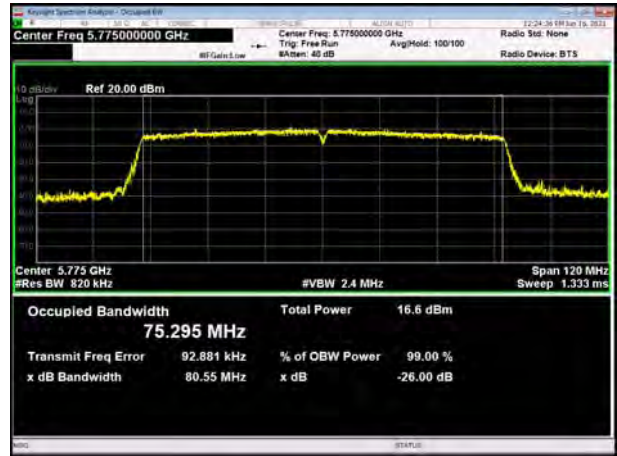

Minimum 6 dB bandwidth

U-NII-3, 802.11a
Carrier frequency (MHz): 5745



U-NII-3, 802.11n HT20
Carrier frequency (MHz): 5745



U-NII-3, 802.11a
Carrier frequency (MHz): 5785



U-NII-3, 802.11n HT20
Carrier frequency (MHz): 5785



U-NII-3, 802.11a
Carrier frequency (MHz): 5825



U-NII-3, 802.11n HT20
Carrier frequency (MHz): 5825



U-NII-3, 802.11n HT40
Carrier frequency (MHz): 5755



U-NII-3, 802.11ac VHT20
Carrier frequency (MHz): 5745

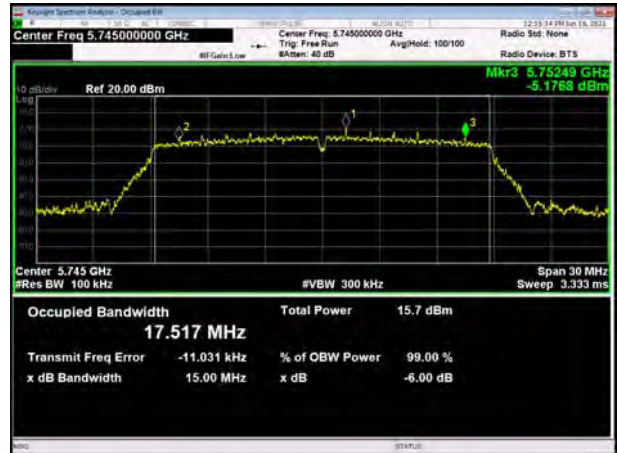

U-NII-3, 802.11n HT40
Carrier frequency (MHz): 5795



U-NII-3, 802.11ac VHT20
Carrier frequency (MHz): 5785





U-NII-3, 802.11ac VHT40
Carrier frequency (MHz): 5755



U-NII-3, 802.11ac VHT20
Carrier frequency (MHz): 5825



U-NII-3, 802.11ac VHT40
Carrier frequency (MHz): 5795



U-NII-3, 802.11ac VHT80
Carrier frequency (MHz): 5775

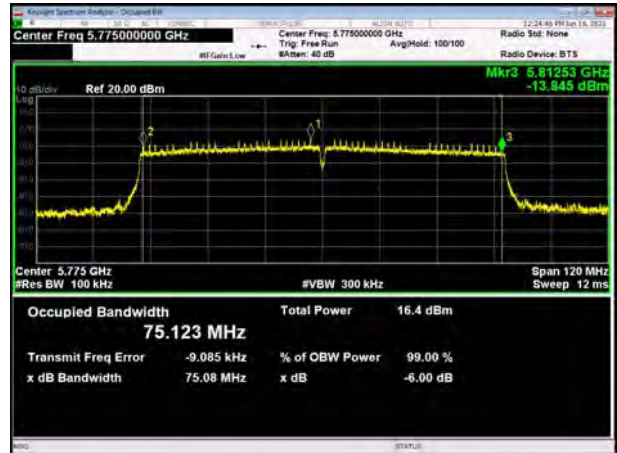

5.2. Average Power Output

Ambient condition

Temperature	Relative humidity	Pressure
23°C ~25°C	45%~50%	101.5kPa

Methods of Measurement

During the process of the testing, The EUT was connected to the average power meter through an external attenuator and a known loss cable. The EUT is max power transmission with proper modulation. We use Maximum average Conducted Output Power Level Method in KDB789033 for this test

Test Setup

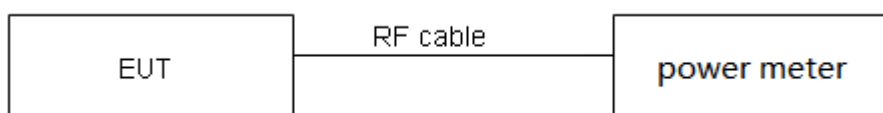

Limits

Rule FCC Part 15.407(a)(1)(2)(3)

(1) For the band 5.15-5.25 GHz.

(i) For an outdoor access point operating in the band 5.15-5.25 GHz, the maximum conducted output power over the frequency band of operation shall not exceed 1 W provided the maximum antenna gain does not exceed 6 dBi. In addition, the maximum power spectral density shall not exceed 17 dBm in any 1 megahertz band. If transmitting antennas of directional gain greater than 6 dBi are used, both the maximum conducted output power and the maximum power spectral density shall be reduced by the amount in dB that the directional gain of the antenna exceeds 6 dBi. The maximum e.i.r.p. at any elevation angle above 30 degrees as measured from the horizon must not exceed 125 mW (21 dBm).

(ii) For an indoor access point operating in the band 5.15-5.25 GHz, the maximum conducted output power over the frequency band of operation shall not exceed 1 W provided the maximum antenna gain does not exceed 6 dBi. In addition, the maximum power spectral density shall not exceed 17 dBm in any 1 megahertz band. If transmitting antennas of directional gain greater than 6 dBi are used, both the maximum conducted output power and the maximum power spectral density shall be reduced by the amount in dB that the directional gain of the antenna exceeds 6 dBi.

(iii) For fixed point-to-point access points operating in the band 5.15-5.25 GHz, the maximum conducted output power over the frequency band of operation shall not exceed 1 W. In addition, the maximum power spectral density shall not exceed 17 dBm in any 1 megahertz band. Fixed point-to-point U-NII devices may employ antennas with directional gain up to 23 dBi without any corresponding reduction in the maximum conducted output power or maximum power spectral density. For fixed point-to-point transmitters that employ a directional antenna gain greater than 23 dBi, a 1 dB reduction in maximum conducted output power and maximum power spectral density is required for each 1 dB of antenna gain in excess of 23 dBi. Fixed, point-to-point operations exclude



the use of point-to-multipoint systems, omnidirectional applications, and multiple collocated transmitters transmitting the same information. The operator of the U-NII device, or if the equipment is professionally installed, the installer, is responsible for ensuring that systems employing high gain directional antennas are used exclusively for fixed, point-to-point operations.

(iv) For client devices in the 5.15-5.25 GHz band, the maximum conducted output power over the frequency band of operation shall not exceed 250 mW provided the maximum antenna gain does not exceed 6 dBi. In addition, the maximum power spectral density shall not exceed 11 dBm in any 1 megahertz band. If transmitting antennas of directional gain greater than 6 dBi are used, both the maximum conducted output power and the maximum power spectral density shall be reduced by the amount in dB that the directional gain of the antenna exceeds 6 dBi.

(2) For the 5.25-5.35 GHz and 5.47-5.725 GHz bands, the maximum conducted output power over the frequency bands of operation shall not exceed the lesser of 250 mW or 11 dBm + 10 log B, where B is the 26 dB emission bandwidth in megahertz. In addition, the maximum power spectral density shall not exceed 11 dBm in any 1 megahertz band. If transmitting antennas of directional gain greater than 6 dBi are used, both the maximum conducted output power and the maximum power spectral density shall be reduced by the amount in dB that the directional gain of the antenna exceeds 6 dBi.

(3) For the band 5.725-5.85 GHz, the maximum conducted output power over the frequency band of operation shall not exceed 1 W. In addition, the maximum power spectral density shall not exceed 30 dBm in any 500-kHz band. If transmitting antennas of directional gain greater than 6 dBi are used, both the maximum conducted output power and the maximum power spectral density shall be reduced by the amount in dB that the directional gain of the antenna exceeds 6 dBi.

Measurement Uncertainty

The assessed measurement uncertainty to ensure 95% confidence level for the normal distribution is with the coverage factor $k = 2$, $U = 0.44$ dB.

Test Results

Mode	T _{on} (ms)	T _(on+off) (ms)	Duty cycle	Duty cycle correction Factor(dB)
802.11a	1.39	1.44	0.97	0.15
802.11n HT20	1.30	1.34	0.96	0.16
802.11n HT40	0.65	0.69	0.94	0.29
802.11ac VHT20	1.31	1.36	0.97	0.14
802.11ac VHT40	0.65	0.70	0.94	0.28
802.11ac VHT80	0.32	0.37	0.88	0.55

Note: when Duty cycle ≥ 0.98 , Duty cycle correction Factor not required.

Power Index								
Channel	802.11a	802.11n HT20	802.11ac VHT20	Channel	802.11n HT40	802.11ac VHT40	Channel	802.11ac VHT80
CH36	15	15	14	CH38	15	14	CH42	14
CH40	15	15	14	CH46	14	14	/	/
CH48	15	15	14	/	/	/	/	/
CH52	15	15	14	CH54	14	14	CH58	14
CH60	15	15	14	CH62	14	14	/	/
CH64	15	15	14	/	/	/	/	/
CH100	15	15	14	CH102	14	14	CH106	14
CH120	15	15	14	CH118	14	14	CH122	14
CH140	15	15	14	CH134	14	14	CH138	14
CH144	15	15	14	CH142	14	14	/	/
CH149	14	14	14	CH151	14	14	CH155	14
CH157	14	14	14	CH159	14	14	/	/
CH165	14	14	14	/	/	/	/	/



Network Standards		Channel/Frequency (MHz)	B=26 dB bandwidth (MHz)	Limit 11 dBm + 10 log B (dBm)	Final Limit(dBm)
U-NII-2A	802.11a	52/5260	19.43	23.88<24	23.88
		60/5300	19.61	23.92<24	23.92
		64/5320	19.46	23.89<24	23.89
	802.11n HT20	52/5260	20.25	24.06>24	24.00
		60/5300	19.96	24.00>24	24.00
		64/5320	20.02	24.01>24	24.00
	802.11n HT40	54/5270	40.07	27.03>24	24.00
		62/5310	40.41	27.06>24	24.00
	802.11ac VHT20	52/5260	20.09	24.03>24	24.00
		60/5300	20.19	24.05>24	24.00
64/5320		19.90	23.99<24	23.99	
802.11ac VHT40	54/5270	40.22	27.04>24	24.00	
	62/5310	40.54	27.08>24	24.00	
802.11ac VHT80	58/5290	80.52	30.06>24	24.00	
U-NII-2C	802.11a	100/5500	19.63	23.93<24	23.93
		120/5600	19.44	23.89<24	23.89
		140/5700	19.81	23.97<24	23.97
		144/5720	19.74	23.95<24	23.95
	802.11n HT20	100/5500	20.00	24.01>24	24.00
		120/5600	20.06	24.02>24	24.00
		140/5700	19.97	24.00>24	24.00
		144/5720	20.04	24.02>24	24.00
	802.11n HT40	102/5510	40.36	27.06>24	24.00
		118/5590	40.08	27.03>24	24.00
		134/5670	39.91	27.01>24	24.00
		142/5710	40.20	27.04>24	24.00
	802.11ac VHT20	100/5500	20.14	24.04>24	24.00
		120/5600	19.87	23.98<24	23.98
		140/5700	20.03	24.02>24	24.00
		144/5720	20.07	24.03>24	24.00
	802.11ac VHT40	102/5510	40.25	27.05>24	24.00
		118/5590	40.45	27.07>24	24.00
		134/5670	39.95	27.02>24	24.00
		142/5710	40.23	27.05>24	24.00
	802.11ac VHT80	106/5530	80.39	30.05>24	24.00
122/5610		80.48	30.06>24	24.00	
138/5690		80.33	30.05>24	24.00	
Note: 250mW=24dBm					



Note: Average Power with duty factor = Average Power Measured +Duty cycle correction factor

U-NII-1

Network Standards	Channel/ Frequency (MHz)	Average Power Measured (dBm)	Average Power with duty factor (dBm)	Limit (dBm)	Conclusion
802.11a	36/5180	14.86	15.01	24	PASS
	40/5200	14.83	14.98	24	PASS
	48/5240	14.92	15.07	24	PASS
802.11n HT20	36/5180	14.32	14.48	24	PASS
	40/5200	14.28	14.44	24	PASS
	48/5240	14.35	14.51	24	PASS
802.11n HT40	38/5190	12.86	13.15	24	PASS
	46/5230	13.03	13.32	24	PASS
802.11ac VHT20	36/5180	13.11	13.25	24	PASS
	40/5200	12.86	13.00	24	PASS
	48/5240	13.14	13.28	24	PASS
802.11ac VHT40	38/5190	12.92	13.20	24	PASS
	46/5230	13.04	13.32	24	PASS
802.11ac VHT80	42/5210	12.75	13.30	24	PASS

Note: Average Power with duty factor = Average Power Measured +Duty cycle correction factor



U-NII-2A

Network Standards	Channel/ Frequency (MHz)	Average Power Measured (dBm)	Average Power with duty factor (dBm)	Limit (dBm)	Conclusion
802.11a	52/5260	14.83	14.98	23.88	PASS
	60/5300	14.94	15.09	23.92	PASS
	64/5320	15.06	15.21	23.89	PASS
802.11n HT20	52/5260	14.78	14.94	24.00	PASS
	60/5300	14.60	14.76	24.00	PASS
	64/5320	14.90	15.06	24.00	PASS
802.11n HT40	54/5270	13.58	13.87	24.00	PASS
	62/5310	13.74	14.03	24.00	PASS
802.11ac VHT20	52/5260	13.58	13.72	24.00	PASS
	60/5300	13.61	13.75	24.00	PASS
	64/5320	13.85	13.99	23.99	PASS
802.11ac VHT40	54/5270	13.52	13.80	24.00	PASS
	62/5310	13.78	14.06	24.00	PASS
802.11ac VHT80	58/5290	13.88	14.43	24.00	PASS

Note: Average Power with duty factor = Average Power Measured +Duty cycle correction factor

U-NII-2C

Network Standards	Channel/ Frequency (MHz)	Average Power Measured (dBm)	Average Power with duty factor (dBm)	Limit (dBm)	Conclusion
802.11a	100/5500	14.42	14.57	23.93	PASS
	120/5600	14.93	15.08	23.89	PASS
	140/5700	14.59	14.74	23.97	PASS
	144/5720	14.65	14.80	23.95	PASS
802.11n HT20	100/5500	14.26	14.42	24.00	PASS
	120/5600	14.75	14.91	24.00	PASS
	140/5700	14.42	14.58	24.00	PASS
	144/5720	14.44	14.60	24.00	PASS
802.11n HT40	102/5510	13.21	13.50	24.00	PASS
	118/5590	13.48	13.77	24.00	PASS
	134/5670	13.14	13.43	24.00	PASS
	142/5710	13.30	13.59	24.00	PASS
802.11ac	100/5500	13.29	13.43	24.00	PASS



VHT20	120/5600	13.73	13.87	23.98	PASS
	140/5700	13.40	13.54	24.00	PASS
	144/5720	13.49	13.63	24.00	PASS
802.11ac VHT40	102/5510	13.13	13.41	24.00	PASS
	118/5590	13.42	13.70	24.00	PASS
	134/5670	13.10	13.38	24.00	PASS
	142/5710	13.34	13.62	24.00	PASS
802.11ac VHT80	106/5530	12.84	13.39	24.00	PASS
	122/5610	13.20	13.75	24.00	PASS
	138/5690	12.92	13.47	24.00	PASS

Note: Average Power with duty factor = Average Power Measured +Duty cycle correction factor

U-NII-3

Network Standards	Channel/ Frequency (MHz)	Average Power Measured (dBm)	Average Power with duty factor (dBm)	Limit (dBm)	Conclusion
802.11a	149/5745	13.46	13.61	30	PASS
	157/5785	13.51	13.66	30	PASS
	165/5825	13.34	13.49	30	PASS
802.11n HT20	149/5745	13.32	13.48	30	PASS
	157/5785	13.33	13.49	30	PASS
	165/5825	13.22	13.38	30	PASS
802.11n HT40	151/5755	13.07	13.36	30	PASS
	159/5795	13.28	13.57	30	PASS
802.11ac VHT20	149/5745	13.32	13.46	30	PASS
	157/5785	13.31	13.45	30	PASS
	165/5825	13.23	13.37	30	PASS
802.11ac VHT40	151/5755	13.19	13.47	30	PASS
	159/5795	13.28	13.56	30	PASS
802.11ac VHT80	155/5775	13.01	13.56	30	PASS

Note: Average Power with duty factor = Average Power Measured +Duty cycle correction factor

5.3. Frequency Stability

Ambient condition

Temperature	Relative humidity	Pressure
23°C ~25°C	45%~50%	101.5kPa

Method of Measurement

1. Frequency stability with respect to ambient temperature

- a) Supply the EUT with a nominal ac voltage or install a new or fully charged battery in the EUT. If possible, a dummy load shall be connected to the EUT because an antenna near the metallic walls of an environmental test chamber could affect the output frequency of the EUT. If the EUT is equipped with a permanently attached, adjustable-length antenna, then the EUT shall be placed in the center of the chamber with the antenna adjusted to the shortest length possible. Turn ON the EUT and tune it to one of the number of frequencies shown in 5.6.
- b) Couple the unlicensed wireless device output to the measuring instrument by connecting an antenna to the measuring instrument with a suitable length of coaxial cable and placing the measuring antenna near the EUT (e.g., 15 cm away), or by connecting a dummy load to the measuring instrument, through an attenuator if necessary.
- c) Adjust the location of the measurement antenna and the controls on the measurement instrument to obtain a suitable signal level (i.e., a level that will not overload the measurement instrument but is strong enough to allow measurement of the operating or fundamental frequency of the EUT).
- d) Turn the EUT OFF and place it inside the environmental temperature chamber. For devices that have oscillator heaters, energize only the heater circuit.
- e) Set the temperature control on the chamber to the highest specified in the regulatory requirements for the type of device and allow the oscillator heater and the chamber temperature to stabilize.
- f) While maintaining a constant temperature inside the environmental chamber, turn the EUT ON and record the operating frequency at startup, and at 2 minutes, 5 minutes, and 10 minutes after the EUT is energized. Four measurements in total are made.
- g) Measure the frequency at each of frequencies specified in 5.6.
- h) Switch OFF the EUT but do not switch OFF the oscillator heater.
- i) Lower the chamber temperature by not more than 10°C, and allow the temperature inside the chamber to stabilize.
- j) Repeat step f) through step i) down to the lowest specified temperature.

2. Frequency stability when varying supply voltage

Unless otherwise specified, these tests shall be made at ambient room temperature (+15°C to +25 °C). An antenna shall be connected to the antenna output terminals of the EUT if possible. If the EUT is equipped with or uses an adjustable-length antenna, then it shall be fully extended.

- a) Supply the EUT with nominal voltage or install a new or fully charged battery in the EUT. Turn ON the EUT and couple its output to a frequency counter or other frequency-measuring instrument.



- b) Tune the EUT to one of the number of frequencies required in 5.6. Adjust the location of the measurement antenna and the controls on the measurement instrument to obtain a suitable signal level (i.e., a level that will not overload the measurement instrument but is strong enough to allow measurement of the operating or fundamental frequency of the EUT).
- c) Measure the frequency at each of the frequencies specified in 5.6.
- d) Repeat the above procedure at 85% and 115% of the nominal supply voltage.

Limit

Manufacturers of U-NII devices are responsible for ensuring frequency stability such that an emission is maintained within the band of operation under all conditions of normal operation as specified in the users manual.

Measurement Uncertainty

The assessed measurement uncertainty to ensure 95% confidence level for the normal distribution is with the coverage factor $k = 2$, $U = 936\text{Hz}$

**Test Results**

Voltage (V)	Temperature (°C)	U-NII-1 Test Results			
		5200MHz			
		1min	2min	5min	10min
3.87	-10	5199.994793	5199.993209	5199.985337	5199.982448
3.87	0	5199.989190	5199.991843	5199.979686	5199.979941
3.87	10	5199.988541	5199.988449	5199.976764	5199.971365
3.87	20	5199.988297	5199.986252	5199.971280	5199.966526
3.87	30	5199.984811	5199.981474	5199.967146	5199.960501
3.87	40	5199.983410	5199.975725	5199.965464	5199.954802
3.87	50	5199.974902	5199.967479	5199.963162	5199.954753
3.87	60	5199.965342	5199.960562	5199.954327	5199.951562
3.6	20	5199.959091	5199.957607	5199.949847	5199.949010
4.45	20	5199.955230	5199.950737	5199.944051	5199.948585
MHz		-0.044770	-0.049263	-0.055949	-0.051415
PPM		-8.609655	-9.473613	-10.759504	-9.887458

Voltage (V)	Temperature (°C)	U-NII-2A Test Results			
		5300MHz			
		1min	2min	5min	10min
3.87	-10	5299.991935	5299.982964	5299.978630	5299.976968
3.87	0	5299.986928	5299.981859	5299.977523	5299.969961
3.87	10	5299.985599	5299.979091	5299.967720	5299.961551
3.87	20	5299.980071	5299.973442	5299.961230	5299.955112
3.87	30	5299.974111	5299.967559	5299.958613	5299.954846
3.87	40	5299.968894	5299.960904	5299.948733	5299.952176
3.87	50	5299.963751	5299.953465	5299.945137	5299.946409
3.87	60	5299.958590	5299.949714	5299.938775	5299.940517
3.6	20	5299.949981	5299.948381	5299.932747	5299.935910
4.45	20	5299.947302	5299.946313	5299.931352	5299.932800
MHz		-0.052698	-0.053687	-0.068648	-0.067200
PPM		-9.943023	-10.129621	-12.952478	-12.679275



Voltage (V)	Temperature (°C)	U-NII-2C Test Results			
		5580MHz			
		1min	2min	5min	10min
3.87	-10	5579.998217	5579.993046	5579.984177	5579.983640
3.87	0	5579.989213	5579.986943	5579.978923	5579.977600
3.87	10	5579.985129	5579.986083	5579.970027	5579.970068
3.87	20	5579.981237	5579.982979	5579.967931	5579.966624
3.87	30	5579.978015	5579.974832	5579.963352	5579.965634
3.87	40	5579.972250	5579.971456	5579.958267	5579.963102
3.87	50	5579.968196	5579.965692	5579.948904	5579.959114
3.87	60	5579.959083	5579.963308	5579.942642	5579.949228
3.6	20	5579.956051	5579.960688	5579.935990	5579.945505
4.45	20	5579.947879	5579.955573	5579.935773	5579.941887
MHz		-0.052121	-0.044427	-0.064227	-0.058113
PPM		-9.340650	-7.961816	-11.510269	-10.414508

Voltage (V)	Temperature (°C)	U-NII-3 Test Results			
		5785MHz			
		1min	2min	5min	10min
3.87	-10	5785.005343	5784.999294	5784.993503	5784.983744
3.87	0	5784.997198	5784.989808	5784.989870	5784.978781
3.87	10	5784.989344	5784.987017	5784.982427	5784.978730
3.87	20	5784.985911	5784.977532	5784.975535	5784.977449
3.87	30	5784.980223	5784.976009	5784.968410	5784.974532
3.87	40	5784.977701	5784.967538	5784.963608	5784.974181
3.87	50	5784.974822	5784.965796	5784.956651	5784.971163
3.87	60	5784.973178	5784.962254	5784.954096	5784.966341
3.6	20	5784.963847	5784.956627	5784.945766	5784.963528
4.45	20	5784.961441	5784.953472	5784.944240	5784.960680
MHz		-0.038559	-0.046528	-0.055760	-0.039320
PPM		-6.665412	-8.042939	-9.638775	-6.796829

5.4. Power Spectral Density

Ambient condition

Temperature	Relative humidity	Pressure
23°C ~25°C	45%~50%	101.5kPa

Method of Measurement

The EUT was connected to the spectrum analyzer through an external attenuator (20dB) and a known loss cable.

Set RBW = 1MHz, VBW =3MHz for the band 5.150-5.250GHz, 5.250-5.350GHz, 5.470-5.725GHz.
 Set RBW = 470kHz, VBW =1.5MHz for the band 5.725-5.850GHz

The conducted PSD is measured at each antenna port. The measured results at the various antenna ports are then summed mathematically.

Test setup

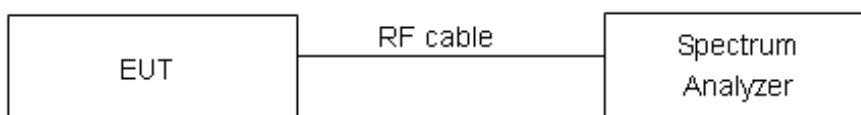

Limits

Rule FCC Part 15.407(a)(1)/ Part 15.407(a)(2) / Part 15.407(a)(3)

For an indoor access point operating in the band 5.15-5.25 GHz, the maximum power spectral density shall not exceed 17 dBm in any 1 megahertz band. If transmitting antennas of directional gain greater than 6 dBi are used, both the maximum conducted output power and the maximum power spectral density shall be reduced by the amount in dB that the directional gain of the antenna exceeds 6 dBi.

For client devices in the 5.15-5.25 GHz band, the maximum conducted output power over the frequency band of operation shall not exceed 250 mW provided the maximum antenna gain does not exceed 6 dBi. In addition, the maximum power spectral density shall not exceed 11 dBm in any 1 megahertz band. If transmitting antennas of directional gain greater than 6 dBi are used, both the maximum conducted output power and the maximum power spectral density shall be reduced by the amount in dB that the directional gain of the antenna exceeds 6 dBi.

For the 5.25-5.35 GHz and 5.47-5.725 GHz bands, the maximum power spectral density shall not exceed 11 dBm in any 1 megahertz band. If transmitting antennas of directional gain greater than 6 dBi are used, both the maximum conducted output power and the maximum power spectral density shall be reduced by the amount in dB that the directional gain of the antenna exceeds 6 dBi.

For the band 5.725-5.85 GHz, the maximum power spectral density shall not exceed 30 dBm in any 500kHz band. If transmitting antennas of directional gain greater than 6 dBi are used, both the maximum conducted output power and the maximum power spectral density shall be reduced by the



amount in dB that the directional gain of the antenna exceeds 6 dBi.

Frequency Bands/MHz	Limits
5150-5250	11dBm/MHz
5.25-5.35 GHz and 5.47-5.725 GHz	11dBm/MHz
5725-5850	30dBm/500kHz

Measurement Uncertainty

The assessed measurement uncertainty to ensure 95% confidence level for the normal distribution is with the coverage factor $k = 2$, $U = 0.75\text{dB}$.

**Test Results:**

Note: Power Spectral Density =Read Value+Duty cycle correction factor

U-NII-1

Mode	Channel Number	Read Value (dBm /MHz)	Power Spectral Density (dBm /MHz)	Limit (dBm /MHz)	Conclusion
802.11a	36	2.644	2.79	11	PASS
	40	2.604	2.75	11	PASS
	48	2.654	2.80	11	PASS
802.11n HT20	36	2.773	2.93	11	PASS
	40	2.176	2.33	11	PASS
	48	2.381	2.54	11	PASS
802.11n HT40	38	-1.734	-1.45	11	PASS
	46	-2.014	-1.73	11	PASS
802.11ac VHT20	36	1.469	1.61	11	PASS
	40	1.301	1.44	11	PASS
	48	1.214	1.36	11	PASS
802.11ac VHT40	38	-1.284	-1.00	11	PASS
	46	-1.659	-1.38	11	PASS
802.11ac VHT80	42	-5.571	-5.02	11	PASS

U-NII-2A

Mode	Channel Number	Read Value (dBm /MHz)	Power Spectral Density (dBm /MHz)	Limit (dBm /MHz)	Conclusion
802.11a	52	2.574	2.72	11	PASS
	60	2.195	2.34	11	PASS
	64	2.077	2.22	11	PASS
802.11n HT20	52	2.106	2.26	11	PASS
	60	1.884	2.04	11	PASS
	64	1.689	1.85	11	PASS
802.11n HT40	54	-1.943	-1.66	11	PASS
	62	-1.998	-1.71	11	PASS
802.11ac	52	1.044	1.19	11	PASS



VHT20	60	0.871	1.01	11	PASS
	64	0.550	0.69	11	PASS
802.11ac VHT40	54	-1.729	-1.45	11	PASS
	62	-2.062	-1.78	11	PASS
802.11ac VHT80	58	-5.395	-4.84	11	PASS

U-NII-2C

Mode	Channel Number	Read Value (dBm /MHz)	Power Spectral Density (dBm /MHz)	Limit (dBm /MHz)	Conclusion
802.11a	100	1.695	1.84	11	PASS
	120	1.369	1.52	11	PASS
	140	2.018	2.17	11	PASS
	144	1.824	1.97	11	PASS
802.11n HT20	100	1.010	1.17	11	PASS
	120	1.134	1.29	11	PASS
	140	1.527	1.68	11	PASS
	144	1.569	1.73	11	PASS
802.11n HT40	102	-2.707	-2.42	11	PASS
	118	-2.970	-2.68	11	PASS
	134	-2.608	-2.32	11	PASS
	142	-2.618	-2.33	11	PASS
802.11ac VHT20	100	0.167	0.31	11	PASS
	120	-0.032	0.11	11	PASS
	140	0.539	0.68	11	PASS
	144	0.532	0.68	11	PASS
802.11ac VHT40	102	-2.65	-2.37	11	PASS
	118	-2.873	-2.59	11	PASS
	134	-2.465	-2.18	11	PASS
	142	-2.639	-2.36	11	PASS
802.11ac VHT80	106	-6.318	-5.76	11	PASS
	122	-6.340	-5.79	11	PASS
	138	-5.236	-4.68	11	PASS



U-NII-3

Mode	Channel Number	Read Value (dBm/470kHz)	Power Spectral Density (dBm/500kHz)	Limit (dBm/500kHz)	Conclusion
802.11a	149	-3.025	-2.61	30	PASS
	157	-2.705	-2.29	30	PASS
	165	-0.127	0.29	30	PASS
802.11n HT20	149	-3.367	-2.94	30	PASS
	157	-2.968	-2.54	30	PASS
	165	-3.158	-2.73	30	PASS
802.11n HT40	151	-6.163	-5.61	30	PASS
	159	-6.238	-5.68	30	PASS
802.11ac VHT20	149	-3.311	-2.90	30	PASS
	157	-3.045	-2.63	30	PASS
	165	-3.122	-2.71	30	PASS
802.11ac VHT40	151	-6.108	-5.55	30	PASS
	159	-6.290	-5.74	30	PASS
802.11ac VHT80	155	-9.461	-8.64	30	PASS

Note: PSD=Read Value+Duty cycle+10*LOG(500/470) correction factor



U-NII-1, 802.11a, Channel No.: 36



U-NII-1, 802.11n HT20, Channel No.: 36



U-NII-1, 802.11a, Channel No.: 40



U-NII-1, 802.11n HT20, Channel No.: 40

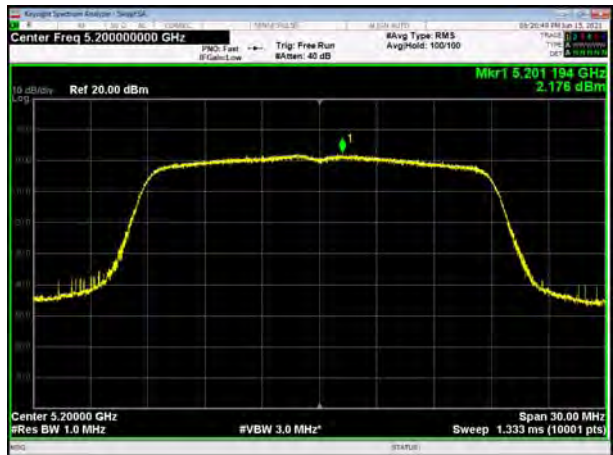

U-NII-1, 802.11a, Channel No.: 48



U-NII-1, 802.11n HT20, Channel No.: 48





U-NII-1, 802.11n HT40, Channel No.: 38



U-NII-1, 802.11ac VHT20, Channel No.: 36



U-NII-1, 802.11n HT40, Channel No.: 46



U-NII-1, 802.11ac VHT20, Channel No.: 40



U-NII-1, 802.11ac VHT40, Channel No.: 38



U-NII-1, 802.11ac VHT20, Channel No.: 48





U-NII-1, 802.11ac VHT40, Channel No.: 46

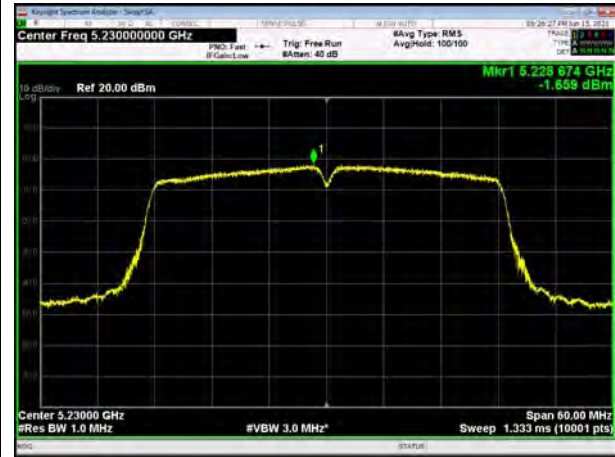

U-NII-1, 802.11ac VHT80, Channel No.: 42



U-NII-2A, 802.11a, Channel No.: 52

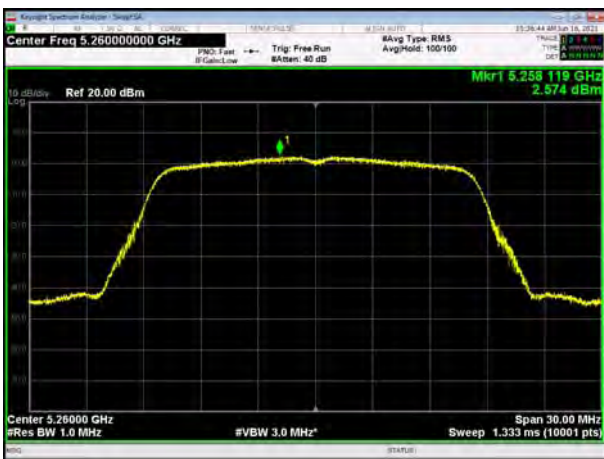

U-NII-2A, 802.11n HT20, Channel No.: 52

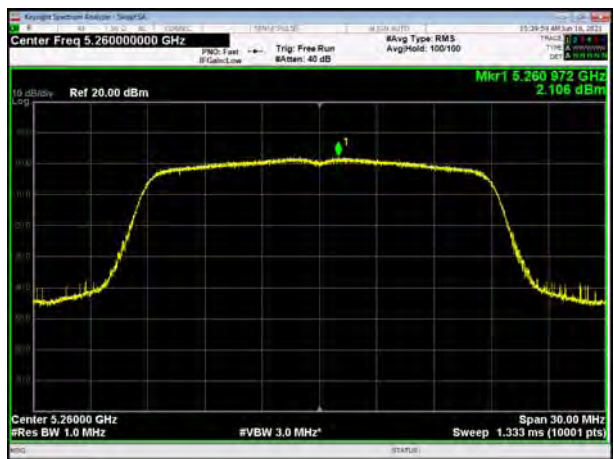

U-NII-2A, 802.11a, Channel No.: 60



U-NII-2A, 802.11n HT20, Channel No.: 60





U-NII-2A, 802.11a, Channel No.: 64

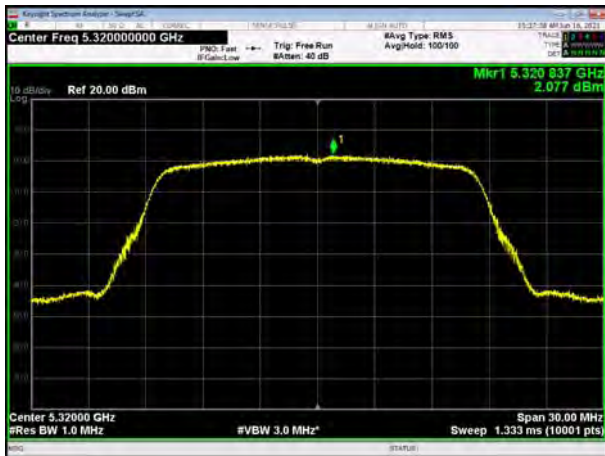

U-NII-2A, 802.11n HT20, Channel No.: 64

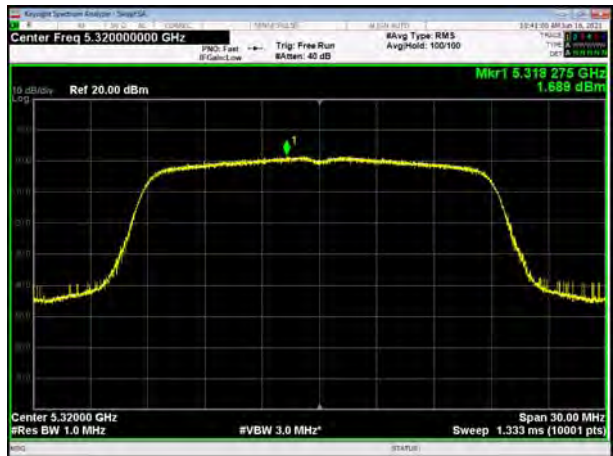

U-NII-2A, 802.11n HT40, Channel No.: 54



U-NII-2A, 802.11ac VHT20, Channel No.: 52

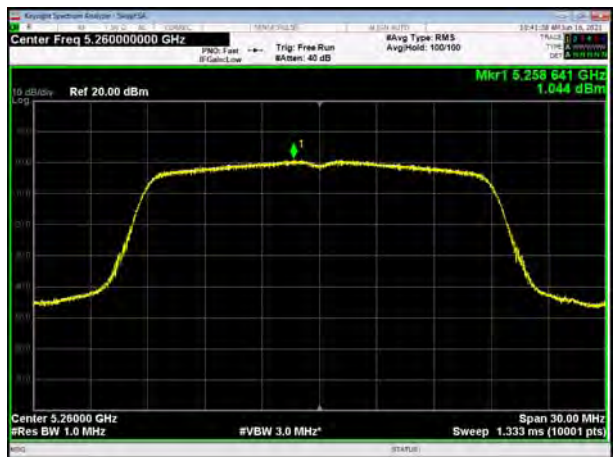

U-NII-2A, 802.11n HT40, Channel No.: 62



U-NII-2A, 802.11ac VHT20, Channel No.: 60

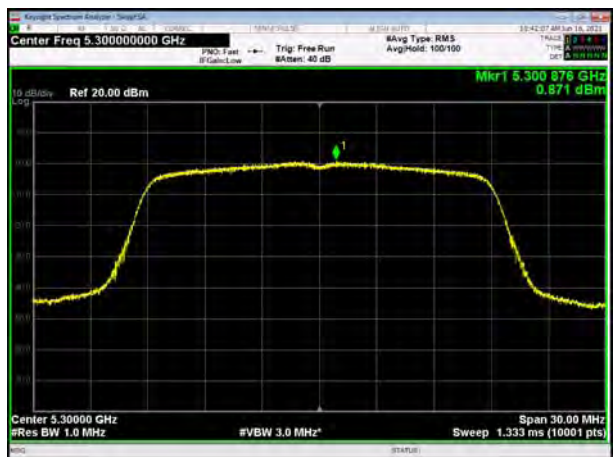



U-NII-2A, 802.11ac VHT40, Channel No.: 54



U-NII-2A, 802.11ac VHT20, Channel No.: 64



U-NII-2A, 802.11ac VHT40, Channel No.: 62



U-NII-2A, 802.11ac VHT80, Channel No.: 58



U-NII-2C, 802.11a, Channel No.: 100



U-NII-2C, 802.11n HT20, Channel No.: 100

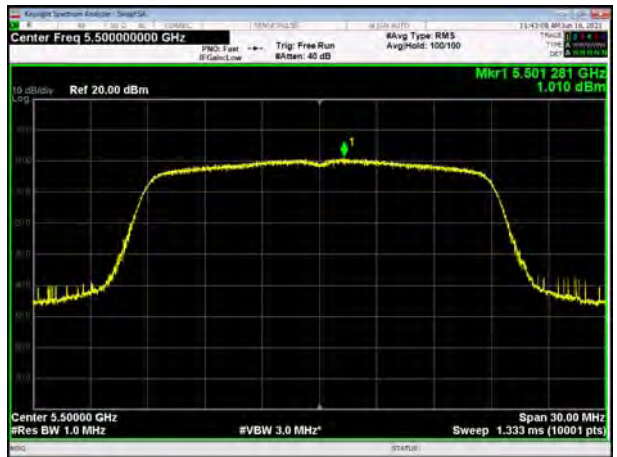



U-NII-2C, 802.11a, Channel No.: 120



U-NII-2C, 802.11n HT20, Channel No.: 120

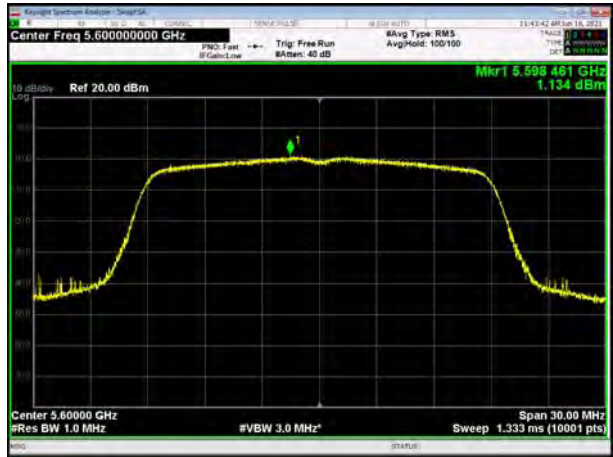

U-NII-2C, 802.11a, Channel No.: 140



U-NII-2C, 802.11n HT20, Channel No.: 140



U-NII-2C, 802.11a, Channel No.: 144

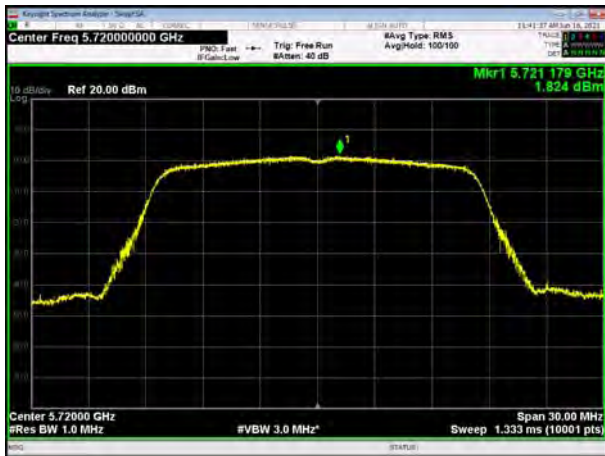

U-NII-2C, 802.11n HT20, Channel No.: 144

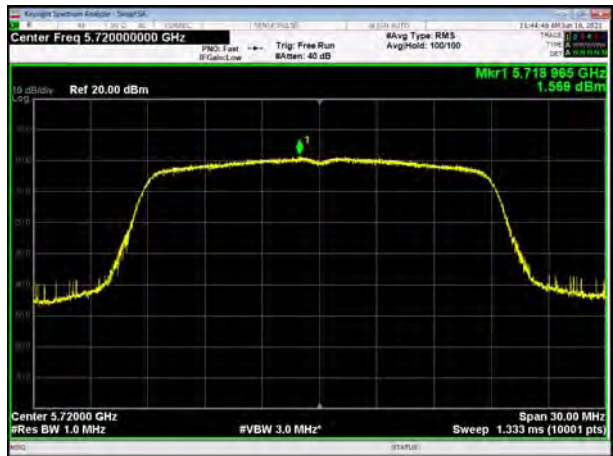

U-NII-2C, 802.11n HT40, Channel No.: 102

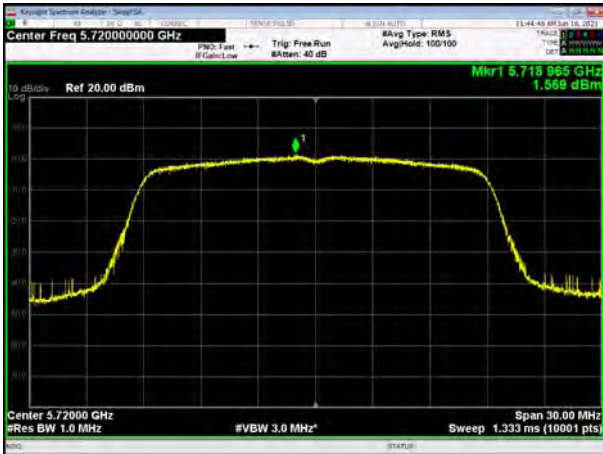

U-NII-2C, 802.11ac VHT20, Channel No.: 100

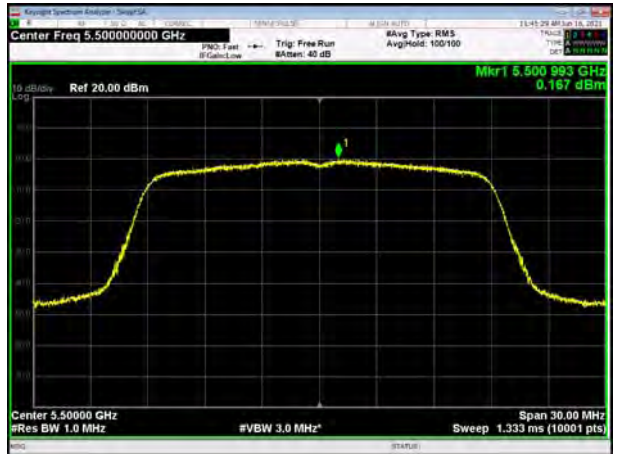

U-NII-2C, 802.11n HT40, Channel No.: 118



U-NII-2C, 802.11ac VHT20, Channel No.: 120



U-NII-2C, 802.11n HT40, Channel No.: 134



U-NII-2C, 802.11ac VHT20, Channel No.: 140

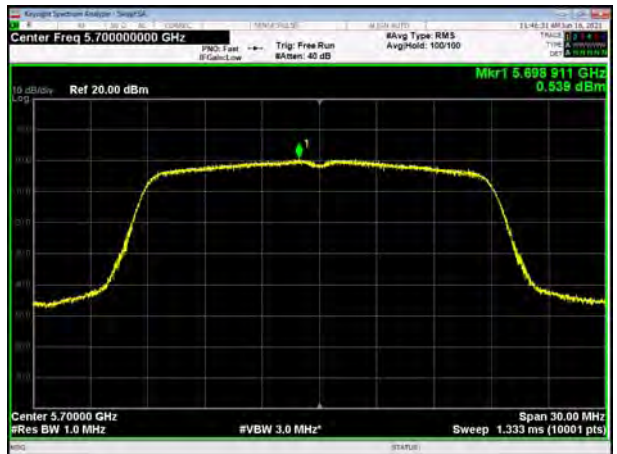

U-NII-2C, 802.11n HT40, Channel No.: 142



U-NII-2C, 802.11ac VHT20, Channel No.: 144

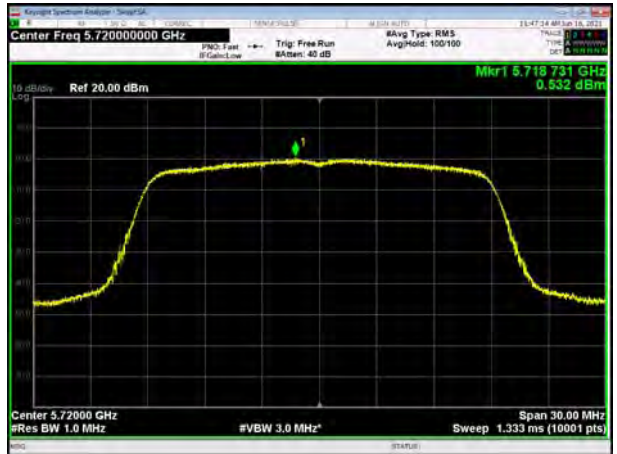

U-NII-2C, 802.11ac VHT40, Channel No.: 102



U-NII-2C, 802.11ac VHT80, Channel No.: 106



U-NII-2C, 802.11ac VHT40, Channel No.: 118



U-NII-2C, 802.11ac VHT80, Channel No.: 122





U-NII-2C, 802.11ac VHT40, Channel No.: 134

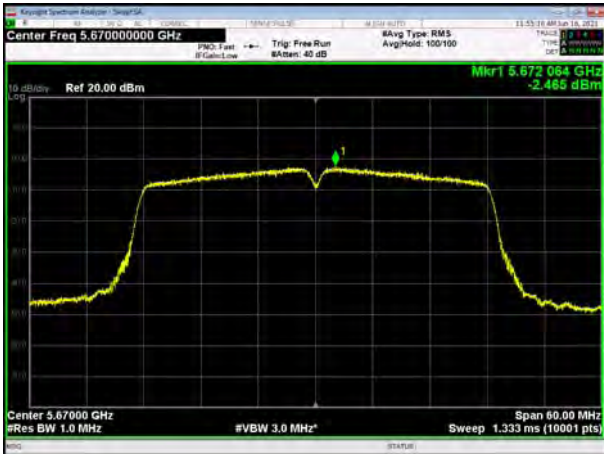

U-NII-2C, 802.11ac VHT80, Channel No.: 138



U-NII-2C, 802.11ac VHT40, Channel No.: 142



U-NII-3, 802.11a, Channel No.: 149



U-NII-3, 802.11n HT20, Channel No.: 149





U-NII-3, 802.11a, Channel No.: 157



U-NII-3, 802.11n HT20, Channel No.: 157



U-NII-3, 802.11a, Channel No.: 165



U-NII-3, 802.11n HT20, Channel No.: 165



U-NII-3, 802.11n HT40, Channel No.: 151



U-NII-3, 802.11ac VHT20, Channel No.: 149



U-NII-3, 802.11n HT40, Channel No.: 159



U-NII-3, 802.11ac VHT20, Channel No.: 157



U-NII-3, 802.11ac VHT40, Channel No.: 151



U-NII-3, 802.11ac VHT20, Channel No.: 165



U-NII-3, 802.11ac VHT40, Channel No.: 159

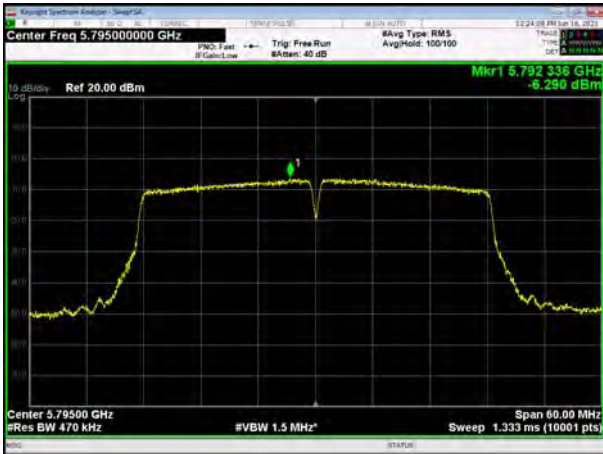

U-NII-3, 802.11ac VHT80, Channel No.: 155

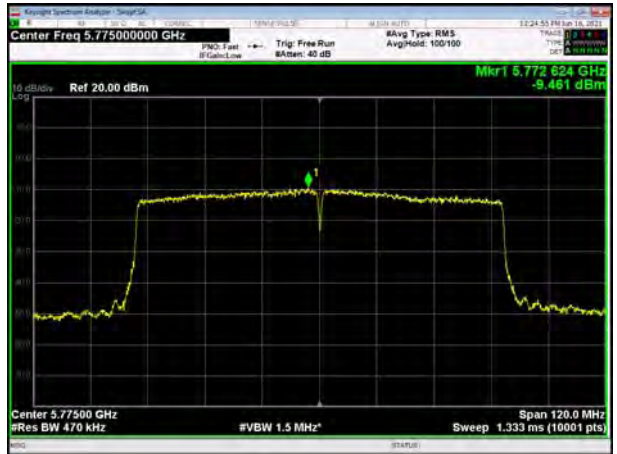

5.5. Unwanted Emission

Ambient condition

Temperature	Relative humidity	Pressure
23°C ~25°C	45%~50%	101.5kPa

Method of Measurement

The test set-up was made in accordance to the general provisions of ANSI C63.10. The Equipment Under Test (EUT) was set up on a non-conductive table in the semi-anechoic chamber. The test was performed at the distance of 3 m between the EUT and the receiving antenna. The radiated emissions measurements were made in a typical installation configuration.

Sweep the whole frequency band range from 9kHz to the 10th harmonic of the carrier, and the emissions less than 20 dB below the permissible value are reported.

During the test, the height of receive antenna shall be moved from 1 to 4 meters, and the antenna shall be performed under horizontal and vertical polarization. The turntable shall be rotated from 0 to 360 degrees for detecting the maximum of radiated spurious signal level. The measurements shall be repeated with orthogonal polarization of the test antenna. The data of cable loss and antenna factor has been calibrated in full testing frequency range before the testing.

Set the spectrum analyzer in the following:

9kHz~150 kHz

RBW=200Hz, VBW=1kHz/ Sweep=AUTO

150 kHz~30MHz

RBW=9KHz, VBW=30KHz,/ Sweep=AUTO

Below 1GHz

RBW=100kHz / VBW=300kHz / Sweep=AUTO

a) Peak emission levels are measured by setting the instrument as follows:

Above 1GHz

PEAK: RBW=1MHz VBW=3MHz/ Sweep=AUTO

b) Average emission levels are measured by setting the instrument as follows:

Above 1GHz

AVERAGE: RBW=1MHz / VBW=3MHz / Sweep=AUTO

c) Detector: The measurements employing a CISPR quasi-peak detector except for the frequency bands 9-90 kHz, 110-490 kHz and above 1000 MHz. Radiated emission limits in these three bands are based on measurements employing an average detector.

d) Averaging type = power (i.e., rms) (As an alternative, the detector and averaging type may be set for linear voltage averaging. Some instruments require linear display mode to use linear voltage averaging. Log or dB averaging shall not be used.)

e) Sweep time = auto.

f) Perform a trace average of at least 100 traces if the transmission is continuous. If the transmission is not continuous, then the number of traces shall be increased by a factor of $1 / D$, where D is the duty cycle. For example, with 50% duty cycle, at least 200 traces shall be averaged. (If a specific



emission is demonstrated to be continuous—i.e., 100% duty cycle—then rather than turning ON and OFF with the transmit cycle, at least 100 traces shall be averaged.)

g) If tests are performed with the EUT transmitting at a duty cycle less than 98%, then a correction factor shall be added to the measurement results prior to comparing with the emission limit, to compute the emission level that would have been measured had the test been performed at 100% duty cycle. The correction factor is computed as follows:

1) If power averaging (rms) mode was used in the preceding step e), then the correction factor is $[10 \log (1 / D)]$, where D is the duty cycle. For example, if the transmit duty cycle was 50%, then 3 dB shall be added to the measured emission levels.

2) If linear voltage averaging mode was used in the preceding step e), then the correction factor is $[20 \log (1 / D)]$, where D is the duty cycle. For example, if the transmit duty cycle was 50%, then 6 dB shall be added to the measured emission levels.

3) If a specific emission is demonstrated to be continuous (100% duty cycle) rather than turning ON and OFF with the transmit cycle, then no duty cycle correction is required for that emission.

Reduce the video bandwidth until no significant variations in the displayed signal are observed in subsequent traces, provided the video bandwidth is no less than 1 Hz. For regulatory requirements that specify averaging only over the transmit duration (e.g., digital transmission system [DTS] and Unlicensed National Information Infrastructure [U-NII]), the video bandwidth shall be greater than $[1 / (\text{minimum transmitter on time})]$ and no less than 1 Hz.

The field strength of spurious emission was measured in the following position: EUT stand-up position (Z axis), lie-down position (X, Y axis). The worst emission was found in stand-up position (Z axis) and the loop antenna is vertical, others antenna are vertical and horizontal.

The test is in transmitting mode.

9KHz~~~30MHz

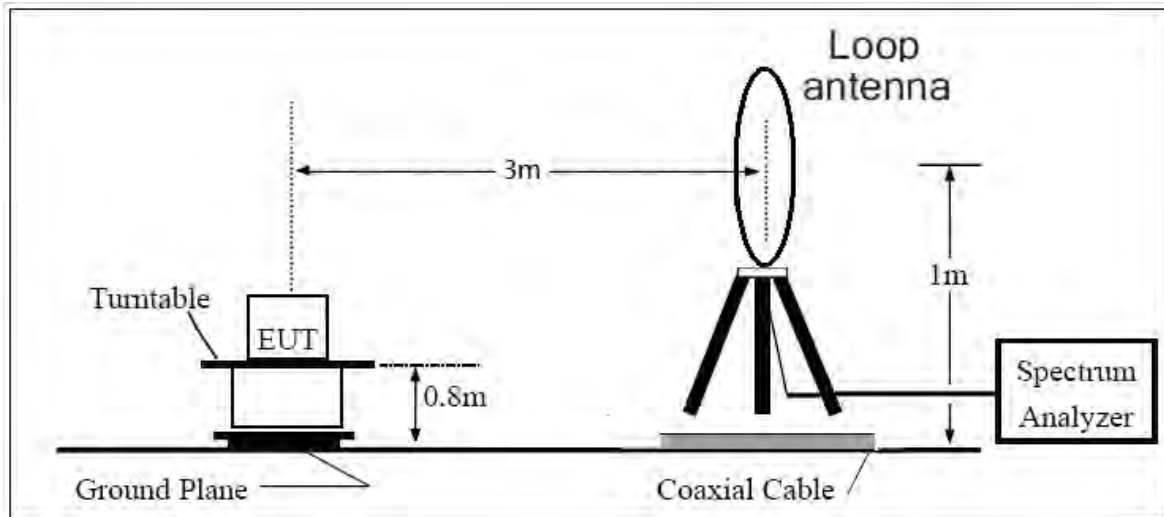

30MHz~~~ 1GHz

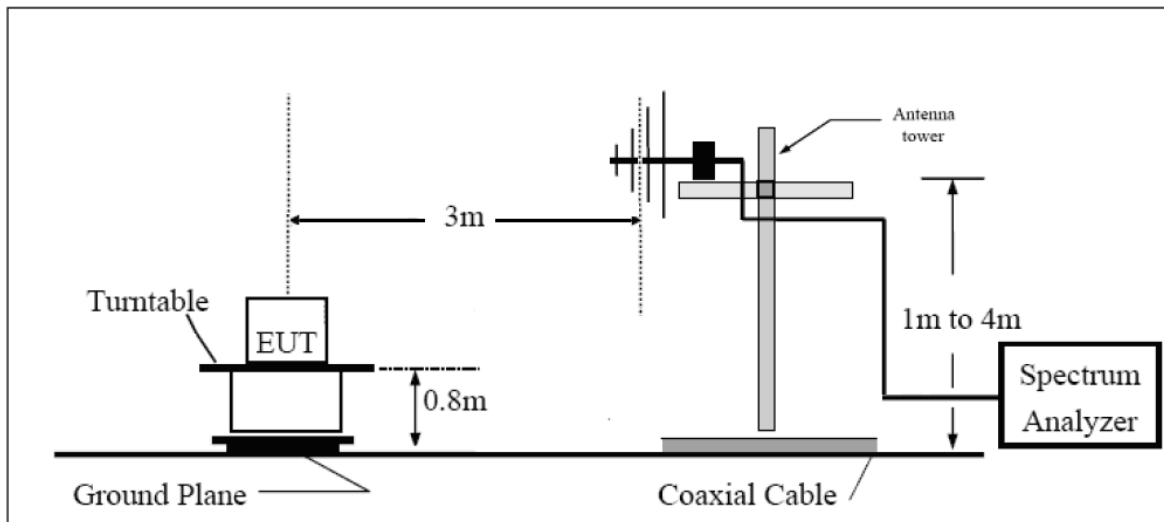

Above 1GHz

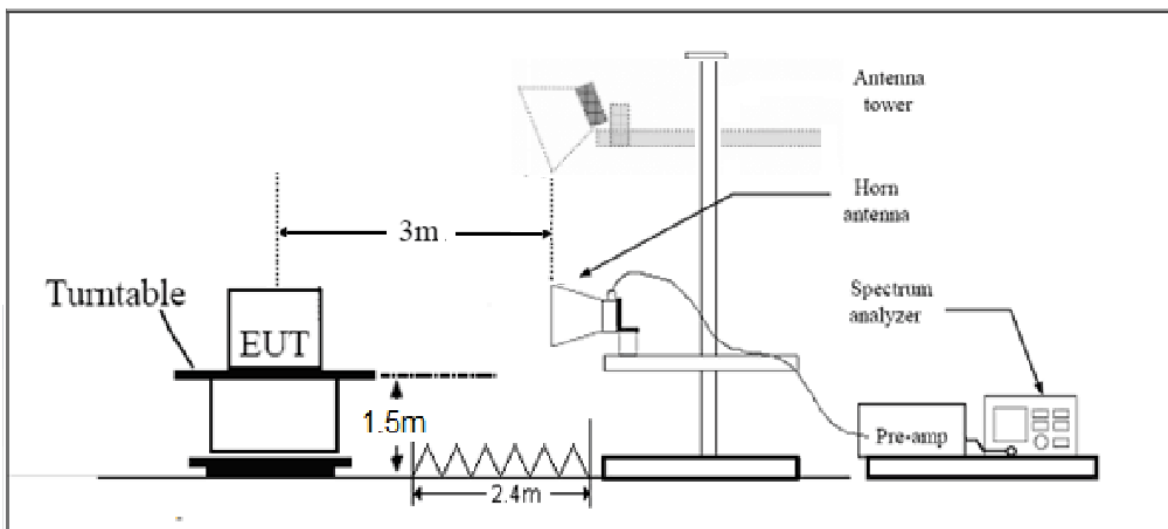

Note: Area side:2.4mX3.6m

**Limits**

- (1) For transmitters operating in the 5725-5850 MHz band: All emissions shall be limited to a level of -27 dBm/MHz at 75 MHz or more above or below the band edge increasing linearly to 10 dBm/MHz at 25 MHz above or below the band edge, and from 25 MHz above or below the band edge increasing linearly to a level of 15.6 dBm/MHz at 5 MHz above or below the band edge, and from 5 MHz above or below the band edge increasing linearly to a level of 27 dBm/MHz at the band edge.
- (2) For transmitters operating in the 5.15-5.25 GHz band: All emissions outside of the 5.15-5.35 GHz band shall not exceed an e.i.r.p. of -27 dBm/MHz(68.2dBμV/m).
- (3) For transmitters operating in the 5.25-5.35 GHz band: All emissions outside of the 5.15-5.35 GHz band shall not exceed an e.i.r.p. of -27 dBm/MHz(68.2dBμV/m).
- (4) For transmitters operating in the 5.47-5.725 GHz band: All emissions outside of the 5.47-5.725 GHz band shall not exceed an e.i.r.p. of -27 dBm/MHz(68.2dBμV/m).

Note: the following formula is used to convert the EIRP to field strength

§1、 $E[\text{dB}\mu\text{V}/\text{m}] = \text{EIRP}[\text{dBm}] - 20 \log(d[\text{meters}]) + 104.77$, where E = field strength and

d = distance at which field strength limit is specified in the rules;

§2、 $E[\text{dB}\mu\text{V}/\text{m}] = \text{EIRP}[\text{dBm}] + 95.2$, for d = 3 meters

- (5) Unwanted spurious emissions fallen in restricted bands per FCC Part15.205 shall comply with the general field strength limits set forth in § 15.209 as below table.

Frequency of emission (MHz)	Field strength(uV/m)	Field strength(dBuV/m)
0.009–0.490	2400/F(kHz)	/
0.490–1.705	24000/F(kHz)	/
1.705–30.0	30	/
30-88	100	40
88-216	150	43.5
216-960	200	46
Above960	500	54



MHz	MHz	MHz	GHz
0.090 - 0.110	16.42 - 16.423	399.9 - 410	4.5 - 5.15
0.495 - 0.505	16.69475 - 16.69525	608 - 614	5.35 - 5.46
2.1735 - 2.1905	16.80425 - 16.80475	960 - 1240	7.25 - 7.75
4.125 - 4.128	25.5 - 25.67	1300 - 1427	8.025 - 8.5
4.17725 - 4.17775	37.5 - 38.25	1435 - 1626.5	9.0 - 9.2
4.20725 - 4.20775	73 - 74.6	1645.5 - 1646.5	9.3 - 9.5
6.215 - 6.218	74.8 - 75.2	1660 - 1710	10.6 - 12.7
6.26775 - 6.26825	108 - 121.94	1718.8 - 1722.2	13.25 - 13.4
6.31175 - 6.31225	123 - 138	2200 - 2300	14.47 - 14.5
8.291 - 8.294	149.9 - 150.05	2310 - 2390	15.35 - 16.2
8.362 - 8.366	156.52475 - 156.52525	2483.5 - 2500	17.7 - 21.4
8.37625 - 8.38675	156.7 - 156.9	2690 - 2900	22.01 - 23.12
8.41425 - 8.41475	162.0125 - 167.17	3260 - 3267	23.6 - 24.0
12.29 - 12.293	167.72 - 173.2	3332 - 3339	31.2 - 31.8
12.51975 - 12.52025	240 - 285	3345.8 - 3358	36.43 - 36.5
12.57675 - 12.57725	322 - 335.4	3600 - 4400	(²)
13.36 - 13.41			

Measurement Uncertainty

The assessed measurement uncertainty to ensure 95% confidence level for the normal distribution is with the coverage factor $k = 1.96$.

Frequency	Uncertainty
9KHz-30MHz	3.55 dB
30MHz-200MHz	4.17 dB
200MHz-1GHz	4.84 dB
1-18GHz	4.35 dB
18-26.5GHz	5.90 dB
26.5GHz~40GHz	5.92 dB



Test Results:

The modulation and bandwidth are similar for 802.11n mode for 20MHz/40MHz and 802.11ac mode for V20MHz/V40MHz, therefore investigated worst case to representative mode in test report.

The signal beyond the limit is carrier.

U-NII-1

802.11a-Channel 36: Peak & Average

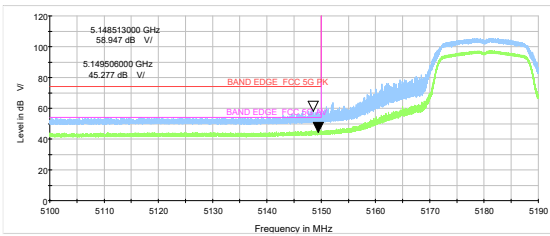

802.11a-Channel 48: Peak & Average

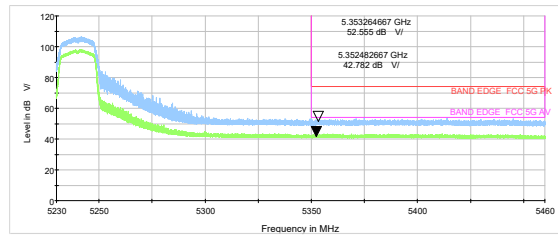

802.11n HT20-Channel 36: Peak & Average

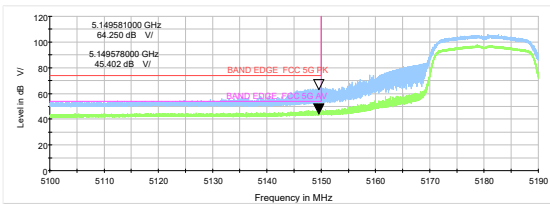

802.11n HT20-Channel 48: Peak & Average

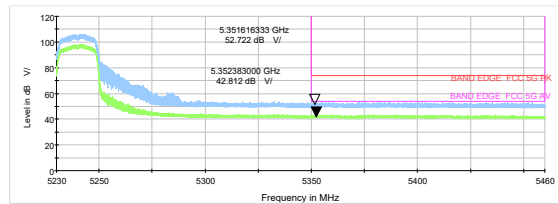

802.11n HT40-Channel 38: Peak & Average

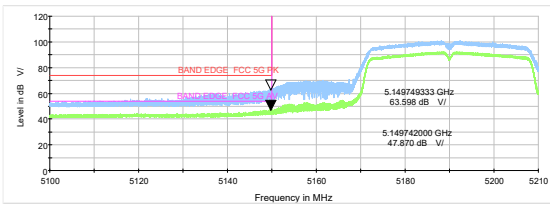

802.11n HT40-Channel 46: Peak & Average

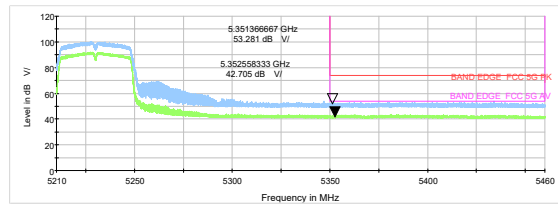

802.11ac VHT80 -Channel 42: Peak & Average

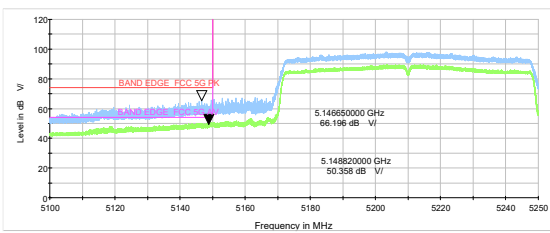



U-NII-2A

802.11a-Channel 52: Peak & Average

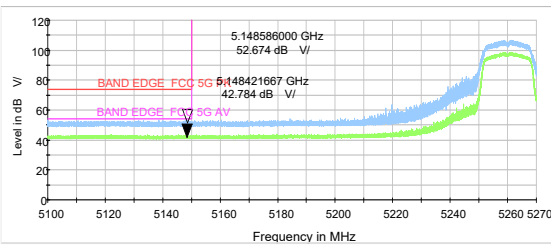

802.11a-Channel 64: Peak & Average

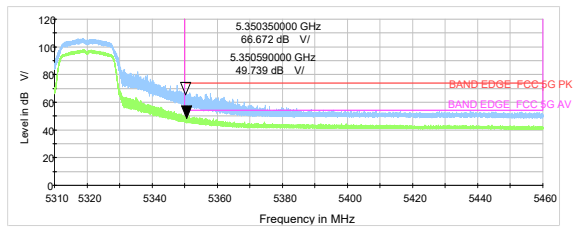

802.11n HT20-Channel 52: Peak & Average

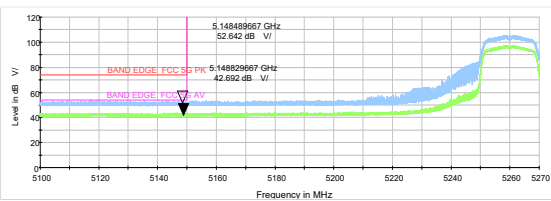

802.11n HT20-Channel 64: Peak & Average

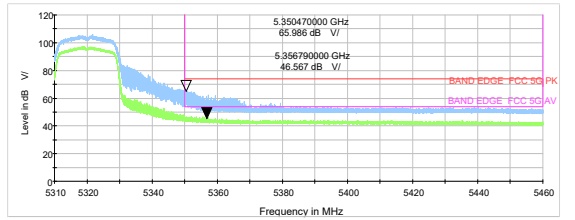

802.11n HT40-Channel 54: Peak & Average

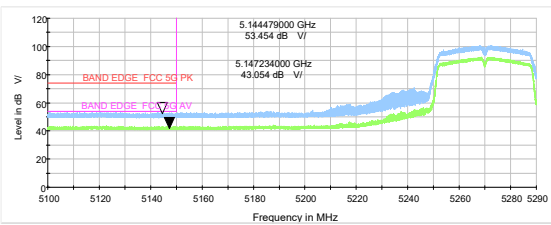

802.11n HT40-Channel 62: Peak & Average

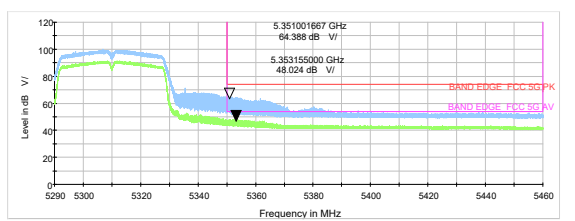

802.11ac VHT80 -Channel 58: Peak & Average

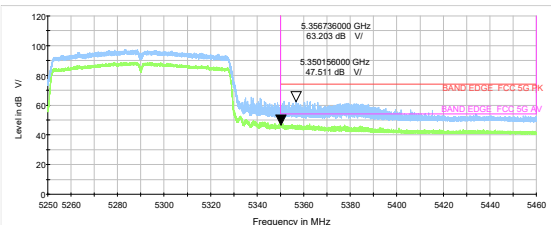



U-NII-2C

802.11a-Channel 100: Peak & Average

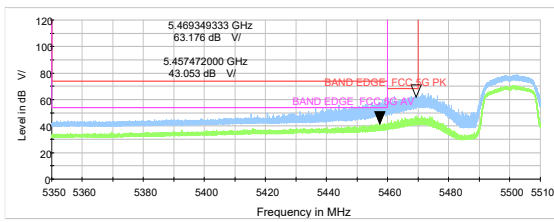

802.11n HT20-Channel 100: Peak & Average

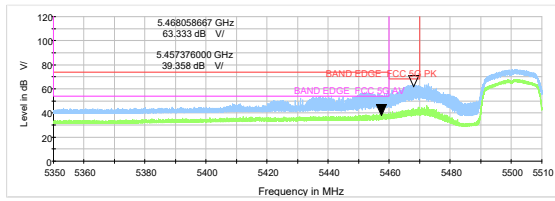

802.11a-Channel 140: Peak

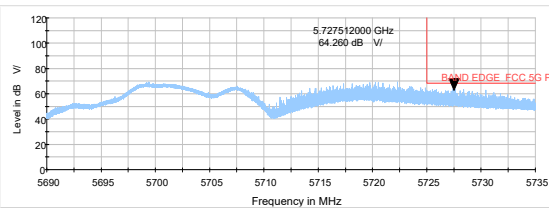

802.11n HT20-Channel 140: Peak

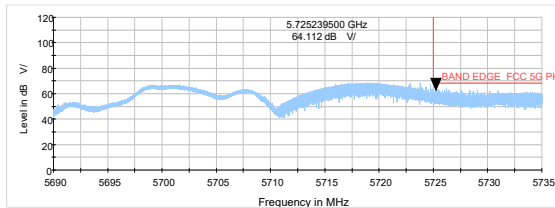

802.11n HT40-Channel 102: Peak & Average

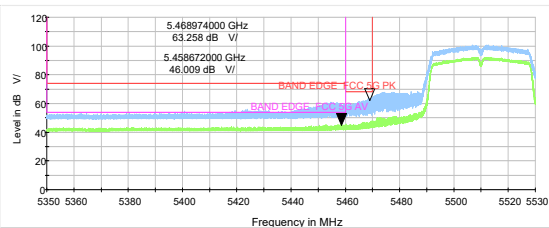

802.11n HT40-Channel 134: Peak & Average

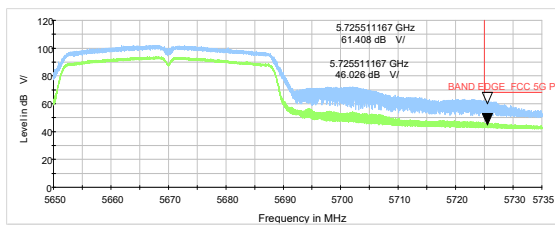

802.11ac VHT80 -Channel 106: Peak & Average

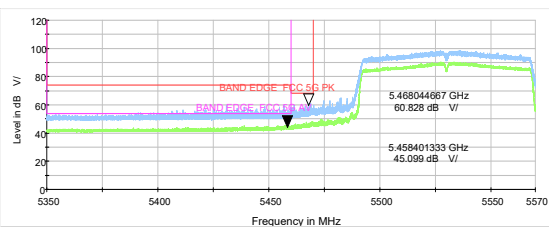



U-NII-3

802.11a-Channel 149: Peak

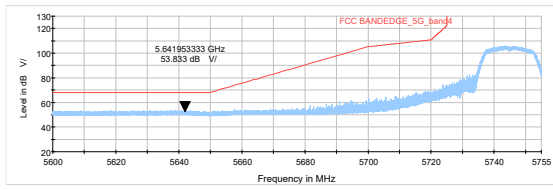

802.11a-Channel 165: Peak

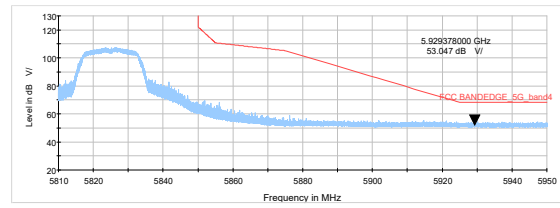

802.11n HT20-Channel 149: Peak

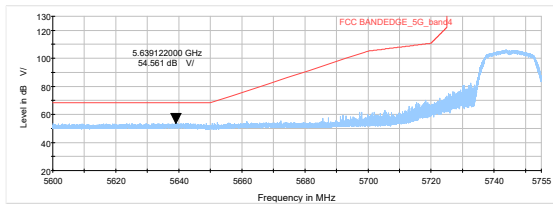

802.11n HT20-Channel 165: Peak

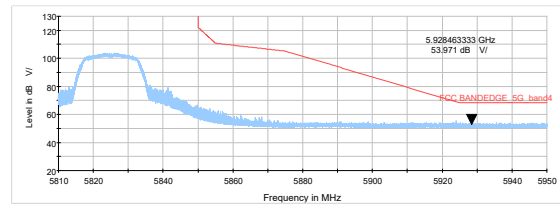

802.11n HT40-Channel 151: Peak

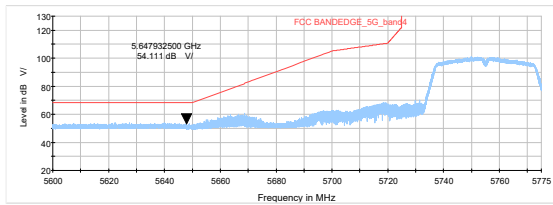

802.11n HT40-Channel 159: Peak

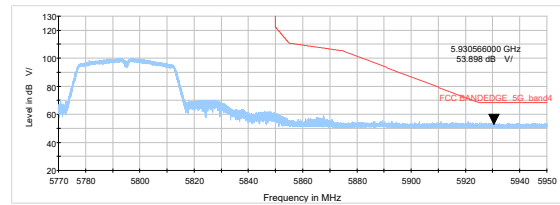

802.11ac VHT80- Channel 155: Peak

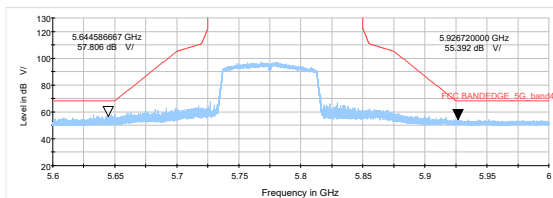



Result of RE

Test result

Sweep the whole frequency band through the range from 9kHz to the 10th harmonic of the carrier, the Emissions in the frequency band 9kHz-30MHz and 26.5GHz-40GHz are more than 20dB below the limit are not reported.

During the test, the Radiates Emission from 30MHz to 1GHz was performed in all modes with all channels, 802.11ac (VHT80) CH42 are selected as the worst condition. The test data of the worst-case condition was recorded in this report.

A font (Level in dB μ V/)in the test plot =(level in dB μ V/m)

Continuous TX mode:

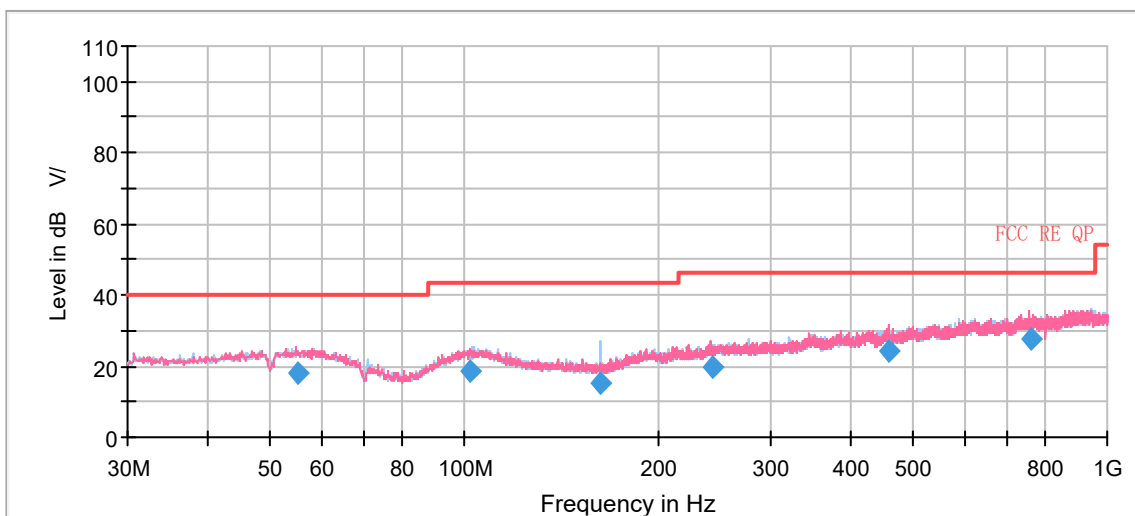

Radiates Emission from 30MHz to 1GHz

Frequency (MHz)	Quasi-Peak (dBuV/m)	Height (cm)	Polarization	Azimuth (deg)	Correct Factor (dB)	Margin (dB)	Limit (dBuV/m)
55.096250	18.14	225.0	V	148.0	-4.7	21.86	40.00
101.990000	18.77	110.0	H	226.0	-5.6	24.73	43.50
163.247000	15.02	175.0	H	138.0	-8.9	28.48	43.50
243.630000	19.85	175.0	V	178.0	-4.5	26.15	46.00
456.563000	24.48	125.0	V	166.0	-0.4	21.52	46.00
759.631500	27.63	123.0	V	8.0	4.0	18.37	46.00

Remark: 1. Correction Factor = Antenna factor+ Insertion loss(cable loss+amplifier gain)

2. Margin = Limit – Quasi-Peak



802.11a CH36

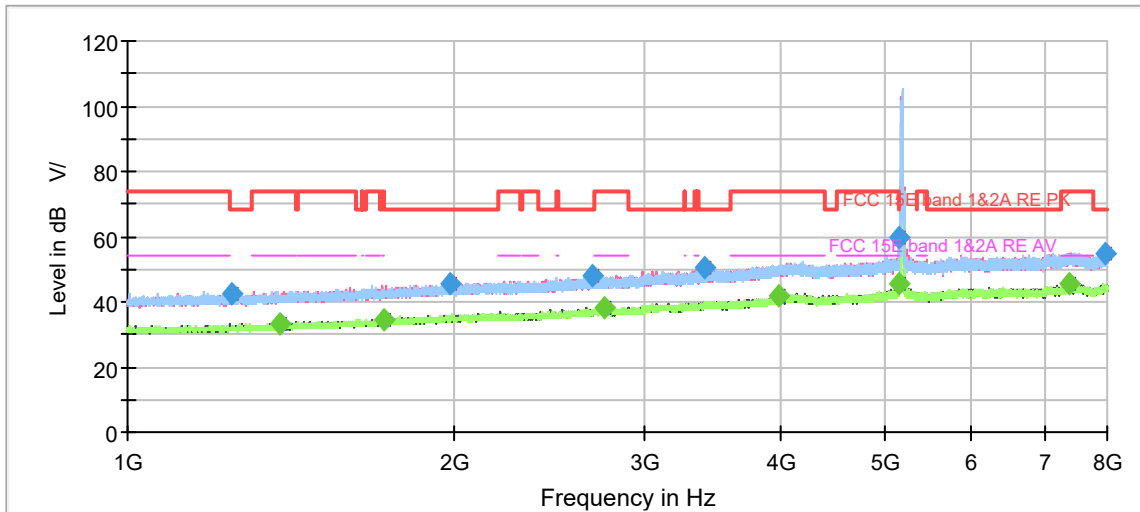

Note: The signal beyond the limit is carrier.
Radiates Emission from 1GHz to 8GHz

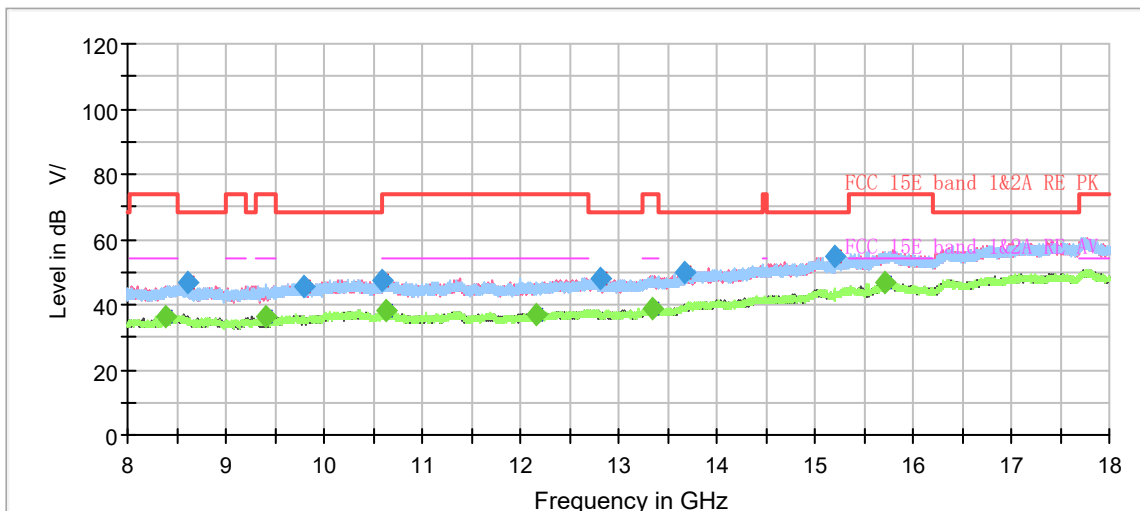

Radiates Emission from 8GHz to 18GHz



Frequency (MHz)	Peak (dBuV/m)	Average (dBuV/m)	Limit (dBuV/m)	Margin (dB)	Height (cm)	Polarization	Azimuth (deg)	Correct Factor (dB)
1248.500000	42.53	---	68.20	25.67	200.0	H	0.0	-7.0
1379.166667	---	33.38	54.00	20.62	100.0	V	317.0	-6.3
1721.933333	---	34.58	54.00	19.42	100.0	H	233.0	-4.3
1986.066667	45.84	---	68.20	22.36	200.0	V	0.0	-2.7
2686.300000	48.28	---	68.20	19.92	200.0	H	304.0	0.5
2752.800000	---	37.96	54.00	16.04	200.0	H	339.0	0.8
3408.700000	50.48	---	68.20	17.72	200.0	H	89.0	3.5
3988.533333	---	41.65	54.00	12.35	100.0	V	226.0	6.1
5148.666667	---	45.52	54.00	8.48	200.0	H	202.0	8.7
5149.600000	59.51	---	74.00	14.49	100.0	V	0.0	8.7
7364.633333	---	45.71	54.00	8.29	100.0	V	133.0	11.5
7974.100000	54.96	---	68.20	13.24	200.0	H	0.0	11.9

Remark: 1. Correction Factor = Antenna factor+ Insertion loss (cable loss + amplifier gain)

802.11a CH40

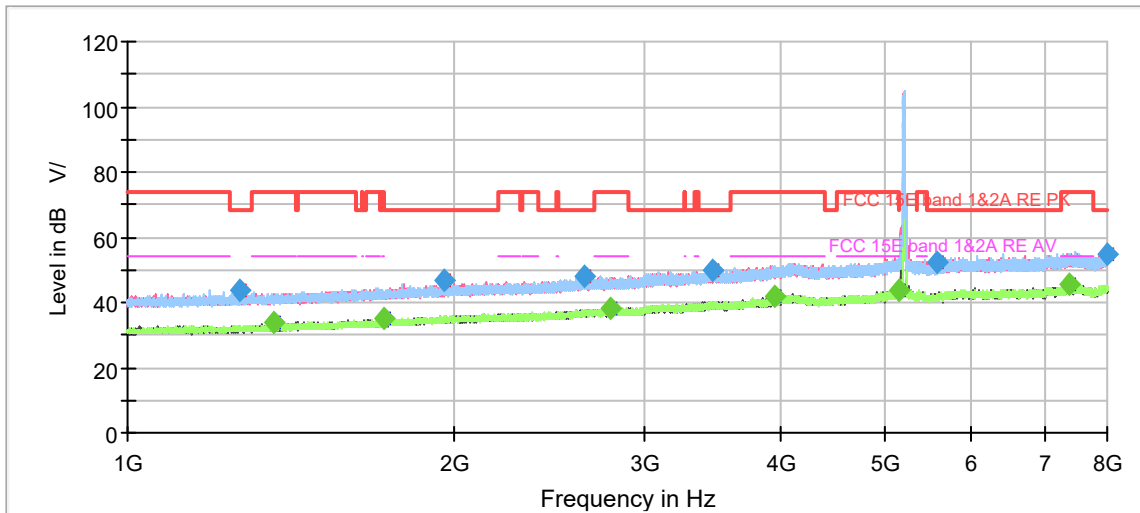

Note: The signal beyond the limit is carrier.
Radiates Emission from 1GHz to 8GHz

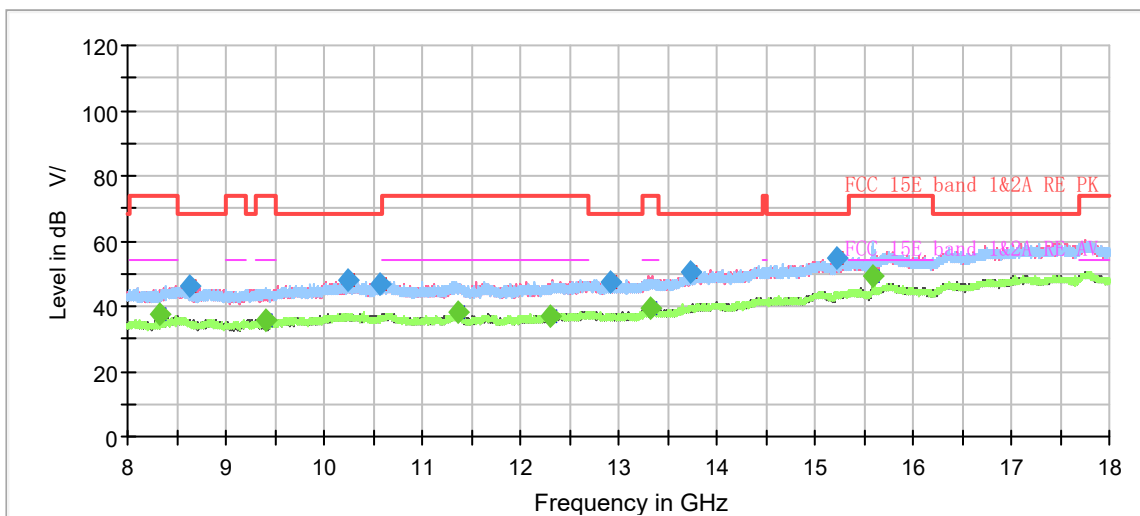

Radiates Emission from 8GHz to 18GHz



Frequency (MHz)	Peak (dBuV/m)	Average (dBuV/m)	Limit (dBuV/m)	Margin (dB)	Height (cm)	Polarization	Azimuth (deg)	Correct Factor (dB)
1270.433333	43.57	---	68.20	24.63	200.0	H	337.0	-6.9
1364.700000	---	33.74	54.00	20.26	100.0	H	92.0	-6.4
1720.300000	---	34.90	54.00	19.10	200.0	H	330.0	-4.4
1960.866667	46.57	---	68.20	21.63	100.0	H	107.0	-2.9
2641.733333	48.01	---	68.20	20.19	100.0	H	320.0	0.3
2786.866667	---	38.23	54.00	15.77	100.0	H	247.0	0.9
3456.066667	49.90	---	68.20	18.30	200.0	H	344.0	3.6
3941.400000	---	41.60	54.00	12.40	200.0	V	192.0	5.7
5149.366667	---	43.60	54.00	10.40	200.0	V	336.0	8.7
5571.233333	52.47	---	68.20	15.73	200.0	V	19.0	8.9
7375.133333	---	45.40	54.00	8.60	100.0	V	309.0	11.5
7991.366667	54.70	---	68.20	13.50	200.0	V	81.0	11.9

Remark: 1. Correction Factor = Antenna factor+ Insertion loss (cable loss + amplifier gain)

802.11a CH48

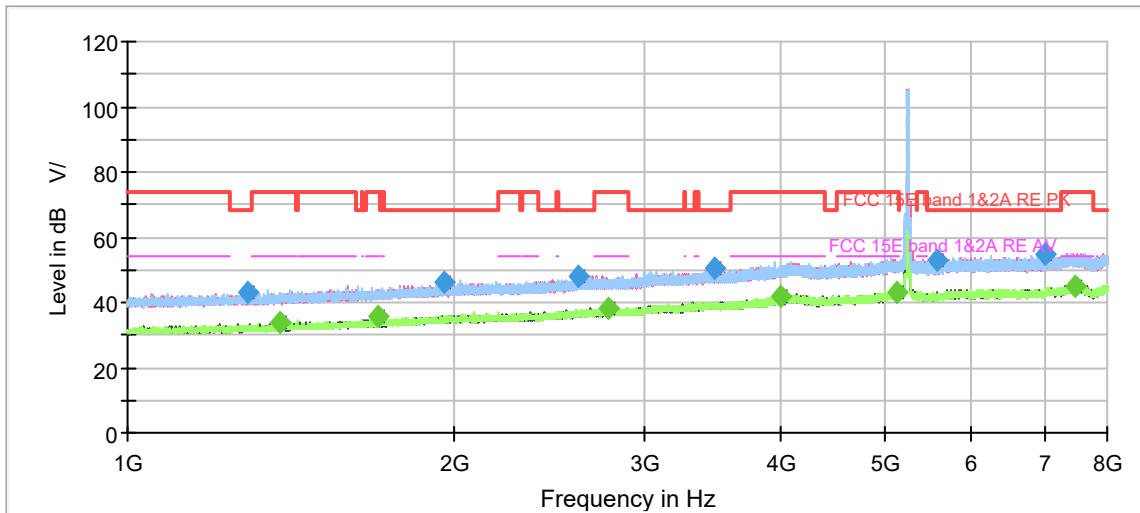

Note: The signal beyond the limit is carrier.
Radiates Emission from 1GHz to 8GHz

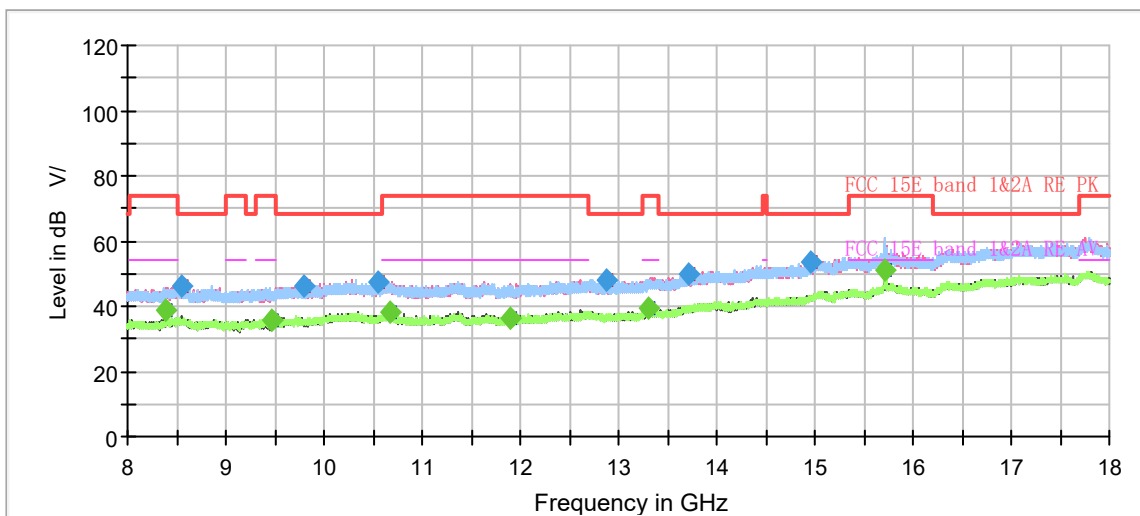

Radiates Emission from 8GHz to 18GHz



Frequency (MHz)	Peak (dBuV/m)	Average (dBuV/m)	Limit (dBuV/m)	Margin (dB)	Height (cm)	Polarization	Azimuth (deg)	Correct Factor (dB)
1293.300000	43.04	---	68.20	25.16	100.0	H	137.0	-6.8
1381.966667	---	33.68	54.00	20.32	100.0	H	16.0	-6.3
1701.866667	---	35.93	54.00	18.07	200.0	H	331.0	-4.5
1955.500000	45.85	---	68.20	22.35	100.0	H	81.0	-2.9
2608.600000	47.86	---	68.20	20.34	200.0	V	135.0	0.1
2774.033333	---	38.23	54.00	15.77	200.0	H	236.0	0.8
3475.433333	50.38	---	68.20	17.82	100.0	V	310.0	3.7
3996.700000	---	41.94	54.00	12.06	100.0	V	134.0	6.2
5126.500000	---	43.33	54.00	10.67	200.0	V	23.0	8.7
5578.700000	52.75	---	68.20	15.45	200.0	V	183.0	8.9
7011.133333	54.90	---	68.20	13.30	100.0	H	2.0	10.8
7463.800000	---	45.17	54.00	8.83	100.0	H	257.0	11.5

Remark: 1. Correction Factor = Antenna factor+ Insertion loss (cable loss + amplifier gain)

802.11a CH52

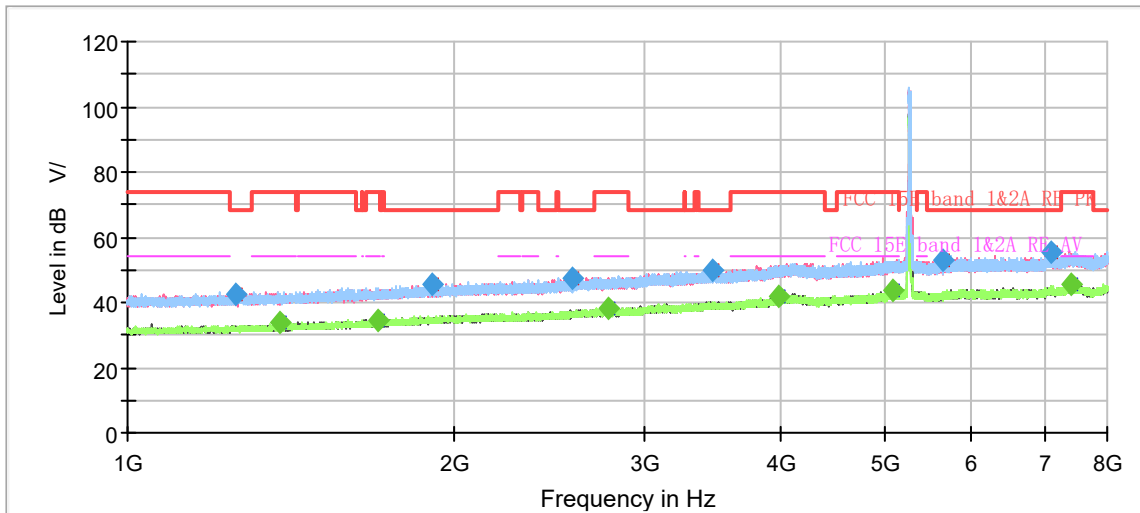

Note: The signal beyond the limit is carrier.
Radiates Emission from 1GHz to 8GHz

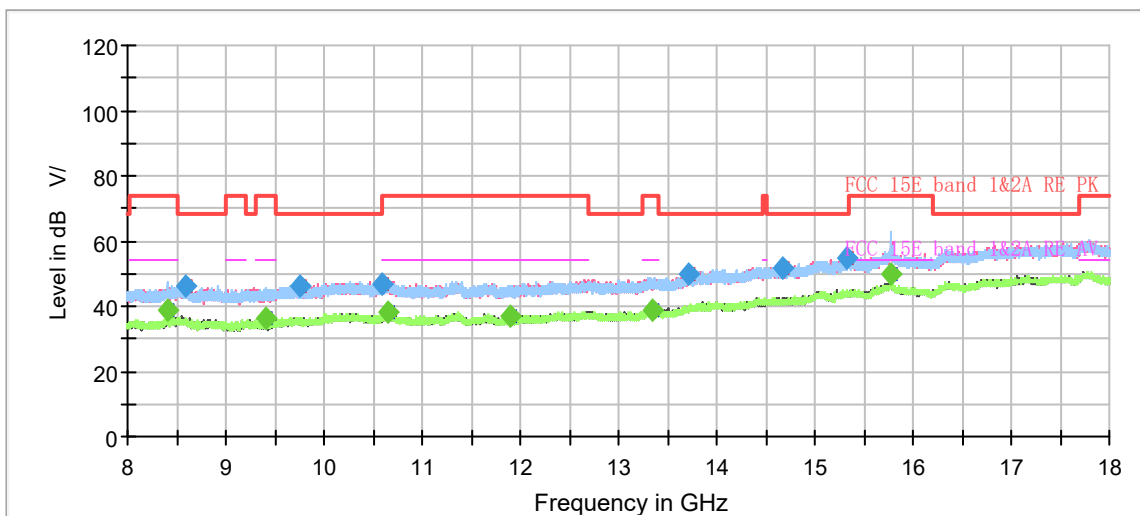

Radiates Emission from 8GHz to 18GHz



Frequency (MHz)	Peak (dBuV/m)	Average (dBuV/m)	Limit (dBuV/m)	Margin (dB)	Height (cm)	Polarization	Azimuth (deg)	Correct Factor (dB)
1255.500000	42.75	---	68.20	25.45	100.0	V	48.0	-7.0
1379.866667	---	33.60	54.00	20.40	100.0	H	146.0	-6.3
1699.766667	---	34.69	54.00	19.31	100.0	H	83.0	-4.5
1909.300000	45.56	---	68.20	22.64	100.0	H	189.0	-3.3
2570.566667	47.48	---	68.20	20.72	200.0	V	107.0	-0.2
2770.533333	---	38.10	54.00	15.90	200.0	V	0.0	0.8
3458.400000	49.68	---	68.20	18.52	200.0	V	72.0	3.6
3981.300000	---	41.80	54.00	12.20	200.0	H	227.0	6.0
5085.900000	---	43.45	54.00	10.55	100.0	V	331.0	8.7
5637.266667	52.66	---	68.20	15.54	200.0	H	331.0	9.2
7101.433333	55.20	---	68.20	13.00	200.0	H	213.0	11.0
7412.233333	---	45.39	54.00	8.61	100.0	V	192.0	11.5

Remark: 1. Correction Factor = Antenna factor+ Insertion loss (cable loss + amplifier gain)

802.11a CH60

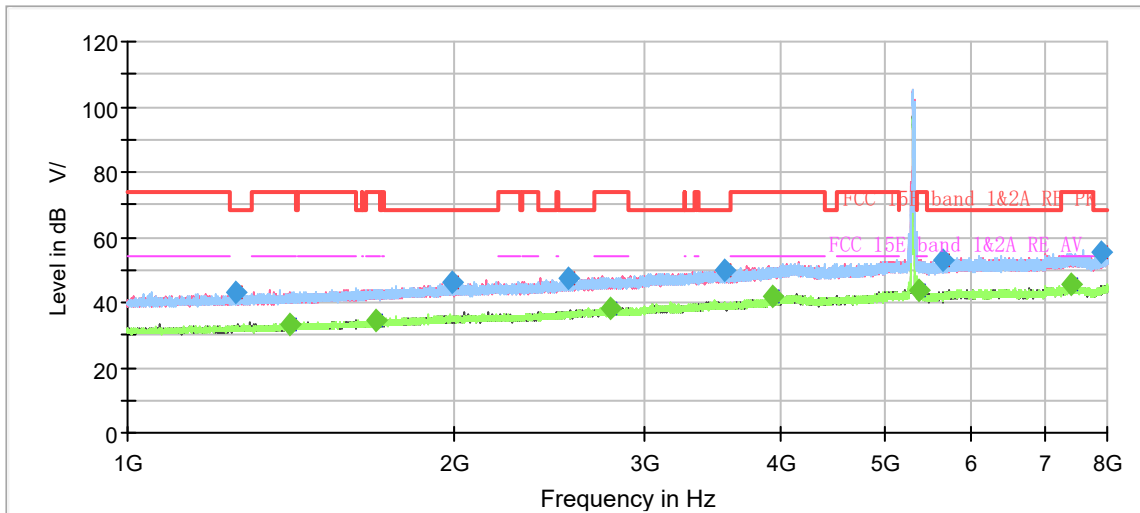

Note: The signal beyond the limit is carrier.
Radiates Emission from 1GHz to 8GHz

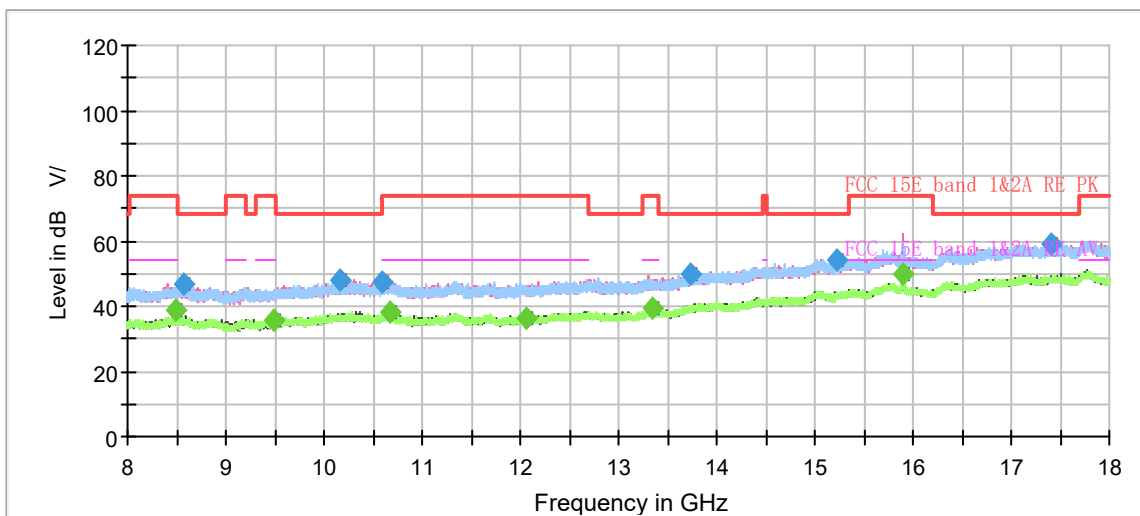

Radiates Emission from 8GHz to 18GHz



Frequency (MHz)	Peak (dBuV/m)	Average (dBuV/m)	Limit (dBuV/m)	Margin (dB)	Height (cm)	Polarization	Azimuth (deg)	Correct Factor (dB)
1256.900000	42.93	---	68.20	25.27	100.0	H	22.0	-7.0
1411.366667	---	33.39	54.00	20.61	200.0	H	329.0	-6.1
1694.400000	---	34.57	54.00	19.43	200.0	V	130.0	-4.5
1991.666667	46.12	---	68.20	22.08	100.0	V	275.0	-2.7
2551.200000	47.50	---	68.20	20.70	200.0	H	267.0	-0.3
2781.500000	---	38.15	54.00	15.85	100.0	V	141.0	0.9
3545.433333	49.88	---	68.20	18.32	200.0	V	46.0	3.8
3927.400000	---	41.74	54.00	12.26	200.0	H	0.0	5.6
5357.266667	---	43.47	54.00	10.53	200.0	V	109.0	8.7
5637.966667	52.80	---	68.20	15.40	100.0	H	57.0	9.2
7423.666667	---	45.47	54.00	8.53	200.0	H	167.0	11.5
7910.866667	55.24	---	68.20	12.96	100.0	H	212.0	11.7

Remark: 1. Correction Factor = Antenna factor+ Insertion loss (cable loss + amplifier gain)

802.11a CH64

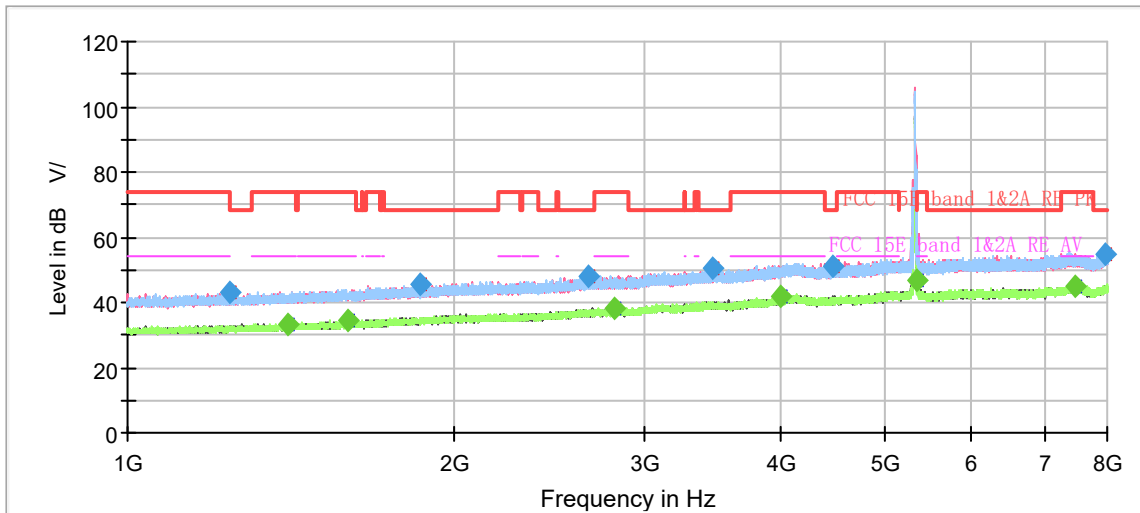

Note: The signal beyond the limit is carrier.
Radiates Emission from 1GHz to 8GHz

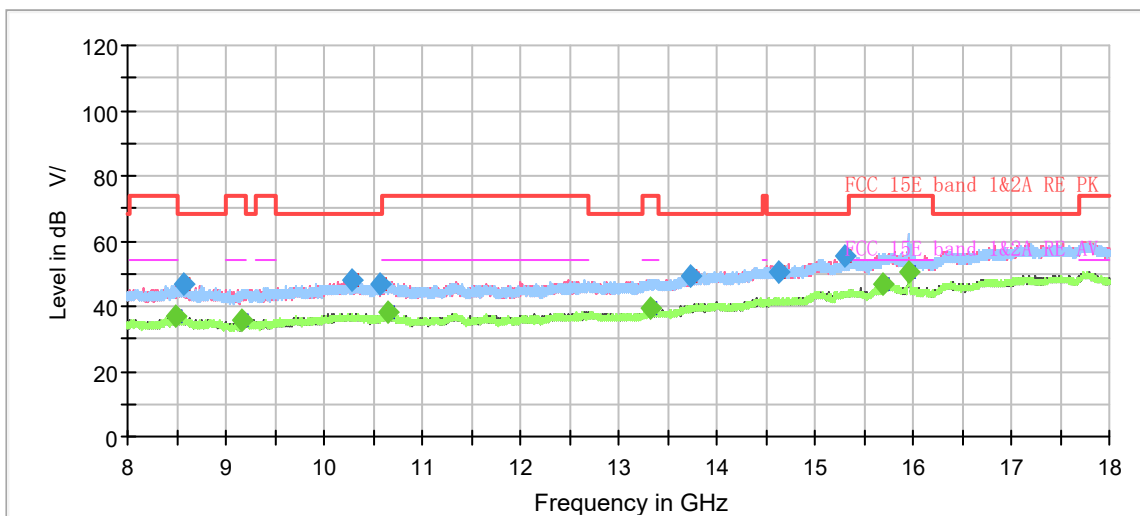

Radiates Emission from 8GHz to 18GHz



Frequency (MHz)	Peak (dBuV/m)	Average (dBuV/m)	Limit (dBuV/m)	Margin (dB)	Height (cm)	Polarization	Azimuth (deg)	Correct Factor (dB)
1242.666667	43.36	---	68.20	24.84	200.0	H	111.0	-7.1
1405.766667	---	33.28	54.00	20.72	100.0	H	75.0	-6.1
1598.733333	---	34.60	54.00	19.40	100.0	V	316.0	-5.1
1860.066667	45.59	---	68.20	22.61	200.0	V	227.0	-3.5
2661.566667	48.18	---	68.20	20.02	200.0	V	262.0	0.4
2804.833333	---	38.15	54.00	15.85	200.0	H	261.0	1.0
3468.900000	50.38	---	68.20	17.82	100.0	H	54.0	3.6
3998.566667	---	41.83	54.00	12.17	200.0	H	126.0	6.2
4462.900000	50.95	---	68.20	17.25	200.0	H	0.0	6.4
5350.033333	---	46.93	54.00	7.07	200.0	V	0.0	8.7
7466.133333	---	45.14	54.00	8.86	100.0	H	26.0	11.5
7953.100000	54.87	---	68.20	13.33	200.0	H	68.0	11.8

Remark: 1. Correction Factor = Antenna factor+ Insertion loss (cable loss + amplifier gain)

802.11a CH100

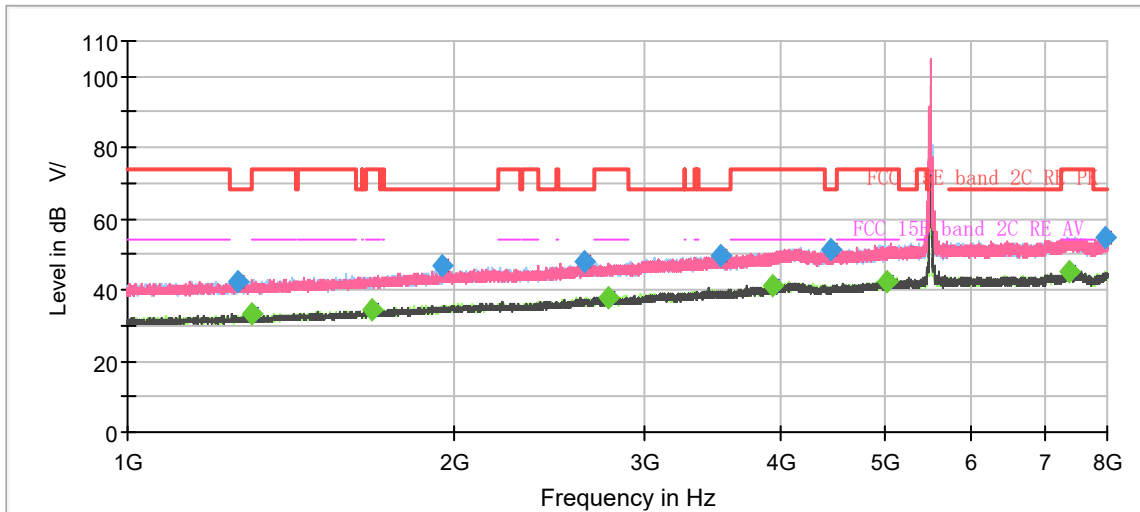

Note: The signal beyond the limit is carrier.
Radiates Emission from 1GHz to 8GHz

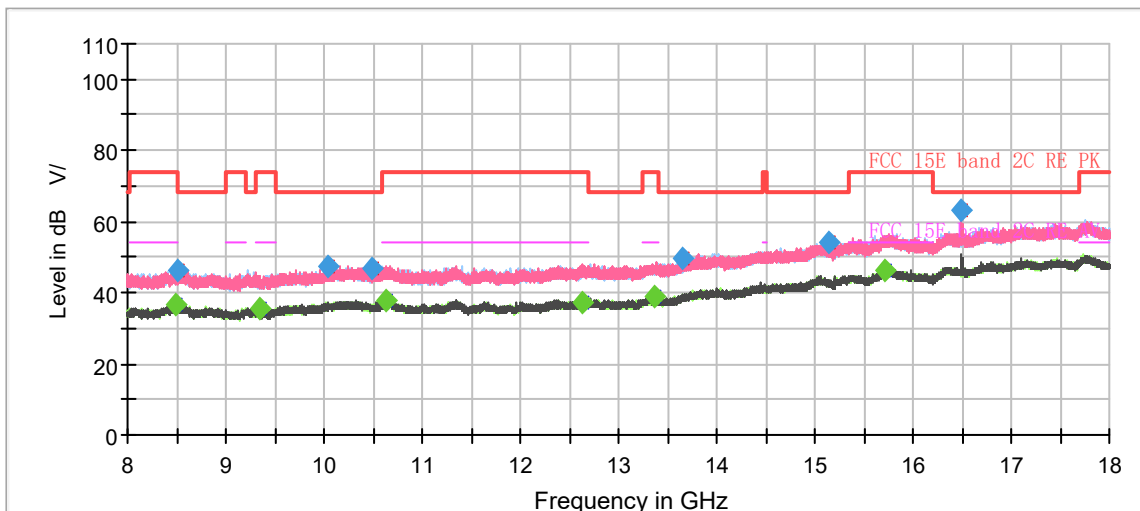

Radiates Emission from 8GHz to 18GHz



Frequency (MHz)	Peak (dBuV/m)	Average (dBuV/m)	Limit (dBuV/m)	Margin (dB)	Height (cm)	Polarization	Azimuth (deg)	Correct Factor (dB)
1261.100000	42.44	---	68.20	25.76	200.0	H	87.0	-6.9
1303.566667	---	33.12	54.00	20.88	100.0	V	227.0	-6.7
1680.633333	---	34.41	54.00	19.59	200.0	H	263.0	-4.6
1950.366667	46.65	---	68.20	21.55	200.0	H	60.0	-3.0
2635.666667	47.71	---	68.20	20.49	100.0	V	199.0	0.3
2771.000000	---	37.82	54.00	16.18	100.0	V	147.0	0.8
3518.133333	49.47	---	68.20	18.73	100.0	H	67.0	3.8
3930.666667	---	41.21	54.00	12.79	100.0	H	58.0	5.7
4454.033333	51.15	---	68.20	17.05	200.0	V	80.0	6.3
5015.900000	---	42.25	54.00	11.75	100.0	H	75.0	8.7
7376.533333	---	45.17	54.00	8.83	100.0	V	173.0	11.5
7979.000000	54.78	---	68.20	13.42	200.0	H	141.0	11.9

Remark: 1. Correction Factor = Antenna factor+ Insertion loss (cable loss + amplifier gain)

802.11a CH116

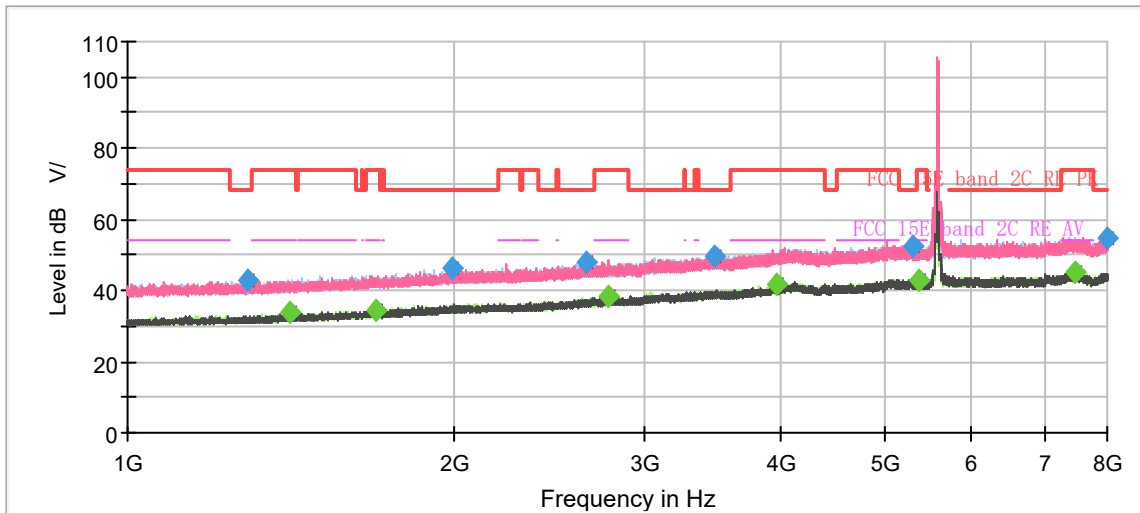

Note: The signal beyond the limit is carrier.
Radiates Emission from 1GHz to 8GHz

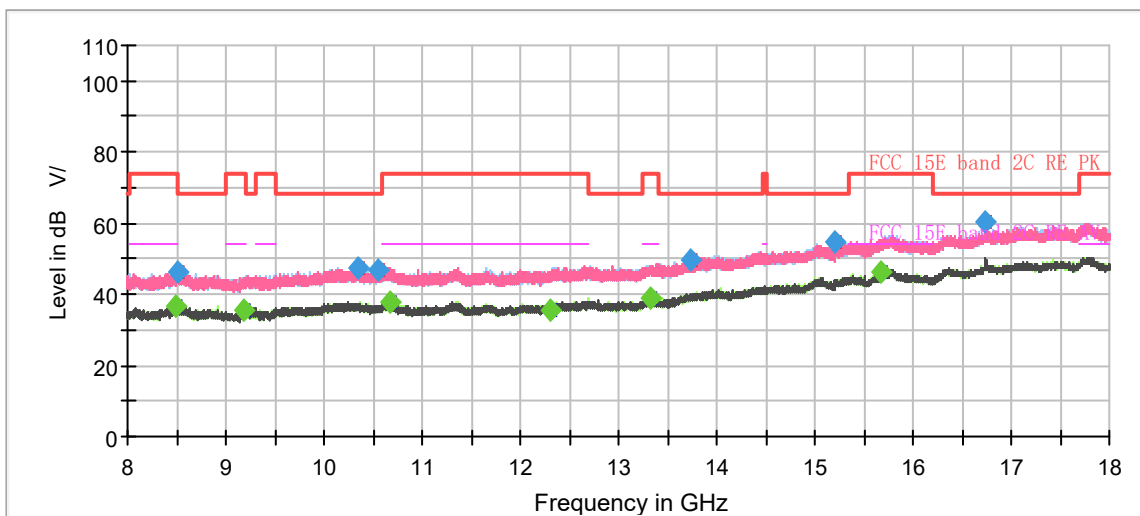

Radiates Emission from 8GHz to 18GHz



Frequency (MHz)	Peak (dBuV/m)	Average (dBuV/m)	Limit (dBuV/m)	Margin (dB)	Height (cm)	Polarization	Azimuth (deg)	Correct Factor (dB)
1292.133333	42.76	---	68.20	25.44	100.0	H	0.0	-6.8
1413.233333	---	33.60	54.00	20.40	200.0	H	140.0	-6.1
1692.300000	---	34.53	54.00	19.47	200.0	V	296.0	-4.5
1994.000000	46.33	---	68.20	21.87	200.0	H	202.0	-2.7
2643.600000	47.68	---	68.20	20.52	100.0	H	110.0	0.3
2775.433333	---	38.29	54.00	15.71	200.0	H	272.0	0.9
3470.300000	49.67	---	68.20	18.53	100.0	H	163.0	3.6
3957.733333	---	41.59	54.00	12.41	200.0	H	59.0	5.9
5285.400000	52.54	---	68.20	15.66	100.0	H	102.0	8.8
5359.833333	---	42.89	54.00	11.11	100.0	V	0.0	8.7
7465.200000	---	45.15	54.00	8.85	200.0	V	118.0	11.5
7990.666667	54.66	---	68.20	13.54	100.0	H	102.0	11.9

Remark: 1. Correction Factor = Antenna factor+ Insertion loss (cable loss + amplifier gain)

802.11a CH140

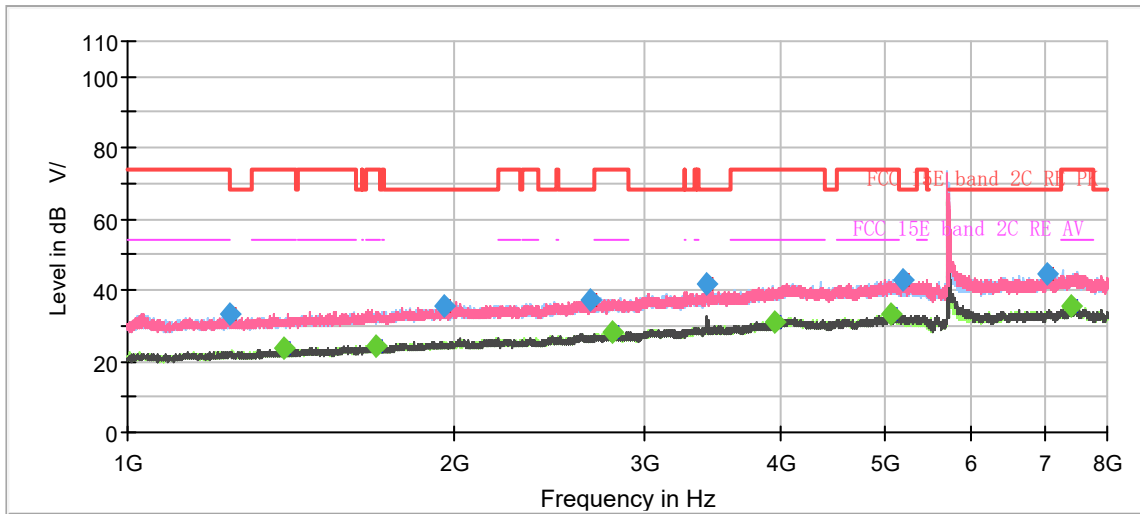

Note: The signal beyond the limit is carrier.
Radiates Emission from 1GHz to 8GHz

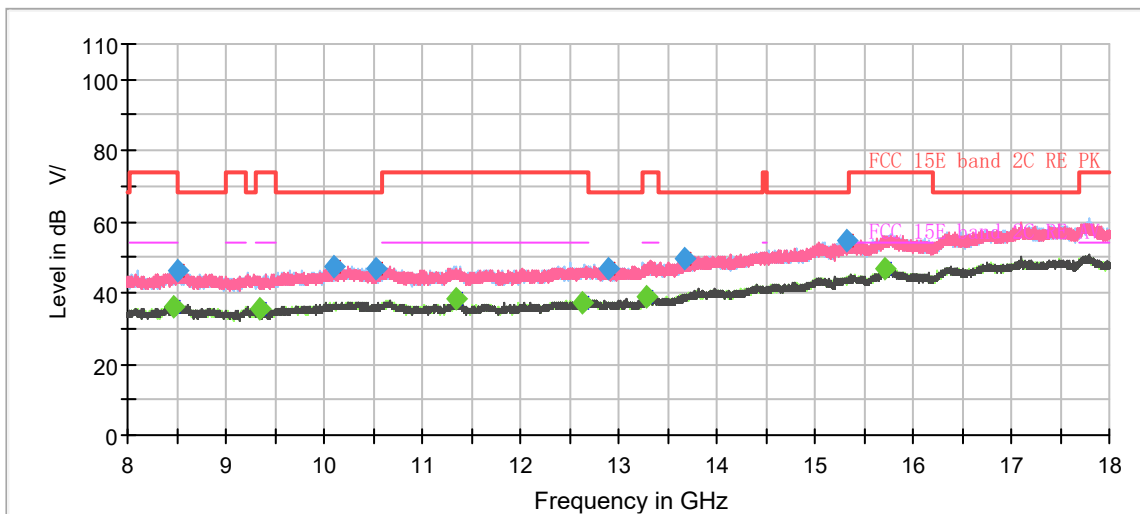

Radiates Emission from 8GHz to 18GHz



Frequency (MHz)	Peak (dBuV/m)	Average (dBuV/m)	Limit (dBuV/m)	Margin (dB)	Height (cm)	Polarization	Azimuth (deg)	Correct Factor (dB)
1244.300000	33.16	---	68.20	35.04	200.0	H	308.0	-17.0
1392.466667	---	23.58	54.00	30.42	100.0	V	78.0	-16.2
1693.000000	---	24.48	54.00	29.52	200.0	V	121.0	-14.5
1957.600000	35.50	---	68.20	32.70	200.0	V	164.0	-12.9
2675.100000	37.38	---	68.20	30.82	100.0	V	289.0	-9.5
2795.033333	---	28.10	54.00	25.90	200.0	V	0.0	-9.1
3419.666667	41.60	---	68.20	26.60	100.0	V	353.0	-6.5
3948.166667	---	31.13	54.00	22.87	200.0	H	42.0	-4.2
5060.233333	---	33.03	54.00	20.97	200.0	V	35.0	-1.3
5183.900000	43.03	---	68.20	25.17	200.0	V	181.0	-1.3
7049.633333	44.38	---	68.20	23.82	100.0	V	281.0	0.9
7418.066667	---	35.26	54.00	18.74	200.0	H	88.0	1.5

Remark: 1. Correction Factor = Antenna factor+ Insertion loss (cable loss + amplifier gain)

802.11a CH149

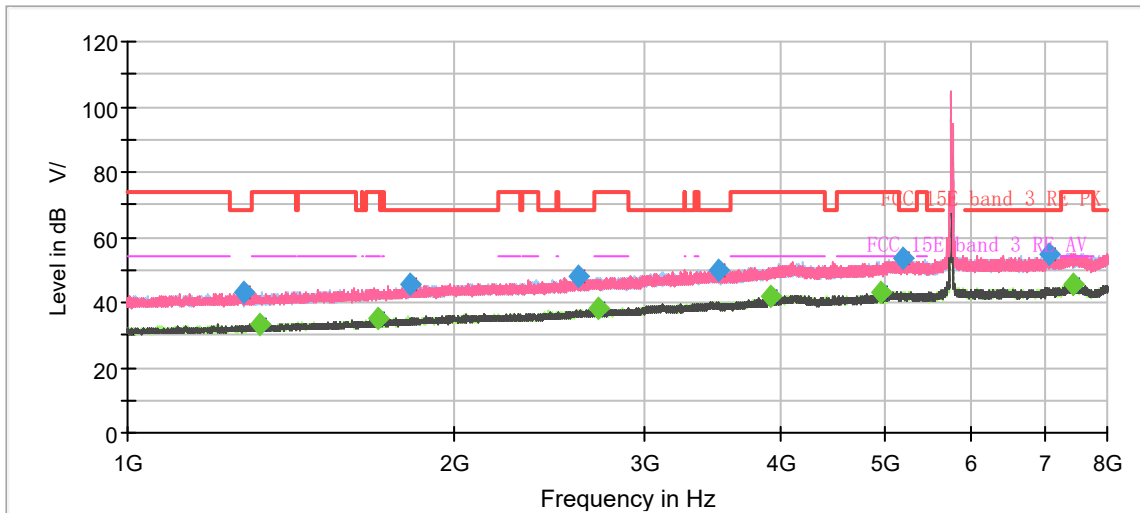

Note: The signal beyond the limit is carrier.
Radiates Emission from 1GHz to 8GHz

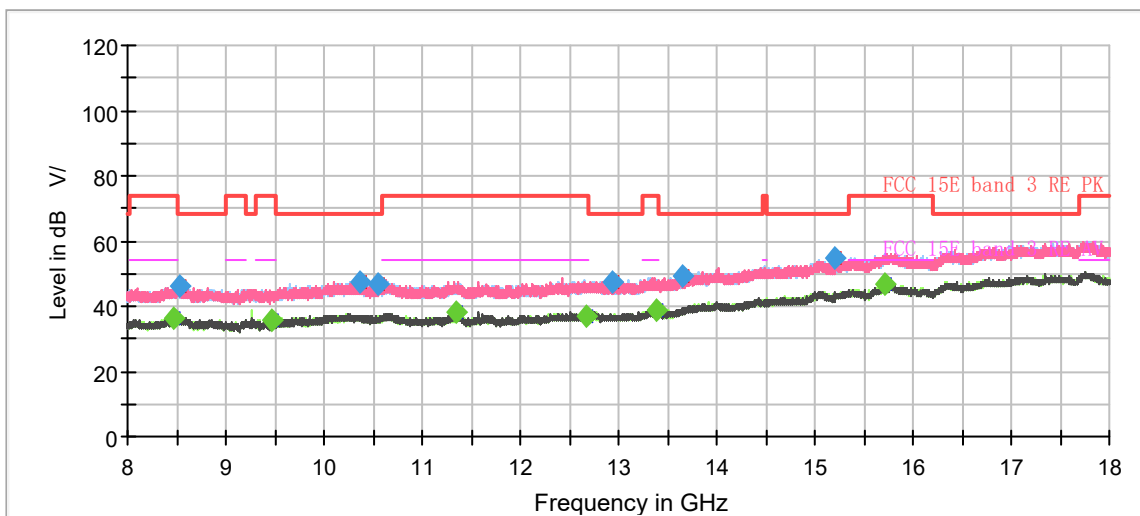

Radiates Emission from 8GHz to 18GHz



Frequency (MHz)	Peak (dBuV/m)	Average (dBuV/m)	Limit (dBuV/m)	Margin (dB)	Height (cm)	Polarization	Azimuth (deg)	Correct Factor (dB)
1282.333333	43.00	---	68.20	25.20	100.0	V	85.0	-6.8
1326.666667	---	33.32	54.00	20.68	200.0	V	15.0	-6.6
1703.266667	---	34.90	54.00	19.10	100.0	V	41.0	-4.5
1821.100000	45.60	---	68.20	22.60	100.0	H	115.0	-3.7
2605.333333	47.85	---	68.20	20.35	100.0	V	1.0	0.1
2718.733333	---	38.05	54.00	15.95	100.0	V	165.0	0.6
3503.433333	50.14	---	68.20	18.06	200.0	H	184.0	3.7
3920.400000	---	41.71	54.00	12.29	100.0	V	183.0	5.6
4943.566667	---	43.20	54.00	10.80	200.0	H	176.0	8.3
5177.833333	53.51	---	68.20	14.69	100.0	V	209.0	8.7
7067.833333	54.77	---	68.20	13.43	200.0	V	129.0	10.9
7452.133333	---	45.38	54.00	8.62	100.0	V	0.0	11.5

Remark: 1. Correction Factor = Antenna factor+ Insertion loss (cable loss + amplifier gain)

802.11a CH157

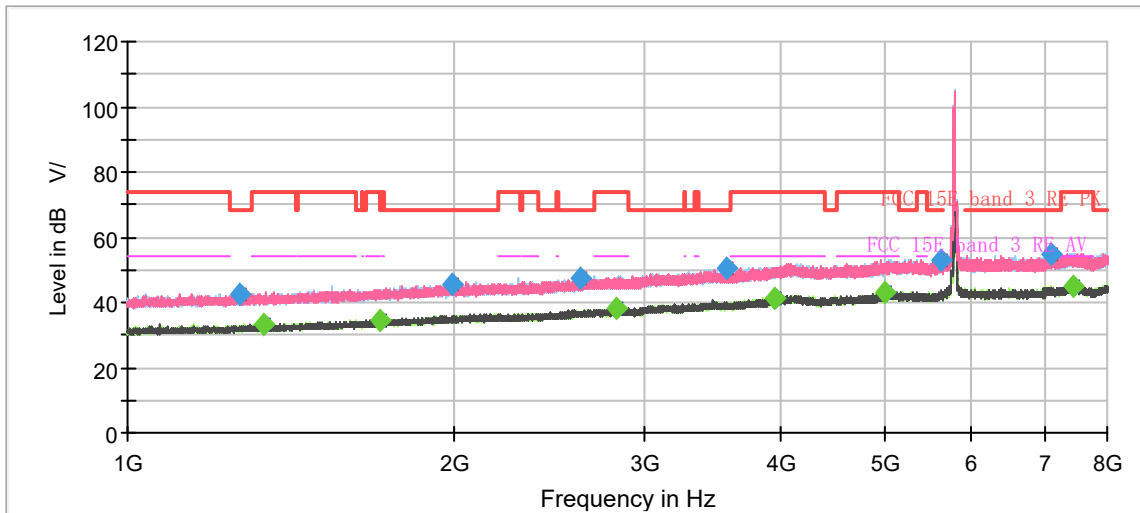

Note: The signal beyond the limit is carrier.
Radiates Emission from 1GHz to 8GHz

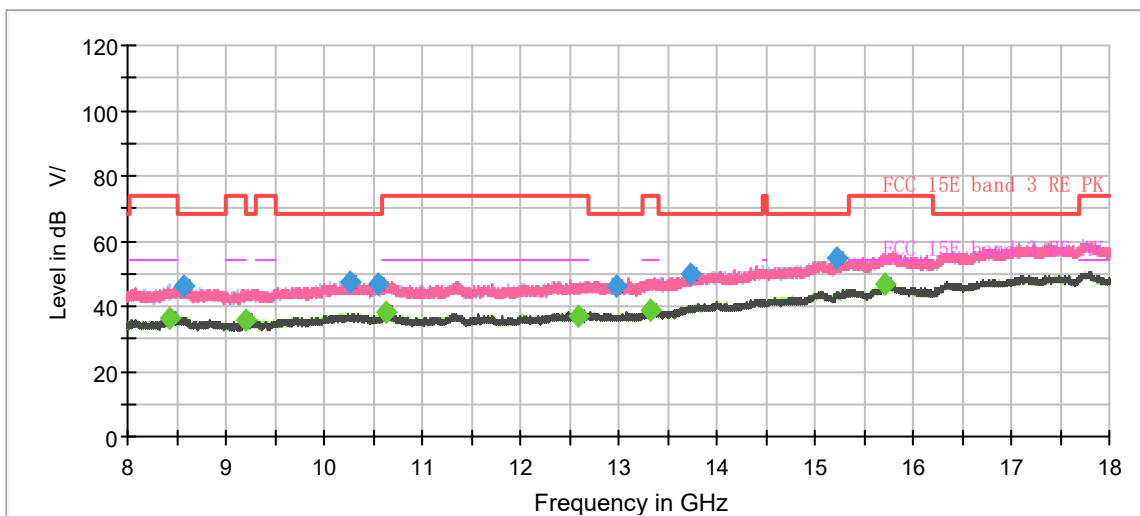

Radiates Emission from 8GHz to 18GHz



Frequency (MHz)	Peak (dBuV/m)	Average (dBuV/m)	Limit (dBuV/m)	Margin (dB)	Height (cm)	Polarization	Azimuth (deg)	Correct Factor (dB)
1266.233333	42.76	---	68.20	25.44	100.0	H	254.0	-6.9
1334.600000	---	33.21	54.00	20.79	200.0	V	91.0	-6.6
1706.066667	---	34.70	54.00	19.30	200.0	V	186.0	-4.5
1991.900000	45.41	---	68.20	22.79	100.0	V	205.0	-2.7
2609.300000	47.67	---	68.20	20.53	200.0	H	161.0	0.1
2818.600000	---	38.19	54.00	15.81	200.0	H	107.0	1.0
3559.200000	50.53	---	68.20	17.67	200.0	H	178.0	3.9
3954.233333	---	41.42	54.00	12.58	100.0	V	255.0	5.8
4997.233333	---	43.26	54.00	10.74	200.0	H	282.0	8.7
5628.400000	53.16	---	68.20	15.04	200.0	H	152.0	9.1
7101.200000	55.00	---	68.20	13.20	200.0	V	271.0	11.0
7428.800000	---	45.19	54.00	8.81	100.0	V	264.0	11.5

Remark: 1. Correction Factor = Antenna factor+ Insertion loss (cable loss + amplifier gain)

802.11a CH165

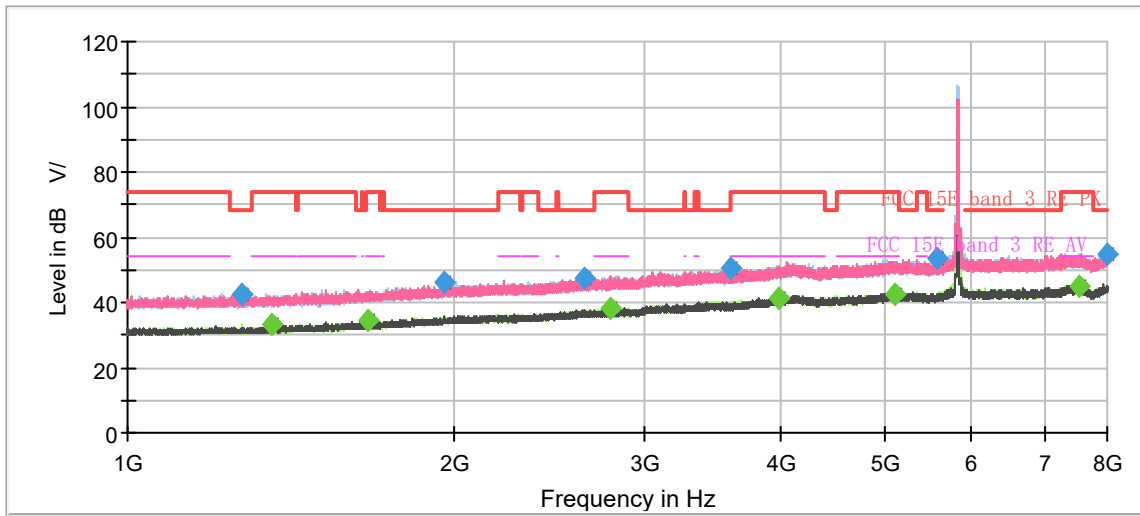

Note: The signal beyond the limit is carrier.
Radiates Emission from 1GHz to 8GHz

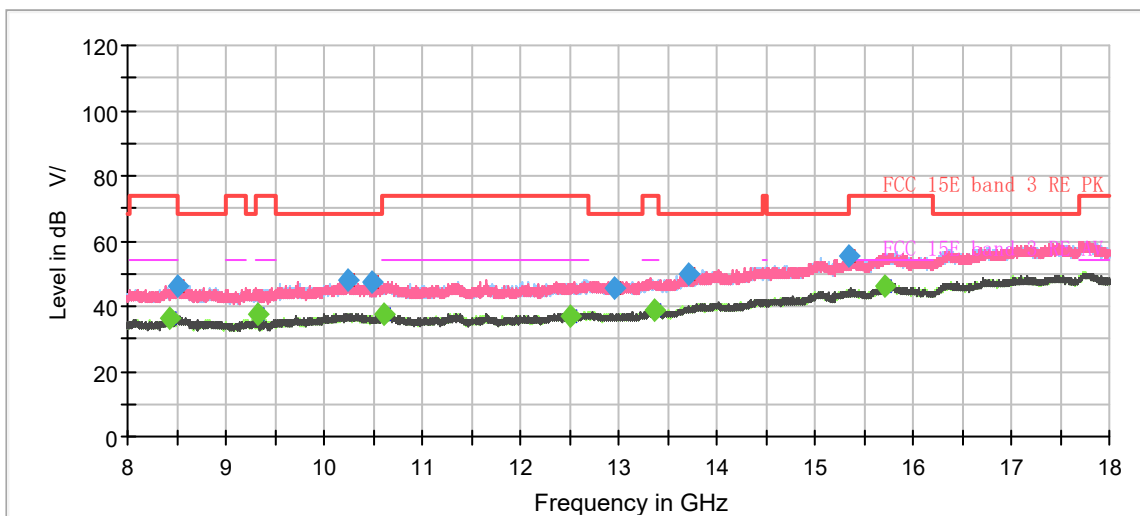

Radiates Emission from 8GHz to 18GHz



Frequency (MHz)	Peak (dBuV/m)	Average (dBuV/m)	Limit (dBuV/m)	Margin (dB)	Height (cm)	Polarization	Azimuth (deg)	Correct Factor (dB)
1275.100000	42.71	---	68.20	25.49	200.0	V	12.0	-6.9
1356.533333	---	33.25	54.00	20.75	200.0	V	21.0	-6.5
1664.766667	---	34.25	54.00	19.75	200.0	V	55.0	-4.7
1958.766667	46.21	---	68.20	21.99	100.0	V	231.0	-2.9
2641.500000	47.11	---	68.20	21.09	100.0	H	300.0	0.3
2790.366667	---	38.21	54.00	15.79	100.0	V	350.0	0.9
3596.533333	50.56	---	68.20	17.64	100.0	H	73.0	4.0
3985.966667	---	41.47	54.00	12.53	200.0	H	297.0	6.1
5088.933333	---	42.77	54.00	11.23	100.0	H	134.0	8.7
5573.566667	53.35	---	68.20	14.85	100.0	V	93.0	8.9
7542.433333	---	45.18	54.00	8.82	100.0	V	333.0	11.5
7991.133333	55.04	---	68.20	13.16	100.0	H	30.0	11.9

Remark: 1. Correction Factor = Antenna factor+ Insertion loss (cable loss + amplifier gain)

802.11n (HT20) CH36

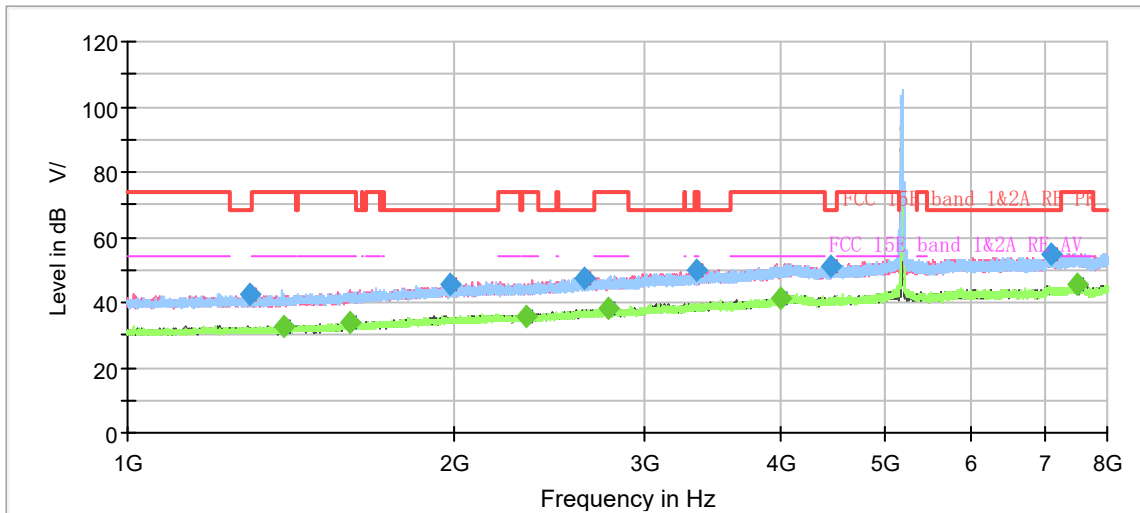

Note: The signal beyond the limit is carrier.
Radiates Emission from 1GHz to 8GHz

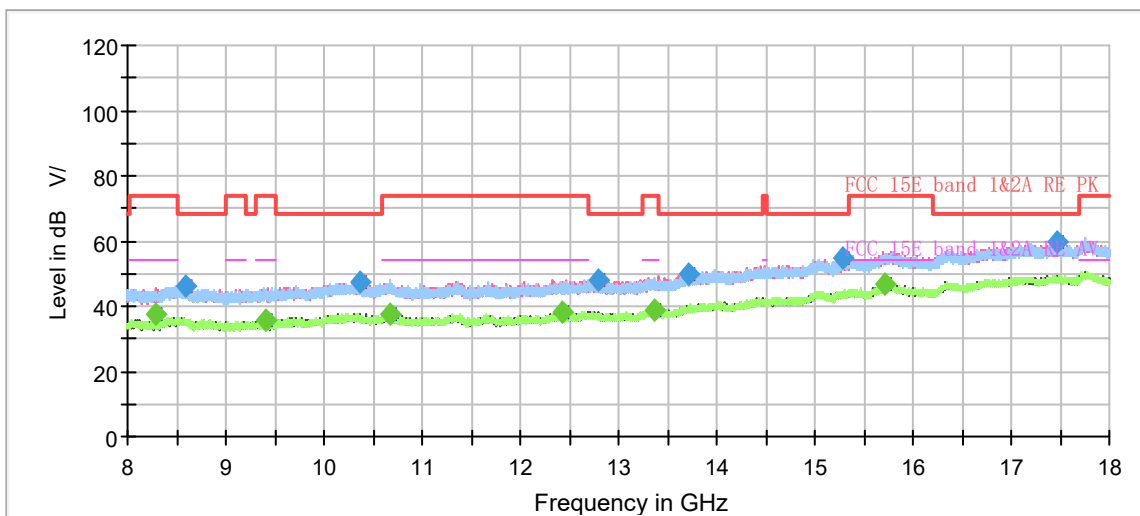

Radiates Emission from 8GHz to 18GHz



Frequency (MHz)	Peak (dBuV/m)	Average (dBuV/m)	Limit (dBuV/m)	Margin (dB)	Height (cm)	Polarization	Azimuth (deg)	Correct Factor (dB)
1293.533333	42.22	---	68.20	25.98	100.0	H	140.0	-6.8
1392.000000	---	32.74	54.00	21.26	100.0	H	284.0	-6.2
1601.300000	---	34.10	54.00	19.90	100.0	H	353.0	-5.0
1981.633333	45.47	---	68.20	22.73	100.0	V	359.0	-2.8
2330.000000	---	35.96	54.00	18.04	100.0	V	156.0	-1.4
2637.533333	47.25	---	68.20	20.95	100.0	V	0.0	0.3
2769.366667	---	37.96	54.00	16.04	200.0	V	0.0	0.8
3341.733333	49.70	---	68.20	18.50	200.0	H	207.0	3.2
3999.500000	---	41.47	54.00	12.53	100.0	V	38.0	6.2
4444.700000	50.95	---	68.20	17.25	200.0	V	166.0	6.3
7108.900000	54.96	---	68.20	13.24	100.0	V	58.0	11.0
7499.733333	---	45.45	54.00	8.55	100.0	V	291.0	11.5

Remark: 1. Correction Factor = Antenna factor+ Insertion loss (cable loss + amplifier gain)

802.11n (HT20) CH40

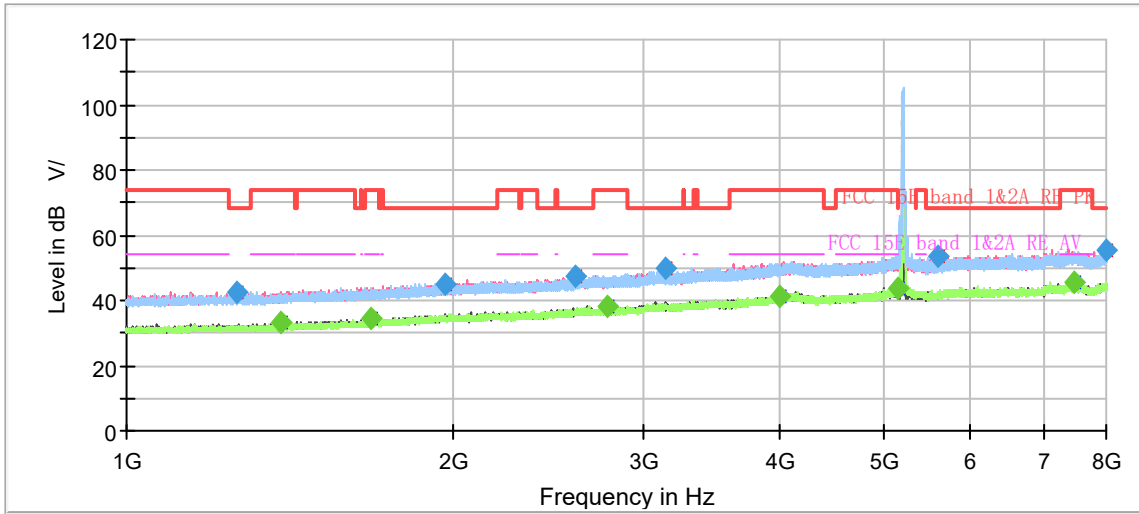

Note: The signal beyond the limit is carrier.
Radiates Emission from 1GHz to 8GHz

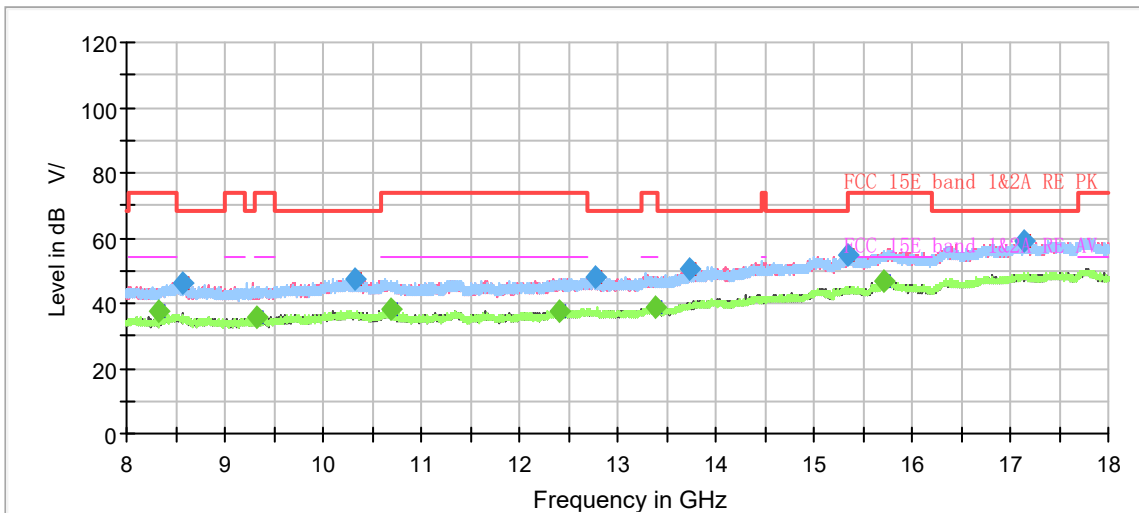

Radiates Emission from 8GHz to 18GHz