

# FCC SAR Test Report

**APPLICANT** : Xiaomi Communications Co., Ltd.  
**EQUIPMENT** : Mobile Phone  
**BRAND NAME** : MI  
**MODEL NAME** : M1903F10G  
**FCC ID** : 2AFZZ-XMSF10G  
**STANDARD** : FCC 47 CFR Part 2 (2.1093)  
ANSI/IEEE C95.1-1992  
IEEE 1528-2013

The product was received on Jun. 11, 2019 and testing was started from Jun. 19, 2019 and completed on Jun. 22, 2019. We, Sporton International (Kunshan) Inc., would like to declare that the tested sample has been evaluated in accordance with the procedures and had been in compliance with the applicable technical standards.

The test results in this report apply exclusively to the tested model / sample. Without written approval of Sporton International (Kunshan) Inc., the test report shall not be reproduced except in full.

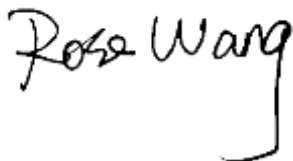

Reviewed by: Rose Wang / Supervisor

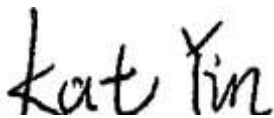

Approved by: Kat Yin / Manager



**Sporton International (Kunshan) Inc.**

**No. 1098, Pengxi North Road, Kunshan Economic Development Zone Jiangsu Province 215300  
People's Republic of China**



Table of Contents

1. Statement of Compliance ..... 4
2. Administration Data ..... 5
3. Guidance Applied..... 5
4. Equipment Under Test (EUT) Information..... 6
4.1 General Information ..... 6
4.2 General LTE SAR Test and Reporting Considerations ..... 8
5. Proximity Sensor Triggering Test.....10
5.1 Proximity sensor triggering distances(Per KDB616217§6.2) .....10
5.2 Tilt angle influences to proximity sensor triggering(Per KDB616217 §6.4).....14
6. RF Exposure Limits.....15
6.1 Uncontrolled Environment.....15
6.2 Controlled Environment.....15
7. Specific Absorption Rate (SAR).....16
7.1 Introduction .....16
7.2 SAR Definition.....16
8. System Description and Setup .....17
8.1 E-Field Probe .....18
8.2 Data Acquisition Electronics (DAE) .....18
8.3 Phantom.....19
8.4 Device Holder.....20
9. Measurement Procedures .....21
9.1 Spatial Peak SAR Evaluation .....21
9.2 Power Reference Measurement.....22
9.3 Area Scan .....22
9.4 Zoom Scan.....23
9.5 Volume Scan Procedures.....23
9.6 Power Drift Monitoring.....23
10. Test Equipment List.....24
11. System Verification .....25
11.1 Tissue Simulating Liquids .....25
11.2 Tissue Verification .....26
11.3 System Performance Check Results .....27
12. RF Exposure Positions .....28
12.1 Ear and handset reference point .....28
12.2 Definition of the cheek position .....29
12.3 Definition of the tilt position .....30
12.4 Body Worn Accessory .....31
12.5 Product Specific 10g SAR Exposure.....32
12.6 Wireless Router.....32
13. SAR Test Results .....33
13.1 Head SAR .....34
13.2 Hotspot SAR .....36
13.3 Body Worn Accessory SAR.....38
13.4 Product specific 10g SAR .....39
13.5 Repeated SAR Measurement .....40
14. Simultaneous Transmission Analysis.....41
14.1 Head Exposure Conditions .....42
14.2 Hotspot Exposure Conditions.....44
14.3 Body-Worn Accessory Exposure Conditions .....46
14.4 Product specific 10g SAR Exposure Conditions.....47
15. Uncertainty Assessment .....48
16. References.....49
Appendix A. Plots of System Performance Check
Appendix B. Plots of High SAR Measurement
Appendix C. DASY Calibration Certificate
Appendix D. Test Setup Photos





### 1. Statement of Compliance

The maximum results of Specific Absorption Rate (SAR) found during testing for **Xiaomi Communications Co., Ltd., Mobile Phone, M1903F10G**, are as follows.

Highest 1g SAR Summary						
Equipment Class	Frequency Band		Head (Separation 0mm)	Hotspot (Separation 10mm)	Body-worn (Separation 15mm)	Highest Simultaneous Transmission 1g SAR (W/kg)
			1g SAR (W/kg)			
Licensed	GSM	GSM850	0.77	0.36	0.26	1.53
		GSM1900	0.98	0.98	0.27	
	WCDMA	Band V	0.96	0.52	0.31	
		Band IV	1.08	0.91	<b>0.87</b>	
		Band II	1.03	0.74	0.75	
	LTE	Band 5	1.05	0.44	0.33	
		Band 4	0.96	1.01	0.65	
		Band 2	1.01	0.93	0.56	
		Band 7	<b>1.18</b>	0.89	0.35	
		Band 38	0.94	<b>1.11</b>	0.24	
DTS	WLAN	2.4GHz WLAN	0.63	0.25	0.18	1.52
NII		5GHz WLAN	1.00	0.70	0.83	1.53
DSS	Bluetooth	2.4GHz Bluetooth	0.15	<0.10	<0.10	1.53
Highest 10g SAR Summary						
Equipment Class	Frequency Band		Product Specific 10g SAR (W/kg) (Separation 0mm)		Highest Simultaneous Transmission 10g SAR (W/kg)	
Licensed	GSM	GSM1900	1.86		3.29	
	WCDMA	Band IV	3.11			
		Band II	<b>3.29</b>			
	LTE	Band 4	2.64			
		Band 2	2.88			
NII	WLAN	5GHz WLAN	1.81			
Date of Testing:				2019/6/19~2019/6/22		

This device is in compliance with Specific Absorption Rate (SAR) for general population/uncontrolled exposure limits (1.6 W/kg for Partial-Body 1g SAR, 4.0 W/kg for Product Specific 10g SAR) specified in FCC 47 CFR part 2 (2.1093) and ANSI/IEEE C95.1-1992, and had been tested in accordance with the measurement methods and procedures specified in IEEE 1528-2013 and FCC KDB publications.



## 2. Administration Data

Sporton International (Kunshan) Inc. is accredited to ISO/IEC 17025:2017 by American Association for Laboratory Accreditation with Certificate Number 5145.02.

Testing Laboratory		
Test Firm	Sporton International (Kunshan) Inc.	
Test Site Location	No. 1098, Pengxi North Road, Kunshan Economic Development Zone Jiangsu Province 215300 People's Republic of China TEL : +86-512-57900158 FAX : +86-512-57900958	
Test Site No.	FCC Designation No.	FCC Test Firm Registration No.
	CN1257	314309

Applicant	
Company Name	Xiaomi Communications Co., Ltd.
Address	The Rainbow City of China Resources, NO.68, Qinghe Middle Street, Haidian District, Beijing, China

## 3. Guidance Applied

The Specific Absorption Rate (SAR) testing specification, method, and procedure for this device is in accordance with the following standards:

- FCC 47 CFR Part 2 (2.1093)
- ANSI/IEEE C95.1-1992
- IEEE 1528-2013
- FCC KDB 865664 D01 SAR Measurement 100 MHz to 6 GHz v01r04
- FCC KDB 865664 D02 SAR Reporting v01r02
- FCC KDB 447498 D01 General RF Exposure Guidance v06
- FCC KDB 648474 D04 SAR Evaluation Considerations for Wireless Handsets v01r03
- FCC KDB 248227 D01 802.11 Wi-Fi SAR v02r02
- FCC KDB 941225 D01 3G SAR Procedures v03r01
- FCC KDB 941225 D05 SAR for LTE Devices v02r05
- FCC KDB 941225 D05A Rel.10 LTE SAR Test Guidance v01r02
- FCC KDB 941225 D06 Hotspot Mode SAR v02r01
- FCC KDB 616217 D04 SAR for laptop and tablets v01r02



**4. Equipment Under Test (EUT) Information**

**4.1 General Information**

Product Feature & Specification	
Equipment Name	Mobile Phone
Brand Name	MI
Model Name	M1903F10G
FCC ID	2AFZZ-XMSF10G
IMEI Code	SIM1: 866962040433736 SIM2: 866962040433744
Wireless Technology and Frequency Range	GSM850: 824.2 MHz ~ 848.8 MHz GSM1900: 1850.2 MHz ~ 1909.8 MHz WCDMA Band II: 1852.4 MHz ~ 1907.6 MHz WCDMA Band IV: 1712.4 MHz ~ 1752.6 MHz WCDMA Band V: 826.4 MHz ~ 846.6 MHz LTE Band 2: 1850.7 MHz ~ 1909.3 MHz LTE Band 4: 1710.7 MHz ~ 1754.3 MHz LTE Band 5: 824.7 MHz ~ 848.3 MHz LTE Band 7: 2502.5 MHz ~ 2567.5 MHz LTE Band 38: 2572.5 MHz ~ 2617.5 MHz WLAN 2.4GHz Band: 2412 MHz ~ 2462 MHz WLAN 5.2GHz Band: 5180 MHz ~ 5240 MHz WLAN 5.3GHz Band: 5260 MHz ~ 5320 MHz WLAN 5.5GHz Band: 5500 MHz ~ 5700 MHz WLAN 5.8GHz Band: 5745 MHz ~ 5805 MHz Bluetooth: 2402 MHz ~ 2480 MHz NFC : 13.56 MHz
Mode	GSM/GPRS/EGPRS RMC/AMR 12.2Kbps HSDPA HSUPA DC-HSDPA HSPA+: 16QAM (uplink is not supported) LTE: QPSK, 16QAM, 64QAM, 256QAM (Downlink Only) WLAN 2.4GHz 802.11b/g/n HT20 WLAN 5GHz 802.11a/n HT20/HT40 WLAN 5GHz 802.11ac VHT20/VHT40/VHT80 Bluetooth BR/EDR/LE NFC
HW Version	P2
SW Version	MIUI 10
GSM / (E)GPRS Transfer mode	Class B – EUT cannot support Packet Switched and Circuit Switched Network simultaneously but can automatically switch between Packet and Circuit Switched Network.
EUT Stage	Identical Prototype



**Remark:**

1. This device supports VoIP in GPRS, EGPRS, CDMA, WCDMA and LTE (e.g. for 3rd-party VoIP), LTE supports VoLTE operation.
2. This device 2.4GHz WLAN support hotspot operation and Bluetooth support tethering applications.
3. This device 2.4GHz WLAN/5.2GHz WLAN/5.8GHz WLAN support hotspot operation, and 5.2GHz WLAN/5.8GHz WLAN supports WiFi Direct (GC/GO), and 5.3GHz / 5.5GHz supports WiFi Direct (GC only).
4. This device does not support DTM operation and supports GRPS/EGPRS mode up to multi-slot class 33.
5. This device has two WWAN transmit antennas. WWAN bottom antenna is located at the bottom edge of the device, and WWAN top antenna is located at the top edge of the device which can refer to antenna location chapter. Top and Bottom antenna support the same WWAN frequency bands, and they can't transmit simultaneously.
6. For top WWAN antenna and WLAN antenna:
  - a. When the phone is in talking mode and receiver worked, then power reduction will be implemented immediately in GSM850, WCDMA band 2/4/5, LTE B2/4/5/7/38 and WLAN 2.4GHz/5.2/5.3/5.8GHz.
  - b. When hotspot mode is enabled, power reduction will be activated to GSM850, WCDMA band 2/4/5, LTE B2/4/5/7/38 and WLAN 2.4GHz/5.2/5.8GHz.
7. For bottom WWAN antenna:
  - a. P-sensor can detect handheld state, WCDMA band II/IV and LTE band 2/4/7 for front/back/bottom sides of product specific 10g SAR condition reduced powers will be active
  - b. When hotspot mode is enabled, power reduction will be activated to GSM1900, WCDMA band II/IV, LTE band 2/4/7.
8. There are two types of EUT sample 1 and sample 2, the differences between two samples is for memory, sample 1 6+64GB capacity and sample 2 is 6+128GB capacity. According to the difference, memory capacity has no effect on SAR distribution, so sample 1 is chose to perform full SAR testing.
9. For dual SIM card mobile has two SIM slots and supports dual SIM dual standby. The WWAN radio transmission will be enabled by either one SIM at a time (single active). After pre-scan two SIM cards power, we found test result of the SIM1 was the worse, so we chose SIM1 slot to perform all tests.
10. The device distinguishes different countries by MCC information. If we are close to a country border and the phone switches to a neighboring network the power reduction will follow the newest registered MCC information. The default status when the device doesn't know the MCC information will be set to the Lower Power Level between A and B, the detail information can refer to operation description. This mechanism limited to WLAN only.
11. This is a variant report for M1903F10G, the change note could be referred to the product equality declaration which is exhibit separately. Based on the similarity between two models, only the worst case from original test report (Sporton Report Number FA931204) were verified for the differences.



**4.2 General LTE SAR Test and Reporting Considerations**

Summarized necessary items addressed in KDB 941225 D05 v02r05																																																							
FCC ID	2AFZZ-XMSF10G																																																						
Equipment Name	Mobile Phone																																																						
Operating Frequency Range of each LTE transmission band	LTE Band 2: 1850.7 MHz ~ 1909.3 MHz LTE Band 4: 1710.7 MHz ~ 1754.3 MHz LTE Band 5: 824.7 MHz ~ 848.3 MHz LTE Band 7: 2502.5 MHz ~ 2567.5 MHz LTE Band 38: 2572.5 MHz ~ 2617.5 MHz																																																						
Channel Bandwidth	LTE Band 2: 1.4MHz, 3MHz, 5MHz, 10MHz, 15MHz, 20MHz LTE Band 4: 1.4MHz, 3MHz, 5MHz, 10MHz, 15MHz, 20MHz LTE Band 5: 1.4MHz, 3MHz, 5MHz, 10MHz LTE Band 7: 5MHz, 10MHz, 15MHz, 20MHz LTE Band 38: 5MHz, 10MHz, 15MHz, 20MHz																																																						
uplink modulations used	QPSK / 16QAM / 64QAM /256QAM (Downlink Only)																																																						
LTE Voice / Data requirements	Voice and Data																																																						
LTE Release Version	R12, Cat13																																																						
CA Support	Yes, Uplink and Downlink																																																						
LTE MPR permanently built-in by design	<p align="center"><b>Table 6.2.3-1: Maximum Power Reduction (MPR) for Power Class 1, 2 and 3</b></p> <table border="1"> <thead> <tr> <th rowspan="2">Modulation</th> <th colspan="6">Channel bandwidth / Transmission bandwidth (N<sub>RB</sub>)</th> <th rowspan="2">MPR (dB)</th> </tr> <tr> <th>1.4 MHz</th> <th>3.0 MHz</th> <th>5 MHz</th> <th>10 MHz</th> <th>15 MHz</th> <th>20 MHz</th> </tr> </thead> <tbody> <tr> <td>QPSK</td> <td>&gt; 5</td> <td>&gt; 4</td> <td>&gt; 8</td> <td>&gt; 12</td> <td>&gt; 16</td> <td>&gt; 18</td> <td>≤ 1</td> </tr> <tr> <td>16 QAM</td> <td>≤ 5</td> <td>≤ 4</td> <td>≤ 8</td> <td>≤ 12</td> <td>≤ 16</td> <td>≤ 18</td> <td>≤ 1</td> </tr> <tr> <td>64 QAM</td> <td>&gt; 5</td> <td>&gt; 4</td> <td>&gt; 8</td> <td>&gt; 12</td> <td>&gt; 16</td> <td>&gt; 18</td> <td>≤ 2</td> </tr> <tr> <td>256 QAM</td> <td>&gt; 5</td> <td>&gt; 4</td> <td>&gt; 8</td> <td>&gt; 12</td> <td>&gt; 16</td> <td>&gt; 18</td> <td>≤ 3</td> </tr> <tr> <td></td> <td></td> <td></td> <td></td> <td>≥ 1</td> <td></td> <td></td> <td>≤ 5</td> </tr> </tbody> </table>	Modulation	Channel bandwidth / Transmission bandwidth (N <sub>RB</sub> )						MPR (dB)	1.4 MHz	3.0 MHz	5 MHz	10 MHz	15 MHz	20 MHz	QPSK	> 5	> 4	> 8	> 12	> 16	> 18	≤ 1	16 QAM	≤ 5	≤ 4	≤ 8	≤ 12	≤ 16	≤ 18	≤ 1	64 QAM	> 5	> 4	> 8	> 12	> 16	> 18	≤ 2	256 QAM	> 5	> 4	> 8	> 12	> 16	> 18	≤ 3					≥ 1			≤ 5
Modulation	Channel bandwidth / Transmission bandwidth (N <sub>RB</sub> )						MPR (dB)																																																
	1.4 MHz	3.0 MHz	5 MHz	10 MHz	15 MHz	20 MHz																																																	
QPSK	> 5	> 4	> 8	> 12	> 16	> 18	≤ 1																																																
16 QAM	≤ 5	≤ 4	≤ 8	≤ 12	≤ 16	≤ 18	≤ 1																																																
64 QAM	> 5	> 4	> 8	> 12	> 16	> 18	≤ 2																																																
256 QAM	> 5	> 4	> 8	> 12	> 16	> 18	≤ 3																																																
				≥ 1			≤ 5																																																
LTE A-MPR	In the base station simulator configuration, Network Setting value is set to NS_01 to disable A-MPR during SAR testing and the LTE SAR tests was transmitting on all TTI frames (Maximum TTI)																																																						
Spectrum plots for RB configuration	A properly configured base station simulator was used for the SAR and power measurement; therefore, spectrum plots for each RB allocation and offset configuration are not included in the SAR report.																																																						
Power reduction applied to satisfy SAR compliance	Yes, the detail please referred to original report (Sporton Report Number FA931204)																																																						
LTE Carrier Aggregation Combinations	Intra-Band and Inter-Band possible combinations and the detail power verification please referred to original report (Sporton Report Number FA931204)																																																						
LTE Carrier Aggregation Additional Information	<p>(1) This device supports LTE Carrier Aggregation (CA) in the uplink for LTE 7C /38C with two component carriers in the uplink. SAR Measurements and conducted powers were evaluated per FCC Guidance.</p> <p>(2) This device supports maximum of 2 carriers in the downlink and 2 carriers in the uplink. Additional following LTE Release features are not supported: Relay, HetNet, Enhanced MIMO, eICI, WiFi Offloading, MDH, eMBMA, Cross-Carrier Scheduling, Enhanced SC-FDMA.</p>																																																						





Transmission (H, M, L) channel numbers and frequencies in each LTE band												
LTE Band 2												
	Bandwidth 1.4 MHz		Bandwidth 3 MHz		Bandwidth 5 MHz		Bandwidth 10 MHz		Bandwidth 15 MHz		Bandwidth 20 MHz	
	Ch. #	Freq. (MHz)	Ch. #	Freq. (MHz)	Ch. #	Freq. (MHz)	Ch. #	Freq. (MHz)	Ch. #	Freq. (MHz)	Ch. #	Freq. (MHz)
L	18607	1850.7	18615	1851.5	18625	1852.5	18650	1855	18675	1857.5	18700	1860
M	18900	1880	18900	1880	18900	1880	18900	1880	18900	1880	18900	1880
H	19193	1909.3	19185	1908.5	19175	1907.5	19150	1905	19125	1902.5	19100	1900
LTE Band 4												
	Bandwidth 1.4 MHz		Bandwidth 3 MHz		Bandwidth 5 MHz		Bandwidth 10 MHz		Bandwidth 15 MHz		Bandwidth 20 MHz	
	Ch. #	Freq. (MHz)	Ch. #	Freq. (MHz)	Ch. #	Freq. (MHz)	Ch. #	Freq. (MHz)	Ch. #	Freq. (MHz)	Ch. #	Freq. (MHz)
L	19957	1710.7	19965	1711.5	19975	1712.5	20000	1715	20025	1717.5	20050	1720
M	20175	1732.5	20175	1732.5	20175	1732.5	20175	1732.5	20175	1732.5	20175	1732.5
H	20393	1754.3	20385	1753.5	20375	1752.5	20350	1750	20325	1747.5	20300	1745
LTE Band 5												
	Bandwidth 1.4 MHz		Bandwidth 3 MHz		Bandwidth 5 MHz		Bandwidth 10 MHz					
	Ch. #	Freq. (MHz)	Ch. #	Freq. (MHz)	Ch. #	Freq. (MHz)	Ch. #	Freq. (MHz)	Ch. #	Freq. (MHz)	Ch. #	Freq. (MHz)
L	20407	824.7	20415	825.5	20425	826.5	20450	829				
M	20525	836.5	20525	836.5	20525	836.5	20525	836.5	20525	836.5	20525	836.5
H	20643	848.3	20635	847.5	20625	846.5	20600	844				
LTE Band 7												
	Bandwidth 5 MHz		Bandwidth 10 MHz		Bandwidth 15 MHz		Bandwidth 20 MHz					
	Ch. #	Freq. (MHz)	Ch. #	Freq. (MHz)	Ch. #	Freq. (MHz)	Ch. #	Freq. (MHz)	Ch. #	Freq. (MHz)	Ch. #	Freq. (MHz)
L	20775	2502.5	20800	2505	20825	2507.5	20850	2510				
M	21100	2535	21100	2535	21100	2535	21100	2535	21100	2535	21100	2535
H	21425	2567.5	21400	2565	21375	2562.5	21350	2560				
LTE Band 38												
	Bandwidth 5 MHz		Bandwidth 10 MHz		Bandwidth 15 MHz		Bandwidth 20 MHz					
	Ch. #	Freq. (MHz)	Ch. #	Freq. (MHz)	Ch. #	Freq. (MHz)	Ch. #	Freq. (MHz)	Ch. #	Freq. (MHz)	Ch. #	Freq. (MHz)
L	37775	2572.5	37800	2575	37825	2577.5	37850	2580				
M	38000	2595	38000	2595	38000	2595	38000	2595	38000	2595	38000	2595
H	38225	2617.5	38200	2615	38175	2612.5	38150	2610				

## 5. Proximity Sensor Triggering Test

### 5.1 Proximity sensor triggering distances(Per KDB616217§6.2)

1. Proximity sensor triggering distance testing was performed according to the procedures outlined in KDB 616217 D04 section 6.2, and EUT moving further away from the flat phantom and EUT moving toward the flat phantom were both assessed and the tissue-equivalent medium for highest frequency (2600MHz) and lowest (1750MHz) frequency was used for proximity sensor triggering testing.
2. Capacitive proximity sensor placed coincident with antenna elements at the bottom end of the phone are utilized to determine when the device comes in proximity of the user's body at the front, back or bottom side surface of the device. There is no need to do sensor coverage testing for the proximity sensor is designed to support sufficient detection range and sensitivity to cover regions of the sensors in all applicable directions since the proximity sensor entirely covers the antenna.
3. When the sensor is active, WCDMA B2 / B4, and LTE B2 / B4 / B7 reduced power will be active.
4. The sensors used to detect the proximity of the user's body at the front, back or bottom side surface of the device use a detection threshold distance. The data shown in the sections below shows the distance(s).

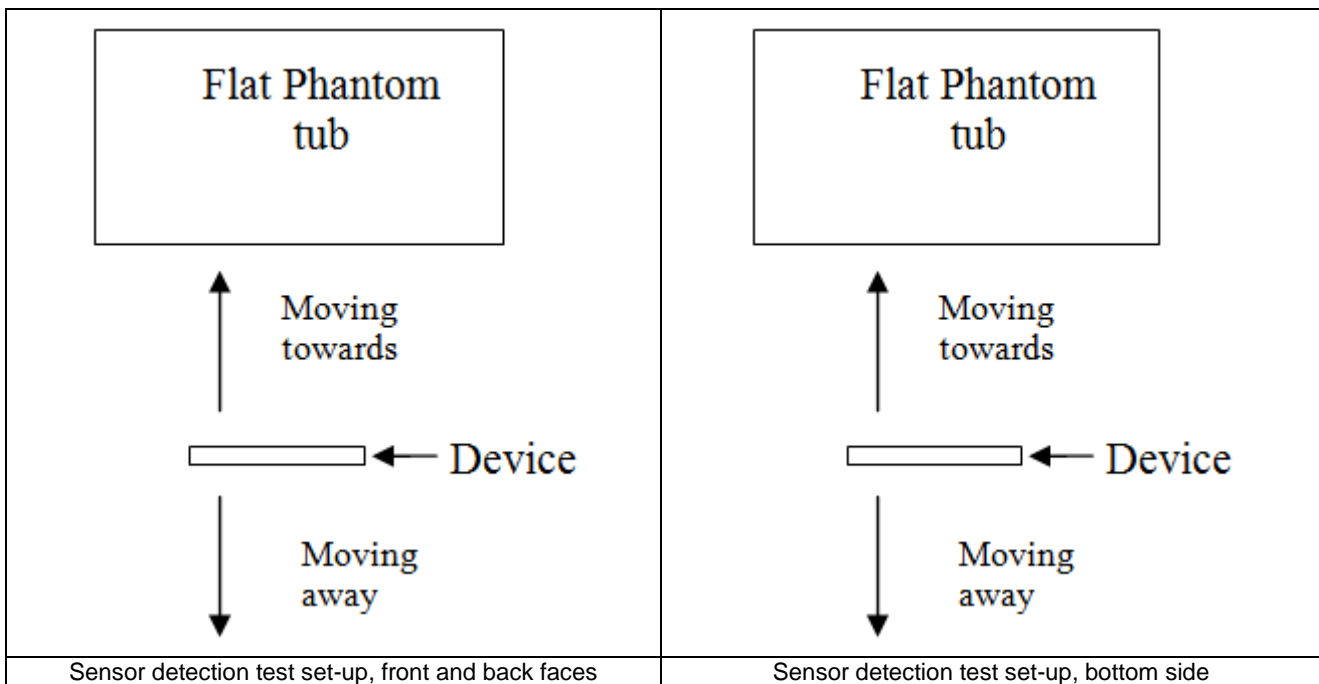

Proximity Sensor Triggering Distance (mm)						
Position	Front		Back		Bottom Side	
	Moving towards	Moving away	Moving towards	Moving away	Moving towards	Moving away
Minimum	9	11	11	13	12	14

<Sensor Trigger Distance and Measured Power>

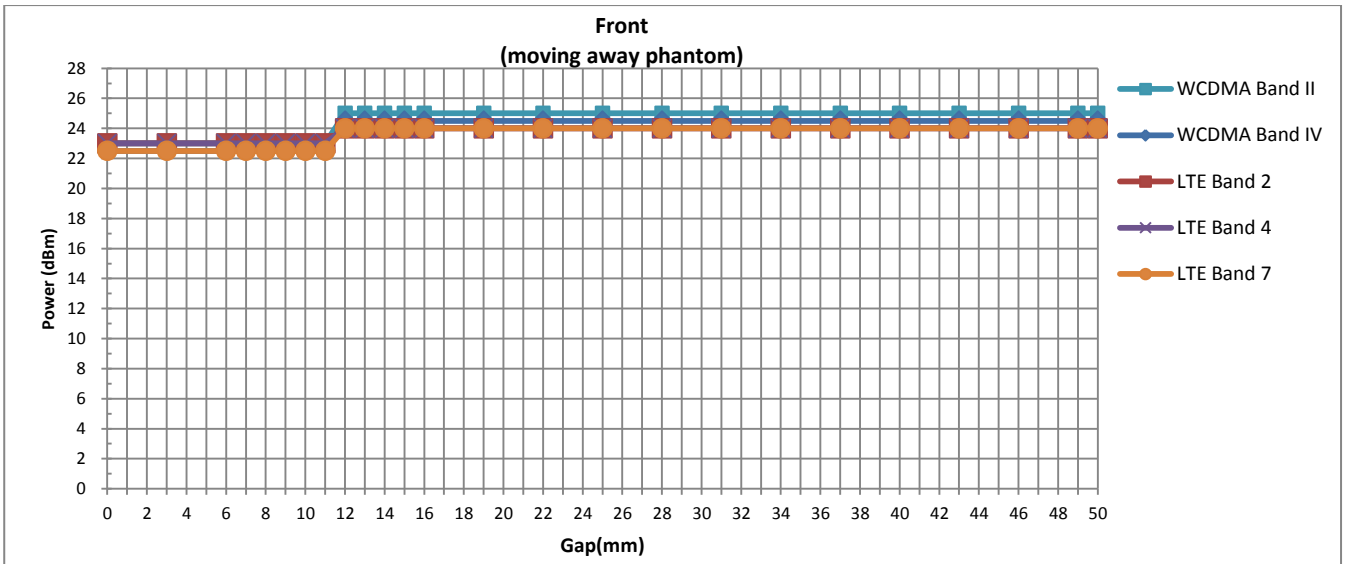
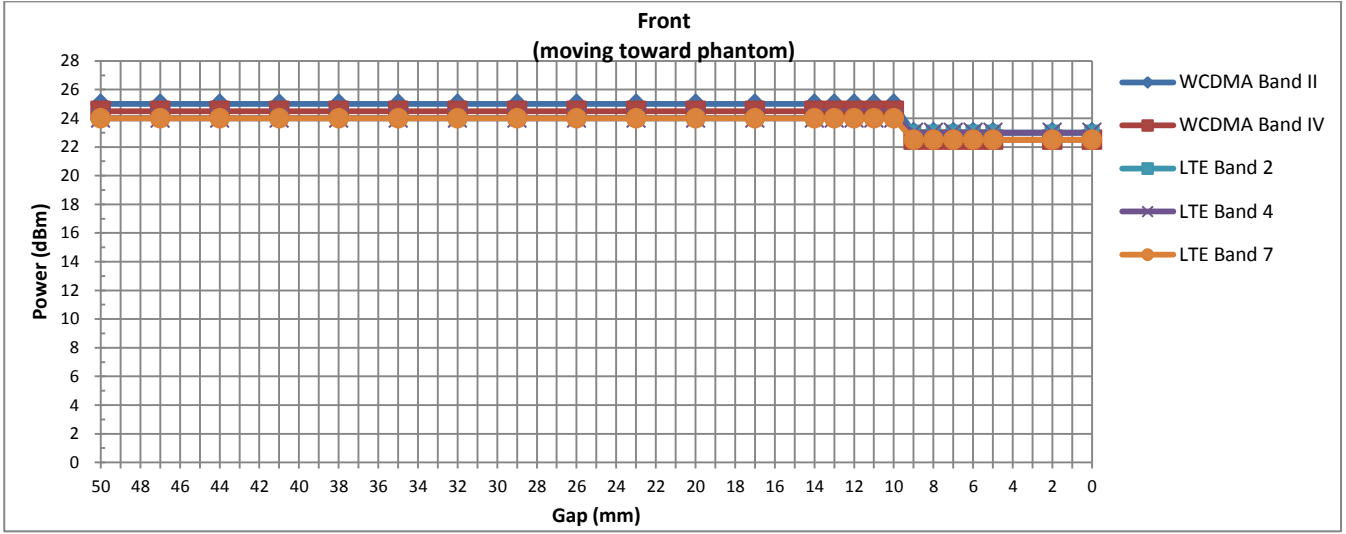

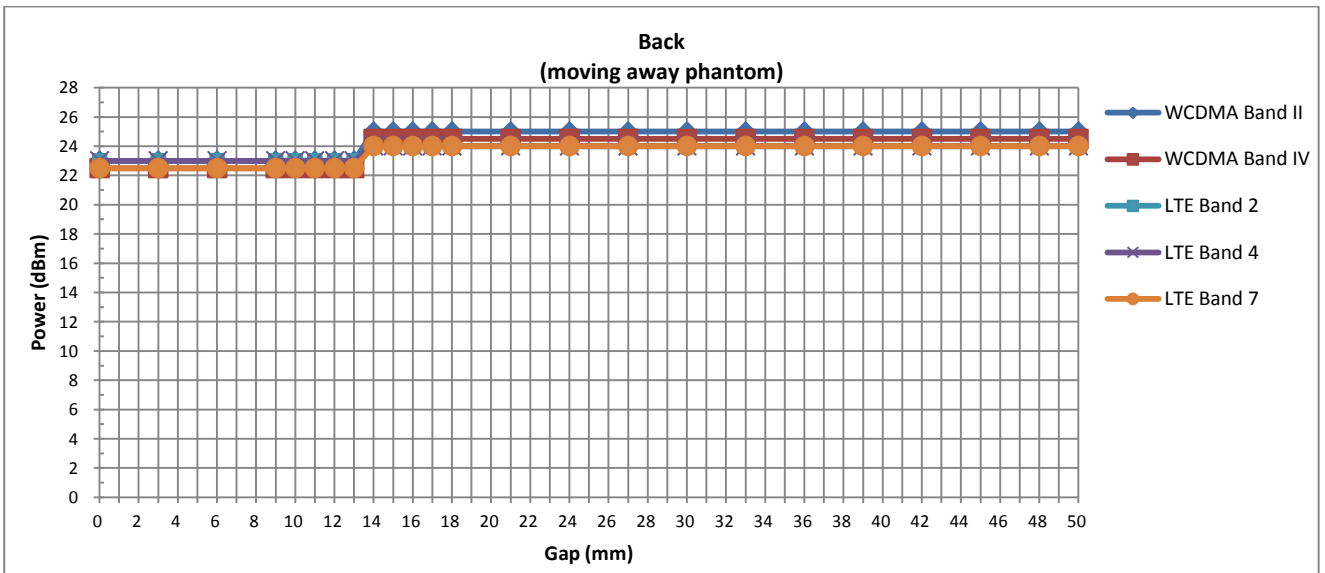
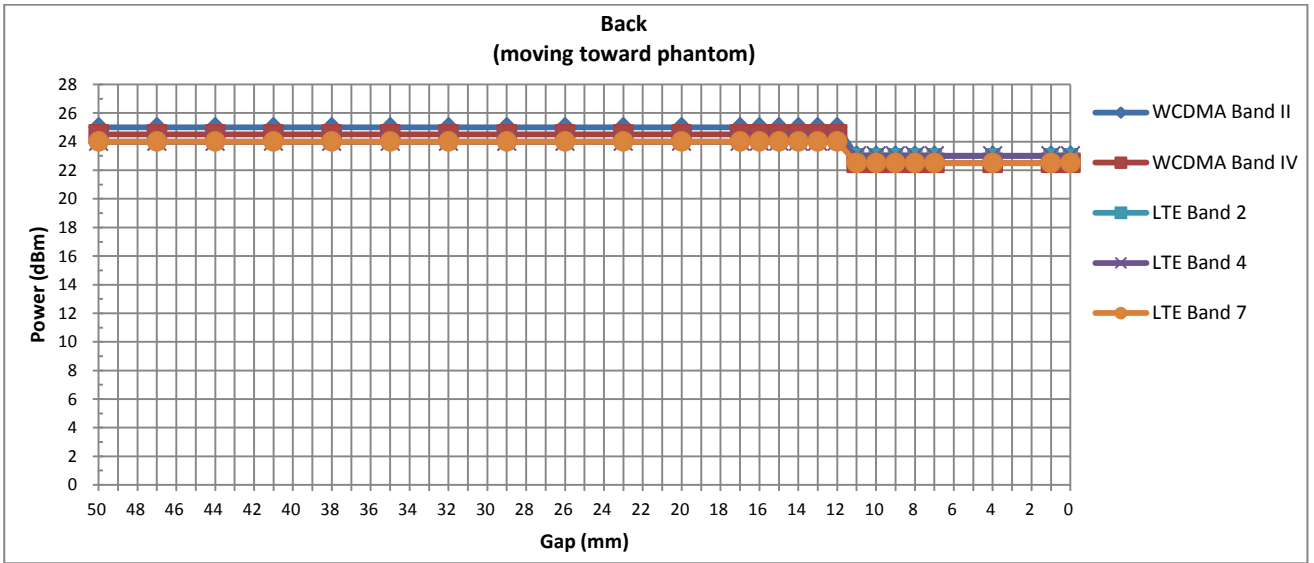

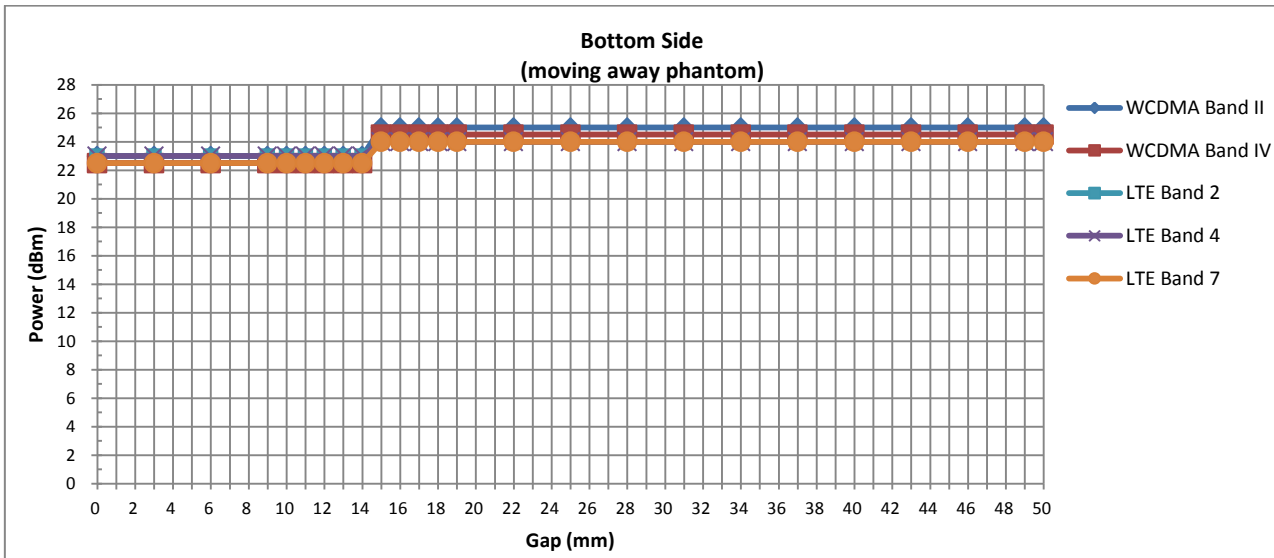
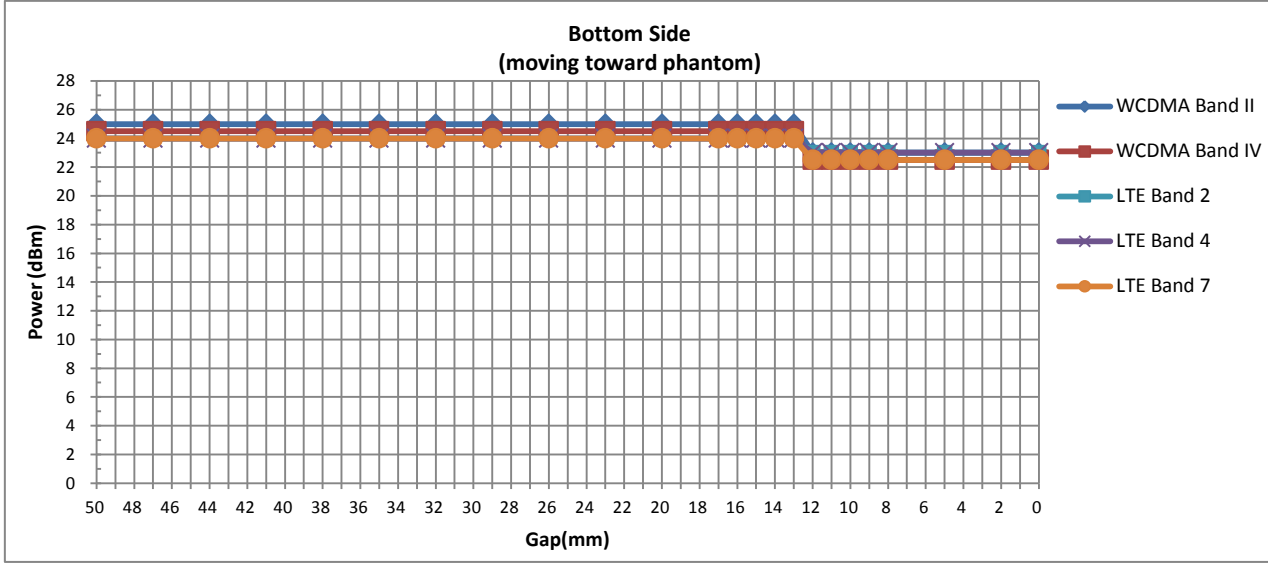

**5.2 Tilt angle influences to proximity sensor triggering(Per KDB616217 §6.4)**

The DUT was positioned directly below the flat phantom at the minimum measured trigger distance with bottom side parallel to the base of the flat phantom for each band.

The EUT was rotated about bottom side for angles up to +/- 45°. If the output power increased during the rotation the DUT was moved 1mm toward the phantom and the rotation repeated. This procedure was repeated until the power remained reduced for all angles up to +/- 45°.

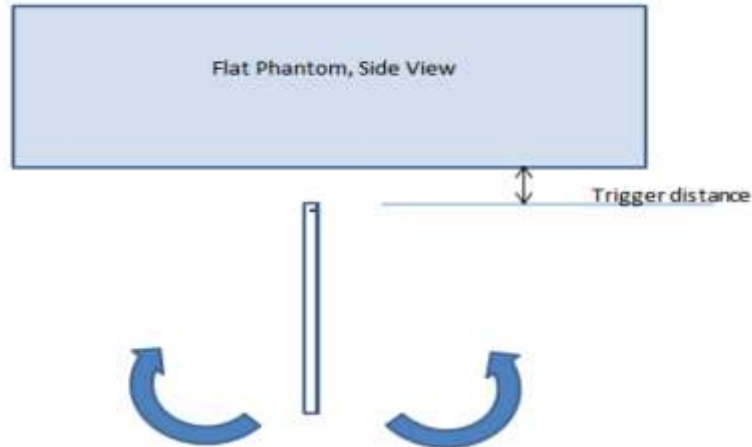

**Proximity Sensor Coverage Assesment(Bottom Side)**

**Table: Summary of Tablet Tilt Angle Influence to Proximity Sensor Triggering (Bottom Side)**

Main ant Band(MHz)	Minimum trigger distance at which power reduction was maintained over ±45°	Power Reduction Status											
		-45°	-35°	-25°	-15°	-5°	0°	5°	15°	25°	35°	45°	
WCDMA Band II	12mm	on	on	on	on	on	on	on	on	on	on	on	on
WCDMA Band IV	12mm	on	on	on	on	on	on	on	on	on	on	on	on
LTE Band 2	12mm	on	on	on	on	on	on	on	on	on	on	on	on
LTE Band 4	12mm	on	on	on	on	on	on	on	on	on	on	on	on
LTE Band 7	12mm	on	on	on	on	on	on	on	on	on	on	on	on

**Conclusion:** As is shown from the validation data, it can be ensured that the proximity sensor can be valid triggered for the DUT tilt coverage exposure condition.



6. RF Exposure Limits

6.1 Uncontrolled Environment

Uncontrolled Environments are defined as locations where there is the exposure of individuals who have no knowledge or control of their exposure. The general population/uncontrolled exposure limits are applicable to situations in which the general public may be exposed or in which persons who are exposed as a consequence of their employment may not be made fully aware of the potential for exposure or cannot exercise control over their exposure. Members of the general public would come under this category when exposure is not employment-related; for example, in the case of a wireless transmitter that exposes persons in its vicinity.

6.2 Controlled Environment

Controlled Environments are defined as locations where there is exposure that may be incurred by persons who are aware of the potential for exposure, (i.e. as a result of employment or occupation). In general, occupational/controlled exposure limits are applicable to situations in which persons are exposed as a consequence of their employment, who have been made fully aware of the potential for exposure and can exercise control over their exposure. The exposure category is also applicable when the exposure is of a transient nature due to incidental passage through a location where the exposure levels may be higher than the general population/uncontrolled limits, but the exposed person is fully aware of the potential for exposure and can exercise control over his or her exposure by leaving the area or by some other appropriate means.

Limits for Occupational/Controlled Exposure (W/kg)

Table with 3 columns: Whole-Body, Partial-Body, Hands, Wrists, Feet and Ankles. Values: 0.4, 8.0, 20.0

Limits for General Population/Uncontrolled Exposure (W/kg)

Table with 3 columns: Whole-Body, Partial-Body, Hands, Wrists, Feet and Ankles. Values: 0.08, 1.6, 4.0

Whole-Body SAR is averaged over the entire body, partial-body SAR is averaged over any 1gram of tissue defined as a tissue volume in the shape of a cube. SAR for hands, wrists, feet and ankles is averaged over any 10 grams of tissue defined as a tissue volume in the shape of a cube.

## **7. Specific Absorption Rate (SAR)**

### **7.1 Introduction**

SAR is related to the rate at which energy is absorbed per unit mass in an object exposed to a radio field. The SAR distribution in a biological body is complicated and is usually carried out by experimental techniques or numerical modeling. The standard recommends limits for two tiers of groups, occupational/controlled and general population/uncontrolled, based on a person's awareness and ability to exercise control over his or her exposure. In general, occupational/controlled exposure limits are higher than the limits for general population/uncontrolled.

### **7.2 SAR Definition**

The SAR definition is the time derivative (rate) of the incremental energy (dW) absorbed by (dissipated in) an incremental mass (dm) contained in a volume element (dv) of a given density ( $\rho$ ). The equation description is as below:

$$\text{SAR} = \frac{d}{dt} \left( \frac{dW}{dm} \right) = \frac{d}{dt} \left( \frac{dW}{\rho dv} \right)$$

SAR is expressed in units of Watts per kilogram (W/kg)

$$\text{SAR} = \frac{\sigma |E|^2}{\rho}$$

Where:  $\sigma$  is the conductivity of the tissue,  $\rho$  is the mass density of the tissue and E is the RMS electrical field strength.



## 8. System Description and Setup

The DASY system used for performing compliance tests consists of the following items:

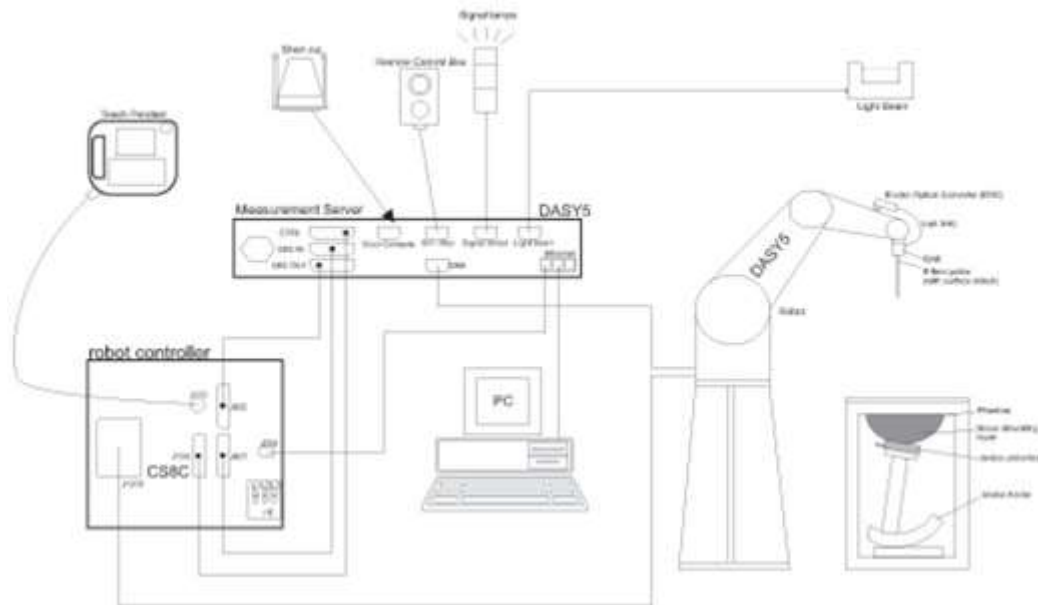

- A standard high precision 6-axis robot with controller, teach pendant and software. An arm extension for accommodating the data acquisition electronics (DAE).
- An isotropic Field probe optimized and calibrated for the targeted measurement.
- A data acquisition electronics (DAE) which performs the signal amplification, signal multiplexing, AD-conversion, offset measurements, mechanical surface detection, collision detection, etc. The unit is battery powered with standard or rechargeable batteries. The signal is optically transmitted to the EOC.
- The Electro-optical converter (EOC) performs the conversion from optical to electrical signals for the digital communication to the DAE. To use optical surface detection, a special version of the EOC is required. The EOC signal is transmitted to the measurement server.
- The function of the measurement server is to perform the time critical tasks such as signal filtering, control of the robot operation and fast movement interrupts.
- The Light Beam used is for probe alignment. This improves the (absolute) accuracy of the probe positioning.
- A computer running WinXP or Win7 and the DASY5 software.
- Remote control and teach pendant as well as additional circuitry for robot safety such as warning lamps, etc.
- The phantom, the device holder and other accessories according to the targeted measurement.

**8.1 E-Field Probe**

The SAR measurement is conducted with the dosimetric probe (manufactured by SPEAG).The probe is specially designed and calibrated for use in liquid with high permittivity. The dosimetric probe has special calibration in liquid at different frequency. This probe has a built in optical surface detection system to prevent from collision with phantom.

**<EX3DV4 Probe>**

<b>Construction</b>	Symmetric design with triangular core Built-in shielding against static charges PEEK enclosure material (resistant to organic solvents, e.g., DGBE)	
<b>Frequency</b>	10 MHz – >6 GHz Linearity: ±0.2 dB (30 MHz – 6 GHz)	
<b>Directivity</b>	±0.3 dB in TSL (rotation around probe axis) ±0.5 dB in TSL (rotation normal to probe axis)	
<b>Dynamic Range</b>	10 µW/g – >100 mW/g Linearity: ±0.2 dB (noise: typically <1 µW/g)	
<b>Dimensions</b>	Overall length: 337 mm (tip: 20 mm) Tip diameter: 2.5 mm (body: 12 mm) Typical distance from probe tip to dipole centers: 1 mm	

**8.2 Data Acquisition Electronics (DAE)**

The data acquisition electronics (DAE) consists of a highly sensitive electrometer-grade preamplifier with auto-zeroing, a channel and gain-switching multiplexer, a fast 16 bit AD-converter and a command decoder and control logic unit. Transmission to the measurement server is accomplished through an optical downlink for data and status information as well as an optical uplink for commands and the clock.

The input impedance of the DAE is 200 MOhm; the inputs are symmetrical and floating. Common mode rejection is above 80 dB.



**Photo of DAE**

**8.3 Phantom**

**<SAM Twin Phantom>**

<b>Shell Thickness</b>	2 ± 0.2 mm; Center ear point: 6 ± 0.2 mm
<b>Filling Volume</b>	Approx. 25 liters
<b>Dimensions</b>	Length: 1000 mm; Width: 500 mm; Height: adjustable feet
<b>Measurement Areas</b>	Left Hand, Right Hand, Flat Phantom



The bottom plate contains three pair of bolts for locking the device holder. The device holder positions are adjusted to the standard measurement positions in the three sections. A white cover is provided to tap the phantom during off-periods to prevent water evaporation and changes in the liquid parameters. On the phantom top, three reference markers are provided to identify the phantom position with respect to the robot.

**<ELI Phantom>**

<b>Shell Thickness</b>	2 ± 0.2 mm (sagging: <1%)
<b>Filling Volume</b>	Approx. 30 liters
<b>Dimensions</b>	Major ellipse axis: 600 mm Minor axis: 400 mm



The ELI phantom is intended for compliance testing of handheld and body-mounted wireless devices in the frequency range of 30 MHz to 6 GHz. ELI4 is fully compatible with standard and all known tissue simulating liquids.

## 8.4 Device Holder

### <Mounting Device for Hand-Held Transmitter>

In combination with the Twin SAM V5.0/V5.0c or ELI phantoms, the Mounting Device for Hand-Held Transmitters enables rotation of the mounted transmitter device to specified spherical coordinates. At the heads, the rotation axis is at the ear opening. Transmitter devices can be easily and accurately positioned according to IEC 62209-1, IEEE 1528, FCC, or other specifications. The device holder can be locked for positioning at different phantom sections (left head, right head, flat). And upgrade kit to Mounting Device to enable easy mounting of wider devices like big smart-phones, e-books, small tablets, etc. It holds devices with width up to 140 mm.



Mounting Device for Hand-Held Transmitters



Mounting Device Adaptor for Wide-Phones

### <Mounting Device for Laptops and other Body-Worn Transmitters>

The extension is lightweight and made of POM, acrylic glass and foam. It fits easily on the upper part of the mounting device in place of the phone positioned. The extension is fully compatible with the SAM Twin and ELI phantoms.



Mounting Device for Laptops

## **9. Measurement Procedures**

The measurement procedures are as follows:

### <Conducted power measurement>

- (a) For WWAN power measurement, use base station simulator to configure EUT WWAN transmission in conducted connection with RF cable, at maximum power in each supported wireless interface and frequency band.
- (b) Read the WWAN RF power level from the base station simulator.
- (c) For WLAN/BT power measurement, use engineering software to configure EUT WLAN/BT continuously transmission, at maximum RF power in each supported wireless interface and frequency band
- (d) Connect EUT RF port through RF cable to the power meter, and measure WLAN/BT output power

### <SAR measurement>

- (a) Use base station simulator to configure EUT WWAN transmission in radiated connection, and engineering software to configure EUT WLAN/BT continuously transmission, at maximum RF power, in the highest power channel.
- (b) Place the EUT in the positions as Appendix D demonstrates.
- (c) Set scan area, grid size and other setting on the DASY software.
- (d) Measure SAR results for the highest power channel on each testing position.
- (e) Find out the largest SAR result on these testing positions of each band
- (f) Measure SAR results for other channels in worst SAR testing position if the reported SAR of highest power channel is larger than 0.8 W/kg

According to the test standard, the recommended procedure for assessing the peak spatial-average SAR value consists of the following steps:

- (a) Power reference measurement
- (b) Area scan
- (c) Zoom scan
- (d) Power drift measurement

### **9.1 Spatial Peak SAR Evaluation**

The procedure for spatial peak SAR evaluation has been implemented according to the test standard. It can be conducted for 1g and 10g, as well as for user-specific masses. The DASY software includes all numerical procedures necessary to evaluate the spatial peak SAR value.

The base for the evaluation is a "cube" measurement. The measured volume must include the 1g and 10g cubes with the highest averaged SAR values. For that purpose, the center of the measured volume is aligned to the interpolated peak SAR value of a previously performed area scan.

The entire evaluation of the spatial peak values is performed within the post-processing engine (SEMCAD). The system always gives the maximum values for the 1g and 10g cubes. The algorithm to find the cube with highest averaged SAR is divided into the following stages:

- (a) Extraction of the measured data (grid and values) from the Zoom Scan
- (b) Calculation of the SAR value at every measurement point based on all stored data (A/D values and measurement parameters)
- (c) Generation of a high-resolution mesh within the measured volume
- (d) Interpolation of all measured values from the measurement grid to the high-resolution grid
- (e) Extrapolation of the entire 3-D field distribution to the phantom surface over the distance from sensor to surface
- (f) Calculation of the averaged SAR within masses of 1g and 10g

**9.2 Power Reference Measurement**

The Power Reference Measurement and Power Drift Measurements are for monitoring the power drift of the device under test in the batch process. The minimum distance of probe sensors to surface determines the closest measurement point to phantom surface. This distance cannot be smaller than the distance of sensor calibration points to probe tip as defined in the probe properties.

**9.3 Area Scan**

The area scan is used as a fast scan in two dimensions to find the area of high field values, before doing a fine measurement around the hot spot. The sophisticated interpolation routines implemented in DASY software can find the maximum found in the scanned area, within a range of the global maximum. The range (in dB0 is specified in the standards for compliance testing. For example, a 2 dB range is required in IEEE standard 1528 and IEC 62209 standards, whereby 3 dB is a requirement when compliance is assessed in accordance with the ARIB standard (Japan), if only one zoom scan follows the area scan, then only the absolute maximum will be taken as reference. For cases where multiple maximums are detected, the number of zoom scans has to be increased accordingly.

Area scan parameters extracted from FCC KDB 865664 D01v01r04 SAR measurement 100 MHz to 6 GHz.

	≤ 3 GHz	> 3 GHz
Maximum distance from closest measurement point (geometric center of probe sensors) to phantom surface	5 ± 1 mm	$\frac{1}{2} \cdot \delta \cdot \ln(2) \pm 0.5$ mm
Maximum probe angle from probe axis to phantom surface normal at the measurement location	30° ± 1°	20° ± 1°
Maximum area scan spatial resolution: $\Delta x_{Area}$ , $\Delta y_{Area}$	≤ 2 GHz: ≤ 15 mm 2 – 3 GHz: ≤ 12 mm	3 – 4 GHz: ≤ 12 mm 4 – 6 GHz: ≤ 10 mm
	When the x or y dimension of the test device, in the measurement plane orientation, is smaller than the above, the measurement resolution must be ≤ the corresponding x or y dimension of the test device with at least one measurement point on the test device.	

**9.4 Zoom Scan**

Zoom scans are used assess the peak spatial SAR values within a cubic averaging volume containing 1 gram and 10 gram of simulated tissue. The zoom scan measures points (refer to table below) within a cube shoes base faces are centered on the maxima found in a preceding area scan job within the same procedure. When the measurement is done, the zoom scan evaluates the averaged SAR for 1 gram and 10 gram and displays these values next to the job's label.

Zoom scan parameters extracted from FCC KDB 865664 D01v01r04 SAR measurement 100 MHz to 6 GHz.

		≤ 3 GHz	> 3 GHz	
Maximum zoom scan spatial resolution: $\Delta x_{Zoom}, \Delta y_{Zoom}$		$\leq 2$ GHz: $\leq 8$ mm $2 - 3$ GHz: $\leq 5$ mm*	$3 - 4$ GHz: $\leq 5$ mm* $4 - 6$ GHz: $\leq 4$ mm*	
Maximum zoom scan spatial resolution, normal to phantom surface	uniform grid: $\Delta z_{Zoom}(n)$	$\leq 5$ mm	$3 - 4$ GHz: $\leq 4$ mm $4 - 5$ GHz: $\leq 3$ mm $5 - 6$ GHz: $\leq 2$ mm	
	graded grid	$\Delta z_{Zoom}(1)$ : between 1 <sup>st</sup> two points closest to phantom surface	$\leq 4$ mm	$3 - 4$ GHz: $\leq 3$ mm $4 - 5$ GHz: $\leq 2.5$ mm $5 - 6$ GHz: $\leq 2$ mm
		$\Delta z_{Zoom}(n>1)$ : between subsequent points	$\leq 1.5 \cdot \Delta z_{Zoom}(n-1)$	
Minimum zoom scan volume	x, y, z	$\geq 30$ mm	$3 - 4$ GHz: $\geq 28$ mm $4 - 5$ GHz: $\geq 25$ mm $5 - 6$ GHz: $\geq 22$ mm	
Note: $\delta$ is the penetration depth of a plane-wave at normal incidence to the tissue medium; see draft standard IEEE P1528-2011 for details. * When zoom scan is required and the <i>reported</i> SAR from the <i>area scan based 1-g SAR estimation</i> procedures of KDB 447498 is $\leq 1.4$ W/kg, $\leq 8$ mm, $\leq 7$ mm and $\leq 5$ mm zoom scan resolution may be applied, respectively, for 2 GHz to 3 GHz, 3 GHz to 4 GHz and 4 GHz to 6 GHz.				

**9.5 Volume Scan Procedures**

The volume scan is used for assess overlapping SAR distributions for antennas transmitting in different frequency bands. It is equivalent to an oversized zoom scan used in standalone measurements. The measurement volume will be used to enclose all the simultaneous transmitting antennas. For antennas transmitting simultaneously in different frequency bands, the volume scan is measured separately in each frequency band. In order to sum correctly to compute the 1g aggregate SAR, the EUT remain in the same test position for all measurements and all volume scan use the same spatial resolution and grid spacing. When all volume scan were completed, the software, SEMCAD postprocessor can combine and subsequently superpose these measurement data to calculating the multiband SAR.

**9.6 Power Drift Monitoring**

All SAR testing is under the EUT install full charged battery and transmit maximum output power. In DASy measurement software, the power reference measurement and power drift measurement procedures are used for monitoring the power drift of EUT during SAR test. Both these procedures measure the field at a specified reference position before and after the SAR testing. The software will calculate the field difference in dB. If the power drifts more than 5%, the SAR will be retested.





**10. Test Equipment List**

Manufacturer	Name of Equipment	Type/Model	Serial Number	Calibration	
				Last Cal.	Due Date
SPEAG	835MHz System Validation Kit	D835V2	4d151	2019/3/27	2020/3/26
SPEAG	1750MHz System Validation Kit	D1750V2	1090	2019/3/27	2020/3/26
SPEAG	1900MHz System Validation Kit	D1900V2	5d170	2019/3/26	2020/3/25
SPEAG	2450MHz System Validation Kit	D2450V2	908	2019/3/25	2020/3/24
SPEAG	2600MHz System Validation Kit	D2600V2	1061	2018/12/7	2019/12/6
SPEAG	5000MHz System Validation Kit	D5GHzV2	1006	2018/9/27	2019/9/26
SPEAG	Data Acquisition Electronics	DAE4	1279	2018/10/22	2019/10/21
SPEAG	Data Acquisition Electronics	DAE4	1338	2018/12/3	2019/12/2
SPEAG	Dosimetric E-Field Probe	EX3DV4	3954	2019/4/25	2020/4/24
SPEAG	Dosimetric E-Field Probe	EX3DV4	3843	2018/9/27	2019/9/26
SPEAG	Dosimetric E-Field Probe	EX3DV4	3911	2019/1/22	2020/1/21
SPEAG	SAM Twin Phantom	QD 000 P40 CB	TP-1839	NCR	NCR
SPEAG	SAM Twin Phantom	QD 000 P40 CB	TP-1503	NCR	NCR
SPEAG	SAM Twin Phantom	QD 000 P40 CB	TP-1697	NCR	NCR
SPEAG	Phone Positioner	N/A	N/A	NCR	NCR
Anritsu	Radio communication analyzer	MT8821C	6201432831	2019/4/17	2020/4/16
Agilent	ENA Series Network Analyzer	E5071C	MY46106933	2018/8/3	2019/8/2
SPEAG	Dielectric Probe Kit	DAK-3.5	1138	2018/11/20	2019/11/19
Anritsu	Vector Signal Generator	MG3710A	6201682672	2019/1/14	2020/1/13
Rohde & Schwarz	Power Meter	NRVD	102081	2018/8/20	2019/8/19
Rohde & Schwarz	Power Sensor	NRV-Z5	100538	2018/8/20	2019/8/19
Rohde & Schwarz	Power Sensor	NRV-Z5	100539	2018/8/20	2019/8/19
R&S	CBT BLUETOOTH TESTER	CBT	101641	2019/1/14	2020/1/13
EXA	Spectrum Analyzer	FSV7	101631	2019/1/14	2020/1/13
Testo	Hygrometer	608-H1	1241332126	2018/8/21	2019/8/20
FLUKE	DIGITAC THERMOMETER	51II	97240029	2018/8/8	2019/8/7
ARRA	Power Divider	A3200-2	N/A	Note	
MCL	Attenuation1	BW-S10W5+	N/A	Note	
MCL	Attenuation2	BW-S10W5+	N/A	Note	
MCL	Attenuation3	BW-S10W5+	N/A	Note	
BONN	POWER AMPLIFIER	BLMA 0830-3	087193A	Note	
BONN	POWER AMPLIFIER	BLMA 2060-2	087193B	Note	
Agilent	Dual Directional Coupler	778D	20500	Note	
Agilent	Dual Directional Coupler	11691D	MY48151020	Note	

**Note:** Prior to system verification and validation, the path loss from the signal generator to the system check source and the power meter, which includes the amplifier, cable, attenuator and directional coupler, was measured by the network analyzer. The reading of the power meter was offset by the path loss difference between the path to the power meter and the path to the system check source to monitor the actual power level fed to the system check source.



## **11. System Verification**

### **11.1 Tissue Simulating Liquids**

For the measurement of the field distribution inside the SAM phantom with DASYS, the phantom must be filled with around 25 liters of homogeneous body tissue simulating liquid. For head SAR testing, the liquid height from the ear reference point (ERP) of the phantom to the liquid top surface is larger than 15 cm, which is shown in Fig. 10.1. For body SAR testing, the liquid height from the center of the flat phantom to the liquid top surface is larger than 15 cm, which is shown in Fig. 10.2.



Fig 10.1 Photo of Liquid Height for Head SAR



Fig 10.2 Photo of Liquid Height for Body SAR



**11.2 Tissue Verification**

The following tissue formulations are provided for reference only as some of the parameters have not been thoroughly verified. The composition of ingredients may be modified accordingly to achieve the desired target tissue parameters required for routine SAR evaluation.

Frequency (MHz)	Water (%)	Sugar (%)	Cellulose (%)	Salt (%)	Preventol (%)	DGBE (%)	Conductivity ( $\sigma$ )	Permittivity ( $\epsilon_r$ )
<b>For Head</b>								
835	40.3	57.9	0.2	1.4	0.2	0	0.90	41.5
1800, 1900, 2000	55.2	0	0	0.3	0	44.5	1.40	40.0
2450	55.0	0	0	0	0	45.0	1.80	39.2
2600	54.8	0	0	0.1	0	45.1	1.96	39.0
<b>For Body</b>								
835	50.8	48.2	0	0.9	0.1	0	0.97	55.2
1800, 1900, 2000	70.2	0	0	0.4	0	29.4	1.52	53.3
2450	68.6	0	0	0	0	31.4	1.95	52.7
2600	68.1	0	0	0.1	0	31.8	2.16	52.5

**Simulating Liquid for 5GHz, Manufactured by SPEAG**

Ingredients	(% by weight)
Water	64~78%
Mineral oil	11~18%
Emulsifiers	9~15%
Additives and Salt	2~3%

**<Tissue Dielectric Parameter Check Results>**

Frequency (MHz)	Tissue Type	Liquid Temp. (°C)	Conductivity ( $\sigma$ )	Permittivity ( $\epsilon_r$ )	Conductivity Target ( $\sigma$ )	Permittivity Target ( $\epsilon_r$ )	Delta ( $\sigma$ ) (%)	Delta ( $\epsilon_r$ ) (%)	Limit (%)	Date
835	Head	22.7	0.904	42.015	0.90	41.50	0.44	1.24	±5	2019/6/19
1750	Head	22.9	1.355	39.596	1.37	40.10	-1.09	-1.26	±5	2019/6/19
1900	Head	22.6	1.402	39.391	1.40	40.00	0.14	-1.52	±5	2019/6/19
2450	Head	22.9	1.860	38.914	1.80	39.20	3.33	-0.73	±5	2019/6/19
2600	Head	22.7	1.976	39.468	1.96	39.00	0.82	1.20	±5	2019/6/21
5250	Head	22.8	4.647	34.972	4.71	35.90	-1.34	-2.58	±5	2019/6/21
5600	Head	22.6	4.986	34.505	5.07	35.50	-1.66	-2.80	±5	2019/6/21
5750	Head	22.7	5.140	34.286	5.22	35.40	-1.53	-3.15	±5	2019/6/21
835	Body	22.7	0.998	56.478	0.97	55.20	2.89	2.32	±5	2019/6/19
1750	Body	22.8	1.439	53.027	1.49	53.40	-3.42	-0.70	±5	2019/6/19
1900	Body	22.6	1.513	53.669	1.52	53.30	-0.46	0.69	±5	2019/6/19
2450	Body	22.6	1.992	53.992	1.95	52.70	2.15	2.45	±5	2019/6/19
2600	Body	22.7	2.203	53.413	2.16	52.50	1.99	1.74	±5	2019/6/19
5250	Body	22.7	5.503	47.874	5.36	48.90	2.67	-2.10	±5	2019/6/22
5600	Body	22.7	5.957	47.280	5.77	48.50	3.24	-2.52	±5	2019/6/22
5750	Body	22.7	6.179	47.023	5.94	48.30	4.02	-2.64	±5	2019/6/22

### 11.3 System Performance Check Results

Comparing to the original SAR value provided by SPEAG, the verification data should be within its specification of 10 %. Below table shows the target SAR and measured SAR after normalized to 1W input power. The table below indicates the system performance check can meet the variation criterion and the plots can be referred to Appendix A of this report.

**<1g SAR>**

Date	Frequency (MHz)	Tissue Type	Input Power (mW)	Dipole S/N	Probe S/N	DAE S/N	Measured 1g SAR (W/kg)	Targeted 1g SAR (W/kg)	Normalized 1g SAR (W/kg)	Deviation (%)
2019/6/19	835	Head	250	4d151	3843	1279	2.42	9.30	9.68	4.09
2019/6/19	1750	Head	250	1090	3843	1279	9.27	36.40	37.08	1.87
2019/6/19	1900	Head	250	5d170	3843	1279	9.67	39.00	38.68	-0.82
2019/6/19	2450	Head	250	908	3843	1279	13.40	52.80	53.6	1.52
2019/6/21	2600	Head	250	1061	3843	1279	14.40	57.70	57.6	-0.17
2019/6/21	5250	Head	100	1006	3954	1338	7.57	80.70	75.7	-6.20
2019/6/21	5600	Head	100	1006	3954	1338	7.68	83.30	76.8	-7.80
2019/6/21	5750	Head	100	1006	3954	1338	7.93	80.40	79.3	-1.37
2019/6/19	835	Body	250	4d151	3843	1279	2.51	9.53	10.04	5.35
2019/6/19	1750	Body	250	1090	3843	1279	9.20	37.70	36.8	-2.39
2019/6/19	1900	Body	250	5d170	3843	1279	9.68	40.00	38.72	-3.20
2019/6/19	2450	Body	250	908	3843	1279	13.10	50.80	52.4	3.15
2019/6/19	2600	Body	250	1061	3843	1279	13.80	54.20	55.2	1.85
2019/6/22	5250	Body	100	1006	3911	1338	8.23	78.30	82.3	5.11
2019/6/22	5600	Body	100	1006	3911	1338	7.97	81.00	79.7	-1.60
2019/6/22	5750	Body	100	1006	3911	1338	7.22	77.40	72.2	-6.72

**<10g SAR>**

Date	Frequency (MHz)	Tissue Type	Input Power (mW)	Dipole S/N	Probe S/N	DAE S/N	Measured 10g SAR (W/kg)	Targeted 10g SAR (W/kg)	Normalized 10g SAR (W/kg)	Deviation (%)
2019/6/19	1750	Body	250	1090	3843	1279	4.99	19.90	19.96	0.30
2019/6/19	1900	Body	250	5d170	3843	1279	5.04	21.00	20.16	-4.00
2019/6/22	5250	Body	100	1006	3911	1338	2.31	21.70	23.1	6.45
2019/6/22	5600	Body	100	1006	3911	1338	2.18	22.50	21.8	-3.11

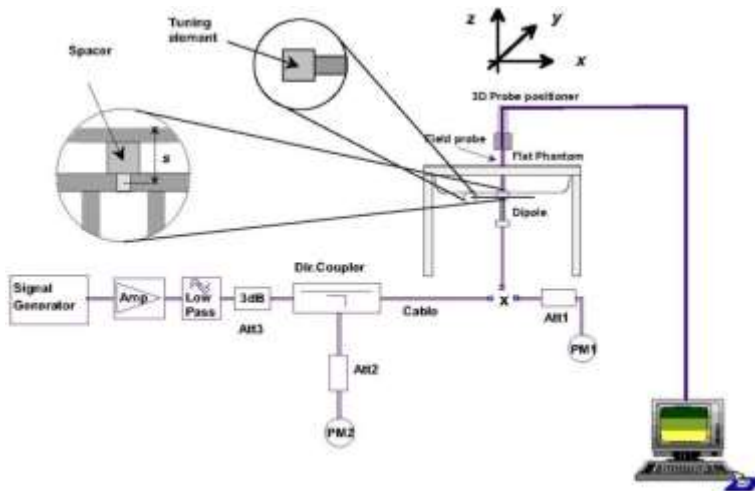

**Fig 11.3.1 System Performance Check Setup**



**Fig 11.3.2 Setup Photo**

## 12. RF Exposure Positions

### 12.1 Ear and handset reference point

Figure 12.1.1 shows the front, back, and side views of the SAM phantom. The center-of-mouth reference point is labeled "M," the left ear reference point (ERP) is marked "LE," and the right ERP is marked "RE." Each ERP is 15 mm along the B-M (back-mouth) line behind the entrance-to-ear-canal (EEC) point, as shown in Figure 12.1.2 The Reference Plane is defined as passing through the two ear reference points and point M. The line N-F (neck-front), also called the reference pivoting line, is normal to the Reference Plane and perpendicular to both a line passing through RE and LE and the B-M line (see Figure 12.1.3). Both N-F and B-M lines should be marked on the exterior of the phantom shell to facilitate handset positioning. Posterior to the N-F line the ear shape is a flat surface with 6 mm thickness at each ERP, and forward of the N-F line the ear is truncated, as illustrated in Figure 12.1.2. The ear truncation is introduced to preclude the ear lobe from interfering with handset tilt, which could lead to unstable positioning at the cheek.



Fig 12.1.1 Front, back, and side views of SAM twin phantom

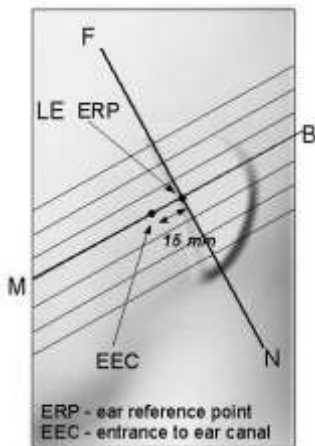

Fig 12.1.2 Close-up side view of phantom showing the ear region.

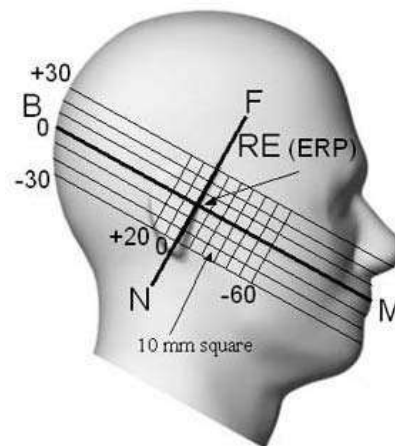
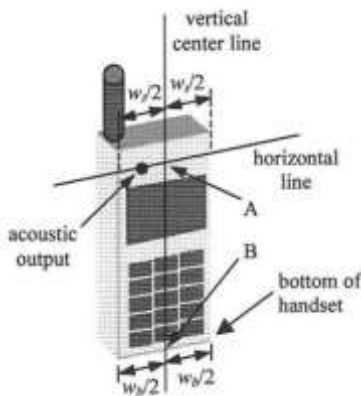

Fig 12.1.3 Side view of the phantom showing relevant markings and seven cross-sectional plane locations

**12.2 Definition of the cheek position**

1. Ready the handset for talk operation, if necessary. For example, for handsets with a cover piece (flip cover), open the cover. If the handset can transmit with the cover closed, both configurations must be tested.
2. Define two imaginary lines on the handset—the vertical centerline and the horizontal line. The vertical centerline passes through two points on the front side of the handset—the midpoint of the width  $w_t$  of the handset at the level of the acoustic output (point A in Figure 12.2.1 and Figure 12.2.2), and the midpoint of the width  $w_b$  of the bottom of the handset (point B). The horizontal line is perpendicular to the vertical centerline and passes through the center of the acoustic output (see Figure 12.2.1). The two lines intersect at point A. Note that for many handsets, point A coincides with the center of the acoustic output; however, the acoustic output may be located elsewhere on the horizontal line. Also note that the vertical centerline is not necessarily parallel to the front face of the handset (see Figure 12.2.2), especially for clamshell handsets, handsets with flip covers, and other irregularly-shaped handsets.
3. Position the handset close to the surface of the phantom such that point A is on the (virtual) extension of the line passing through points RE and LE on the phantom (see Figure 12.2.3), such that the plane defined by the vertical centerline and the horizontal line of the handset is approximately parallel to the sagittal plane of the phantom.
4. Translate the handset towards the phantom along the line passing through RE and LE until handset point A touches the pinna at the ERP.
5. While maintaining the handset in this plane, rotate it around the LE-RE line until the vertical centerline is in the plane normal to the plane containing B-M and N-F lines, i.e., the Reference Plane.
6. Rotate the handset around the vertical centerline until the handset (horizontal line) is parallel to the N-F line.
7. While maintaining the vertical centerline in the Reference Plane, keeping point A on the line passing through RE and LE, and maintaining the handset contact with the pinna, rotate the handset about the N-F line until any point on the handset is in contact with a phantom point below the pinna on the cheek. See Figure 12.2.3. The actual rotation angles should be documented in the test report.



**Fig 12.2.1 Handset vertical and horizontal reference lines—“fixed case”**

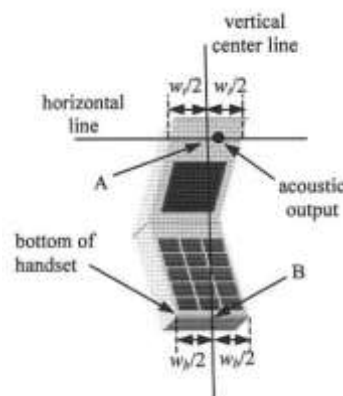

**Fig 12.2.2 Handset vertical and horizontal reference lines—“clam-shell case”**

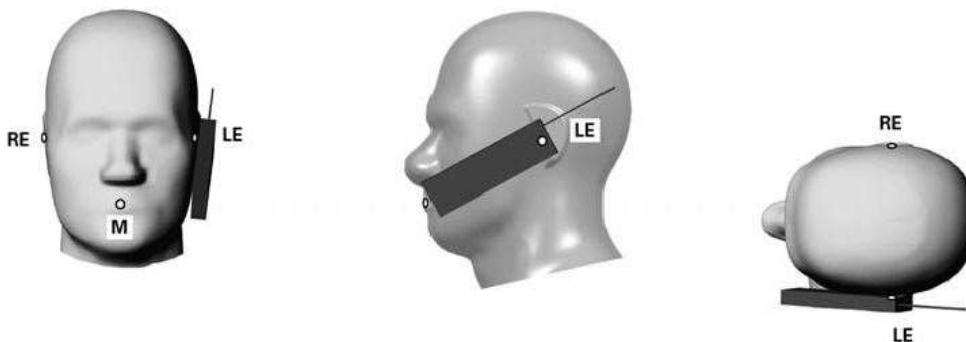

**Fig 12.2.3 cheek or touch position. The reference points for the right ear (RE), left ear (LE), and mouth (M), which establish the Reference Plane for handset positioning, are indicated.**

### 12.3 Definition of the tilt position

1. Ready the handset for talk operation, if necessary. For example, for handsets with a cover piece (flip cover), open the cover. If the handset can transmit with the cover closed, both configurations must be tested.
2. While maintaining the orientation of the handset, move the handset away from the pinna along the line passing through RE and LE far enough to allow a rotation of the handset away from the cheek by 15°.
3. Rotate the handset around the horizontal line by 15°.
4. While maintaining the orientation of the handset, move the handset towards the phantom on the line passing through RE and LE until any part of the handset touches the ear. The tilt position is obtained when the contact point is on the pinna. See Figure 12.3.1. If contact occurs at any location other than the pinna, e.g., the antenna at the back of the phantom head, the angle of the handset should be reduced. In this case, the tilt position is obtained if any point on the handset is in contact with the pinna and a second point

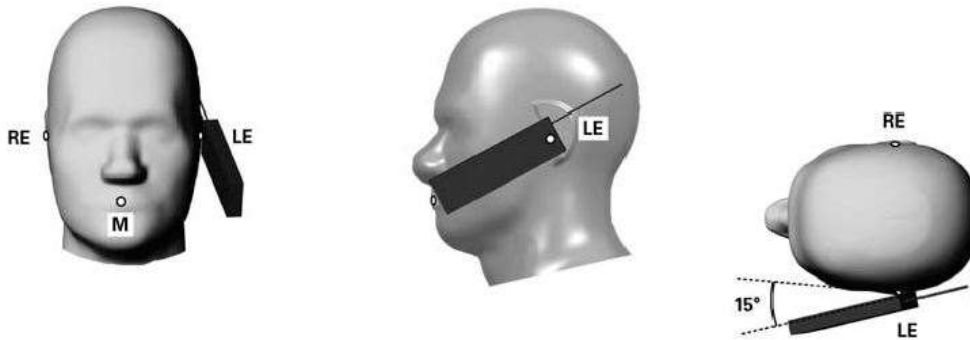

Fig 12.3.1 Tilt position. The reference points for the right ear (RE), left ear (LE), and mouth (M), which define the Reference Plane for handset positioning, are indicated.

## 12.4 Body Worn Accessory

Body-worn operating configurations are tested with the belt-clips and holsters attached to the device and positioned against a flat phantom in a normal use configuration (see Figure 12.4). Per KDB648474 D04v01r03, body-worn accessory exposure is typically related to voice mode operations when handsets are carried in body-worn accessories. The body-worn accessory procedures in FCC KDB 447498 D01v06 should be used to test for body-worn accessory SAR compliance, without a headset connected to it. This enables the test results for such configuration to be compatible with that required for hotspot mode when the body-worn accessory test separation distance is greater than or equal to that required for hotspot mode, when applicable. When the reported SAR for body-worn accessory, measured without a headset connected to the handset is  $> 1.2$  W/kg, the highest reported SAR configuration for that wireless mode and frequency band should be repeated for that body-worn accessory with a headset attached to the handset.

Accessories for body-worn operation configurations are divided into two categories: those that do not contain metallic components and those that do contain metallic components. When multiple accessories that do not contain metallic components are supplied with the device, the device is tested with only the accessory that dictates the closest spacing to the body. Then multiple accessories that contain metallic components are tested with the device with each accessory. If multiple accessories share an identical metallic component (i.e. the same metallic belt-chip used with different holsters with no other metallic components) only the accessory that dictates the closest spacing to the body is tested.

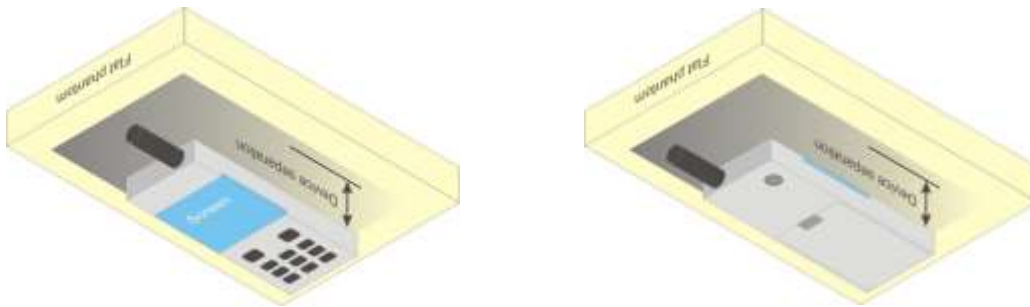

Fig 12.4 Body Worn Position





### **12.5 Product Specific 10g SAR Exposure**

For smart phones with a display diagonal dimension > 15.0 cm or an overall diagonal dimension > 16.0 cm that provide similar mobile web access and multimedia support found in mini-tablets or UMPC mini-tablets that support voice calls next to the ear, According to KDB648474 D04v01r03, the following phablet procedures should be applied to evaluate SAR compliance for each applicable wireless modes and frequency band. Devices marketed as phablets, regardless of form factors and operating characteristics must be tested as a phablet to determine SAR compliance

1. The normally required head and body-worn accessory SAR test procedures for handsets, including hotspot mode, must be applied.
2. The UMPC mini-tablet procedures must also be applied to test the SAR of all surfaces and edges with an antenna located at  $\leq 25$  mm from that surface or edge, in direct contact with a flat phantom, for 10-g extremity SAR according to the body-equivalent tissue dielectric parameters in KDB 865664 to address interactive hand use exposure conditions.6 The UMPC mini-tablet 1-g SAR at 5 mm is not required. When hotspot mode applies, 10-g extremity SAR is required only for the surfaces and edges with hotspot mode 1-g reported SAR > 1.2 W/kg.

### **12.6 Wireless Router**

Some battery-operated handsets have the capability to transmit and receive user through simultaneous transmission of WIFI simultaneously with a separate licensed transmitter. The FCC has provided guidance in FCC KDB Publication 941225 D06 v02r01 where SAR test considerations for handsets ( $L \times W \geq 9$  cm x 5 cm) are based on a composite test separation distance of 10mm from the front, back and edges of the device containing transmitting antennas within 2.5cm of their edges, determined from general mixed use conditions for this type of devices. Since the hotspot SAR results may overlap with the body-worn accessory SAR requirements, the more conservative configurations can be considered, thus excluding some body-worn accessory SAR tests.

When the user enables the personal wireless router functions for the handset, actual operations include simultaneous transmission of both the WIFI transmitter and another licensed transmitter. Both transmitters often do not transmit at the same transmitting frequency and thus cannot be evaluated for SAR under actual use conditions due to the limitations of the SAR assessment probes. Therefore, SAR must be evaluated for each frequency transmission and mode separately and spatially summed with the WIFI transmitter according to FCC KDB Publication 447498 D01v06 publication procedures. The "Portable Hotspot" feature on the handset was NOT activated during SAR assessments, to ensure the SAR measurements were evaluated for a single transmission frequency RF signal at a time.





### 13. SAR Test Results

**General Note:**

1. Per KDB 447498 D01v06, the reported SAR is the measured SAR value adjusted for maximum tune-up tolerance.
  - a. Tune-up scaling Factor = tune-up limit power (mW) / EUT RF power (mW), where tune-up limit is the maximum rated power among all production units.
  - b. For SAR testing of WLAN signal with non-100% duty cycle, the measured SAR is scaled-up by the duty cycle scaling factor which is equal to "1/(duty cycle)"
  - c. For WWAN: Reported SAR(W/kg)= Measured SAR(W/kg)\*Tune-up Scaling Factor
  - d. For WLAN/Bluetooth: Reported SAR(W/kg)= Measured SAR(W/kg)\* Duty Cycle scaling factor \* Tune-up scaling factor
  - e. For TDD LTE SAR measurement, the duty cycle 1:1.59 (62.9 %) was used perform testing and considering the theoretical duty cycle of 63.3% for extended cyclic prefix in the uplink, and the theoretical duty cycle of 62.9% for normal cyclic prefix in uplink, a scaling factor of extended cyclic prefix  $63.3\%/62.9\% = 1.006$  is applied to scale-up the measured SAR result.  
The Reported TDD LTE SAR = measured SAR (W/kg)\* Tune-up Scaling Factor\* scaling factor for extended cyclic prefix.
2. Per KDB 447498 D01v06, for each exposure position, testing of other required channels within the operating mode of a frequency band is not required when the *reported* 1-g or 10-g SAR for the mid-band or highest output power channel is:
  - $\leq 0.8$  W/kg or 2.0 W/kg, for 1-g or 10-g respectively, when the transmission band is  $\leq 100$  MHz
  - $\leq 0.6$  W/kg or 1.5 W/kg, for 1-g or 10-g respectively, when the transmission band is between 100 MHz and 200 MHz
  - $\leq 0.4$  W/kg or 1.0 W/kg, for 1-g or 10-g respectively, when the transmission band is  $\geq 200$  MHz
3. Per KDB 865664 D01v01r04, for each frequency band, repeated SAR measurement is required when the measured SAR is  $\geq 0.8$ W/kg. Per KDB 865664 D01v01r04, if the extremity repeated SAR is necessary, the same procedures should be adapted for measurements according to extremity and occupational exposure limits by applying a factor of 2.5 for extremity exposure and a factor of 5 for occupational exposure to the corresponding SAR thresholds.
4. This is a variant report for M1903F10G, the change note could be referred to the product equality declaration which is exhibit separately. Based on the similarity between two models, only the worst case from original test report (Sporton Report Number FA931204) were verified for the differences.
5. The verified SAR is the worst case from original application, the SAR value is less than original, although reported SAR higher than 0.8W/Kg, no need to considering other remaining channel SAR testing.
6. For simultaneously transmission SAR analysis, SAR values only considered which we did perform SAR testing on FA931204-03, and other test results were leverage from the parent model which referred to the test report number FA931204.



**13.1 Head SAR**

**<GSM SAR>**

Plot No.	Band	Mode	Test Position	Antenna	Power Mode	Ch.	Freq. (MHz)	Average Power (dBm)	Tune-Up Limit (dBm)	Tune-up Scaling Factor	Power Drift (dB)	Measured 1g SAR (W/kg)	Reported 1g SAR (W/kg)
01	GSM 850	GPRS 4 Tx slots	Right Cheek	Top	Reduced	189	836.4	24.18	25.50	1.355	-0.02	0.567	<b>0.768</b>
02	GSM 1900	GPRS 4 Tx slots	Right Cheek	Top	Full	810	1909.8	23.40	25.00	1.445	-0.16	0.677	<b>0.979</b>

**<WCDMA SAR>**

Plot No.	Band	Mode	Test Position	Antenna	Power Mode	Ch.	Freq. (MHz)	Average Power (dBm)	Tune-Up Limit (dBm)	Tune-up Scaling Factor	Power Drift (dB)	Measured 1g SAR (W/kg)	Reported 1g SAR (W/kg)
03	WCDMA Band V	RMC 12.2Kbps	Right Cheek	Top	Reduced	4182	836.4	20.85	22.00	1.303	0.06	0.737	<b>0.960</b>
04	WCDMA Band IV	RMC 12.2Kbps	Right Cheek	Top	Reduced	1513	1752.6	20.22	21.50	1.343	0.05	0.807	<b>1.084</b>
05	WCDMA Band II	RMC 12.2Kbps	Right Cheek	Top	Reduced	9538	1907.6	20.60	21.50	1.230	-0.12	0.834	<b>1.026</b>

**<FDD LTE SAR>**

Plot No.	Band	BW (MHz)	Modulation	RB Size	RB Offset	Test Position	Antenna	Power Mode	Ch.	Freq. (MHz)	Average Power (dBm)	Tune-Up Limit (dBm)	Tune-up Scaling Factor	Power Drift (dB)	Measured 1g SAR (W/kg)	Reported 1g SAR (W/kg)
06	LTE Band 5	10M	QPSK	25	0	Right Cheek	Top	Reduced	20525	836.5	21.21	22.50	1.346	0.01	0.780	<b>1.050</b>
	LTE Band 5	10M	QPSK	1	0	Right Cheek	Bottom	Full	20525	836.5	22.82	24.00	1.312	0.01	0.213	0.279
07	LTE Band 4	20M	QPSK	100	0	Right Cheek	Top	Reduced	20175	1732.5	20.67	21.50	1.211	0.03	0.791	<b>0.958</b>
08	LTE Band 2	20M	QPSK	100	0	Right Cheek	Top	Reduced	18900	1880	19.93	21.00	1.279	-0.08	0.791	<b>1.012</b>
	LTE Band 2	20M	QPSK	1	0	Left Cheek	Bottom	Full	18900	1880	22.74	24.00	1.337	0.03	0.095	0.127
09	LTE Band 7	20M	QPSK	1	0	Right Cheek	Top	Reduced	21350	2560	17.94	19.50	1.432	0.07	0.824	<b>1.180</b>
	LTE Band 7	20M	QPSK	1	0	Right Cheek	Top	Reduced	20850	2510	17.99	19.50	1.416	0.07	0.777	1.100
	LTE Band 7	20M	QPSK	1	0	Right Cheek	Top	Reduced	21100	2535	18.10	19.50	1.380	-0.03	0.804	1.110
	LTE Band 7	20M	QPSK	1	0	Left Cheek	Bottom	Full	21100	2535	22.99	24.00	1.262	0.04	0.052	0.066

**<TDD LTE SAR>**

Plot No.	Band	BW (MHz)	Modulation	RB Size	RB Offset	Test Position	Antenna	Power Mode	Ch.	Freq. (MHz)	Average Power (dBm)	Tune-Up Limit (dBm)	Tune-up Scaling Factor	Duty Cycle %	Duty Cycle Scaling Factor	Power Drift (dB)	Measured 1g SAR (W/kg)	Reported 1g SAR (W/kg)
10	LTE Band 38	20M	QPSK	1	0	Right Cheek	Top	Reduced	38000	2595	19.72	21.00	1.343	62.9	1.006	0.11	0.699	<b>0.944</b>



<WLAN2.4GHz SAR>

Plot No.	Band	Mode	Test Position	Power Mode	Ch.	Freq. (MHz)	Average Power (dBm)	Tune-Up Limit (dBm)	Tune-up Scaling Factor	Duty Cycle %	Duty Cycle Scaling Factor	Power Drift (dB)	Measured 1g SAR (W/kg)	Reported 1g SAR (W/kg)
11	WLAN2.4GHz	802.11b 1Mbps	Left Tilted	Reduced	11	2462	16.77	17.50	1.183	100	1.000	0.08	0.529	<b>0.626</b>

<WLAN5GHz SAR>

Plot No.	Band	Mode	Test Position	Power Mode	Ch.	Freq. (MHz)	Average Power (dBm)	Tune-Up Limit (dBm)	Tune-up Scaling Factor	Duty Cycle %	Duty Cycle Scaling Factor	Power Drift (dB)	Measured 1g SAR (W/kg)	Reported 1g SAR (W/kg)
12	WLAN5.3GHz	802.11a 6Mbps	Left Cheek	Reduced	56	5280	15.82	16.00	1.042	97.95	1.021	-0.08	0.895	<b>0.952</b>
13	WLAN5.5GHz	802.11a 6Mbps	Left Cheek	Full	100	5500	18.86	19.50	1.159	97.95	1.021	-0.05	0.844	<b>0.999</b>
14	WLAN 5.8GHz	802.11a 6Mbps	Left Cheek	Reduced	161	5805	17.56	18.00	1.107	97.95	1.021	-0.14	0.723	<b>0.817</b>

<Bluetooth SAR>

Plot No.	Band	Mode	Test Position	Ch.	Freq. (MHz)	Average Power (dBm)	Tune-Up Limit (dBm)	Tune-up Scaling Factor	Duty Cycle %	Duty Cycle Scaling Factor	Power Drift (dB)	Measured 1g SAR (W/kg)	Reported 1g SAR (W/kg)
15	Bluetooth	1Mbps	Left Tilted	78	2480	11.61	12.00	1.094	76.94	1.083	-0.02	0.130	<b>0.154</b>



**13.2 Hotspot SAR**

**<GSM SAR>**

Plot No.	Band	Mode	Test Position	Gap (mm)	Antenna	Power Mode	Ch.	Freq. (MHz)	Average Power (dBm)	Tune-Up Limit (dBm)	Tune-up Scaling Factor	Power Drift (dB)	Measured 1g SAR (W/kg)	Reported 1g SAR (W/kg)
16	GSM850	GPRS 4 Tx slots	Back	10	Bottom	Full	189	836.4	26.20	27.50	1.349	-0.05	0.263	<b>0.355</b>
17	GSM1900	GPRS 4 Tx slots	Bottom Side	10	Bottom	Reduced	810	1909.8	22.41	24.00	1.442	0.03	0.682	<b>0.984</b>

**<WCDMA SAR>**

Plot No.	Band	Mode	Test Position	Gap (mm)	Antenna	Power Mode	Ch.	Freq. (MHz)	Average Power (dBm)	Tune-Up Limit (dBm)	Tune-up Scaling Factor	Power Drift (dB)	Measured 1g SAR (W/kg)	Reported 1g SAR (W/kg)
18	WCDMA Band V	RMC 12.2Kbps	Back	10	Bottom	Full	4182	836.4	23.99	25.00	1.262	0.01	0.412	<b>0.520</b>
19	WCDMA Band IV	RMC 12.2Kbps	Bottom Side	10	Bottom	Reduced	1413	1732.6	18.33	19.50	1.309	-0.09	0.695	<b>0.910</b>
20	WCDMA Band II	RMC 12.2Kbps	Bottom Side	10	Bottom	Reduced	9262	1852.4	18.20	19.00	1.202	-0.01	0.614	<b>0.738</b>

**<FDD LTE SAR>**

Plot No.	Band	BW (MHz)	Modulation	RB Size	RB Offset	Test Position	Gap (mm)	Antenna	Power Mode	Ch.	Freq. (MHz)	Average Power (dBm)	Tune-Up Limit (dBm)	Tune-up Scaling Factor	Power Drift (dB)	Measured 1g SAR (W/kg)	Reported 1g SAR (W/kg)
	LTE Band 5	10M	QPSK	1	0	Back	10	Top	Reduced	20525	836.5	21.45	22.50	1.274	-0.13	0.237	0.302
21	LTE Band 5	10M	QPSK	1	0	Right Side	10	Bottom	Full	20525	836.5	22.82	24.00	1.312	-0.02	0.336	<b>0.441</b>
22	LTE Band 4	20M	QPSK	50	0	Bottom Side	10	Bottom	Reduced	20175	1732.5	18.75	20.00	1.334	0.03	0.754	<b>1.005</b>
	LTE Band 2	20M	QPSK	50	0	Left Side	10	Top	Reduced	18900	1880	19.97	21.00	1.268	-0.06	0.311	0.394
23	LTE Band 2	20M	QPSK	50	0	Bottom Side	10	Bottom	Reduced	18700	1860	18.26	19.50	1.330	0.01	0.701	<b>0.933</b>
	LTE Band 7	20M	QPSK	1	0	Left Side	10	Top	Reduced	21100	2535	18.10	19.50	1.380	-0.06	0.381	0.526
24	LTE Band 7	20M	QPSK	100	0	Bottom Side	10	Bottom	Reduced	21100	2535	20.45	21.50	1.274	0.06	0.696	<b>0.886</b>

**<TDD LTE SAR>**

Plot No.	Band	BW (MHz)	Modulation	RB Size	RB Offset	Test Position	Gap (mm)	Antenna	Power Mode	Ch.	Freq. (MHz)	Average Power (dBm)	Tune-Up Limit (dBm)	Tune-up Scaling Factor	Duty Cycle %	Duty Cycle Scaling Factor	Power Drift (dB)	Measured 1g SAR (W/kg)	Reported 1g SAR (W/kg)
25	LTE Band 38	20M	QPSK	1	0	Bottom Side	10	Bottom	Full	38000	2595	23.09	24.00	1.233	62.9	1.006	0.01	0.894	<b>1.109</b>



<WLAN 2.4GHz SAR>

Plot No.	Band	Mode	Test Position	Gap (mm)	Power Mode	Ch.	Freq. (MHz)	Average Power (dBm)	Tune-Up Limit (dBm)	Tune-up Scaling Factor	Duty Cycle %	Duty Cycle Scaling Factor	Power Drift (dB)	Measured 1g SAR (W/kg)	Reported 1g SAR (W/kg)
26	WLAN 2.4GHz	802.11b 1Mbps	Top Side	10	Reduced	11	2462	16.77	17.50	1.183	100	1.000	0.05	0.215	0.254

<WLAN 5GHz SAR>

Plot No.	Band	Mode	Test Position	Gap (mm)	Power Mode	Ch.	Freq. (MHz)	Average Power (dBm)	Tune-Up Limit (dBm)	Tune-up Scaling Factor	Duty Cycle %	Duty Cycle Scaling Factor	Power Drift (dB)	Measured 1g SAR (W/kg)	Reported 1g SAR (W/kg)
27	WLAN5.2GHz	802.11a 6Mbps	Back	10	Reduced	44	5220	15.87	16.00	1.030	97.95	1.021	-0.03	0.191	0.201
28	WLAN5.8GHz	802.11a 6Mbps	Back	10	Reduced	161	5805	17.56	18.00	1.107	97.95	1.021	0.03	0.617	0.697

<Bluetooth SAR>

Plot No.	Band	Mode	Test Position	Gap (mm)	Ch.	Freq. (MHz)	Average Power (dBm)	Tune-Up Limit (dBm)	Tune-up Scaling Factor	Duty Cycle %	Duty Cycle Scaling Factor	Power Drift (dB)	Measured 1g SAR (W/kg)	Reported 1g SAR (W/kg)
29	Bluetooth	1Mbps	Top Side	10	78	2480	11.61	12.00	1.094	76.94	1.083	0.04	0.048	0.057



**13.3 Body Worn Accessory SAR**

**<GSM SAR>**

Plot No.	Band	Mode	Test Position	Gap (mm)	Antenna	Power Reduced	Ch.	Freq. (MHz)	Average Power (dBm)	Tune-Up Limit (dBm)	Tune-up Scaling Factor	Power Drift (dB)	Measured 1g SAR (W/kg)	Reported 1g SAR (W/kg)
30	GSM850	GPRS 4 Tx slots	Back	15	Bottom	Full	189	836.4	26.20	27.50	1.349	-0.01	0.196	<b>0.264</b>
31	GSM1900	GPRS 4 Tx slots	Back	15	Bottom	Full	661	1880	23.41	25.00	1.442	0.1	0.184	<b>0.265</b>

**<WCDMA SAR>**

Plot No.	Band	Mode	Test Position	Gap (mm)	Antenna	Power Reduced	Ch.	Freq. (MHz)	Average Power (dBm)	Tune-Up Limit (dBm)	Tune-up Scaling Factor	Power Drift (dB)	Measured 1g SAR (W/kg)	Reported 1g SAR (W/kg)
32	WCDMA Band V	RMC 12.2Kbps	Back	15	Bottom	Full	4182	836.4	23.99	25.00	1.262	0.02	0.248	<b>0.313</b>
33	WCDMA Band IV	RMC 12.2Kbps	Back	15	Bottom	Full	1513	1752.6	23.12	24.50	1.374	-0.05	0.631	<b>0.867</b>
34	WCDMA Band II	RMC 12.2Kbps	Back	15	Bottom	Full	9538	1907.6	23.87	25.00	1.297	-0.14	0.579	<b>0.751</b>

**<FDD LTE SAR>**

Plot No.	Band	BW (MHz)	Modulation	RB Size	RB Offset	Test Position	Gap (mm)	Antenna	Power Reduced	Ch.	Freq. (MHz)	Average Power (dBm)	Tune-Up Limit (dBm)	Tune-up Scaling Factor	Power Drift (dB)	Measured 1g SAR (W/kg)	Reported 1g SAR (W/kg)
	LTE Band 5	10M	QPSK	1	0	Back	15	Top	Full	20525	836.5	22.82	24.00	1.312	-0.08	0.145	0.190
35	LTE Band 5	10M	QPSK	1	0	Back	15	Bottom	Full	20525	836.5	22.82	24.00	1.312	0.01	0.252	<b>0.331</b>
36	LTE Band 4	20M	QPSK	1	0	Back	15	Bottom	Full	20175	1732.5	22.85	24.00	1.303	-0.15	0.502	<b>0.654</b>
	LTE Band 2	20M	QPSK	1	0	Back	15	Top	Full	18900	1880	22.74	24.00	1.337	-0.09	0.114	0.152
37	LTE Band 2	20M	QPSK	1	0	Back	15	Bottom	Full	18900	1880	22.74	24.00	1.337	-0.13	0.419	<b>0.560</b>
	LTE Band 7	20M	QPSK	1	0	Front	15	Top	Full	21100+20902	2535+2515.2	22.85	23.50	1.161	-0.11	0.220	0.256
38	LTE Band 7	20M	QPSK	1	0	Back	15	Bottom	Full	21100	2535	22.99	24.00	1.262	0.08	0.276	<b>0.348</b>

**<TDD LTE SAR>**

Plot No.	Band	BW (MHz)	Modulation	RB Size	RB Offset	Test Position	Gap (mm)	Antenna	Power Reduced	Ch.	Freq. (MHz)	Average Power (dBm)	Tune-Up Limit (dBm)	Tune-up Scaling Factor	Duty Cycle %	Duty Cycle Scaling Factor	Power Drift (dB)	Measured 1g SAR (W/kg)	Reported 1g SAR (W/kg)
39	LTE Band 38	20M	QPSK	1	0	Back	15	Bottom	Full	38000	2595	23.09	24.00	1.233	62.9	1.006	0.12	0.191	<b>0.237</b>

**<WLAN 2.4GHz SAR>**

Plot No.	Band	Mode	Test Position	Gap (mm)	Power Reduced	Ch.	Freq. (MHz)	Average Power (dBm)	Tune-Up Limit (dBm)	Tune-up Scaling Factor	Duty Cycle %	Duty Cycle Scaling Factor	Power Drift (dB)	Measured 1g SAR (W/kg)	Reported 1g SAR (W/kg)
40	WLAN 2.4GHz	802.11b 1Mbps	Back	15	Full	11	2462	20.93	21.50	1.140	100	1.000	-0.06	0.159	<b>0.181</b>

**<WLAN 5GHz SAR>**

Plot No.	Band	Mode	Test Position	Gap (mm)	Power Reduced Level	Ch.	Freq. (MHz)	Average Power (dBm)	Tune-Up Limit (dBm)	Tune-up Scaling Factor	Duty Cycle %	Duty Cycle Scaling Factor	Power Drift (dB)	Measured 1g SAR (W/kg)	Reported 1g SAR (W/kg)
41	WLAN5.3GHz	802.11a 6Mbps	Back	15	Full	56	5280	18.86	19.50	1.159	97.95	1.021	0.03	0.303	<b>0.358</b>
42	WLAN5.5GHz	802.11a 6Mbps	Back	15	Full	132	5660	18.75	19.50	1.189	97.95	1.021	-0.03	0.683	<b>0.829</b>
43	WLAN5.8GHz	802.11a 6Mbps	Back	15	Full	161	5805	18.79	19.50	1.178	97.95	1.021	0.02	0.460	<b>0.553</b>

**<Bluetooth SAR>**

Plot No.	Band	Mode	Test Position	Gap (mm)	Ch.	Freq. (MHz)	Average Power (dBm)	Tune-Up Limit (dBm)	Tune-up Scaling Factor	Duty Cycle %	Duty Cycle Scaling Factor	Power Drift (dB)	Measured 1g SAR (W/kg)	Reported 1g SAR (W/kg)
44	Bluetooth	1Mbps	Back	15	78	2480	11.61	12.00	1.094	76.94	1.083	0.05	0.013	<b>0.016</b>



**13.4 Product specific 10g SAR**

**<GSM SAR>**

Plot No.	Band	Mode	Test Position	Gap (mm)	Antenna	Power Mode	Ch.	Freq. (MHz)	Average Power (dBm)	Tune-Up Limit (dBm)	Tune-up Scaling Factor	Power Drift (dB)	Measured 10g SAR (W/kg)	Reported 10g SAR (W/kg)
45	GSM1900	GPRS 4 Tx slots	Bottom Side	0	Bottom	Full	661	1880	23.41	25.00	1.442	0.02	1.290	<b>1.860</b>

**<WCDMA SAR>**

Plot No.	Band	Mode	Test Position	Gap (mm)	Antenna	Power Mode	Ch.	Freq. (MHz)	Average Power (dBm)	Tune-Up Limit (dBm)	Tune-up Scaling Factor	Power Drift (dB)	Measured 10g SAR (W/kg)	Reported 10g SAR (W/kg)
	WCDMA Band IV	RMC 12.2Kbps	Bottom Side	0	Bottom	Reduced	1413	1732.6	21.31	22.50	1.315	-0.07	2.330	3.064
	WCDMA Band IV	RMC 12.2Kbps	Bottom Side	0	Bottom	Reduced	1513	1752.6	21.27	22.50	1.327	-0.02	2.290	3.040
46	WCDMA Band IV	RMC 12.2Kbps	Bottom Side	0	Bottom	Reduced	1312	1712.4	21.26	22.50	1.330	-0.03	2.340	<b>3.113</b>
	WCDMA Band II	RMC 12.2Kbps	Bottom Side	0	Bottom	Reduced	9400	1880	21.91	23.00	1.285	-0.09	2.540	3.265
	WCDMA Band II	RMC 12.2Kbps	Bottom Side	0	Bottom	Reduced	9262	1852.4	21.85	23.00	1.303	-0.01	2.440	3.180
47	WCDMA Band II	RMC 12.2Kbps	Bottom Side	0	Bottom	Reduced	9538	1907.6	21.84	23.00	1.306	-0.06	2.520	<b>3.292</b>

**<FDD LTE SAR>**

Plot No.	Band	BW (MHz)	Modulation	RB Size	RB Offset	Test Position	Gap (mm)	Antenna	Power Mode	Ch.	Freq. (MHz)	Average Power (dBm)	Tune-Up Limit (dBm)	Tune-up Scaling Factor	Power Drift (dB)	Measured 10g SAR (W/kg)	Reported 10g SAR (W/kg)
48	LTE Band 4	20M	QPSK	50	0	Back	0	Bottom	Reduced	20175	1732.5	21.86	23.00	1.300	-0.04	2.030	<b>2.639</b>
	LTE Band 2	20M	QPSK	50	0	Bottom Side	0	Bottom	Reduced	18900	1880	21.82	23.00	1.312	0.06	2.130	2.795
	LTE Band 2	20M	QPSK	50	0	Bottom Side	0	Bottom	Reduced	18700	1860	21.71	23.00	1.346	0.03	2.080	2.799
49	LTE Band 2	20M	QPSK	50	0	Bottom Side	0	Bottom	Reduced	19100	1900	21.73	23.00	1.340	0.01	2.150	<b>2.880</b>

**<WLAN 5GHz SAR>**

Plot No.	Band	Mode	Test Position	Gap (mm)	Power Mode	Ch.	Freq. (MHz)	Average Power (dBm)	Tune-Up Limit (dBm)	Tune-up Scaling Factor	Duty Cycle %	Duty Cycle Scaling Factor	Power Drift (dB)	Measured 10g SAR (W/kg)	Reported 10g SAR (W/kg)
50	WLAN5.3GHz	802.11a 6Mbps	Back	0	Full	56	5280	18.86	19.50	1.159	97.95	1.021	-0.02	0.847	<b>1.002</b>
51	WLAN5.5GHz	802.11a 6Mbps	Back	0	Full	100	5500	18.86	19.50	1.159	97.95	1.021	0.03	1.530	<b>1.810</b>



**13.5 Repeated SAR Measurement**

**<1g SAR>**

No.	Band	Mode	BW (MHz)	Modulation	RB Size	RB Offset	Test Position	Gap (mm)	Antenna	Power Mode	Ch.	Freq. (MHz)	Average Power (dBm)	Tune-Up Limit (dBm)	Tune-up Scaling Factor	Duty Cycle %	Duty Cycle Scaling Factor	Power Drift (dB)	Measured 1g SAR (W/kg)	Ratio	Reported 1g SAR (W/kg)
1st	WCDMA Band IV	RMC 12.2Kbps	-	-	-	-	Right Cheek	0	Top	Reduced	1513	1752.6	20.22	21.50	1.343	-	-	0.05	0.807	1	1.084
2nd	WCDMA Band IV	RMC 12.2Kbps	-	-	-	-	Right Cheek	0	Top	Reduced	1513	1752.6	20.22	21.50	1.343	-	-	-0.02	0.802	1.006	1.077
1st	WCDMA Band II	RMC 12.2Kbps	-	-	-	-	Right Cheek	0	Top	Reduced	9538	1907.6	20.60	21.50	1.230	-	-	-0.12	0.834	1	1.026
2nd	WCDMA Band II	RMC 12.2Kbps	-	-	-	-	Right Cheek	0	Top	Reduced	9538	1907.6	20.60	21.50	1.230	-	-	0.08	0.811	1.028	0.998
1st	WLAN5.3GHz	802.11a 6Mbps	-	-	-	-	Left Cheek	0	-	Reduced	56	5280	15.82	16.00	1.042	97.95	1.021	-0.08	0.895	1	0.952
2nd	WLAN5.3GHz	802.11a 6Mbps	-	-	-	-	Left Cheek	0	-	Reduced	56	5280	15.82	16.00	1.042	97.95	1.021	0.05	0.871	1.028	0.927
1st	LTE Band 38	-	20M	QPSK	1	0	Bottom Side	10	Bottom	Full	38000	2595	23.09	24.00	1.233	62.9	1.006	0.01	0.894	1	1.109
2nd	LTE Band 38	-	20M	QPSK	1	0	Bottom Side	10	Bottom	Full	38000	2595	23.09	24.00	1.233	62.9	1.006	-0.09	0.866	1.032	1.074

**<10g SAR>**

No.	Band	Mode	BW (MHz)	Modulation	RB Size	RB Offset	Test Position	Gap (mm)	Antenna	Power Mode	Ch.	Freq. (MHz)	Average Power (dBm)	Tune-Up Limit (dBm)	Tune-up Scaling Factor	Duty Cycle %	Duty Cycle Scaling Factor	Power Drift (dB)	Measured 10g SAR (W/kg)	Ratio	Reported 10g SAR (W/kg)
1st	WCDMA Band IV	RMC 12.2Kbps	-	-	-	-	Bottom Side	0	Bottom	Reduced	1312	1712.4	21.26	22.50	1.330	-	-	-0.03	2.340	1	3.113
2nd	WCDMA Band IV	RMC 12.2Kbps	-	-	-	-	Bottom Side	0	Bottom	Reduced	1312	1712.4	21.26	22.50	1.330	-	-	0.04	2.290	1.022	3.047
1st	WCDMA Band II	RMC 12.2Kbps	-	-	-	-	Bottom Side	0	Bottom	Reduced	9400	1880	21.91	23.00	1.285	-	-	-0.09	2.540	1	3.265
2nd	WCDMA Band II	RMC 12.2Kbps	-	-	-	-	Bottom Side	0	Bottom	Reduced	9400	1880	21.91	23.00	1.285	-	-	0.03	2.490	1.020	3.200

**General Note:**

1. Per KDB 865664 D01v01r04, for each frequency band, repeated SAR measurement is required only when the measured SAR is  $\geq 0.8W/kg$ .
2. Per KDB 865664 D01v01r04, if the ratio among the repeated measurement is  $\leq 1.2$  and the measured SAR  $< 1.45W/kg$ , only one repeated measurement is required.
3. Per KDB 865664 D01v01r04, if the extremity repeated SAR is necessary, the same procedures should be adapted for measurements according to extremity and occupational exposure limits by applying a factor of 2.5 for extremity exposure and a factor of 5 for occupational exposure to the corresponding SAR thresholds.
4. The ratio is the difference in percentage between original and repeated *measured* SAR.
5. All measurement SAR result is scaled-up to account for tune-up tolerance and is compliant.



**14. Simultaneous Transmission Analysis**

No.	Simultaneous Transmission Configurations	Portable Handset		
		Head	Body-worn	Hotspot
1.	GSM Voice + WLAN2.4GHz	Yes	Yes	
2.	GPRS/EDGE + WLAN2.4GHz	Yes	Yes	Yes
3.	WCDMA + WLAN2.4GHz	Yes	Yes	Yes
4.	CDMA + WLAN2.4GHz	Yes	Yes	Yes
5.	LTE + WLAN2.4GHz	Yes	Yes	Yes
6.	GSM Voice + WLAN5.3/5.5GHz	Yes	Yes	
7.	GPRS/EDGE + WLAN5.3/5.5GHz	Yes	Yes	
8.	WCDMA + WLAN5.3/5.5GHz	Yes	Yes	
9.	CDMA + WLAN5.3/5.5GHz	Yes	Yes	
10.	LTE + WLAN5.3/5.5GHz	Yes	Yes	
11.	GSM Voice + WLAN5.2/5.8GHz	Yes	Yes	
12.	GPRS/EDGE + WLAN5.2/5.8GHz	Yes	Yes	Yes
13.	WCDMA + WLAN5.2/5.8GHz	Yes	Yes	Yes
14.	CDMA + WLAN5.2/5.8GHz	Yes	Yes	Yes
15.	LTE + WLAN5.2/5.8GHz	Yes	Yes	Yes
16.	GSM Voice + Bluetooth	Yes	Yes	
17.	GPRS/EDGE + Bluetooth	Yes	Yes	Yes
18.	WCDMA + Bluetooth	Yes	Yes	Yes
19.	CDMA + Bluetooth	Yes	Yes	Yes
20.	LTE + Bluetooth	Yes	Yes	Yes
21.	Bluetooth + WLAN5GHz	Yes	Yes	Yes
22.	GSM Voice + Bluetooth + WLAN5.3/5.5GHz	Yes	Yes	
23.	GPRS/EDGE + Bluetooth + WLAN5.3/5.5GHz	Yes	Yes	
24.	WCDMA + Bluetooth + WLAN5.3/5.5GHz	Yes	Yes	
25.	CDMA + Bluetooth + WLAN5.3/5.5GHz	Yes	Yes	
26.	LTE + Bluetooth + WLAN5.3/5.5GHz	Yes	Yes	
27.	GSM Voice + Bluetooth + WLAN5.2/5.8GHz	Yes	Yes	
28.	GPRS/EDGE + Bluetooth + WLAN5.2/5.8GHz	Yes	Yes	Yes
29.	WCDMA + Bluetooth + WLAN5.2/5.8GHz	Yes	Yes	Yes
30.	CDMA + Bluetooth + WLAN5.2/5.8GHz	Yes	Yes	Yes
31.	LTE + Bluetooth + WLAN5.2/5.8GHz	Yes	Yes	Yes

**General Note:**

1. For simultaneously transmission SAR analysis, SAR values only considered which we did perform SAR testing on FA931204-03, and other test results were leverage from the parent model which referred to the test report number FA931204.
2. This device supports VoIP in GPRS, EGPRS, CDMA, WCDMA and LTE (e.g. for 3rd-party VoIP), LTE supports VoLTE operation.
3. EUT will choose each GSM, WCDMA, CDMA and LTE according to the network signal condition; therefore, they will not operate simultaneously at any moment.
4. WLAN2.4GHz antenna and Bluetooth share the same antenna, so can't transmit simultaneously.
5. This device 2.4GHz WLAN support hotspot operation and Bluetooth support tethering applications.
6. This device 2.4GHz WLAN/ 5.2GHz WLAN/5.8GHz WLAN support hotspot operation, and 5.2GHz WLAN/5.8GHz WLAN supports WLAN Direct (GC/GO), and 5.3GHz / 5.5GHz supports WLAN Direct (GC only).
7. The worst case 5 GHz WLAN SAR for each configuration was used for SAR summation.
8. For simultaneously analysis, since the SAR summation of 3 transmitters can cover others combination of 2 transmitters, therefore in this section did not additional to evaluate 2TX combination of simultaneously transmission.
9. The reported SAR summation is calculated based on the same configuration and test position.
10. Per KDB 447498 D01v06, simultaneous transmission SAR is compliant if,
  - i) 1g Scalar SAR summation < 1.6W/kg and 10g Scalar SAR summation < 4.0W/kg.
  - ii)  $SPLSR = (SAR1 + SAR2)^{1.5} / (\text{min. separation distance, mm})$ , and the peak separation distance is determined from the square root of  $[(x1-x2)^2 + (y1-y2)^2 + (z1-z2)^2]$ , where (x1, y1, z1) and (x2, y2, z2) are the coordinates of the extrapolated peak SAR locations in the zoom scan.
  - iii) If  $SPLSR \leq 0.04$  for 1g SAR,  $SPLSR \leq 0.10$  for 10g SAR simultaneously transmission SAR measurement is not necessary.
  - iv) Simultaneously transmission SAR measurement, and the reported multi-band 1g SAR < 1.6W/kg and 10g SAR < 4.0W/kg.
  - v) For WWAN/Bluetooth product specific 10g stand-alone SAR is not required for a transmitter or antenna, due to 1g hotspot SAR is <1.2W/kg.



**14.1 Head Exposure Conditions**

<Top Antenna >

WWAN Band		Exposure Position	1	2	3	4	1+2 Summed 1g SAR (W/kg)	1+3+4 Summed 1g SAR (W/kg)
			WWAN	2.4GHz WLAN	5GHz WLAN	Bluetooth		
			1g SAR (W/kg)	1g SAR (W/kg)	1g SAR (W/kg)	1g SAR (W/kg)		
GSM	GSM850	Right Cheek	0.768	0.340	0.252	0.102	1.11	1.12
		Left Cheek	0.367	0.530	0.999	0.128	0.90	1.49
		Left Tilted	0.356	0.626	0.797	0.154	0.98	1.31
	GSM1900	Right Cheek	0.979	0.340	0.252	0.102	1.32	1.33
		Left Cheek	0.277	0.530	0.999	0.128	0.81	1.40
		Left Tilted	0.211	0.626	0.797	0.154	0.84	1.16
WCDMA	Band V	Right Cheek	0.960	0.340	0.252	0.102	1.30	1.31
		Left Cheek	0.371	0.530	0.999	0.128	0.90	1.50
		Left Tilted	0.263	0.626	0.797	0.154	0.89	1.21
	Band IV	Right Cheek	1.084	0.340	0.252	0.102	1.42	1.44
		Left Cheek	0.325	0.530	0.999	0.128	0.86	1.45
		Left Tilted	0.256	0.626	0.797	0.154	0.88	1.21
	Band II	Right Cheek	1.026	0.340	0.252	0.102	1.37	1.38
		Left Cheek	0.288	0.530	0.999	0.128	0.82	1.42
		Left Tilted	0.218	0.626	0.797	0.154	0.84	1.17
LTE	Band 5	Right Cheek	1.050	0.340	0.252	0.102	1.39	1.40
		Left Cheek	0.332	0.530	0.999	0.128	0.86	1.46
		Left Tilted	0.306	0.626	0.797	0.154	0.93	1.26
	Band 4	Right Cheek	0.958	0.340	0.252	0.102	1.30	1.31
		Left Cheek	0.308	0.530	0.999	0.128	0.84	1.44
		Left Tilted	0.235	0.626	0.797	0.154	0.86	1.19
	Band 2	Right Cheek	1.012	0.340	0.252	0.102	1.35	1.37
		Left Cheek	0.264	0.530	0.999	0.128	0.79	1.39
		Left Tilted	0.213	0.626	0.797	0.154	0.84	1.16
	Band 7	Right Cheek	1.180	0.340	0.252	0.102	1.52	1.53
		Left Cheek	0.369	0.530	0.999	0.128	0.90	1.50
		Left Tilted	0.184	0.626	0.797	0.154	0.81	1.14
	Band 38	Right Cheek	0.944	0.340	0.252	0.102	1.28	1.30
		Left Cheek	0.366	0.530	0.999	0.128	0.90	1.49
		Left Tilted	0.168	0.626	0.797	0.154	0.79	1.12



**<Bottom Antenna >**

WWAN Band		Exposure Position	1	2	3	4	1+2 Summed 1g SAR (W/kg)	1+3+4 Summed 1g SAR (W/kg)
			WWAN	2.4GHz WLAN	5GHz WLAN	Bluetooth		
			1g SAR (W/kg)	1g SAR (W/kg)	1g SAR (W/kg)	1g SAR (W/kg)		
LTE	Band 5	Right Cheek	0.279	0.340	0.252	0.102	0.62	0.63
		Left Cheek	0.205	0.530	0.999	0.128	0.74	1.33
		Left Tilted	0.131	0.626	0.797	0.154	0.76	1.08
	Band 2	Left Cheek	0.127	0.530	0.999	0.128	0.66	1.25
		Left Tilted	0.049	0.626	0.797	0.154	0.68	1.00
	Band 7	Left Cheek	0.066	0.530	0.999	0.128	0.60	1.19
		Left Tilted	0.077	0.626	0.797	0.154	0.70	1.03



**14.2 Hotspot Exposure Conditions**

<Top Antenna >

WWAN Band		Exposure Position	1	2	3	4	1+2 Summed 1g SAR (W/kg)	1+3+4 Summed 1g SAR (W/kg)
			WWAN	2.4GHz WLAN	5GHz WLAN	Bluetooth		
			1g SAR (W/kg)	1g SAR (W/kg)	1g SAR (W/kg)	1g SAR (W/kg)		
LTE	Band 5	Back	0.302	0.137	0.697	0.048	0.44	1.05
		Top side	0.196	0.254	0.317	0.057	0.45	0.57
	Band 2	Back	0.140	0.137	0.697	0.048	0.28	0.89
		Left side	0.394				0.39	0.39
		Top side	0.111	0.254	0.317	0.057	0.37	0.49
	Band 7	Back	0.222	0.137	0.697	0.048	0.36	0.97
		Left side	0.526				0.53	0.53
		Top side	0.136	0.254	0.317	0.057	0.39	0.51



<Bottom Antenna>

WWAN Band		Exposure Position	1	2	3	4	1+2 Summed 1g SAR (W/kg)	1+3+4 Summed 1g SAR (W/kg)
			WWAN	2.4GHz WLAN	5GHz WLAN	Bluetooth		
			1g SAR (W/kg)	1g SAR (W/kg)	1g SAR (W/kg)	1g SAR (W/kg)		
GSM	GSM850	Back	0.355	0.137	0.697	0.048	0.49	1.10
		Top side		0.254	0.317	0.057	0.25	0.37
	GSM1900	Back	0.557	0.137	0.697	0.048	0.69	1.30
		Top side		0.254	0.317	0.057	0.25	0.37
		Bottom side	0.984				0.98	0.98
WCDMA	Band V	Back	0.520	0.137	0.697	0.048	0.66	1.27
		Top side		0.254	0.317	0.057	0.25	0.37
	Band IV	Back	0.535	0.137	0.697	0.048	0.67	1.28
		Top side		0.254	0.317	0.057	0.25	0.37
		Bottom side	0.910				0.91	0.91
	Band II	Back	0.360	0.137	0.697	0.048	0.50	1.11
		Top side		0.254	0.317	0.057	0.25	0.37
		Bottom side	0.738				0.74	0.74
	LTE	Band 5	Back	0.279	0.137	0.697	0.048	0.42
Right side			0.441	0.102	0.315	0.033	0.54	0.79
Top side				0.254	0.317	0.057	0.25	0.37
Band 4		Back	0.615	0.137	0.697	0.048	0.75	1.36
		Top side		0.254	0.317	0.057	0.25	0.37
		Bottom side	1.005				1.01	1.01
Band 2		Back	0.482	0.137	0.697	0.048	0.62	1.23
		Top side		0.254	0.317	0.057	0.25	0.37
		Bottom side	0.933				0.93	0.93
Band 7		Back	0.371	0.137	0.697	0.048	0.51	1.12
		Top side		0.254	0.317	0.057	0.25	0.37
		Bottom side	0.886				0.89	0.89
Band 38		Back	0.470	0.137	0.697	0.048	0.61	1.22
		Top side		0.254	0.317	0.057	0.25	0.37
		Bottom side	1.109				1.11	1.11



**14.3 Body-Worn Accessory Exposure Conditions**

**<Top Antenna>**

WWAN Band		Exposure Position	1	2	3	4	1+2 Summed 1g SAR (W/kg)	1+3+4 Summed 1g SAR (W/kg)
			WWAN 1g SAR (W/kg)	2.4GHz WLAN 1g SAR (W/kg)	5GHz WLAN 1g SAR (W/kg)	Bluetooth 1g SAR (W/kg)		
LTE	Band 5	Back	0.190	0.181	0.829	0.016	0.37	1.04
	Band 2	Back	0.152	0.181	0.829	0.016	0.33	1.00
	Band 7	Front	0.256	0.144	0.105	0.021	0.40	0.38

**<Bottom Antenna>**

WWAN Band		Exposure Position	1	2	3	4	1+2	1+3+4		
			WWAN 1g SAR (W/kg)	2.4GHz WLAN 1g SAR (W/kg)	5GHz WLAN 1g SAR (W/kg)	Bluetooth 1g SAR (W/kg)	Summed 1g SAR (W/kg)	Summed 1g SAR (W/kg)	SPLSR	Case No
GSM	GSM850	Back	0.264	0.181	0.829	0.016	0.45	1.11		
	GSM1900	Back	0.265	0.181	0.829	0.016	0.45	1.11		
WCDMA	Band V	Back	0.313	0.181	0.829	0.016	0.49	1.16		
	Band IV	Back	0.867	0.181	0.829	0.016	1.05	1.71**		
	Band II	Back	0.751	0.181	0.829	0.016	0.93	1.60**		
LTE	Band 5	Back	0.331	0.181	0.829	0.016	0.51	1.18		
	Band 4	Back	0.654	0.181	0.829	0.016	0.84	1.50		
	Band 2	Back	0.560	0.181	0.829	0.016	0.74	1.41		
	Band 7	Back	0.348	0.181	0.829	0.016	0.53	1.19		
	Band 38	Back	0.237	0.181	0.829	0.016	0.42	1.08		

Note: Above table "\*\*\*" means no need to do SPLSR analysis gain, for WCDMA band II/IV and 5G WLAN/Bluetooth verified SAR value for back side are all less than original application, original SPLSR analysis can represent more conservatively for this variant report.



14.4 Product specific 10g SAR Exposure Conditions

WWAN Band		Exposure Position	1	2	1+2		
			WWAN	5GHz WLAN	Summed 10g SAR (W/kg)	SPLSR	Case No
			10g SAR (W/kg)	10g SAR (W/kg)			
GSM	GSM1900	Bottom Side	1.860		1.86		
WCDMA	Band IV	Bottom Side	3.113		3.11		
	Band II	Bottom Side	3.292		3.29		
LTE	Band 4	Back	2.639	1.810	4.45**		
	Band 2	Bottom Side	2.880		2.88		

Remark:

- For Bluetooth Product specific 10g stand-alone SAR is not required for a transmitter or antenna, due to 1g hotspot SAR is <1.2W/kg.
- Above table "\*\*\*" means no need to do SPLSR analysis gain, for LTE band 4 and 5G WLAN verified SAR value for back side are all less than original application, original SPLSR analysis can represent more conservatively for this variant report.

Test Engineer : Nick Hu



## **15. Uncertainty Assessment**

Per KDB 865664 D01 SAR measurement 100MHz to 6GHz, when the highest measured 1-g SAR within a frequency band is  $< 1.5$  W/kg and the measured 10-g SAR within a frequency band is  $< 3.75$  W/kg. The expanded SAR measurement uncertainty must be  $\leq 30\%$ , for a confidence interval of  $k = 2$ . If these conditions are met, extensive SAR measurement uncertainty analysis described in IEEE Std 1528-2013 is not required in SAR reports submitted for equipment approval. For this device, the highest measured 1-g SAR is less 1.5W/kg and highest measured 10-g SAR is less 3.75W/kg. Therefore, the measurement uncertainty table is not required in this report.





## 16. References

- [1] FCC 47 CFR Part 2 "Frequency Allocations and Radio Treaty Matters; General Rules and Regulations"
- [2] ANSI/IEEE Std. C95.1-1992, "IEEE Standard for Safety Levels with Respect to Human Exposure to Radio Frequency Electromagnetic Fields, 3 kHz to 300 GHz", September 1992
- [3] IEEE Std. 1528-2013, "IEEE Recommended Practice for Determining the Peak Spatial-Average Specific Absorption Rate (SAR) in the Human Head from Wireless Communications Devices: Measurement Techniques", Sep 2013
- [4] SPEAG DASY System Handbook
- [5] FCC KDB 865664 D01 v01r04, "SAR Measurement Requirements for 100 MHz to 6 GHz", Aug 2015.
- [6] FCC KDB 865664 D02 v01r02, "RF Exposure Compliance Reporting and Documentation Considerations" Oct 2015.
- [7] FCC KDB 447498 D01 v06, "Mobile and Portable Device RF Exposure Procedures and Equipment Authorization Policies", Oct 2015
- [8] FCC KDB 648474 D04 v01r03, "SAR Evaluation Considerations for Wireless Handsets", Oct 2015.
- [9] FCC KDB 248227 D01 v02r02, "SAR Guidance for IEEE 802.11 (WiFi) Transmitters", Oct 2015.
- [10] FCC KDB 941225 D01 v03r01, "3G SAR MEAUREMENT PROCEDURES", Oct 2015
- [11] FCC KDB 941225 D05 v02r05, "SAR Evaluation Considerations for LTE Devices", Dec 2015
- [12] FCC KDB 941225 D05A v01r02, "Rel. 10 LTE SAR Test Guidance and KDB Inquiries", Oct 2015
- [13] FCC KDB 941225 D06 v02r01, "SAR Evaluation Procedures for Portable Devices with Wireless Router Capabilities", Oct 2015.
- [14] FCC KDB 616217 D04 v01r02, "SAR Evaluation Considerations for Laptop, Notebook, Netbook and Tablet Computers", Oct 2015



## **Appendix A. Plots of System Performance Check**

The plots are shown as follows.

### System Check\_Head\_835MHz

**DUT: D835V2 - SN:4d151**

Communication System: UID 0, CW; Frequency: 835 MHz; Duty Cycle: 1:1

Medium: HSL\_835 Medium parameters used:  $f = 835 \text{ MHz}$ ;  $\sigma = 0.904 \text{ S/m}$ ;  $\epsilon_r = 42.015$ ;  $\rho = 1000 \text{ kg/m}^3$

Ambient Temperature :  $23.3 \text{ }^\circ\text{C}$ ; Liquid Temperature :  $22.7 \text{ }^\circ\text{C}$

DASY5 Configuration:

- Probe: EX3DV4 - SN3843; ConvF(9.01, 9.01, 9.01); Calibrated: 2018.9.27
- Sensor-Surface: 1.4mm (Mechanical Surface Detection)
- Electronics: DAE4 Sn1279; Calibrated: 2018.10.22
- Phantom: SAM1; Type: SAM; Serial: TP-1839
- Measurement SW: DASY52, Version 52.10 (1); SEMCAD X Version 14.6.11 (7439)

**Pin=250mW/Area Scan (61x61x1):** Interpolated grid:  $dx=1.500 \text{ mm}$ ,  $dy=1.500 \text{ mm}$   
Maximum value of SAR (interpolated) =  $3.06 \text{ W/kg}$

**Pin=250mW/Zoom Scan (5x5x7)/Cube 0:** Measurement grid:  $dx=8\text{mm}$ ,  $dy=8\text{mm}$ ,  $dz=5\text{mm}$   
Reference Value =  $53.27 \text{ V/m}$ ; Power Drift =  $0.02 \text{ dB}$   
Peak SAR (extrapolated) =  $3.66 \text{ W/kg}$   
**SAR(1 g) =  $2.42 \text{ W/kg}$ ; SAR(10 g) =  $1.57 \text{ W/kg}$**   
Maximum value of SAR (measured) =  $3.09 \text{ W/kg}$

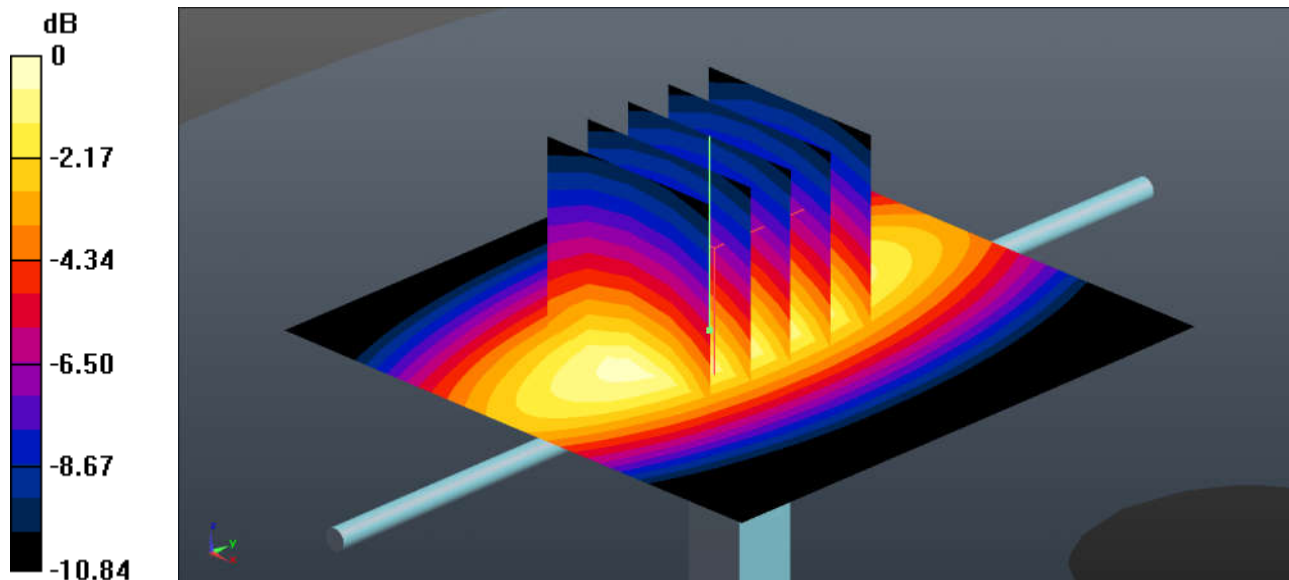

0 dB =  $3.09 \text{ W/kg}$  =  $4.90 \text{ dBW/kg}$

**System Check\_Head\_1750MHz**

**DUT: D1750V2 - SN:1090**

Communication System: UID 0, CW; Frequency: 1750 MHz; Duty Cycle: 1:1

Medium: HSL\_1750 Medium parameters used:  $f = 1750$  MHz;  $\sigma = 1.355$  S/m;  $\epsilon_r = 39.596$ ;  $\rho = 1000$  kg/m<sup>3</sup>

Ambient Temperature : 23.2 °C ; Liquid Temperature : 22.9 °C

DASY5 Configuration:

- Probe: EX3DV4 - SN3843; ConvF(7.79, 7.79, 7.79); Calibrated: 2018.9.27
- Sensor-Surface: 1.4mm (Mechanical Surface Detection)
- Electronics: DAE4 Sn1279; Calibrated: 2018.10.22
- Phantom: SAM2; Type: SAM; Serial: TP-1503
- Measurement SW: DASY52, Version 52.10 (1); SEMCAD X Version 14.6.11 (7439)

**Pin=250mW/Area Scan (61x61x1):** Interpolated grid: dx=1.500 mm, dy=1.500 mm

Maximum value of SAR (interpolated) = 13.3 W/kg

**Pin=250mW/Zoom Scan (5x5x7)/Cube 0:** Measurement grid: dx=8mm, dy=8mm, dz=5mm

Reference Value = 87.15 V/m; Power Drift = 0.04 dB

Peak SAR (extrapolated) = 16.7 W/kg

**SAR(1 g) = 9.27 W/kg; SAR(10 g) = 4.92 W/kg**

Maximum value of SAR (measured) = 13.1 W/kg

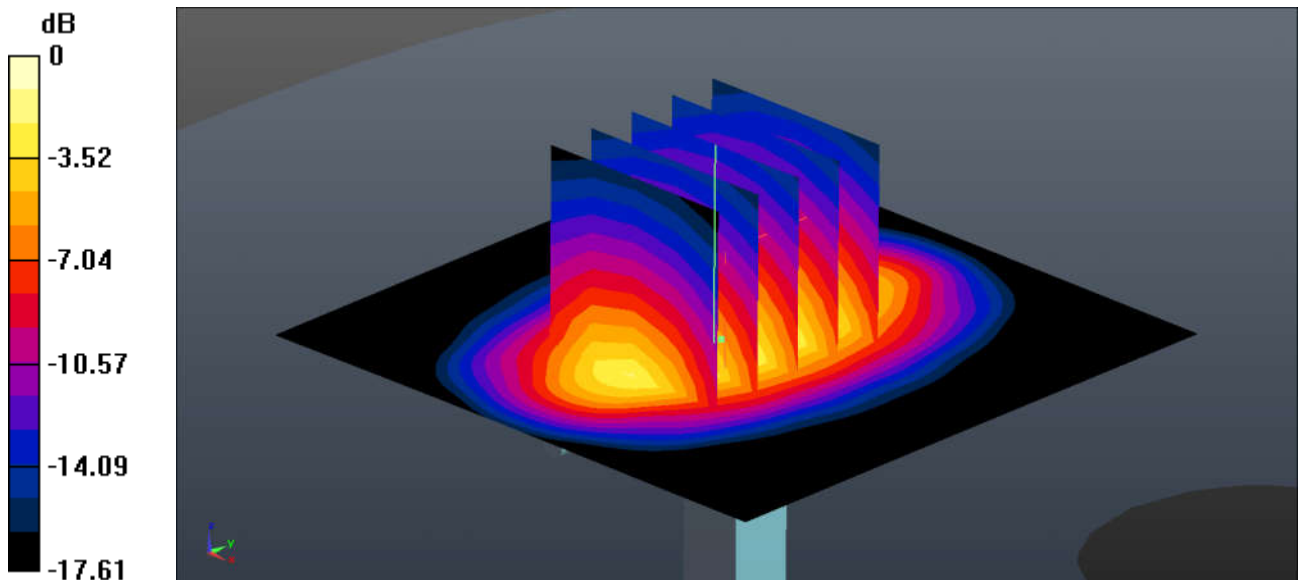

0 dB = 13.1 W/kg = 11.17 dBW/kg

### System Check\_Head\_1900MHz

**DUT: D1900V2 - SN:5d170**

Communication System: UID 0, CW; Frequency: 1900 MHz; Duty Cycle: 1:1

Medium: HSL\_1900 Medium parameters used:  $f = 1900$  MHz;  $\sigma = 1.402$  S/m;  $\epsilon_r = 39.391$ ;  $\rho = 1000$  kg/m<sup>3</sup>

Ambient Temperature : 23.4 °C ; Liquid Temperature : 22.6 °C

DASY5 Configuration:

- Probe: EX3DV4 - SN3843; ConvF(7.4, 7.4, 7.4); Calibrated: 2018.9.27
- Sensor-Surface: 1.4mm (Mechanical Surface Detection)
- Electronics: DAE4 Sn1279; Calibrated: 2018.10.22
- Phantom: SAM2; Type: SAM; Serial: TP-1503
- Measurement SW: DASY52, Version 52.10 (1); SEMCAD X Version 14.6.11 (7439)

**Pin=250mW/Area Scan (61x61x1):** Interpolated grid: dx=1.500 mm, dy=1.500 mm

Maximum value of SAR (interpolated) = 14.1 W/kg

**Pin=250mW/Zoom Scan (5x5x7)/Cube 0:** Measurement grid: dx=8mm,dy=8mm, dz=5mm

Reference Value = 87.87 V/m; Power Drift = 0.01 dB

Peak SAR (extrapolated) = 17.8 W/kg

**SAR(1 g) = 9.67 W/kg; SAR(10 g) = 5 W/kg**

Maximum value of SAR (measured) = 14.0 W/kg

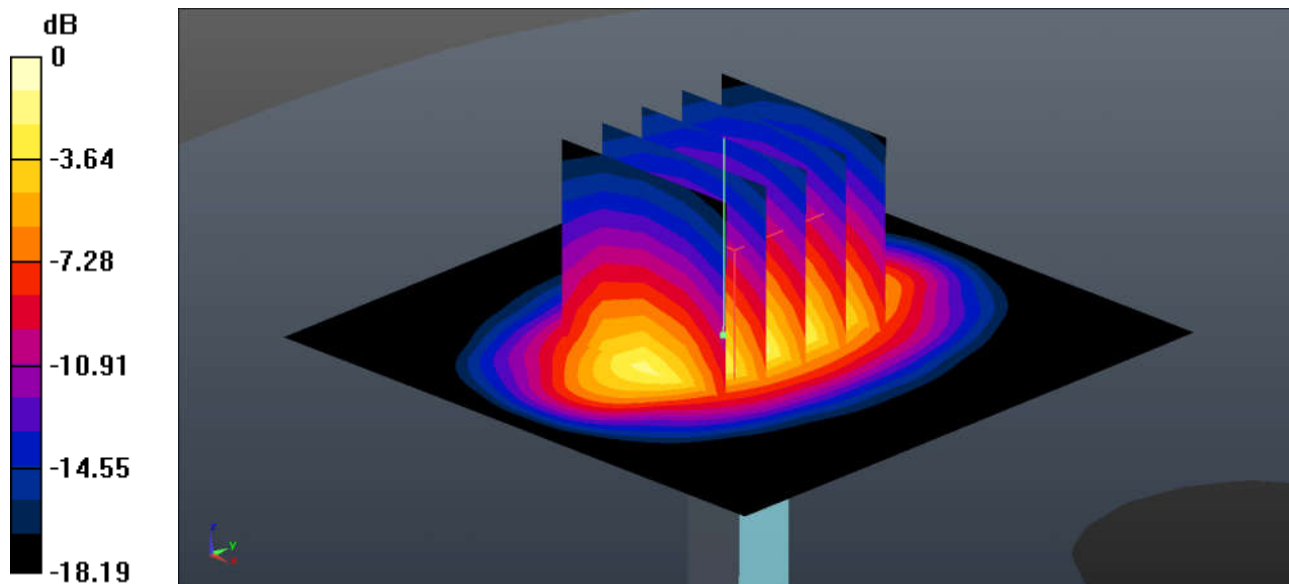

0 dB = 14.0 W/kg = 11.46 dBW/kg

### System Check\_Head\_2450MHz

**DUT: D2450V2 - SN:908**

Communication System: UID 0, CW (0); Frequency: 2450 MHz;Duty Cycle: 1:1  
Medium: HSL\_2450 Medium parameters used:  $f = 2450$  MHz;  $\sigma = 1.86$  S/m;  $\epsilon_r = 38.914$ ;  $\rho = 1000$  kg/m<sup>3</sup>  
Ambient Temperature : 23.3 °C ; Liquid Temperature : 22.9 °C

DASY5 Configuration:

- Probe: EX3DV4 - SN3843; ConvF(7.08, 7.08, 7.08); Calibrated: 2018.9.27
- Sensor-Surface: 1.4mm (Mechanical Surface Detection)
- Electronics: DAE4 Sn1279; Calibrated: 2018.10.22
- Phantom: SAM2; Type: SAM; Serial: TP-1503
- Measurement SW: DASY52, Version 52.10 (1); SEMCAD X Version 14.6.11 (7439)

**Pin=250mW/Area Scan (71x71x1):** Interpolated grid: dx=1.200 mm, dy=1.200 mm  
Maximum value of SAR (interpolated) = 21.2 W/kg

**Pin=250mW/Zoom Scan (7x7x7)/Cube 0:** Measurement grid: dx=5mm, dy=5mm, dz=5mm  
Reference Value = 87.74 V/m; Power Drift = 0.15 dB  
Peak SAR (extrapolated) = 28.6 W/kg  
**SAR(1 g) = 13.4 W/kg; SAR(10 g) = 6.15 W/kg**  
Maximum value of SAR (measured) = 20.9 W/kg

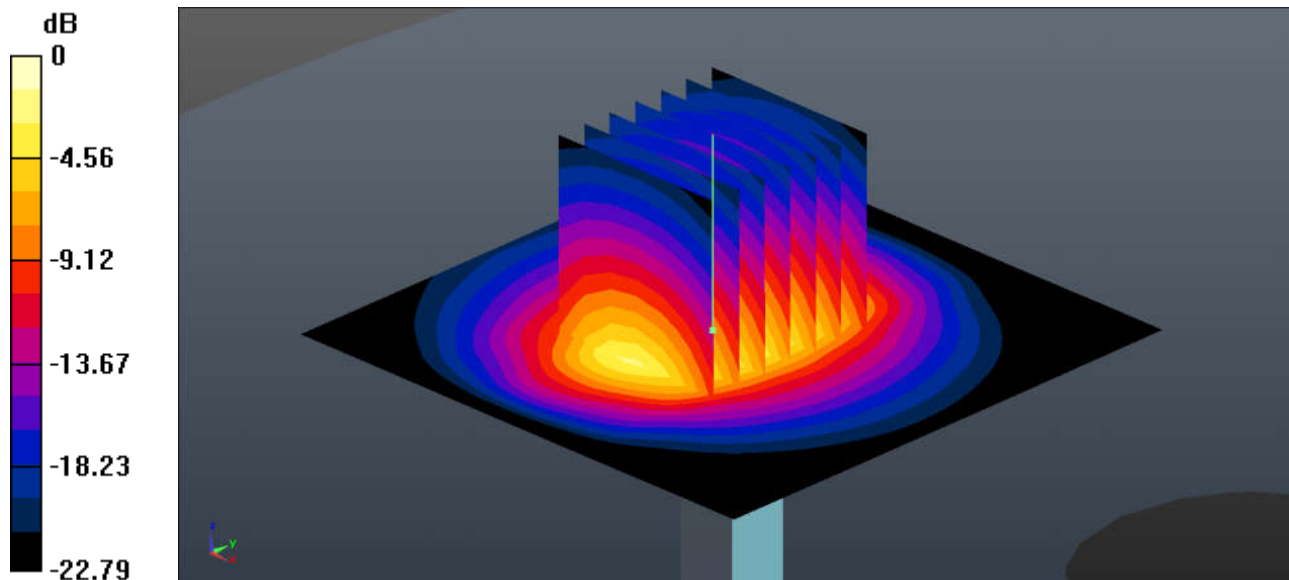

0 dB = 20.9 W/kg = 13.20 dBW/kg

### System Check\_Head\_2600MHz

**DUT: D2600V2 - SN:1061**

Communication System: UID 0, CW; Frequency: 2600 MHz; Duty Cycle: 1:1

Medium: HSL\_2600 Medium parameters used:  $f = 2600$  MHz;  $\sigma = 1.976$  S/m;  $\epsilon_r = 39.468$ ;  $\rho = 1000$  kg/m<sup>3</sup>

Ambient Temperature : 23.1 °C ; Liquid Temperature : 22.7 °C

DASY5 Configuration:

- Probe: EX3DV4 - SN3843; ConvF(6.86, 6.86, 6.86); Calibrated: 2018.9.27
- Sensor-Surface: 1.4mm (Mechanical Surface Detection)
- Electronics: DAE4 Sn1279; Calibrated: 2018.10.22
- Phantom: SAM2; Type: SAM; Serial: TP-1503
- Measurement SW: DASY52, Version 52.10 (1); SEMCAD X Version 14.6.11 (7439)

**Pin=250mW/Area Scan (71x71x1):** Interpolated grid: dx=1.200 mm, dy=1.200 mm

Maximum value of SAR (interpolated) = 23.0 W/kg

**Pin=250mW/Zoom Scan (7x7x7)/Cube 0:** Measurement grid: dx=5mm, dy=5mm, dz=5mm

Reference Value = 87.04 V/m; Power Drift = -0.09 dB

Peak SAR (extrapolated) = 31.5 W/kg

**SAR(1 g) = 14.4 W/kg; SAR(10 g) = 6.39 W/kg**

Maximum value of SAR (measured) = 22.9 W/kg

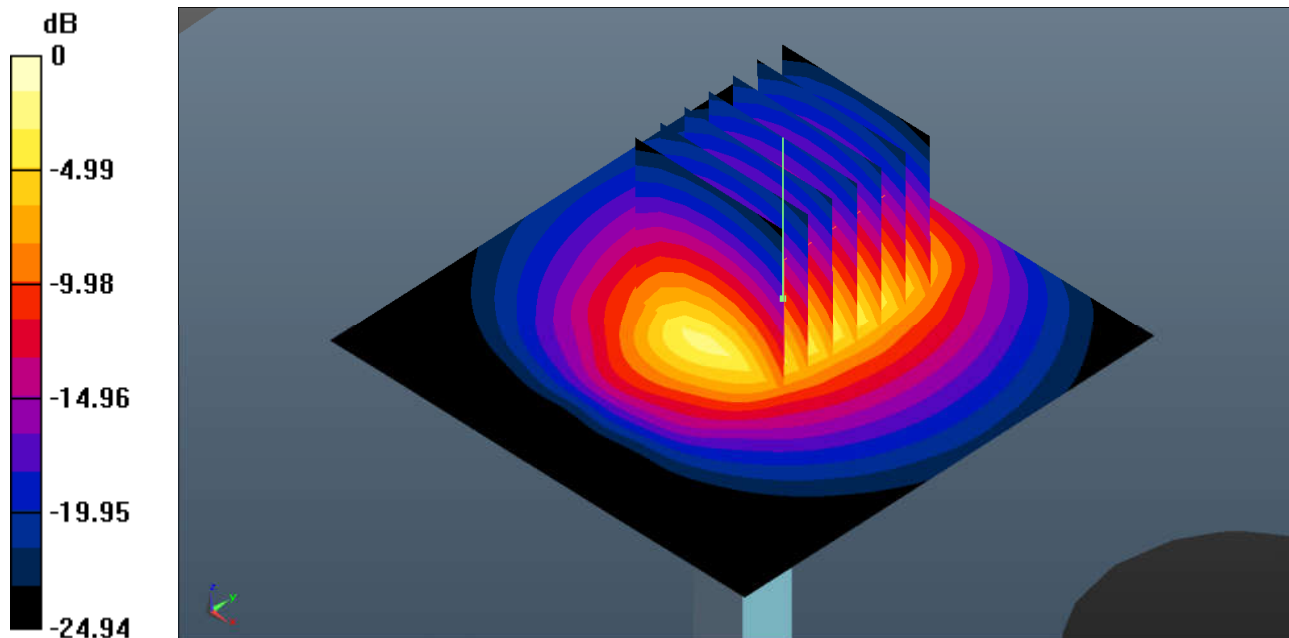

0 dB = 22.9 W/kg = 13.60 dBW/kg

### System Check\_Head\_5250MHz

**DUT: D5GHzV2-SN:1006**

Communication System: UID 0, CW (0); Frequency: 5250 MHz; Duty Cycle: 1:1  
Medium: HSL\_5000 Medium parameters used:  $f = 5250$  MHz;  $\sigma = 4.647$  S/m;  $\epsilon_r = 34.972$ ;  $\rho = 1000$  kg/m<sup>3</sup>  
Ambient Temperature : 23.2 °C ; Liquid Temperature : 22.8 °C

#### DASY5 Configuration:

- Probe: EX3DV4 - SN3954; ConvF(4.98, 4.98, 4.98); Calibrated: 2019.4.25
- Sensor-Surface: 1.4mm (Mechanical Surface Detection)
- Electronics: DAE4 Sn1338; Calibrated: 2018.12.3
- Phantom: SAM1; Type: SAM; Serial: TP-1697
- Measurement SW: DASY52, Version 52.10 (1); SEMCAD X Version 14.6.11 (7439)

**Pin=100mW/Area Scan (71x71x1):** Interpolated grid: dx=1.000 mm, dy=1.000 mm  
Maximum value of SAR (interpolated) = 18.0 W/kg

**Pin=100mW/Zoom Scan (8x8x7)/Cube 0:** Measurement grid: dx=4mm, dy=4mm, dz=1.4mm  
Reference Value = 39.03 V/m; Power Drift = -0.09 dB  
Peak SAR (extrapolated) = 32.7 W/kg  
**SAR(1 g) = 7.57 W/kg; SAR(10 g) = 2.22 W/kg**  
Maximum value of SAR (measured) = 17.5 W/kg

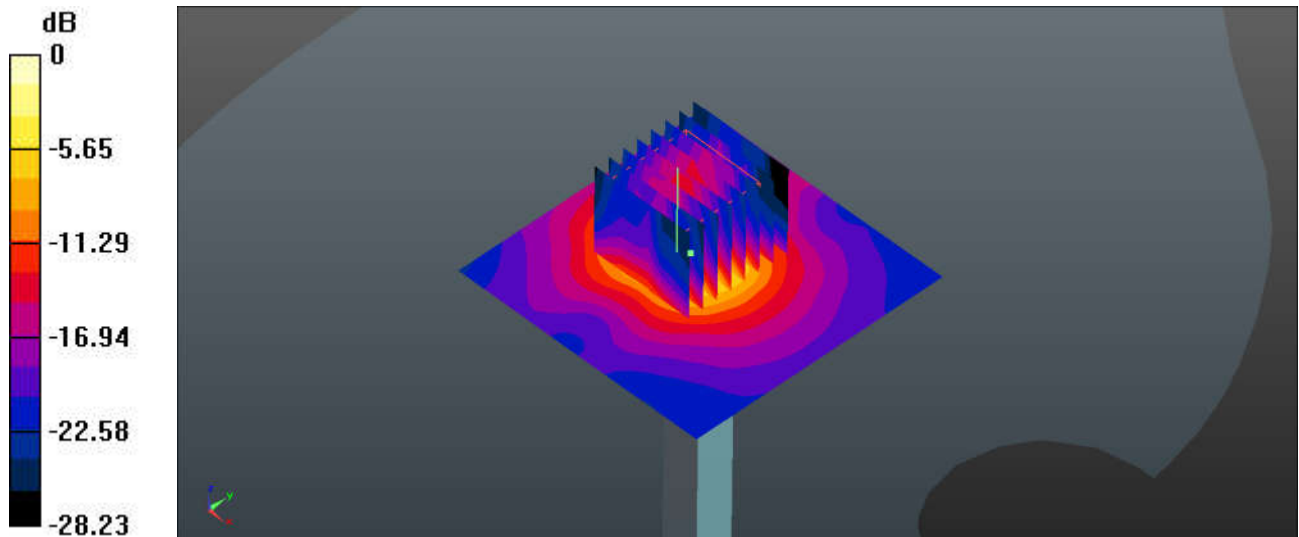

0 dB = 18.0 W/kg = 12.46 dBW/kg



### System Check\_Head\_5600MHz

#### DUT: D5GHzV2-SN:1006

Communication System: UID 0, CW (0); Frequency: 5600 MHz; Duty Cycle: 1:1

Medium: HSL\_5000 Medium parameters used:  $f = 5600$  MHz;  $\sigma = 4.986$  S/m;  $\epsilon_r = 34.505$ ;  $\rho = 1000$  kg/m<sup>3</sup>

Ambient Temperature : 23.3 °C ; Liquid Temperature : 22.6 °C

#### DASY5 Configuration:

- Probe: EX3DV4 - SN3954; ConvF(4.51, 4.51, 4.51); Calibrated: 2019.4.25
- Sensor-Surface: 1.4mm (Mechanical Surface Detection)
- Electronics: DAE4 Sn1338; Calibrated: 2018.12.3
- Phantom: SAM1; Type: SAM; Serial: TP-1697
- Measurement SW: DASY52, Version 52.10 (1); SEMCAD X Version 14.6.11 (7439)

**Pin=100mW/Area Scan (71x71x1):** Interpolated grid: dx=1.000 mm, dy=1.000 mm

Maximum value of SAR (interpolated) = 18.5 W/kg

**Pin=100mW/Zoom Scan (8x8x7)/Cube 0:** Measurement grid: dx=4mm, dy=4mm, dz=1.4mm

Reference Value = 39.17 V/m; Power Drift = 0.02 dB

Peak SAR (extrapolated) = 33.2 W/kg

**SAR(1 g) = 7.68 W/kg; SAR(10 g) = 2.37 W/kg**

Maximum value of SAR (measured) = 17.8 W/kg

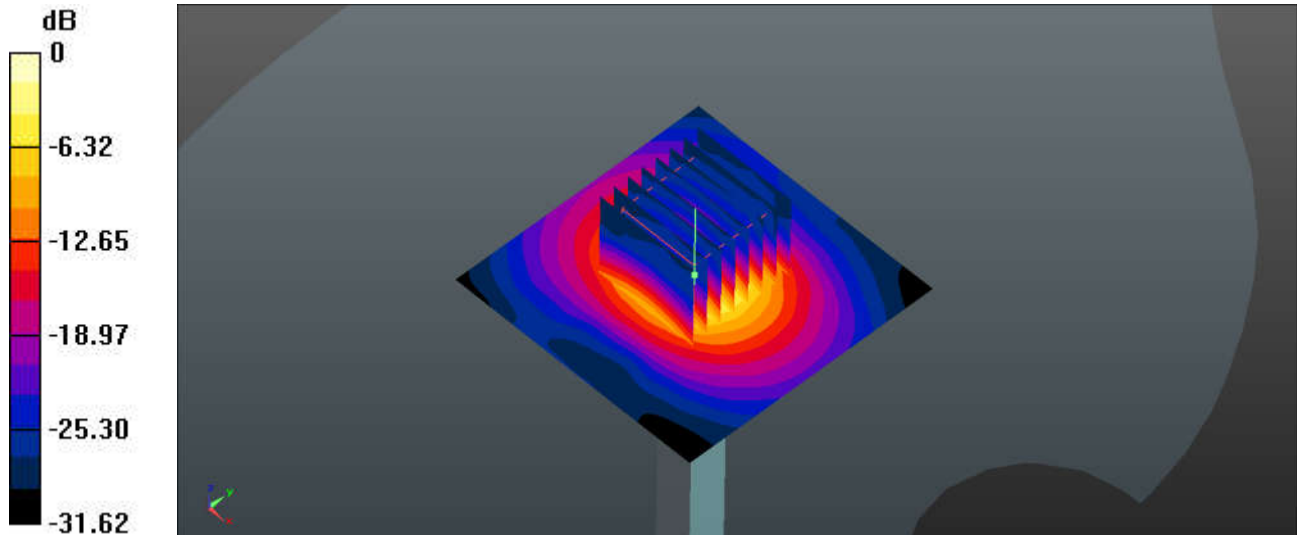

0 dB = 18.5 W/kg = 12.67 dBW/kg

### System Check\_Head\_5750MHz

#### DUT: D5GHzV2-SN:1006

Communication System: UID 0, CW (0); Frequency: 5750 MHz; Duty Cycle: 1:1  
Medium: HSL\_5000 Medium parameters used:  $f = 5750$  MHz;  $\sigma = 5.14$  S/m;  $\epsilon_r = 34.286$ ;  $\rho = 1000$  kg/m<sup>3</sup>  
Ambient Temperature : 23.3 °C ; Liquid Temperature : 22.7 °C

#### DASY5 Configuration:

- Probe: EX3DV4 - SN3954; ConvF(4.65, 4.65, 4.65); Calibrated: 2019.4.25
- Sensor-Surface: 1.4mm (Mechanical Surface Detection)
- Electronics: DAE4 Sn1338; Calibrated: 2018.12.3
- Phantom: SAM1; Type: SAM; Serial: TP-1697
- Measurement SW: DASY52, Version 52.10 (1); SEMCAD X Version 14.6.11 (7439)

**Pin=100mW/Area Scan (71x71x1):** Interpolated grid: dx=1.000 mm, dy=1.000 mm  
Maximum value of SAR (interpolated) = 19.7 W/kg

**Pin=100mW/Zoom Scan (8x8x7)/Cube 0:** Measurement grid: dx=4mm, dy=4mm, dz=1.4mm  
Reference Value = 39.81 V/m; Power Drift = 0.06 dB  
Peak SAR (extrapolated) = 34.4 W/kg  
**SAR(1 g) = 7.93 W/kg; SAR(10 g) = 2.32 W/kg**  
Maximum value of SAR (measured) = 17.7 W/kg

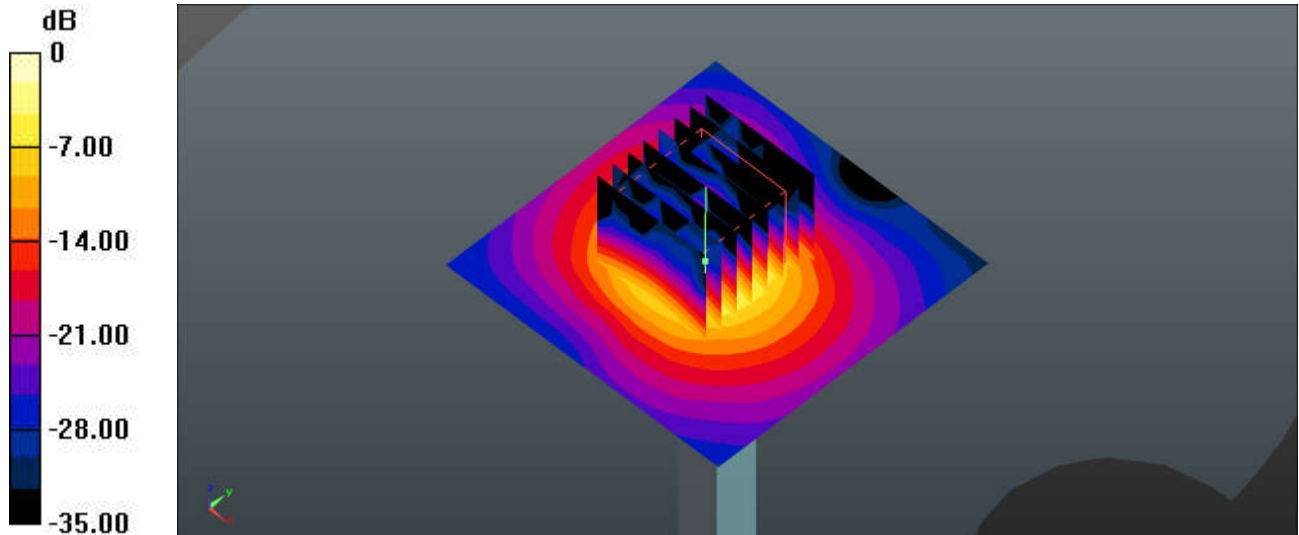

0 dB = 19.7 W/kg = 12.88 dBW/kg

### System Check\_Body\_835MHz

**DUT: D835V2 - SN:4d151**

Communication System: UID 0, CW (0); Frequency: 835 MHz; Duty Cycle: 1:1

Medium: MSL\_835 Medium parameters used:  $f = 835 \text{ MHz}$ ;  $\sigma = 0.998 \text{ S/m}$ ;  $\epsilon_r = 56.478$ ;  $\rho = 1000 \text{ kg/m}^3$

Ambient Temperature :  $23.2 \text{ }^\circ\text{C}$ ; Liquid Temperature :  $22.7 \text{ }^\circ\text{C}$

DASY5 Configuration:

- Probe: EX3DV4 - SN3843; ConvF(9.03, 9.03, 9.03); Calibrated: 2018.9.27
- Sensor-Surface: 1.4mm (Mechanical Surface Detection)
- Electronics: DAE4 Sn1279; Calibrated: 2018.10.22
- Phantom: SAM1; Type: SAM; Serial: TP-1839
- Measurement SW: DASY52, Version 52.10 (1); SEMCAD X Version 14.6.11 (7439)

**Pin=250mW/Area Scan (61x61x1):** Interpolated grid:  $dx=1.500 \text{ mm}$ ,  $dy=1.500 \text{ mm}$

Maximum value of SAR (interpolated) =  $3.16 \text{ W/kg}$

**Pin=250mW/Zoom Scan (5x5x7)/Cube 0:** Measurement grid:  $dx=8\text{mm}$ ,  $dy=8\text{mm}$ ,  $dz=5\text{mm}$

Reference Value =  $51.82 \text{ V/m}$ ; Power Drift =  $-0.10 \text{ dB}$

Peak SAR (extrapolated) =  $3.67 \text{ W/kg}$

**SAR(1 g) =  $2.51 \text{ W/kg}$ ; SAR(10 g) =  $1.65 \text{ W/kg}$**

Maximum value of SAR (measured) =  $3.17 \text{ W/kg}$

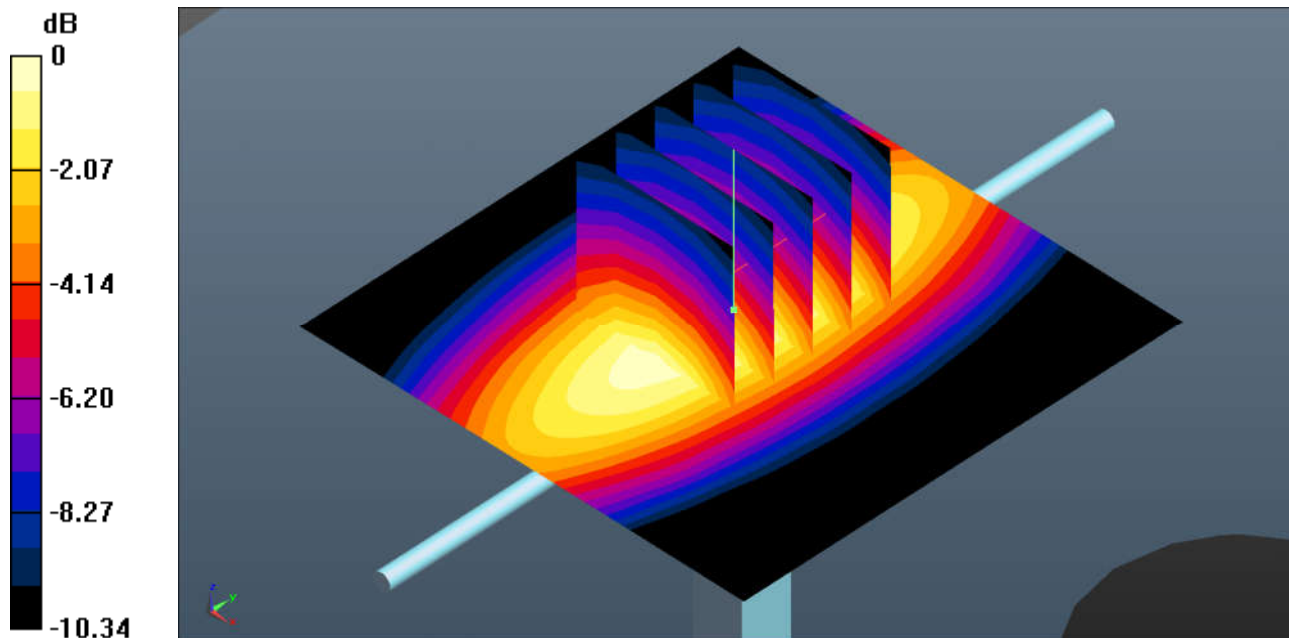

0 dB =  $3.17 \text{ W/kg} = 5.01 \text{ dBW/kg}$

### System Check\_Body\_1750MHz

**DUT: D1750V2 - SN:1090**

Communication System: UID 0, CW (0); Frequency: 1750 MHz; Duty Cycle: 1:1  
Medium: MSL\_1750 Medium parameters used:  $f = 1750$  MHz;  $\sigma = 1.439$  S/m;  $\epsilon_r = 53.027$ ;  $\rho = 1000$  kg/m<sup>3</sup>  
Ambient Temperature : 23.2 °C ; Liquid Temperature : 22.8 °C

DASY5 Configuration:

- Probe: EX3DV4 - SN3843; ConvF(7.41, 7.41, 7.41); Calibrated: 2018.9.27
- Sensor-Surface: 1.4mm (Mechanical Surface Detection)
- Electronics: DAE4 Sn1279; Calibrated: 2018.10.22
- Phantom: SAM2; Type: SAM; Serial: TP-1503
- Measurement SW: DASY52, Version 52.10 (1); SEMCAD X Version 14.6.11 (7439)

**Pin=250mW/Area Scan (61x61x1):** Interpolated grid: dx=1.500 mm, dy=1.500 mm  
Maximum value of SAR (interpolated) = 12.9 W/kg

**Pin=250mW/Zoom Scan (5x5x7)/Cube 0:** Measurement grid: dx=8mm, dy=8mm, dz=5mm  
Reference Value = 81.89 V/m; Power Drift = 0.10 dB  
Peak SAR (extrapolated) = 15.9 W/kg  
**SAR(1 g) = 9.2 W/kg; SAR(10 g) = 4.99 W/kg**  
Maximum value of SAR (measured) = 12.8 W/kg

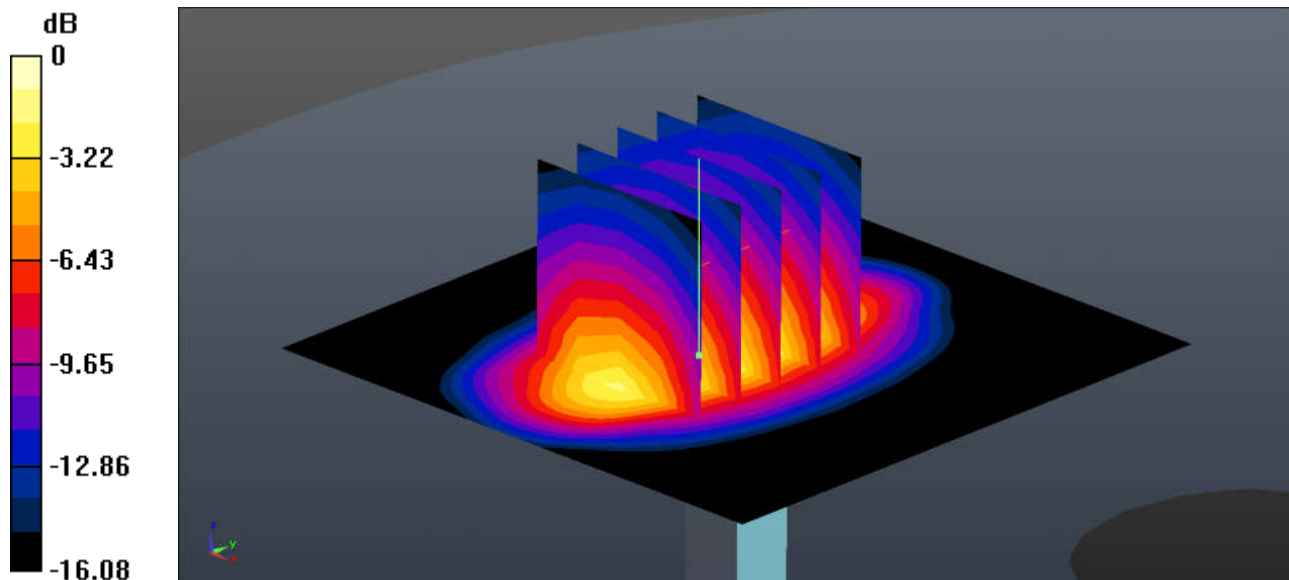

0 dB = 12.8 W/kg = 11.07 dBW/kg

**System Check\_Body\_1900MHz**

**DUT: D1900V2 - SN:5d170**

Communication System: UID 0, CW; Frequency: 1900 MHz; Duty Cycle: 1:1

Medium: MSL\_1900 Medium parameters used:  $f = 1900$  MHz;  $\sigma = 1.513$  S/m;  $\epsilon_r = 53.669$ ;  $\rho = 1000$  kg/m<sup>3</sup>

Ambient Temperature : 23.3 °C ; Liquid Temperature : 22.6 °C

**DASY5 Configuration:**

- Probe: EX3DV4 - SN3843; ConvF(7.07, 7.07, 7.07); Calibrated: 2018.9.27
- Sensor-Surface: 1.4mm (Mechanical Surface Detection)
- Electronics: DAE4 Sn1279; Calibrated: 2018.10.22
- Phantom: SAM2; Type: SAM; Serial: TP-1503
- Measurement SW: DASY52, Version 52.10 (1); SEMCAD X Version 14.6.11 (7439)

**Pin=250mW/Area Scan (61x61x1):** Interpolated grid: dx=1.500 mm, dy=1.500 mm

Maximum value of SAR (interpolated) = 13.9 W/kg

**Pin=250mW/Zoom Scan (5x5x7)/Cube 0:** Measurement grid: dx=8mm, dy=8mm, dz=5mm

Reference Value = 84.83 V/m; Power Drift = 0.02 dB

Peak SAR (extrapolated) = 17.4 W/kg

**SAR(1 g) = 9.68 W/kg; SAR(10 g) = 5.04 W/kg**

Maximum value of SAR (measured) = 13.8 W/kg

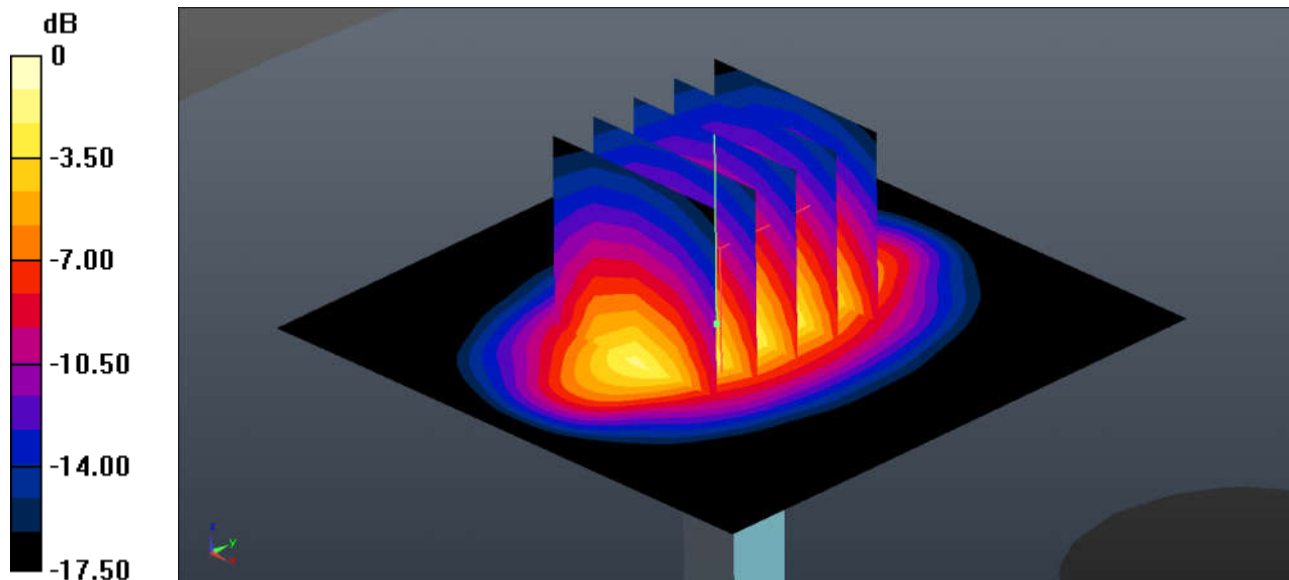

0 dB = 13.8 W/kg = 11.40 dBW/kg

### System Check\_Body\_2450MHz

**DUT: D2450V2 - SN:908**

Communication System: UID 0, CW (0); Frequency: 2450 MHz; Duty Cycle: 1:1  
Medium: MSL\_2450 Medium parameters used:  $f = 2450$  MHz;  $\sigma = 1.992$  S/m;  $\epsilon_r = 53.992$ ;  $\rho = 1000$  kg/m<sup>3</sup>  
Ambient Temperature : 23.2 °C ; Liquid Temperature : 22.6 °C

#### DASY5 Configuration:

- Probe: EX3DV4 - SN3843; ConvF(7.02, 7.02, 7.02); Calibrated: 2018.9.27
- Sensor-Surface: 1.4mm (Mechanical Surface Detection)
- Electronics: DAE4 Sn1279; Calibrated: 2018.10.22
- Phantom: SAM2; Type: SAM; Serial: TP-1503
- Measurement SW: DASY52, Version 52.10 (1); SEMCAD X Version 14.6.11 (7439)

**Pin=250mW/Area Scan (71x71x1):** Interpolated grid: dx=1.200 mm, dy=1.200 mm  
Maximum value of SAR (interpolated) = 20.5 W/kg

**Pin=250mW/Zoom Scan (7x7x7)/Cube 0:** Measurement grid: dx=5mm, dy=5mm, dz=5mm  
Reference Value = 72.12 V/m; Power Drift = 0.04 dB  
Peak SAR (extrapolated) = 27.0 W/kg  
**SAR(1 g) = 13.1 W/kg; SAR(10 g) = 6.04 W/kg**  
Maximum value of SAR (measured) = 20.0 W/kg

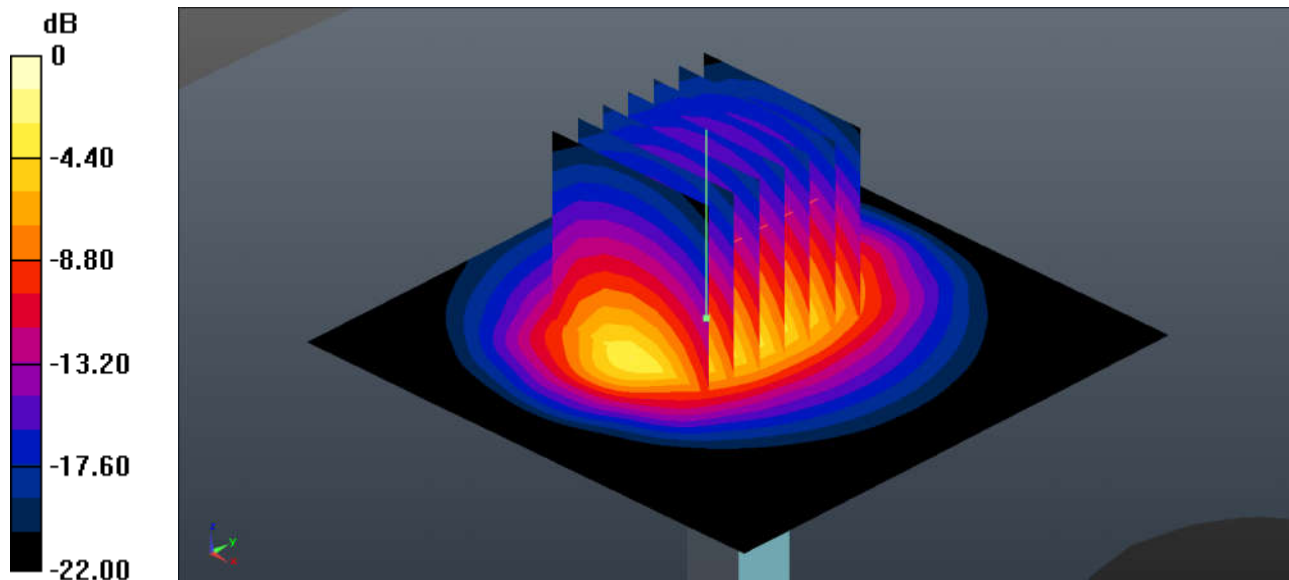

0 dB = 20.0 W/kg = 13.01 dBW/kg

### System Check\_Body\_2600MHz

**DUT: D2600V2 - SN:1061**

Communication System: UID 0, CW (0); Frequency: 2600 MHz; Duty Cycle: 1:1  
Medium: MSL\_2600 Medium parameters used:  $f = 2600$  MHz;  $\sigma = 2.203$  S/m;  $\epsilon_r = 53.413$ ;  $\rho = 1000$  kg/m<sup>3</sup>  
Ambient Temperature : 23.3 °C; Liquid Temperature : 22.7 °C

DASY5 Configuration:

- Probe: EX3DV4 - SN3843; ConvF(6.7, 6.7, 6.7); Calibrated: 2018.9.27
- Sensor-Surface: 1.4mm (Mechanical Surface Detection)
- Electronics: DAE4 Sn1279; Calibrated: 2018.10.22
- Phantom: SAM2; Type: SAM; Serial: TP-1503
- Measurement SW: DASY52, Version 52.10 (1); SEMCAD X Version 14.6.11 (7439)

**Pin=250mW/Area Scan (71x71x1):** Interpolated grid: dx=1.200 mm, dy=1.200 mm  
Maximum value of SAR (interpolated) = 21.8 W/kg

**Pin=250mW/Zoom Scan (7x7x7)/Cube 0:** Measurement grid: dx=5mm, dy=5mm, dz=5mm  
Reference Value = 71.30 V/m; Power Drift = 0.06 dB  
Peak SAR (extrapolated) = 30.0 W/kg  
**SAR(1 g) = 13.8 W/kg; SAR(10 g) = 6.08 W/kg**  
Maximum value of SAR (measured) = 21.7 W/kg

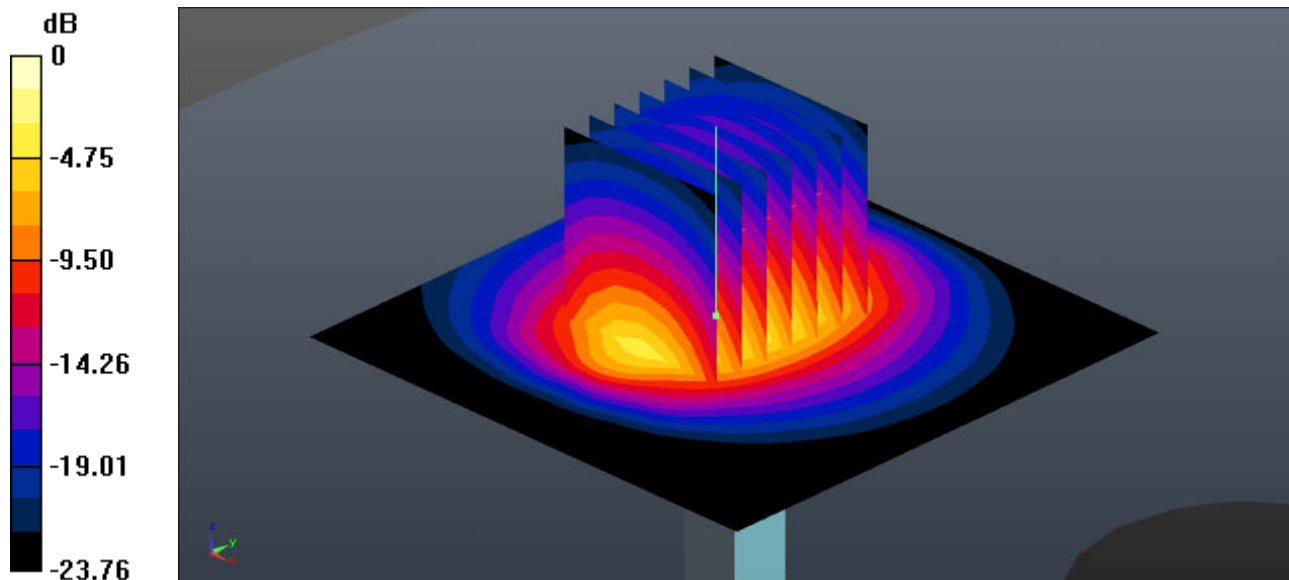

0 dB = 21.7 W/kg = 13.36 dBW/kg



### System Check\_Body\_5250MHz

#### DUT: D5GHzV2-SN:1006

Communication System: UID 0, CW (0); Frequency: 5250 MHz; Duty Cycle: 1:1

Medium: MSL\_5000 Medium parameters used:  $f = 5250$  MHz;  $\sigma = 5.503$  S/m;  $\epsilon_r = 47.874$ ;  $\rho = 1000$  kg/m<sup>3</sup>

Ambient Temperature : 23.2 °C ; Liquid Temperature : 22.7 °C

#### DASY5 Configuration:

- Probe: EX3DV4 - SN3911; ConvF(4.67, 4.67, 4.67); Calibrated: 2019.1.22
- Sensor-Surface: 1.4mm (Mechanical Surface Detection)
- Electronics: DAE4 Sn1338; Calibrated: 2018.12.3
- Phantom: SAM2; Type: SAM; Serial: TP-1503
- Measurement SW: DASY52, Version 52.10 (1); SEMCAD X Version 14.6.11 (7439)

**Pin=100mW/Area Scan (71x71x1):** Interpolated grid: dx=1.000 mm, dy=1.000 mm

Maximum value of SAR (interpolated) = 20.2 W/kg

**Pin=100mW/Zoom Scan (8x8x7)/Cube 0:** Measurement grid: dx=4mm, dy=4mm, dz=1.4mm

Reference Value = 40.13 V/m; Power Drift = 0.01 dB

Peak SAR (extrapolated) = 35.7 W/kg

**SAR(1 g) = 8.23 W/kg; SAR(10 g) = 2.31 W/kg**

Maximum value of SAR (measured) = 20.3 W/kg

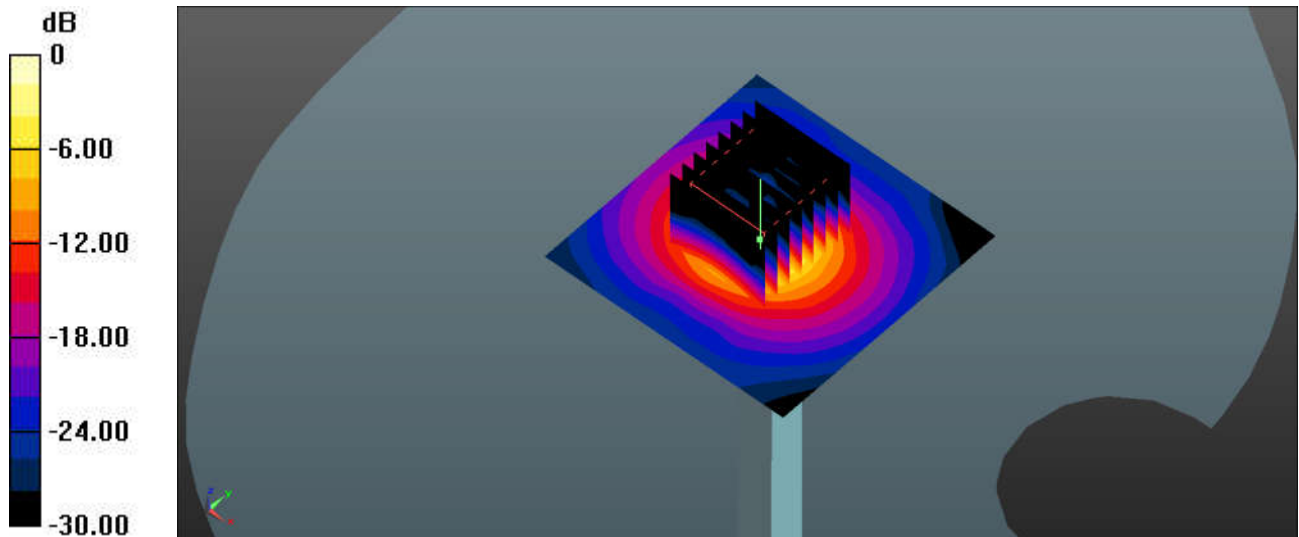

0 dB = 20.3 W/kg = 13.07 dBW/kg



### System Check\_Body\_5600MHz

#### DUT: D5GHzV2-SN:1006

Communication System: UID 0, CW (0); Frequency: 5600 MHz; Duty Cycle: 1:1

Medium: MSL\_5000 Medium parameters used:  $f = 5600$  MHz;  $\sigma = 5.957$  S/m;  $\epsilon_r = 47.28$ ;  $\rho = 1000$  kg/m<sup>3</sup>

Ambient Temperature : 23.2 °C ; Liquid Temperature : 22.7 °C

#### DASY5 Configuration:

- Probe: EX3DV4 - SN3911; ConvF(4.04, 4.04, 4.04); Calibrated: 2019.1.22
- Sensor-Surface: 1.4mm (Mechanical Surface Detection)
- Electronics: DAE4 Sn1338; Calibrated: 2018.12.3
- Phantom: SAM2; Type: SAM; Serial: TP-1503
- Measurement SW: DASY52, Version 52.10 (1); SEMCAD X Version 14.6.11 (7439)

**Pin=100mW/Area Scan (71x71x1):** Interpolated grid: dx=1.000 mm, dy=1.000 mm

Maximum value of SAR (interpolated) = 19.8 W/kg

**Pin=100mW/Zoom Scan (8x8x7)/Cube 0:** Measurement grid: dx=4mm, dy=4mm, dz=1.4mm

Reference Value = 22.48 V/m; Power Drift = 0.09 dB

Peak SAR (extrapolated) = 37.5 W/kg

**SAR(1 g) = 7.97 W/kg; SAR(10 g) = 2.18 W/kg**

Maximum value of SAR (measured) = 19.8 W/kg

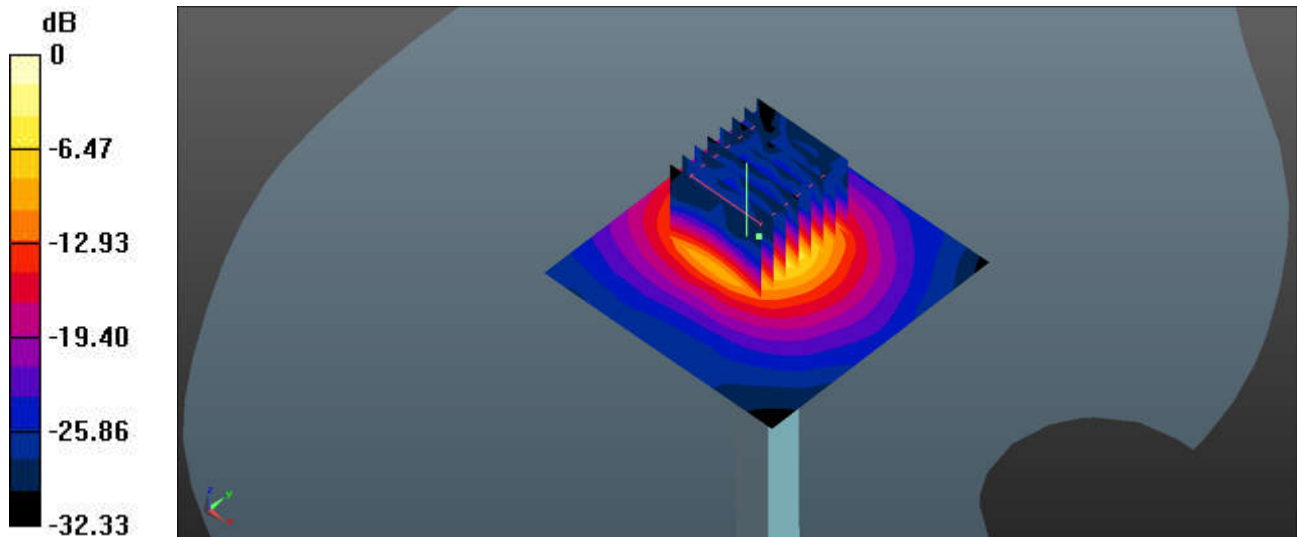

0 dB = 19.8 W/kg = 12.97 dBW/kg

### System Check\_Body\_5750MHz

#### DUT: D5GHzV2-SN:1006

Communication System: UID 0, CW (0); Frequency: 5750 MHz; Duty Cycle: 1:1

Medium: MSL\_5000 Medium parameters used:  $f = 5750$  MHz;  $\sigma = 6.179$  S/m;  $\epsilon_r = 47.023$ ;  $\rho = 1000$  kg/m<sup>3</sup>

Ambient Temperature : 23.2 °C; Liquid Temperature : 22.7 °C

#### DASY5 Configuration:

- Probe: EX3DV4 - SN3911; ConvF(4.16, 4.16, 4.16); Calibrated: 2019.1.22
- Sensor-Surface: 1.4mm (Mechanical Surface Detection)
- Electronics: DAE4 Sn1338; Calibrated: 2018.12.3
- Phantom: SAM2; Type: SAM; Serial: TP-1503
- Measurement SW: DASY52, Version 52.10 (1); SEMCAD X Version 14.6.11 (7439)

**Pin=100mW/Area Scan (71x71x1):** Interpolated grid: dx=1.000 mm, dy=1.000 mm

Maximum value of SAR (interpolated) = 17.9 W/kg

**Pin=100mW/Zoom Scan (8x8x7)/Cube 0:** Measurement grid: dx=4mm, dy=4mm, dz=1.4mm

Reference Value = 20.81 V/m; Power Drift = 0.06 dB

Peak SAR (extrapolated) = 35.2 W/kg

**SAR(1 g) = 7.22 W/kg; SAR(10 g) = 1.98 W/kg**

Maximum value of SAR (measured) = 17.9 W/kg

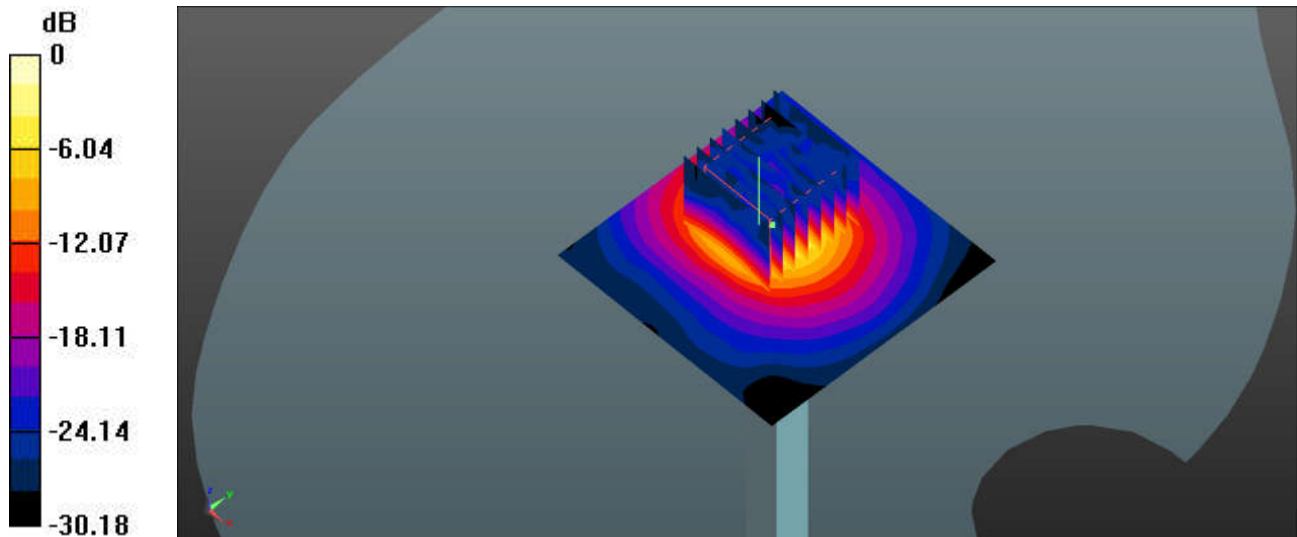

0 dB = 17.9 W/kg = 12.53 dBW/kg



**Appendix B. Plots of High SAR Measurement**

The plots are shown as follows.

### 01\_GSM850-UAT\_GPRS 4 Tx slots\_Right Cheek\_0mm\_Ch189

Communication System: UID 0, GSM850-4UP (0); Frequency: 836.4 MHz; Duty Cycle: 1:2.08  
Medium: HSL\_835 Medium parameters used:  $f = 836.4$  MHz;  $\sigma = 0.906$  S/m;  $\epsilon_r = 41.986$ ;  $\rho = 1000$  kg/m<sup>3</sup>  
Ambient Temperature : 23.3 °C ; Liquid Temperature : 22.7 °C

#### DASY5 Configuration:

- Probe: EX3DV4 - SN3843; ConvF(9.01, 9.01, 9.01); Calibrated: 2018.9.27
- Sensor-Surface: 1.4mm (Mechanical Surface Detection)
- Electronics: DAE4 Sn1279; Calibrated: 2018.10.22
- Phantom: SAM1; Type: SAM; Serial: TP-1839
- Measurement SW: DASY52, Version 52.10 (1); SEMCAD X Version 14.6.11 (7439)

**Ch189/Area Scan (71x81x1):** Interpolated grid: dx=1.500 mm, dy=1.500 mm  
Maximum value of SAR (interpolated) = 0.874 W/kg

**Ch189/Zoom Scan (7x7x7)/Cube 0:** Measurement grid: dx=8mm, dy=8mm, dz=5mm  
Reference Value = 14.95 V/m; Power Drift = -0.02 dB  
Peak SAR (extrapolated) = 1.41 W/kg  
**SAR(1 g) = 0.567 W/kg; SAR(10 g) = 0.282 W/kg**  
Maximum value of SAR (measured) = 1.10 W/kg

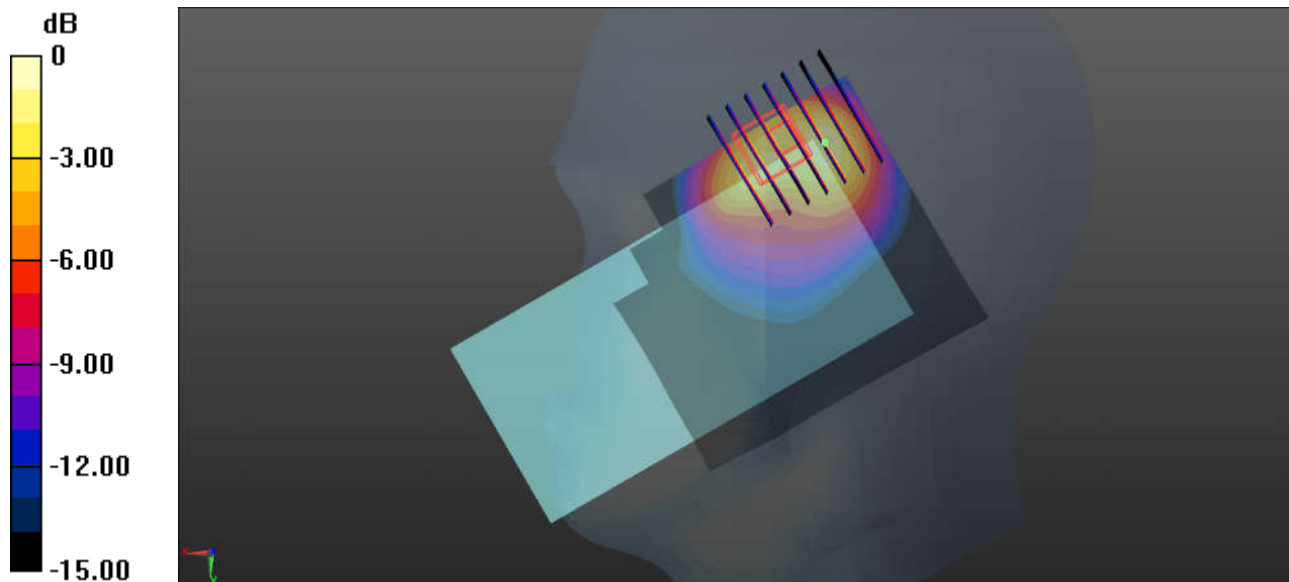

0 dB = 1.10 W/kg = 0.41 dBW/kg

### 02\_GSM1900-UAT\_GPRS 4 Tx slots\_Right Cheek\_0mm\_Ch810

Communication System: UID 0, PCS-4UP (0); Frequency: 1909.8 MHz; Duty Cycle: 1:2.08  
Medium: HSL\_1900 Medium parameters used:  $f = 1910$  MHz;  $\sigma = 1.411$  S/m;  $\epsilon_r = 39.358$ ;  $\rho = 1000$  kg/m<sup>3</sup>  
Ambient Temperature : 23.4 °C ; Liquid Temperature : 22.6 °C

#### DASY5 Configuration:

- Probe: EX3DV4 - SN3843; ConvF(7.4, 7.4, 7.4); Calibrated: 2018.9.27
- Sensor-Surface: 1.4mm (Mechanical Surface Detection)
- Electronics: DAE4 Sn1279; Calibrated: 2018.10.22
- Phantom: SAM2; Type: SAM; Serial: TP-1503
- Measurement SW: DASY52, Version 52.10 (1); SEMCAD X Version 14.6.11 (7439)

**Ch810/Area Scan (71x61x1):** Interpolated grid: dx=1.500 mm, dy=1.500 mm  
Maximum value of SAR (interpolated) = 1.23 W/kg

**Ch810/Zoom Scan (5x5x7)/Cube 0:** Measurement grid: dx=8mm, dy=8mm, dz=5mm  
Reference Value = 11.87 V/m; Power Drift = -0.16 dB  
Peak SAR (extrapolated) = 1.29 W/kg  
**SAR(1 g) = 0.677 W/kg; SAR(10 g) = 0.346 W/kg**  
Maximum value of SAR (measured) = 0.932 W/kg

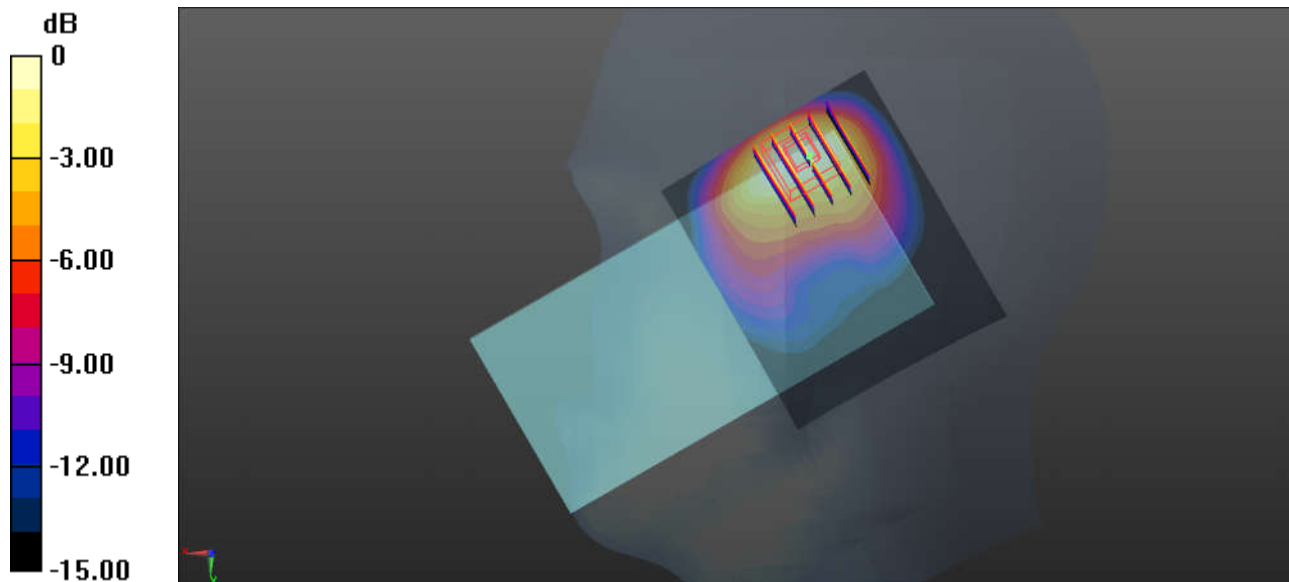

0 dB = 0.932 W/kg = -0.31 dBW/kg

### 03\_WCDMA V-UAT\_RMC 12.2Kbps\_Right Cheek\_0mm\_Ch4182

Communication System: UID 0, WCDMA (0); Frequency: 836.4 MHz; Duty Cycle: 1:1  
Medium: HSL\_835 Medium parameters used:  $f = 836.4$  MHz;  $\sigma = 0.906$  S/m;  $\epsilon_r = 41.986$ ;  $\rho = 1000$  kg/m<sup>3</sup>  
Ambient Temperature : 23.3 °C ; Liquid Temperature : 22.7 °C

#### DASY5 Configuration:

- Probe: EX3DV4 - SN3843; ConvF(9.01, 9.01, 9.01); Calibrated: 2018.9.27
- Sensor-Surface: 1.4mm (Mechanical Surface Detection)
- Electronics: DAE4 Sn1279; Calibrated: 2018.10.22
- Phantom: SAM1; Type: SAM; Serial: TP-1839
- Measurement SW: DASY52, Version 52.10 (1); SEMCAD X Version 14.6.11 (7439)

**Ch4182/Area Scan (71x81x1):** Interpolated grid: dx=1.500 mm, dy=1.500 mm  
Maximum value of SAR (interpolated) = 1.26 W/kg

**Ch4182/Zoom Scan (5x5x7)/Cube 0:** Measurement grid: dx=8mm, dy=8mm, dz=5mm  
Reference Value = 15.58 V/m; Power Drift = 0.06 dB  
Peak SAR (extrapolated) = 1.78 W/kg  
**SAR(1 g) = 0.737 W/kg; SAR(10 g) = 0.369 W/kg**  
Maximum value of SAR (measured) = 1.26 W/kg

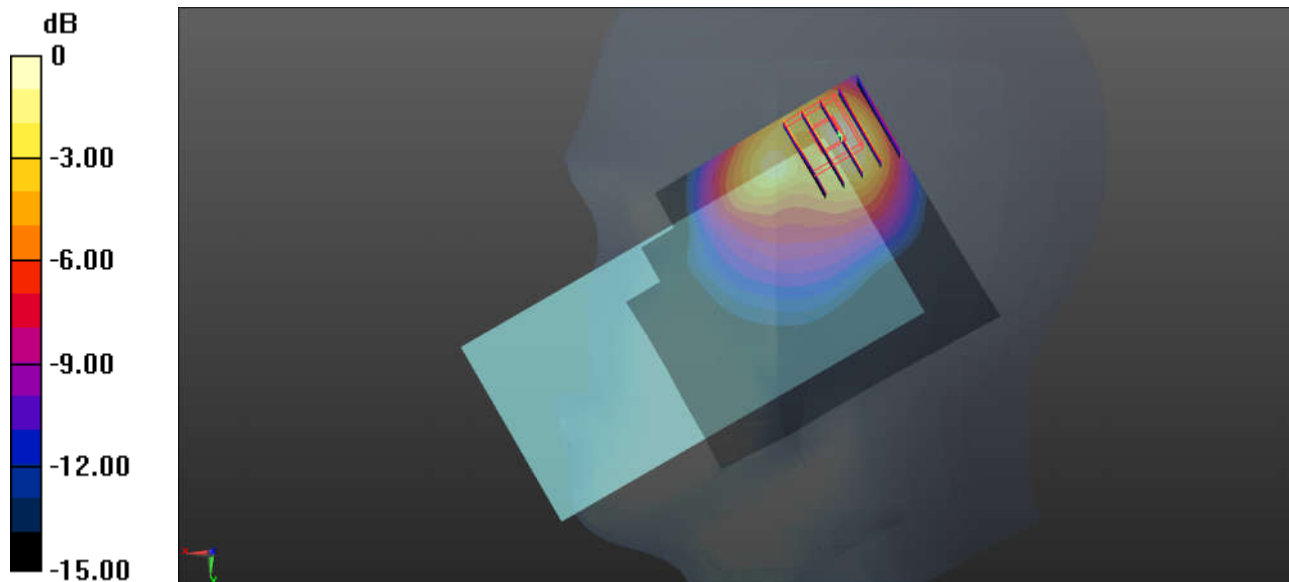

### 04\_WCDMA IV-UAT\_RMC 12.2Kbps\_Right Cheek\_0mm\_Ch1513

Communication System: UID 0, WCDMA (0); Frequency: 1752.6 MHz; Duty Cycle: 1:1  
Medium: HSL\_1750 Medium parameters used:  $f = 1753$  MHz;  $\sigma = 1.359$  S/m;  $\epsilon_r = 39.579$ ;  $\rho = 1000$  kg/m<sup>3</sup>  
Ambient Temperature : 23.2 °C ; Liquid Temperature : 22.9 °C

#### DASY5 Configuration:

- Probe: EX3DV4 - SN3843; ConvF(7.79, 7.79, 7.79); Calibrated: 2018.9.27
- Sensor-Surface: 1.4mm (Mechanical Surface Detection)
- Electronics: DAE4 Sn1279; Calibrated: 2018.10.22
- Phantom: SAM2; Type: SAM; Serial: TP-1503
- Measurement SW: DASY52, Version 52.10 (1); SEMCAD X Version 14.6.11 (7439)

**Ch1513/Area Scan (71x61x1):** Interpolated grid: dx=1.500 mm, dy=1.500 mm  
Maximum value of SAR (interpolated) = 1.48 W/kg

**Ch1513/Zoom Scan (5x5x7)/Cube 0:** Measurement grid: dx=8mm, dy=8mm, dz=5mm  
Reference Value = 12.92 V/m; Power Drift = 0.05 dB  
Peak SAR (extrapolated) = 1.60 W/kg  
**SAR(1 g) = 0.807 W/kg; SAR(10 g) = 0.421 W/kg**  
Maximum value of SAR (measured) = 1.17 W/kg

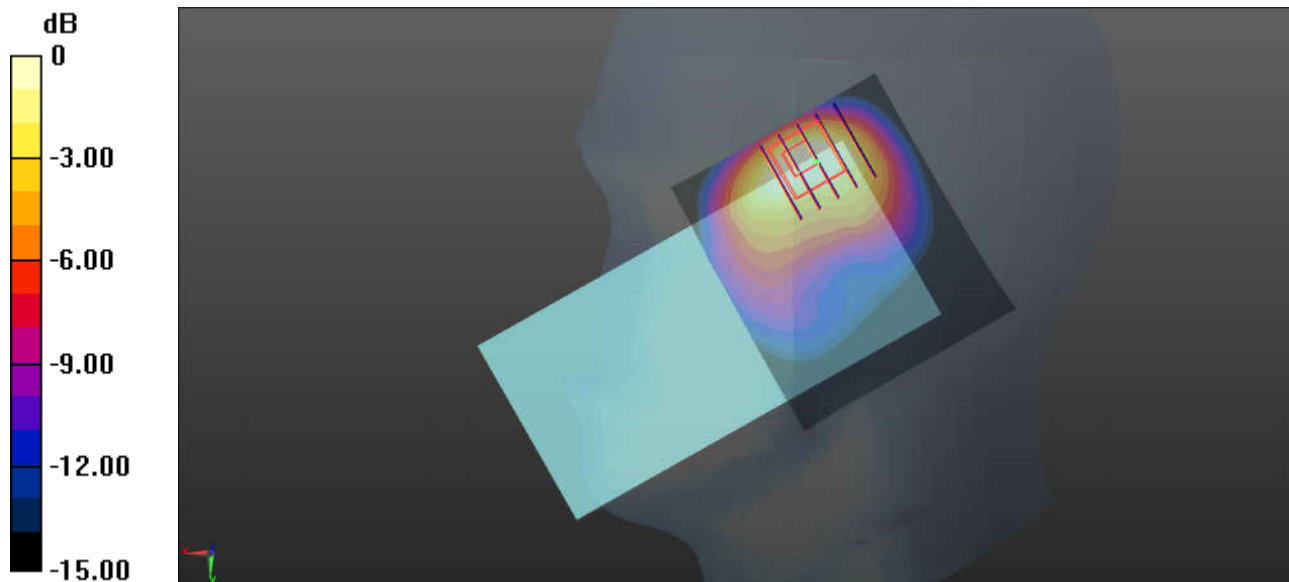

0 dB = 1.17 W/kg = 0.68 dBW/kg

### 05\_WCDMA II-UAT\_RMC 12.2Kbps\_Right Cheek\_0mm\_Ch9538

Communication System: UID 0, WCDMA (0); Frequency: 1907.6 MHz; Duty Cycle: 1:1  
Medium: HSL\_1900 Medium parameters used:  $f = 1908$  MHz;  $\sigma = 1.409$  S/m;  $\epsilon_r = 39.362$ ;  $\rho = 1000$  kg/m<sup>3</sup>  
Ambient Temperature : 23.4 °C ; Liquid Temperature : 22.6 °C

#### DASY5 Configuration:

- Probe: EX3DV4 - SN3843; ConvF(7.4, 7.4, 7.4); Calibrated: 2018.9.27
- Sensor-Surface: 1.4mm (Mechanical Surface Detection)
- Electronics: DAE4 Sn1279; Calibrated: 2018.10.22
- Phantom: SAM2; Type: SAM; Serial: TP-1503
- Measurement SW: DASY52, Version 52.10 (1); SEMCAD X Version 14.6.11 (7439)

**Ch9538/Area Scan (71x61x1):** Interpolated grid: dx=1.500 mm, dy=1.500 mm  
Maximum value of SAR (interpolated) = 1.53 W/kg

**Ch9538/Zoom Scan (5x5x7)/Cube 0:** Measurement grid: dx=8mm, dy=8mm, dz=5mm  
Reference Value = 13.56 V/m; Power Drift = -0.12 dB  
Peak SAR (extrapolated) = 1.63 W/kg  
**SAR(1 g) = 0.834 W/kg; SAR(10 g) = 0.422 W/kg**  
Maximum value of SAR (measured) = 1.22 W/kg

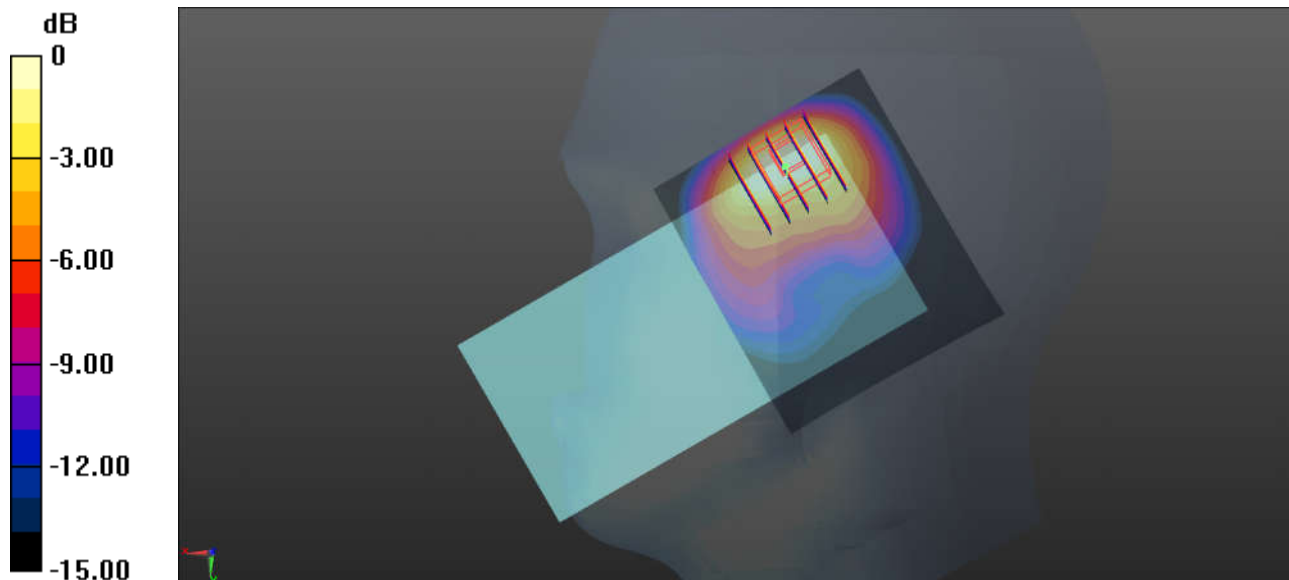

0 dB = 1.22 W/kg = 0.86 dBW/kg



**06\_LTE Band 5-UAT\_10M\_QPSK\_25RB\_0Offset\_Right Cheek\_0mm\_Ch20525**

Communication System: UID 0, LTE-FDD (0); Frequency: 836.5 MHz;Duty Cycle: 1:1  
Medium: HSL\_835 Medium parameters used:  $f = 836.5$  MHz;  $\sigma = 0.906$  S/m;  $\epsilon_r = 41.985$ ;  $\rho = 1000$  kg/m<sup>3</sup>  
Ambient Temperature : 23.3 °C ; Liquid Temperature : 22.7 °C

DASY5 Configuration:

- Probe: EX3DV4 - SN3843; ConvF(9.01, 9.01, 9.01); Calibrated: 2018.9.27
- Sensor-Surface: 1.4mm (Mechanical Surface Detection)
- Electronics: DAE4 Sn1279; Calibrated: 2018.10.22
- Phantom: SAM1; Type: SAM; Serial: TP-1839
- Measurement SW: DASY52, Version 52.10 (1); SEMCAD X Version 14.6.11 (7439)

**Ch20525/Area Scan (71x81x1):** Interpolated grid: dx=1.500 mm, dy=1.500 mm  
Maximum value of SAR (interpolated) = 0.942 W/kg

**Ch20525/Zoom Scan (5x5x7)/Cube 0:** Measurement grid: dx=8mm, dy=8mm, dz=5mm  
Reference Value = 15.23 V/m; Power Drift = 0.01 dB  
Peak SAR (extrapolated) = 1.76 W/kg  
**SAR(1 g) = 0.780 W/kg; SAR(10 g) = 0.396 W/kg**  
Maximum value of SAR (measured) = 1.01 W/kg

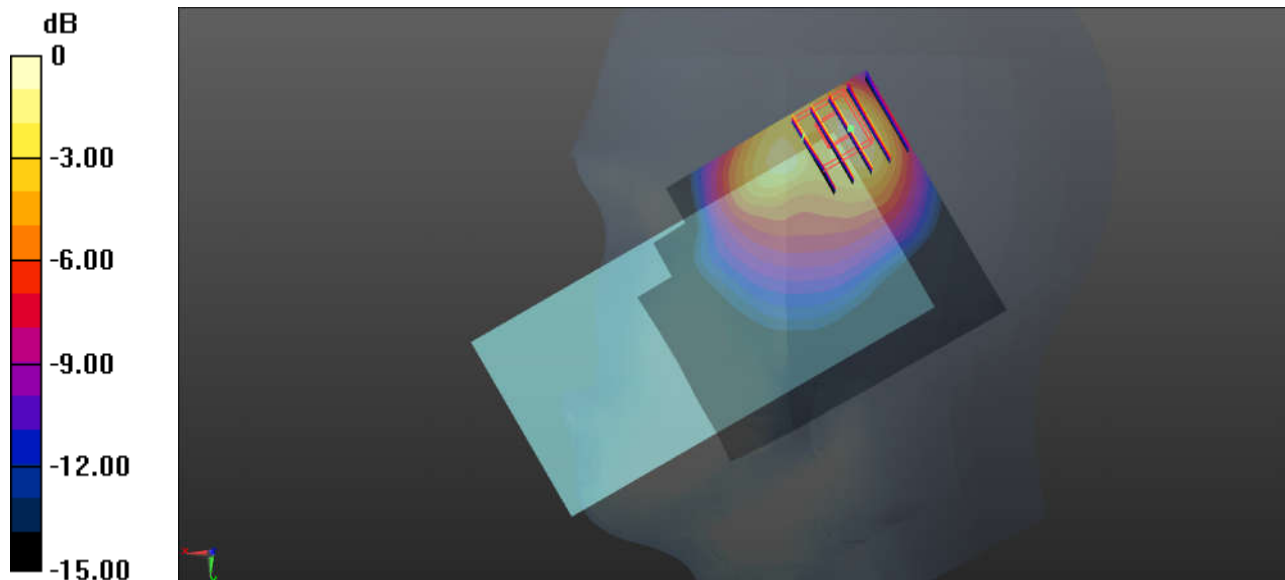

0 dB = 1.01 W/kg = 0.04 dBW/kg

### 07\_LTE Band 4-UAT\_20M\_QPSK\_100RB\_0Offset\_Right Cheek\_0mm\_Ch20175

Communication System: UID 0, LTE-FDD (0); Frequency: 1732.5 MHz; Duty Cycle: 1:1  
Medium: HSL\_1750 Medium parameters used:  $f = 1733$  MHz;  $\sigma = 1.338$  S/m;  $\epsilon_r = 39.678$ ;  $\rho = 1000$  kg/m<sup>3</sup>  
Ambient Temperature : 23.2 °C ; Liquid Temperature : 22.9 °C

#### DASY5 Configuration:

- Probe: EX3DV4 - SN3843; ConvF(7.79, 7.79, 7.79); Calibrated: 2018.9.27
- Sensor-Surface: 1.4mm (Mechanical Surface Detection)
- Electronics: DAE4 Sn1279; Calibrated: 2018.10.22
- Phantom: SAM2; Type: SAM; Serial: TP-1503
- Measurement SW: DASY52, Version 52.10 (1); SEMCAD X Version 14.6.11 (7439)

**Ch20175/Area Scan (71x61x1):** Interpolated grid: dx=1.500 mm, dy=1.500 mm  
Maximum value of SAR (interpolated) = 1.47 W/kg

**Ch20175/Zoom Scan (5x5x7)/Cube 0:** Measurement grid: dx=8mm, dy=8mm, dz=5mm  
Reference Value = 12.98 V/m; Power Drift = 0.03 dB  
Peak SAR (extrapolated) = 1.56 W/kg  
**SAR(1 g) = 0.791 W/kg; SAR(10 g) = 0.415 W/kg**  
Maximum value of SAR (measured) = 1.14 W/kg

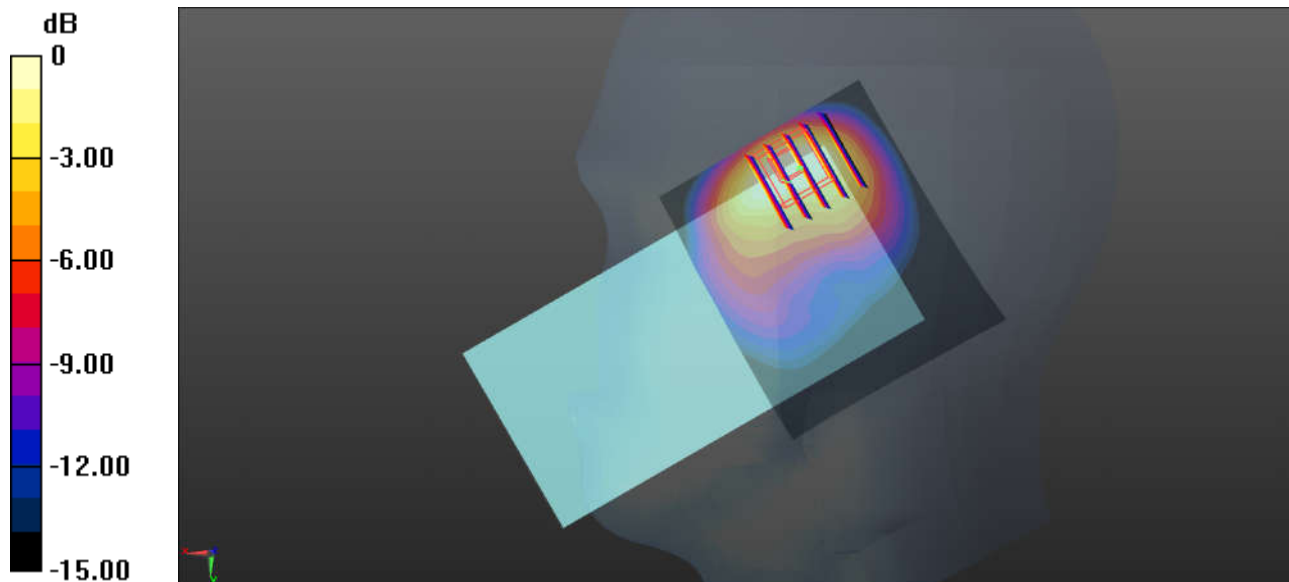

0 dB = 1.14 W/kg = 0.57 dBW/kg

**08\_LTE Band 2-UAT\_20M\_QPSK\_100RB\_0Offset\_Right Cheek\_0mm\_Ch18900**

Communication System: UID 0, LTE-FDD (0); Frequency: 1880 MHz; Duty Cycle: 1:1  
Medium: HSL\_1900 Medium parameters used:  $f = 1880$  MHz;  $\sigma = 1.38$  S/m;  $\epsilon_r = 39.466$ ;  $\rho = 1000$  kg/m<sup>3</sup>  
Ambient Temperature : 23.4 °C ; Liquid Temperature : 22.6 °C

DASY5 Configuration:

- Probe: EX3DV4 - SN3843; ConvF(7.4, 7.4, 7.4); Calibrated: 2018.9.27
- Sensor-Surface: 1.4mm (Mechanical Surface Detection)
- Electronics: DAE4 Sn1279; Calibrated: 2018.10.22
- Phantom: SAM2; Type: SAM; Serial: TP-1503
- Measurement SW: DASY52, Version 52.10 (1); SEMCAD X Version 14.6.11 (7439)

**Ch18900/Area Scan (71x61x1):** Interpolated grid: dx=1.500 mm, dy=1.500 mm  
Maximum value of SAR (interpolated) = 1.50 W/kg

**Ch18900/Zoom Scan (5x5x7)/Cube 0:** Measurement grid: dx=8mm, dy=8mm, dz=5mm  
Reference Value = 12.18 V/m; Power Drift = -0.08 dB  
Peak SAR (extrapolated) = 1.56 W/kg  
**SAR(1 g) = 0.791 W/kg; SAR(10 g) = 0.404 W/kg**  
Maximum value of SAR (measured) = 1.13 W/kg

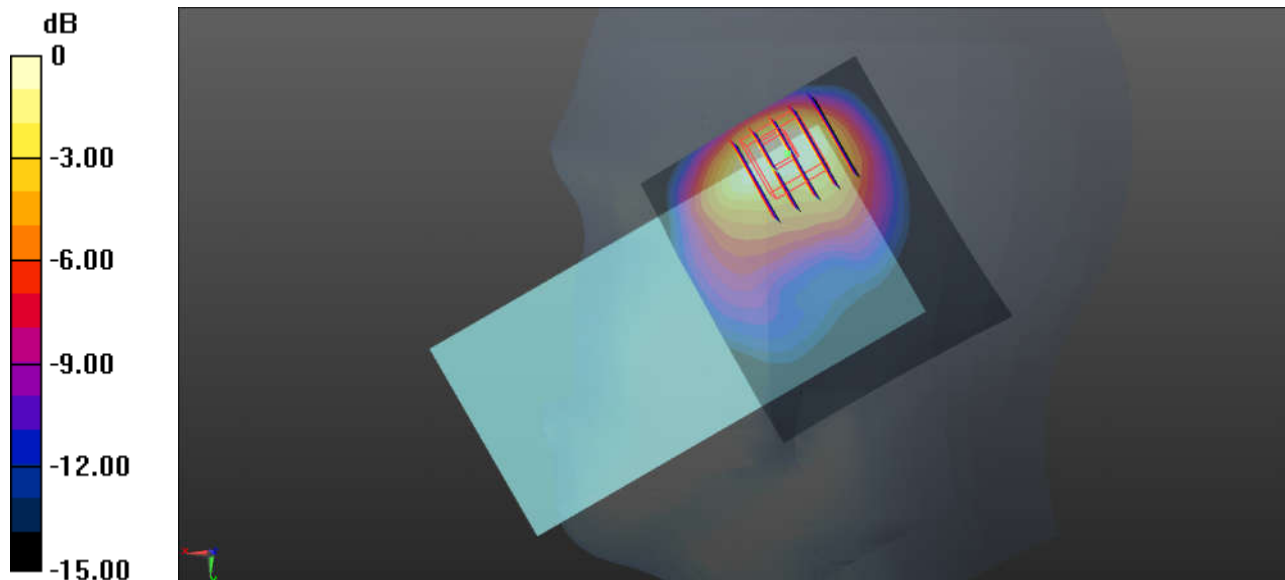

0 dB = 1.13 W/kg = 0.53 dBW/kg

### 09\_LTE Band 7-UAT\_20M\_QPSK\_1RB\_0Offset\_Right Cheek\_0mm\_Ch21350

Communication System: UID 0, LTE-FDD (0); Frequency: 2560 MHz; Duty Cycle: 1:1  
Medium: HSL\_2600 Medium parameters used:  $f = 2560$  MHz;  $\sigma = 1.928$  S/m;  $\epsilon_r = 39.619$ ;  $\rho = 1000$  kg/m<sup>3</sup>  
Ambient Temperature : 23.1 °C ; Liquid Temperature : 22.7 °C

#### DASY5 Configuration:

- Probe: EX3DV4 - SN3843; ConvF(6.86, 6.86, 6.86); Calibrated: 2018.9.27
- Sensor-Surface: 1.4mm (Mechanical Surface Detection)
- Electronics: DAE4 Sn1279; Calibrated: 2018.10.22
- Phantom: SAM2; Type: SAM; Serial: TP-1503
- Measurement SW: DASY52, Version 52.10 (1); SEMCAD X Version 14.6.11 (7439)

**Ch21350/Area Scan (91x71x1):** Interpolated grid: dx=1.200 mm, dy=1.200 mm  
Maximum value of SAR (interpolated) = 1.17 W/kg

**Ch21350/Zoom Scan (7x7x7)/Cube 0:** Measurement grid: dx=5mm, dy=5mm, dz=5mm  
Reference Value = 10.05 V/m; Power Drift = 0.07 dB  
Peak SAR (extrapolated) = 2.00 W/kg  
**SAR(1 g) = 0.824 W/kg; SAR(10 g) = 0.349 W/kg**  
Maximum value of SAR (measured) = 1.49 W/kg

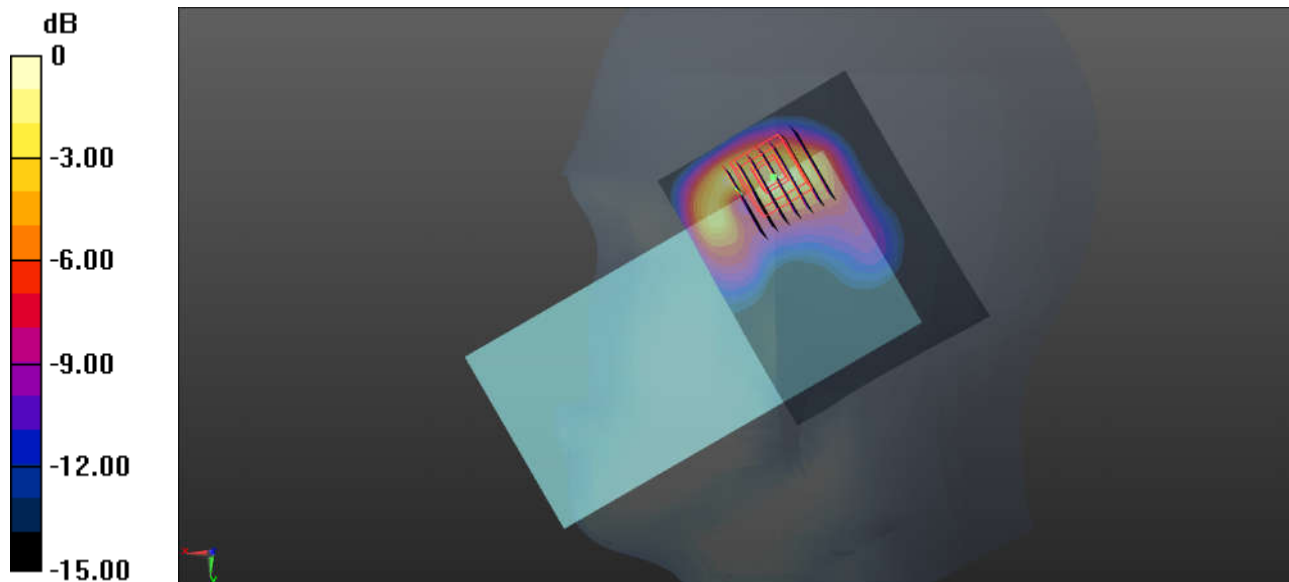

0 dB = 1.49 W/kg = 1.73 dBW/kg

### 10\_LTE Band 38-UAT\_20M\_QPSK\_1RB\_0Offset\_Right Cheek\_0mm\_Ch38000

Communication System: UID 0, LTE-TDD (0); Frequency: 2595 MHz; Duty Cycle: 1:1.59  
Medium: HSL\_2600 Medium parameters used:  $f = 2595$  MHz;  $\sigma = 1.97$  S/m;  $\epsilon_r = 39.481$ ;  $\rho = 1000$  kg/m<sup>3</sup>  
Ambient Temperature : 23.1 °C ; Liquid Temperature : 22.7 °C

#### DASY5 Configuration:

- Probe: EX3DV4 - SN3843; ConvF(6.86, 6.86, 6.86); Calibrated: 2018.9.27
- Sensor-Surface: 1.4mm (Mechanical Surface Detection)
- Electronics: DAE4 Sn1279; Calibrated: 2018.10.22
- Phantom: SAM2; Type: SAM; Serial: TP-1503
- Measurement SW: DASY52, Version 52.10 (1); SEMCAD X Version 14.6.11 (7439)

**Ch38000/Area Scan (81x101x1):** Interpolated grid: dx=1.200 mm, dy=1.200 mm  
Maximum value of SAR (interpolated) = 0.923 W/kg

**Ch38000/Zoom Scan (7x7x7)/Cube 0:** Measurement grid: dx=5mm, dy=5mm, dz=5mm  
Reference Value = 9.491 V/m; Power Drift = 0.11 dB  
Peak SAR (extrapolated) = 1.67 W/kg  
**SAR(1 g) = 0.699 W/kg; SAR(10 g) = 0.296 W/kg**  
Maximum value of SAR (measured) = 1.21 W/kg

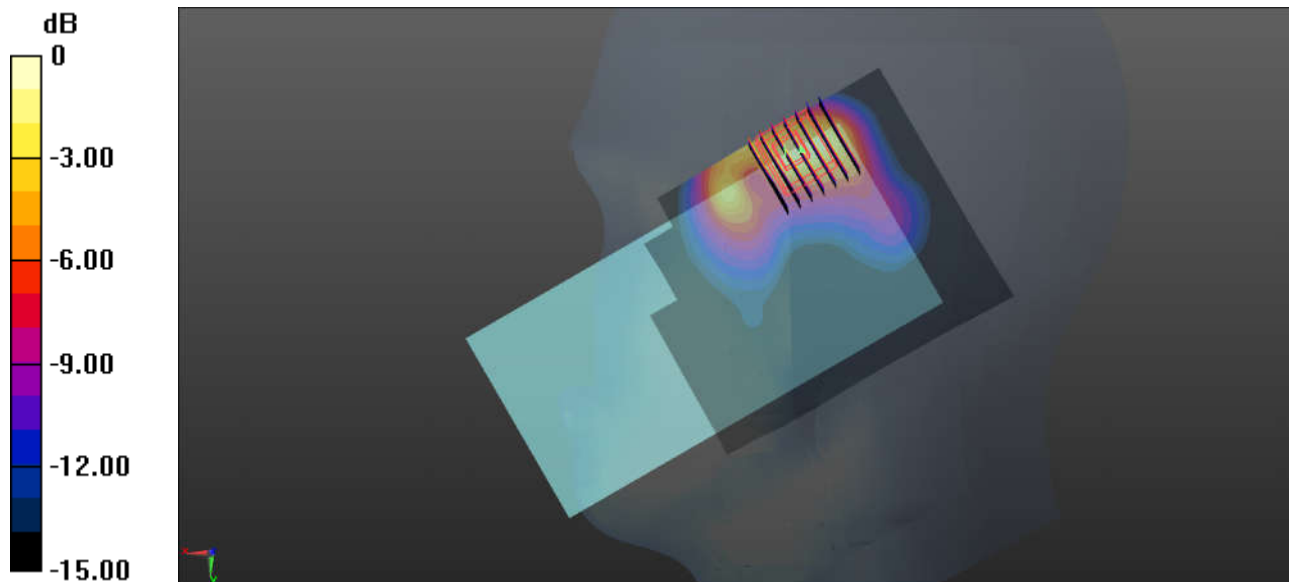

0 dB = 1.21 W/kg = 0.83 dBW/kg

### 11\_WLAN2.4GHz\_802.11b 1Mbps\_Left Tilted\_0mm\_Ant 1\_Ch11

Communication System: UID 0, 802.11b (0); Frequency: 2462 MHz; Duty Cycle: 1:1  
Medium: HSL\_2450 Medium parameters used:  $f = 2462$  MHz;  $\sigma = 1.874$  S/m;  $\epsilon_r = 38.87$ ;  $\rho = 1000$  kg/m<sup>3</sup>  
Ambient Temperature : 23.3 °C ; Liquid Temperature : 22.9 °C

#### DASY5 Configuration:

- Probe: EX3DV4 - SN3843; ConvF(7.08, 7.08, 7.08); Calibrated: 2018.9.27
- Sensor-Surface: 1.4mm (Mechanical Surface Detection)
- Electronics: DAE4 Sn1279; Calibrated: 2018.10.22
- Phantom: SAM2; Type: SAM; Serial: TP-1503
- Measurement SW: DASY52, Version 52.10 (1); SEMCAD X Version 14.6.11 (7439)

**Ch11/Area Scan (81x71x1):** Interpolated grid: dx=1.200 mm, dy=1.200 mm  
Maximum value of SAR (interpolated) = 0.965 W/kg

**Ch11/Zoom Scan (7x7x7)/Cube 0:** Measurement grid: dx=5mm, dy=5mm, dz=5mm  
Reference Value = 18.60 V/m; Power Drift = 0.08 dB  
Peak SAR (extrapolated) = 1.32 W/kg  
**SAR(1 g) = 0.529 W/kg; SAR(10 g) = 0.233 W/kg**  
Maximum value of SAR (measured) = 0.914 W/kg

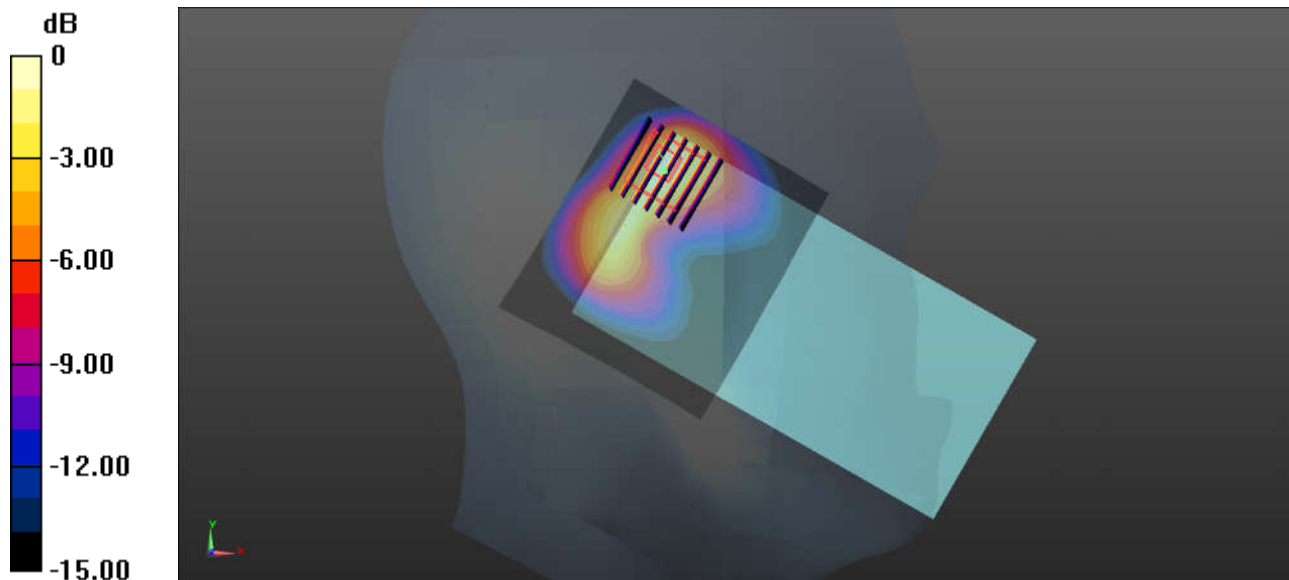

0 dB = 0.914 W/kg = -0.39 dBW/kg

### 12\_WLAN5GHz\_802.11a 6Mbps\_Left Cheek\_0mm\_Ant 1\_Ch56

Communication System: UID 0, 802.11a (0); Frequency: 5280 MHz; Duty Cycle: 1:1.021  
Medium: HSL 5000 Medium parameters used:  $f = 5280$  MHz;  $\sigma = 4.677$  S/m;  $\epsilon_r = 34.965$ ;  $\rho = 1000$  kg/m<sup>3</sup>  
Ambient Temperature : 23.2 °C ; Liquid Temperature : 22.8 °C

#### DASY5 Configuration:

- Probe: EX3DV4 - SN3954; ConvF(4.98, 4.98, 4.98); Calibrated: 2019.4.25
- Sensor-Surface: 1.4mm (Mechanical Surface Detection)
- Electronics: DAE4 Sn1338; Calibrated: 2018.12.3
- Phantom: SAM1; Type: SAM; Serial: TP-1697
- Measurement SW: DASY52, Version 52.10 (1); SEMCAD X Version 14.6.11 (7439)

**Ch56/Area Scan (101x81x1):** Interpolated grid: dx=1.000 mm, dy=1.000 mm  
Maximum value of SAR (interpolated) = 2.09 W/kg

**Ch56/Zoom Scan (8x8x7)/Cube 0:** Measurement grid: dx=4mm, dy=4mm, dz=1.4mm  
Reference Value = 6.041 V/m; Power Drift = -0.08 dB  
Peak SAR (extrapolated) = 3.53 W/kg  
**SAR(1 g) = 0.895 W/kg; SAR(10 g) = 0.295 W/kg**  
Maximum value of SAR (measured) = 2.17 W/kg

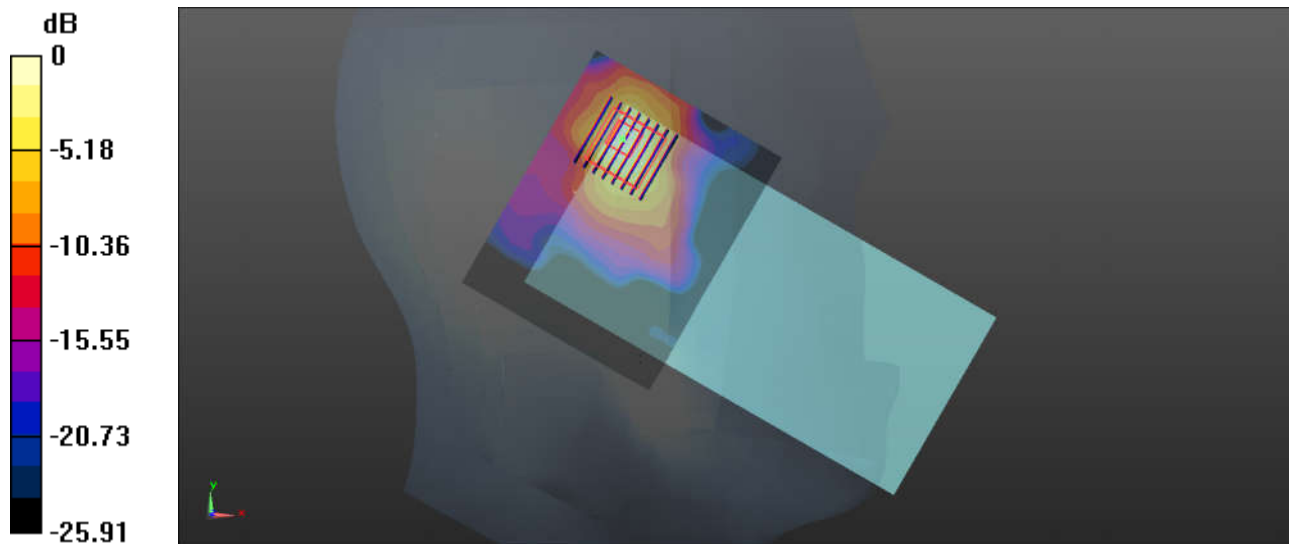

0 dB = 2.17 W/kg = 3.36 dBW/kg

### 13\_WLAN5GHz\_802.11a 6Mbps\_Left Cheek\_0mm\_Ant 1\_Ch100

Communication System: UID 0, 802.11a (0); Frequency: 5500 MHz; Duty Cycle: 1:1.021

Medium: HSL 5000 Medium parameters used:  $f = 5500$  MHz;  $\sigma = 4.883$  S/m;  $\epsilon_r = 34.644$ ;  $\rho = 1000$  kg/m<sup>3</sup>

Ambient Temperature : 23.3 °C ; Liquid Temperature : 22.6 °C

DASY5 Configuration:

- Probe: EX3DV4 - SN3954; ConvF(4.51, 4.51, 4.51); Calibrated: 2019.4.25
- Sensor-Surface: 1.4mm (Mechanical Surface Detection)
- Electronics: DAE4 Sn1338; Calibrated: 2018.12.3
- Phantom: SAM1; Type: SAM; Serial: TP-1697
- Measurement SW: DASY52, Version 52.10 (1); SEMCAD X Version 14.6.11 (7439)

**Ch100/Area Scan (101x81x1):** Interpolated grid: dx=1.000 mm, dy=1.000 mm

Maximum value of SAR (interpolated) = 1.78 W/kg

**Ch100/Zoom Scan (8x8x7)/Cube 0:** Measurement grid: dx=4mm, dy=4mm, dz=1.4mm

Reference Value = 6.410 V/m; Power Drift = -0.05 dB

Peak SAR (extrapolated) = 3.74 W/kg

**SAR(1 g) = 0.844 W/kg; SAR(10 g) = 0.289 W/kg**

Maximum value of SAR (measured) = 2.16 W/kg

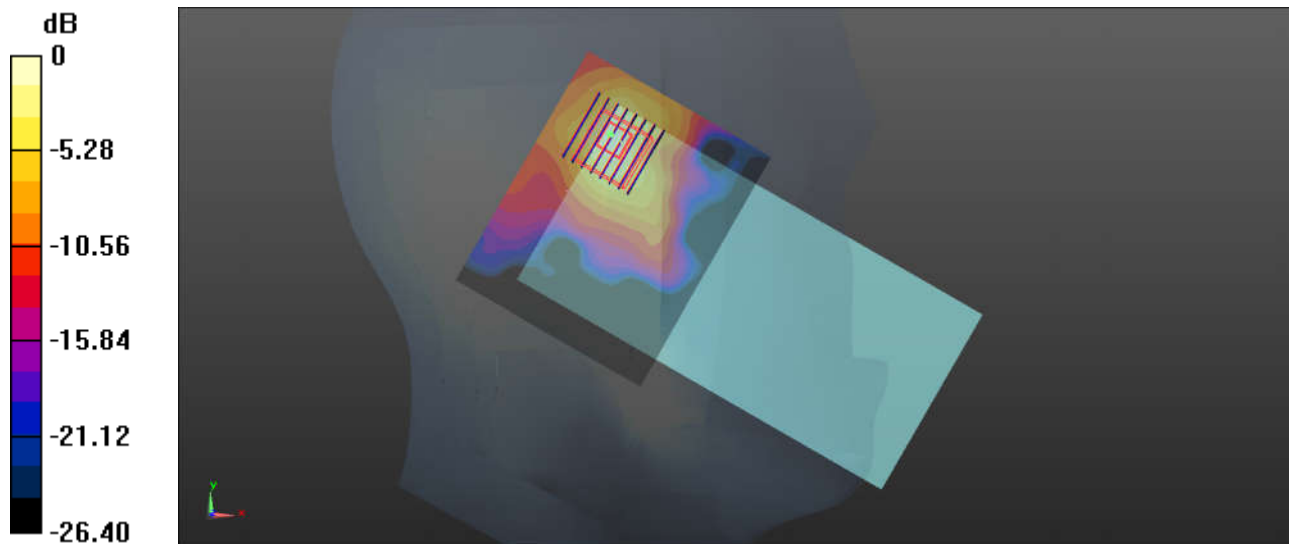

0 dB = 2.16 W/kg = 3.34 dBW/kg



### 14\_WLAN5GHz\_802.11a 6Mbps\_Left Cheek\_0mm\_Ant 1\_Ch161

Communication System: UID 0, 802.11a (0); Frequency: 5805 MHz; Duty Cycle: 1:1.021  
Medium: HSL 5000 Medium parameters used:  $f = 5805$  MHz;  $\sigma = 5.197$  S/m;  $\epsilon_r = 34.221$ ;  $\rho = 1000$  kg/m<sup>3</sup>  
Ambient Temperature : 23.3 °C ; Liquid Temperature : 22.7 °C

#### DASY5 Configuration:

- Probe: EX3DV4 - SN3954; ConvF(4.65, 4.65, 4.65); Calibrated: 2019.4.25
- Sensor-Surface: 1.4mm (Mechanical Surface Detection)
- Electronics: DAE4 Sn1338; Calibrated: 2018.12.3
- Phantom: SAM1; Type: SAM; Serial: TP-1697
- Measurement SW: DASY52, Version 52.10 (1); SEMCAD X Version 14.6.11 (7439)

**Ch161/Area Scan (101x81x1):** Interpolated grid: dx=1.000 mm, dy=1.000 mm  
Maximum value of SAR (interpolated) = 1.18 W/kg

**Ch161/Zoom Scan (8x8x7)/Cube 0:** Measurement grid: dx=4mm, dy=4mm, dz=1.4mm  
Reference Value = 4.463 V/m; Power Drift = -0.14 dB  
Peak SAR (extrapolated) = 4.20 W/kg  
**SAR(1 g) = 0.723 W/kg; SAR(10 g) = 0.171 W/kg**  
Maximum value of SAR (measured) = 2.14 W/kg

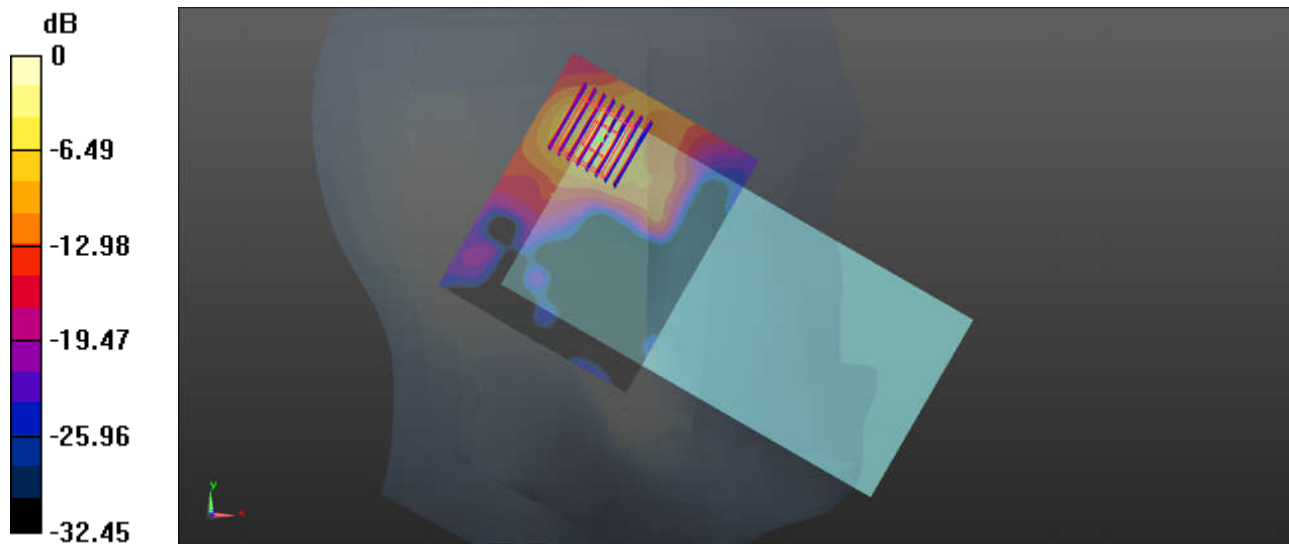

0 dB = 2.14 W/kg = 3.30 dBW/kg

### 15\_Bluetooth\_1Mbps\_Left Tilted\_0mm\_Ant 1\_Ch78

Communication System: UID 0, Bluetooth (0); Frequency: 2480 MHz; Duty Cycle: 1:1.3  
Medium: HSL\_2450 Medium parameters used:  $f = 2480$  MHz;  $\sigma = 1.895$  S/m;  $\epsilon_r = 38.797$ ;  $\rho = 1000$  kg/m<sup>3</sup>  
Ambient Temperature : 23.3 °C ; Liquid Temperature : 22.9 °C

#### DASY5 Configuration:

- Probe: EX3DV4 - SN3843; ConvF(7.08, 7.08, 7.08); Calibrated: 2018.9.27
- Sensor-Surface: 1.4mm (Mechanical Surface Detection)
- Electronics: DAE4 Sn1279; Calibrated: 2018.10.22
- Phantom: SAM2; Type: SAM; Serial: TP-1503
- Measurement SW: DASY52, Version 52.10 (1); SEMCAD X Version 14.6.11 (7439)

**Ch78/Area Scan (81x71x1):** Interpolated grid: dx=1.200 mm, dy=1.200 mm  
Maximum value of SAR (interpolated) = 0.224 W/kg

**Ch78/Zoom Scan (7x7x7)/Cube 0:** Measurement grid: dx=5mm, dy=5mm, dz=5mm  
Reference Value = 8.305 V/m; Power Drift = -0.02 dB  
Peak SAR (extrapolated) = 0.320 W/kg  
**SAR(1 g) = 0.130 W/kg; SAR(10 g) = 0.058 W/kg**  
Maximum value of SAR (measured) = 0.227 W/kg

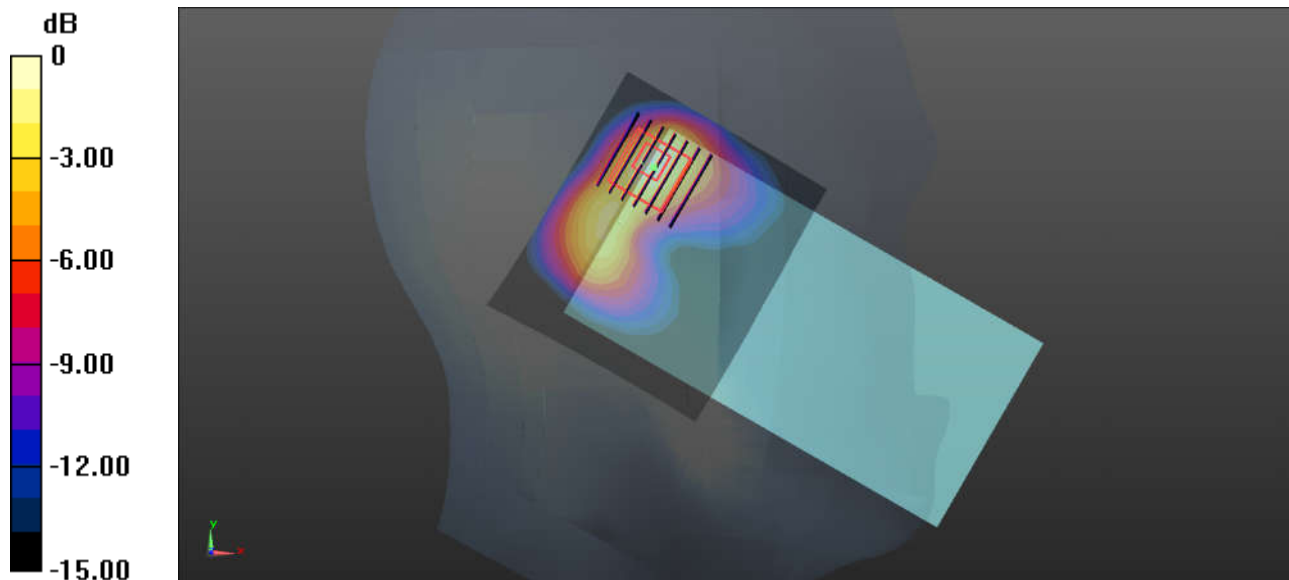

0 dB = 0.227 W/kg = -6.44 dBW/kg

### 16\_GSM850-LAT\_GPRS 4 Tx slots\_Back\_10mm\_Ch189

Communication System: UID 0, GSM850-4UP (0); Frequency: 836.4 MHz; Duty Cycle: 1:2.08  
Medium: MSL\_835 Medium parameters used:  $f = 836.4$  MHz;  $\sigma = 1$  S/m;  $\epsilon_r = 56.462$ ;  $\rho = 1000$  kg/m<sup>3</sup>  
Ambient Temperature : 23.2 °C ; Liquid Temperature : 22.7 °C

#### DASY5 Configuration:

- Probe: EX3DV4 - SN3843; ConvF(9.03, 9.03, 9.03); Calibrated: 2018.9.27
- Sensor-Surface: 1.4mm (Mechanical Surface Detection)
- Electronics: DAE4 Sn1279; Calibrated: 2018.10.22
- Phantom: SAM1; Type: SAM; Serial: TP-1839
- Measurement SW: DASY52, Version 52.10 (1); SEMCAD X Version 14.6.11 (7439)

**Ch189/Area Scan (71x61x1):** Interpolated grid: dx=1.500 mm, dy=1.500 mm  
Maximum value of SAR (interpolated) = 0.400 W/kg

**Ch189/Zoom Scan (6x6x7)/Cube 0:** Measurement grid: dx=8mm, dy=8mm, dz=5mm  
Reference Value = 17.60 V/m; Power Drift = -0.05 dB  
Peak SAR (extrapolated) = 0.474 W/kg  
**SAR(1 g) = 0.263 W/kg; SAR(10 g) = 0.157 W/kg**  
Maximum value of SAR (measured) = 0.377 W/kg

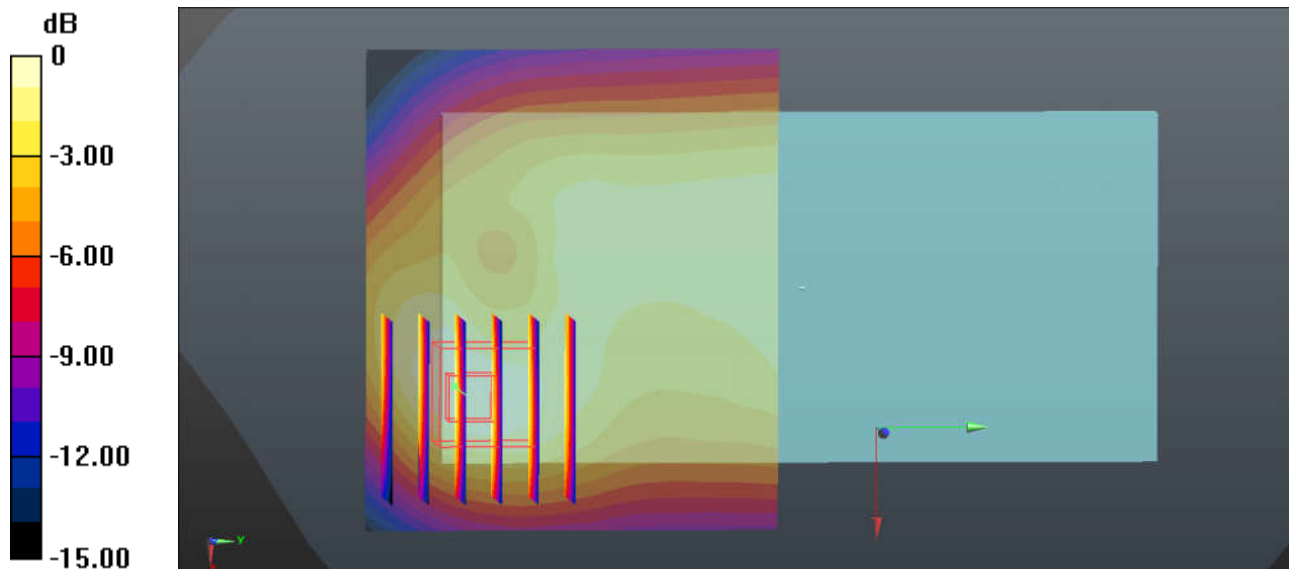

0 dB = 0.377 W/kg = -4.24 dBW/kg

### 17\_GSM1900-LAT\_GPRS 4 Tx slots\_Bottom Side\_10mm\_Ch810

Communication System: UID 0, PCS-4UP (0); Frequency: 1909.8 MHz; Duty Cycle: 1:2.08  
Medium: MSL\_1900 Medium parameters used:  $f = 1910$  MHz;  $\sigma = 1.523$  S/m;  $\epsilon_r = 53.685$ ;  $\rho = 1000$  kg/m<sup>3</sup>  
Ambient Temperature : 23.3 °C ; Liquid Temperature : 22.6 °C

#### DASY5 Configuration:

- Probe: EX3DV4 - SN3843; ConvF(7.07, 7.07, 7.07); Calibrated: 2018.9.27
- Sensor-Surface: 1.4mm (Mechanical Surface Detection)
- Electronics: DAE4 Sn1279; Calibrated: 2018.10.22
- Phantom: SAM2; Type: SAM; Serial: TP-1503
- Measurement SW: DASY52, Version 52.10 (1); SEMCAD X Version 14.6.11 (7439)

**Ch810/Area Scan (41x71x1):** Interpolated grid: dx=1.500 mm, dy=1.500 mm  
Maximum value of SAR (interpolated) = 1.11 W/kg

**Ch810/Zoom Scan (5x5x7)/Cube 0:** Measurement grid: dx=8mm, dy=8mm, dz=5mm  
Reference Value = 26.39 V/m; Power Drift = 0.03 dB  
Peak SAR (extrapolated) = 1.20 W/kg  
**SAR(1 g) = 0.682 W/kg; SAR(10 g) = 0.355 W/kg**  
Maximum value of SAR (measured) = 1.06 W/kg

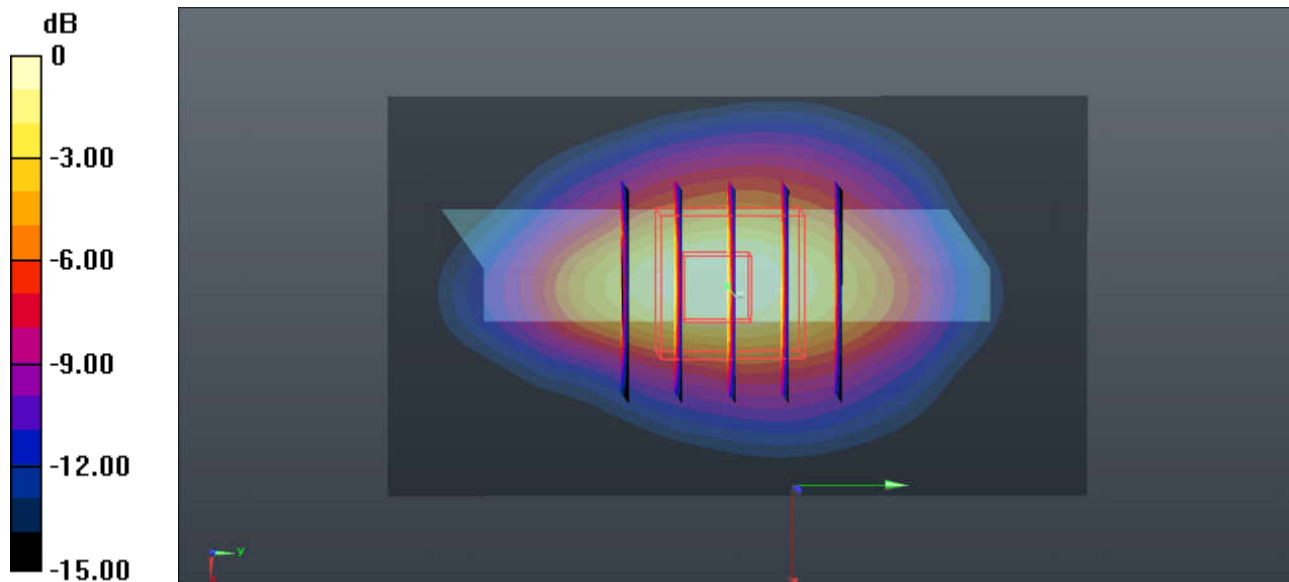

0 dB = 1.06 W/kg = 0.25 dBW/kg

### 18\_WCDMA V-LAT\_RMC 12.2Kbps\_Back\_10mm\_Ch4182

Communication System: UID 0, WCDMA (0); Frequency: 836.4 MHz; Duty Cycle: 1:1  
Medium: MSL\_835 Medium parameters used:  $f = 836.4$  MHz;  $\sigma = 1$  S/m;  $\epsilon_r = 56.462$ ;  $\rho = 1000$  kg/m<sup>3</sup>  
Ambient Temperature : 23.2 °C ; Liquid Temperature : 22.7 °C

#### DASY5 Configuration:

- Probe: EX3DV4 - SN3843; ConvF(9.03, 9.03, 9.03); Calibrated: 2018.9.27
- Sensor-Surface: 1.4mm (Mechanical Surface Detection)
- Electronics: DAE4 Sn1279; Calibrated: 2018.10.22
- Phantom: SAM1; Type: SAM; Serial: TP-1839
- Measurement SW: DASY52, Version 52.10 (1); SEMCAD X Version 14.6.11 (7439)

**Ch4182/Area Scan (71x61x1):** Interpolated grid: dx=1.500 mm, dy=1.500 mm  
Maximum value of SAR (interpolated) = 0.614 W/kg

**Ch4182/Zoom Scan (6x6x7)/Cube 0:** Measurement grid: dx=8mm, dy=8mm, dz=5mm  
Reference Value = 18.87 V/m; Power Drift = 0.01 dB  
Peak SAR (extrapolated) = 0.707 W/kg  
**SAR(1 g) = 0.412 W/kg; SAR(10 g) = 0.255 W/kg**  
Maximum value of SAR (measured) = 0.583 W/kg

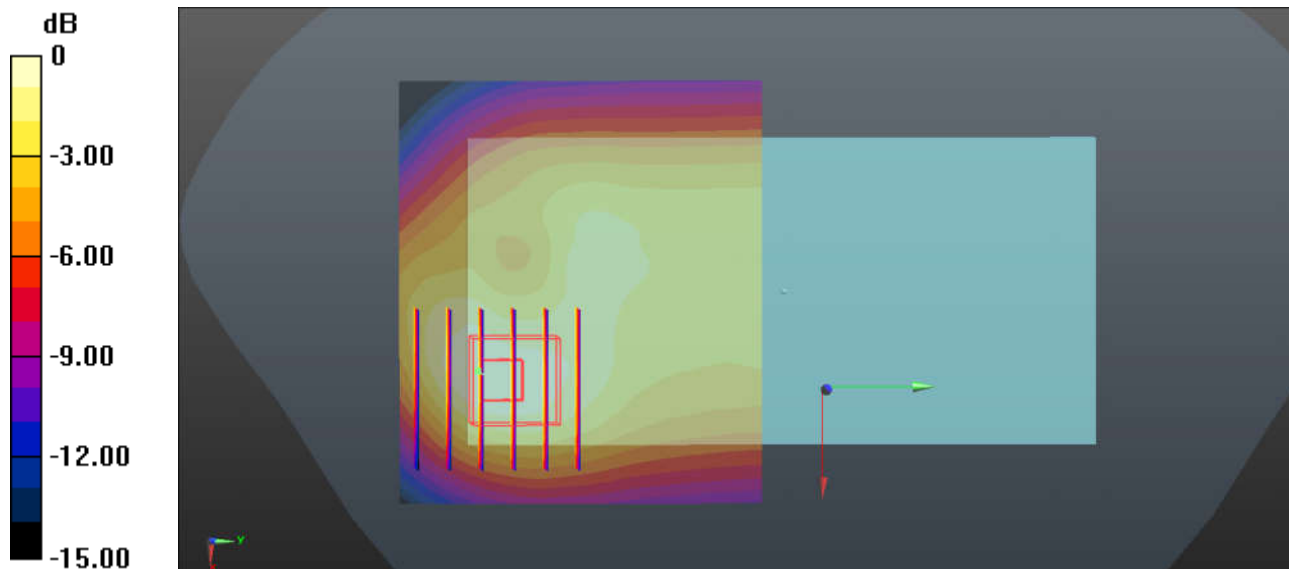

0 dB = 0.583 W/kg = -2.34 dBW/kg

### 19\_WCDMA IV-LAT\_RMC 12.2Kbps\_Bottom Side\_10mm\_Ch1413

Communication System: UID 0, WCDMA (0); Frequency: 1732.6 MHz; Duty Cycle: 1:1  
Medium: MSL\_1750 Medium parameters used:  $f = 1733$  MHz;  $\sigma = 1.419$  S/m;  $\epsilon_r = 53.091$ ;  $\rho = 1000$  kg/m<sup>3</sup>  
Ambient Temperature : 23.2 °C ; Liquid Temperature : 22.8 °C

#### DASY5 Configuration:

- Probe: EX3DV4 - SN3843; ConvF(7.41, 7.41, 7.41); Calibrated: 2018.9.27
- Sensor-Surface: 1.4mm (Mechanical Surface Detection)
- Electronics: DAE4 Sn1279; Calibrated: 2018.10.22
- Phantom: SAM2; Type: SAM; Serial: TP-1503
- Measurement SW: DASY52, Version 52.10 (1); SEMCAD X Version 14.6.11 (7439)

**Ch1413/Area Scan (41x71x1):** Interpolated grid: dx=1.500 mm, dy=1.500 mm  
Maximum value of SAR (interpolated) = 1.08 W/kg

**Ch1413/Zoom Scan (5x5x7)/Cube 0:** Measurement grid: dx=8mm, dy=8mm, dz=5mm  
Reference Value = 27.76 V/m; Power Drift = -0.09 dB  
Peak SAR (extrapolated) = 1.20 W/kg  
**SAR(1 g) = 0.695 W/kg; SAR(10 g) = 0.375 W/kg**  
Maximum value of SAR (measured) = 1.02 W/kg

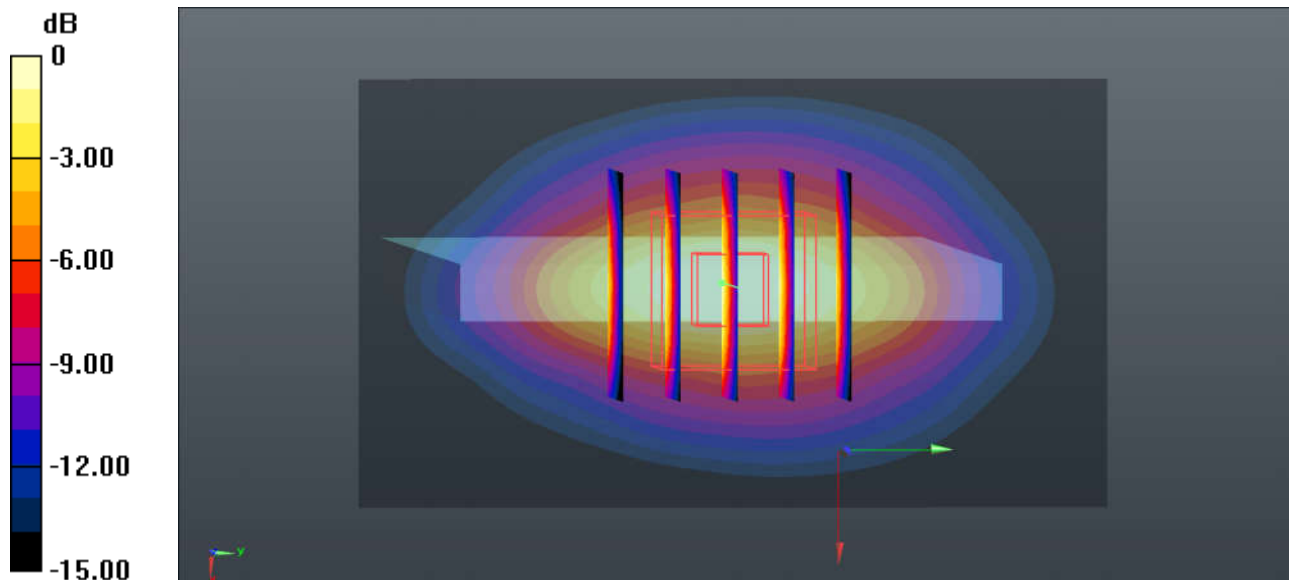

0 dB = 1.02 W/kg = 0.09 dBW/kg

### 20\_WCDMA II-LAT\_RMC 12.2Kbps\_Bottom Side\_10mm\_Ch9262

Communication System: UID 0, WCDMA (0); Frequency: 1852.4 MHz; Duty Cycle: 1:1  
Medium: MSL\_1900 Medium parameters used:  $f = 1852.4$  MHz;  $\sigma = 1.446$  S/m;  $\epsilon_r = 53.862$ ;  $\rho = 1000$  kg/m<sup>3</sup>  
Ambient Temperature : 23.3 °C ; Liquid Temperature : 22.6 °C

#### DASY5 Configuration:

- Probe: EX3DV4 - SN3843; ConvF(7.07, 7.07, 7.07); Calibrated: 2018.9.27
- Sensor-Surface: 1.4mm (Mechanical Surface Detection)
- Electronics: DAE4 Sn1279; Calibrated: 2018.10.22
- Phantom: SAM2; Type: SAM; Serial: TP-1503
- Measurement SW: DASY52, Version 52.10 (1); SEMCAD X Version 14.6.11 (7439)

**Ch9262/Area Scan (41x71x1):** Interpolated grid: dx=1.500 mm, dy=1.500 mm  
Maximum value of SAR (interpolated) = 0.971 W/kg

**Ch9262/Zoom Scan (5x5x7)/Cube 0:** Measurement grid: dx=8mm, dy=8mm, dz=5mm  
Reference Value = 25.78 V/m; Power Drift = -0.01 dB  
Peak SAR (extrapolated) = 1.08 W/kg  
**SAR(1 g) = 0.614 W/kg; SAR(10 g) = 0.323 W/kg**  
Maximum value of SAR (measured) = 0.914 W/kg

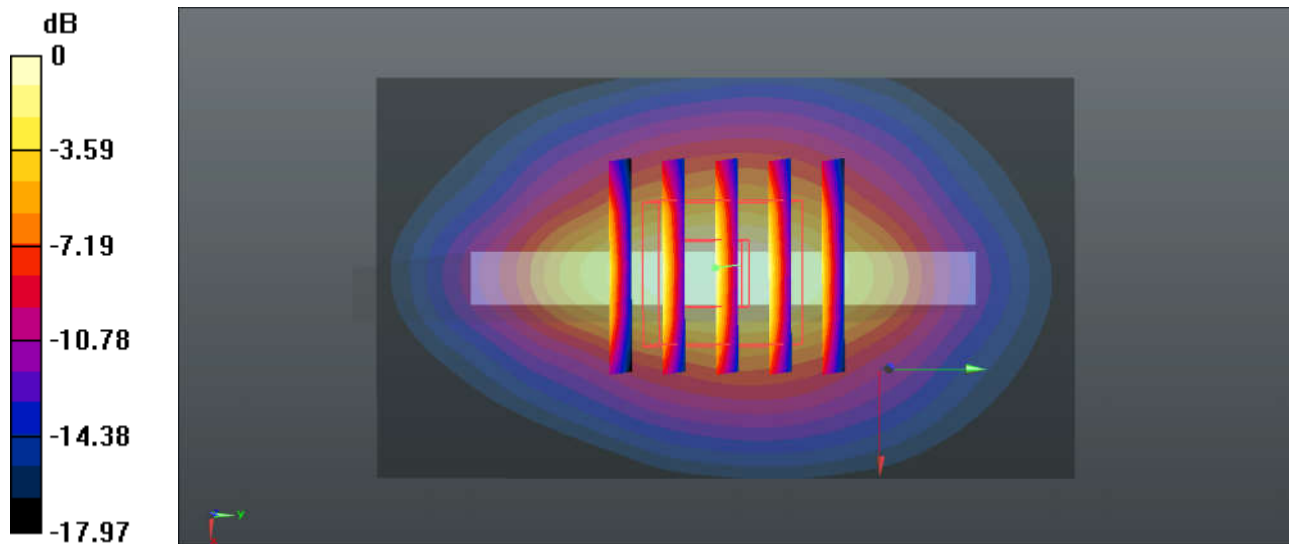

0 dB = 0.914 W/kg = -0.39 dBW/kg

**21\_LTE Band 5-LAT\_10M\_QPSK\_1RB\_0Offset\_Right Side\_10mm\_Ch20525**

Communication System: UID 0, LTE-FDD (0); Frequency: 836.5 MHz; Duty Cycle: 1:1  
 Medium: MSL\_835 Medium parameters used:  $f = 836.5 \text{ MHz}$ ;  $\sigma = 1 \text{ S/m}$ ;  $\epsilon_r = 56.461$ ;  $\rho = 1000 \text{ kg/m}^3$   
 Ambient Temperature : 23.2 °C ; Liquid Temperature : 22.7 °C

**DASY5 Configuration:**

- Probe: EX3DV4 - SN3843; ConvF(9.03, 9.03, 9.03); Calibrated: 2018.9.27
- Sensor-Surface: 1.4mm (Mechanical Surface Detection)
- Electronics: DAE4 Sn1279; Calibrated: 2018.10.22
- Phantom: SAM1; Type: SAM; Serial: TP-1839
- Measurement SW: DASY52, Version 52.10 (1); SEMCAD X Version 14.6.11 (7439)

**Ch20525/Area Scan (41x81x1):** Interpolated grid:  $dx=1.500 \text{ mm}$ ,  $dy=1.500 \text{ mm}$   
 Maximum value of SAR (interpolated) = 0.453 W/kg

**Ch20525/Zoom Scan (5x5x7)/Cube 0:** Measurement grid:  $dx=8\text{mm}$ ,  $dy=8\text{mm}$ ,  $dz=5\text{mm}$   
 Reference Value = 21.68 V/m; Power Drift = -0.02 dB  
 Peak SAR (extrapolated) = 0.525 W/kg  
**SAR(1 g) = 0.336 W/kg; SAR(10 g) = 0.229 W/kg**  
 Maximum value of SAR (measured) = 0.453 W/kg

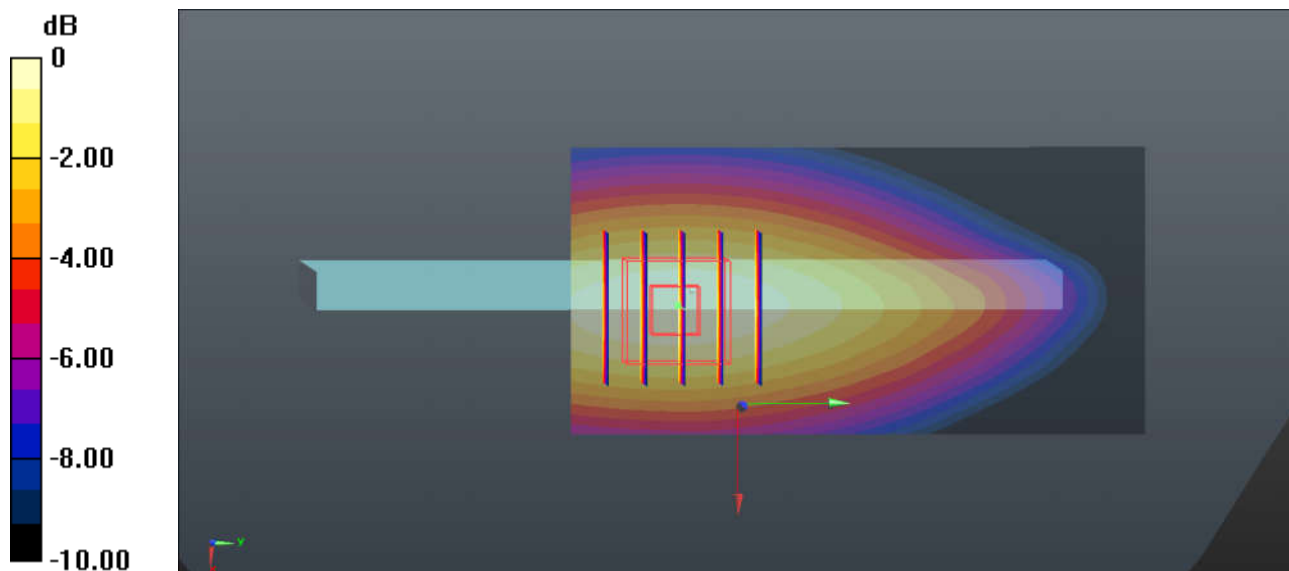

0 dB = 0.453 W/kg = -3.44 dBW/kg



## 22\_LTE Band 4-LAT\_20M\_QPSK\_50RB\_0Offset\_Bottom Side\_10mm\_Ch20175

Communication System: UID 0, LTE-FDD (0); Frequency: 1732.5 MHz; Duty Cycle: 1:1  
Medium: MSL\_1750 Medium parameters used:  $f = 1733$  MHz;  $\sigma = 1.419$  S/m;  $\epsilon_r = 53.091$ ;  $\rho = 1000$  kg/m<sup>3</sup>  
Ambient Temperature : 23.2 °C ; Liquid Temperature : 22.8 °C

### DASY5 Configuration:

- Probe: EX3DV4 - SN3843; ConvF(7.41, 7.41, 7.41); Calibrated: 2018.9.27
- Sensor-Surface: 1.4mm (Mechanical Surface Detection)
- Electronics: DAE4 Sn1279; Calibrated: 2018.10.22
- Phantom: SAM2; Type: SAM; Serial: TP-1503
- Measurement SW: DASY52, Version 52.10 (1); SEMCAD X Version 14.6.11 (7439)

**Ch20175/Area Scan (41x71x1):** Interpolated grid: dx=1.500 mm, dy=1.500 mm  
Maximum value of SAR (interpolated) = 1.19 W/kg

**Ch20175/Zoom Scan (5x5x7)/Cube 0:** Measurement grid: dx=8mm, dy=8mm, dz=5mm  
Reference Value = 29.01 V/m; Power Drift = 0.03 dB  
Peak SAR (extrapolated) = 1.30 W/kg  
**SAR(1 g) = 0.754 W/kg; SAR(10 g) = 0.407 W/kg**  
Maximum value of SAR (measured) = 1.11 W/kg

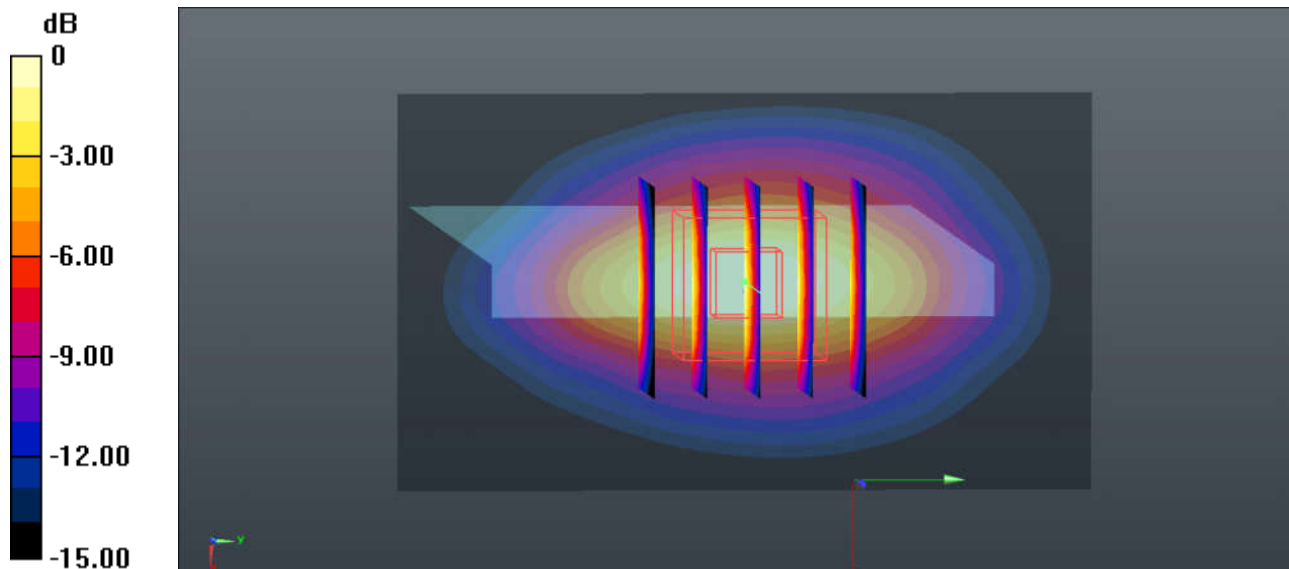

0 dB = 1.11 W/kg = 0.45 dBW/kg

### 23\_LTE Band 2-LAT\_20M\_QPSK\_50RB\_0Offset\_Bottom Side\_10mm\_Ch18700

Communication System: UID 0, LTE-FDD (0); Frequency: 1860 MHz; Duty Cycle: 1:1  
Medium: MSL\_1900 Medium parameters used:  $f = 1860$  MHz;  $\sigma = 1.456$  S/m;  $\epsilon_r = 53.801$ ;  $\rho = 1000$  kg/m<sup>3</sup>  
Ambient Temperature : 23.3 °C ; Liquid Temperature : 22.6 °C

#### DASY5 Configuration:

- Probe: EX3DV4 - SN3843; ConvF(7.07, 7.07, 7.07); Calibrated: 2018.9.27
- Sensor-Surface: 1.4mm (Mechanical Surface Detection)
- Electronics: DAE4 Sn1279; Calibrated: 2018.10.22
- Phantom: SAM2; Type: SAM; Serial: TP-1503
- Measurement SW: DASY52, Version 52.10 (1); SEMCAD X Version 14.6.11 (7439)

**Ch18700/Area Scan (41x61x1):** Interpolated grid: dx=1.500 mm, dy=1.500 mm  
Maximum value of SAR (interpolated) = 1.09 W/kg

**Ch18700/Zoom Scan (5x5x7)/Cube 0:** Measurement grid: dx=8mm, dy=8mm, dz=5mm  
Reference Value = 26.60 V/m; Power Drift = 0.01 dB  
Peak SAR (extrapolated) = 1.25 W/kg  
**SAR(1 g) = 0.701 W/kg; SAR(10 g) = 0.368 W/kg**  
Maximum value of SAR (measured) = 1.06 W/kg

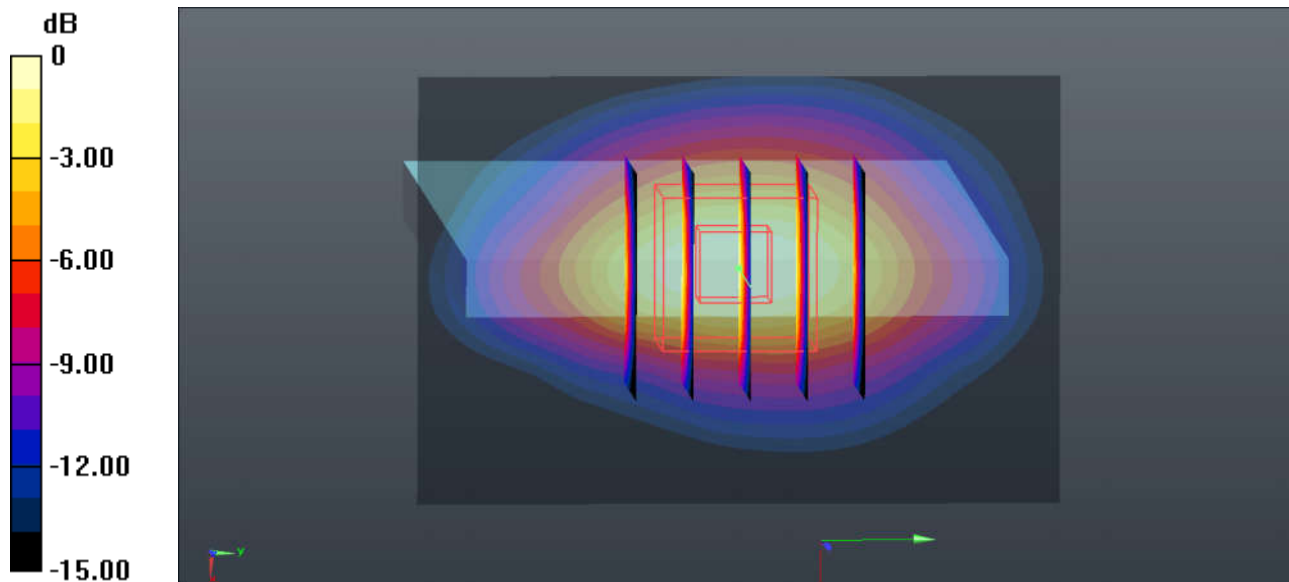

0 dB = 1.06 W/kg = 0.25 dBW/kg

### 24\_LTE Band 7\_20M\_QPSK\_100RB\_0Offset\_Bottom Side\_10mm\_Ch21100

Communication System: UID 0, LTE-FDD (0); Frequency: 2535 MHz; Duty Cycle: 1:1  
Medium: MSL\_2600 Medium parameters used:  $f = 2535$  MHz;  $\sigma = 2.109$  S/m;  $\epsilon_r = 53.649$ ;  $\rho = 1000$  kg/m<sup>3</sup>  
Ambient Temperature : 23.3 °C ; Liquid Temperature : 22.7 °C

#### DASY5 Configuration:

- Probe: EX3DV4 - SN3843; ConvF(6.7, 6.7, 6.7); Calibrated: 2018.9.27
- Sensor-Surface: 1.4mm (Mechanical Surface Detection)
- Electronics: DAE4 Sn1279; Calibrated: 2018.10.22
- Phantom: SAM2; Type: SAM; Serial: TP-1503
- Measurement SW: DASY52, Version 52.10 (1); SEMCAD X Version 14.6.11 (7439)

**Ch21100/Area Scan (51x81x1):** Interpolated grid: dx=1.200 mm, dy=1.200 mm  
Maximum value of SAR (interpolated) = 1.16 W/kg

**Ch21100/Zoom Scan (7x7x7)/Cube 0:** Measurement grid: dx=5mm, dy=5mm, dz=5mm  
Reference Value = 7.112 V/m; Power Drift = 0.06 dB  
Peak SAR (extrapolated) = 1.37 W/kg  
**SAR(1 g) = 0.696 W/kg; SAR(10 g) = 0.341 W/kg**  
Maximum value of SAR (measured) = 1.12 W/kg

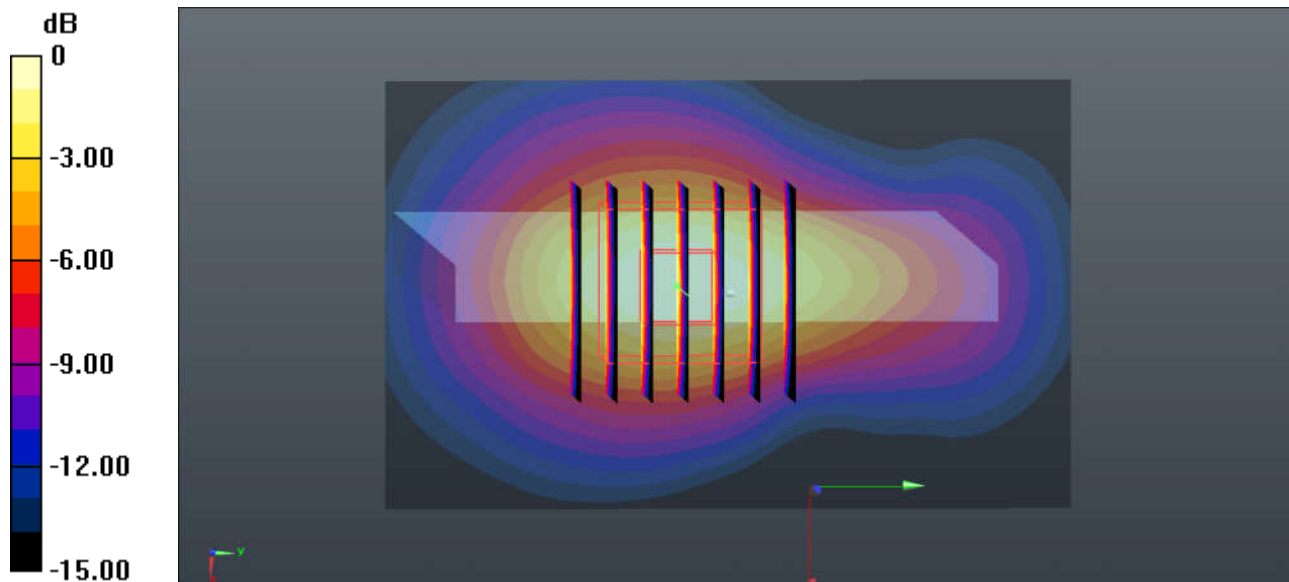

0 dB = 1.12 W/kg = 0.49 dBW/kg

### 25\_LTE Band 38-LAT\_20M\_QPSK\_1RB\_0Offset\_Bottom Side\_10mm\_Ch38000

Communication System: UID 0, LTE-TDD (0); Frequency: 2595 MHz; Duty Cycle: 1:1.59  
Medium: MSL\_2600 Medium parameters used:  $f = 2595$  MHz;  $\sigma = 2.196$  S/m;  $\epsilon_r = 53.435$ ;  $\rho = 1000$  kg/m<sup>3</sup>  
Ambient Temperature : 23.3 °C ; Liquid Temperature : 22.7 °C

#### DASY5 Configuration:

- Probe: EX3DV4 - SN3843; ConvF(6.7, 6.7, 6.7); Calibrated: 2018.9.27
- Sensor-Surface: 1.4mm (Mechanical Surface Detection)
- Electronics: DAE4 Sn1279; Calibrated: 2018.10.22
- Phantom: SAM2; Type: SAM; Serial: TP-1503
- Measurement SW: DASY52, Version 52.10 (1); SEMCAD X Version 14.6.11 (7439)

**Ch38000/Area Scan (51x81x1):** Interpolated grid: dx=1.200 mm, dy=1.200 mm  
Maximum value of SAR (interpolated) = 1.50 W/kg

**Ch38000/Zoom Scan (7x7x7)/Cube 0:** Measurement grid: dx=5mm, dy=5mm, dz=5mm  
Reference Value = 9.469 V/m; Power Drift = 0.01 dB  
Peak SAR (extrapolated) = 1.79 W/kg  
**SAR(1 g) = 0.894 W/kg; SAR(10 g) = 0.432 W/kg**  
Maximum value of SAR (measured) = 1.45 W/kg

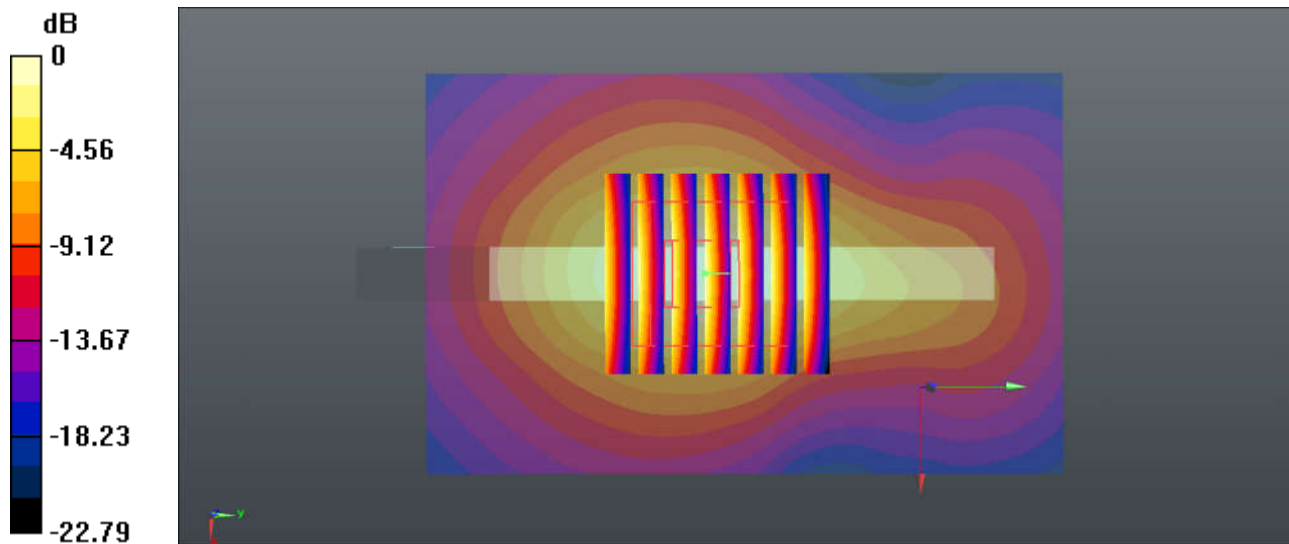

0 dB = 1.45 W/kg = 1.61 dBW/kg

**26\_WLAN2.4GHz\_802.11b 1Mbps\_Top Side\_10mm\_Ch11**

Communication System: UID 0, 802.11b (0); Frequency: 2462 MHz; Duty Cycle: 1:1  
 Medium: MSL\_2450 Medium parameters used:  $f = 2462$  MHz;  $\sigma = 2.009$  S/m;  $\epsilon_r = 53.952$ ;  $\rho = 1000$  kg/m<sup>3</sup>  
 Ambient Temperature : 23.2 °C ; Liquid Temperature : 22.6 °C

**DASY5 Configuration:**

- Probe: EX3DV4 - SN3843; ConvF(7.02, 7.02, 7.02); Calibrated: 2018.9.27
- Sensor-Surface: 1.4mm (Mechanical Surface Detection)
- Electronics: DAE4 Sn1279; Calibrated: 2018.10.22
- Phantom: SAM2; Type: SAM; Serial: TP-1503
- Measurement SW: DASY52, Version 52.10 (1); SEMCAD X Version 14.6.11 (7439)

**Ch11/Area Scan (51x81x1):** Interpolated grid: dx=1.200 mm, dy=1.200 mm  
 Maximum value of SAR (interpolated) = 0.348 W/kg

**Ch11/Zoom Scan (7x7x7)/Cube 0:** Measurement grid: dx=5mm, dy=5mm, dz=5mm  
 Reference Value = 3.079 V/m; Power Drift = 0.05 dB  
 Peak SAR (extrapolated) = 0.406 W/kg  
**SAR(1 g) = 0.215 W/kg; SAR(10 g) = 0.108 W/kg**  
 Maximum value of SAR (measured) = 0.335 W/kg

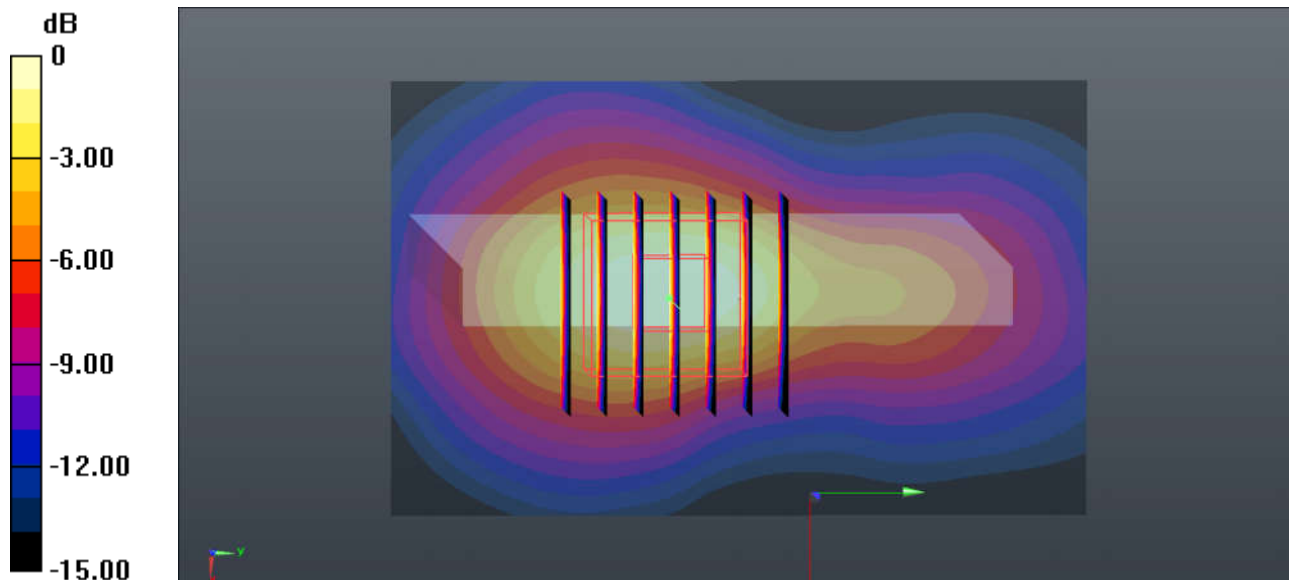

0 dB = 0.335 W/kg = -4.75 dBW/kg

### 27\_WLAN5GHz\_802.11a 6Mbps\_Back\_10mm\_Ant 1\_Ch44

Communication System: UID 0, 802.11a (0); Frequency: 5220 MHz; Duty Cycle: 1:1.021  
Medium: MSL\_5000 Medium parameters used:  $f = 5220$  MHz;  $\sigma = 5.463$  S/m;  $\epsilon_r = 47.885$ ;  $\rho = 1000$  kg/m<sup>3</sup>  
Ambient Temperature : 23.2 °C ; Liquid Temperature : 22.7 °C

#### DASY5 Configuration:

- Probe: EX3DV4 - SN3911; ConvF(4.67, 4.67, 4.67); Calibrated: 2019.1.22
- Sensor-Surface: 1.4mm (Mechanical Surface Detection)
- Electronics: DAE4 Sn1338; Calibrated: 2018.12.3
- Phantom: SAM2; Type: SAM; Serial: TP-1503
- Measurement SW: DASY52, Version 52.10 (1); SEMCAD X Version 14.6.11 (7439)

**Ch44/Area Scan (101x91x1):** Interpolated grid: dx=1.000 mm, dy=1.000 mm

Maximum value of SAR (interpolated) = 0.446 W/kg

**Ch44/Zoom Scan (9x8x7)/Cube 0:** Measurement grid: dx=4mm, dy=4mm, dz=1.4mm

Reference Value = 0.8460 V/m; Power Drift = -0.03 dB

Peak SAR (extrapolated) = 0.748 W/kg

**SAR(1 g) = 0.191 W/kg; SAR(10 g) = 0.063 W/kg**

Maximum value of SAR (measured) = 0.459 W/kg

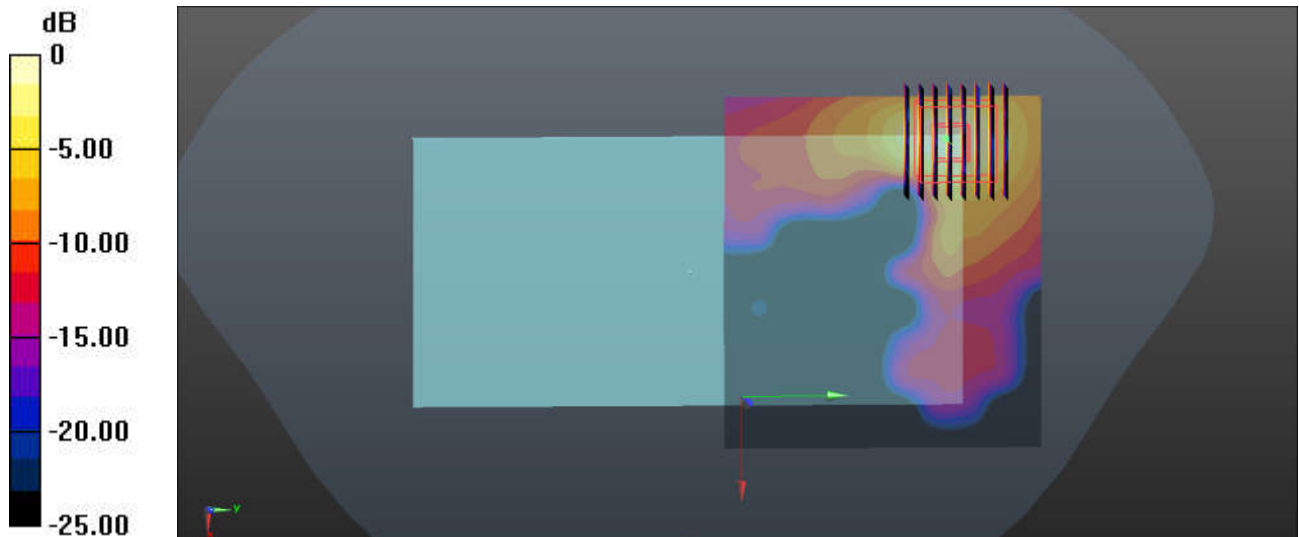

0 dB = 0.446 W/kg = -3.51 dBW/kg

### 28\_WLAN5GHz\_802.11a 6Mbps\_Back\_10mm\_Ant 1\_Ch161

Communication System: UID 0, 802.11a (0); Frequency: 5805 MHz; Duty Cycle: 1:1.021  
Medium: MSL\_5000 Medium parameters used:  $f = 5805$  MHz;  $\sigma = 6.248$  S/m;  $\epsilon_r = 46.962$ ;  $\rho = 1000$  kg/m<sup>3</sup>  
Ambient Temperature : 23.2 °C ; Liquid Temperature : 22.7 °C

#### DASY5 Configuration:

- Probe: EX3DV4 - SN3911; ConvF(4.16, 4.16, 4.16); Calibrated: 2019.1.22
- Sensor-Surface: 1.4mm (Mechanical Surface Detection)
- Electronics: DAE4 Sn1338; Calibrated: 2018.12.3
- Phantom: SAM2; Type: SAM; Serial: TP-1503
- Measurement SW: DASY52, Version 52.10 (1); SEMCAD X Version 14.6.11 (7439)

**Ch161/Area Scan (101x81x1):** Interpolated grid: dx=1.000 mm, dy=1.000 mm  
Maximum value of SAR (interpolated) = 1.39 W/kg

**Ch161/Zoom Scan (9x9x7)/Cube 0:** Measurement grid: dx=4mm, dy=4mm, dz=1.4mm  
Reference Value = 3.068 V/m; Power Drift = 0.03 dB  
Peak SAR (extrapolated) = 2.58 W/kg  
**SAR(1 g) = 0.617 W/kg; SAR(10 g) = 0.235 W/kg**  
Maximum value of SAR (measured) = 1.46 W/kg

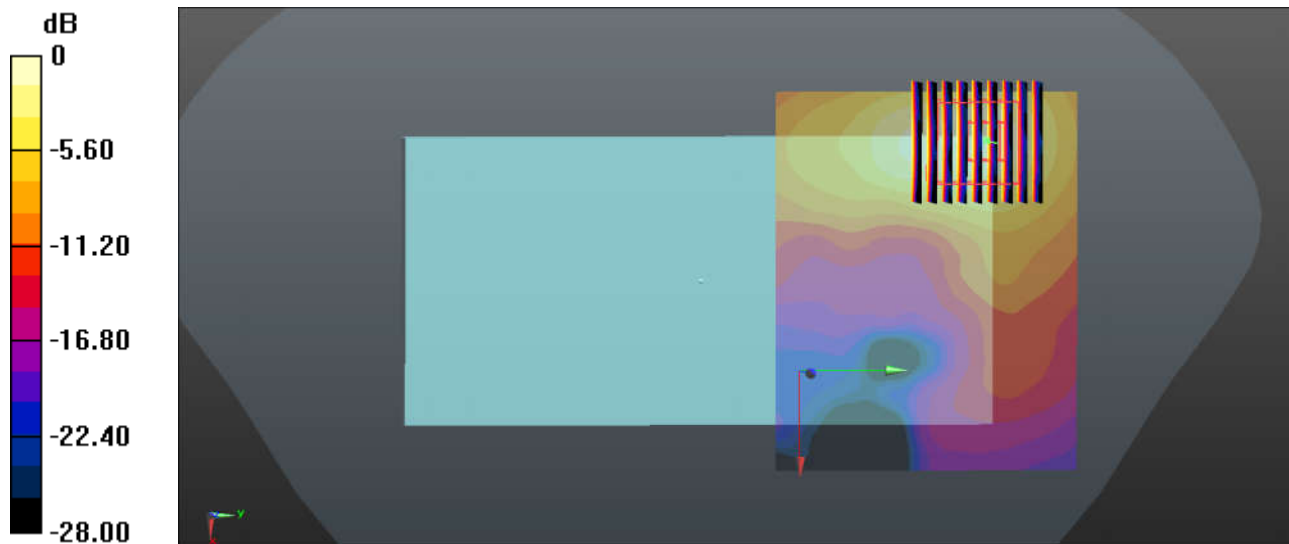

0 dB = 1.46 W/kg = 1.64 dBW/kg

### 29\_Bluetooth\_1Mbps\_Top Side\_10mm\_Ch78

Communication System: UID 0, Bluetooth (0); Frequency: 2480 MHz; Duty Cycle: 1:1.3  
Medium: MSL\_2450 Medium parameters used:  $f = 2480$  MHz;  $\sigma = 2.033$  S/m;  $\epsilon_r = 53.884$ ;  $\rho = 1000$  kg/m<sup>3</sup>  
Ambient Temperature : 23.2 °C ; Liquid Temperature : 22.6 °C

#### DASY5 Configuration:

- Probe: EX3DV4 - SN3843; ConvF(7.02, 7.02, 7.02); Calibrated: 2018.9.27
- Sensor-Surface: 1.4mm (Mechanical Surface Detection)
- Electronics: DAE4 Sn1279; Calibrated: 2018.10.22
- Phantom: SAM2; Type: SAM; Serial: TP-1503
- Measurement SW: DASY52, Version 52.10 (1); SEMCAD X Version 14.6.11 (7439)

**Ch78/Area Scan (51x81x1):** Interpolated grid: dx=1.200 mm, dy=1.200 mm  
Maximum value of SAR (interpolated) = 0.0764 W/kg

**Ch78/Zoom Scan (7x7x7)/Cube 0:** Measurement grid: dx=5mm, dy=5mm, dz=5mm  
Reference Value = 1.195 V/m; Power Drift = 0.04 dB  
Peak SAR (extrapolated) = 0.0940 W/kg  
**SAR(1 g) = 0.048 W/kg; SAR(10 g) = 0.024 W/kg**  
Maximum value of SAR (measured) = 0.0762 W/kg

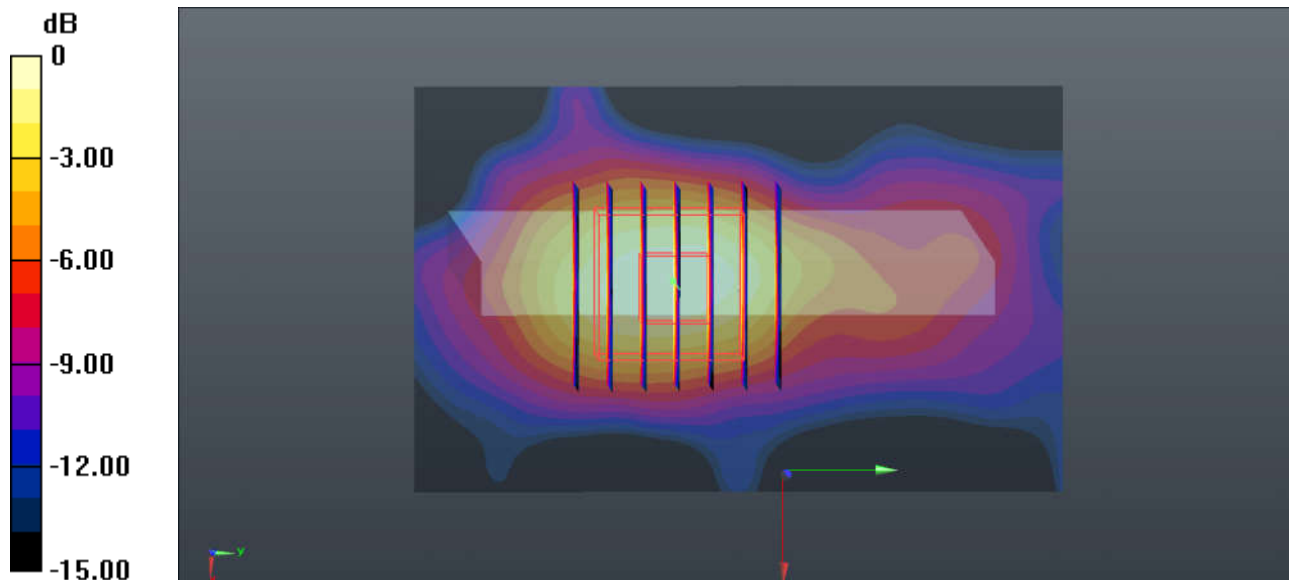

0 dB = 0.0762 W/kg = -11.18 dBW/kg



### 30\_GSM850-LAT\_GPRS 4 Tx slots\_Back\_15mm\_Ch189

Communication System: UID 0, GSM850-4UP (0); Frequency: 836.4 MHz; Duty Cycle: 1:2.08  
Medium: MSL\_835 Medium parameters used:  $f = 836.4$  MHz;  $\sigma = 1$  S/m;  $\epsilon_r = 56.462$ ;  $\rho = 1000$  kg/m<sup>3</sup>  
Ambient Temperature : 23.2 °C ; Liquid Temperature : 22.7 °C

#### DASY5 Configuration:

- Probe: EX3DV4 - SN3843; ConvF(9.03, 9.03, 9.03); Calibrated: 2018.9.27
- Sensor-Surface: 1.4mm (Mechanical Surface Detection)
- Electronics: DAE4 Sn1279; Calibrated: 2018.10.22
- Phantom: SAM1; Type: SAM; Serial: TP-1839
- Measurement SW: DASY52, Version 52.10 (1); SEMCAD X Version 14.6.11 (7439)

**Ch189/Area Scan (71x81x1):** Interpolated grid: dx=1.500 mm, dy=1.500 mm  
Maximum value of SAR (interpolated) = 0.248 W/kg

**Ch189/Zoom Scan (6x5x7)/Cube 0:** Measurement grid: dx=8mm, dy=8mm, dz=5mm  
Reference Value = 15.93 V/m; Power Drift = -0.01 dB  
Peak SAR (extrapolated) = 0.273 W/kg  
**SAR(1 g) = 0.196 W/kg; SAR(10 g) = 0.149 W/kg**  
Maximum value of SAR (measured) = 0.244 W/kg

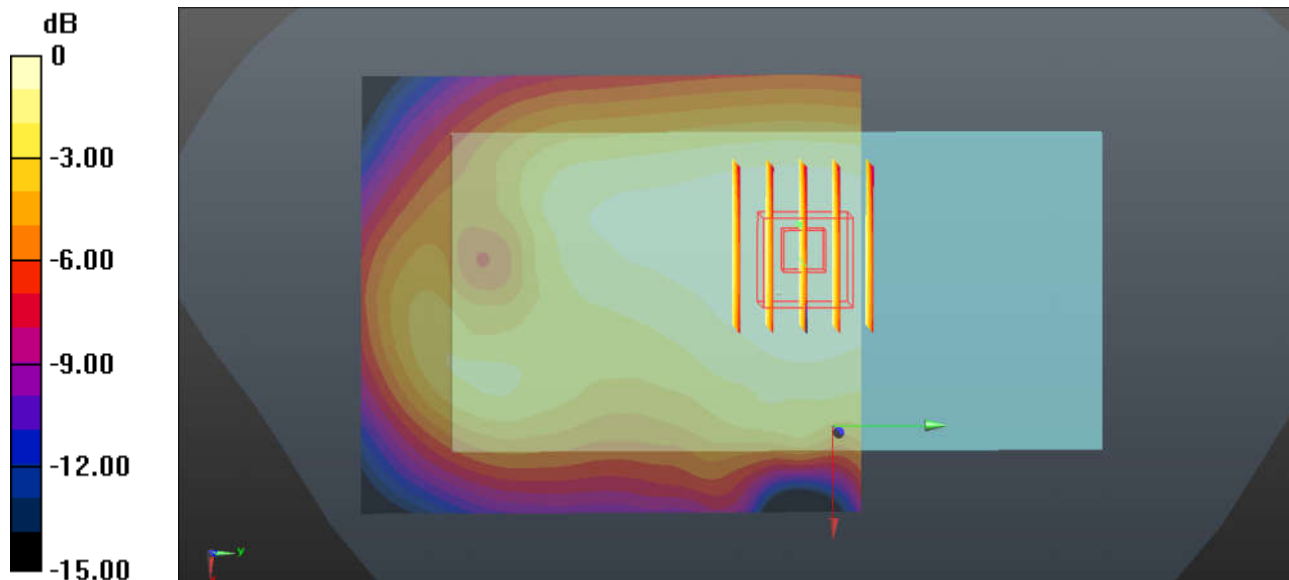

0 dB = 0.244 W/kg = -6.13 dBW/kg