



# FCC RF Test Report

**APPLICANT** : Xiaomi Communications Co., Ltd.  
**EQUIPMENT** : Mobile Phone  
**BRAND NAME** : MI  
**MODEL NAME** : M1803D5XA  
**FCC ID** : 2AFZZ-XMSD5X  
**STANDARD** : FCC 47 CFR Part 2, 27(D)  
**CLASSIFICATION** : PCS Licensed Transmitter Held to Ear (PCE)

The product was received on Feb. 08, 2018 and completely tested on Mar. 24, 2018. We, Sporton International (Kunshan) Inc., would like to declare that the tested sample has been evaluated in accordance with the procedures given in ANSI/TIA-603-E and shown compliance with the applicable technical standards.

The test results in this report apply exclusively to the tested model / sample. Without written approval of Sporton International (Kunshan) Inc., the test report shall not be reproduced except in full.



Approved by: James Huang / Manager

**Sporton International (Kunshan) Inc.**

**No.3-2 Ping-Xiang Rd, Kunshan Development Zone Kunshan City Jiangsu Province 215335  
China**



TABLE OF CONTENTS

REVISION HISTORY.....3
SUMMARY OF TEST RESULT .....4
1 GENERAL DESCRIPTION .....5
1.1 Applicant.....5
1.2 Manufacturer.....5
1.3 Product Feature of Equipment Under Test.....5
1.4 Product Specification of Equipment Under Test.....6
1.5 Modification of EUT .....6
1.6 Maximum Frequency Tolerance and Emission Designator and Conducted Power.....6
1.7 Testing Site.....7
1.8 Applied Standards .....7
2 TEST CONFIGURATION OF EQUIPMENT UNDER TEST .....8
2.1 Test Mode.....8
2.2 Connection Diagram of Test System.....9
2.3 Support Unit used in test configuration and system.....9
2.4 Measurement Results Explanation Example.....10
2.5 Frequency List of Low/Middle/High Channels.....10
3 CONDUCTED TEST ITEMS .....11
3.1 Measuring Instruments .....11
3.2 Test Setup .....11
3.3 Test Result of Conducted Test.....11
3.4 Conducted Output Power Measurement .....12
3.5 Peak-to-Average Ratio .....13
3.6 EIRP Power Density .....14
3.7 Occupied Bandwidth.....15
3.8 Conducted Band Edge Measurement .....16
3.9 Conducted Spurious Emission Measurement .....17
3.10 Frequency Stability Measurement.....18
4 RADIATED TEST ITEMS .....19
4.1 Measuring Instruments .....19
4.2 Test Setup .....19
4.3 Test Result of Radiated Test.....19
4.4 Radiated Spurious Emission Measurement .....20
5 LIST OF MEASURING EQUIPMENT .....21
6 UNCERTAINTY OF EVALUATION .....22
APPENDIX A. TEST RESULTS OF CONDUCTED TEST
APPENDIX B. TEST RESULTS OF RADIATED TEST
APPENDIX C. TEST SETUP PHOTOGRAPHS





### SUMMARY OF TEST RESULT

Report Section	FCC Rule	Description	Limit	Result	Remark
3.4	§2.1046	Conducted Output Power	Reporting Only	PASS	-
3.5	-	Peak-to-Average Ratio	<13dB	N/A	Reporting only
3.6	§27.50 (a)(3)	EIRP Power Density	EIRP < 250mW/5MHz	PASS	-
3.7	§2.1049	Occupied Bandwidth	Reporting Only	PASS	-
3.8	§2.1051 §27.53 (a)(4)	Conducted Band Edge Measurement	Refer standard	PASS	-
3.9	§2.1051 §27.53 (a)(4)	Conducted Spurious Emission	< 70+10log <sub>10</sub> (P[Watts])	PASS	-
3.10	§2.1055 §27.54	Frequency Stability Temperature & Voltage	Within the band	PASS	-
4.4	§2.1053 §27.53 (a)(4)	Radiated Spurious Emission	< 70+10log <sub>10</sub> (P[Watts])	PASS	Under limit 4.30 dB at 16140.000 MHz



# 1 General Description

## 1.1 Applicant

Xiaomi Communications Co., Ltd.

The Rainbow City of China Resources, NO.68, Qinghe Middle Street, Haidian District, Beijing, China

## 1.2 Manufacturer

Xiaomi Communications Co., Ltd.

The Rainbow City of China Resources, NO.68, Qinghe Middle Street, Haidian District, Beijing, China

## 1.3 Product Feature of Equipment Under Test

Product Feature	
Equipment	Mobile Phone
Brand Name	MI
Model Name	M1803D5XA
FCC ID	2AFZZ-XMSD5X
EUT supports Radios application	CDMA/EV-DO/GSM/GPRS/EGPRS/WCDMA/HSPA/ DC-HSDPA/HSPA+/LTE/NFC WLAN 2.4GHz 802.11b/g/n HT20/HT40/ WLAN 5GHz 802.11a/n HT20/HT40/ WLAN 5GHz 802.11ac VHT20/VHT40/VHT80/ Bluetooth v3.0 + EDR/Bluetooth v4.0 LE/ Bluetooth v4.1 LE/Bluetooth v4.2 LE/Bluetooth v5.0 LE
IMEI Code	Conducted: 867601030224817/867601030224825 Radiation: 867601030225855/867601030225863
HW Version	P3.0
SW Version	MIUI 9
EUT Stage	Pre-Production Unit

**Remark:** There are two types of EUT sample 1 and sample 2, the differences between two samples are only for Flash, sample 1 is 6GB+64GB, sample 2 is 6GB+128GB. According to the difference, choose sample 1 to perform full tests.

## 1.4 Product Specification of Equipment Under Test

Product Feature	
Tx Frequency	LTE Band 30 : 2307.5 MHz ~ 2312.5 MHz
Rx Frequency	LTE Band 30 : 2352.5 MHz ~ 2357.5 MHz
Bandwidth	5MHz / 10MHz
Maximum Output Power to Antenna	LTE Band 30 : 22.80 dBm
Antenna Type	LDS Antenna
Antenna Gain	-2.18dBi
Type of Modulation	QPSK / 16QAM / 64QAM

## 1.5 Modification of EUT

No modifications are made to the EUT during all test items.

## 1.6 Maximum Frequency Tolerance and Emission Designator and Conducted Power

LTE Band 30		QPSK			16QAM		
BW (MHz)	Frequency Range (MHz)	Emission Designator (99%OBW)	Frequency Tolerance (ppm)	Maximum Conducted power(W)	Emission Designator (99%OBW)	Frequency Tolerance (ppm)	Maximum Conducted power(W)
5	2307.5 ~ 2312.5	4M50G7D	-	0.1875	4M50W7D	-	0.1633
10	2310.0	9M03G7D	0.0014	0.1905	8M99W7D	-	0.1641
LTE Band 30		64QAM					
BW (MHz)	Frequency Range (MHz)	Emission Designator (99%OBW)	Frequency Tolerance (ppm)	Maximum Conducted power(W)			
5	2307.5 ~ 2312.5	4M51W7D	-	0.1274			
10	2310.0	9M09W7D	-	0.1276			

## 1.7 Testing Site

Sporton International (Kunshan) Inc. is accredited to ISO 17025 by National Voluntary Laboratory Accreditation Program (NVLAP code: 600155-0) and the FCC designation No. is CN5013.

<b>Test Site</b>	Sporton International (Kunshan) Inc.		
<b>Test Site Location</b>	No.3-2 Ping-Xiang Rd, Kunshan Development Zone Kunshan City Jiangsu Province 215335 China TEL : +86-512-57900158 FAX : +86-512-57900958		
<b>Test Site No.</b>	<b>Sporton Site No.</b>		<b>FCC Test Firm Registration No.</b>
	TH01-KS	03CH03-KS	630927

**Note:** The test site complies with ANSI C63.4 2014 requirement.

## 1.8 Applied Standards

According to the specifications of the manufacturer, the EUT must comply with the requirements of the following standards:

- ♦ 47 CFR Part 2, Part 27(D)
- ♦ ANSI/TIA-603-E
- ♦ FCC KDB 971168 D01 Power Meas. License Digital Systems v03

**Remark:**

1. All test items were verified and recorded according to the standards and without any deviation during the test.
2. This EUT has also been tested and complied with the requirements of FCC Part 15, Subpart B, recorded in a separate test report.



## 2 Test Configuration of Equipment Under Test

### 2.1 Test Mode

Antenna port conducted and radiated test items listed below are performed according to KDB 971168 D01 Power Meas. License Digital Systems v03 with maximum output power.

Radiated measurements are performed by rotating the EUT in three different orthogonal test planes to find the maximum emission.

Conducted Test Cases	Band	Bandwidth (MHz)						Modulation			RB #			Test Channel			
		1.4	3	5	10	15	20	QPSK	16QAM	64QAM	1	Half	Full	L	M	H	
Max. Output Power	30	-	-	V		-	-	V	V	V	V	V	V	V	V	V	
		-	-		V	-	-	V	V	V	V	V	V		V		
Peak-to-Average Ratio	30	-	-		V	-	-	V	V	V	V		V		V		
E.I.R.P PSD	30	-	-	V		-	-	V	V	V	V			V	V	V	
		-	-		V	-	-	V	V	V	V				V		
26dB and 99% Bandwidth	30	-	-	V		-	-	V	V	V			V	V	V	V	
		-	-		V	-	-	V	V	V			V		V		
Conducted Band Edge	30	-	-	V		-	-	V	V	V	V		V	V		V	
		-	-		V	-	-	V	V	V	V		V		V		
Conducted Spurious Emission	30	-	-	V		-	-	V	V	V	V			V	V	V	
		-	-		V	-	-	V	V	V	V				V		
Frequency Stability	30	-	-		V	-	-	V					V		V		
Radiated Spurious Emission	30	-	-	V		-	-	V				V			-	-	-
					V			V				V				V	
Note	<ol style="list-style-type: none"> <li>The mark "v " means that this configuration is chosen for testing</li> <li>The mark "- " means that this bandwidth is not supported.</li> <li>The device is investigated from 30MHz to 10 times of fundamental signal for radiated spurious emission test under different BW/RB size/offset and modulations in exploratory test. Subsequently, only the worst case emissions are reported.</li> </ol>																



## 2.2 Connection Diagram of Test System

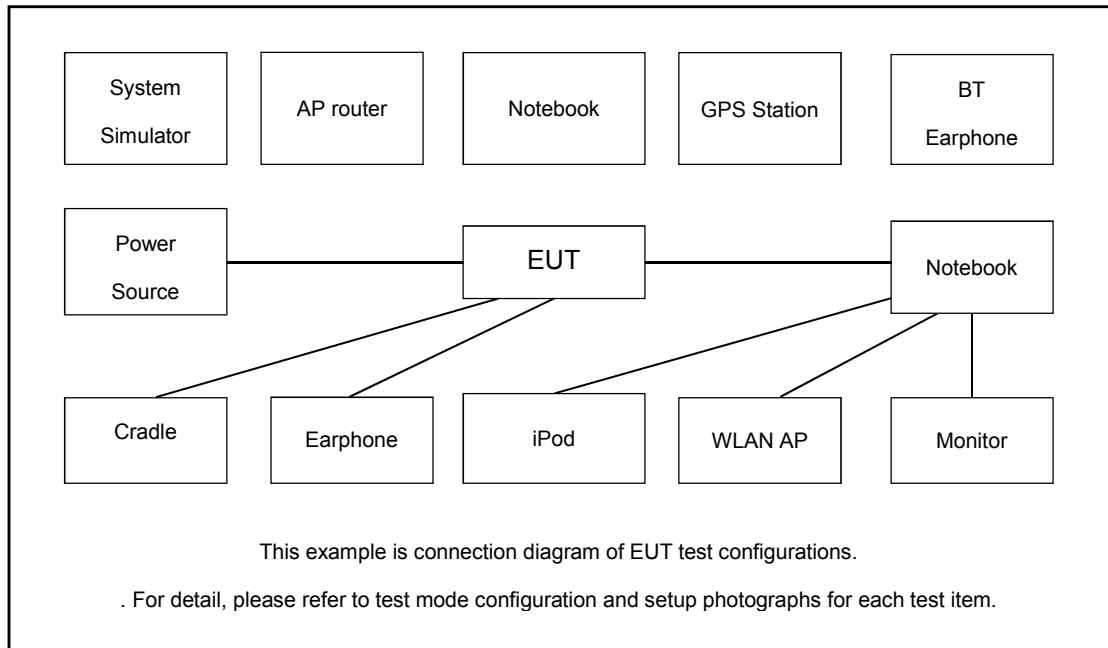

## 2.3 Support Unit used in test configuration and system

Item	Equipment	Trade Name	Model No.	FCC ID	Data Cable	Power Cord
1.	LTE Base Station	Anritsu	MT8820C	N/A	N/A	Unshielded,1.8m
2.	DC Power Supply	GW INSTEK	GPS-3030D	N/A	N/A	Unshielded,1.8 m

## 2.4 Measurement Results Explanation Example

For all conducted test items:

The offset level is set in the spectrum analyzer to compensate the RF cable loss between EUT conducted output port and spectrum analyzer. With the offset compensation, the spectrum analyzer reading level is exactly the EUT RF output level.

The spectrum analyzer offset is derived from RF cable loss.

*Offset = RF cable loss.*

Following shows an offset computation example with cable loss 5.5 dB.

Example :

$$\begin{aligned} \text{Offset(dB)} &= \text{RF cable loss(dB)}. \\ &= 5.5 \text{ (dB)} \end{aligned}$$

## 2.5 Frequency List of Low/Middle/High Channels

LTE Band 30 Channel and Frequency List				
BW [MHz]	Channel/Frequency(MHz)	Lowest	Middle	Highest
10	Channel	-	27710	-
	Frequency	-	2310	-
5	Channel	27685	27710	27735
	Frequency	2307.5	2310	2312.5

### 3 Conducted Test Items

#### 3.1 Measuring Instruments

See list of measuring instruments of this test report.

#### 3.2 Test Setup

##### 3.2.1 Conducted Output Power

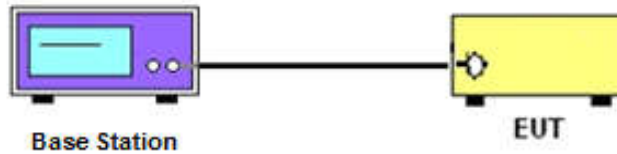

##### 3.2.2 Peak-to-Average Ratio, Occupied / 26dB Bandwidth ,Band-Edge and Conducted Spurious Emission

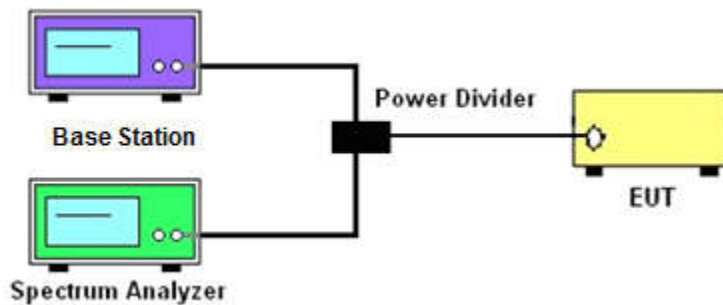

##### 3.2.3 Frequency Stability

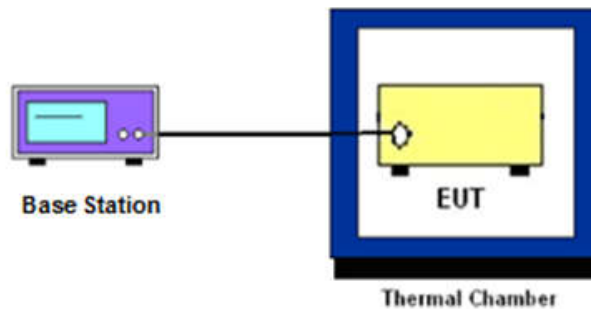

### 3.3 Test Result of Conducted Test

Please refer to Appendix A.



## **3.4 Conducted Output Power Measurement**

### **3.4.1 Description of the Conducted Output Power Measurement**

A base station simulator was used to establish communication with the EUT. Its parameters were set to transmit the maximum power on the EUT. The measured power in the radio frequency on the transmitter output terminals shall be reported.

### **3.4.2 Test Procedures**

1. The transmitter output port was connected to the system simulator.
2. Set EUT at maximum power through the system simulator.
3. Select lowest, middle, and highest channels for each band and different modulation.
4. Measure and record the power level from the system simulator.



## **3.5 Peak-to-Average Ratio**

### **3.5.1 Description of the PAR Measurement**

Power Complementary Cumulative Distribution Function (CCDF) curves provide a means for characterizing the power peaks of a digitally modulated signal on a statistical basis. A CCDF curve depicts the probability of the peak signal amplitude exceeding the average power level. Most contemporary measurement instrumentation include the capability to produce CCDF curves for an input signal provided that the instrument's resolution bandwidth can be set wide enough to accommodate the entire input signal bandwidth. In measuring transmissions in this band using an average power technique, the peak-to-average ratio (PAR) of the transmission may not exceed 13 dB.

### **3.5.2 Test Procedures**

1. The testing follows FCC KDB 971168 v03 Section 5.7.1.
2. The EUT was connected to spectrum and system simulator via a power divider.
3. Set the CCDF (Complementary Cumulative Distribution Function) option in spectrum analyzer.
4. The highest RF powers were measured and recorded the maximum PAPR level associated with a probability of 0.1 %.
5. Record the deviation as Peak to Average Ratio.



## 3.6 EIRP Power Density

### 3.6.1 Description of EIRP Power Density

For mobile and portable stations transmitting in the 2305-2315 MHz band or the 2350-2360 MHz band, the average EIRP must not exceed 50 milliwatts within any 1 megahertz of authorized bandwidth, *except that* for mobile and portable stations compliant with 3GPP LTE standards or another advanced mobile broadband protocol that avoids concentrating energy at the edge of the operating band the average EIRP must not exceed 250 milliwatts within any 5 megahertz of authorized bandwidth but may exceed 50 milliwatts within any 1 megahertz of authorized bandwidth. For mobile and portable stations using time division duplexing (TDD) technology, the duty cycle must not exceed 38 percent in the 2305-2315 MHz and 2350-2360 MHz bands. Mobile and portable stations using FDD technology are restricted to transmitting in the 2305-2315 MHz band. Power averaging shall not include intervals in which the transmitter is off.

### 3.6.2 Test Procedures

1. The testing follows FCC KDB 971168 v03 Section 5.7.1.
2. Set instrument center frequency to OBW center frequency.
3. Set span to at least 1.5 times the OBW.
4. Set the RBW to the specified reference bandwidth (5MHz).
5. Set VBW  $\geq 3 \times$  RBW.
6. Detector = RMS (power averaging).
7. Ensure that the number of measurement points in the sweep  $\geq 2 \times$  span/RBW.
8. Sweep time = auto couple.
9. Employ trace averaging (RMS) mode over a minimum of 100 traces.
10. Use the peak marker function to determine the maximum amplitude level within the reference bandwidth (PSD).



## **3.7 Occupied Bandwidth**

### **3.7.1 Description of Occupied Bandwidth Measurement**

The occupied bandwidth is the width of a frequency band such that, below the lower and above the upper frequency limits, the mean powers emitted are each equal to a specified percentage 0.5% of the total mean transmitted power.

The 26dB occupied bandwidth is the width of a frequency band such that, below the lower and above the upper frequency limits, the mean powers emitted are each equal 26 dB.

The 26 dB emission bandwidth(EBW) is defined as the frequency range between two points, one above and one below the carrier frequency, at which the spectral density of the emission is attenuated 26 dB below the maximum in-band spectral density of the modulated signal. Spectral density (power per unit bandwidth) is to be measured with a detector of resolution bandwidth equal to approximately 1.0% of the emission bandwidth.

### **3.7.2 Test Procedures**

1. The EUT was connected to Spectrum Analyzer and Base Station via power divider.
2. The 26dB and 99% occupied bandwidth (BW) of the middle channel for the highest RF powers with full RB sizes were measured.

## 3.8 Conducted Band Edge Measurement

### 3.8.1 Description of Conducted Band Edge Measurement

27.53 (a)(4)

For mobile and portable stations operating in the 2305-2315 MHz and 2350-2360 MHz bands:

(i) By a factor of not less than:  $43 + 10 \log (P)$  dB on all frequencies between 2305 and 2320 MHz and on all frequencies between 2345 and 2360 MHz that are outside the licensed band(s) of operation, not less than  $55 + 10 \log (P)$  dB on all frequencies between 2320 and 2324 MHz and on all frequencies between 2341 and 2345 MHz, not less than  $61 + 10 \log (P)$  dB on all frequencies between 2324 and 2328 MHz and on all frequencies between 2337 and 2341 MHz, and not less than  $67 + 10 \log (P)$  dB on all frequencies between 2328 and 2337 MHz;

(ii) By a factor of not less than  $43 + 10 \log (P)$  dB on all frequencies between 2300 and 2305 MHz,  $55 + 10 \log (P)$  dB on all frequencies between 2296 and 2300 MHz,  $61 + 10 \log (P)$  dB on all frequencies between 2292 and 2296 MHz,  $67 + 10 \log (P)$  dB on all frequencies between 2288 and 2292 MHz, and  $70 + 10 \log (P)$  dB below 2288 MHz;

(iii) By a factor of not less than  $43 + 10 \log (P)$  dB on all frequencies between 2360 and 2365 MHz, and not less than  $70 + 10 \log (P)$  dB above 2365 MHz.

### 3.8.2 Test Procedures

1. The EUT was connected to Spectrum Analyzer and Base Station via power divider.
2. The band edges of low and high channels were measured with  $RBW \geq 1\%$  EBW set in Spectrum Analyzer, while the EUT was transmitting under maximum power.
3. The RF fundamental frequency should be excluded against the limit line in the operating frequency band.
4. The limit line is derived from  $43 + 10 \log(P)$  dB below the transmitter power P(Watts)  
=  $P(W) - [43 + 10 \log(P)]$  (dB) =  $[30 + 10 \log(P)]$  (dBm) -  $[43 + 10 \log(P)]$  (dB) = -13dBm.  
=  $[30 + 10 \log(P)]$  (dBm) -  $[43 + 10 \log(P)]$  (dB) = -13dBm.



## 3.9 Conducted Spurious Emission Measurement

### 3.9.1 Description of Conducted Spurious Emission Measurement

The power of any emission outside of the authorized operating frequency ranges must be lower than the transmitter power (P) by a factor of at least  $70 + 10 \log (P)$  dB.

It is measured by means of a calibrated spectrum analyzer and scanned from 30MHz up to a frequency including its 10<sup>th</sup> harmonic.

### 3.9.2 Test Procedures

1. The EUT was connected to spectrum analyzer and base station via power divider.
2. The RF output of EUT was connected to the spectrum analyzer by RF cable and attenuator.  
The path loss was compensated to the results for each measurement.
3. The middle channel for the highest RF power within the transmitting frequency was measured.
4. The conducted spurious emission for the whole frequency range was taken.
5. Make the measurement with the spectrum analyzer's RBW = 1MHz, VBW = 3MHz, taking the record of maximum spurious emission.
6. The RF fundamental frequency should be excluded against the limit line in the operating frequency band.
7. The limit line is derived from  $70 + 10\log(P)$ dB below the transmitter power P(Watts)  
 $= P(W) - [70 + 10\log(P)]$  (dB)  
 $= [30 + 10\log(P)]$  (dBm) -  $[70 + 10\log(P)]$  (dB)  
 $= -40$ dBm.

## 3.10 Frequency Stability Measurement

### 3.10.1 Description of Frequency Stability Measurement

The frequency stability shall be measured by variation of ambient temperature and variation of primary supply voltage to ensure that the fundamental emission stays within the authorized frequency block. The frequency stability of the transmitter shall be maintained within  $\pm 0.00025\%$  ( $\pm 2.5\text{ppm}$ ) of the center frequency.

### 3.10.2 Test Procedures for Temperature Variation

1. The EUT was set up in the thermal chamber and connected with the base station.
2. With power OFF, the temperature was decreased to  $-30^{\circ}\text{C}$  and the EUT was stabilized before testing. Power was applied and the maximum change in frequency was recorded within one minute.
3. With power OFF, the temperature was raised in  $10^{\circ}\text{C}$  step up to  $50^{\circ}\text{C}$ . The EUT was stabilized at each step for at least half an hour. Power was applied and the maximum frequency change was recorded within one minute.

### 3.10.3 Test Procedures for Voltage Variation

1. The EUT was placed in a temperature chamber at  $25\pm 5^{\circ}\text{C}$  and connected with the base station.
2. The power supply voltage to the EUT was varied from 85% to 115% of the nominal value measured at the input to the EUT.
3. The variation in frequency was measured for the worst case.

## 4 Radiated Test Items

### 4.1 Measuring Instruments

See list of measuring instruments of this test report.

### 4.2 Test Setup

#### 4.2.1 For radiated test from 30MHz to 1GHz

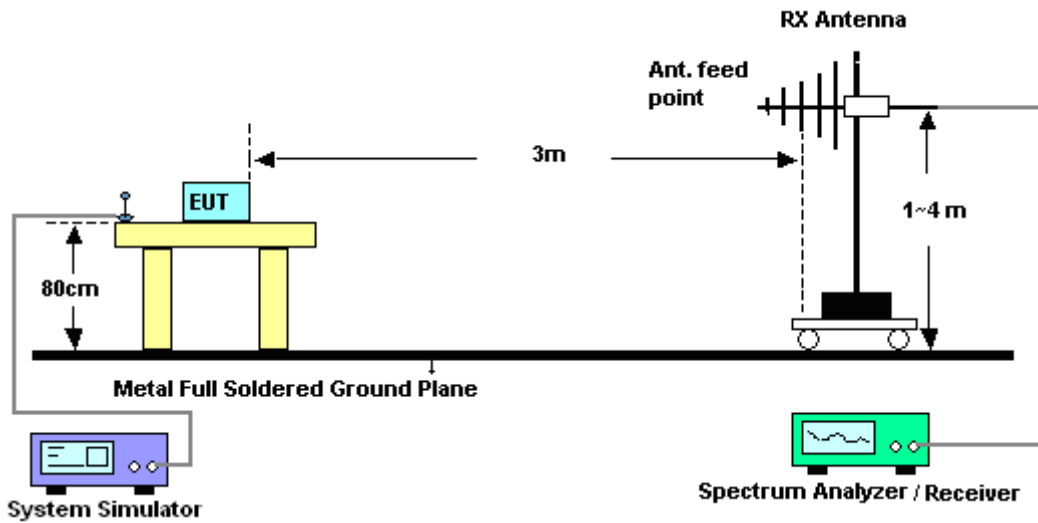

#### 4.2.2 For radiated test above 1GHz

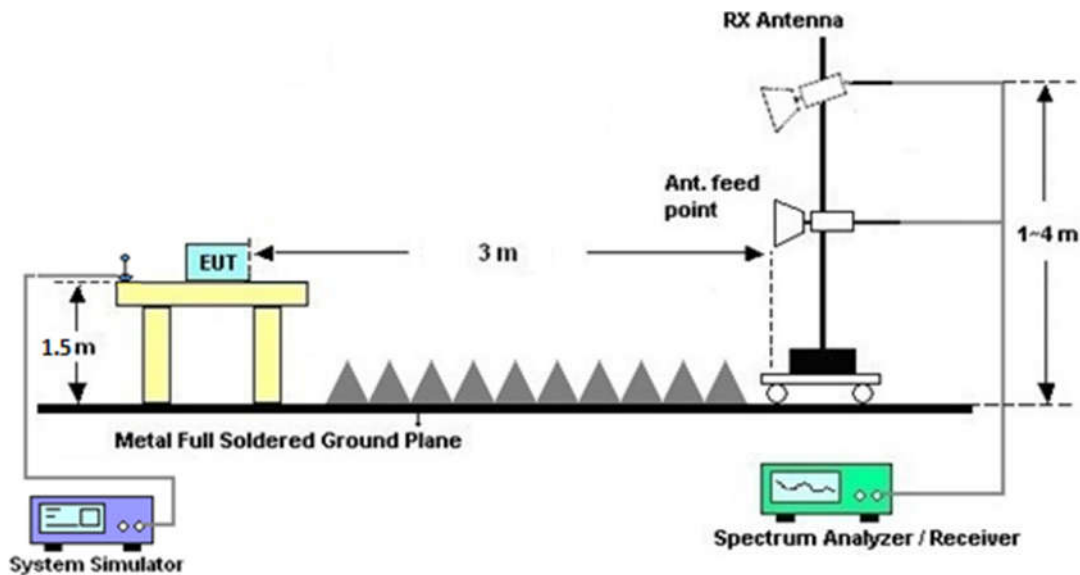

### 4.3 Test Result of Radiated Test

Please refer to Appendix B.



## 4.4 Radiated Spurious Emission Measurement

### 4.4.1 Description of Radiated Spurious Emission

The radiated spurious emission was measured by substitution method according to ANSI / TIA-603-E. The power of any emission outside of the authorized operating frequency ranges must be attenuated below the transmitter power (P) by a factor of at least  $70 + 10 \log (P)$  dB.

### 4.4.2 Test Procedures

1. The EUT was placed on a turntable with 0.8 meter for frequency below 1GHz and 1.5 meter for frequency above 1GHz respectively above ground.
2. The EUT was set 3 meters from the receiving antenna, which was mounted on the antenna tower.
3. The table was rotated 360 degrees to determine the position of the highest spurious emission.
4. The height of the receiving antenna is varied between one meter and four meters to search the maximum spurious emission for both horizontal and vertical polarizations.
5. Make the measurement with the spectrum analyzer's RBW = 1MHz, VBW = 3MHz, Sweep = 500ms, Taking the record of maximum spurious emission.
6. A horn antenna was substituted in place of the EUT and was driven by a signal generator.
7. Tune the output power of signal generator to the same emission level with EUT maximum spurious emission.
8. Taking the record of output power at antenna port.
9. Repeat step 7 to step 8 for another polarization.
10. The RF fundamental frequency should be excluded against the limit line in the operating frequency band.  
The limit line is derived from  $70 + 10\log(P)$ dB below the transmitter power P(Watts)  
 $= P(W) - [70 + 10\log(P)]$  (dB)  
 $= [30 + 10\log(P)]$  (dBm) -  $[70 + 10\log(P)]$  (dB)  
 $= -40$ dBm.
11. EIRP (dBm) = S.G. Power – Tx Cable Loss + Tx Antenna Gain



## 5 List of Measuring Equipment

Instrument	Manufacturer	Model No.	Serial No.	Characteristics	Calibration Date	Test Date	Due Date	Remark
Spectrum Analyzer	R&S	FSV40	101040	10Hz~40GHz	Aug. 08, 2017	Mar. 15, 2018	Aug. 07, 2018	Conducted (TH01-KS)
Radio communication analyzer	Anritsu	MT8820C	6201300652	2G/3G/LTE_full band	Aug. 08, 2017	Mar. 15, 2018	Aug. 07, 2018	Conducted (TH01-KS)
Thermal Chamber	Ten Billion	TTC-B3S	TBN-960502	-40~+150°C	Oct. 12, 2017	Mar. 15, 2018	Oct. 11, 2018	Conducted (TH01-KS)
EXA Spectrum Analyzer	Keysight	N9010A	MY55150244	10Hz-44GHz	Apr. 18, 2017	Mar. 24, 2018	Apr. 17, 2018	Radiation (03CH03-KS)
Bilog Antenna	TeseQ	CBL6112D	35406	25MHz-2GHz	Apr. 22, 2017	Mar. 24, 2018	Apr. 21, 2018	Radiation (03CH03-KS)
Horn Antenna	Schwarzbeck	BBHA9120D	9120D-1356	1GHz~18GHz	Apr. 22, 2017	Mar. 24, 2018	Apr. 21, 2018	Radiation (03CH03-KS)
SHF-EHF Horn	Schwarzbeck	BBHA 9170	BBHA170249	15GHz~40GHz	Feb. 07, 2018	Mar. 24, 2018	Feb. 06, 2019	Radiation (03CH03-KS)
Amplifier	com-power	PA-103A	161069	1MHz ~1000MHz / 32 dB	Apr. 18, 2017	Mar. 24, 2018	Apr. 17, 2018	Radiation (03CH03-KS)
high gain Amplifier	MITEQ	AMF-7D-00 101800-30-1 0P	2025788	1Ghz-18Ghz	Apr. 18, 2017	Mar. 24, 2018	Apr. 17, 2018	Radiation (03CH03-KS)
Amplifier	MITEQ	TTA1840-35 -HG	1887435	18~40GHz	Oct. 12, 2017	Mar. 24, 2018	Oct. 11, 2018	Radiation (03CH03-KS)
Amplifier	Agilent	8449B	3008A02370	1GHz~26.5GHz	Oct. 12, 2017	Mar. 24, 2018	Oct. 11, 2018	Radiation (03CH03-KS)
AC Power Source	Chroma	61601	F104090004	N/A	NCR	Mar. 24, 2018	NCR	Radiation (03CH03-KS)
Turn Table	ChamPro	EM 1000-T	060762-T	0~360 degree	NCR	Mar. 24, 2018	NCR	Radiation (03CH03-KS)
Antenna Mast	ChamPro	EM 1000-A	060762-A	1 m~4 m	NCR	Mar. 24, 2018	NCR	Radiation (03CH03-KS)

NCR: No Calibration Required



## 6 Uncertainty of Evaluation

### Uncertainty of Radiated Emission Measurement (30 MHz ~ 1000 MHz)

Measuring Uncertainty for a Level of Confidence of 95% ( $U = 2Uc(y)$ )	2.8dB
---	-------

### Uncertainty of Radiated Emission Measurement (1 GHz ~ 40 GHz)

Measuring Uncertainty for a Level of Confidence of 95% ( $U = 2Uc(y)$ )	3.3dB
---	-------



## Appendix A. Test Results of Conducted Test

### Conducted Output Power(Average power)

LTE Band 30 Maximum Average Power [dBm]						
BW [MHz]	RB Size	RB Offset	Mod	Lowest	Middle	Highest
5	1	0	QPSK	22.73	22.70	22.70
5	1	12		22.63	22.64	22.60
5	1	24		22.59	22.59	22.57
5	12	0		21.73	21.70	21.66
5	12	7		21.68	21.70	21.64
5	12	13		21.65	21.67	21.64
5	25	0		21.68	21.65	21.63
5	1	0	16-QAM	22.13	22.09	22.07
5	1	12		22.02	21.97	21.97
5	1	24		21.92	21.96	21.94
5	12	0		20.81	20.82	20.78
5	12	7		20.79	20.80	20.77
5	12	13		20.77	20.74	20.73
5	25	0		20.77	20.75	20.73
5	1	0	64QAM	21.05	20.99	20.95
5	1	12		20.93	20.91	20.88
5	1	24		20.90	20.88	20.81
5	12	0		19.88	19.85	19.79
5	12	7		19.84	19.82	19.81
5	12	13		19.80	19.76	19.77
5	25	0		19.80	19.78	19.73



10	1	0	QPSK		22.80	
10	1	25			22.62	
10	1	49			22.55	
10	25	0			21.76	
10	25	12			21.71	
10	25	25			21.65	
10	50	0			21.71	
10	1	0	16-QAM	-	22.15	-
10	1	25			21.99	
10	1	49			21.91	
10	25	0			20.86	
10	25	12			20.77	
10	25	25			20.70	
10	50	0			20.77	
10	1	0	64QAM		21.06	
10	1	25			20.88	
10	1	49			20.81	
10	25	0			19.86	
10	25	12			19.82	
10	25	25			19.73	
10	50	0			19.79	





**Peak-to-Average Ratio**

Mode	LTE Band 30 / 10MHz				
Mod.	QPSK		16QAM		Limit: 13dB
RB Size	1RB	Full RB	1RB	Full RB	Result
Lowest CH	-	-	-	-	<b>PASS</b>
Middle CH	3.57	4.70	5.19	5.94	
Highest CH	-	-	-	-	
Mod.	64QAM		Limit: 13dB		
RB Size	1RB	Full RB	Result		
Lowest CH	-	-	<b>PASS</b>		
Middle CH	5.39	5.94			
Highest CH	-	-			



LTE Band 30 / 10MHz / QPSK

Middle Channel / 1RB

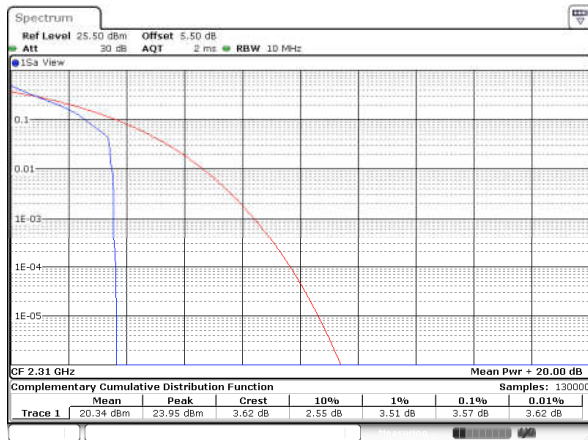

Date: 15 MAR 2018 09:59:46

Middle Channel / Full RB

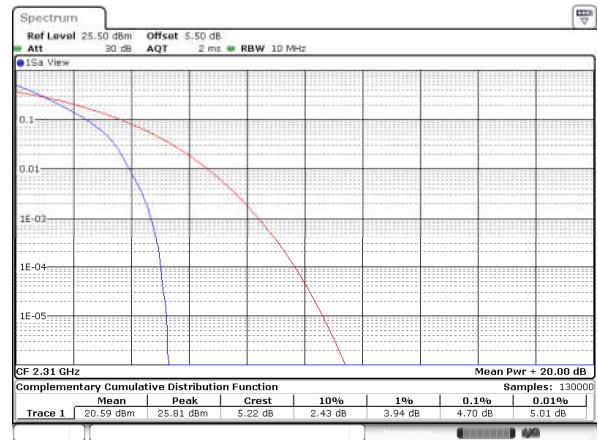

Date: 15 MAR 2018 10:01:16

LTE Band 30 / 10MHz / 16QAM

Middle Channel / 1RB

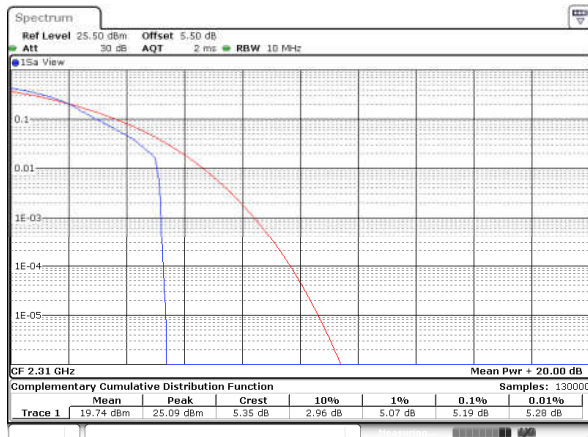

Date: 15 MAR 2018 10:00:12

Middle Channel / Full RB

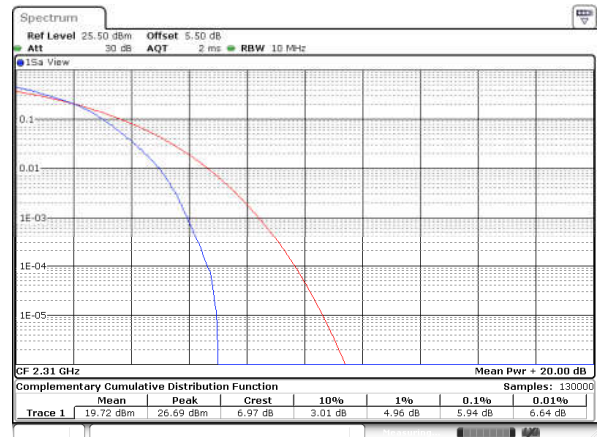

Date: 15 MAR 2018 10:00:58

LTE Band 30 / 10MHz / 64QAM

Middle Channel / 1RB

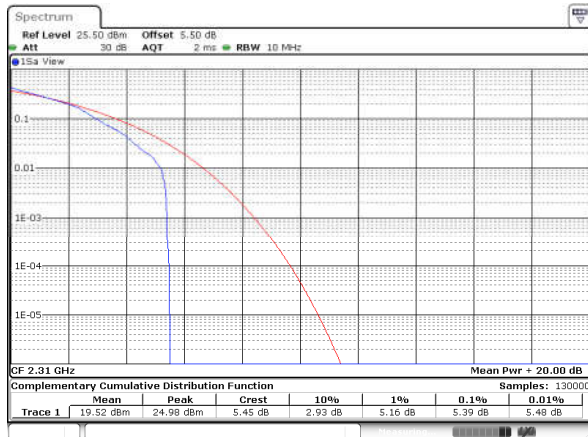

Date: 15 MAR 2018 10:00:26

Middle Channel / Full RB

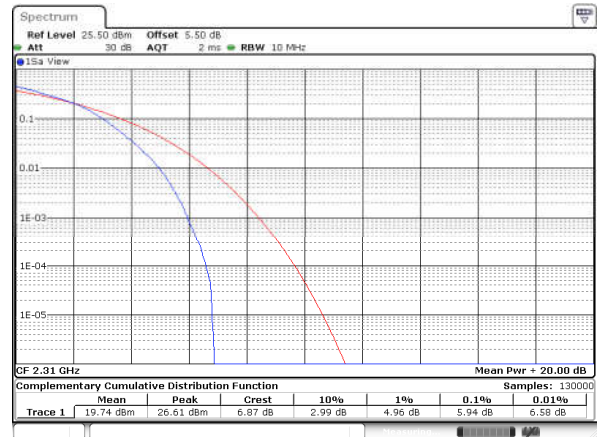

Date: 15 MAR 2018 10:00:45



**EIRP Power Density**

Mode	LTE Band 30 : Conducted Power Density (dBm/5MHz)									
BW	5MHz			10MHz						
Mod.	QPSK	16QAM	64QAM	QPSK	16QAM	64QAM				
Lowest CH	23.07	22.54	22.37	-	-	-				
Middle CH	23.21	22.70	22.60	23.42	23.15	22.74				
Highest CH	23.13	22.42	22.62	-	-	-				

Mode	LTE Band 30 : EIRP Power Density (dBm/5MHz)									
BW	5MHz			10MHz						
Mod.	QPSK	16QAM	64QAM	QPSK	16QAM	64QAM				
Lowest CH	20.89	20.36	20.19	-	-	-				
Middle CH	21.03	20.52	20.42	21.24	20.97	20.56				
Highest CH	20.95	20.24	20.44	-	-	-				
Antenna Gain	-2.18 dBi									
Limit	250mW / 5MHz = 24dBm / 5MHz									
Result	Pass									



LTE Band 30 / 5MHz

Lowest Channel / 5MHz / 1RB0 / QPSK

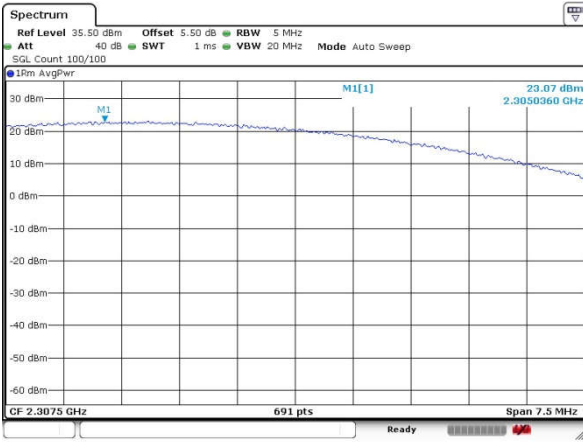

Date: 15 MAR 2018 10:09:46

Lowest Channel / 5MHz / 1RB0 / 16QAM

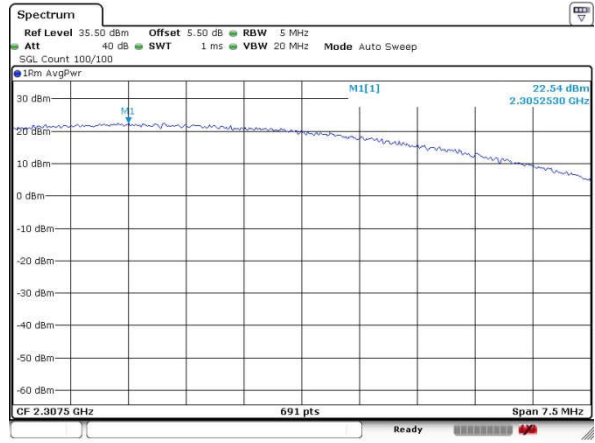

Date: 15 MAR 2018 10:10:47

Middle Channel / 5MHz / 1RB0 / QPSK

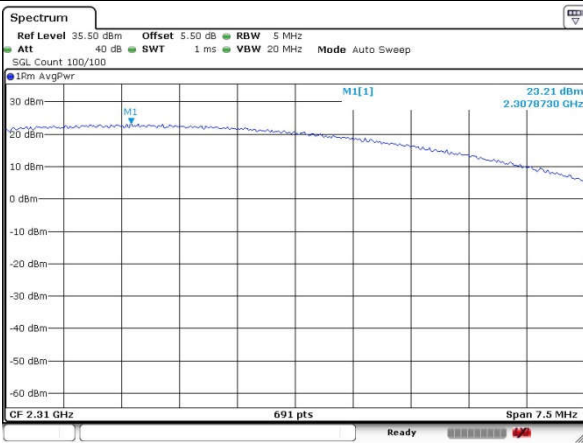

Date: 15 MAR 2018 10:13:07

Middle Channel / 5MHz / 1RB0 / 16QAM

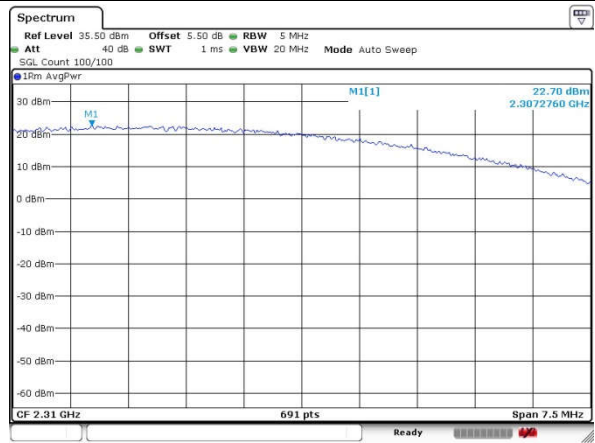

Date: 15 MAR 2018 10:12:48

Highest Channel / 5MHz / 1RB0 / QPSK

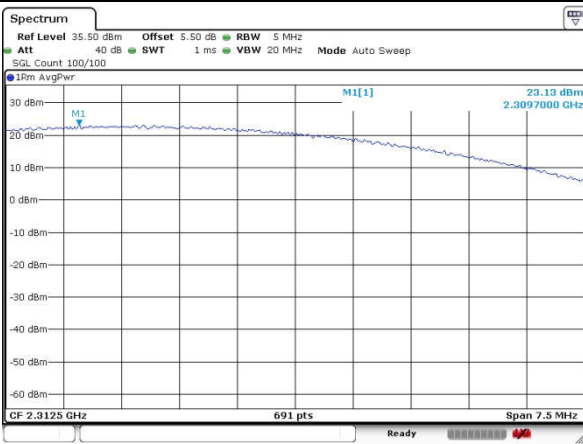

Date: 15 MAR 2018 10:13:52

Highest Channel / 5MHz / 1RB0 / 16QAM

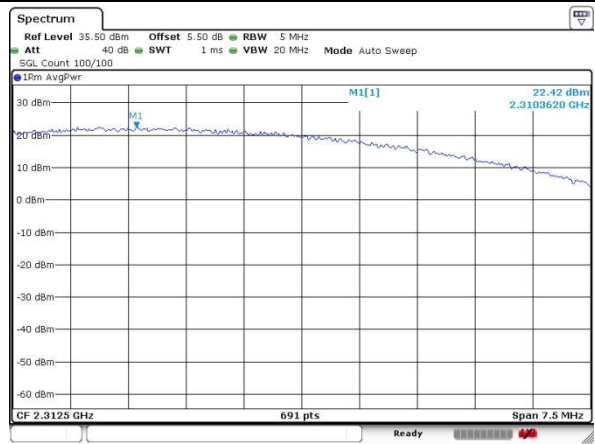

Date: 15 MAR 2018 10:14:09



LTE Band 30 / 10MHz

Lowest Channel / 10MHz / 1RB0 / QPSK

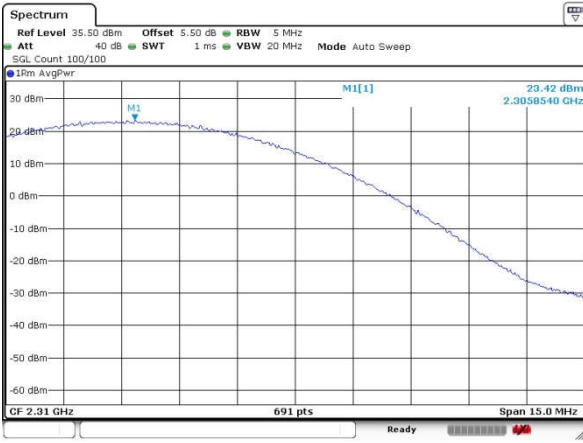

Date: 15 MAR 2018 10:16:54

Lowest Channel / 10MHz / 1RB0 / 16QAM

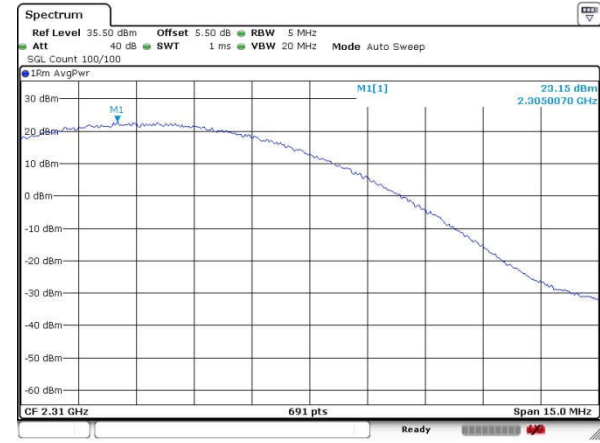

Date: 15 MAR 2018 10:17:32

LTE Band 30 / 5MHz

Lowest Channel / 5MHz / 1RB0 / 64QAM

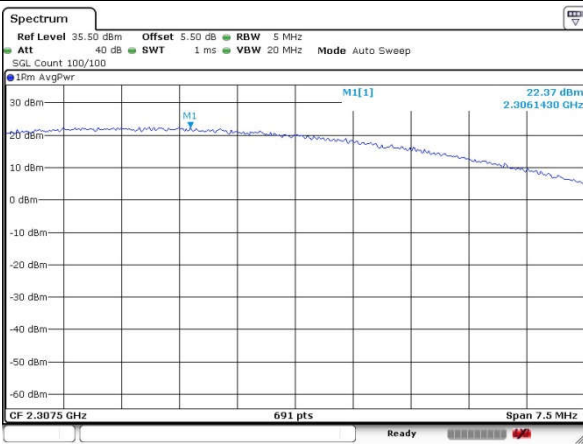

Date: 15 MAR 2018 10:11:06

Middle Channel / 5MHz / 1RB0 / 64QAM

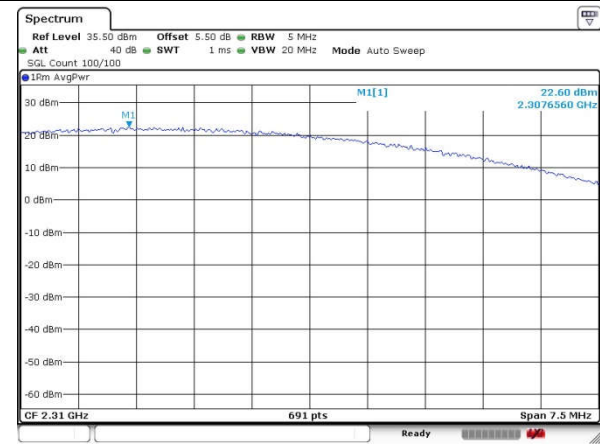

Date: 15 MAR 2018 10:12:28

Highest Channel / 5MHz / 1RB0 / 64QAM

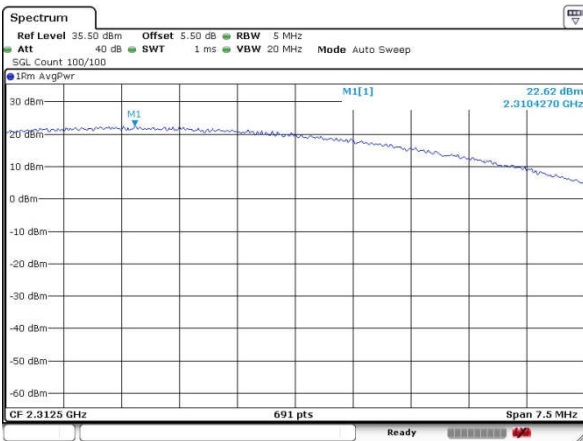

Date: 15 MAR 2018 10:14:24

Middle Channel / 10MHz / 1RB0 / 64QAM

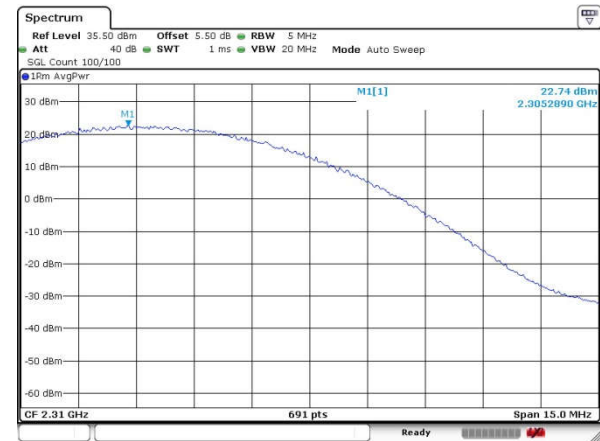

Date: 15 MAR 2018 10:17:49



**26dB Bandwidth**

Mode	LTE Band 30 : 26dB BW(MHz)										
	5MHz		10MHz		5MHz	10MHz					
BW	QPSK	16QAM	QPSK	16QAM	64QAM	64QAM					
Mod.	QPSK	16QAM	QPSK	16QAM	64QAM	64QAM					
Lowest CH	4.895	4.855	-	-	4.875	-					
Middle CH	4.845	4.955	9.81	9.69	4.905	9.69					
Highest CH	4.905	4.975	-	-	4.795	-					



LTE Band 30

Lowest Channel / 5MHz / QPSK

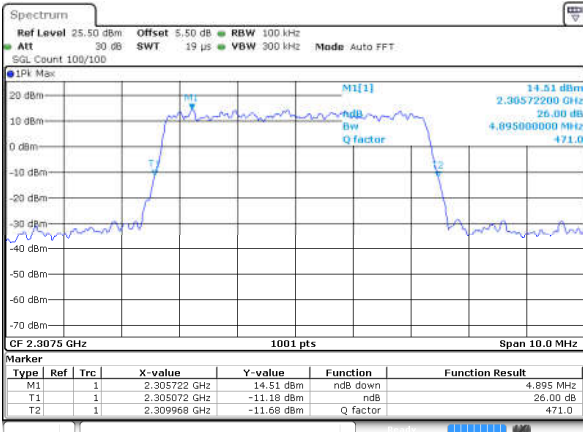

Date: 15 MAR 2018 09:08:00

Lowest Channel / 5MHz / 16QAM

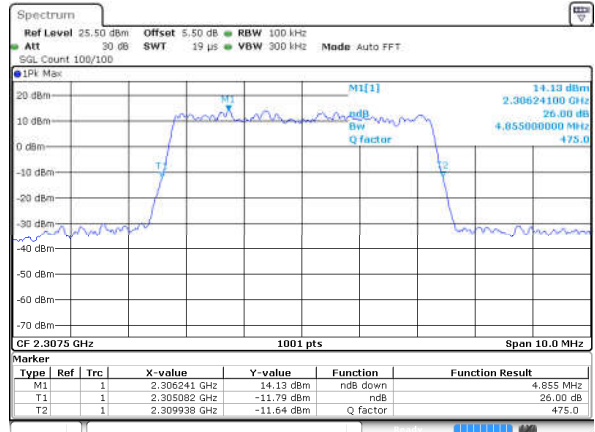

Date: 15 MAR 2018 09:28:26

Middle Channel / 5MHz / QPSK

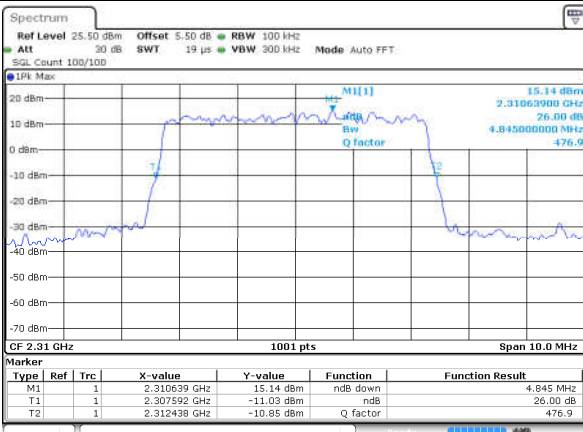

Date: 15 MAR 2018 09:10:11

Middle Channel / 5MHz / 16QAM

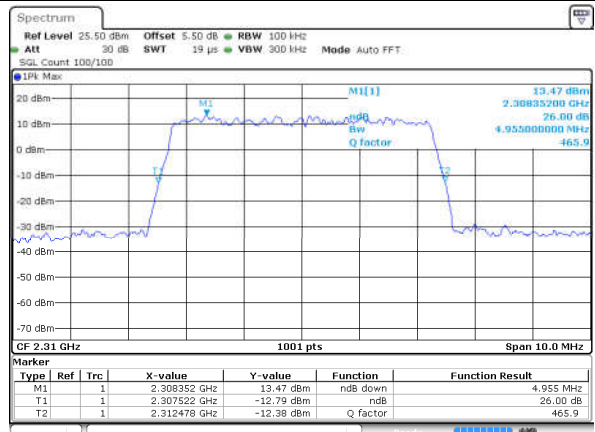

Date: 15 MAR 2018 09:10:23

Highest Channel / 5MHz / QPSK

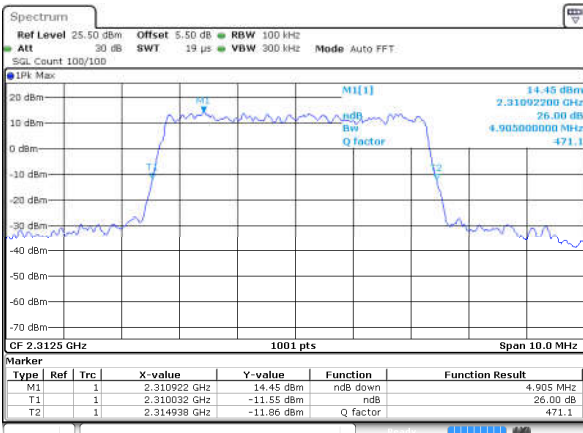

Date: 15 MAR 2018 09:11:57

Highest Channel / 5MHz / 16QAM

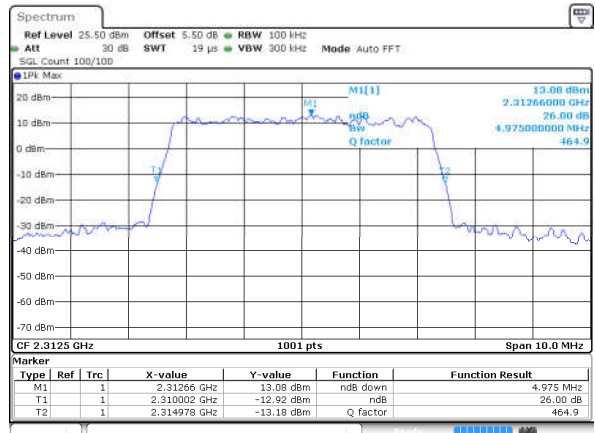

Date: 15 MAR 2018 09:11:26



LTE Band 30

Middle Channel / 10MHz / QPSK

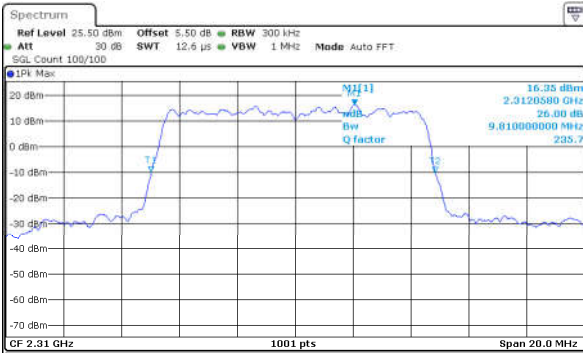

Marker	Type	Ref	Trc	X-value	Y-value	Function	Function Result
M1	1			2.312058 GHz	16.35 dBm	ndB down	9.81 MHz
T1	1			2.305025 GHz	-9.68 dBm	ndB	26.00 dB
T2	1			2.314635 GHz	-10.00 dBm	Q factor	235.7

Date: 15 MAR 2018 09:44:44

Middle Channel / 10MHz / 16QAM

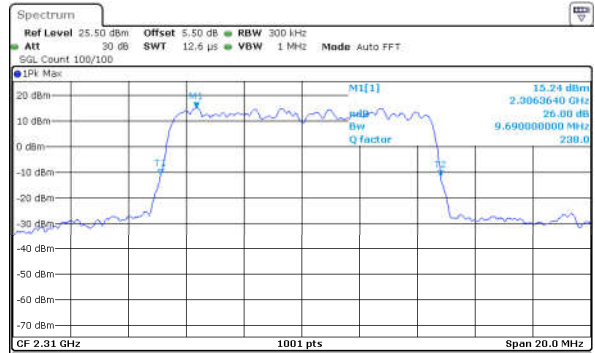

Marker	Type	Ref	Trc	X-value	Y-value	Function	Function Result
M1	1			2.306364 GHz	15.24 dBm	ndB down	9.69 MHz
T1	1			2.305125 GHz	-10.81 dBm	ndB	26.00 dB
T2	1			2.314915 GHz	-11.22 dBm	Q factor	236.0

Date: 15 MAR 2018 09:44:19

LTE Band 30

Lowest Channel / 5MHz / 64QAM

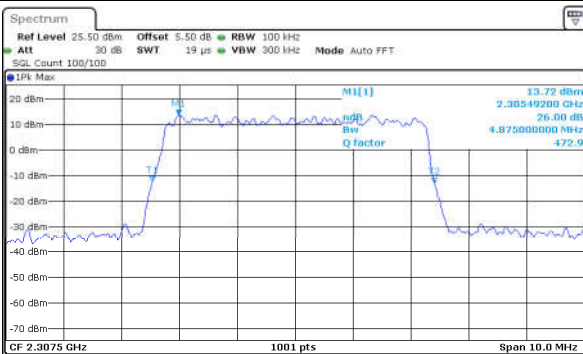

Marker	Type	Ref	Trc	X-value	Y-value	Function	Function Result
M1	1			2.305492 GHz	13.72 dBm	ndB down	4.875 MHz
T1	1			2.305032 GHz	-12.09 dBm	ndB	26.00 dB
T2	1			2.309908 GHz	-12.69 dBm	Q factor	472.9

Date: 15 MAR 2018 09:08:49

Middle Channel / 5MHz / 64QAM

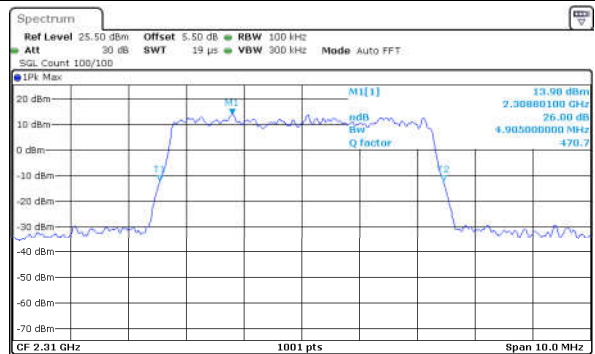

Marker	Type	Ref	Trc	X-value	Y-value	Function	Function Result
M1	1			2.308801 GHz	13.98 dBm	ndB down	4.905 MHz
T1	1			2.307542 GHz	-11.99 dBm	ndB	26.00 dB
T2	1			2.312448 GHz	-11.92 dBm	Q factor	470.7

Date: 15 MAR 2018 09:10:37

Highest Channel / 5MHz / 64QAM

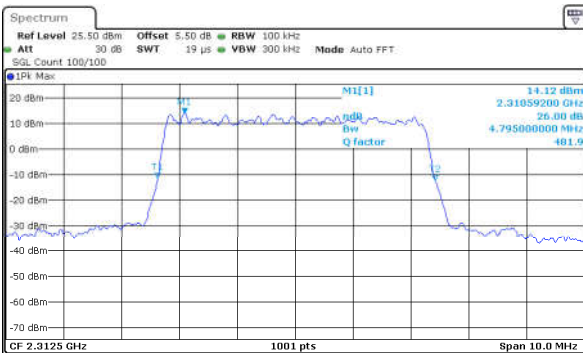

Marker	Type	Ref	Trc	X-value	Y-value	Function	Function Result
M1	1			2.310592 GHz	14.12 dBm	ndB down	4.795 MHz
T1	1			2.310122 GHz	-11.25 dBm	ndB	26.00 dB
T2	1			2.314918 GHz	-12.18 dBm	Q factor	461.9

Date: 15 MAR 2018 09:11:02

Middle Channel / 10MHz / 64QAM

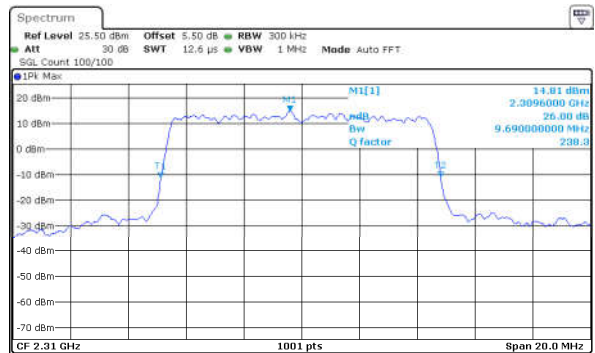

Marker	Type	Ref	Trc	X-value	Y-value	Function	Function Result
M1	1			2.3096 GHz	14.81 dBm	ndB down	9.69 MHz
T1	1			2.305125 GHz	-11.04 dBm	ndB	26.00 dB
T2	1			2.314915 GHz	-10.79 dBm	Q factor	236.3

Date: 15 MAR 2018 09:45:31





### Occupied Bandwidth

Mode	LTE Band 30 : 99%OBW(MHz)											
	5MHz		10MHz		5MHz	10MHz						
BW	QPSK	16QAM	QPSK	16QAM	64QAM	64QAM						
Lowest CH	4.50	4.46	-	-	4.49	-				-	-	-
Middle CH	4.50	4.50	9.03	8.99	4.51	9.09			-	-	-	-
Highest CH	4.49	4.50	-	-	4.49	-			-	-	-	-



LTE Band 30

Lowest Channel / 5MHz / QPSK

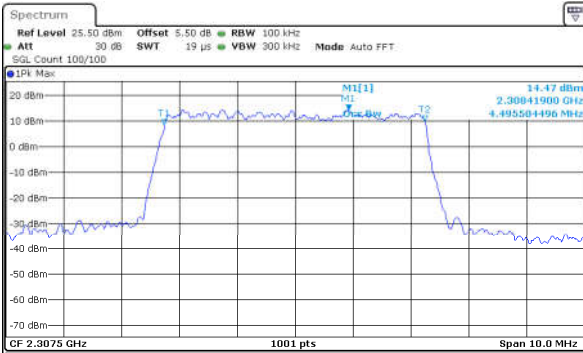

Date: 15 MAR 2018 09:07:44

Lowest Channel / 5MHz / 16QAM

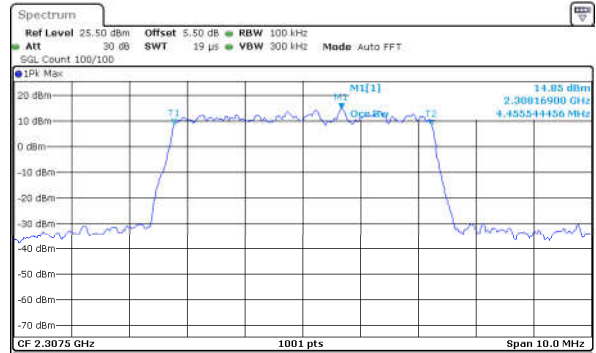

Date: 15 MAR 2018 09:08:14

Middle Channel / 5MHz / QPSK

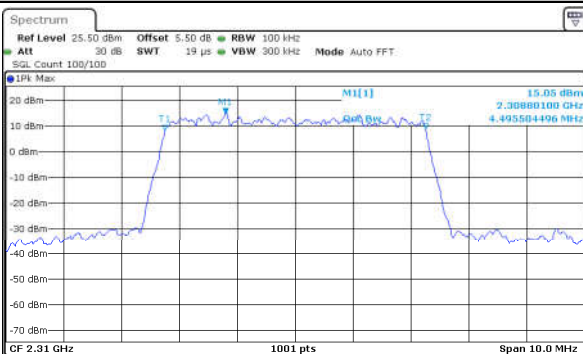

Date: 15 MAR 2018 09:09:56

Middle Channel / 5MHz / 16QAM

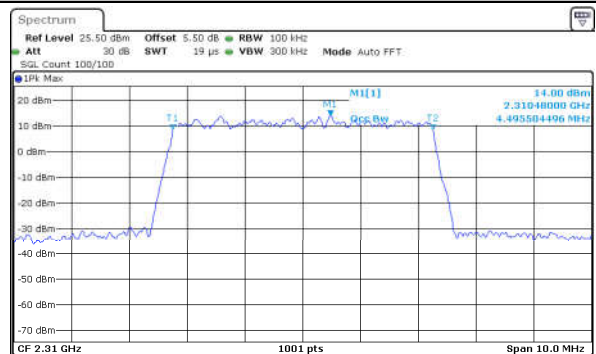

Date: 15 MAR 2018 09:09:43

Highest Channel / 5MHz / QPSK

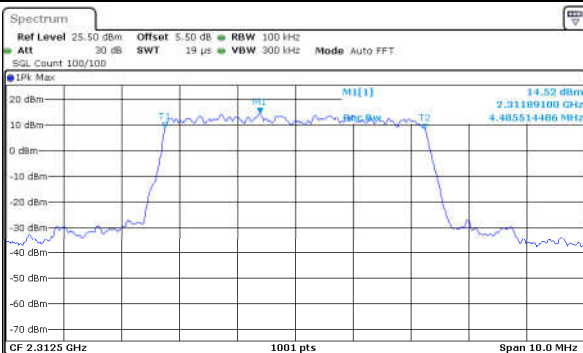

Date: 15 MAR 2018 09:11:44

Highest Channel / 5MHz / 16QAM

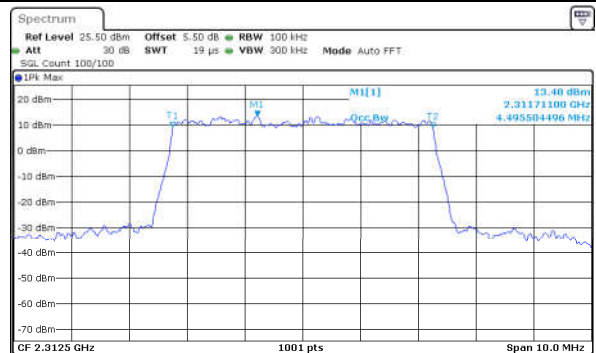

Date: 15 MAR 2018 09:11:14



LTE Band 30

Middle Channel / 10MHz / QPSK

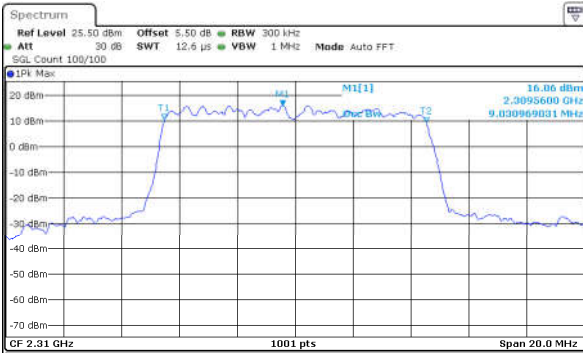

Date: 15 MAR 2018 09:45:02

Middle Channel / 10MHz / 16QAM

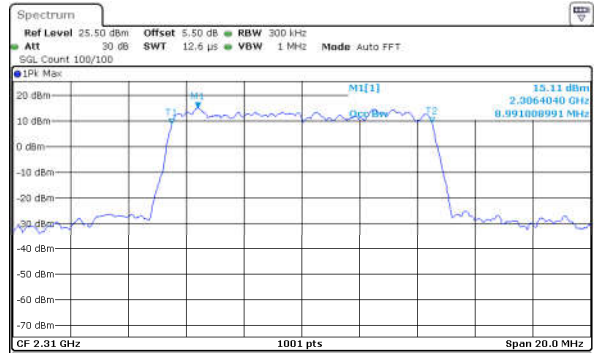

Date: 15 MAR 2018 09:44:31

LTE Band 30

Lowest Channel / 5MHz / 64QAM

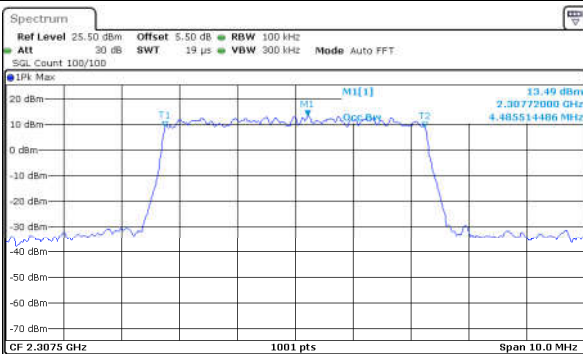

Date: 15 MAR 2018 09:08:38

Middle Channel / 5MHz / 64QAM

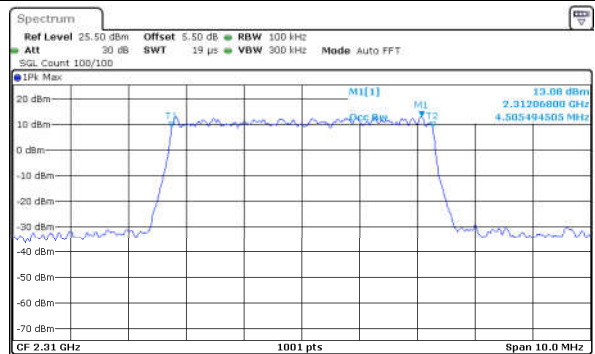

Date: 15 MAR 2018 09:09:31

Highest Channel / 5MHz / 64QAM

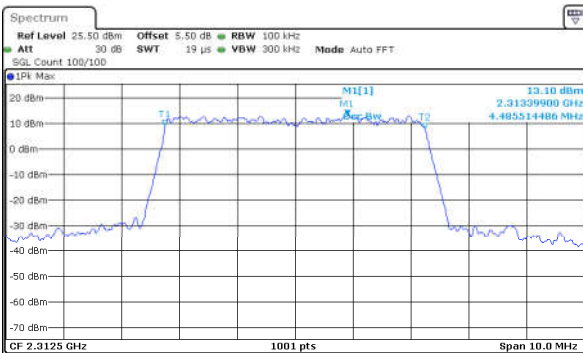

Date: 15 MAR 2018 09:10:51

Middle Channel / 10MHz / 64QAM

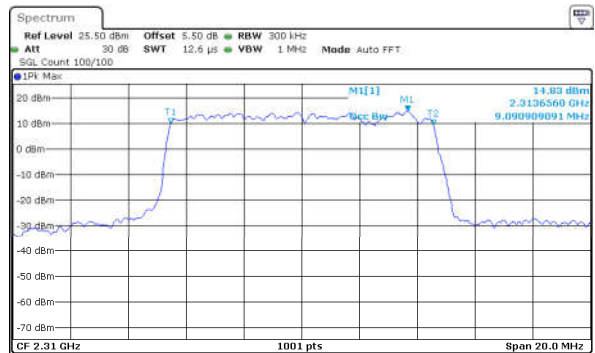

Date: 15 MAR 2018 09:45:20



# Conducted Band Edge

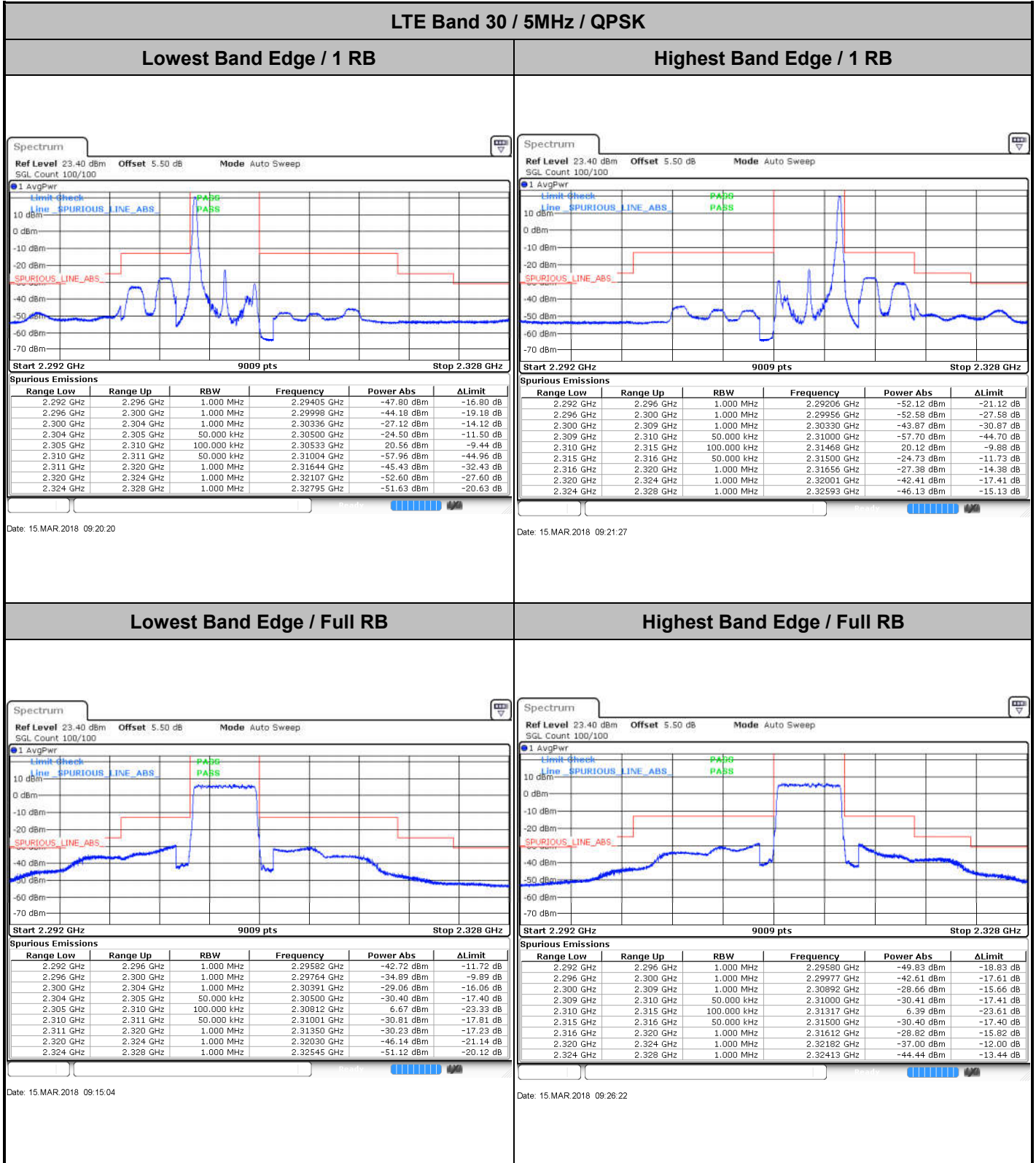



LTE Band 30 / 5MHz / 16QAM

Lowest Band Edge / 1RB

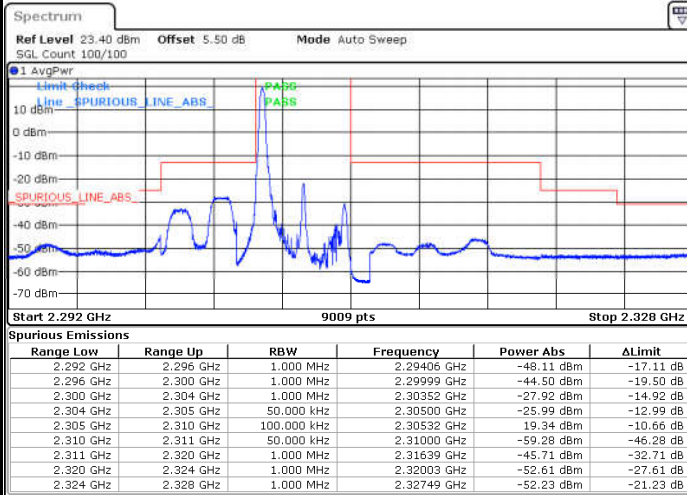

Date: 15.MAR.2018 09:19:25

Highest Band Edge / 1 RB

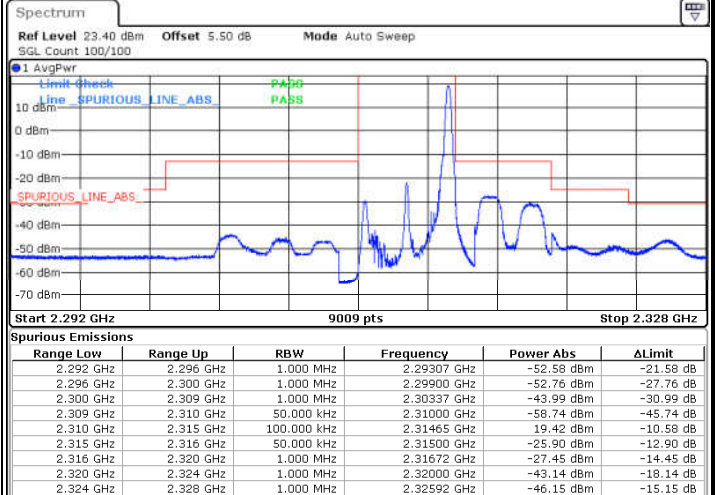

Date: 15.MAR.2018 09:22:12

Lowest Band Edge / Full RB

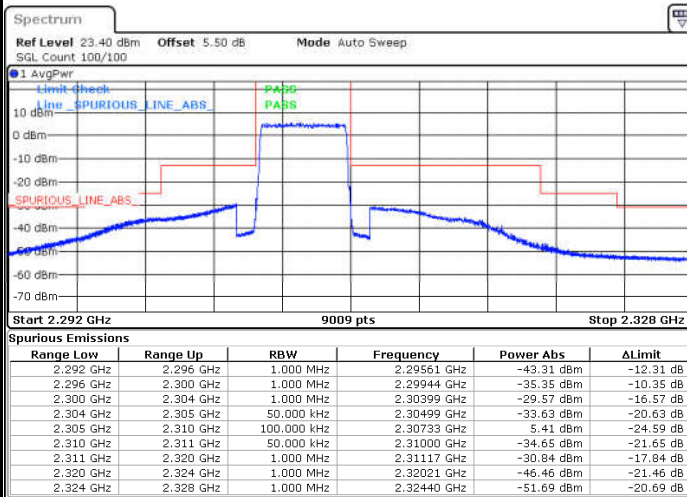

Date: 15.MAR.2018 09:17:25

Highest Band Edge / Full RB

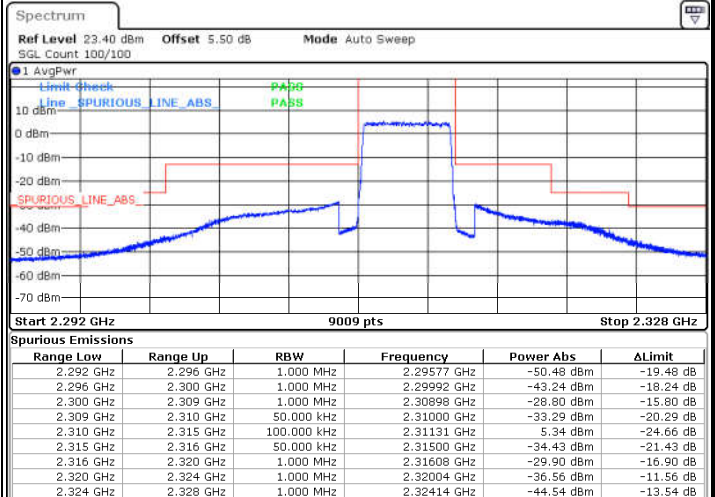

Date: 15.MAR.2018 09:25:40



**LTE Band 30 / 10MHz / QPSK**

**Lowest Band Edge / 1 RB**

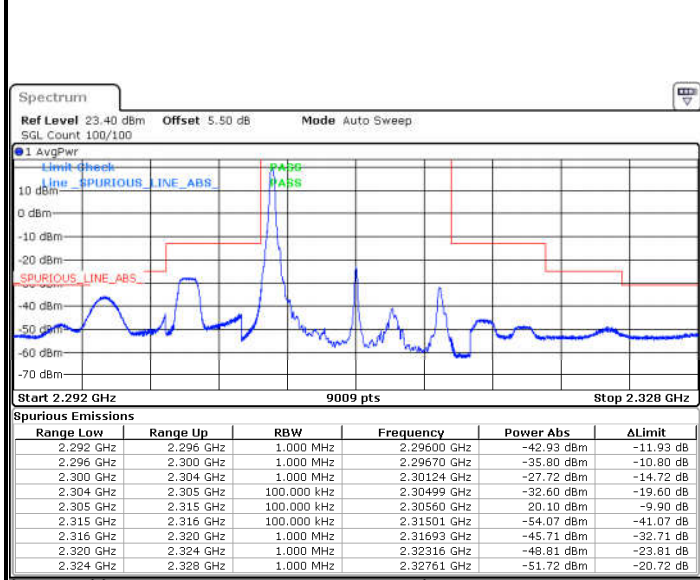

Date: 15.MAR.2018 09:49:03

**Highest Band Edge / 1 RB**

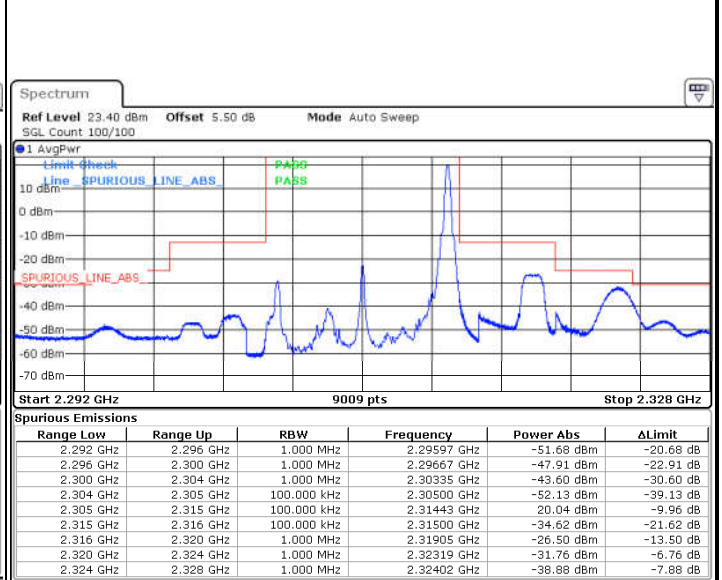

Date: 15.MAR.2018 09:55:33

**Band Edge / Full RB**

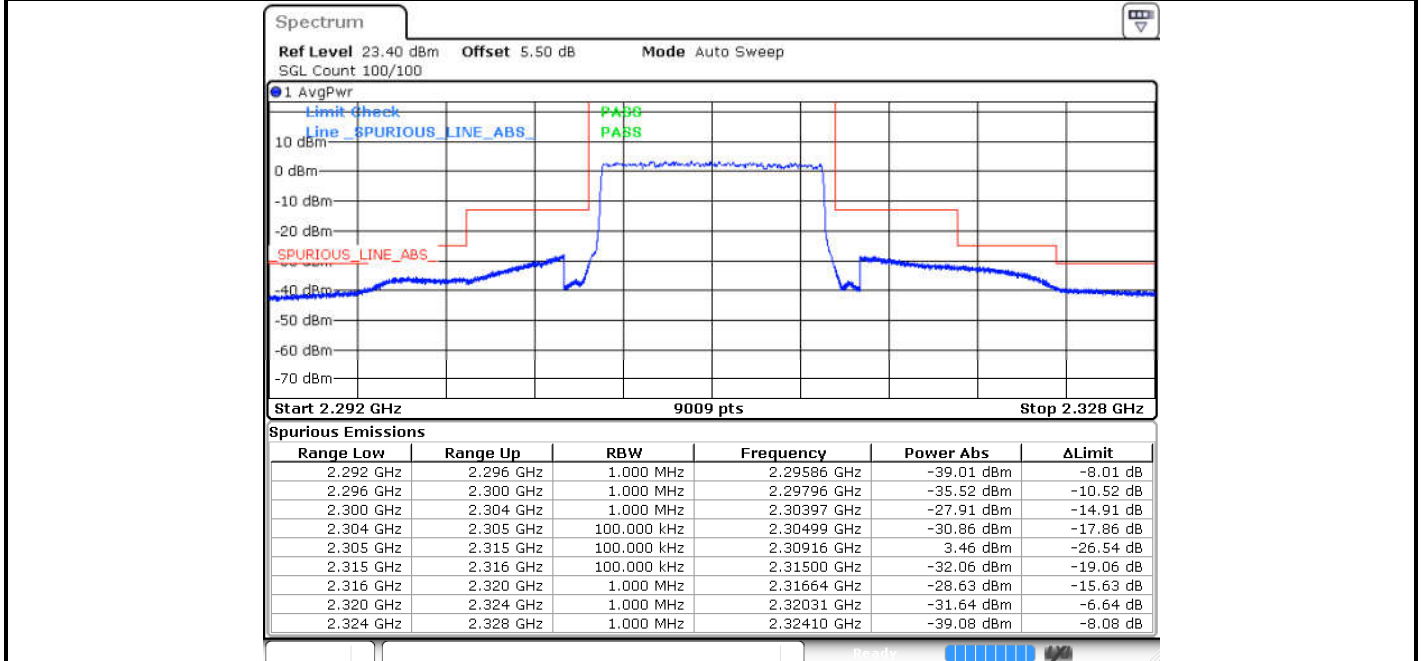

Date: 15.MAR.2018 09:48:24



LTE Band 30 / 10MHz / 16QAM

Lowest Band Edge / 1 RB

Highest Band Edge / 1 RB

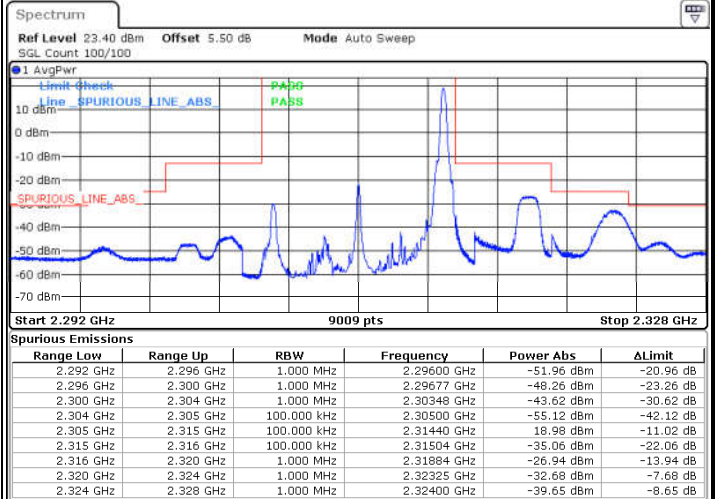
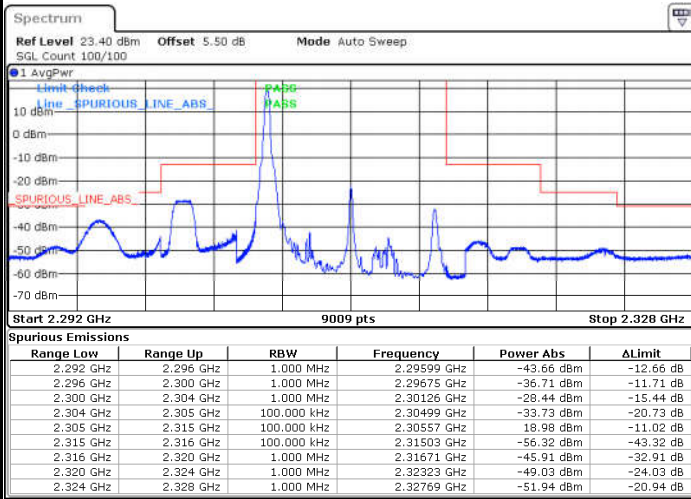

Date: 15.MAR.2018 09:49:33

Date: 15.MAR.2018 09:51:09

Band Edge / Full RB

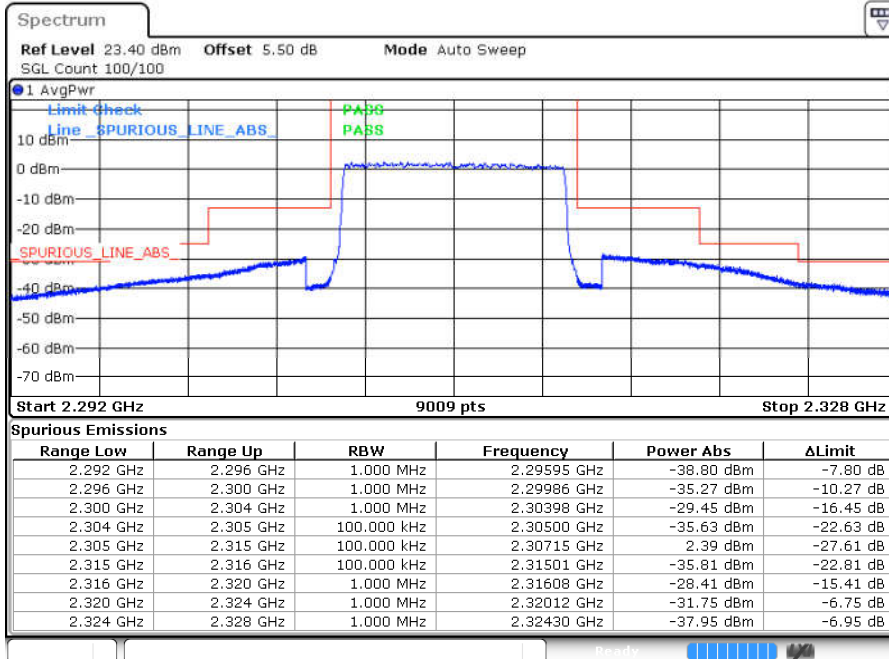

Date: 15.MAR.2018 09:47:45



LTE Band 30 / 5MHz / 64QAM

Lowest Band Edge / 1 RB

Highest Band Edge / 1 RB

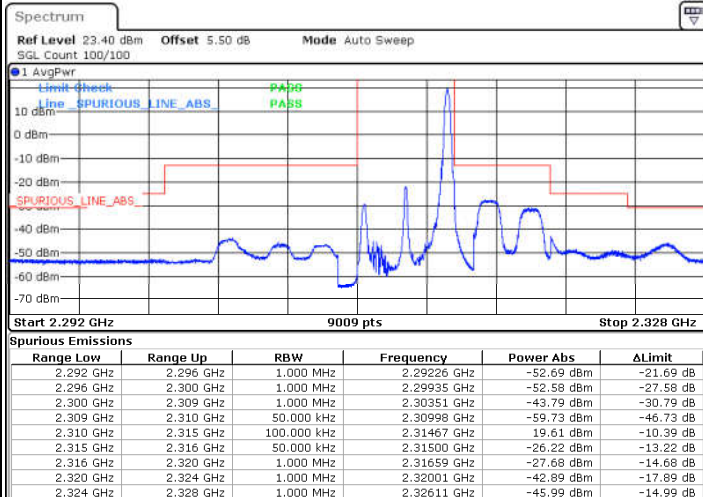
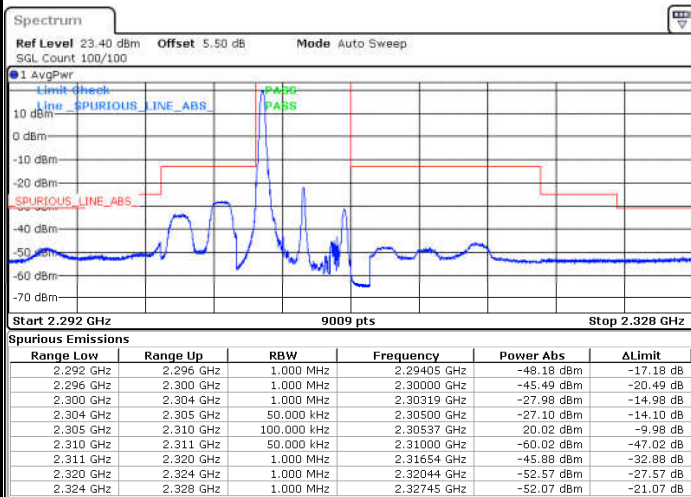

Date: 15.MAR.2018 09:18:49

Date: 15.MAR.2018 09:22:53

Lowest Band Edge / Full RB

Highest Band Edge / Full RB

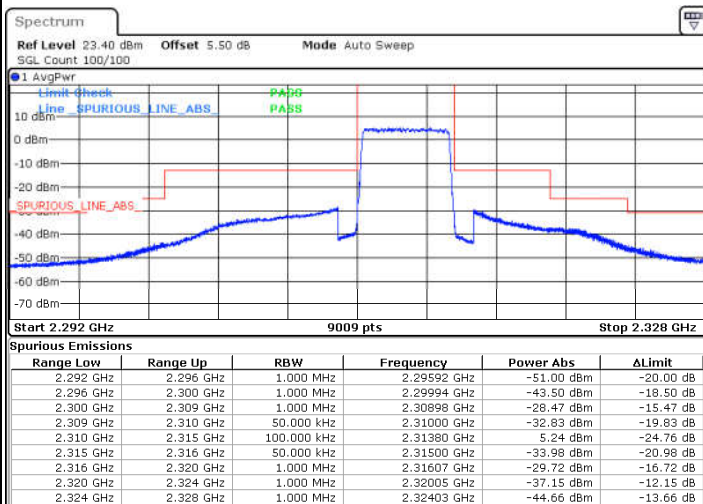
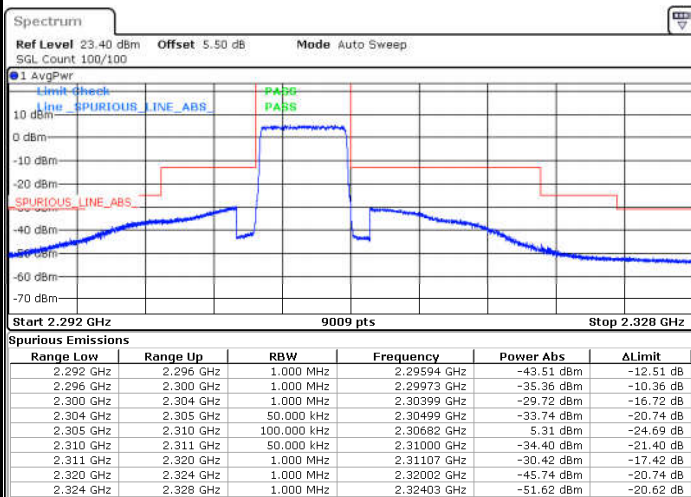

Date: 15.MAR.2018 09:18:08

Date: 15.MAR.2018 09:25:00





LTE Band 30 / 10MHz / 64QAM

Band Edge / 1 RB0

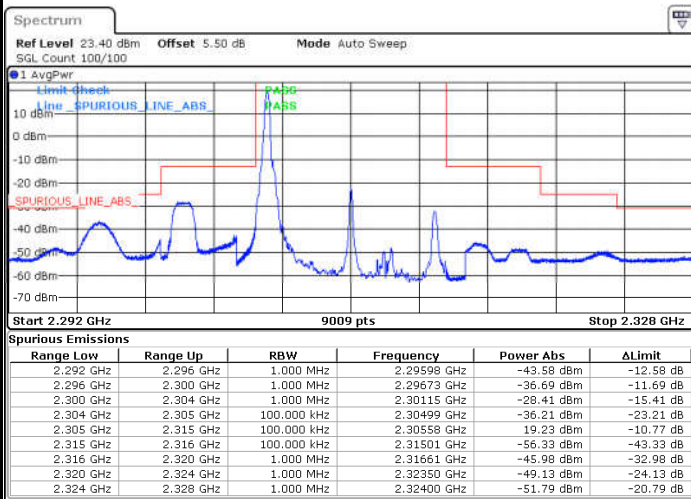

Date: 15.MAR.2018 09:49:56

Band Edge / 1 RB MAX

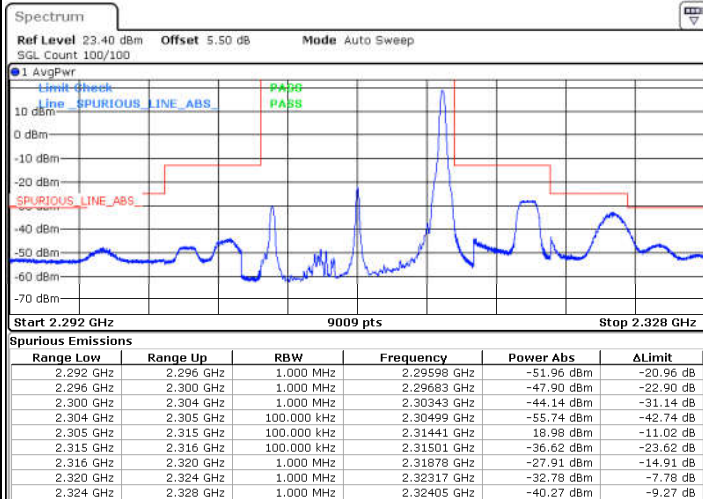

Date: 15.MAR.2018 09:50:33

Band Edge / Full RB

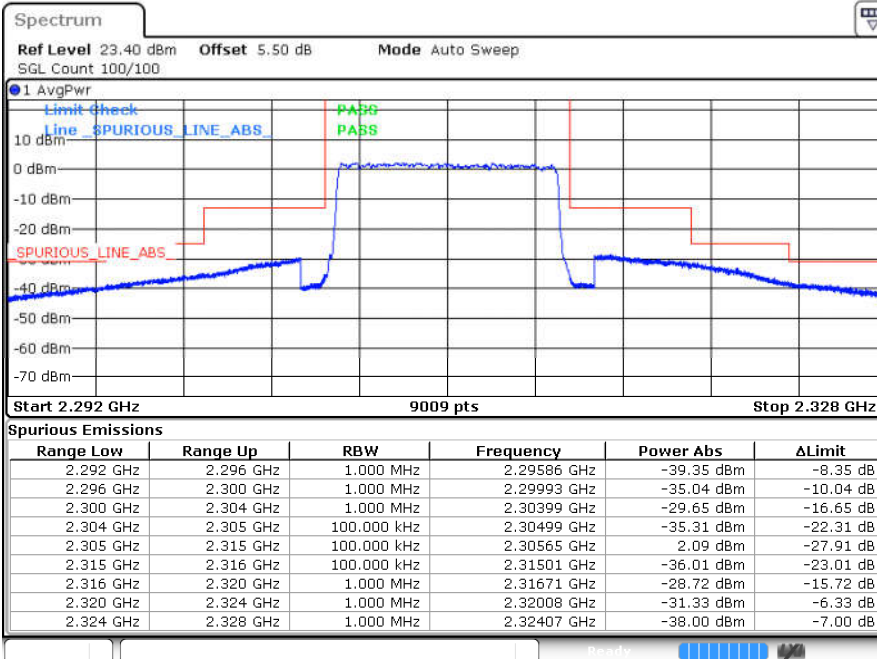

Date: 15.MAR.2018 09:47:23



# Conducted Spurious Emission

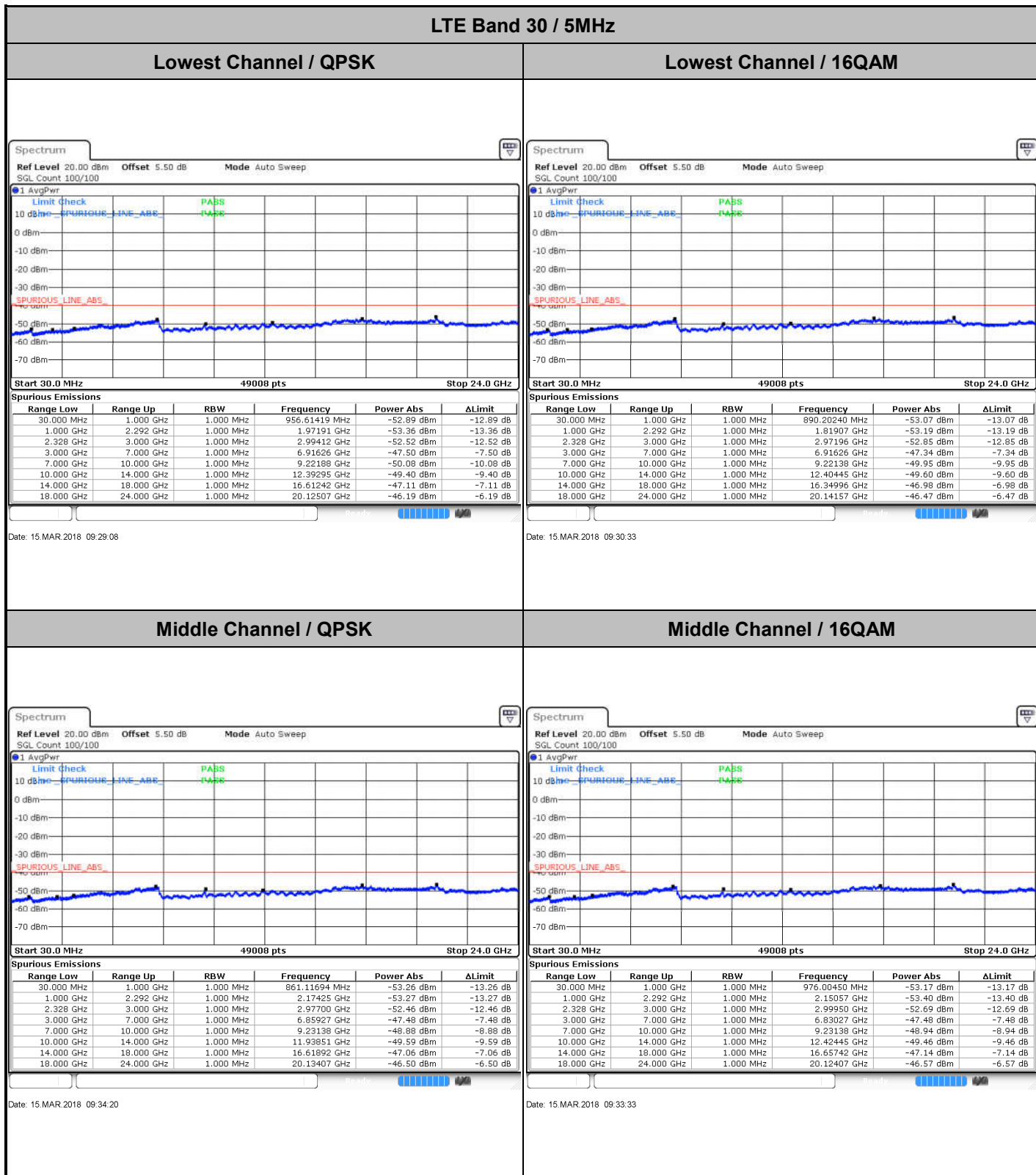

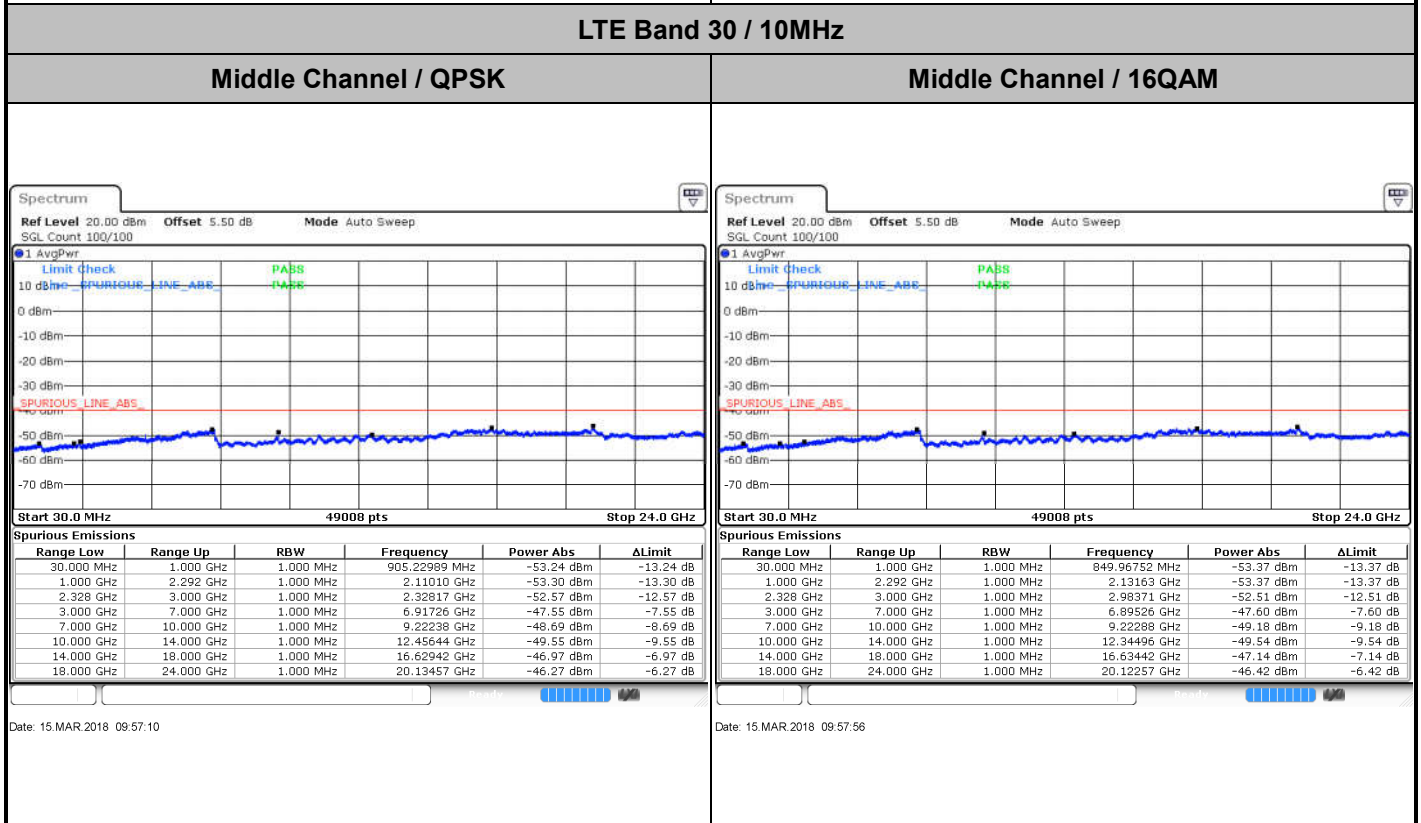
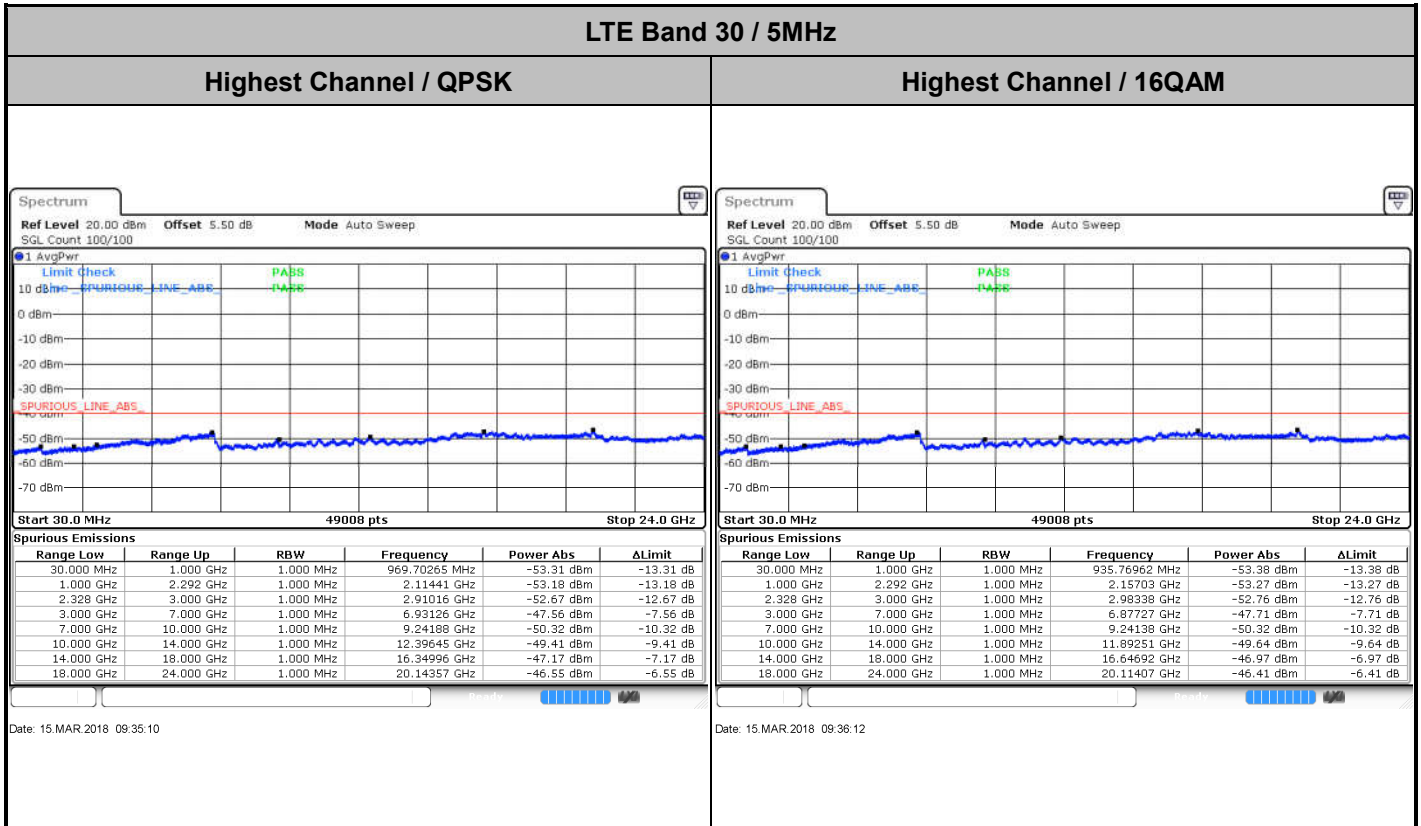



**LTE Band 30 / 5MHz**

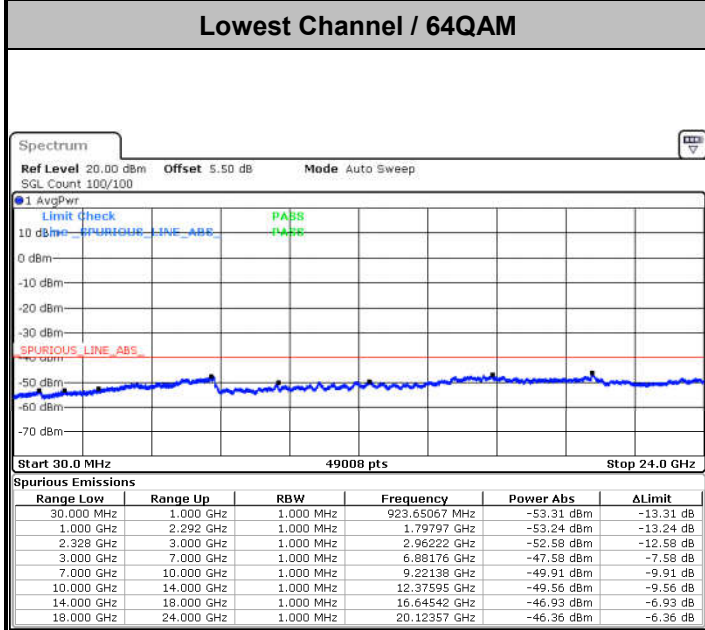

Date: 15.MAR.2018 09:31:24

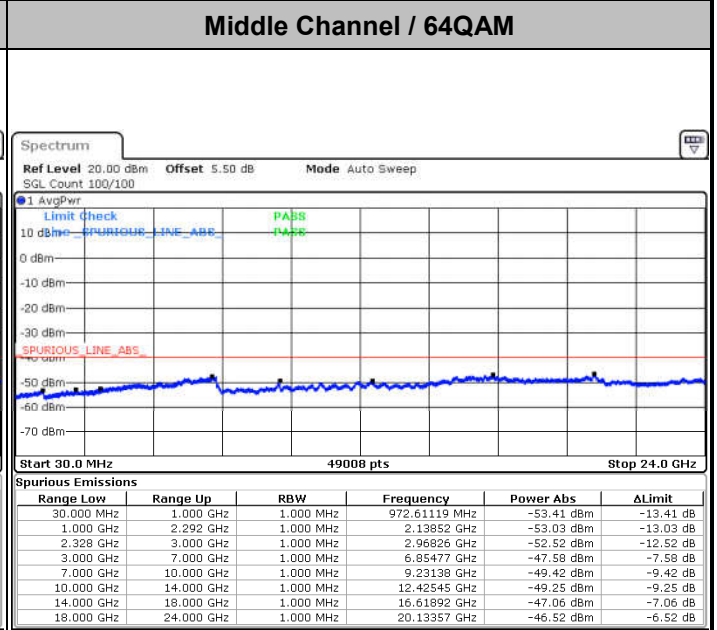

Date: 15.MAR.2018 09:32:42

**LTE Band 30 / 5MHz**

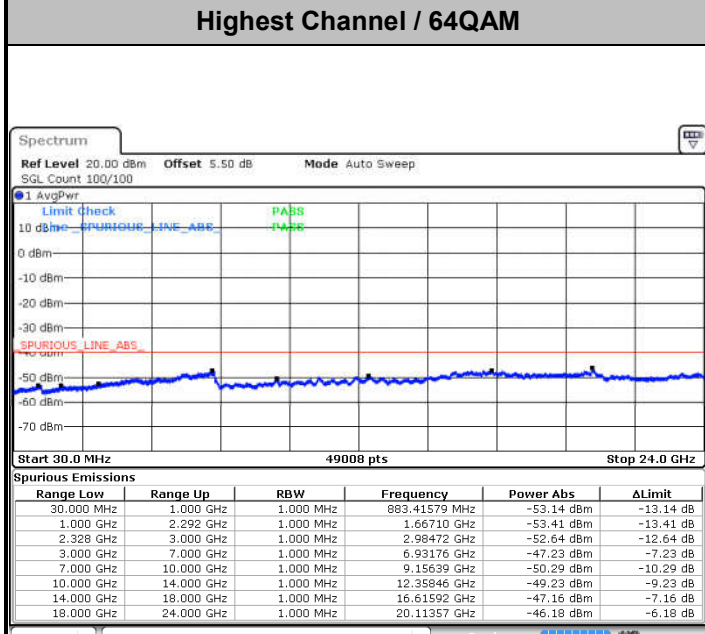

Date: 15.MAR.2018 09:36:59

**LTE Band 30 / 10MHz**

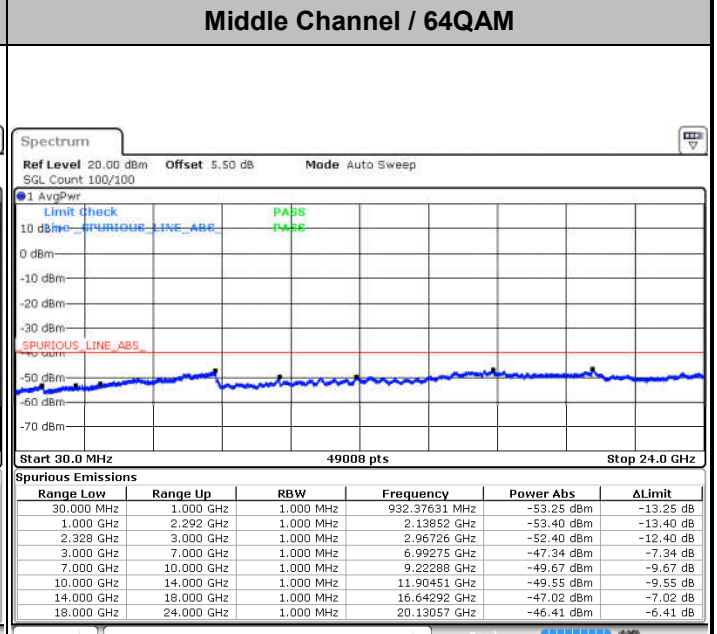

Date: 15.MAR.2018 09:59:01



Frequency Stability

Test Conditions		LTE Band 30 (QPSK) / Middle Channel	Limit
Temperature (°C)	Voltage (Volt)	BW 10MHz	Note 2.
		Deviation (ppm)	Result
50	Normal Voltage	0.0014	PASS
40	Normal Voltage	0.0007	
30	Normal Voltage	0.0005	
20(Ref.)	Normal Voltage	0.0000	
10	Normal Voltage	0.0010	
0	Normal Voltage	0.0012	
-10	Normal Voltage	0.0002	
-20	Normal Voltage	0.0006	
-30	Normal Voltage	0.0007	
20	Maximum Voltage	0.0009	
20	Normal Voltage	0.0004	
20	Battery End Point	0.0006	

Note:

1. Normal Voltage =3.85 V. ; Battery End Point (BEP) =3.7 V. ; Maximum Voltage =4.4 V.
2. Note: The frequency fundamental emissions stay within the authorized frequency block.



## Appendix B. Test Results of Radiated Test

### Radiated Spurious Emission

LTE Band 30 / 10MHz / QPSK / RB Size 1 Offset 0								
Channel	Frequency ( MHz )	EIRP ( dBm )	Limit ( dBm )	Over Limit ( dB )	SPA Reading (dBm)	TX Cable loss ( dB )	TX Antenna Gain (dBi)	Polarization (H/V)
Middle	4612	-55.33	-40	-15.33	-61.20	2.12	7.99	H
	6916	-54.00	-40	-14.00	-63.16	2.51	11.67	H
	9220	-50.16	-40	-10.16	-60.73	3.02	13.59	H
	11528	-49.06	-40	-9.06	-57.55	3.62	12.11	H
	13836	-57.25	-40	-17.25	-66.36	3.93	13.04	H
	16140	-49.27	-40	-9.27	-58.55	4.54	13.82	H
	4612	-57.19	-40	-17.19	-63.06	2.12	7.99	V
	6916	-55.94	-40	-15.94	-65.10	2.51	11.67	V
	9224	-49.76	-40	-9.76	-60.33	3.02	13.59	V
	11528	-46.82	-40	-6.82	-55.31	3.62	12.11	V
	13836	-57.74	-40	-17.74	-66.85	3.93	13.04	V
	16140	-44.30	-40	-4.30	-53.58	4.54	13.82	V

Remark: Spurious emissions within 30-1000MHz were found more than 20dB below limit line.