

FCC Test Report (PART 27)

Report No.: RF160601W004-6

FCC ID: 2AFZZ-RS6031

Test Model: 2016031

Received Date: Jun. 01, 2016

Test Date: Jun. 02, 2016 ~ Jun. 28, 2016

Issued Date: Jun. 29, 2016

Applicant: Xiaomi Communications Co., Ltd.

Address: The Rainbow City of China Resources, NO.68, Qinghe Middle Street, Haidian District, Beijing, China

Issued By: Bureau Veritas Consumer Products Services (H.K.) Ltd.,
Taoyuan Branch

Lab Address: No. 47-2, 14th Ling, Chia Cau Vil., Lin Kou Dist., New Taipei City, Taiwan (R.O.C.)

Test Location: No. 19, Hwa Ya 2nd Rd., Wen Hwa Tsuen, Kwei Shan Hsiang, Taoyuan Hsien 333, Taiwan, R.O.C.

This report should not be used by the client to claim product certification, approval, or endorsement by TAF or any government agencies.



This report is for your exclusive use. Any copying or replication of this report to or for any other person or entity, or use of our name or trademark, is permitted only with our prior written permission. This report sets forth our findings solely with respect to the test samples identified herein. The results set forth in this report are not indicative or representative of the quality or characteristics of the lot from which a test sample was taken or any similar or identical product specifically and expressly noted. Our report includes all of the tests requested by you and the results thereof based upon the information that you provided to us. You have 60 days from date of issuance of this report to notify us of any material error or omission caused by our negligence, provided, however, that such notice shall be in writing and shall specifically address the issue you wish to raise. A failure to raise such issue within the prescribed time shall constitute your unqualified acceptance of the completeness of this report, the tests conducted and the correctness of the report contents. Unless specific mention, the uncertainty of measurement has been explicitly taken into account to declare the compliance or non-compliance to the specification. The report must not be used by the client to claim product certification, approval, or endorsement by TAF or any government agency

TABLE OF CONTENTS

1	Certificate of Conformity	4
2	Summary of Test Results	5
2.1	Measurement Uncertainty	5
2.2	Test Site And Instruments	6
3	General Information	7
3.1	General Description of EUT	7
3.2	Configuration of System Under Test	9
3.2.1	Description Of Support Units	9
3.3	Test Mode Applicability and Tested Channel Detail	10
3.4	EUT Operating Conditions	12
3.5	General Description of Applied Standards	12
4	Test Types and Results	13
4.1	Output Power Measurement	13
4.1.1	Limits of Output Power Measurement	13
4.1.2	Test Procedures.....	13
4.1.3	Test Setup.....	14
4.1.4	Test Results	15
4.2	Frequency Stability Measurement.....	25
4.2.1	Limits of Frequency Stability Measurement.....	25
4.2.2	Test Procedure	25
4.2.3	Test Setup.....	25
4.2.4	Test Results	26
4.3	Occupied Bandwidth Measurement	28
4.3.1	Limits Of Occupied Bandwidth Measurement	28
4.3.2	Test Setup.....	28
4.3.3	Test Procedures.....	28
4.3.4	Test Result.....	29
4.4	Peak To Average Ratio	33
4.4.1	Limits of Peak To Average Ratio Measurement	33
4.4.2	Test Setup.....	33
4.4.3	Test Procedures.....	33
4.4.4	Test Results	34
4.5	Band Edge Measurement	38
4.5.1	Limits of Band Edge Measurement	38
4.5.2	Test Setup.....	38
4.5.3	Test Procedures.....	38
4.5.4	Test Results	39
4.6	Conducted Spurious Emissions	45
4.6.1	Limits of Conducted Spurious Emissions Measurement.....	45
4.6.2	Test Procedure	45
4.6.3	Test Setup.....	45
4.6.4	Test Results	46
4.7	Radiated Emission Measurement	48
4.7.1	Limits of Radiated Emission Measurement.....	48
4.7.2	Test Procedure	48
4.7.3	Deviation from Test Standard	48
4.7.4	Test Setup.....	49
4.7.5	Test Results	50
5	Pictures of Test Arrangements	68
	Appendix – Information on the Testing Laboratories	69



A D T

RELEASE CONTROL RECORD

Issue No.	Description	Date Issued
RF160601W004-6	Original release	Jun. 29, 2016



1 Certificate of Conformity

Product: Mobile Phone
Brand: MI
Test Model: 2016031
Sample Status: Identical Prototype
Applicant: Xiaomi Communications Co., Ltd.
Test Date: Jun. 02, 2016 ~ Jun. 28, 2016
Standards: **FCC Part 27, Subpart C, M**
FCC Part 2
ANSI /TIA/EIA-603-D

The above equipment has been tested by **Bureau Veritas Consumer Products Services (H.K.) Ltd., Taoyuan Branch**, and found compliance with the requirement of the above standards. The test record, data evaluation & Equipment Under Test (EUT) configurations represented herein are true and accurate accounts of the measurements of the sample's EMC characteristics under the conditions specified in this report.

Prepared by :  , **Date:** Jun. 29, 2016
Amyee Qian / Engineer

Approved by :  , **Date:** Jun. 29, 2016
William Chung / Manager

2 Summary of Test Results

Applied Standard: FCC Part 27 & Part 2			
FCC Clause	Test Item	Result	Remarks
2.1046 27.50(h)(2)	Equivalent Isotropically radiated power	PASS	Meet the requirement of limit.
2.1055 27.54	Frequency Stability Stay with the authorized bands of operation	PASS	Meet the requirement of limit.
2.1049 27.53(m)(6)	Occupied Bandwidth	PASS	Meet the requirement of limit.
27.50(d)(5)	Peak to average ratio	PASS	Meet the requirement of limit.
2.1051 27.53(m)(4)(6)	Band Edge Measurements	PASS	Meet the requirement of limit.
2.1051 27.53(m)(4)(6)	Conducted Spurious Emissions	PASS	Meet the requirement of limit.
2.1053 27.53(m)(4)(6)	Radiated Spurious Emissions	PASS	Meet the requirement of limit. Minimum passing margin is -4.63dB at 43.58MHz.

2.1 Measurement Uncertainty

Where relevant, the following measurement uncertainty levels have been estimated for tests performed on the EUT as specified in CISPR 16-4-2:

Measurement	Frequency	Expanded Uncertainty (k=2) (±)
Conducted Emissions at mains ports	150kHz ~ 30MHz	2.44 dB
Radiated Emissions up to 1 GHz	30MHz ~ 200MHz	2.93 dB
	200MHz ~ 1000MHz	2.95 dB
Radiated Emissions above 1 GHz	1GHz ~ 18GHz	2.26 dB
	18GHz ~ 40GHz	1.94 dB

This uncertainty represents an expanded uncertainty expressed at approximately the 95% confidence level using a coverage factor of k=2.

2.2 Test Site And Instruments

Equipment	Manufacturer	Model No.	Serial No.	Last Cal.	Next Cal.
EMI Test Receiver	Rohde&Schwarz	ESR7	101494	Apr. 05,16	Apr. 04,17
Signal and Spectrum Analyzer	Rohde&Schwarz	FSV40	101094	Apr. 05,16	Apr. 04,17
Bilog Antenna 1	Teseq	CBL 6111D	30643	Oct. 26,15	Jun. 24,17
Bilog Antenna 2	Teseq	CBL 6111D	27089	Oct. 25,15	Jun. 24,17
Horn Antenna	ETS-Lindgren	3117	00062558	May 30,15	May 29,17
Horn Antenna (15GHz-40GHz)	SCHWARZBECK	BBHA 9170	BBHA9170147	Jan. 21,15	Jan. 20,17
Amplifier	Burgeon	BPA-530	100220	Apr. 05,16	Apr. 04,17
Pre-Amplifier	HP	8449B	3008A00409	Apr. 24,16	Apr. 23,17
Pre-Amplifier (18GHz-40GHz)	EMCI	EMC 184045	980102	Nov. 11,15	Nov. 10,16
GPS Generator+ Antenna	TOJOIN	GNSS-5000A	E1-010119	Aug. 08, 14	Aug. 07, 16
3m Semi-anechoic Chamber	ETS-LINDGREN	9m*6m*6m	NSEMC003	Mar. 12,16	Mar. 11,18
Test Software	ADT	ADT_Radiated_V7.6.15.9.2	N/A	N/A	N/A
Power Meter	Anritsu	ML2495A	1139001	Feb.19,16	Feb. 18,17
Power Sensor	Anritsu	MA2411B	1126068	Feb.19,16	Feb. 18,17
Power Sensor	Keysight	U2021XA	MY55060016	May 27,15	May 26,17
Power Sensor	Keysight	U2021XA	MY55060018	May 27,15	May 26,17
Digital Multimeter	FLUKE	15B	A1220010DG	Oct. 12, 15	Oct. 11, 16
Humid & Temp Programmable Tester	Haida	HD-2257	110807201	Sep.07,15	Sep. 06,16
Oscilloscope	Agilent	DSO9254A	MY51260160	Nov. 09,15	Nov. 08,16
Signal Analyzer	Rohde & Schwarz	FSV7	102331	Nov. 09,15	Nov. 08,16
Signal Generator	Agilent	N5183A	MY50140980	Apr. 21, 16	Apr. 20, 17
ESG Vector Signal Generator	Agilent	E4438C	MY49072505	Sep. 01,15	Aug. 31,16
BLUETOOTH TESTER	Rohde&Schwarz	CBT32	100811	Oct. 12, 15	Oct. 11, 16

NOTE: 1. The calibration interval of the above test instruments is 12 months and the calibrations are traceable to NML/ROC and NIST/USA.

2. The calibration interval of the loop antenna is 24 months and the calibrations are traceable to NML/ROC and NIST/USA.

3. The test was performed in HwaYa Chamber 4.

4. The horn antenna and HP preamplifier (model: 8449B) are used only for the measurement of emission frequency above 1GHz if tested.

5. The FCC Site Registration No. is 460141.

6. The IC Site Registration No. is IC7450F-4.

3 General Information

3.1 General Description of EUT

PRODUCT	Mobile Phone	
BRAND	MI	
MODEL NAME	2016031	
POWER SUPPLY	5.0Vdc (adapter or host equipment) 3.85Vdc (battery)	
MODULATION TECHNOLOGY	LTE	QPSK, 16QAM
FREQUENCY RANGE	LTE Band 7 Channel Bandwidth: 5MHz	2502.5MHz ~ 2567.5MHz
	LTE Band 7 Channel Bandwidth: 10MHz	2505MHz ~ 2565MHz
	LTE Band 7 Channel Bandwidth: 15MHz	2507.5MHz ~ 2562.5MHz
	LTE Band 7 Channel Bandwidth: 20MHz	2510MHz ~ 2560MHz
	LTE Band 41 Channel Bandwidth: 5MHz	2557.5MHz ~ 2652.5MHz
	LTE Band 41 Channel Bandwidth: 10MHz	2560.0MHz ~ 2650.0MHz
	LTE Band 41 Channel Bandwidth: 15MHz	2562.5MHz ~ 2647.5MHz
	LTE Band 41 Channel Bandwidth: 20MHz	2565.0MHz ~ 2645.0MHz
EMISSION DESIGNATOR	LTE Band 7 Channel Bandwidth: 5MHz	QPSK: 4M48G7D 16QAM: 4M47W7D
	LTE Band 7 Channel Bandwidth: 10MHz	QPSK: 8M92G7D 16QAM: 8M94W7D
	LTE Band 7 Channel Bandwidth: 15MHz	QPSK: 13M4G7D 16QAM: 13M4W7D
	LTE Band 7 Channel Bandwidth: 20MHz	QPSK: 17M9G7D 16QAM: 17M9W7D
	LTE Band 41 Channel Bandwidth: 5MHz	QPSK: 4M48G7D 16QAM: 4M47W7D
	LTE Band 41 Channel Bandwidth: 10MHz	QPSK: 8M92G7D 16QAM: 8M93W7D
	LTE Band 41 Channel Bandwidth: 15MHz	QPSK: 13M4G7D 16QAM: 13M4W7D
	LTE Band 41 Channel Bandwidth: 20MHz	QPSK: 17M9G7D 16QAM: 17M8W7D
MAX. EIRP POWER	LTE Band 7 Channel Bandwidth: 5MHz	276mW
	LTE Band 7 Channel Bandwidth: 10MHz	298mW
	LTE Band 7 Channel Bandwidth: 15MHz	288mW
	LTE Band 7 Channel Bandwidth: 20MHz	243mW

	LTE Band 41 Channel Bandwidth: 5MHz	217mW
	LTE Band 41 Channel Bandwidth: 10MHz	228mW
	LTE Band 41 Channel Bandwidth: 15MHz	224mW
	LTE Band 41 Channel Bandwidth: 20MHz	199mW
ANTENNA TYPE	PIFA Antenna with 1.12dBi gain for LTE Band 7 PIFA Antenna with -1.02dBi gain for LTE Band 41	
HW VERSION	P4	
SW VERSION	V7.3.0.4.MALMIDE	
I/O PORTS	Refer to user's manual	
DATA CABLE	USB cable: non-shielded, detachable, 1.2m	

Note:

- The above EUT information is declared by manufacturer and for more detailed features description, please refer to the manufacturer's specifications or User's Manual.
- The EUT was powered by the following adapter:

ADAPTER	
BRAND:	MI
MODEL:	MDY-08-EF
INPUT:	AC 100-240V, 500mA
OUTPUT:	DC 5V, 2000mA

- The EUT matched the following USB cables:

USB CABLE 1	
BRAND:	MI
MODEL:	KLC-2100
SIGNAL LINE:	1.2 METER

USB CABLE 2	
BRAND:	MI
MODEL:	RS418D010(RICHSTAR)
SIGNAL LINE:	1.2 METER

- For the test results, the EUT had been tested with all conditions. But only the worst case was shown in test report.

3.2 Configuration of System Under Test

FOR RADIATION EMISSION TEST

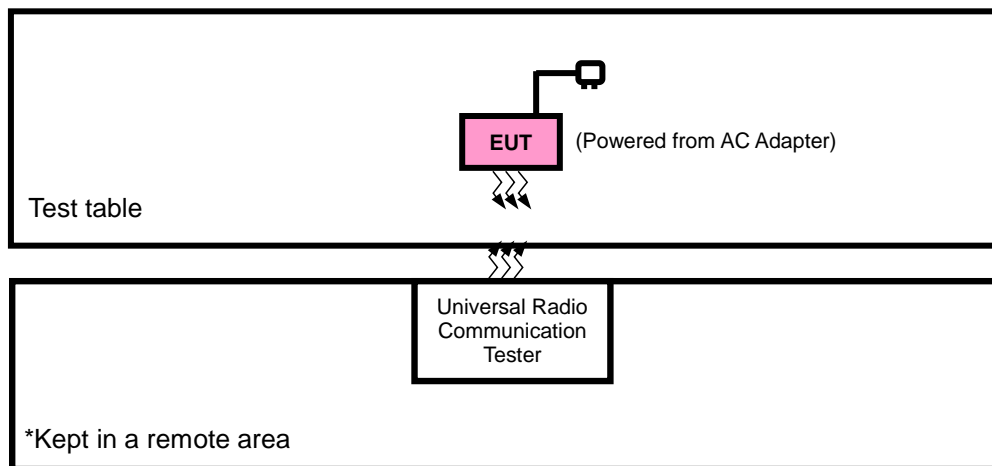

FOR E.R.P./E.I.R.P TEST

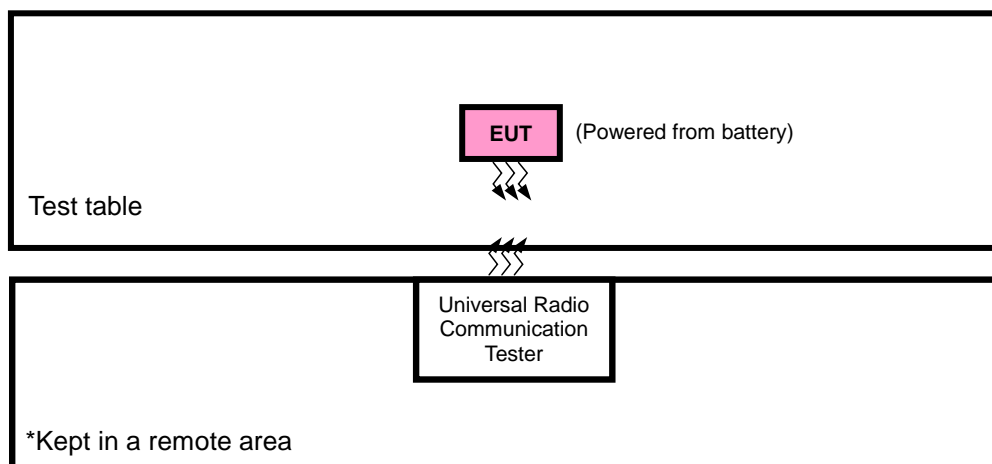

3.2.1 Description Of Support Units

The EUT has been tested as an independent unit together with other necessary accessories or support units. The following support units or accessories were used to form a representative test configuration during the tests.

NO.	PRODUCT	BRAND	MODEL NO.	SERIAL NO.	FCC ID
1	DC source	LONG WEI	PS-6403D	010934269	N/A
2	PC	HP	A6608CN	3CR83825X3	N/A

NO.	SIGNAL CABLE DESCRIPTION OF THE ABOVE SUPPORT UNITS
1	DC Line: Unshielded, Detachable 1.0m
2	AC Line: Unshielded, Detachable 1.5m

NOTE:

1. All power cords of the above support units are non shielded (1.8m).

3.3 Test Mode Applicability and Tested Channel Detail

Pre-Scan has been conducted to determine the worst-case mode from all possible combinations between available modulations, data rates, XYZ axis and antenna ports
 The worst case was found when positioned on X-plane. Following channel(s) was (were) selected for the final test as listed below:

EUT CONFIGURE MODE	DESCRIPTION
A	EUT + Adapter + USB Cable with LTE link
B	EUT + Battery + USB Cable with LTE link

LTE BAND 7

EUT CONFIGURE MODE	TEST ITEM	AVAILABLE CHANNEL	TESTED CHANNEL	CHANNEL BANDWIDTH	MODULATION	MODE
B	EIRP	20775 to 21425	20775, 21100, 21425	5MHz	QPSK, 16QAM	1 RB / 0 RB Offset
		20800 to 21400	20800, 21100, 21400	10MHz	QPSK, 16QAM	1 RB / 0RB Offset
		20825 to 21375	20825, 21100, 21375	15MHz	QPSK, 16QAM	1 RB / 0 RB Offset
		20850 to 21350	20850, 21100 21350	20MHz	QPSK, 16QAM	1 RB / 0 RB Offset
B	FREQUENCY STABILITY	20775 to 21425	21100	5MHz	QPSK	1 RB / 0 RB Offset
		20800 to 21400	21100	10MHz	QPSK	1 RB / 0RB Offset
		20825 to 21375	21100	15MHz	QPSK	1 RB / 0 RB Offset
		20850 to 21350	21100	20MHz	QPSK	1 RB / 0 RB Offset
B	OCCUPIED BANDWIDTH	20775 to 21425	20775, 21100, 21425	5MHz	QPSK, 16QAM	25 RB / 0 RB Offset
		20800 to 21400	20800, 21100, 21400	10MHz	QPSK, 16QAM	50 RB / 0 RB Offset
		20825 to 21375	20825, 21100, 21375	15MHz	QPSK, 16QAM	75 RB / 0 RB Offset
		20850 to 21350	20850, 21100 21350	20MHz	QPSK, 16QAM	100 RB / 0 RB Offset
B	PEAK TO AVERAGE RATIO	20775 to 21425	20775, 21100, 21425	5MHz	QPSK, 16QAM	1 RB / 0 RB Offset
		20800 to 21400	20800, 21100, 21400	10MHz	QPSK, 16QAM	1 RB / 0RB Offset
		20825 to 21375	20825, 21100, 21375	15MHz	QPSK, 16QAM	1 RB / 0 RB Offset
		20850 to 21350	20850, 21100 21350	20MHz	QPSK, 16QAM	1 RB / 0 RB Offset
B	BAND EDGE	20775 to 21425	20775, 21425	5MHz	QPSK	1 RB / 12 RB Offset
						25 RB / 0 RB Offset
		20800 to 21400	20800, 21400	10MHz	QPSK	1 RB / 24 RB Offset
						50 RB / 0 RB Offset
		20825 to 21375	20825, 21375	15MHz	QPSK	1 RB / 37 RB Offset
						75 RB / 0 RB Offset
		20850 to 21350	20850, 21350	20MHz	QPSK	1 RB / 50 RB Offset
						100 RB / 0 RB Offset
B	CONDCUETED EMISSION	20775 to 21425	21100	5MHz	QPSK	1 RB / 0 RB Offset
		20800 to 21400	21100	10MHz	QPSK	1 RB / 0RB Offset
		20825 to 21375	21100	15MHz	QPSK	1 RB / 0 RB Offset
		20850 to 21350	21100	20MHz	QPSK	1 RB / 0 RB Offset
A	RADIATED EMISSION	20775 to 21425	21100	5MHz	QPSK	1 RB / 0 RB Offset
		20800 to 21400	21100	10MHz	QPSK	1 RB / 0RB Offset
		20825 to 21375	21100	15MHz	QPSK	1 RB / 0 RB Offset
		20850 to 21350	21100	20MHz	QPSK	1 RB / 0 RB Offset

LTE BAND 41

EUT CONFIGURE MODE	TEST ITEM	AVAILABLE CHANNEL	TESTED CHANNEL	CHANNEL BANDWIDTH	MODULATION	MODE
B	EIRP	40265 to 41215	40265, 40740, 41215	5MHz	QPSK, 16QAM	1 RB / 12 RB Offset
		40290 to 41190	40290, 40740, 41190	10MHz	QPSK, 16QAM	1 RB / 24RB Offset
		40315 to 41165	40315, 40740, 41165	15MHz	QPSK, 16QAM	1 RB / 37 RB Offset
		40340to 41140	40340, 40740, 41140	20MHz	QPSK, 16QAM	1 RB / 50 RB Offset
B	FREQUENCY STABILITY	40265 to 41215	40740	5MHz	QPSK	1 RB / 12 RB Offset
		40290 to 41190	40740	10MHz	QPSK	1 RB / 24RB Offset
		40315 to 41165	40740	15MHz	QPSK	1 RB / 37 RB Offset
		40340 to 41140	40740	20MHz	QPSK	1 RB / 50 RB Offset
B	OCCUPIED BANDWIDTH	40265 to 41215	40265, 40740, 41215	5MHz	QPSK, 16QAM	25 RB / 0 RB Offset
		40290 to 41190	40290, 40740, 41190	10MHz	QPSK, 16QAM	50 RB / 0 RB Offset
		40315 to 41165	40315, 40740, 41165	15MHz	QPSK, 16QAM	75 RB / 0 RB Offset
		40340 to 41140	40340, 40740, 41140	20MHz	QPSK, 16QAM	100 RB / 0 RB Offset
B	PEAK TO AVERAGE RATIO	40265 to 41215	40265, 40740, 41215	5MHz	QPSK, 16QAM	25RB / 0 RB Offset
		40290 to 41190	40290, 40740, 41190	10MHz	QPSK, 16QAM	1 RB / 12 RB Offset
		40315 to 41165	40315, 40740, 41165	15MHz	QPSK, 16QAM	1 RB / 24RB Offset
		40340 to 41140	40340, 40740, 41140	20MHz	QPSK, 16QAM	1 RB / 37 RB Offset
B	BAND EDGE	40265 to 41215	40265, 41215	5MHz	QPSK, 16QAM	1 RB / 50 RB Offset
		40290 to 41190	40290, 41190	10MHz	QPSK, 16QAM	50 RB / 0 RB Offset
		40315 to 41165	40315, 41165	15MHz	QPSK, 16QAM	75 RB / 0 RB Offset
		40340 to 41140	40340, 41140	20MHz	QPSK, 16QAM	100 RB / 0 RB Offset
B	CONDCUDED EMISSION	40265 to 41215	40740	5MHz	QPSK	1 RB / 12 RB Offset
		40290 to 41190	40740	10MHz	QPSK	1 RB / 24RB Offset
		40315 to 41165	40740	15MHz	QPSK	1 RB / 37 RB Offset
		40340 to 41140	40740	20MHz	QPSK	1 RB / 50 RB Offset
A	RADIATED EMISSION	40265 to 41215	40740	5MHz	QPSK	1 RB / 12 RB Offset
		40290 to 41190	40740	10MHz	QPSK	1 RB / 24RB Offset
		40315 to 41165	40740	15MHz	QPSK	1 RB / 37 RB Offset
		40340 to 41140	40740	20MHz	QPSK	1 RB / 50 RB Offset

Note: This device was tested under all bandwidths, RB configurations and modulations. The worst case was found in QPSK modulation.

Test Condition:

Test Item	Environmental Conditions	Input Power	Tested By
ERP	21deg. C, 71%RH 22deg. C, 71%RH	DC 3.85V from battery	Yuqiang Yin
Frequency Stability	24deg. C, 64%RH	DC 3.85V from battery	Yuqiang Yin
Occupied Bandwidth	24deg. C, 64%RH	DC 3.85V from battery	Yuqiang Yin
Band Edge	24deg. C, 64%RH	DC 3.85V from battery	Yuqiang Yin
Conducuted Emission	24deg. C, 64%RH	DC 3.85V from battery	Yuqiang Yin
Radiated Emission	21deg. C, 71%RH	5Vdc from adapter	Alex Chen

3.4 EUT Operating Conditions

The EUT makes a call to the communication simulator. The communication simulator station system controlled a EUT to export maximum output power under transmission mode and specific channel frequency

3.5 General Description of Applied Standards

The EUT is a RF Product. According to the specifications of the manufacturer, it must comply with the requirements of the following standards:

FCC 47 CFR Part 2

FCC 47 CFR Part 27

KDB Publication 971168 D02

ANSI/TIA/EIA-603-D

NOTE: All test items have been performed and recorded as per the above standards.

4 Test Types and Results

4.1 Output Power Measurement

4.1.1 Limits of Output Power Measurement

Mobile / Portable station are limited to 2 watts e.r.p.

4.1.2 Test Procedures

EIRP / ERP Measurement:

- a. All measurements were done at low, middle and high operational frequency range. RBW and VBW is 10MHz for LTE mode.
- b. Substitution method is used for E.I.R.P measurement. In the semi-anechoic chamber, EUT placed on the 0.8m height of Turn Table, rotated the table around 360 degrees to search the maximum radiation power and receiver antenna shall be rotated vertical and horizontal polarization and moved height from 1m to 4m to find the maximum polar radiated power. The "Read Value" is the spectrum reading the maximum power value.
- c. The substitution horn antenna is substituted for EUT at the same position and signals generator export the CW signal to the substitution antenna via a tx cable. Rotated the Turn Table and moved receiving antenna to find the maximum radiation power. Adjust output power level of S.G to get a Value of spectrum reading equal to "Read Value" of step b. Record the power level of S.G.
- d. $EIRP = \text{Output power level of S.G} - \text{TX cable loss} + \text{Antenna gain of substitution horn}.$

Conducted Power Measurement:

- a. The EUT was set up for the maximum power with LTE link data modulation and link up with simulator.
- b. Set the EUT to transmit under low, middle and high channel and record the power level shown on simulator.

4.1.3 Test Setup
EIRP / ERP MEASUREMENT:

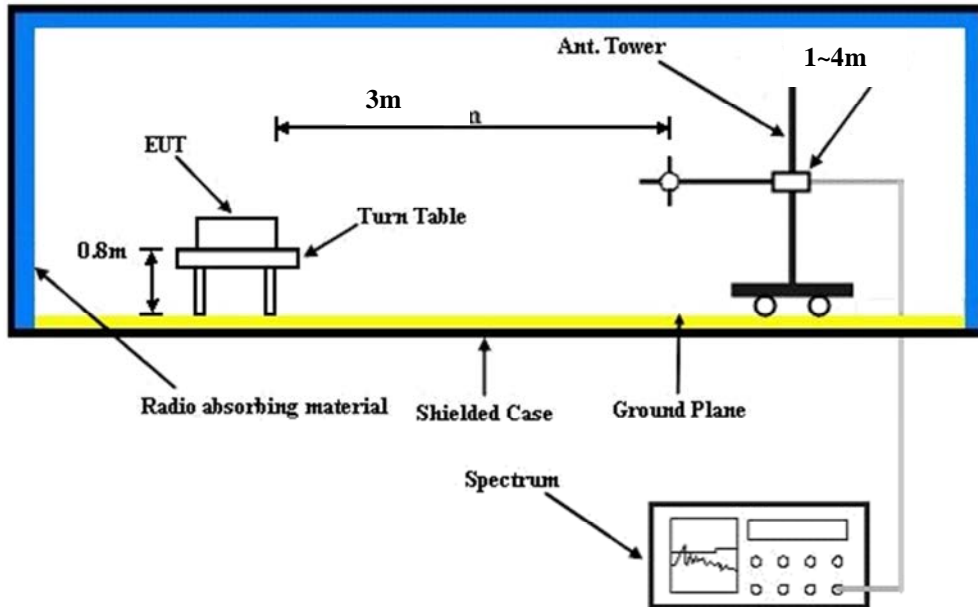

For the actual test configuration, please refer to the attached file (Test Setup Photo).

CONDUCTED POWER MEASUREMENT:



For the actual test configuration, please refer to the attached file (Test Setup Photo).

4.1.4 Test Results

AVERAGE CONDUCTED OUTPUT POWER (dBm)

LTE Band 7							
BW	Modulation	RB Size	RB Offset	Low CH 20775	Mid CH 21100	High CH 21425	MPR
				Frequency 2502.5 MHz	Frequency 2535 MHz	Frequency 2567.5 MHz	
5 MHz	QPSK	1	0	22.84	22.80	22.72	0
		1	12	22.76	22.67	22.70	0
		1	24	22.50	22.57	22.59	0
		12	0	21.98	21.92	21.96	1
		12	6	21.93	21.90	21.92	1
		12	13	21.92	21.87	21.90	1
		25	0	21.90	21.88	21.81	1
	16QAM	1	0	21.62	21.84	21.61	1
		1	12	21.51	21.76	21.66	1
		1	24	21.52	21.65	21.54	1
		12	0	20.74	20.85	20.86	2
		12	6	20.91	20.89	20.94	2
		12	13	20.89	20.86	21.01	2
		25	0	20.79	20.90	20.87	2

LTE Band 7							
BW	Modulation	RB Size	RB Offset	Low CH 20800	Mid CH 21100	High CH 21400	MPR
				Frequency 2505 MHz	Frequency 2535 MHz	Frequency 2565 MHz	
10 MHz	QPSK	1	0	22.88	22.84	22.76	0
		1	24	22.80	22.71	22.74	0
		1	49	22.54	22.61	22.63	0
		25	0	22.02	21.96	22.00	1
		25	12	21.97	21.94	21.96	1
		25	25	21.96	21.91	21.94	1
		50	0	21.94	21.92	21.85	1
	16QAM	1	0	21.66	21.88	21.65	1
		1	24	21.55	21.80	21.70	1
		1	49	21.56	21.69	21.58	1
		25	0	20.78	20.89	20.90	2
		25	12	20.95	20.93	20.98	2
		25	25	20.93	20.90	21.05	2
		50	0	20.83	20.94	20.91	2

BW	Modulation	RB Size	RB Offset	Low CH 20825	Mid CH 21100	High CH 21375	MPR
				Frequency 2507.5 MHz	Frequency 2535 MHz	Frequency 2562.5 MHz	
15 MHz	QPSK	1	0	22.94	22.90	22.82	0
		1	37	22.86	22.77	22.80	0
		1	74	22.60	22.67	22.69	0
		36	0	22.08	22.02	22.06	1
		36	19	22.03	22.00	22.02	1
		36	39	22.02	21.97	22.00	1
		75	0	22.00	21.98	21.91	1
	16QAM	1	0	21.72	21.94	21.71	1
		1	37	21.61	21.86	21.76	1
		1	74	21.62	21.75	21.64	1
		36	0	20.84	20.95	20.96	2
		36	19	21.01	20.99	21.04	2
		36	39	20.99	20.96	21.11	2
		75	0	20.89	21.00	20.97	2

LTE Band 7							
BW	Modulation	RB Size	RB Offset	Low CH 20850	Mid CH 21100	High CH 21350	MPR
				Frequency 2510 MHz	Frequency 2535 MHz	Frequency 2560 MHz	
20 MHz	QPSK	1	0	22.97	22.93	22.85	0
		1	50	22.89	22.80	22.83	0
		1	99	22.63	22.70	22.72	0
		50	0	22.11	22.05	22.09	1
		50	25	22.06	22.03	22.05	1
		50	50	22.05	22.00	22.03	1
		100	0	22.03	22.01	21.94	1
	16QAM	1	0	21.75	21.97	21.74	1
		1	50	21.64	21.89	21.79	1
		1	99	21.65	21.78	21.67	1
		50	0	20.87	20.98	20.99	2
		50	25	21.04	21.02	21.07	2
		50	50	21.02	20.99	21.14	2
		100	0	20.92	21.03	21.00	2

LTE Band 41							
BW	Modulation	RB Size	RB Offset	Low CH (40265)	Mid CH (40740)	High CH (41215)	MPR
				Frequency (2557.5)MHz	Frequency (2605)MHz	Frequency (2652.5)MHz	
5 MHz	QPSK	1	0	22.93	23.08	22.96	0
		1	12	22.90	23.05	22.95	0
		1	24	22.89	22.74	22.88	0
		12	0	21.90	22.20	22.09	1
		12	6	21.88	22.16	22.05	1
		12	13	21.84	22.00	21.94	1
		25	0	21.96	22.01	21.93	1
	16QAM	1	0	21.63	21.73	21.91	1
		1	12	21.60	21.63	21.89	1
		1	24	21.52	21.61	21.79	1
		12	0	20.84	21.08	20.95	2
		12	6	20.82	21.05	20.92	2
		12	13	20.72	20.91	20.92	2
		25	0	20.83	21.05	21.11	2

LTE Band 41							
BW	Modulation	RB Size	RB Offset	Low CH (40290)	Mid CH (40740)	High CH (41190)	MPR
				Frequency (2560)MHz	Frequency (2605)MHz	Frequency (2650)MHz	
10 MHz	QPSK	1	0	22.96	23.11	22.99	0
		1	24	22.93	23.08	22.98	0
		1	49	22.92	22.77	22.91	0
		25	0	21.93	22.23	22.12	1
		25	12	21.91	22.19	22.08	1
		25	25	21.87	22.03	21.97	1
		50	0	21.99	22.04	21.96	1
	16QAM	1	0	21.66	21.76	21.94	1
		1	24	21.63	21.66	21.92	1
		1	49	21.55	21.64	21.82	1
		25	0	20.87	21.11	20.98	2
		25	12	20.85	21.08	20.95	2
		25	25	20.75	20.94	20.95	2
		50	0	20.86	21.08	21.14	2

LTE Band 41							
BW	Modulation	RB Size	RB Offset	Low CH (40315)	Mid CH (40740)	High CH (41165)	MPR
				Frequency (2562.5)MHz	Frequency (2605)MHz	Frequency (2647.5)MHz	
15 MHz	QPSK	1	0	23.00	23.15	23.03	0
		1	37	22.97	23.12	23.02	0
		1	74	22.96	22.81	22.95	0
		36	0	21.97	22.27	22.16	1
		36	19	21.95	22.23	22.12	1
		36	39	21.91	22.07	22.01	1
		75	0	22.03	22.08	22.00	1
	16QAM	1	0	21.70	21.80	21.98	1
		1	37	21.67	21.70	21.96	1
		1	74	21.59	21.68	21.86	1
		36	0	20.91	21.15	21.02	2
		36	19	20.89	21.12	20.99	2
		36	39	20.79	20.98	20.99	2
		75	0	20.90	21.12	21.18	2

LTE Band 41							
BW	Modulation	RB Size	RB Offset	Low CH (40340)	Mid CH (40740)	High CH (41140)	MPR
				Frequency (2565)MHz	Frequency (2605)MHz	Frequency (2645)MHz	
20 MHz	QPSK	1	0	23.06	23.21	23.09	0
		1	50	23.03	23.18	23.08	0
		1	99	23.02	22.87	23.01	0
		50	0	22.03	22.33	22.22	1
		50	25	22.01	22.29	22.18	1
		50	50	21.97	22.13	22.07	1
		100	0	22.09	22.14	22.06	1
	16QAM	1	0	21.76	21.86	22.04	1
		1	50	21.73	21.76	22.02	1
		1	99	21.65	21.74	21.92	1
		50	0	20.97	21.21	21.08	2
		50	25	20.95	21.18	21.05	2
		50	50	20.85	21.04	21.05	2
		100	0	20.96	21.18	21.24	2

EIRP

LTE BAND 7

CHANNEL BANDWIDTH: 5MHz QPSK

Channel	Frequency (MHz)	LVL (dBm)	Correction Factor(dB)	EIRP(dBm)	EIRP(mW)	Polarization (H/V)	Limit (W)
20775	2502.5	-22.36	45.65	23.29	213.21	H	2
21100	2535.0	-22.18	46.04	23.86	242.94	H	2
21425	2567.5	-21.46	45.87	24.41	275.80	H	2
20775	2502.5	-22.98	47.03	24.05	253.98	V	2
21100	2535.0	-23.58	46.57	22.99	199.07	V	2
21425	2567.5	-23.03	46.98	23.95	248.31	V	2

NOTE: EIRP (dBm) = LVL (dBm) + Correction Factor (dB)

CHANNEL BANDWIDTH: 5MHz 16QAM

Channel	Frequency (MHz)	LVL (dBm)	Correction Factor(dB)	EIRP(dBm)	EIRP(mW)	Polarization (H/V)	Limit (W)
20775	2502.5	-23.19	45.65	22.46	176.12	H	2
21100	2535.0	-23.20	46.04	22.84	192.09	H	2
21425	2567.5	-22.56	45.87	23.31	214.09	H	2
20775	2502.5	-23.81	47.03	23.22	209.80	V	2
21100	2535.0	-24.60	46.57	21.97	157.40	V	2
21425	2567.5	-24.13	46.98	22.85	192.75	V	2

NOTE: EIRP (dBm) = LVL (dBm) + Correction Factor (dB)

CHANNEL BANDWIDTH: 10MHz QPSK

Channel	Frequency (MHz)	LVL (dBm)	Correction Factor(dB)	EIRP(dBm)	EIRP(mW)	Polarization (H/V)	Limit (W)
20800	2505.0	-22.17	45.65	23.48	222.79	H	2
21100	2535.0	-22.12	46.04	23.92	246.32	H	2
21400	2565.0	-21.33	46.07	24.74	297.51	H	2
20800	2505.0	-22.79	47.18	24.39	274.54	V	2
21100	2535.0	-23.52	46.57	23.05	201.84	V	2
21400	2565.0	-22.90	47.06	24.16	260.86	V	2

NOTE: EIRP (dBm) = LVL (dBm) + Correction Factor (dB)

CHANNEL BANDWIDTH: 10MHz 16QAM

Channel	Frequency (MHz)	LVL (dBm)	Correction Factor(dB)	EIRP(dBm)	EIRP(mW)	Polarization (H/V)	Limit (W)
20800	2505.0	-23.32	45.65	22.33	170.96	H	2
21100	2535.0	-23.22	46.04	22.82	191.21	H	2
21400	2565.0	-22.49	46.07	23.58	227.77	H	2
20800	2505.0	-23.94	47.18	23.24	210.67	V	2
21100	2535.0	-24.62	46.57	21.95	156.68	V	2
21400	2565.0	-24.06	47.06	23.00	199.71	V	2

NOTE: EIRP (dBm) = LVL (dBm) + Correction Factor (dB)

CHANNEL BANDWIDTH: 15MHz QPSK

Channel	Frequency (MHz)	LVL (dBm)	Correction Factor(dB)	EIRP(dBm)	EIRP(mW)	Polarization (H/V)	Limit (W)
20825	2507.5	-22.18	45.63	23.45	221.46	H	2
21100	2535.0	-22.19	46.04	23.85	242.38	H	2
21375	2562.5	-21.40	45.94	24.54	284.32	H	2
20825	2507.5	-22.80	47.39	24.59	287.67	V	2
21100	2535.0	-23.59	46.57	22.98	198.61	V	2
21375	2562.5	-22.97	47.00	24.03	252.87	V	2

NOTE: EIRP (dBm) = LVL (dBm) + Correction Factor (dB)

CHANNEL BANDWIDTH: 15MHz 16QAM

Channel	Frequency (MHz)	LVL (dBm)	Correction Factor(dB)	EIRP(dBm)	EIRP(mW)	Polarization (H/V)	Limit (W)
20825	2507.5	-23.04	45.63	22.59	181.68	H	2
21100	2535.0	-23.06	46.04	22.98	198.38	H	2
21375	2562.5	-22.25	45.94	23.69	233.78	H	2
20825	2507.5	-23.66	47.39	23.73	235.99	V	2
21100	2535.0	-24.46	46.57	22.11	162.55	V	2
21375	2562.5	-23.82	47.00	23.18	207.92	V	2

NOTE: EIRP (dBm) = LVL (dBm) + Correction Factor (dB)

CHANNEL BANDWIDTH: 20MHz QPSK

Channel	Frequency (MHz)	LVL (dBm)	Correction Factor(dB)	EIRP(dBm)	EIRP(mW)	Polarization (H/V)	Limit (W)
20850	2510.0	-22.76	45.80	23.04	201.33	H	2
21100	2535.0	-22.64	46.04	23.40	218.52	H	2
21350	2560.0	-21.98	45.83	23.85	242.83	H	2
20850	2510.0	-23.38	47.21	23.83	241.55	V	2
21100	2535.0	-24.04	46.57	22.53	178.90	V	2
21350	2560.0	-23.55	47.07	23.52	224.85	V	2

NOTE: EIRP (dBm) = LVL (dBm) + Correction Factor (dB)

CHANNEL BANDWIDTH: 20MHz 16QAM

Channel	Frequency (MHz)	LVL (dBm)	Correction Factor(dB)	EIRP(dBm)	EIRP(mW)	Polarization (H/V)	Limit (W)
20850	2510.0	-23.69	45.80	22.11	162.52	H	2
21100	2535.0	-23.71	46.04	22.33	170.80	H	2
21350	2560.0	-22.81	45.83	23.02	200.59	H	2
20850	2510.0	-24.31	47.21	22.90	194.98	V	2
21100	2535.0	-25.11	46.57	21.46	139.83	V	2
21350	2560.0	-24.38	47.07	22.69	185.74	V	2

NOTE: EIRP (dBm) = LVL (dBm) + Correction Factor (dB)

LTE BAND 41

CHANNEL BANDWIDTH: 5MHz QPSK

Channel	Frequency (MHz)	LVL (dBm)	Correction Factor(dB)	EIRP(dBm)	EIRP(mW)	Polarization (H/V)	Limit (W)
40265	2557.5	-24.21	45.82	21.61	144.88	H	2
40740	2605.0	-24.96	46.15	21.19	131.52	H	2
41215	2652.5	-25.23	46.32	21.09	128.53	H	2
40265	2557.5	-23.68	47.05	23.37	217.27	V	2
40740	2605.0	-24.44	47.18	22.74	187.93	V	2
41215	2652.5	-23.97	47.29	23.32	214.78	V	2

NOTE: EIRP (dBm) = LVL (dBm) + Correction Factor (dB)

CHANNEL BANDWIDTH: 5MHz 16QAM

Channel	Frequency (MHz)	LVL (dBm)	Correction Factor(dB)	EIRP(dBm)	EIRP(mW)	Polarization (H/V)	Limit (W)
40265	2557.5	-25.04	45.82	20.78	119.67	H	2
40740	2605.0	-25.98	46.15	20.17	103.99	H	2
41215	2652.5	-26.33	46.32	19.99	99.77	H	2
40265	2557.5	-24.51	47.05	22.54	179.47	V	2
40740	2605.0	-25.46	47.18	21.72	148.59	V	2
41215	2652.5	-25.07	47.29	22.22	166.72	V	2

NOTE: EIRP (dBm) = LVL (dBm) + Correction Factor (dB)-2.15dB.

CHANNEL BANDWIDTH: 10MHz QPSK

Channel	Frequency (MHz)	LVL (dBm)	Correction Factor(dB)	EIRP(dBm)	EIRP(mW)	Polarization (H/V)	Limit (W)
40290	2560.0	-24.02	45.83	21.81	151.71	H	2
40740	2605.0	-24.90	46.15	21.25	133.35	H	2
41190	2650.0	-25.10	46.31	21.21	132.13	H	2
40290	2560.0	-23.49	47.07	23.58	228.03	V	2
40740	2605.0	-24.38	47.18	22.80	190.55	V	2
41190	2650.0	-23.84	47.28	23.44	220.80	V	2

NOTE: EIRP (dBm) = LVL (dBm) + Correction Factor (dB)

CHANNEL BANDWIDTH: 10MHz 16QAM

Channel	Frequency (MHz)	LVL (dBm)	Correction Factor(dB)	EIRP(dBm)	EIRP(mW)	Polarization (H/V)	Limit (W)
40290	2560.0	-25.17	45.83	20.66	116.41	H	2
40740	2605.0	-26.00	46.15	20.15	103.51	H	2
41190	2650.0	-26.26	46.31	20.05	101.16	H	2
40290	2560.0	-24.64	47.07	22.43	174.98	V	2
40740	2605.0	-25.48	47.18	21.70	147.91	V	2
41190	2650.0	-25.00	47.28	22.28	169.04	V	2

NOTE: EIRP (dBm) = LVL (dBm) + Correction Factor (dB)

CHANNEL BANDWIDTH: 15MHz QPSK

Channel	Frequency (MHz)	LVL (dBm)	Correction Factor(dB)	EIRP(dBm)	EIRP(mW)	Polarization (H/V)	Limit (W)
40315	2562.5	-24.03	45.94	21.91	155.24	H	2
40740	2605.0	-24.97	46.15	21.18	131.22	H	2
41165	2647.5	-25.17	46.29	21.12	129.42	H	2
40315	2562.5	-23.50	47.00	23.50	223.87	V	2
40740	2605.0	-24.45	47.18	22.73	187.50	V	2
41165	2647.5	-23.91	47.24	23.33	215.28	V	2

NOTE: EIRP (dBm) = LVL (dBm) + Correction Factor (dB)

CHANNEL BANDWIDTH: 15MHz 16QAM

Channel	Frequency (MHz)	LVL (dBm)	Correction Factor(dB)	EIRP(dBm)	EIRP(mW)	Polarization (H/V)	Limit (W)
40315	2562.5	-24.89	45.94	21.05	127.35	H	2
40740	2605.0	-25.84	46.15	20.31	107.40	H	2
41165	2647.5	-26.02	46.29	20.27	106.41	H	2
40315	2562.5	-24.36	47.00	22.64	183.65	V	2
40740	2605.0	-25.32	47.18	21.86	153.46	V	2
41165	2647.5	-24.76	47.24	22.48	177.01	V	2

NOTE: EIRP (dBm) = LVL (dBm) + Correction Factor (dB)

CHANNEL BANDWIDTH: 20MHz QPSK

Channel	Frequency (MHz)	LVL (dBm)	Correction Factor(dB)	EIRP(dBm)	EIRP(mW)	Polarization (H/V)	Limit (W)
40340	2565.0	-24.61	46.07	21.46	139.96	H	2
40740	2605.0	-25.42	46.15	20.73	118.30	H	2
41140	2645.0	-25.75	46.27	20.52	112.72	H	2
40340	2565.0	-24.08	47.06	22.98	198.61	V	2
40740	2605.0	-24.90	47.18	22.28	169.04	V	2
41140	2645.0	-24.49	47.22	22.73	187.50	V	2

NOTE: EIRP (dBm) = LVL (dBm) + Correction Factor (dB)

CHANNEL BANDWIDTH: 20MHz 16QAM

Channel	Frequency (MHz)	LVL (dBm)	Correction Factor(dB)	EIRP(dBm)	EIRP(mW)	Polarization (H/V)	Limit (W)
40340	2565.0	-25.54	46.07	20.53	112.98	H	2
40740	2605.0	-26.49	46.15	19.66	92.47	H	2
41140	2645.0	-26.58	46.27	19.69	93.11	H	2
40340	2565.0	-25.01	47.06	22.05	160.32	V	2
40740	2605.0	-25.97	47.18	21.21	132.13	V	2
41140	2645.0	-25.32	47.22	21.90	154.88	V	2

NOTE: EIRP (dBm) = LVL (dBm) + Correction Factor (dB)

4.2 Frequency Stability Measurement

4.2.1 Limits of Frequency Stability Measurement

The frequency stability shall be sufficient to ensure that the fundamental emissions stay within the authorized bands of operation.

4.2.2 Test Procedure

- a. Device is placed at the oven room. The oven room could control the temperatures and humidity. Power warm up is at least 15 min and power applied should perform before recording frequency error.
- b. EUT is connected the external power supply to control the DC input power. The test voltage range is from minimum to maximum working voltage. Each step shall be record the frequency error rate.
- c. The temperature range step is 10 degrees in this test items. All temperature levels shall be hold the $\pm 0.5^{\circ}\text{C}$ during the measurement testing. The each temperature step shall be at least 0.5 hours, consider the EUT could be test under the stability condition.

NOTE: The frequency error was recorded frequency error from the communication simulator.

4.2.3 Test Setup

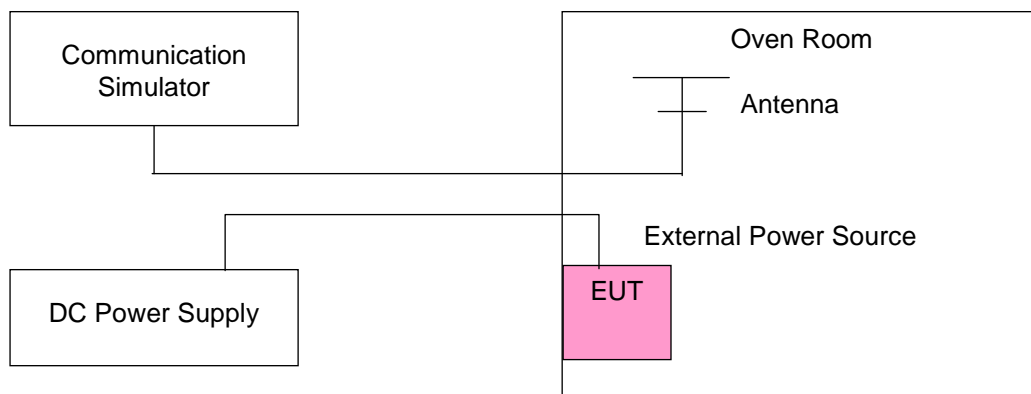

4.2.4 Test Results

FREQUENCY ERROR vs. VOLTAGE

VOLTAGE (Volts)	FREQUENCY ERROR (ppm)				LIMIT (ppm)
	LTE BAND 7				
	5MHz	10MHz	15MHz	20MHz	
3.85	0.0007	0.0011	0.0010	0.0010	2.5
3.6	-0.0009	-0.0012	-0.0012	-0.0013	2.5
4.35	-0.0010	-0.0011	-0.0012	-0.0011	2.5

NOTE: The applicant defined the normal working voltage of the battery is from 3.6Vdc to 4.35Vdc.

FREQUENCY ERROR vs. TEMPERATURE

TEMP. (°C)	FREQUENCY ERROR (ppm)				LIMIT (ppm)
	LTE BAND 7				
	5MHz	10MHz	15MHz	20MHz	
-30	-0.0045	-0.0046	-0.0043	-0.0044	2.5
-20	-0.0040	-0.0040	-0.0038	-0.0039	2.5
-10	-0.0034	-0.0036	-0.0032	-0.0034	2.5
0	-0.0028	-0.0030	-0.0027	-0.0028	2.5
+10	-0.0023	-0.0026	-0.0022	-0.0022	2.5
+20	-0.0017	-0.0021	-0.0017	-0.0018	2.5
+30	-0.0012	-0.0016	-0.0012	-0.0013	2.5
+40	-0.0008	-0.0011	-0.0008	-0.0008	2.5
+50	-0.0004	-0.0005	-0.0002	-0.0003	2.5
+60	0.0001	0.0000	0.0003	0.0001	2.5

FREQUENCY ERROR vs. VOLTAGE

VOLTAGE (Volts)	FREQUENCY ERROR (ppm)				LIMIT (ppm)
	LTE BAND 41				
	5MHz	10MHz	15MHz	20MHz	
3.85	0.0010	0.0007	0.0010	0.0009	2.5
3.6	-0.0014	-0.0010	-0.0013	-0.0012	2.5
4.35	-0.0013	-0.0008	-0.0011	-0.0011	2.5

NOTE: The applicant defined the normal working voltage of the battery is from 3.6Vdc to 4.35Vdc.

FREQUENCY ERROR vs. TEMPERATURE

TEMP. (°C)	FREQUENCY ERROR (ppm)				LIMIT (ppm)
	LTE BAND 41				
	5MHz	10MHz	15MHz	20MHz	
-30	-0.0042	-0.0044	-0.0042	-0.0040	2.5
-20	-0.0037	-0.0039	-0.0036	-0.0035	2.5
-10	-0.0032	-0.0034	-0.0031	-0.0030	2.5
0	-0.0028	-0.0030	-0.0026	-0.0024	2.5
+10	-0.0023	-0.0024	-0.0020	-0.0019	2.5
+20	-0.0017	-0.0019	-0.0015	-0.0015	2.5
+30	-0.0012	-0.0014	-0.0010	-0.0010	2.5
+40	-0.0008	-0.0010	-0.0004	-0.0005	2.5
+50	-0.0003	-0.0005	0.0000	0.0000	2.5
+60	0.0002	0.0001	0.0003	0.0004	2.5

4.3 Occupied Bandwidth Measurement

4.3.1 Limits Of Occupied Bandwidth Measurement

The width of a frequency band such that, below the lower and above the upper frequency limits, the mean powers emitted are each equal to a specified percentage 0.5 % of the total mean power of a given emission.

4.3.2 Test Setup

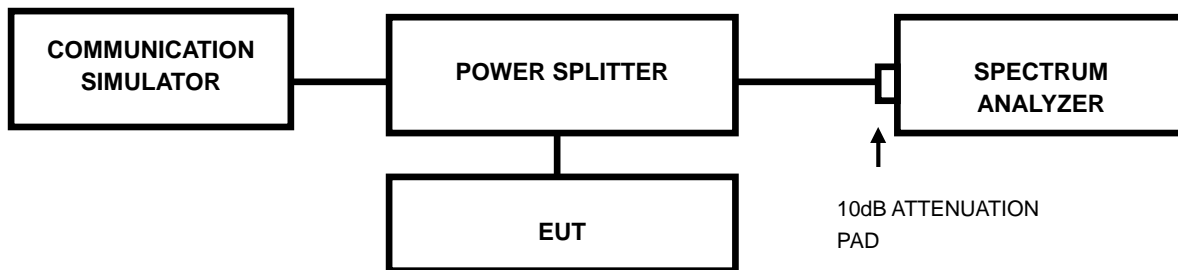

4.3.3 Test Procedures

- a. The conducted occupied bandwidth used the power splitter via EUT RF power connector between simulation base station and spectrum analyzer.
- b. Use OBW measurement function of Spectrum analyzer to measure 99 % occupied bandwidth.

4.3.4 Test Result

LTE BAND 7							
CHANNEL BANDWIDTH: 5MHz				CHANNEL BANDWIDTH: 10MHz			
CHANNEL	FREQUENCY (MHz)	99% OCCUPIED BANDWIDTH (MHz)		CHANNEL	FREQUENCY (MHz)	99% OCCUPIED BANDWIDTH (MHz)	
		QPSK	16QAM			QPSK	16QAM
20775	2502.5	4.48	4.47	20800	2505	8.92	8.93
21100	2535	4.47	4.46	21100	2535	8.90	8.92
21425	2567.5	4.47	4.46	21400	2565	8.91	8.94

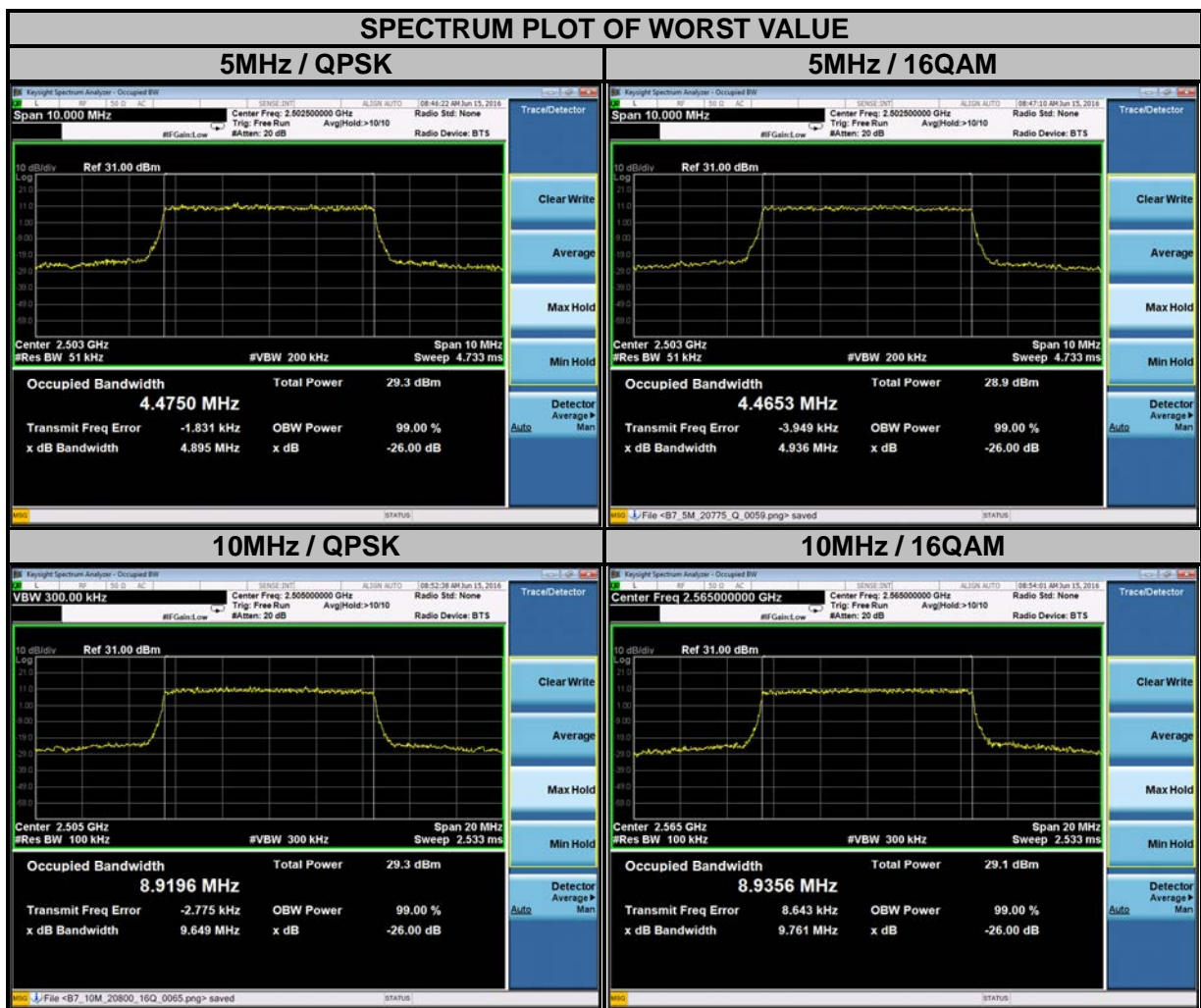

LTE BAND 7							
CHANNEL BANDWIDTH: 15MHz				CHANNEL BANDWIDTH: 20MHz			
CHANNEL	FREQUENCY (MHz)	99% OCCUPIED BANDWIDTH (MHz)		CHANNEL	FREQUENCY (MHz)	99% OCCUPIED BANDWIDTH (MHz)	
		QPSK	16QAM			QPSK	16QAM
20825	2507.5	13.41	13.38	20850	2510	17.91	17.88
21100	2535	13.38	13.36	21100	2535	17.84	17.80
21375	2562.5	13.36	13.37	21350	2560	17.87	17.83

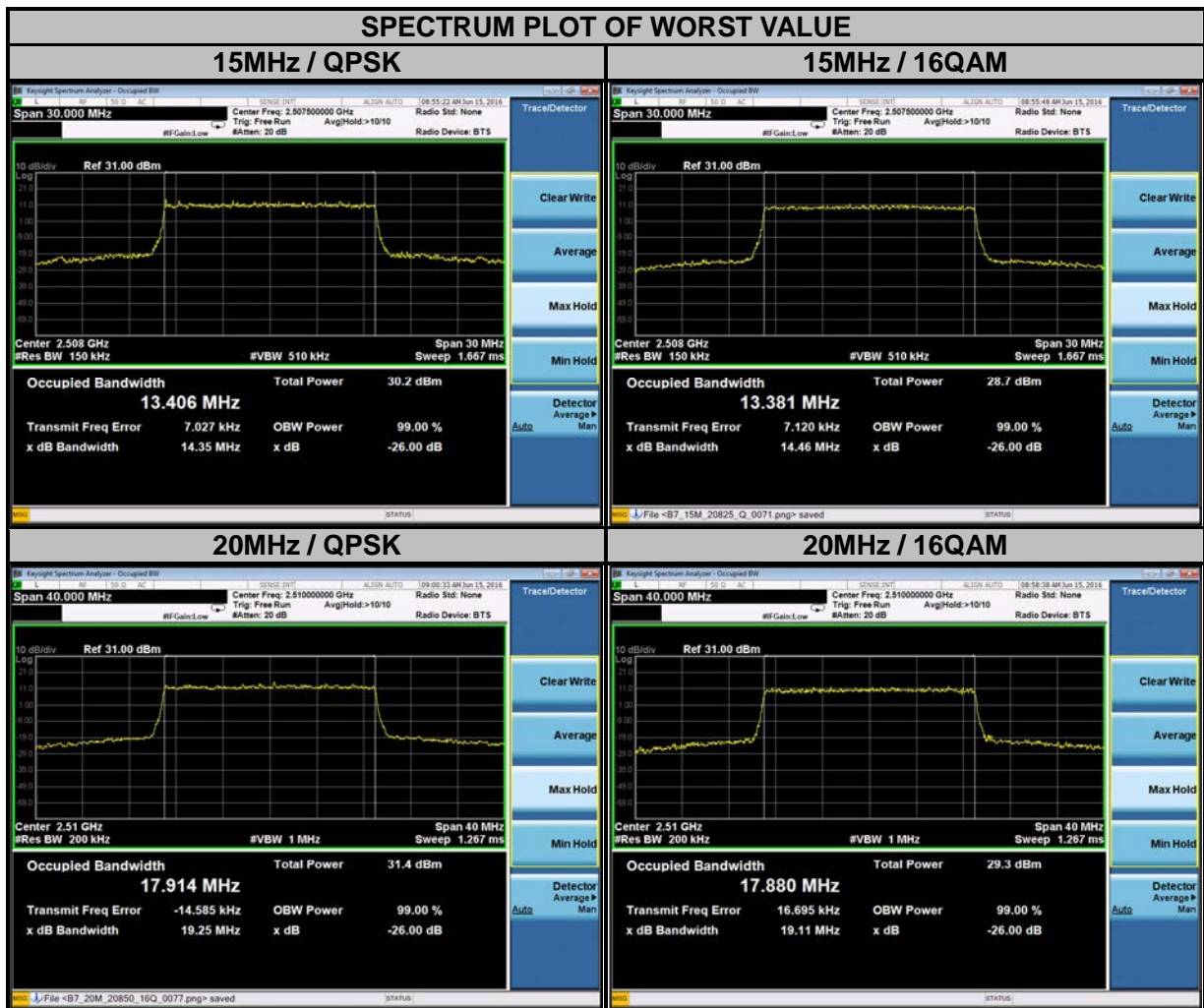

LTE BAND 41							
CHANNEL BANDWIDTH: 5MHz				CHANNEL BANDWIDTH: 10MHz			
CHANNEL	FREQUENCY (MHz)	99% OCCUPIED BANDWIDTH (MHz)		CHANNEL	FREQUENCY (MHz)	99% OCCUPIED BANDWIDTH (MHz)	
		QPSK	16QAM			QPSK	16QAM
40265	2557.5	4.47	4.47	40290	2560	8.92	8.93
40740	2605	4.48	4.47	40740	2605	8.92	8.93
41215	2652.5	4.48	4.47	41190	2650	8.92	8.93

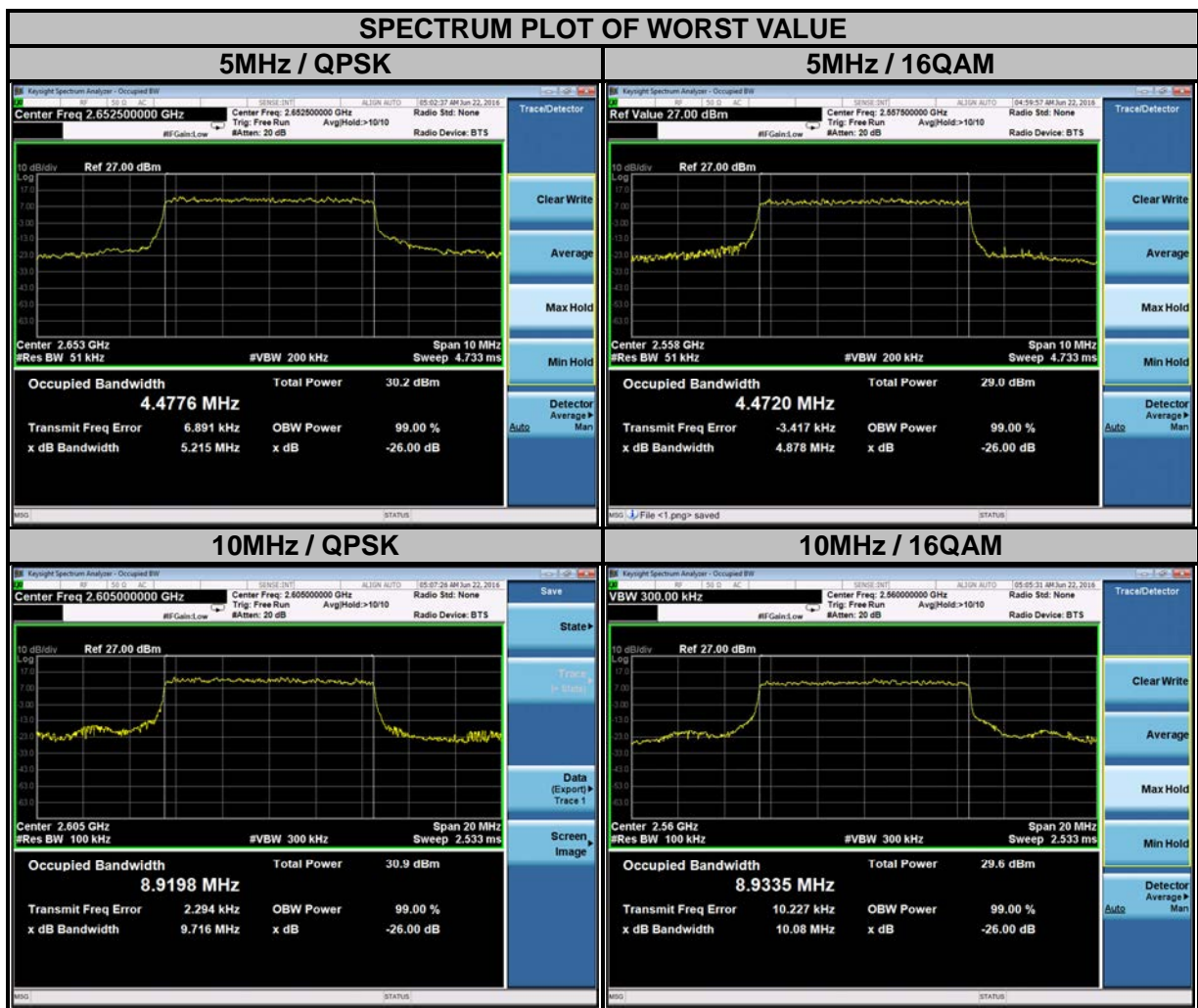

LTE BAND 41							
CHANNEL BANDWIDTH: 15MHz				CHANNEL BANDWIDTH: 20MHz			
CHANNEL	FREQUENCY (MHz)	99% OCCUPIED BANDWIDTH (MHz)		CHANNEL	FREQUENCY (MHz)	99% OCCUPIED BANDWIDTH (MHz)	
		QPSK	16QAM			QPSK	16QAM
40315	2562.5	13.40	13.38	40340	2565	17.86	17.83
40740	2605	13.40	13.38	40740	2605	17.82	17.81
41165	2647.5	13.38	13.38	41140	2645	17.87	17.82

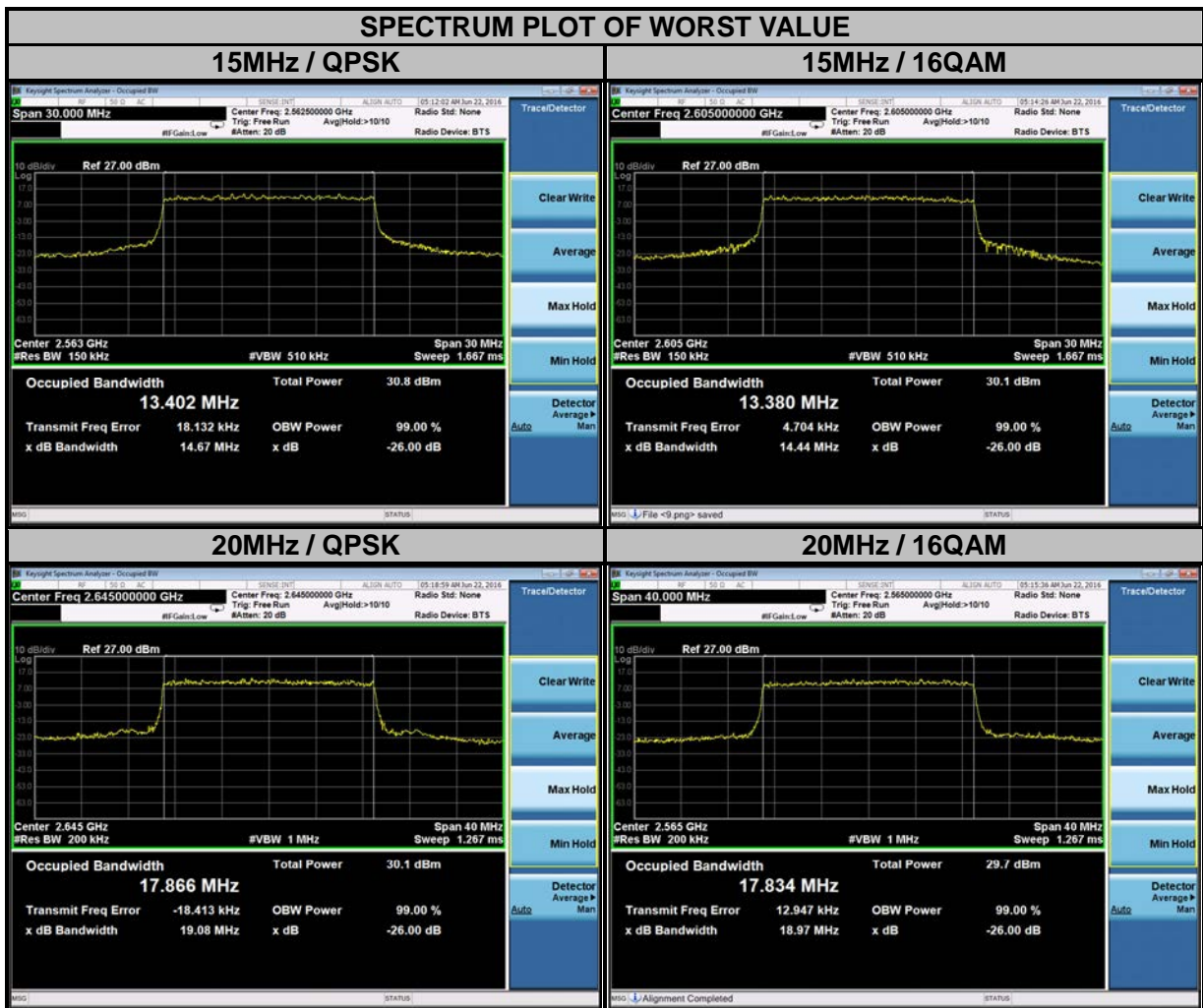

4.4 Peak To Average Ratio

4.4.1 Limits of Peak To Average Ratio Measurement

In measuring transmissions in this band using an average power technique, the peak to-average ratio (PAR) of the transmission may not exceed 13 dB

4.4.2 Test Setup

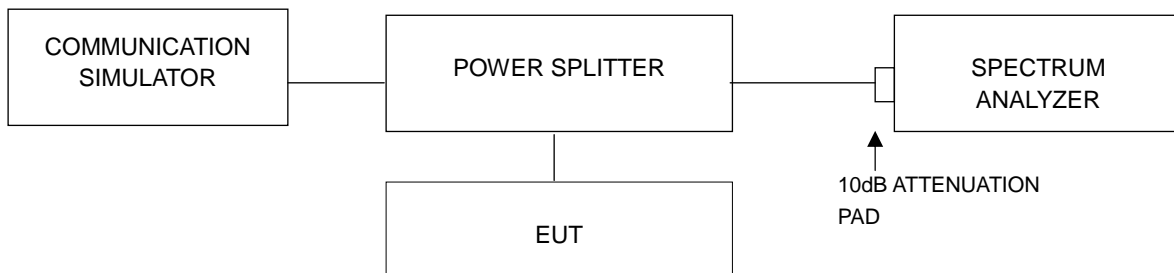

4.4.3 Test Procedures

1. Set resolution/measurement bandwidth \geq signal's occupied bandwidth;
2. Set the number of counts to a value that stabilizes the measured CCDF curve;
3. Record the maximum PAPR level associated with a probability of 0.1%.

4.4.4 Test Results

LTE BAND 7

CHANNEL BANDWIDTH: 5MHz				CHANNEL BANDWIDTH: 10MHz			
CHANNEL	FREQUENCY (MHz)	PEAK TO AVERAGE RATIO (dB)		CHANNEL	FREQUENCY (MHz)	PEAK TO AVERAGE RATIO (dB)	
		QPSK	16QAM			QPSK	16QAM
20775	2502.5	4.85	5.62	20800	2505	4.73	5.54
21100	2535	4.88	5.66	21100	2535	4.76	5.54
21425	2567.5	4.80	5.60	21400	2565	5.09	5.90

SPECTRUM PLOT OF WORST VALUE

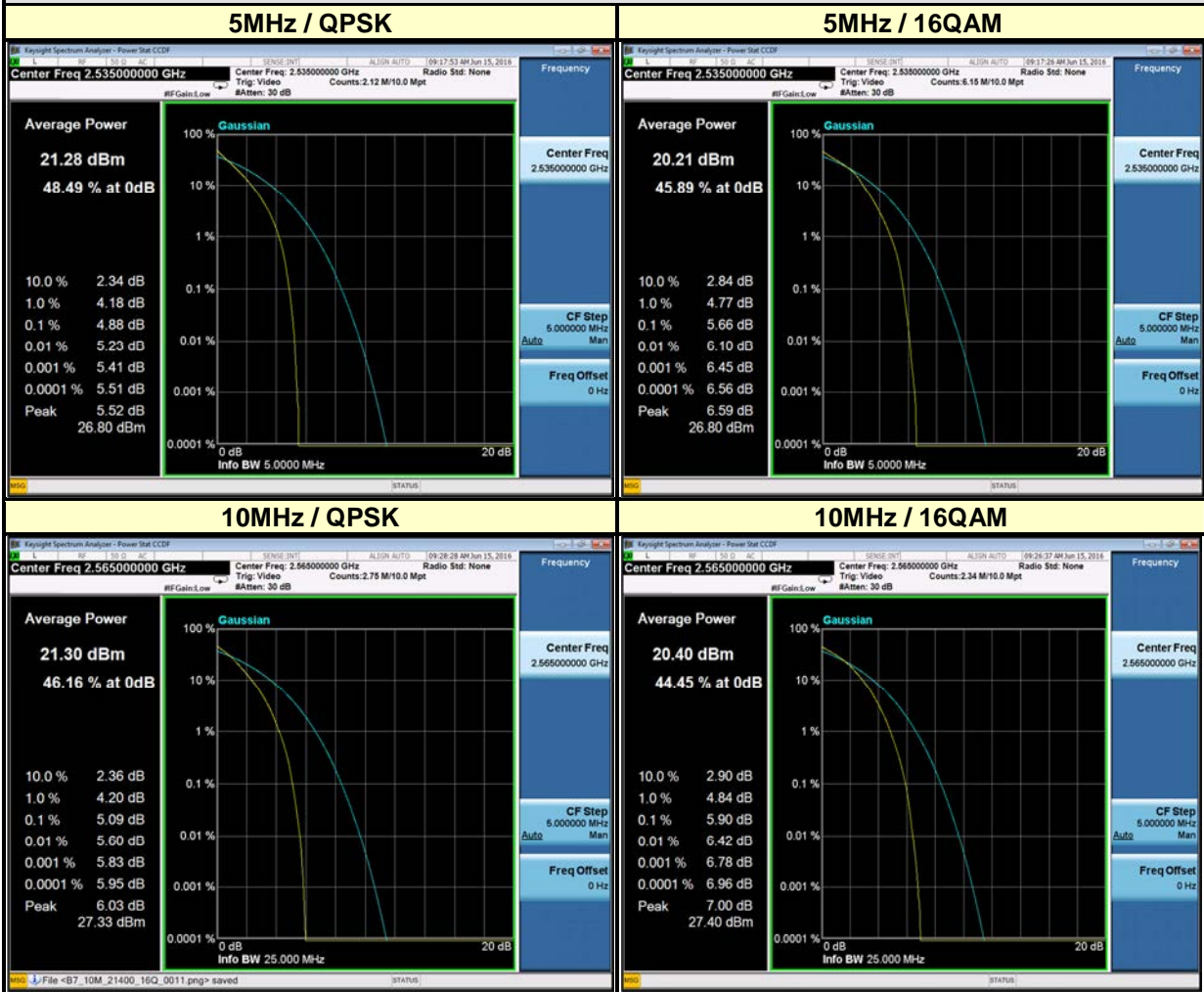

CHANNEL BANDWIDTH: 15MHz				CHANNEL BANDWIDTH: 20MHz			
CHANNEL	FREQUENCY (MHz)	PEAK TO AVERAGE RATIO (dB)		CHANNEL	FREQUENCY (MHz)	PEAK TO AVERAGE RATIO (dB)	
		QPSK	16QAM			QPSK	16QAM
20825	2507.5	4.87	5.54	20850	2510	5.31	5.96
21100	2535	4.77	5.53	21100	2535	4.80	5.56
21375	2562.5	5.07	5.85	21350	2560	4.89	5.86

SPECTRUM PLOT OF WORST VALUE

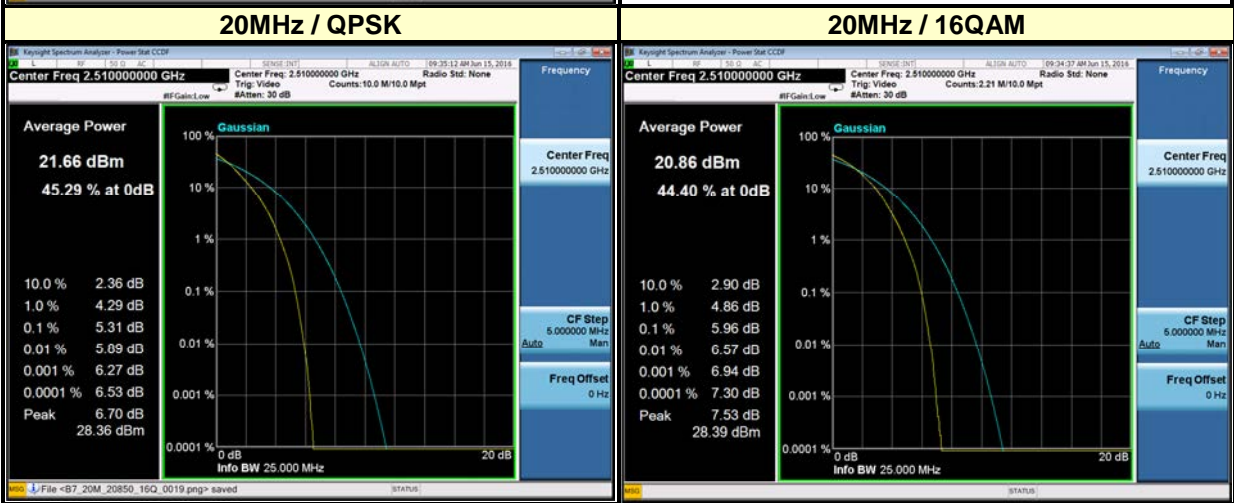

LTE BAND 41

CHANNEL BANDWIDTH: 5MHz				CHANNEL BANDWIDTH: 10MHz			
CHANNEL	FREQUENCY (MHz)	PEAK TO AVERAGE RATIO (dB)		CHANNEL	FREQUENCY (MHz)	PEAK TO AVERAGE RATIO (dB)	
		QPSK	16QAM			QPSK	16QAM
40265	2557.5	5.35	6.01	40290	2560	5.48	6.39
40740	2605	5.13	6.04	40740	2605	5.22	6.23
41215	2652.5	5.46	5.76	41190	2650	5.03	5.57

SPECTRUM PLOT OF WORST VALUE

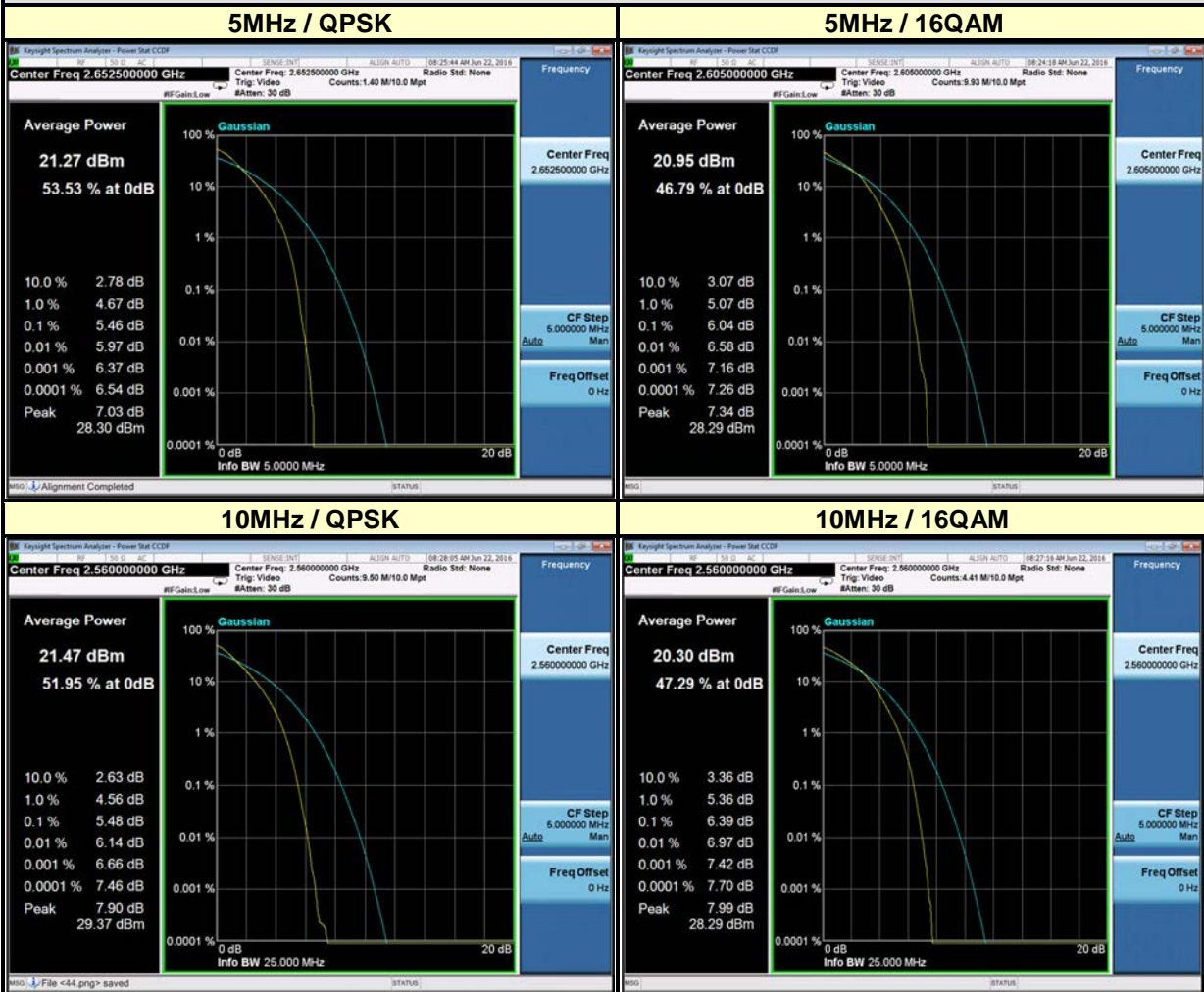

CHANNEL BANDWIDTH: 15MHz				CHANNEL BANDWIDTH: 20MHz			
CHANNEL	FREQUENCY (MHz)	PEAK TO AVERAGE RATIO (dB)		CHANNEL	FREQUENCY (MHz)	PEAK TO AVERAGE RATIO (dB)	
		QPSK	16QAM			QPSK	16QAM
40315	2562.5	5.25	6.11	40340	2565	5.73	6.32
40740	2605	5.25	6.17	40740	2605	5.36	6.14
41165	2647.5	5.13	5.87	41140	2645	5.22	6.02

SPECTRUM PLOT OF WORST VALUE

15MHz / QPSK

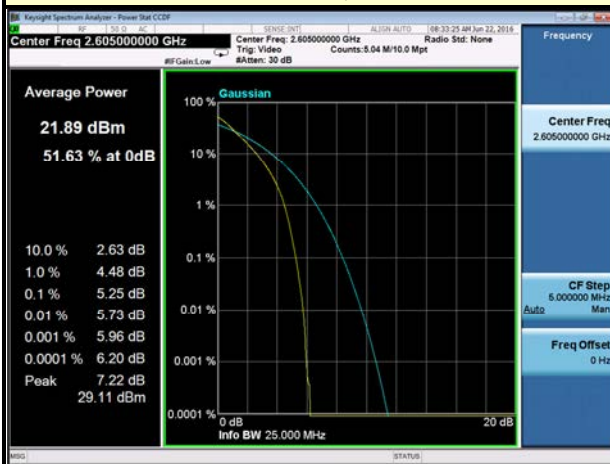

15MHz / 16QAM

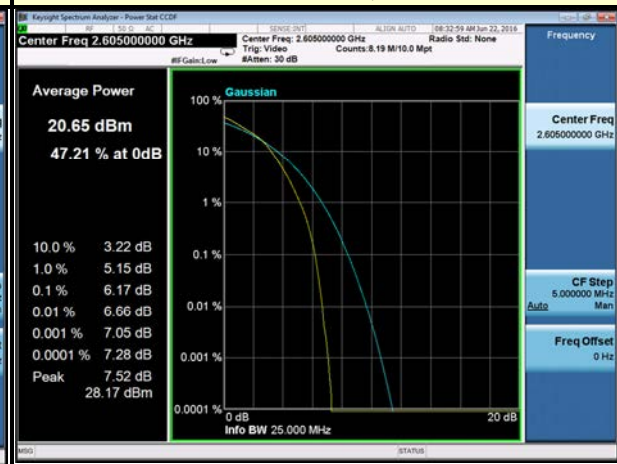

20MHz / QPSK

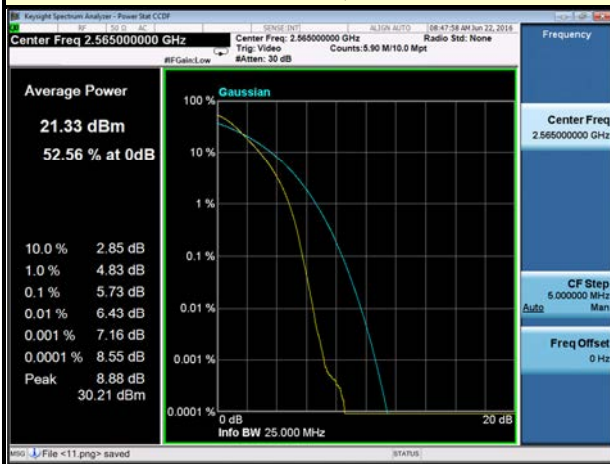

20MHz / 16QAM

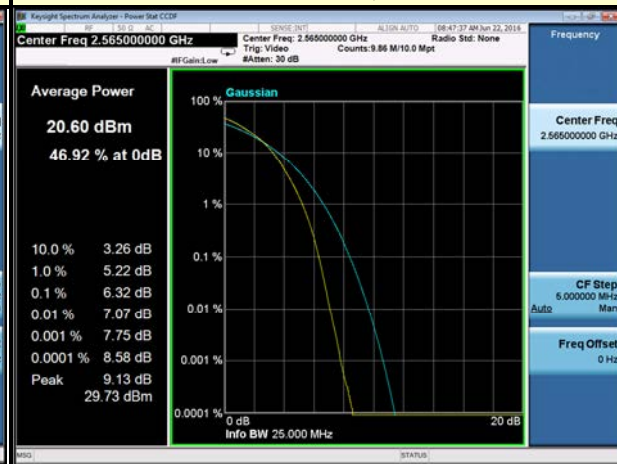

4.5 Band Edge Measurement

4.5.1 Limits of Band Edge Measurement

According to FCC 27.53(m)(4) specified that For mobile digital stations, the attenuation factor shall be not less than $40 + 10 \log (P)$ dB on all frequencies between the channel edge and 5 megahertz from the channel edge, $43 + 10 \log (P)$ dB on all frequencies between 5 megahertz and X megahertz from the channel edge, and $55 + 10 \log (P)$ dB on all frequencies more than X megahertz from the channel edge, where X is the greater of 6 megahertz or the actual emission bandwidth as defined in paragraph (m)(6) of this section. In addition, the attenuation factor shall not be less that $43 + 10 \log (P)$ dB on all frequencies between 2490.5 MHz and 2496 MHz and $55 + 10 \log (P)$ dB at or below 2490.5 MHz. Mobile Satellite Service licensees operating on frequencies below 2495 MHz may also submit a documented interference complaint against BRS licensees operating on channel BRS Channel 1 on the same terms and conditions as adjacent channel BRS or EBS licensees. For mobile digital stations, in the 1 megahertz bands immediately outside and adjacent to the frequency block a resolution bandwidth of at least two percent may be employed.

4.5.2 Test Setup

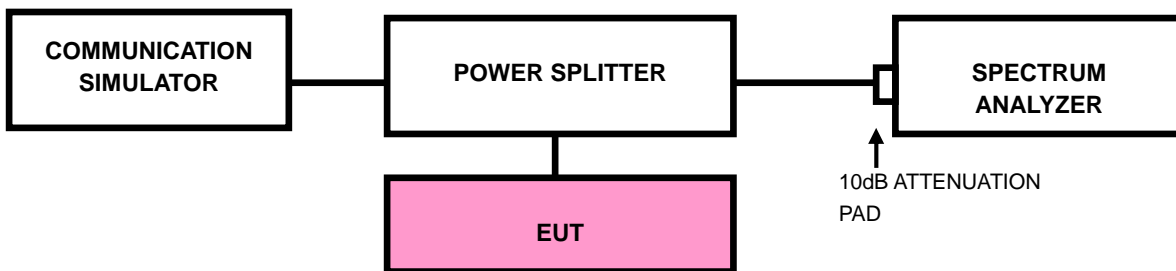

4.5.3 Test Procedures

- a. The EUT was set up for the maximum peak power with LTE link data modulation. The power was measured with R&S Spectrum Analyzer. All measurements were done at 2 channels (low and high operational frequency range.).
- b. The band edge measurement used the power splitter via EUT RF power connector between simulation base station and spectrum analyzer.
- c. The center frequency of spectrum is the band edge frequency and span is 35MHz. RBW of the spectrum is 100kHz and VBW of the spectrum is 300kHz (Channel bandwidth 5MHz).
- d. The center frequency of spectrum is the band edge frequency and span is 50MHz. RBW of the spectrum is 200kHz and VBW of the spectrum is 1MHz (Channel bandwidth 10MHz).
- e. The center frequency of spectrum is the band edge frequency and span is 60MHz. RBW of the spectrum is 300kHz and VBW of the spectrum is 1MHz (Channel bandwidth 15MHz).
- f. The center frequency of spectrum is the band edge frequency and span is 80MHz. RBW of the spectrum is 500kHz and VBW of the spectrum is 2MHz (Channel bandwidth 20MHz).
- g. Record the max trace plot into the test report.

4.5.4 Test Results

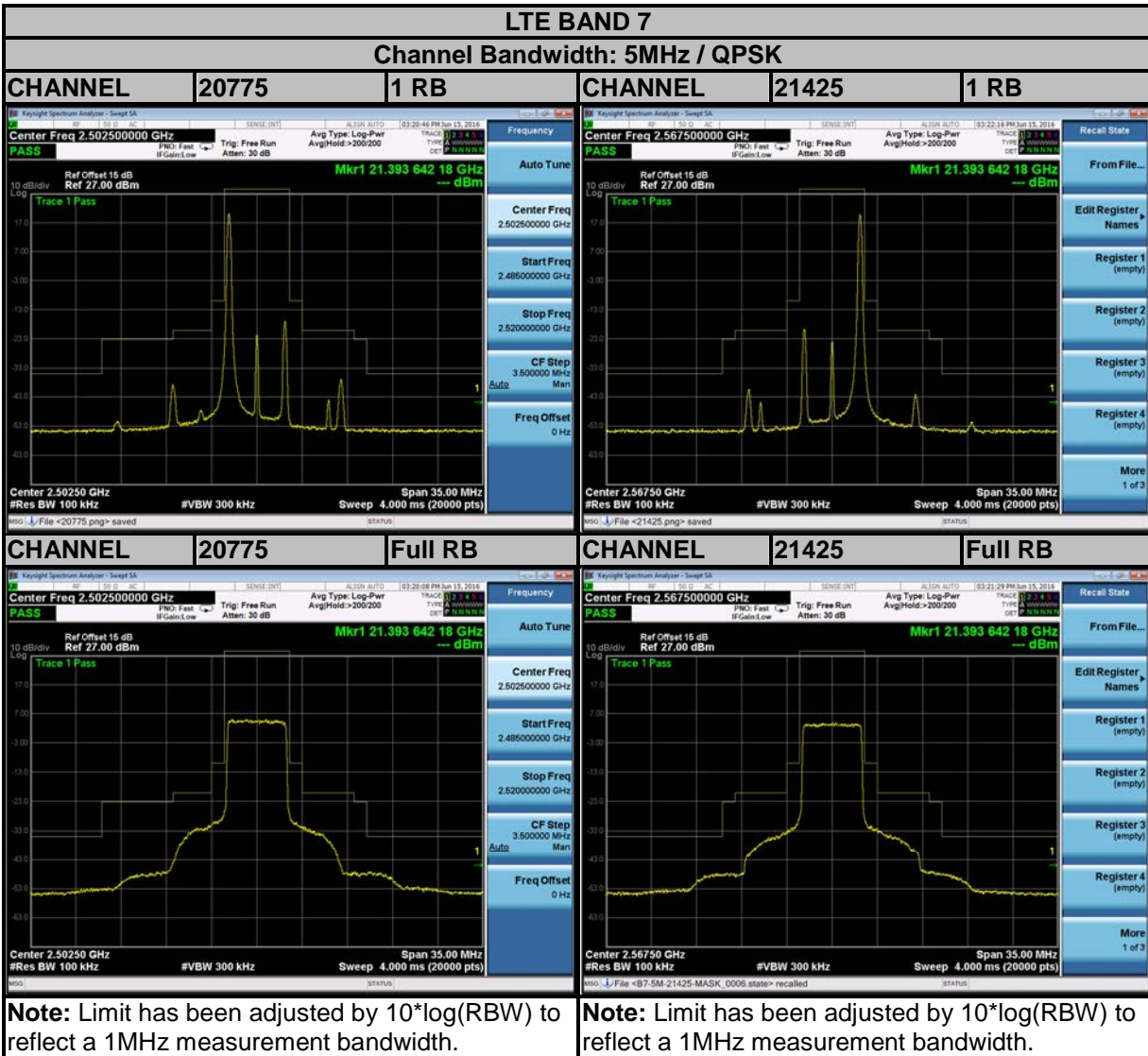

LTE BAND 7

Channel Bandwidth: 10MHz / QPSK

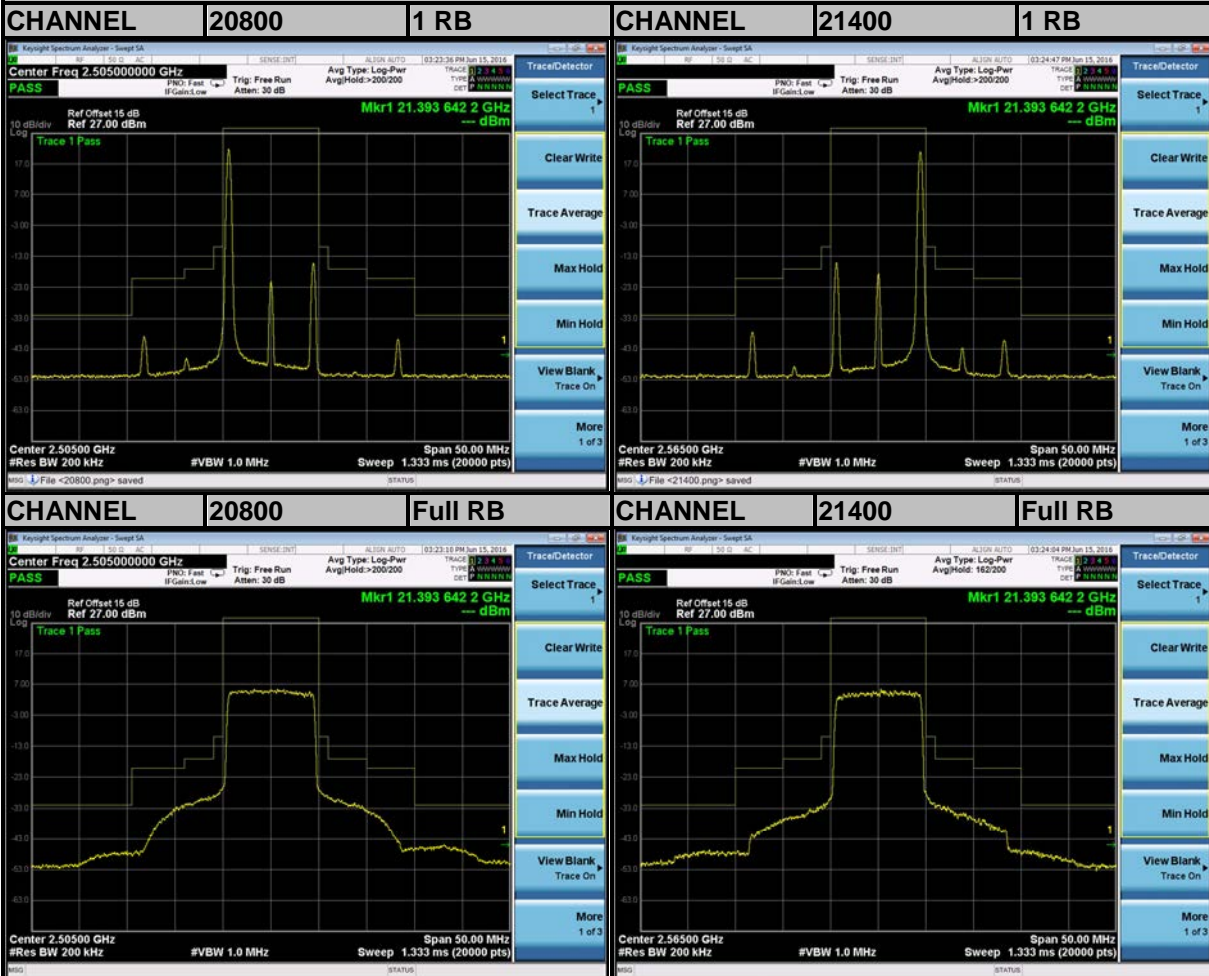

Note: Limit has been adjusted by $10 \cdot \log(\text{RBW})$ to reflect a 1MHz measurement bandwidth.

Note: Limit has been adjusted by $10 \cdot \log(\text{RBW})$ to reflect a 1MHz measurement bandwidth.

LTE BAND 7

Channel Bandwidth: 15MHz / QPSK

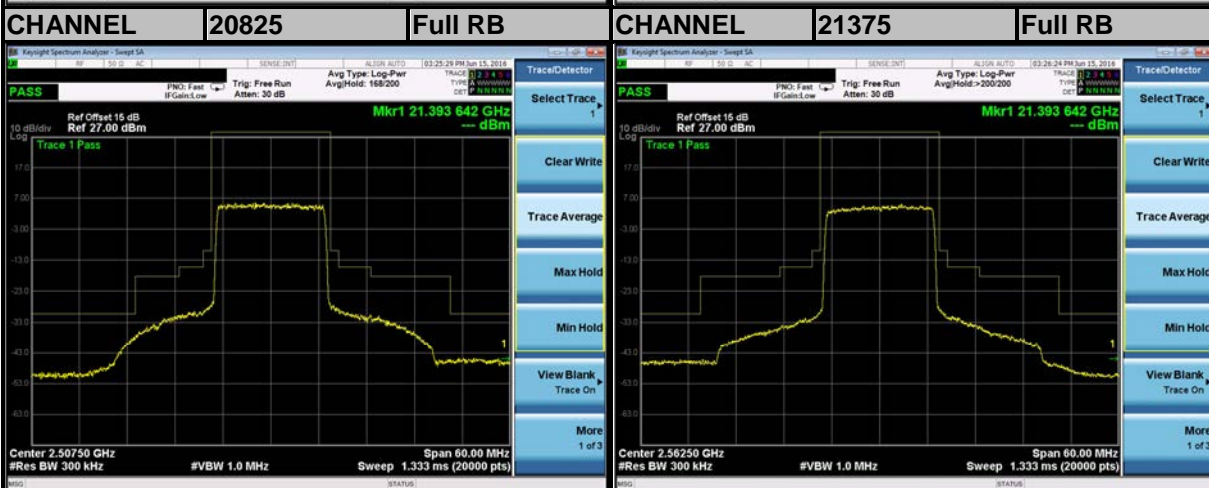
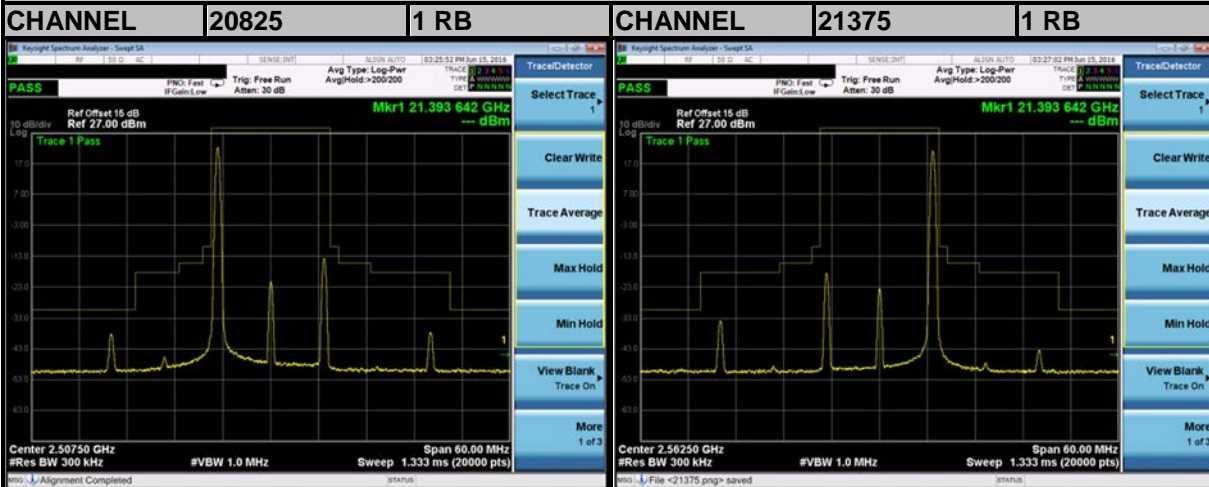

Note: Limit has been adjusted by $10 \cdot \log(\text{RBW})$ to reflect a 1MHz measurement bandwidth.

Note: Limit has been adjusted by $10 \cdot \log(\text{RBW})$ to reflect a 1MHz measurement bandwidth.

LTE BAND 7

Channel Bandwidth: 20MHz / QPSK

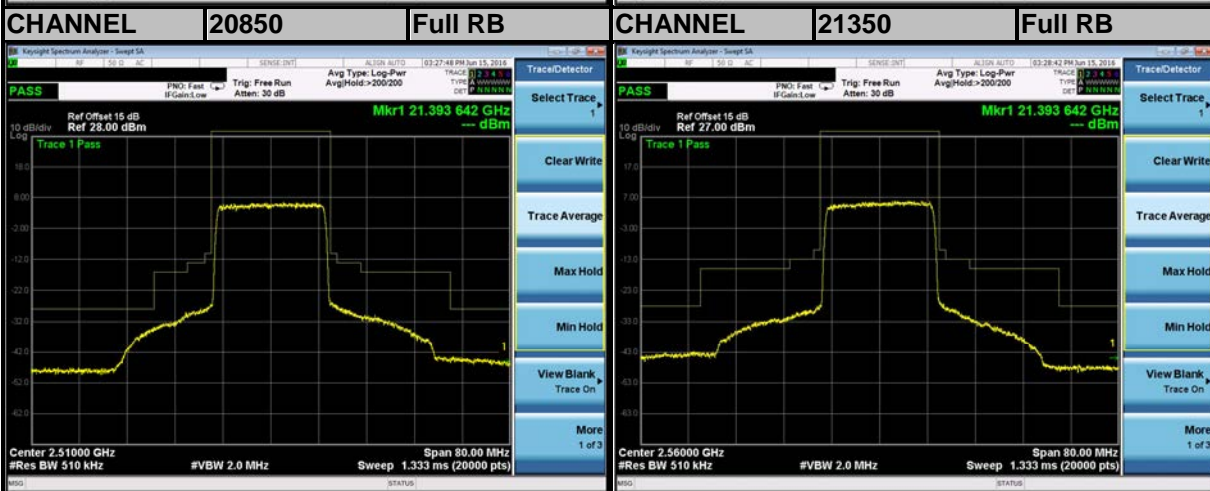
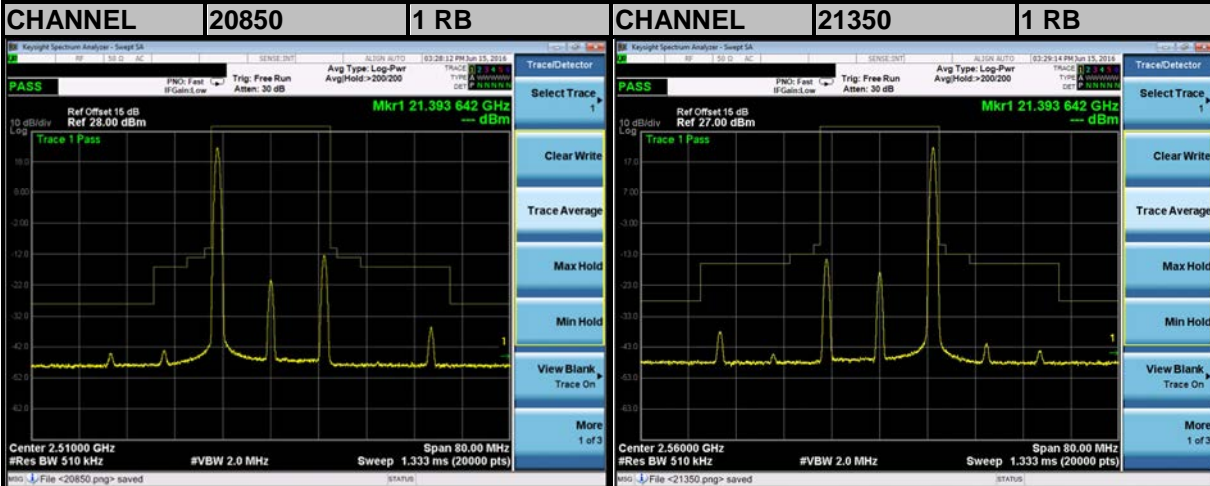

Note: Limit has been adjusted by $10 \cdot \log(\text{RBW})$ to reflect a 1MHz measurement bandwidth.

Note: Limit has been adjusted by $10 \cdot \log(\text{RBW})$ to reflect a 1MHz measurement bandwidth.

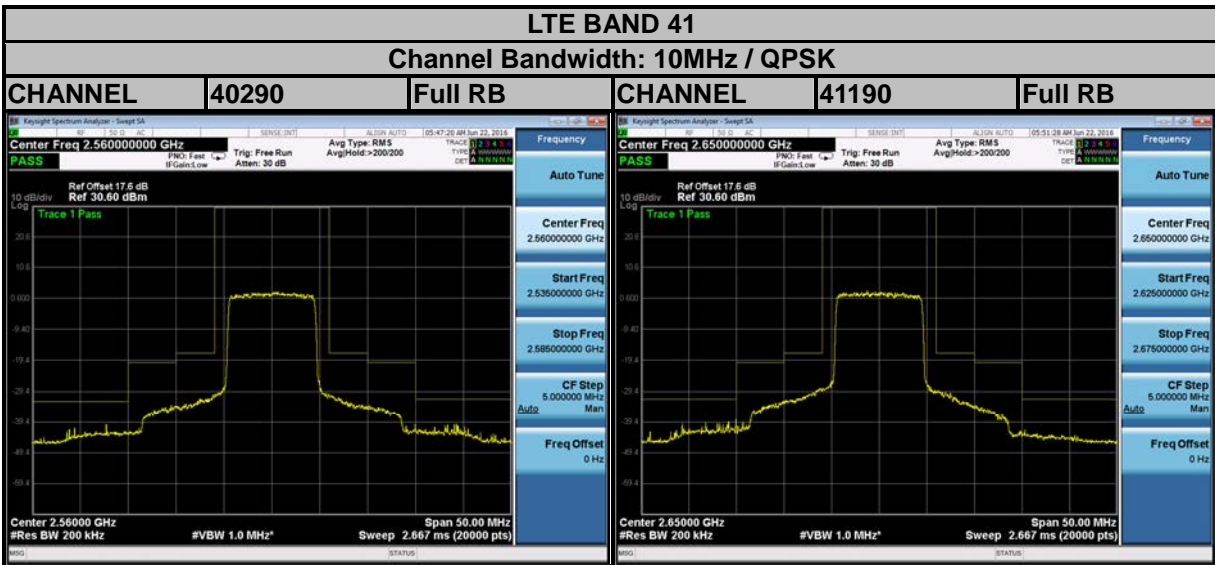
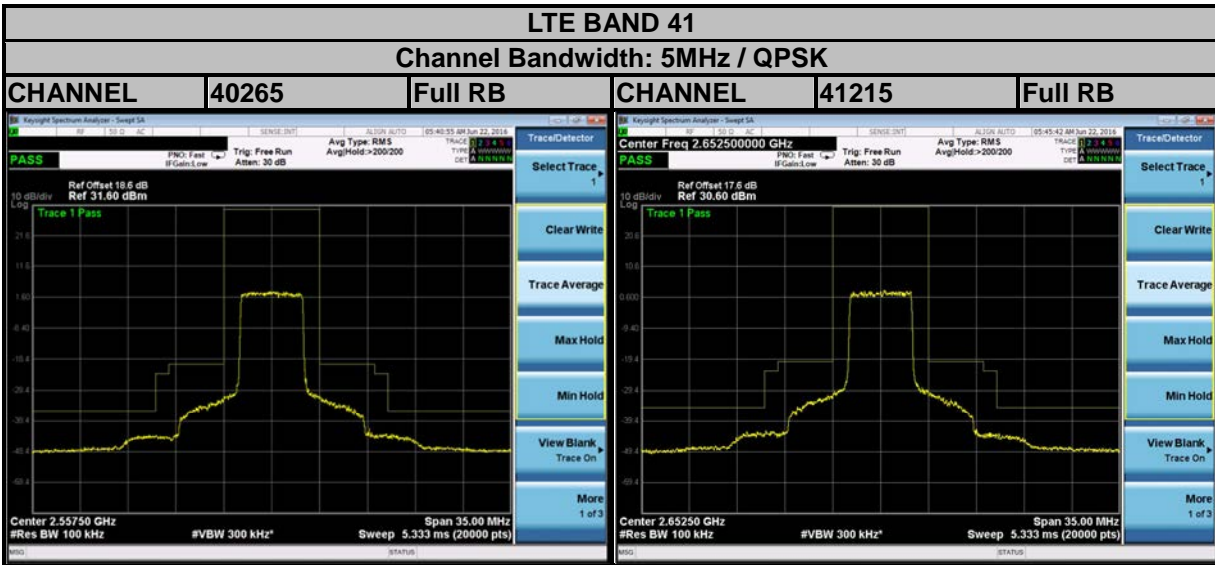

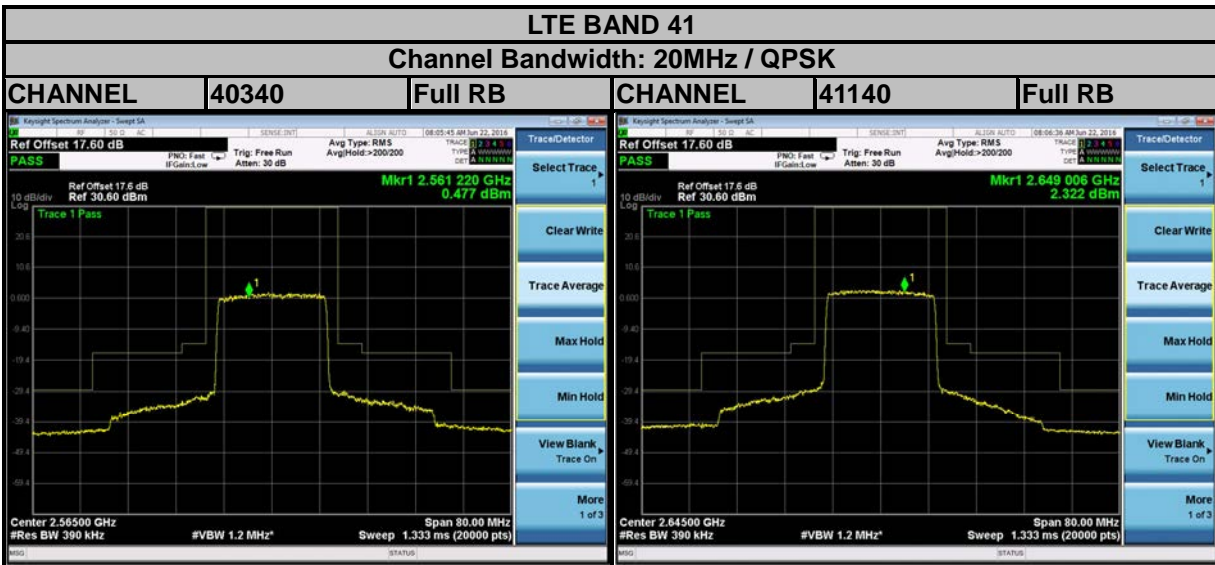
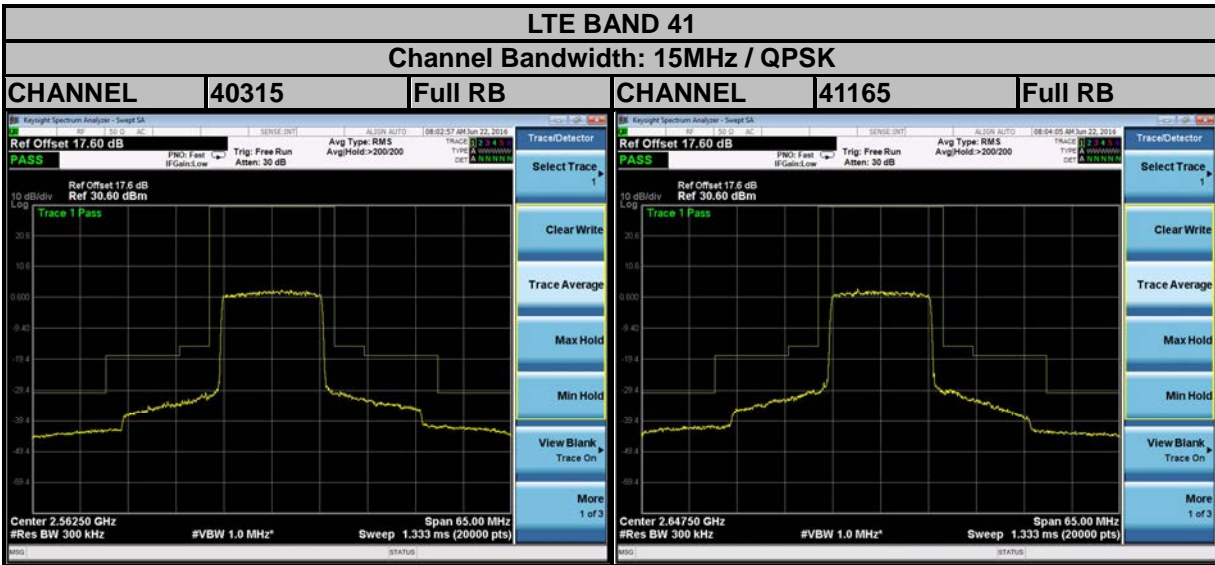

4.6 Conducted Spurious Emissions

4.6.1 Limits of Conducted Spurious Emissions Measurement

The power of any emission outside a licensee's frequency block shall be attenuated below the transmitter power (P) by at least $55 + 10 \log_{10}(P)$ dB. The limit of emission is equal to -25dBm.

4.6.2 Test Procedure

- a. The EUT makes a phone call to the communication simulator. All measurements were done at low, middle and high operational frequency range.
- b. Measuring frequency range is from 30MHz to 27GHz for LTE Band 7. 10dB attenuation pad is connected with spectrum. RBW=1MHz and VBW=3MHz are used for conducted emission measurement.

4.6.3 Test Setup

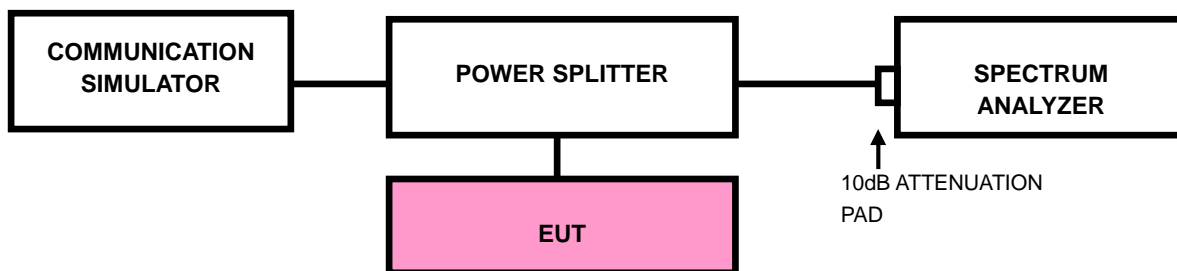

4.6.4 Test Results

LTE BAND 7

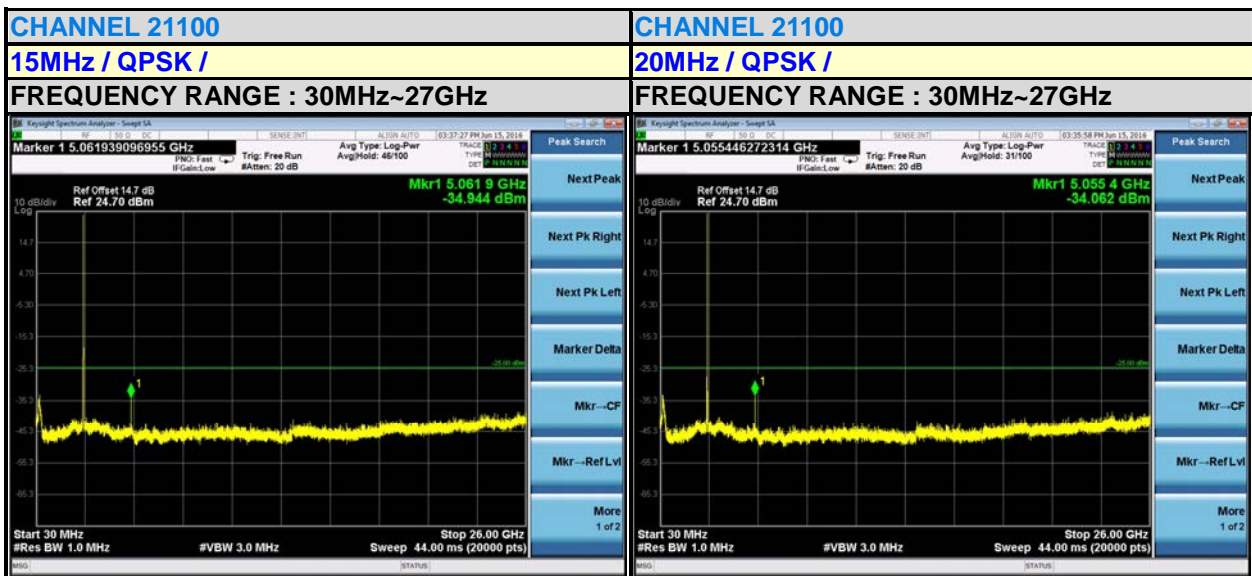
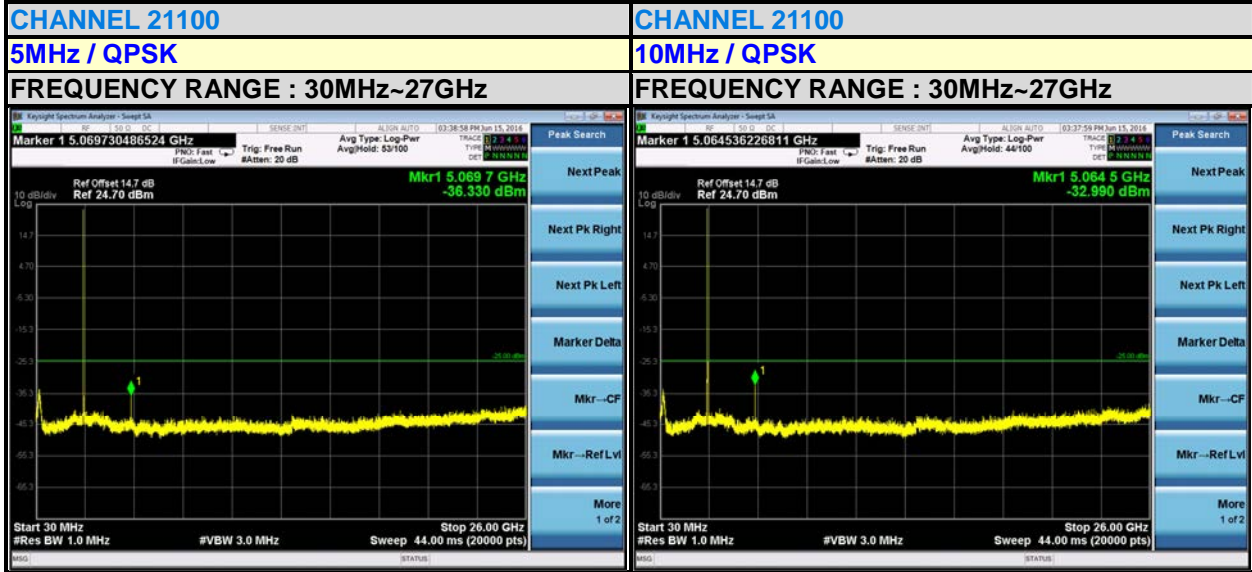

LTE BAND 41

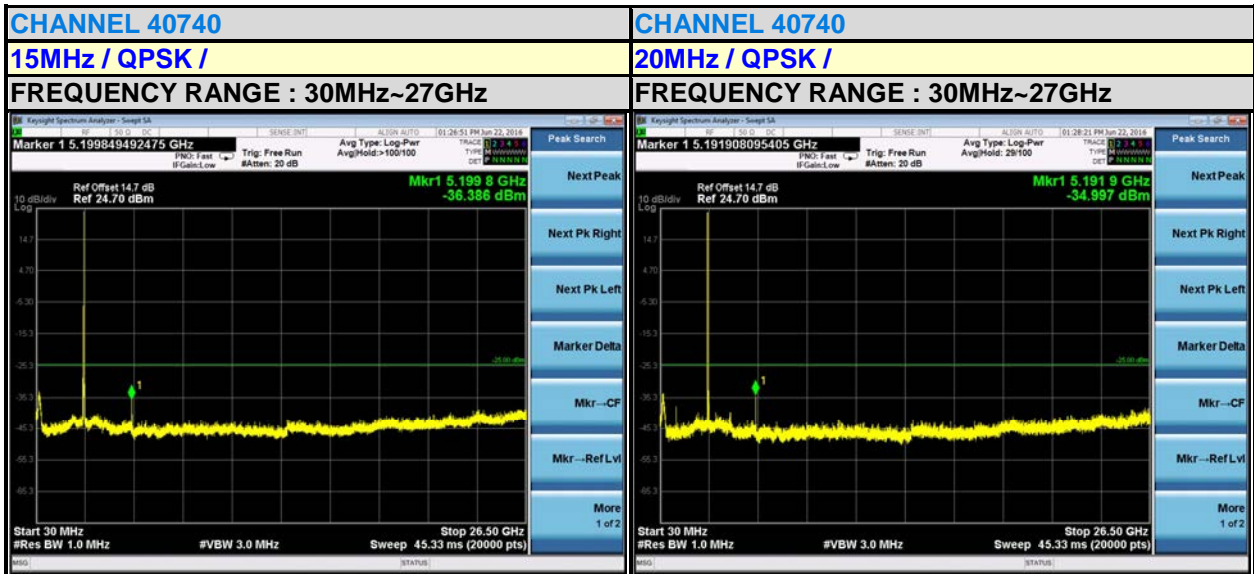
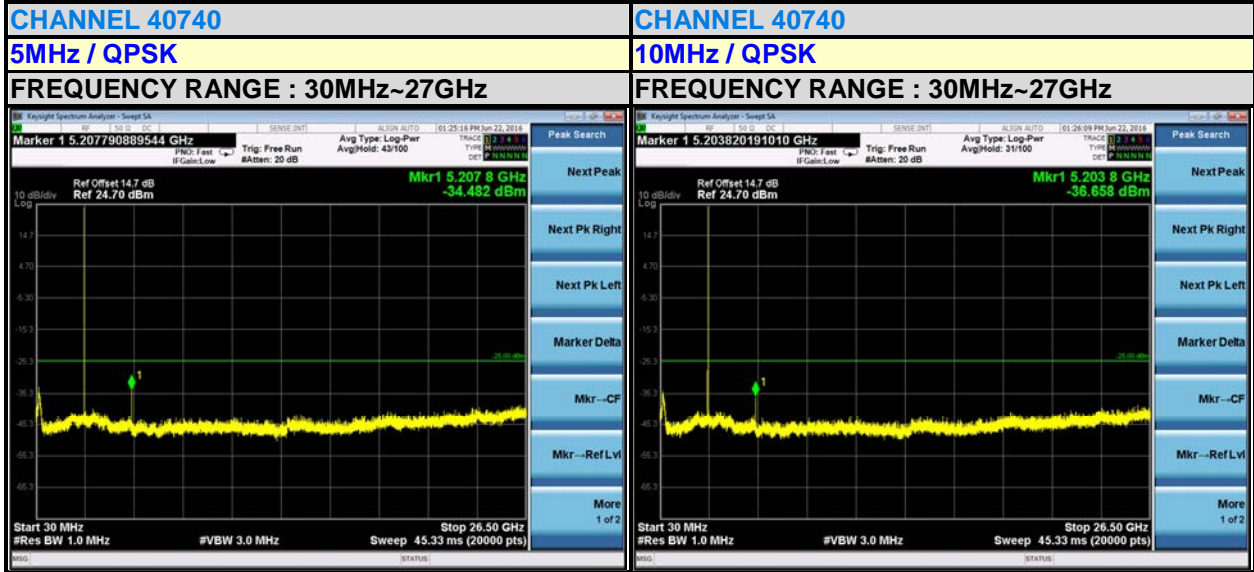

4.7 Radiated Emission Measurement

4.7.1 Limits of Radiated Emission Measurement

In the FCC 27.53(m) (4), On any frequency outside a licensee's frequency block, The power of any emission shall be attenuated below the transmitter power (P) by at least $55 + 10 \log (P)$ dB. The emission limit equal to -25dBm .

4.7.2 Test Procedure

- a. Substitution method is used for E.I.R.P measurement. In the semi-anechoic chamber, EUT placed on the 0.8m height of Turn Table, rotated the table around 360 degrees to search the maximum radiation power and receiver antenna shall be rotated vertical and horizontal polarization and moved height from 1m to 4m to find the maximum polar radiated power. The "Read Value" is the spectrum reading the maximum power value.
- b. The substitution horn antenna is substituted for EUT at the same position and signals generator export the CW signal to the substitution antenna via a TX cable. Rotated the Turn Table and moved receiving antenna to find the maximum radiation power. Adjust output power level of S.G to get a Value of spectrum reading equal to "Read Value " of step a. Record the power level of S.G.
- c. $\text{EIRP} = \text{Output power level of S.G} - \text{TX cable loss} + \text{Antenna gain of substitution horn}$.
- d. E.R.P power can be calculated form E.I.R.P power by subtracting the gain of dipole, $\text{E.R.P power} = \text{E.I.P.R power} - 2.15\text{dBi}$.

NOTE: The resolution bandwidth of spectrum analyzer is 1 MHz and the video bandwidth is 3 MHz.

4.7.3 Deviation from Test Standard

No deviation.

4.7.4 Test Setup

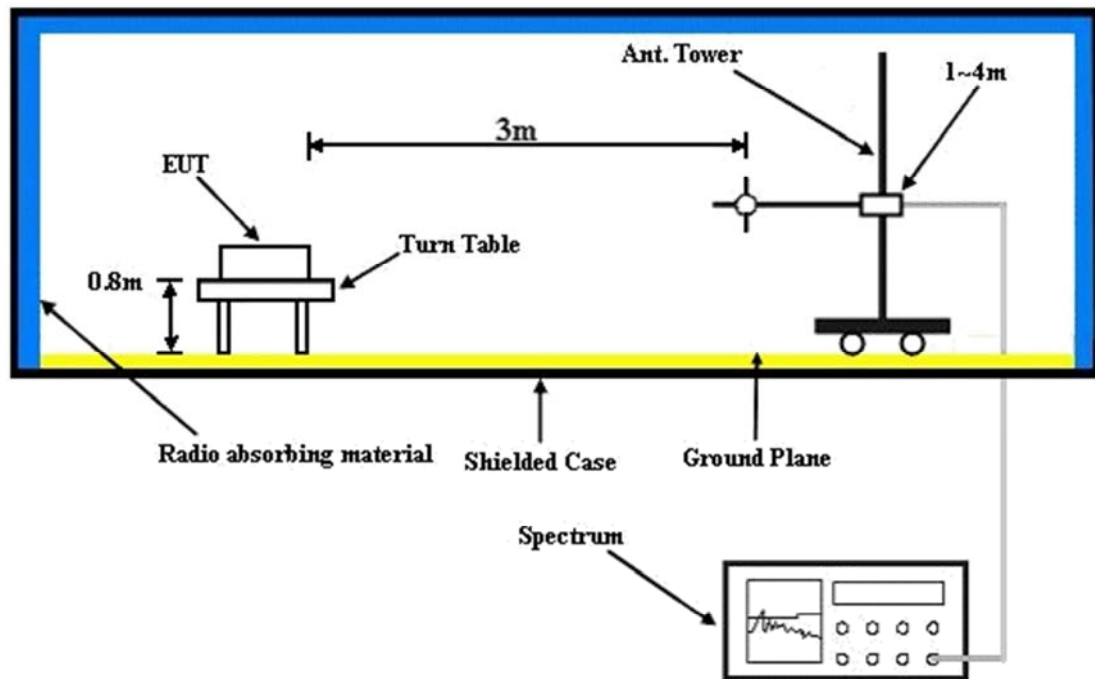

For the actual test configuration, please refer to the attached file (Test Setup Photo).

4.7.5 Test Results

BELOW 1GHz WORST-CASE DATA

LTE Band 7:

MODE	TX channel21100	FREQUENCY RANGE	Below 1000MHz
ENVIRONMENTAL CONDITIONS	26deg. C, 56%RH	INPUT POWER	DC 5V from adapter
TESTED BY	Alex Chen		
ANTENNA POLARITY & TEST DISTANCE: HORIZONTAL AT 3 M			

	Freq	Level	Read Level	Limit Line	Over Limit	Factor	Remark	Pol/Phase
	MHz	dBm/m	dBm	dBm/m	dB	dB/m		
1 PP	43.580	-32.05	-40.99	-25.00	-7.05	8.94	Peak	Horizontal
2	82.380	-54.55	-46.58	-25.00	-29.55	-7.97	Peak	Horizontal
3	187.140	-63.34	-45.77	-25.00	-38.34	-17.57	Peak	Horizontal
4	371.440	-76.92	-65.50	-25.00	-51.92	-11.42	Peak	Horizontal
5	604.240	-74.40	-65.85	-25.00	-49.40	-8.55	Peak	Horizontal
6	774.960	-69.88	-65.53	-25.00	-44.88	-4.35	Peak	Horizontal

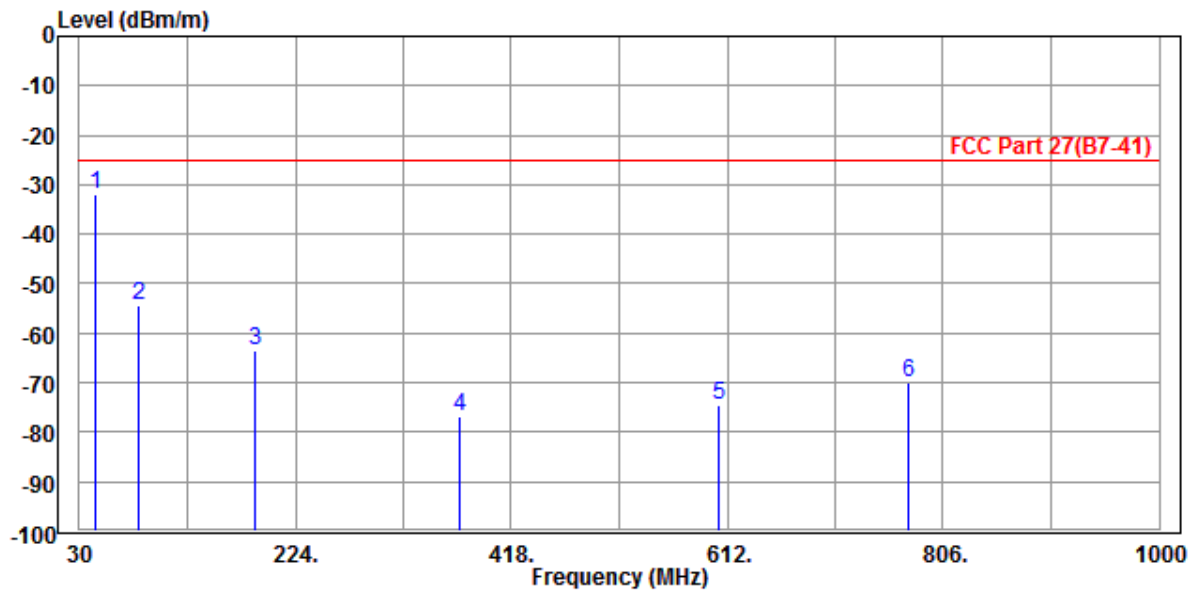



A D T

MODE	TX channel21100	FREQUENCY RANGE	Below 1000MHz
ENVIRONMENTAL CONDITIONS	26deg. C, 56%RH	INPUT POWER	DC 5V from adapter
TESTED BY	Alex Chen		
ANTENNA POLARITY & TEST DISTANCE: VERTICAL AT 3 M			

	Freq	Level	Read Level	Limit Line	Over Limit	Factor	Remark	Pol/Phase	
	MHz	dBm/m	dBm	dBm/m	dB	dB/m			
1	PP	43.580	-29.63	-26.99	-25.00	-4.63	-2.64	Peak	Vertical
2		85.290	-50.16	-39.76	-25.00	-25.16	-10.40	Peak	Vertical
3		201.690	-62.59	-51.93	-25.00	-37.59	-10.66	Peak	Vertical
4		246.310	-69.01	-57.55	-25.00	-44.01	-11.46	Peak	Vertical
5		358.830	-72.37	-61.29	-25.00	-47.37	-11.08	Peak	Vertical
6		605.210	-72.39	-65.11	-25.00	-47.39	-7.28	Peak	Vertical

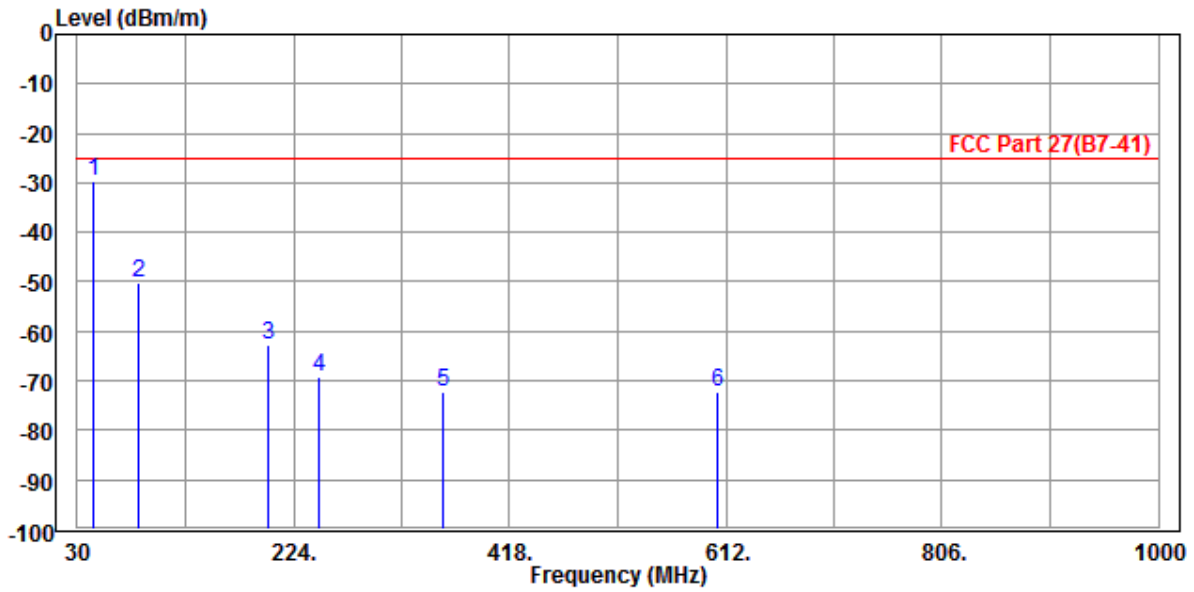



ABOVE 1GHz

LTE Band 7

CHANNEL BANDWIDTH: 5MHz / QPSK

MODE	TX channel21100	FREQUENCY RANGE	Above 1000MHz
ENVIRONMENTAL CONDITIONS	26deg. C, 56%RH	INPUT POWER	DC 5V from adapter
TESTED BY	Alex Chen		
ANTENNA POLARITY & TEST DISTANCE: HORIZONTAL AT 3 M			

	Freq	Level	Read Level	Limit Line	Over Limit	Factor	Remark	Pol/Phase
	MHz	dBm/m	dBm	dBm/m	dB	dB/m		
1	5070.000	-47.46	-55.92	-25.00	-22.46	8.46	Peak	Horizontal
2 PP	7605.000	-44.68	-58.16	-25.00	-19.68	13.48	Peak	Horizontal

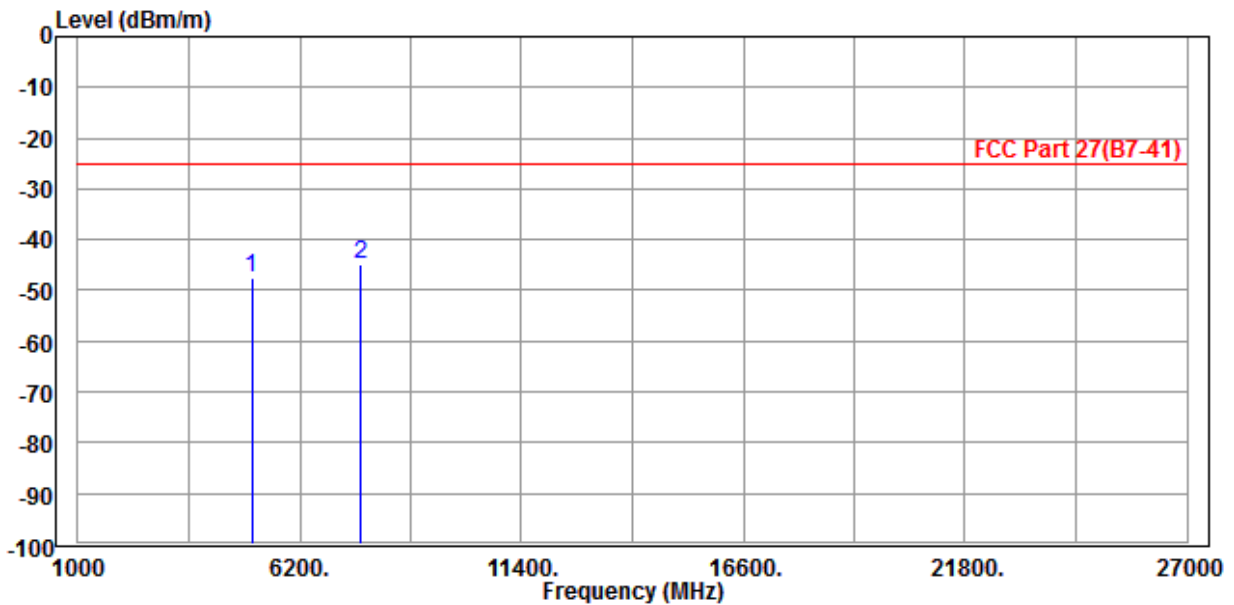

MODE	TX channel21100	FREQUENCY RANGE	Above 1000MHz
ENVIRONMENTAL CONDITIONS	26deg. C, 56%RH	INPUT POWER	DC 5V from adapter
TESTED BY	Alex Chen		
ANTENNA POLARITY & TEST DISTANCE: VERTICAL AT 3 M			

	Freq	Level	Read Level	Limit Line	Over Limit	Factor	Remark	Pol/Phase
	MHz	dBm/m	dBm	dBm/m	dB	dB/m		
1	5070.000	-47.52	-55.51	-25.00	-22.52	7.99	Peak	Vertical
2 PP	7605.000	-44.39	-57.38	-25.00	-19.39	12.99	Peak	Vertical

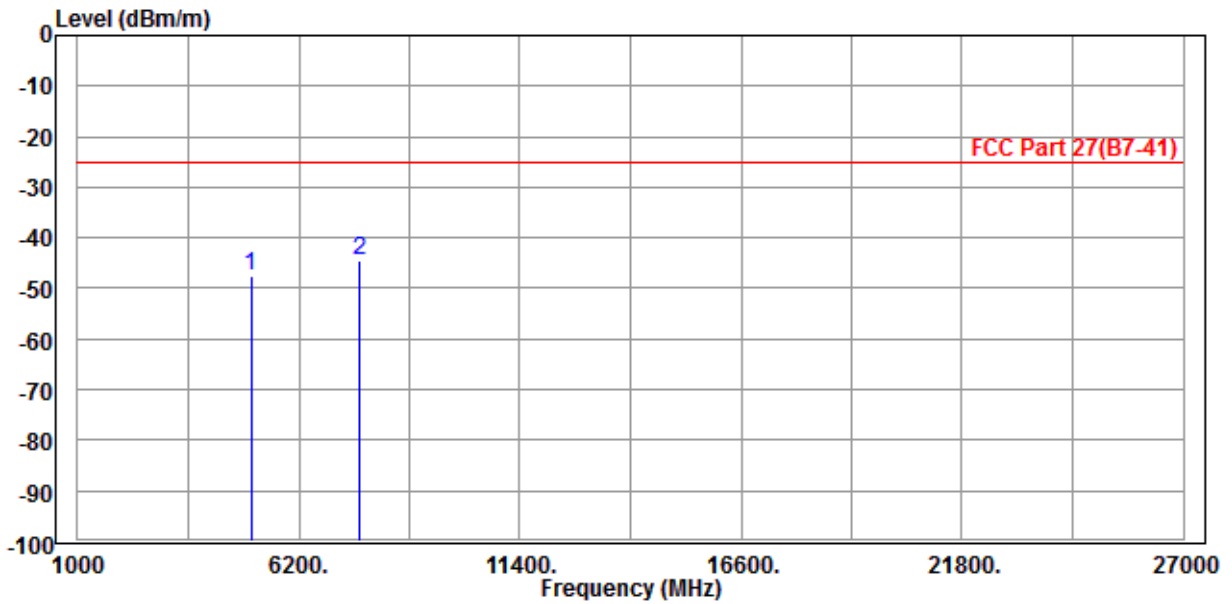

CHANNEL BANDWIDTH: 10MHz / QPSK

MODE	TX channel21100	FREQUENCY RANGE	Above 1000MHz
ENVIRONMENTAL CONDITIONS	26deg. C, 56%RH	INPUT POWER	DC 5V from adapter
TESTED BY	Alex Chen		
ANTENNA POLARITY & TEST DISTANCE: HORIZONTAL AT 3 M			

	Freq	Level	Read Level	Limit Line	Over Limit	Factor	Remark	Pol/Phase
	MHz	dBm/m	dBm	dBm/m	dB	dB/m		
1	5070.000	-47.46	-55.92	-25.00	-22.46	8.46	Peak	Horizontal
2	PP 7605.000	-44.02	-57.50	-25.00	-19.02	13.48	Peak	Horizontal

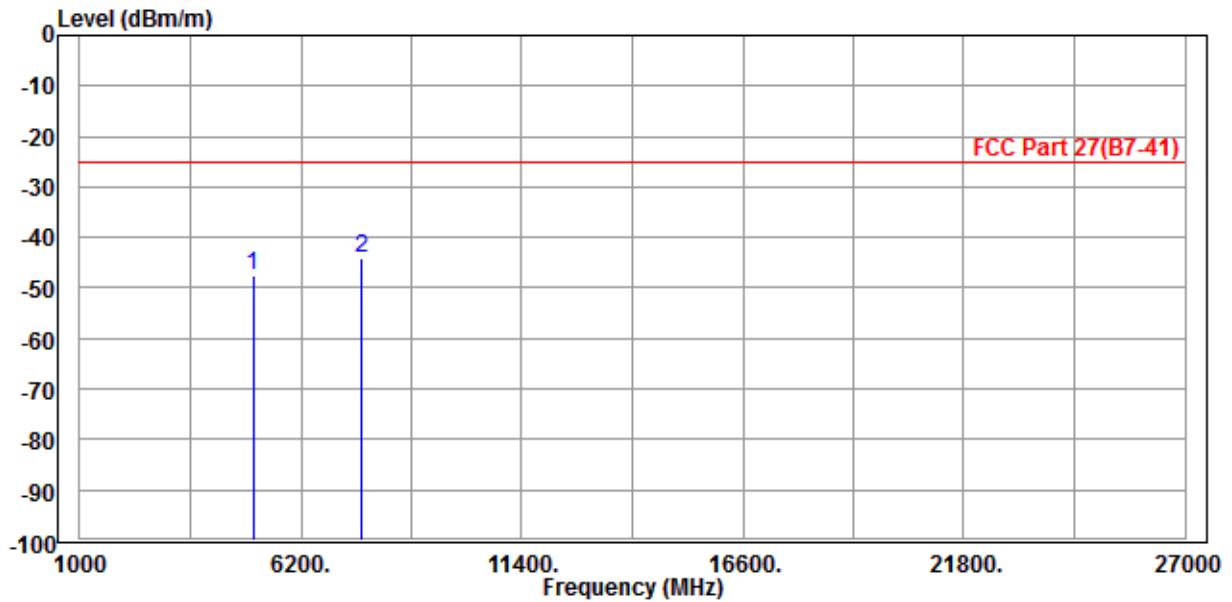



MODE	TX channel21100	FREQUENCY RANGE	Above 1000MHz
ENVIRONMENTAL CONDITIONS	26deg. C, 56%RH	INPUT POWER	DC 5V from adapter
TESTED BY	Alex Chen		
ANTENNA POLARITY & TEST DISTANCE: VERTICAL AT 3 M			

	Freq	Level	Read Level	Limit Line	Over Limit	Factor	Remark	Pol/Phase
	MHz	dBm/m	dBm	dBm/m	dB	dB/m		
1	5070.000	-48.02	-56.48	-25.00	-23.02	8.46	Peak	Horizontal
2 PP	7605.000	-44.39	-57.87	-25.00	-19.39	13.48	Peak	Horizontal

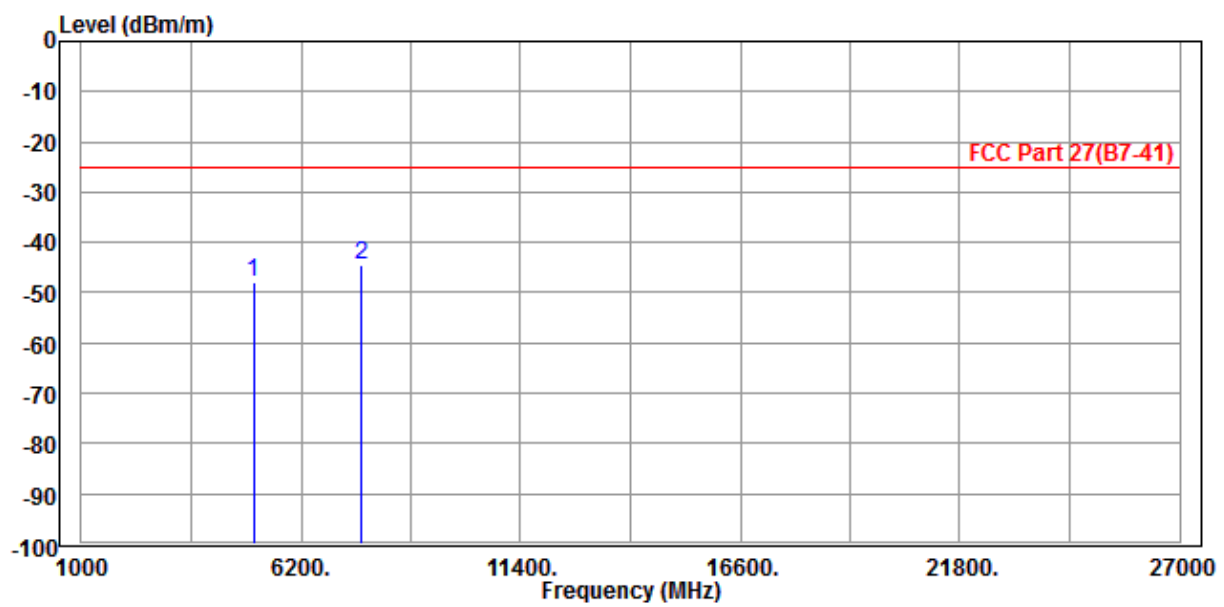

CHANNEL BANDWIDTH: 15MHz / QPSK

MODE	TX channel21100	FREQUENCY RANGE	Above 1000MHz
ENVIRONMENTAL CONDITIONS	26deg. C, 56%RH	INPUT POWER	DC 5V from adapter
TESTED BY	Alex Chen		
ANTENNA POLARITY & TEST DISTANCE: HORIZONTAL AT 3 M			

	Freq	Level	Read Level	Limit Line	Over Limit	Factor	Remark	Pol/Phase
	MHz	dBm/m	dBm	dBm/m	dB	dB/m		
1	5070.000	-47.45	-55.91	-25.00	-22.45	8.46	Peak	Horizontal
2 PP	7605.000	-44.90	-58.38	-25.00	-19.90	13.48	Peak	Horizontal

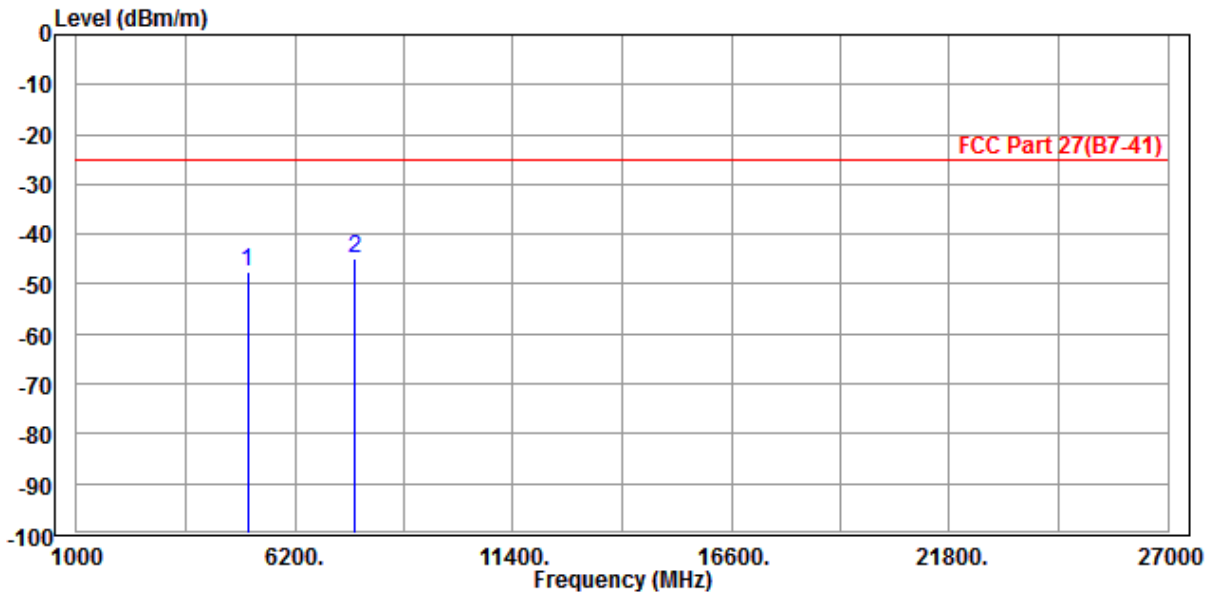



MODE	TX channel21100	FREQUENCY RANGE	Above 1000MHz
ENVIRONMENTAL CONDITIONS	26deg. C, 56%RH	INPUT POWER	DC 5V from adapter
TESTED BY	Alex Chen		
ANTENNA POLARITY & TEST DISTANCE: VERTICAL AT 3 M			

	Freq	Level	Read Level	Limit Line	Over Limit	Factor	Remark	Pol/Phase
	MHz	dBm/m	dBm	dBm/m	dB	dB/m		
1	5070.000	-47.65	-55.64	-25.00	-22.65	7.99	Peak	Vertical
2 PP	7605.000	-44.20	-57.19	-25.00	-19.20	12.99	Peak	Vertical

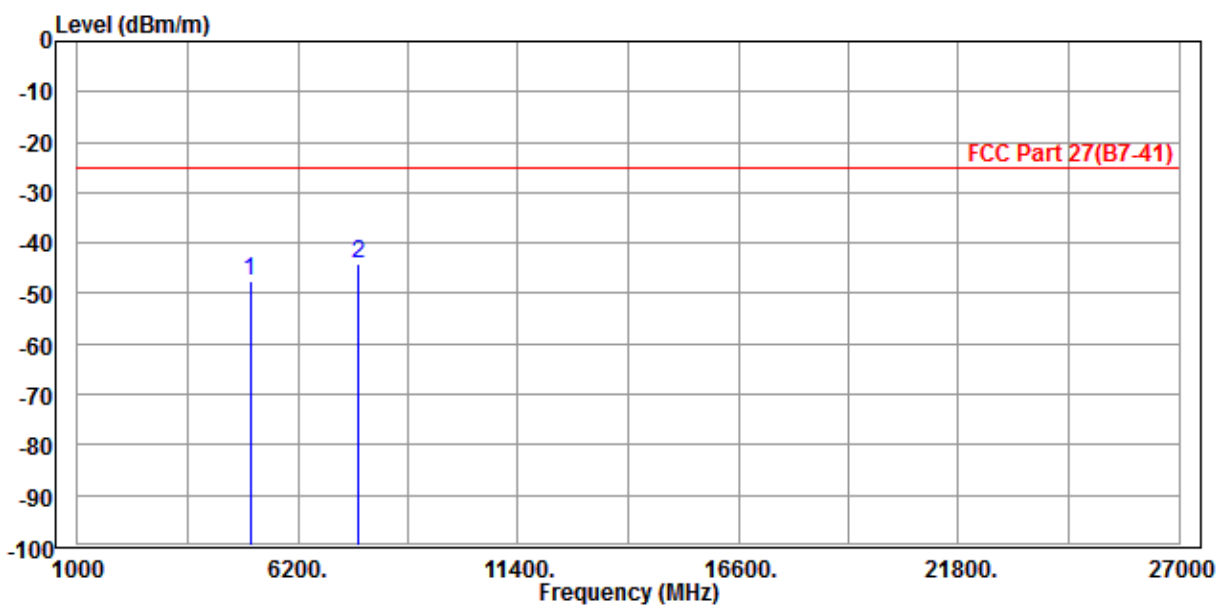

CHANNEL BANDWIDTH: 20MHz / QPSK

MODE	TX channel21100	FREQUENCY RANGE	Above 1000MHz
ENVIRONMENTAL CONDITIONS	26deg. C, 56%RH	INPUT POWER	DC 5V from adapter
TESTED BY	Alex Chen		
ANTENNA POLARITY & TEST DISTANCE: HORIZONTAL AT 3 M			

	Freq	Level	Read Level	Limit Line	Over Limit	Factor	Remark	Pol/Phase
	MHz	dBm/m	dBm	dBm/m	dB	dB/m		
1	5070.000	-47.59	-56.05	-25.00	-22.59	8.46	Peak	Horizontal
2 PP	7605.000	-44.55	-58.03	-25.00	-19.55	13.48	Peak	Horizontal

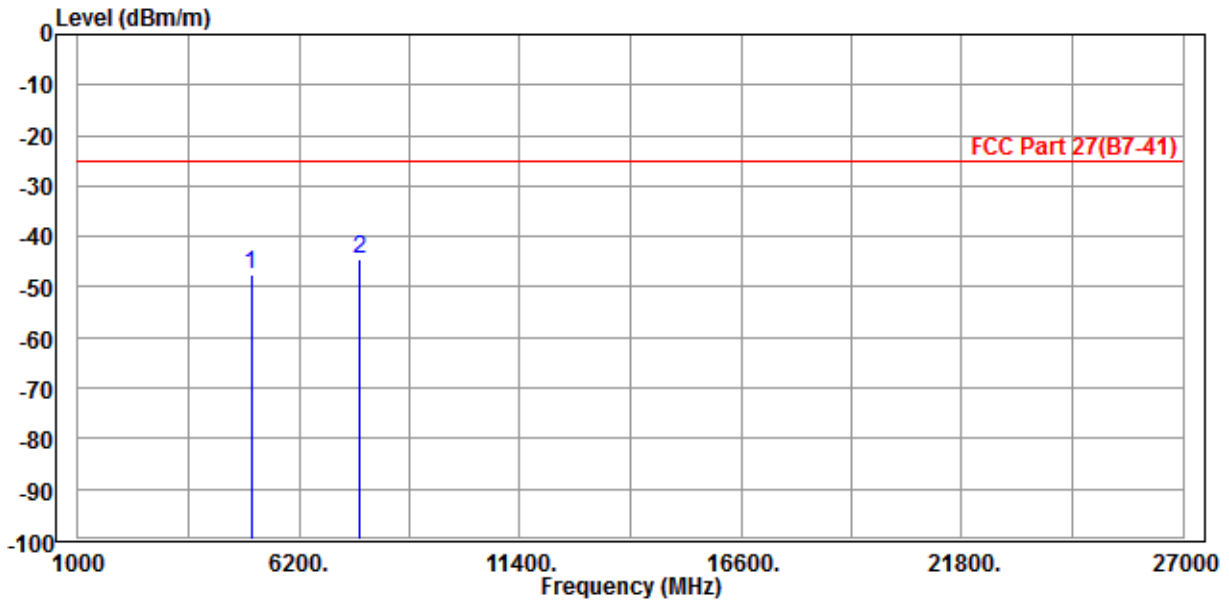

MODE	TX channel21100	FREQUENCY RANGE	Above 1000MHz
ENVIRONMENTAL CONDITIONS	26deg. C, 56%RH	INPUT POWER	DC 5V from adapter
TESTED BY	Alex Chen		
ANTENNA POLARITY & TEST DISTANCE: VERTICAL AT 3 M			

	Freq	Level	Read Level	Limit Line	Over Limit	Factor	Remark	Pol/Phase
	MHz	dBm/m	dBm	dBm/m	dB	dB/m		
1	5070.000	-48.20	-56.19	-25.00	-23.20	7.99	Peak	Vertical
2 PP	7605.000	-43.72	-56.71	-25.00	-18.72	12.99	Peak	Vertical

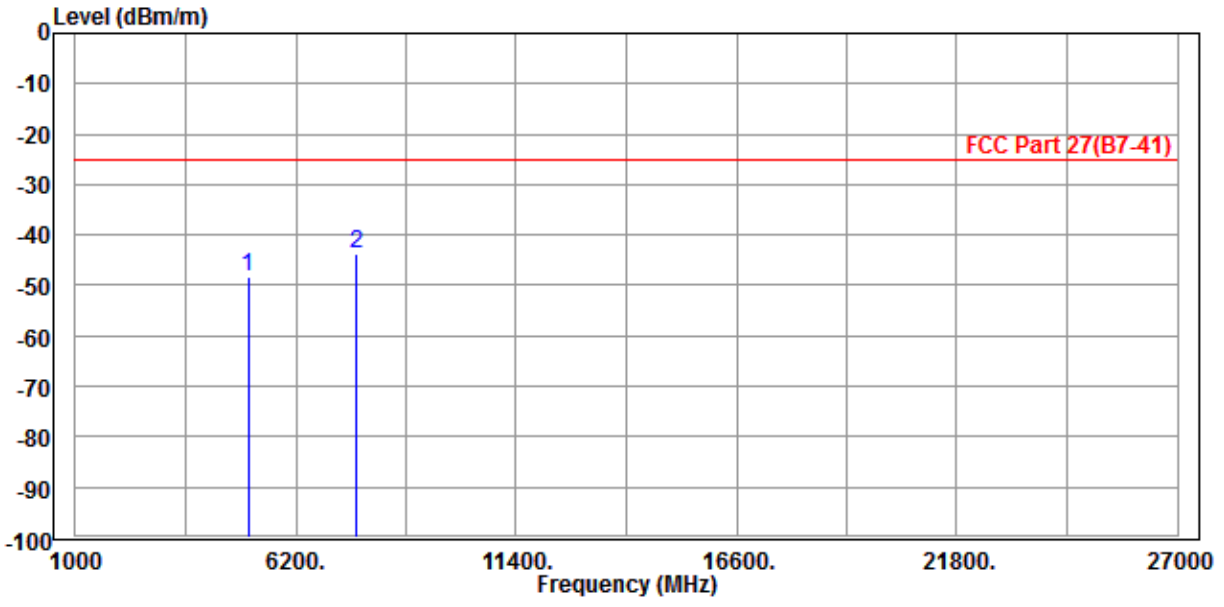



LTE Band 41

CHANNEL BANDWIDTH: 5MHz / QPSK

MODE	TX channel40740	FREQUENCY RANGE	Above 1000MHz
ENVIRONMENTAL CONDITIONS	26deg. C, 56%RH	INPUT POWER	DC 5V from adapter
TESTED BY	Alex Chen		
ANTENNA POLARITY & TEST DISTANCE: HORIZONTAL AT 3 M			

	Freq	Level	Read Level	Limit Line	Over Limit	Factor	Remark	Pol/Phase
	MHz	dBm/m	dBm	dBm/m	dB	dB/m		
1	5210.000	-47.89	-56.51	-25.00	-22.89	8.62	Peak	Horizontal
2 PP	7815.000	-44.11	-57.89	-25.00	-19.11	13.78	Peak	Horizontal

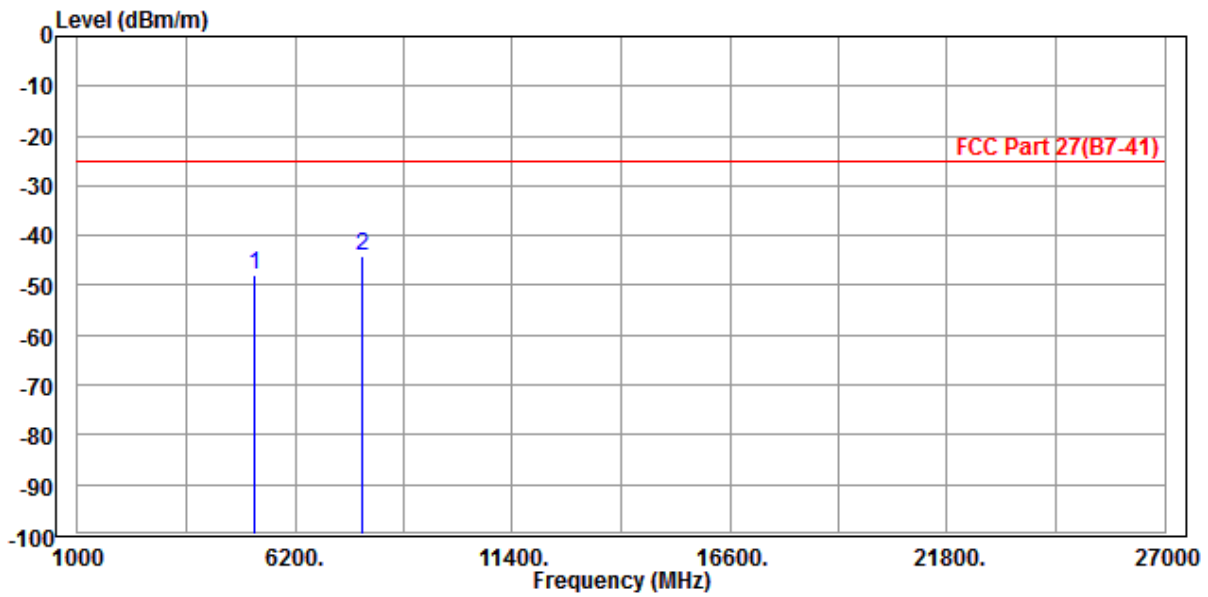

MODE	TX channel40740	FREQUENCY RANGE	Above 1000MHz
ENVIRONMENTAL CONDITIONS	26deg. C, 56%RH	INPUT POWER	DC 5V from adapter
TESTED BY	Alex Chen		
ANTENNA POLARITY & TEST DISTANCE: VERTICAL AT 3 M			

	Freq	Level	Read Level	Limit Line	Over Limit	Factor	Remark	Pol/Phase
	MHz	dBm/m	dBm	dBm/m	dB	dB/m		
1	5210.000	-47.39	-55.37	-25.00	-22.39	7.98	Peak	Vertical
2 PP	7815.000	-44.19	-57.55	-25.00	-19.19	13.36	Peak	Vertical

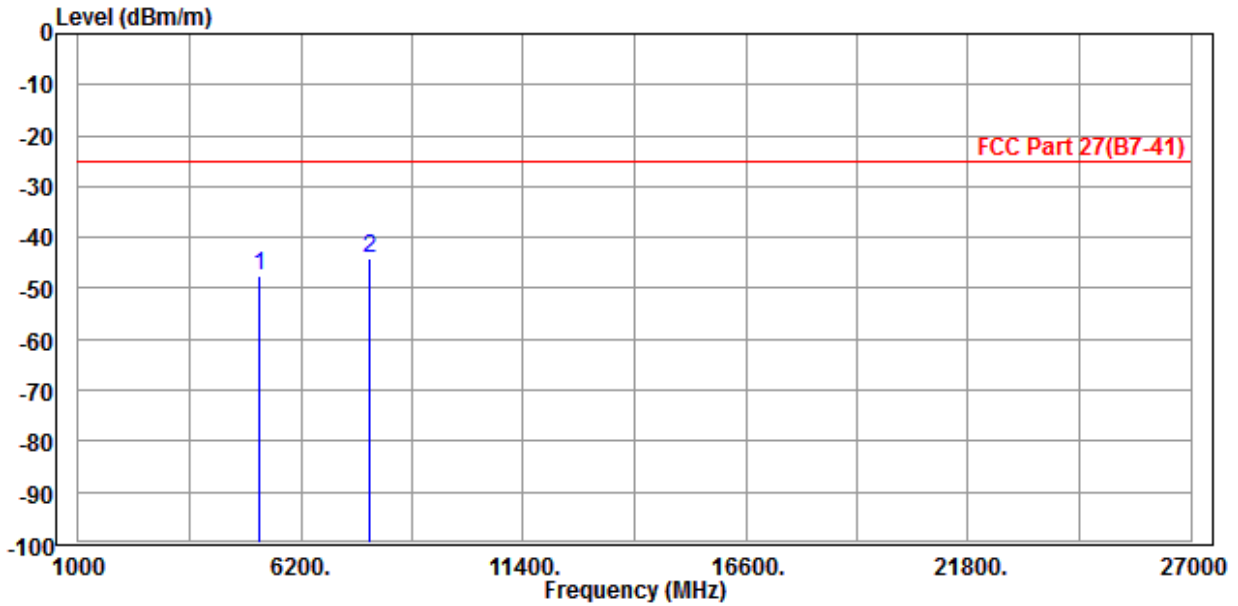

CHANNEL BANDWIDTH: 10MHz / QPSK

MODE	TX channel40740	FREQUENCY RANGE	Above 1000MHz
ENVIRONMENTAL CONDITIONS	26deg. C, 56%RH	INPUT POWER	DC 5V from adapter
TESTED BY	Alex Chen		
ANTENNA POLARITY & TEST DISTANCE: HORIZONTAL AT 3 M			

	Freq	Level	Read Level	Limit Line	Over Limit	Factor	Remark	Pol/Phase
	MHz	dBm/m	dBm	dBm/m	dB	dB/m		
1	5210.000	-47.56	-56.18	-25.00	-22.56	8.62	Peak	Horizontal
2	PP 7815.000	-42.78	-56.56	-25.00	-17.78	13.78	Peak	Horizontal

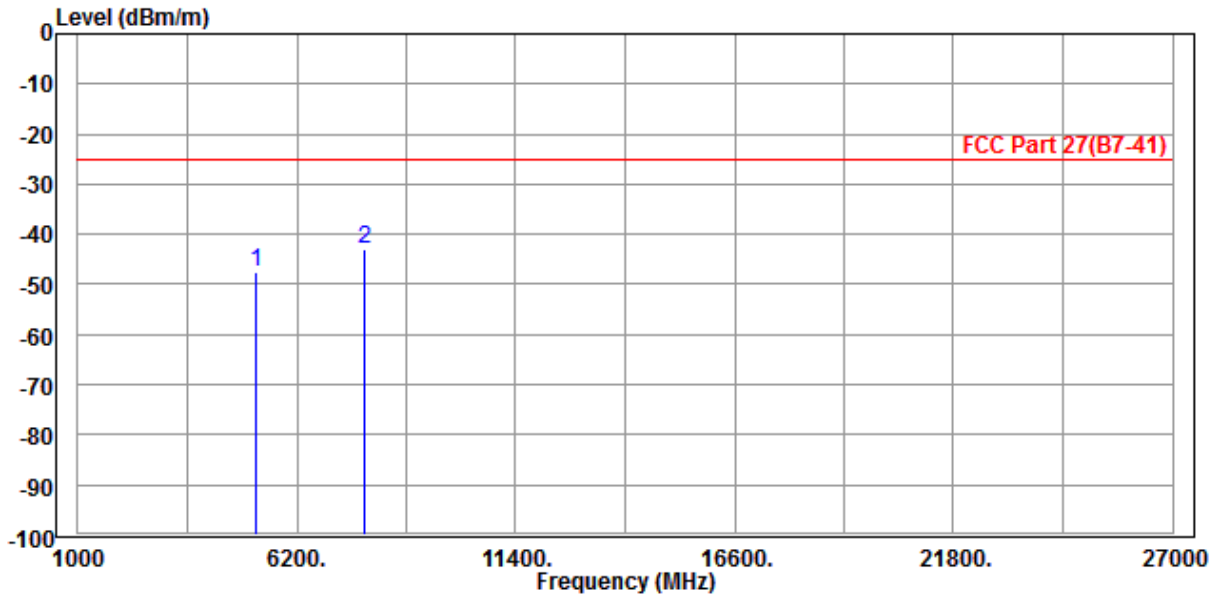

MODE	TX channel40740	FREQUENCY RANGE	Above 1000MHz
ENVIRONMENTAL CONDITIONS	26deg. C, 56%RH	INPUT POWER	DC 5V from adapter
TESTED BY	Alex Chen		
ANTENNA POLARITY & TEST DISTANCE: VERTICAL AT 3 M			

	Freq	Level	Read Level	Limit Line	Over Limit	Factor	Remark	Pol/Phase
	MHz	dBm/m	dBm	dBm/m	dB	dB/m		
1	5210.000	-47.78	-55.76	-25.00	-22.78	7.98	Peak	Vertical
2 PP	7815.000	-43.97	-57.33	-25.00	-18.97	13.36	Peak	Vertical

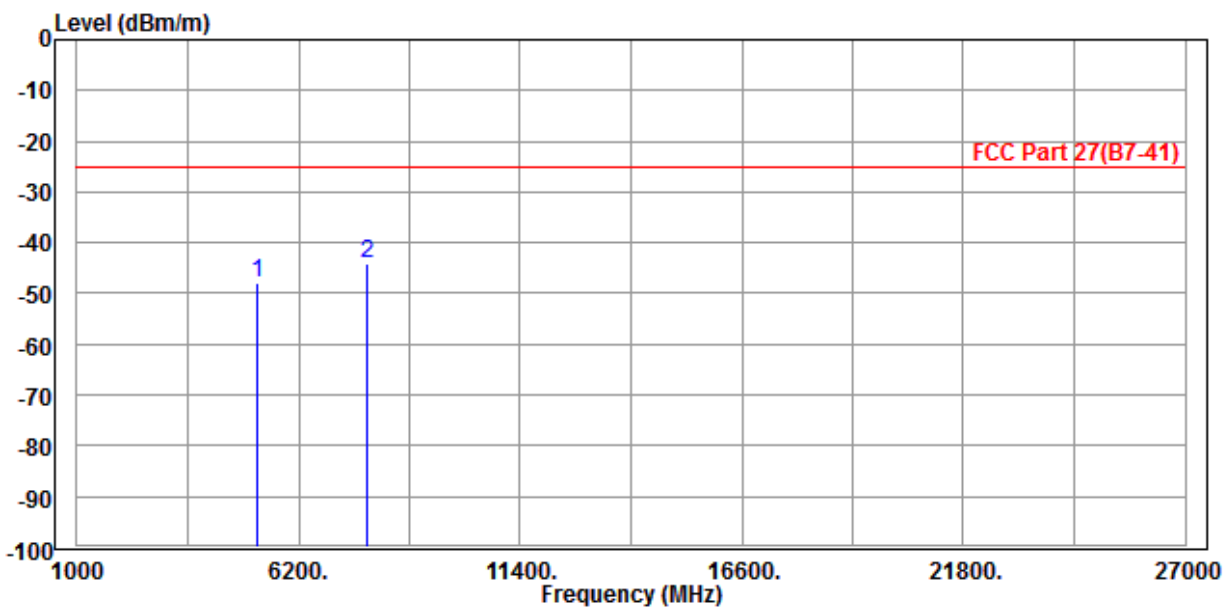



CHANNEL BANDWIDTH: 15MHz / QPSK

MODE	TX channel40740	FREQUENCY RANGE	Above 1000MHz
ENVIRONMENTAL CONDITIONS	26deg. C, 56%RH	INPUT POWER	DC 5V from adapter
TESTED BY	Alex Chen		
ANTENNA POLARITY & TEST DISTANCE: HORIZONTAL AT 3 M			

	Freq	Level	Read Level	Limit Line	Over Limit	Factor	Remark	Pol/Phase
	MHz	dBm/m	dBm	dBm/m	dB	dB/m		
1	5210.000	-47.58	-56.20	-25.00	-22.58	8.62	Peak	Horizontal
2 PP	7815.000	-44.45	-58.23	-25.00	-19.45	13.78	Peak	Horizontal

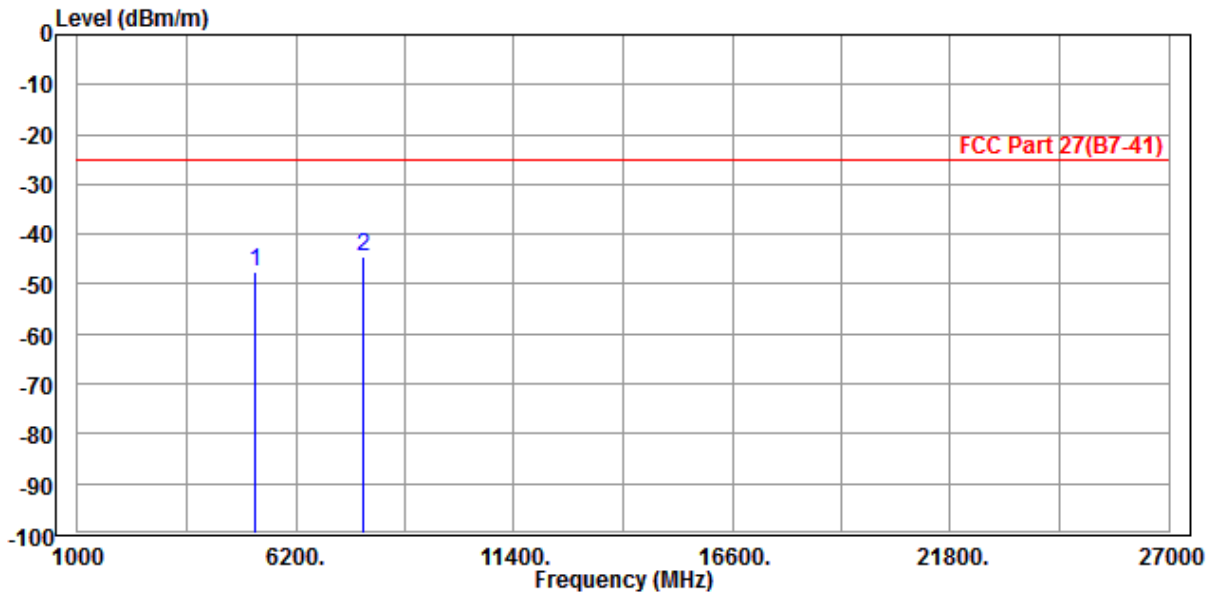



A D T

MODE	TX channel40740	FREQUENCY RANGE	Above 1000MHz
ENVIRONMENTAL CONDITIONS	26deg. C, 56%RH	INPUT POWER	DC 5V from adapter
TESTED BY	Alex Chen		
ANTENNA POLARITY & TEST DISTANCE: VERTICAL AT 3 M			

	Freq	Level	Read Level	Limit Line	Over Limit	Factor	Remark	Pol/Phase
	MHz	dBm/m	dBm	dBm/m	dB	dB/m		
1	5210.000	-48.28	-56.26	-25.00	-23.28	7.98	Peak	Vertical
2 PP	7815.000	-44.64	-58.00	-25.00	-19.64	13.36	Peak	Vertical

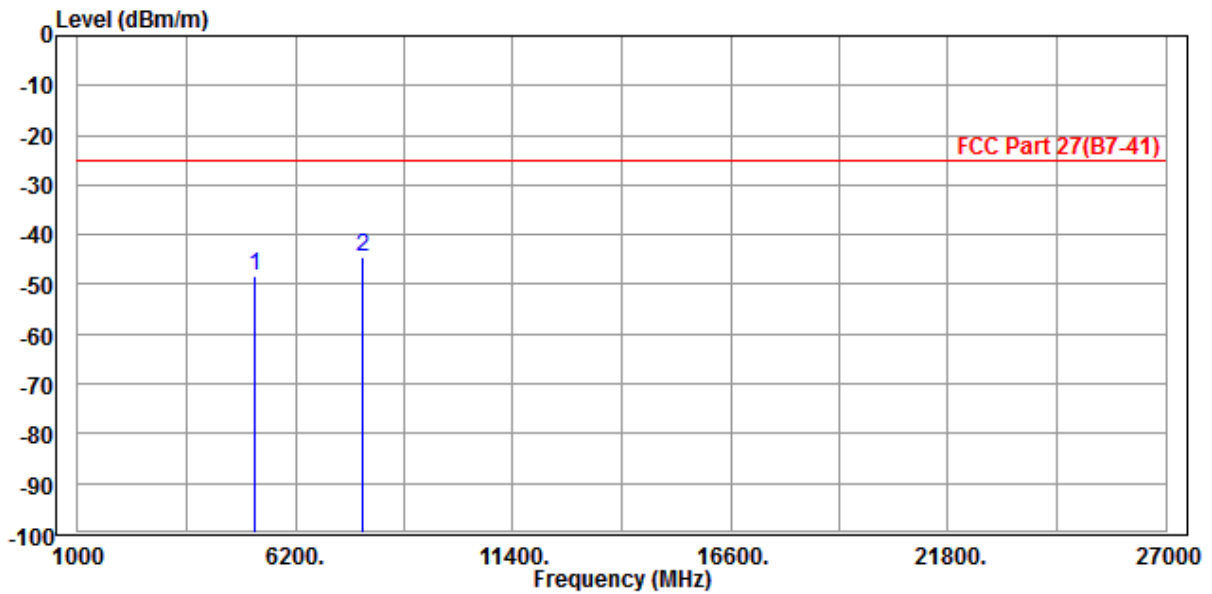

CHANNEL BANDWIDTH: 20MHz / QPSK

MODE	TX channel40740	FREQUENCY RANGE	Above 1000MHz
ENVIRONMENTAL CONDITIONS	26deg. C, 56%RH	INPUT POWER	DC 5V from adapter
TESTED BY	Alex Chen		
ANTENNA POLARITY & TEST DISTANCE: HORIZONTAL AT 3 M			

	Freq	Level	Read Level	Limit Line	Over Limit	Factor	Remark	Pol/Phase
	MHz	dBm/m	dBm	dBm/m	dB	dB/m		
1	5210.000	-47.65	-56.27	-25.00	-22.65	8.62	Peak	Horizontal
2 PP	7815.000	-43.05	-56.83	-25.00	-18.05	13.78	Peak	Horizontal

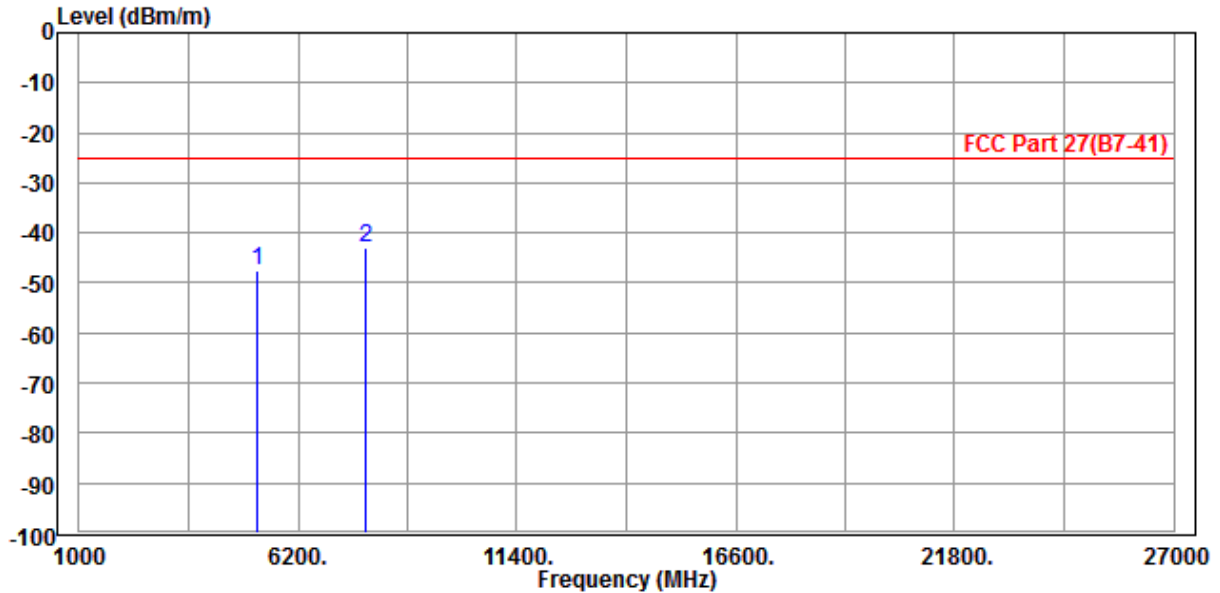

MODE	TX channel40740	FREQUENCY RANGE	Above 1000MHz
ENVIRONMENTAL CONDITIONS	26deg. C, 56%RH	INPUT POWER	DC 5V from adapter
TESTED BY	Alex Chen		
ANTENNA POLARITY & TEST DISTANCE: VERTICAL AT 3 M			

	Freq	Level	Read Level	Limit Line	Over Limit	Factor	Remark	Pol/Phase
	MHz	dBm/m	dBm	dBm/m	dB	dB/m		
1	5210.000	-48.11	-56.09	-25.00	-23.11	7.98	Peak	Vertical
2	PP 7815.000	-44.96	-58.32	-25.00	-19.96	13.36	Peak	Vertical

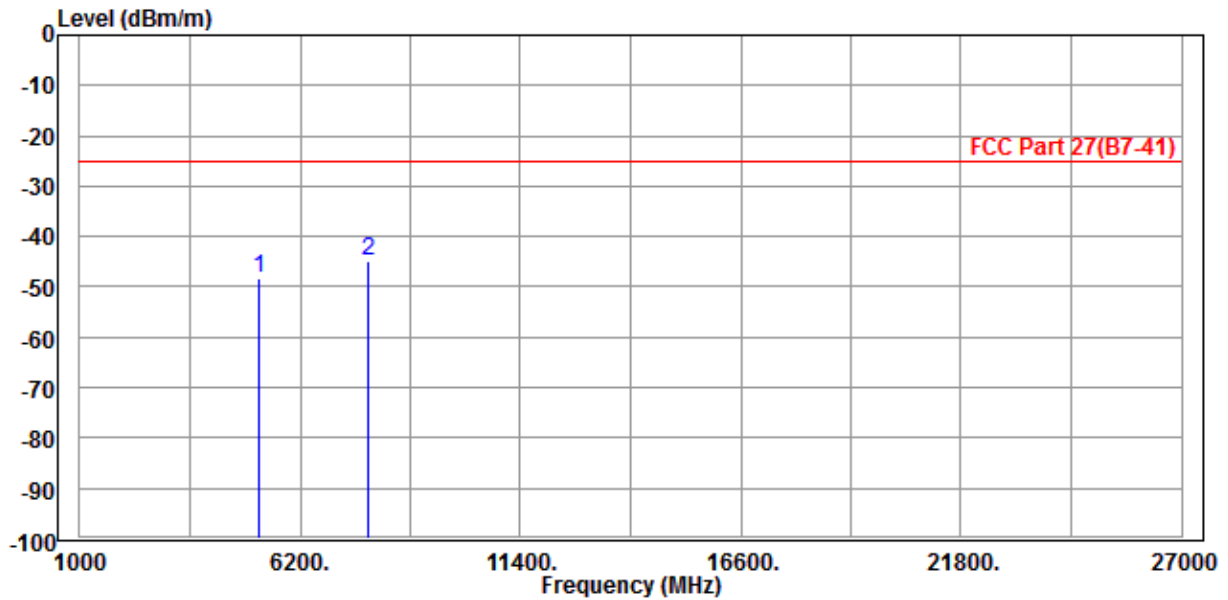

5 Pictures of Test Arrangements

Please refer to the attached file (Test Setup Photo).



Appendix – Information on the Testing Laboratories

We, Bureau Veritas Consumer Products Services (H.K.) Ltd., Taoyuan Branch, were founded in 1988 to provide our best service in EMC, Radio, Telecom and Safety consultation. Our laboratories are accredited and approved according to ISO/IEC 17025.

If you have any comments, please feel free to contact us at the following:

Linko EMC/RF Lab

Tel: 886-2-26052180

Fax: 886-2-26051924

Hsin Chu EMC/RF Lab/Telecom Lab

Tel: 886-3-5935343

Fax: 886-3-5935342

Hwa Ya EMC/RF/Safety

Tel: 886-3-3183232

Fax: 886-3-3270892

Email: service.adt@tw.bureauveritas.com

Web Site: www.bureauveritas-adt.com

The address and road map of all our labs can be found in our web site also.

--- END ---