



EMC TEST REPORT

Applicant Xiaomi Communications Co., Ltd.
FCC ID 2AFZZ-RMSG6S
Product Mobile Phone
Brand MI
Model MDG6S
Report No. RXA1708-0290EMC02R1
Issue Date September 27, 2017

TA Technology (Shanghai) Co., Ltd. tested the above equipment in accordance with the requirements in **FCC Code CFR47 Part15B (2017)/ ANSI C63.4 (2014)**. The test results show that the equipment tested is capable of demonstrating compliance with the requirements as documented in this report.

Wei Liu

Guangchang Fan

Performed by: Wei Liu/ Manager

Approved by: Guangchang Fan/ Director

TA Technology (Shanghai) Co., Ltd.

No.145, Jintang Rd, Tangzhen Industry Park, Pudong Shanghai, China

TEL: +86-021-50791141/2/3

FAX: +86-021-50791141/2/3-8000



Table of Contents

| | | |
|-----|---|----|
| 1 | Test Laboratory..... | 4 |
| 1.1 | Notes of the Test Report..... | 4 |
| 1.2 | Test facility..... | 4 |
| 1.3 | Testing Location..... | 5 |
| 2 | General Description of Equipment under Test..... | 6 |
| 2.1 | Client Information..... | 6 |
| 2.2 | General information..... | 6 |
| 2.3 | Applied Standards..... | 7 |
| 2.4 | Test Mode..... | 8 |
| 3 | Test Case Results..... | 9 |
| 3.1 | Radiated Emission..... | 9 |
| 3.2 | Conducted Emission..... | 15 |
| 4 | Main Test Instrument..... | 17 |
| | ANNEX A: The EUT Appearance and Test Configuration..... | 18 |
| | A.1 EUT Appearance..... | 18 |
| | A.2 Test Setup..... | 21 |
| | A.3 Host Product..... | 23 |



Summary of measurement results

| Number | Test Case | Clause in FCC Rules | Conclusion |
|--|--------------------|-------------------------|------------|
| 1 | Radiated Emission | 15.109, ANSI C63.4-2014 | PASS |
| 2 | Conducted Emission | 15.107, ANSI C63.4-2014 | PASS |
| Test Date: August 21, 2017 ~ August 31, 2017 | | | |

1 Test Laboratory

1.1 Notes of the Test Report

This report shall not be reproduced in full or partial, without the written approval of **TA technology (shanghai) co., Ltd.** The results documented in this report apply only to the tested sample, under the conditions and modes of operation as described herein. Measurement Uncertainties were not taken into account and are published for informational purposes only. This report is written to support regulatory compliance of the applicable standards stated above. This report must not be used by the client to claim product certification, approval, or endorsement any government agencies.

1.2 Test facility

CNAS (accreditation number: L2264)

TA Technology (Shanghai) Co., Ltd. has obtained the accreditation of China National Accreditation Service for Conformity Assessment (CNAS).

FCC (Designation number: CN1179, Test Firm Registration Number: 446626)

TA Technology (Shanghai) Co., Ltd. has been listed on the US Federal Communications Commission list of test facilities recognized to perform electromagnetic emissions measurements.

IC (recognition number is 8510A)

TA Technology (Shanghai) Co., Ltd. has been listed by industry Canada to perform electromagnetic emission measurement.

VCCI (recognition number is C-4595, T-2154, R-4113, G-10766)

TA Technology (Shanghai) Co., Ltd. has been listed by industry Japan to perform electromagnetic emission measurement.

A2LA (Certificate Number: 3857.01)

TA Technology (Shanghai) Co., Ltd. has been listed by American Association for Laboratory Accreditation to perform electromagnetic emission measurement.



1.3 Testing Location

Company: TA Technology (Shanghai) Co., Ltd.
Address: No.145, Jintang Rd, Tangzhen Industry Park, Pudong Shanghai, China
City: Shanghai
Post code: 201201
Country: P. R. China
Contact: Xu Kai
Telephone: +86-021-50791141/2/3
Fax: +86-021-50791141/2/3-8000
Website: <http://www.ta-shanghai.com>
E-mail: xukai@ta-shanghai.com

2 General Description of Equipment under Test

2.1 Client Information

| | |
|-----------------------------|---|
| Applicant | Xiaomi Communications Co., Ltd. |
| Applicant address | The Rainbow City of China Resources,NO.68,Qinghe Middle Street,Haidian District,Beijing,China |
| Manufacturer | Xiaomi Communications Co., Ltd. |
| Manufacturer address | The Rainbow City of China Resources,NO.68,Qinghe Middle Street,Haidian District,Beijing,China |

2.2 General information

| EUT Description | |
|--|---|
| Device Type: | Portable Device |
| Product Name: | Mobile Phone |
| Model Number: | MDG6S |
| HW Version: | P2 |
| SW Version: | MIUI9 |
| IMEI: | SIM1:865396030036780 SIM2:865396030036798 |
| Antenna Type: | Internal Antenna |
| Used Host Product: | PC Manufacturer: Dell Model: E5450 (SN : P48G001) |
| Test Mode: | Transfer Data Mode |
| EUT Accessory | |
| Adapter 1 | Manufacturer: Jiangsu Chenyang Electron Co., Ltd. Model: MDY-08-EZ |
| Adapter 2 | Manufacturer: DONGGUAN AOHAI POWER TECHNOLOGY CO., LTD. Model: MDY-08-EZ |
| Battery 1 | Manufacturer:HARBIN COSLIGHT POWER CO LTD Model: BN31 |
| Battery 2 | Manufacturer:Sunwoda Electronic Co.,LTD Model: BN31 |
| USB Cable | Manufacturer:BOLUDE Model:A TO Micro-B Length: 1m |
| <p>Remark: The information of the EUT is declared by the manufacturer.</p> <p>2. There is more than one Adapter /one SIM card slot/ one Battery, each one should be applied throughout the compliance test respectively, however, only the worst case (Adapter 2 /SIM 1 /Battery 1) will be recorded in this report.</p> | |



2.3 Applied Standards

According to the specifications of the manufacturer, it must comply with the requirements of the following standards:

Test standards

FCC Code CFR47 Part15B (2017)

ANSI C63.4 (2014)

2.4 Test Mode

| Test Mode | |
|-----------|--|
| Mode 1: | Adapter + USB cable + earphone + Camera On + GPS Rx + MP3 + Idle |
| Mode 2: | Adapter + USB cable + earphone + MP3 + Idle |
| Mode 3: | Adapter + USB cable + earphone + Idle |
| Mode 4: | Adapter + USB cable + Idle |
| Mode 5: | USB Copy(EUT with PC) + USB cable + earphone + Camera On + MP3 + GPS Rx + Idle |
| Mode 6: | Camera On + earphone + GPS Rx + Idle |
| Mode 7: | Earphone + MP3 + Idle |
| Mode 8: | Earphone + Idle |

During the test, the preliminary test was performed in all modes (Camera/MP3/GPS) with all frequency bands (GSM/ WCDMA/ LTE/ BT/ Wi-Fi), mode 5 (with Camera + MP3 + GPS Rx + GSM/ WCDMA/ LTE/ BT/ Wi-Fi idle) selected as the worst condition. The test data of the worst-case condition was recorded in this report.

3 Test Case Results

3.1 Radiated Emission

Ambient condition

| Temperature | Relative humidity | Pressure |
|-------------|-------------------|----------|
| 24°C~26°C | 45%~50% | 102.5kPa |

Methods of Measurement

The EUT is placed on a non-metallic table 0.8m above the horizontal metal reference ground plane. The distance between EUT and receive antenna should be 3 meters. During the test, the EUT was operating in its typical mode. The test method is according to ANSI C63.4-2014. Sweep the whole frequency band through the range from 30MHz to the 5th harmonic of the carrier. During the test, the height of receive antenna shall be moved from 1 to 4 meters, and the antenna shall be performed under horizontal and vertical polarization. The turn table shall be rotated from 0 to 360 degrees for detecting the maximum of radiated signal level.

The data of cable loss and antenna factor has been calibrated in full testing frequency range before the testing. During the test, the EUT is worked at maximum output power.

Set the spectrum analyzer in the following:

Below 1GHz:

RBW=100 kHz / VBW=300 kHz / Sweep=AUTO

Above 1GHz:

(a) PEAK: RBW=1MHz / VBW=3MHz/ Sweep=AUTO

(b) AVERAGE: RBW=1MHz / VBW=3MHz / Sweep=AUTO

The radiated emission was measured in the following position: EUT stand-up position (Z axis), lie-down position (X, Y axis). The worst emission was found in stand-up position (Z axis) and the worst case was recorded.

During the test, EUT is connected to a laptop via a USB cable in the case of Transfer Data mode. The EUT is used as the peripheral equipment of the PC. The data is transferred from EUT to PC; PC is connected to server via a long LAN cable.

Test Setup

Below 1GHz

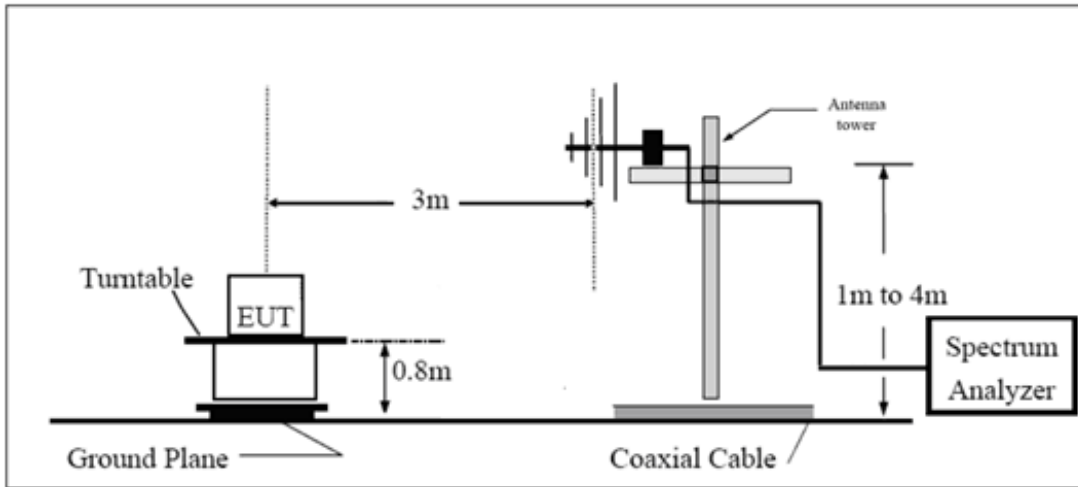

Above 1GHz

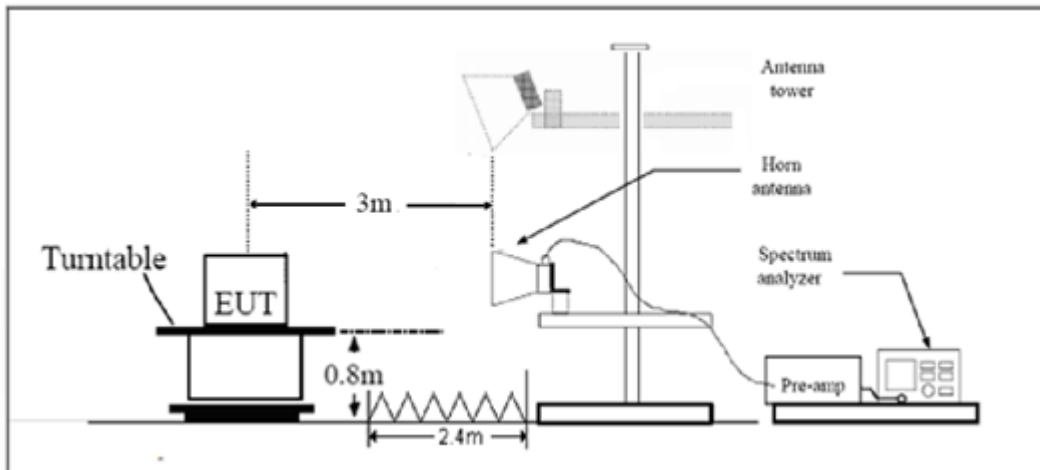

Note: Area side:2.4mX3.6m

Antenna Tower meets ANSI C63.4 requirements for measurements above 1 GHz by keeping the antenna aimed at the EUT during the antenna's ascent/ descent along the antenna mast.

Limits

| Frequency (MHz) | Field Strength (dB μ V/m) | Detector |
|---|-------------------------------|-----------------|
| 30 -88 | 40.0 | Quasi-peak |
| 88-216 | 43.5 | Quasi-peak |
| 216 – 960 | 46.0 | Quasi-peak |
| 960-1000 | 54.0 | Quasi-peak |
| 1000-5 th harmonic of the highest frequency or 40GHz, which is lower | 54 74 | Average Peak |

Measurement Uncertainty

The assessed measurement uncertainty to ensure 95% confidence level for the normal distribution is with the coverage factor $k = 1.96$. $U = 3.92$ dB.

Test Results

The following graphs display the maximum values of horizontal and vertical by software.
 For above 1GHz, Blue trace uses the peak detection, Green trace uses the average detection.

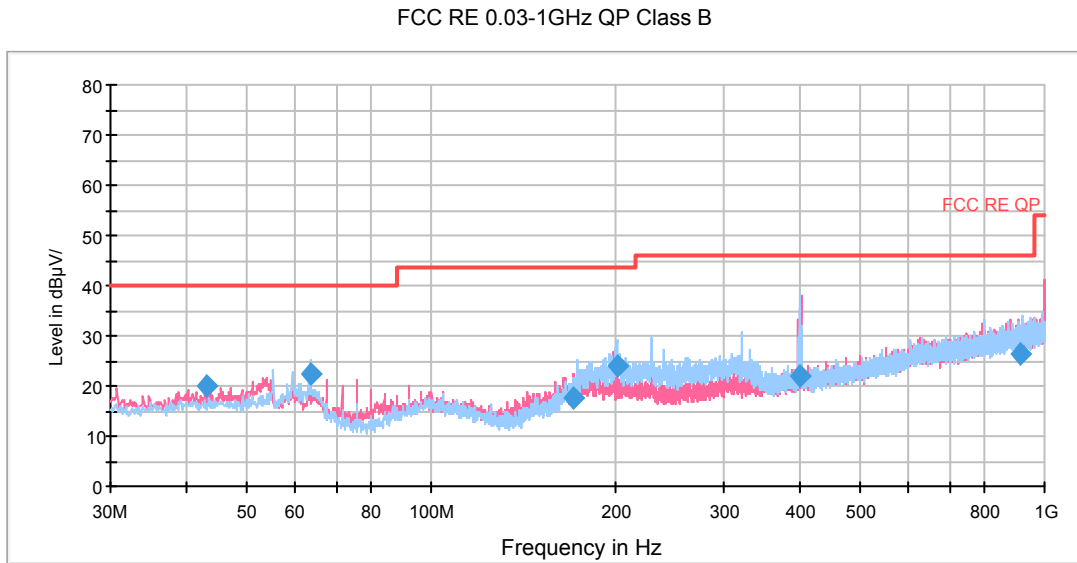

Radiated Emission from 30MHz to 1GHz

| Frequency (MHz) | Quasi-Peak (dBuV/m) | Reading value (dBuV/m) | Height (cm) | Polarization | Azimuth (deg) | Correct Factor (dB) | Margin (dB) | Limit (dBuV/m) |
|-----------------|---------------------|------------------------|-------------|--------------|---------------|---------------------|-------------|----------------|
| 43.013750 | 19.9 | 6.8 | 100.0 | V | 79.0 | 13.1 | 20.1 | 40.0 |
| 63.505000 | 22.6 | 11.5 | 125.0 | H | 342.0 | 11.1 | 17.4 | 40.0 |
| 170.606250 | 17.5 | 7.2 | 100.0 | V | 177.0 | 10.3 | 26.0 | 43.5 |
| 200.678750 | 23.9 | 11.7 | 125.0 | H | 93.0 | 12.2 | 19.6 | 43.5 |
| 399.806250 | 21.9 | 3.6 | 100.0 | H | 32.0 | 18.3 | 24.1 | 46.0 |
| 917.070000 | 26.2 | -0.8 | 125.0 | H | 245.0 | 27.0 | 19.8 | 46.0 |

- Remark:**
1. Quasi-Peak = Reading value + Correction factor
 2. Correction Factor = Antenna factor+ Insertion loss(cable loss+amplifier gain)
 3. Margin = Limit – Quasi-Peak

FCC RE 1G-18GHz PK+AV Class B

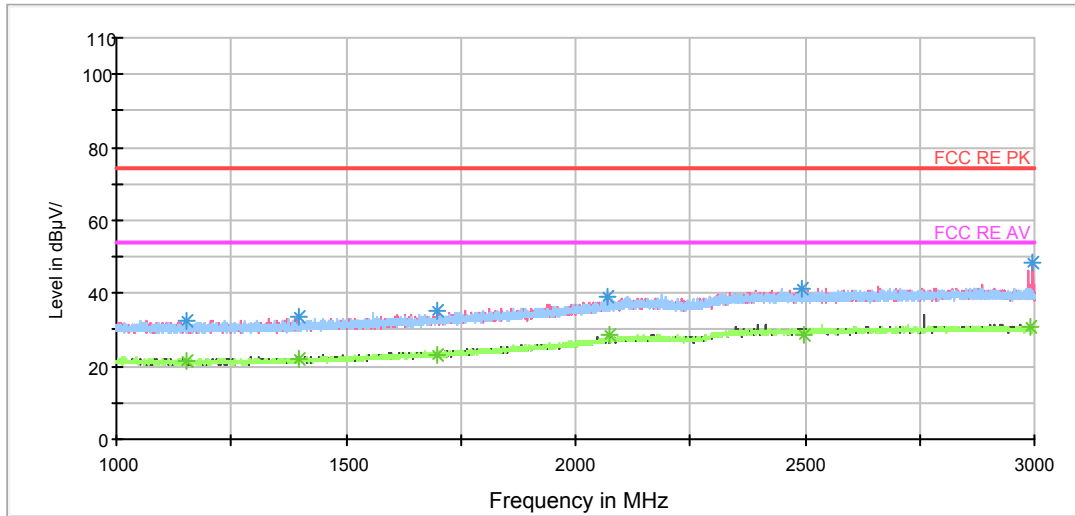

Radiated Emission from 1GHz to 3GHz

| Frequency (MHz) | Peak (dBuV/m) | Reading value (dBuV/m) | Height (cm) | Polarization | Azimuth (deg) | Correct Factor (dB) | Margin (dB) | Limit (dBuV/m) |
|-----------------|---------------|------------------------|-------------|--------------|---------------|---------------------|-------------|----------------|
| 1152.000000 | 32.4 | 40.9 | 100.0 | H | 54.0 | -8.5 | 37.6 | 74 |
| 1395.750000 | 33.7 | 40.7 | 100.0 | V | 227.0 | -7.0 | 36.3 | 74 |
| 1698.750000 | 35.0 | 40.3 | 100.0 | V | 277.0 | -5.3 | 35.0 | 74 |
| 2071.250000 | 39.2 | 42.1 | 100.0 | V | 132.0 | -2.9 | 30.8 | 74 |
| 2493.250000 | 41.3 | 42.2 | 100.0 | H | 342.0 | -0.9 | 32.7 | 74 |
| 2997.500000 | 48.2 | 48.8 | 100.0 | V | 357.0 | -0.6 | 25.8 | 74 |

| Frequency (MHz) | Average (dBuV/m) | Reading value (dBuV/m) | Height (cm) | Polarization | Azimuth (deg) | Correct Factor (dB) | Margin (dB) | Limit (dBuV/m) |
|-----------------|------------------|------------------------|-------------|--------------|---------------|---------------------|-------------|----------------|
| 1153.250000 | 21.2 | 29.7 | 100.0 | V | 206.0 | -8.5 | 32.8 | 54 |
| 1398.250000 | 22.1 | 29.1 | 100.0 | V | 327.0 | -7.0 | 31.9 | 54 |
| 1696.750000 | 23.2 | 28.5 | 100.0 | V | 109.0 | -5.3 | 30.8 | 54 |
| 2074.250000 | 28.5 | 31.5 | 100.0 | V | 299.0 | -3.0 | 25.5 | 54 |
| 2495.750000 | 28.9 | 29.8 | 100.0 | V | 161.0 | -0.9 | 25.1 | 54 |
| 2992.500000 | 31.0 | 31.6 | 100.0 | V | 284.0 | -0.6 | 23.0 | 54 |

FCC RE 1G-18GHz PK+AV Class B

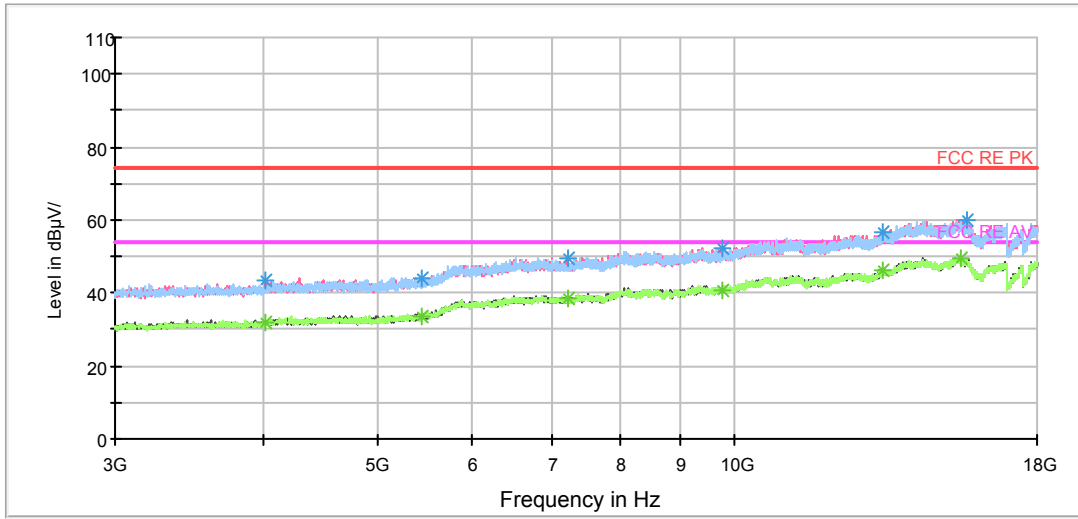

Radiated Emission from 3GHz to 18GHz

| Frequency (MHz) | Peak (dBuV/m) | Reading value (dBuV/m) | Height (cm) | Polarization | Azimuth (deg) | Correct Factor (dB) | Margin (dB) | Limit (dBuV/m) |
|-----------------|---------------|------------------------|-------------|--------------|---------------|---------------------|-------------|----------------|
| 4021.875000 | 43.3 | 42.5 | 100.0 | V | 283.0 | 0.8 | 30.7 | 74 |
| 5445.000000 | 44.1 | 41.6 | 100.0 | H | 65.0 | 2.5 | 29.9 | 74 |
| 7230.000000 | 49.7 | 42.1 | 100.0 | H | 14.0 | 7.6 | 24.3 | 74 |
| 9753.750000 | 52.2 | 40.8 | 100.0 | V | 335.0 | 11.4 | 21.8 | 74 |
| 13344.375000 | 56.8 | 41.1 | 100.0 | V | 150.0 | 15.7 | 17.2 | 74 |
| 15691.875000 | 59.9 | 42.6 | 100.0 | H | 136.0 | 17.3 | 14.1 | 74 |

| Frequency (MHz) | Average (dBuV/m) | Reading value (dBuV/m) | Height (cm) | Polarization | Azimuth (deg) | Correct Factor (dB) | Margin (dB) | Limit (dBuV/m) |
|-----------------|------------------|------------------------|-------------|--------------|---------------|---------------------|-------------|----------------|
| 4021.875000 | 32.0 | 31.2 | 100.0 | V | 283.0 | 0.8 | 22.0 | 54 |
| 5445.000000 | 33.5 | 31.0 | 100.0 | H | 65.0 | 2.5 | 20.5 | 54 |
| 7230.000000 | 38.5 | 30.9 | 100.0 | H | 14.0 | 7.6 | 15.5 | 54 |
| 9753.750000 | 40.7 | 29.3 | 100.0 | V | 335.0 | 11.4 | 13.3 | 54 |
| 13344.375000 | 46.2 | 30.5 | 100.0 | V | 150.0 | 15.7 | 7.8 | 54 |
| 15532.500000 | 49.6 | 31.1 | 100.0 | V | 150.0 | 18.5 | 4.4 | 54 |

3.2 Conducted Emission

Ambient condition

| | | |
|-------------|-------------------|----------|
| Temperature | Relative humidity | Pressure |
| 24°C ~26°C | 50%~55% | 102.5kPa |

Methods of Measurement

The EUT is placed on a non-metallic table of 80cm height above the horizontal metal reference ground plane. During the test, the EUT was operating in its typical mode. The test method is according to ANSI C63.4-2014. Connect the AC power line of the EUT to the L.I.S.N. Use EMI receiver to detect the average and Quasi-peak value. RBW is set to 9 kHz, VBW is set to 30kHz. The measurement result should include both L line and N line.

During the test, EUT is connected to a laptop via a USB cable in the case of Transfer Data mode. The EUT is used as the peripheral equipment of the PC. The data is transferred from EUT to PC; PC is connected to server via a long LAN cable.

Test Setup

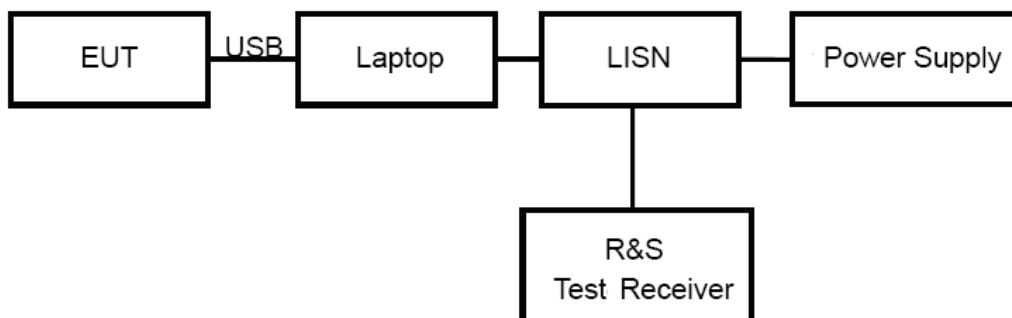

Note: Power Supply is AC Power source and it is used to change the voltage 120V/60Hz.

Limits

| Frequency (MHz) | Conducted Limits(dBμV) | |
|-----------------|------------------------|------------|
| | Quasi-peak | Average |
| 0.15 - 0.5 | 66 to 56 * | 56 to 46 * |
| 0.5 - 5 | 56 | 46 |
| 5 - 30 | 60 | 50 |

*: Decreases with the logarithm of the frequency.

Measurement Uncertainty

The assessed measurement uncertainty to ensure 95% confidence level for the normal distribution is with the coverage factor $k = 1.96$. $U = 2.69$ dB.

Test Results

Following plots, Blue trace uses the peak detection; Green trace uses the average detection.

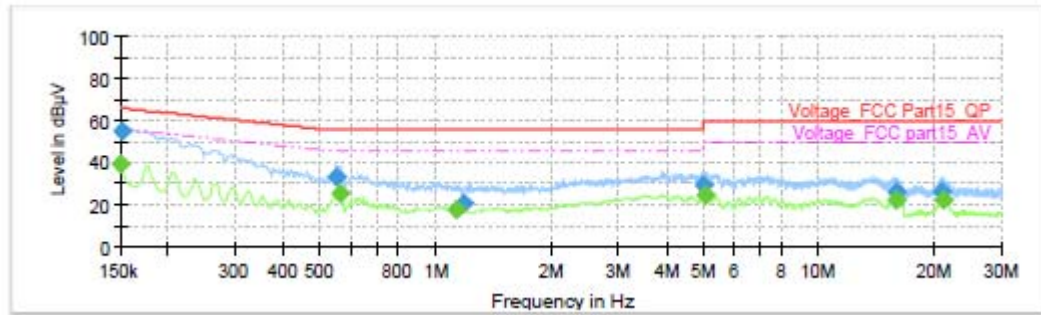

| Frequency (MHz) | QuasiPeak (dBµV) | Average (dBµV) | Limit (dBµV) | Margin (dB) | Meas. Time (ms) | Bandwidth (kHz) | Line | Filter | Corr. (dB) |
|-----------------|------------------|----------------|--------------|-------------|-----------------|-----------------|------|--------|------------|
| 0.150000 | --- | 39.52 | 56.00 | 16.48 | 1000.0 | 9.000 | L1 | ON | 19.1 |
| 0.152250 | 55.36 | --- | 65.88 | 10.52 | 1000.0 | 9.000 | L1 | ON | 19.0 |
| 0.552750 | 33.02 | --- | 56.00 | 22.98 | 1000.0 | 9.000 | L1 | ON | 19.3 |
| 0.559500 | --- | 25.65 | 46.00 | 20.35 | 1000.0 | 9.000 | L1 | ON | 19.3 |
| 1.131000 | --- | 17.90 | 46.00 | 28.10 | 1000.0 | 9.000 | L1 | ON | 19.2 |
| 1.182750 | 21.03 | --- | 56.00 | 34.97 | 1000.0 | 9.000 | L1 | ON | 19.2 |
| 4.976250 | 29.25 | --- | 56.00 | 26.75 | 1000.0 | 9.000 | L1 | ON | 19.1 |
| 5.052750 | --- | 24.52 | 50.00 | 25.48 | 1000.0 | 9.000 | L1 | ON | 19.1 |
| 15.846000 | 26.51 | --- | 60.00 | 33.49 | 1000.0 | 9.000 | L1 | ON | 19.4 |
| 15.866250 | --- | 22.52 | 50.00 | 27.48 | 1000.0 | 9.000 | L1 | ON | 19.4 |
| 20.973750 | 26.12 | --- | 60.00 | 33.88 | 1000.0 | 9.000 | L1 | ON | 19.7 |
| 21.264000 | --- | 22.13 | 50.00 | 27.87 | 1000.0 | 9.000 | L1 | ON | 19.6 |

L line

Conducted Emission from 150 KHz to 30 MHz

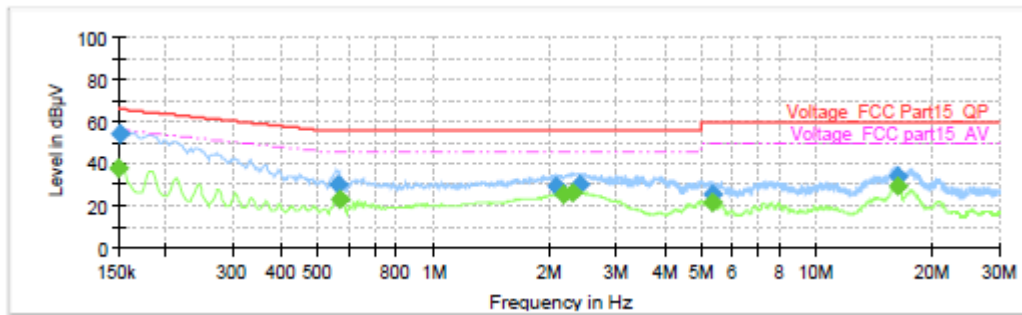

| Frequency (MHz) | QuasiPeak (dBµV) | Average (dBµV) | Limit (dBµV) | Margin (dB) | Meas. Time (ms) | Bandwidth (kHz) | Line | Filter | Corr. (dB) |
|-----------------|------------------|----------------|--------------|-------------|-----------------|-----------------|------|--------|------------|
| 0.150000 | --- | 38.28 | 56.00 | 17.72 | 1000.0 | 9.000 | N | ON | 19.1 |
| 0.152250 | 54.17 | --- | 65.88 | 11.71 | 1000.0 | 9.000 | N | ON | 19.1 |
| 0.564000 | 30.13 | --- | 56.00 | 25.87 | 1000.0 | 9.000 | N | ON | 19.3 |
| 0.568500 | --- | 23.12 | 46.00 | 22.88 | 1000.0 | 9.000 | N | ON | 19.3 |
| 2.096250 | 29.74 | --- | 56.00 | 26.26 | 1000.0 | 9.000 | N | ON | 19.1 |
| 2.177250 | --- | 25.86 | 46.00 | 20.14 | 1000.0 | 9.000 | N | ON | 19.1 |
| 2.314500 | --- | 26.57 | 46.00 | 19.43 | 1000.0 | 9.000 | N | ON | 19.0 |
| 2.393250 | 30.56 | --- | 56.00 | 25.44 | 1000.0 | 9.000 | N | ON | 19.0 |
| 5.311500 | --- | 21.71 | 50.00 | 28.29 | 1000.0 | 9.000 | N | ON | 19.1 |
| 5.354250 | 25.29 | --- | 60.00 | 34.71 | 1000.0 | 9.000 | N | ON | 19.1 |
| 16.228500 | --- | 29.67 | 50.00 | 20.33 | 1000.0 | 9.000 | N | ON | 19.4 |
| 16.280250 | 34.19 | --- | 60.00 | 25.81 | 1000.0 | 9.000 | N | ON | 19.4 |

N line

Conducted Emission from 150 KHz to 30 MHz

4 Main Test Instrument

| Name | Manufacturer | Type | Serial Number | Last Cal. | Cal. Due Date |
|-------------------------|--------------|-----------|---------------|------------|---------------|
| Signal Analyzer | R&S | FSV30 | 100815 | 2016-12-16 | 2017-12-15 |
| EMI Test Receiver | R&S | ESCI | 100948 | 2017-05-20 | 2018-05-19 |
| Loop Antenna | SCHWARZBECK | FMZB1519 | 1519-047 | 2017-02-18 | 2019-02-17 |
| Trilog Antenna | SCHWARZBECK | VULB 9163 | 9163-201 | 2014-12-06 | 2017-12-05 |
| Horn Antenna | R&S | HF907 | 100126 | 2014-12-06 | 2017-12-05 |
| Horn Antenna | ETS-Lindgren | 3160-09 | 00102643 | 2015-01-30 | 2018-01-29 |
| EMI Test Receiver | R&S | ESCS30 | 100138 | 2016-12-16 | 2017-12-15 |
| LISN | R&S | ENV216 | 101171 | 2016-12-16 | 2019-12-15 |
| Bore Sight Antenna mast | ETS | 2171B | 00058752 | NA | NA |

ANNEX A: The EUT Appearance and Test Configuration

A.1 EUT Appearance



Front Side



Back Side

a: EUT



Adapter 1



Adapter 2
b: Adapter

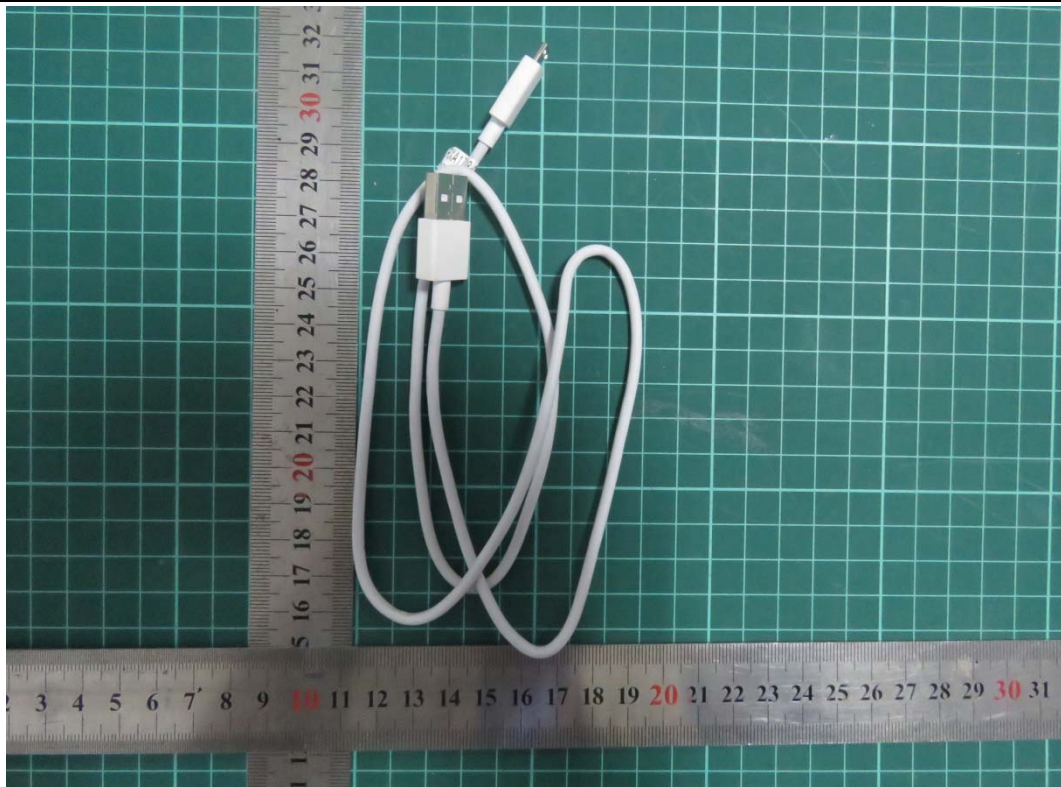

c : USB Cable
Picture 1 EUT

A.2 Test Setup

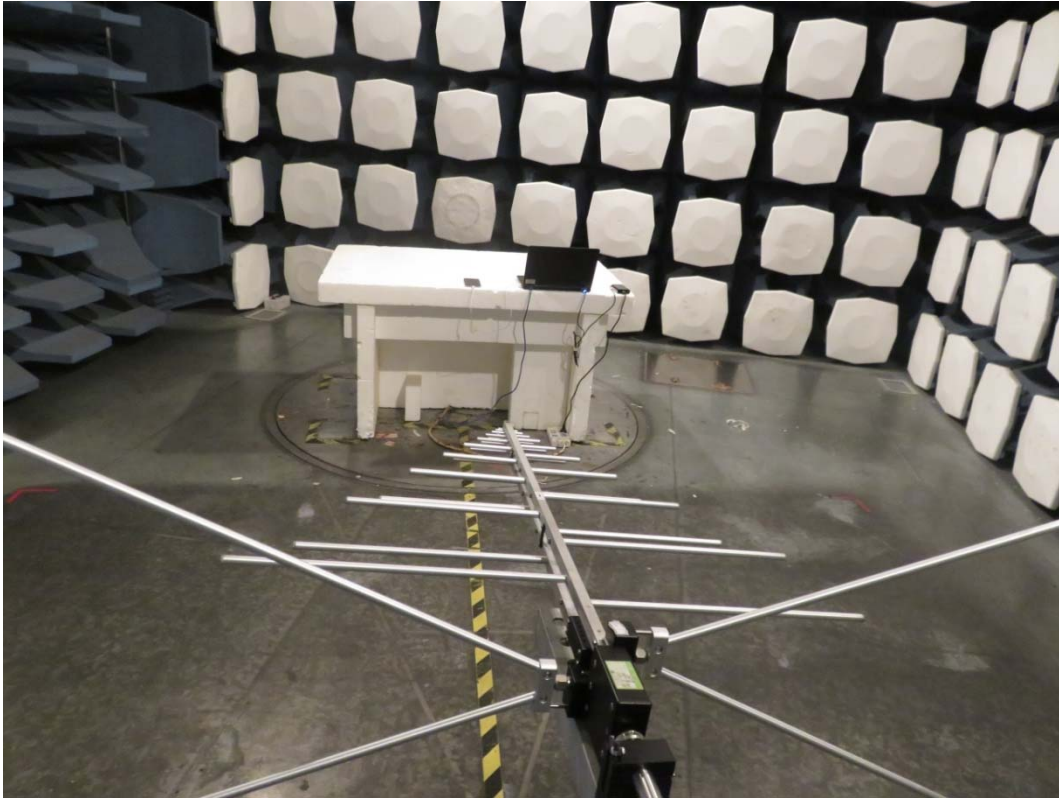

a: Below 1GHz

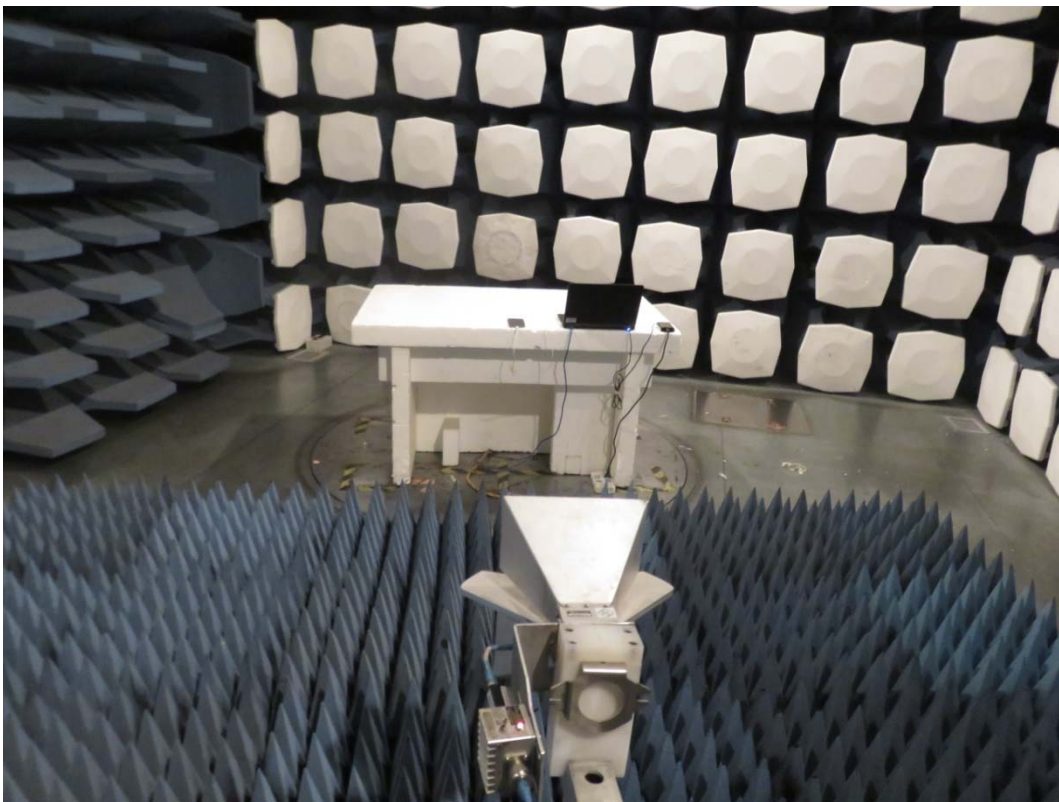

b: Above 1GHz

Picture 2 Radiated Emission Test Setup



Picture 3 Conducted Emission Test Setup

A.3 Host Product

