

**Calibration Laboratory of**  
Schmid & Partner  
Engineering AG  
Zeughausstrasse 43, 8004 Zurich, Switzerland



**S** Schweizerischer Kalibrierdienst  
**C** Service suisse d'étalonnage  
**S** Servizio svizzero di taratura  
**S** Swiss Calibration Service

Accredited by the Swiss Accreditation Service (SAS)

The Swiss Accreditation Service is one of the signatories to the EA  
Multilateral Agreement for the recognition of calibration certificates

Accreditation No.: **SCS 108**

**Glossary:**

TSL	tissue simulating liquid
ConvF	sensitivity in TSL / NORM x,y,z
N/A	not applicable or not measured

**Calibration is Performed According to the Following Standards:**

- IEEE Std 1528-2013, "IEEE Recommended Practice for Determining the Peak Spatial-Averaged Specific Absorption Rate (SAR) in the Human Head from Wireless Communications Devices: Measurement Techniques", June 2013
- IEC 62209-1, "Procedure to measure the Specific Absorption Rate (SAR) for hand-held devices used in close proximity to the ear (frequency range of 300 MHz to 3 GHz)", February 2005
- KDB 865664, "SAR Measurement Requirements for 100 MHz to 6 GHz"

**Additional Documentation:**

- DASY4/5 System Handbook

**Methods Applied and Interpretation of Parameters:**

- Measurement Conditions:* Further details are available from the Validation Report at the end of the certificate. All figures stated in the certificate are valid at the frequency indicated.
- Antenna Parameters with TSL:* The dipole is mounted with the spacer to position its feed point exactly below the center marking of the flat phantom section, with the arms oriented parallel to the body axis.
- Feed Point Impedance and Return Loss:* These parameters are measured with the dipole positioned under the liquid filled phantom. The impedance stated is transformed from the measurement at the SMA connector to the feed point. The Return Loss ensures low reflected power. No uncertainty required.
- Electrical Delay:* One-way delay between the SMA connector and the antenna feed point. No uncertainty required.
- SAR measured:* SAR measured at the stated antenna input power.
- SAR normalized:* SAR as measured, normalized to an input power of 1 W at the antenna connector.
- SAR for nominal TSL parameters:* The measured TSL parameters are used to calculate the nominal SAR result.

The reported uncertainty of measurement is stated as the standard uncertainty of measurement multiplied by the coverage factor  $k=2$ , which for a normal distribution corresponds to a coverage probability of approximately 95%.

**Measurement Conditions**

DASY system configuration, as far as not given on page 1.

<b>DASY Version</b>	DASY5	V52.8.8
<b>Extrapolation</b>	Advanced Extrapolation	
<b>Phantom</b>	Modular Flat Phantom	
<b>Distance Dipole Center - TSL</b>	10 mm	with Spacer
<b>Zoom Scan Resolution</b>	dx, dy, dz = 5 mm	
<b>Frequency</b>	2600 MHz ± 1 MHz	

**Head TSL parameters**

The following parameters and calculations were applied.

	Temperature	Permittivity	Conductivity
<b>Nominal Head TSL parameters</b>	22.0 °C	39.0	1.96 mho/m
<b>Measured Head TSL parameters</b>	(22.0 ± 0.2) °C	39.1 ± 6 %	2.02 mho/m ± 6 %
<b>Head TSL temperature change during test</b>	< 0.5 °C	----	----

**SAR result with Head TSL**

<b>SAR averaged over 1 cm<sup>3</sup> (1 g) of Head TSL</b>	Condition	
SAR measured	250 mW input power	14.4 W/kg
SAR for nominal Head TSL parameters	normalized to 1W	<b>56.9 W/kg ± 17.0 % (k=2)</b>

<b>SAR averaged over 10 cm<sup>3</sup> (10 g) of Head TSL</b>	condition	
SAR measured	250 mW input power	6.40 W/kg
SAR for nominal Head TSL parameters	normalized to 1W	<b>25.4 W/kg ± 16.5 % (k=2)</b>

**Body TSL parameters**

The following parameters and calculations were applied.

	Temperature	Permittivity	Conductivity
<b>Nominal Body TSL parameters</b>	22.0 °C	52.5	2.16 mho/m
<b>Measured Body TSL parameters</b>	(22.0 ± 0.2) °C	50.5 ± 6 %	2.22 mho/m ± 6 %
<b>Body TSL temperature change during test</b>	< 0.5 °C	----	----

**SAR result with Body TSL**

<b>SAR averaged over 1 cm<sup>3</sup> (1 g) of Body TSL</b>	Condition	
SAR measured	250 mW input power	14.4 W/kg
SAR for nominal Body TSL parameters	normalized to 1W	<b>56.4 W/kg ± 17.0 % (k=2)</b>

<b>SAR averaged over 10 cm<sup>3</sup> (10 g) of Body TSL</b>	condition	
SAR measured	250 mW input power	6.36 W/kg
SAR for nominal Body TSL parameters	normalized to 1W	<b>25.1 W/kg ± 16.5 % (k=2)</b>

**Appendix (Additional assessments outside the scope of SCS108)****Antenna Parameters with Head TSL**

Impedance, transformed to feed point	49.7 $\Omega$ - 6.2 j $\Omega$
Return Loss	- 24.2 dB

**Antenna Parameters with Body TSL**

Impedance, transformed to feed point	46.6 $\Omega$ - 5.4 j $\Omega$
Return Loss	- 23.6 dB

**General Antenna Parameters and Design**

Electrical Delay (one direction)	1.150 ns
----------------------------------	----------

After long term use with 100W radiated power, only a slight warming of the dipole near the feedpoint can be measured.

The dipole is made of standard semirigid coaxial cable. The center conductor of the feeding line is directly connected to the second arm of the dipole. The antenna is therefore short-circuited for DC-signals. On some of the dipoles, small end caps are added to the dipole arms in order to improve matching when loaded according to the position as explained in the "Measurement Conditions" paragraph. The SAR data are not affected by this change. The overall dipole length is still according to the Standard.

No excessive force must be applied to the dipole arms, because they might bend or the soldered connections near the feedpoint may be damaged.

**Additional EUT Data**

Manufactured by	SPEAG
Manufactured on	May 13, 2008

**DASY5 Validation Report for Head TSL**

Date: 08.12.2014

Test Laboratory: SPEAG, Zurich, Switzerland

**DUT: Dipole 2600 MHz; Type: D2600V2; Serial: D2600V2 - SN: 1025**

Communication System: UID 0 - CW; Frequency: 2600 MHz

Medium parameters used:  $f = 2600$  MHz;  $\sigma = 2.02$  S/m;  $\epsilon_r = 39.1$ ;  $\rho = 1000$  kg/m<sup>3</sup>

Phantom section: Flat Section

Measurement Standard: DASY5 (IEEE/IEC/ANSI C63.19-2011)

DASY52 Configuration:

- Probe: ES3DV3 - SN3205; ConvF(4.46, 4.46, 4.46); Calibrated: 30.12.2013;
- Sensor-Surface: 3mm (Mechanical Surface Detection)
- Electronics: DAE4 Sn601; Calibrated: 18.08.2014
- Phantom: Flat Phantom 5.0 (front); Type: QD000P50AA; Serial: 1001
- DASY52 52.8.8(1222); SEMCAD X 14.6.10(7331)

**Dipole Calibration for Head Tissue/Pin=250 mW, d=10mm/Zoom Scan (7x7x7)/Cube 0:**

Measurement grid: dx=5mm, dy=5mm, dz=5mm

Reference Value = 102.3 V/m; Power Drift = 0.03 dB

Peak SAR (extrapolated) = 30.9 W/kg

**SAR(1 g) = 14.4 W/kg; SAR(10 g) = 6.4 W/kg**

Maximum value of SAR (measured) = 19.4 W/kg

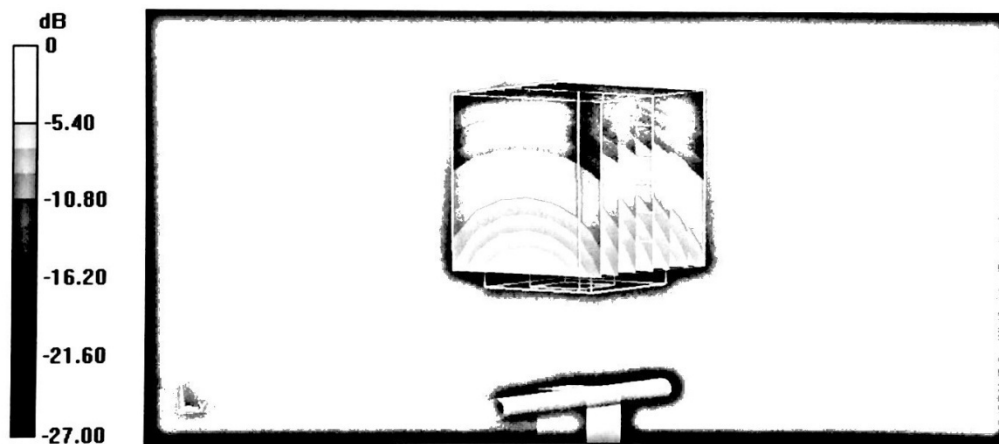

0 dB = 19.4 W/kg = 12.88 dBW/kg



### Impedance Measurement Plot for Head TSL

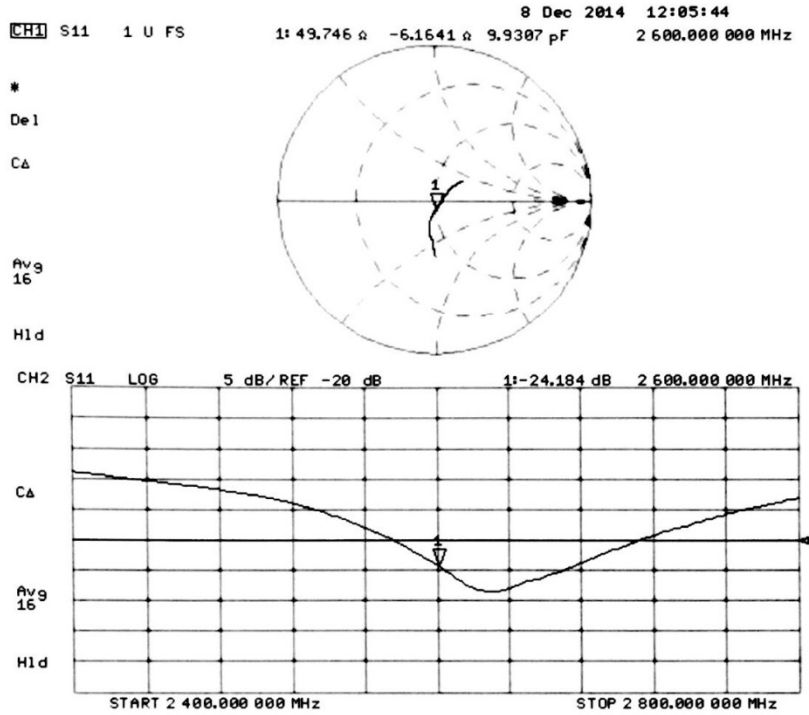

**DASY5 Validation Report for Body TSL**

Date: 08.12.2014

Test Laboratory: SPEAG, Zurich, Switzerland

**DUT: Dipole 2600 MHz; Type: D2600V2; Serial: D2600V2 - SN: 1025**

Communication System: UID 0 - CW; Frequency: 2600 MHz

Medium parameters used:  $f = 2600$  MHz;  $\sigma = 2.22$  S/m;  $\epsilon_r = 50.5$ ;  $\rho = 1000$  kg/m<sup>3</sup>

Phantom section: Flat Section

Measurement Standard: DASY5 (IEEE/IEC/ANSI C63.19-2011)

DASY52 Configuration:

- Probe: ES3DV3 - SN3205; ConvF(4.24, 4.24, 4.24); Calibrated: 30.12.2013;
- Sensor-Surface: 3mm (Mechanical Surface Detection)
- Electronics: DAE4 Sn601; Calibrated: 18.08.2014
- Phantom: Flat Phantom 5.0 (back); Type: QD000P50AA; Serial: 1002
- DASY52 52.8.8(1222); SEMCAD X 14.6.10(7331)

**Dipole Calibration for Body Tissue/Pin=250 mW, d=10mm/Zoom Scan (7x7x7)/Cube 0:**

Measurement grid: dx=5mm, dy=5mm, dz=5mm

Reference Value = 96.72 V/m; Power Drift = 0.02 dB

Peak SAR (extrapolated) = 30.9 W/kg

**SAR(1 g) = 14.4 W/kg; SAR(10 g) = 6.36 W/kg**

Maximum value of SAR (measured) = 19.3 W/kg

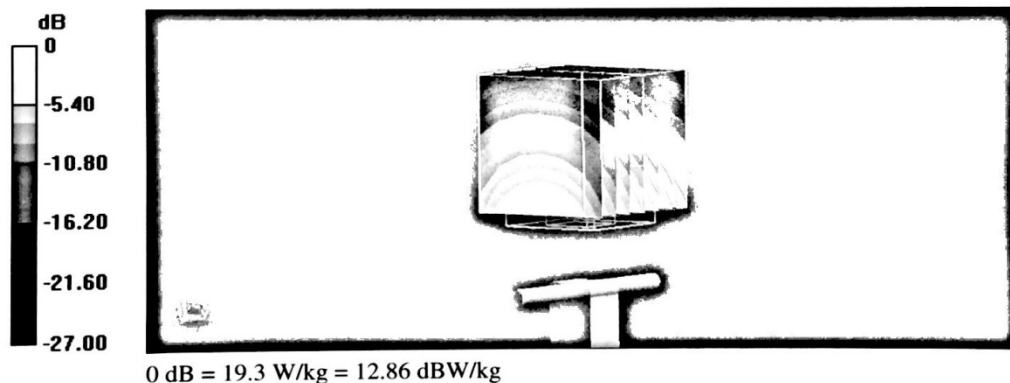



### Impedance Measurement Plot for Body TSL

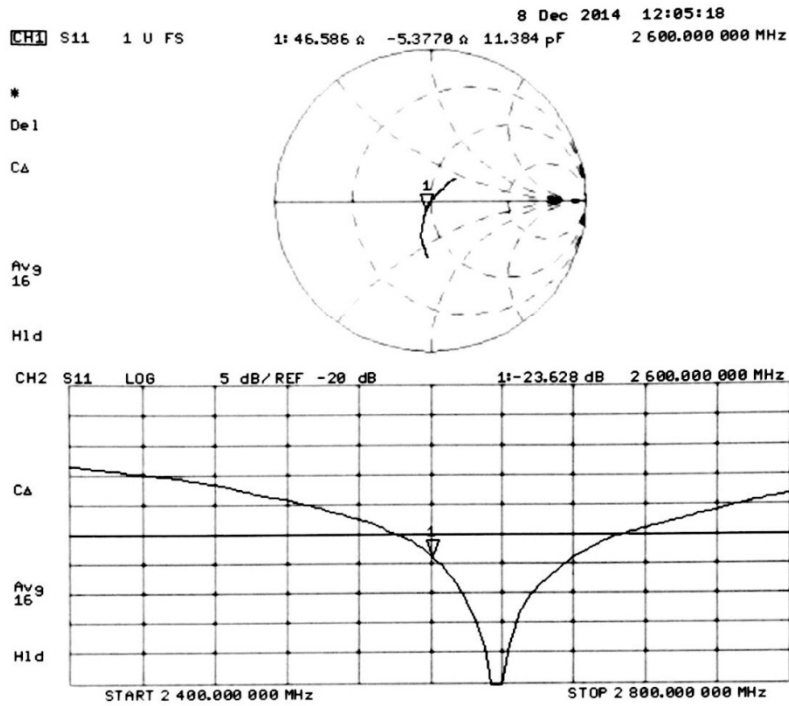



# ANNEX J: DAE4 Calibration Certificate



In Collaboration with  
**s p e a g**  
CALIBRATION LABORATORY



中国认可  
国际互认  
校准  
CALIBRATION  
CNAS L0570

Add: No.51 Xueyuan Road, Haidian District, Beijing, 100191, China  
Tel: +86-10-62304633-2218 Fax: +86-10-62304633-2209  
E-mail: cttl@chinattl.com Http://www.chinattl.cn

Client : **TA(Shanghai)**

Certificate No: **Z17-97011**

## CALIBRATION CERTIFICATE

Object: **DAE4 - SN: 1291**

Calibration Procedure(s): **FD-Z11-002-01  
Calibration Procedure for the Data Acquisition Electronics (DAEx)**

Calibration date: **January 19, 2017**

This calibration Certificate documents the traceability to national standards, which realize the physical units of measurements(SI). The measurements and the uncertainties with confidence probability are given on the following pages and are part of the certificate.

All calibrations have been conducted in the closed laboratory facility: environment temperature(22±3)°C and humidity<70%.

Calibration Equipment used (M&TE critical for calibration)

Primary Standards	ID #	Cal Date(Calibrated by, Certificate No.)	Scheduled Calibration
Process Calibrator 753	1971018	27-June-16 (CTTL, No:J16X04778)	June-17

	Name	Function	Signature
Calibrated by:	Yu Zongying	SAR Test Engineer	
Reviewed by:	Qi Dianyuan	SAR Project Leader	
Approved by:	Lu Bingsong	Deputy Director of the laboratory	

Issued: January 20, 2017

This calibration certificate shall not be reproduced except in full without written approval of the laboratory.



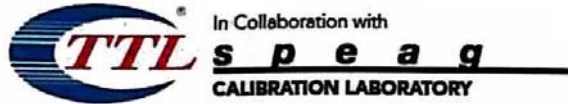

Add: No.51 Xueyuan Road, Haidian District, Beijing, 100191, China  
Tel: +86-10-62304633-2218 Fax: +86-10-62304633-2209  
E-mail: cttl@chinattl.com Http://www.chinattl.cn

**Glossary:**

DAE data acquisition electronics  
Connector angle information used in DASY system to align probe sensor X to the robot coordinate system.

**Methods Applied and Interpretation of Parameters:**

- *DC Voltage Measurement:* Calibration Factor assessed for use in DASY system by comparison with a calibrated instrument traceable to national standards. The figure given corresponds to the full scale range of the voltmeter in the respective range.
- *Connector angle:* The angle of the connector is assessed measuring the angle mechanically by a tool inserted. Uncertainty is not required.
- The report provide only calibration results for DAE, it does not contain other performance test results.

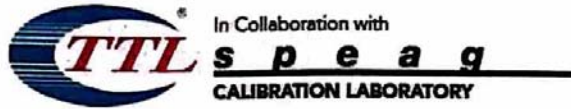

Add: No.51 Xueyuan Road, Haidian District, Beijing, 100191, China  
Tel: +86-10-62304633-2218 Fax: +86-10-62304633-2209  
E-mail: cttl@chinattl.com Http://www.chinattl.cn

### DC Voltage Measurement

A/D - Converter Resolution nominal

High Range: 1LSB = 6.1 $\mu$ V, full range = -100...+300 mV  
Low Range: 1LSB = 61nV, full range = -1.....+3mV

DASY measurement parameters: Auto Zero Time: 3 sec; Measuring time: 3 sec

Calibration Factors	X	Y	Z
High Range	402.659 $\pm$ 0.15% (k=2)	403.334 $\pm$ 0.15% (k=2)	403.248 $\pm$ 0.15% (k=2)
Low Range	3.97545 $\pm$ 0.7% (k=2)	3.93432 $\pm$ 0.7% (k=2)	3.99217 $\pm$ 0.7% (k=2)

### Connector Angle

Connector Angle to be used in DASY system	309 $^{\circ}$ $\pm$ 1 $^{\circ}$
---	-----------------------------------

## ANNEX K: The EUT Appearances and Test Configuration



Front Side



Back Side

Picture 13: Constituents of EUT



Picture 14: Left Hand Touch Cheek Position



Picture 15: Left Hand Tilt 15 Degree Position

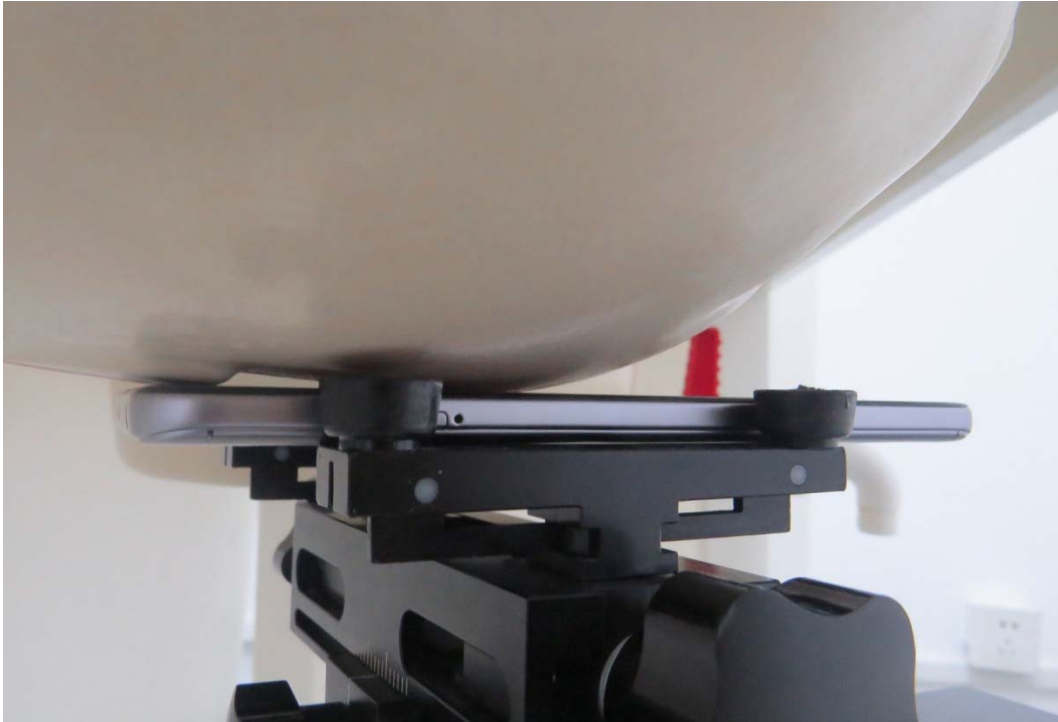

Picture 16: Right Hand Touch Cheek Position

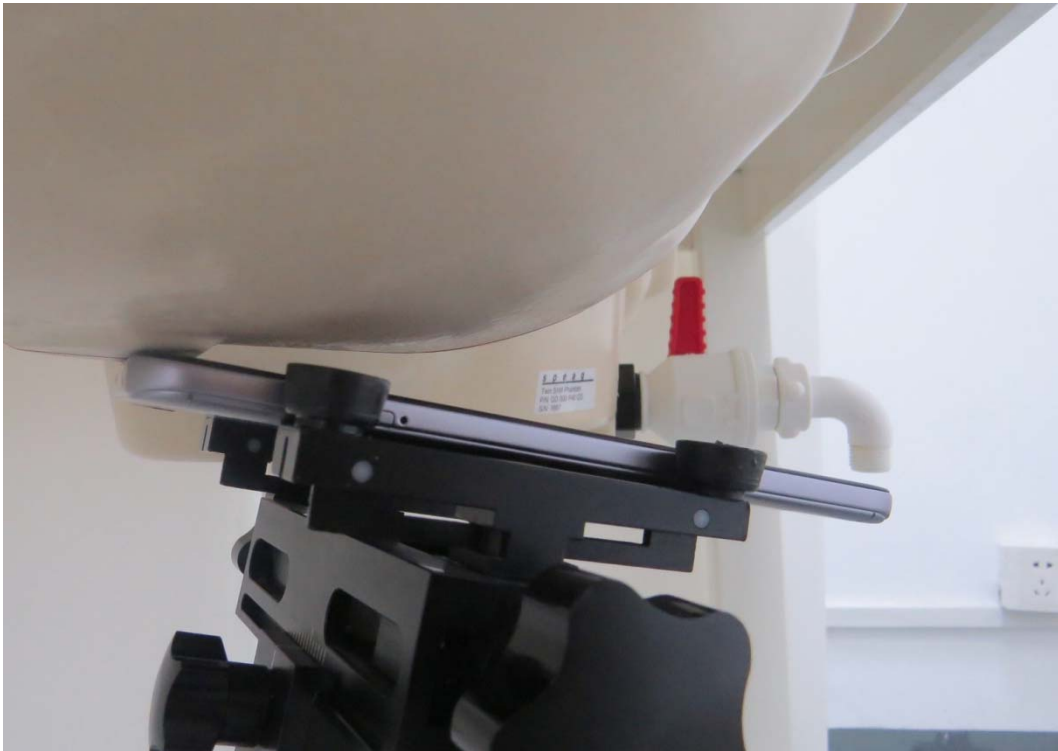

Picture 17: Right Hand Tilt 15 Degree Position

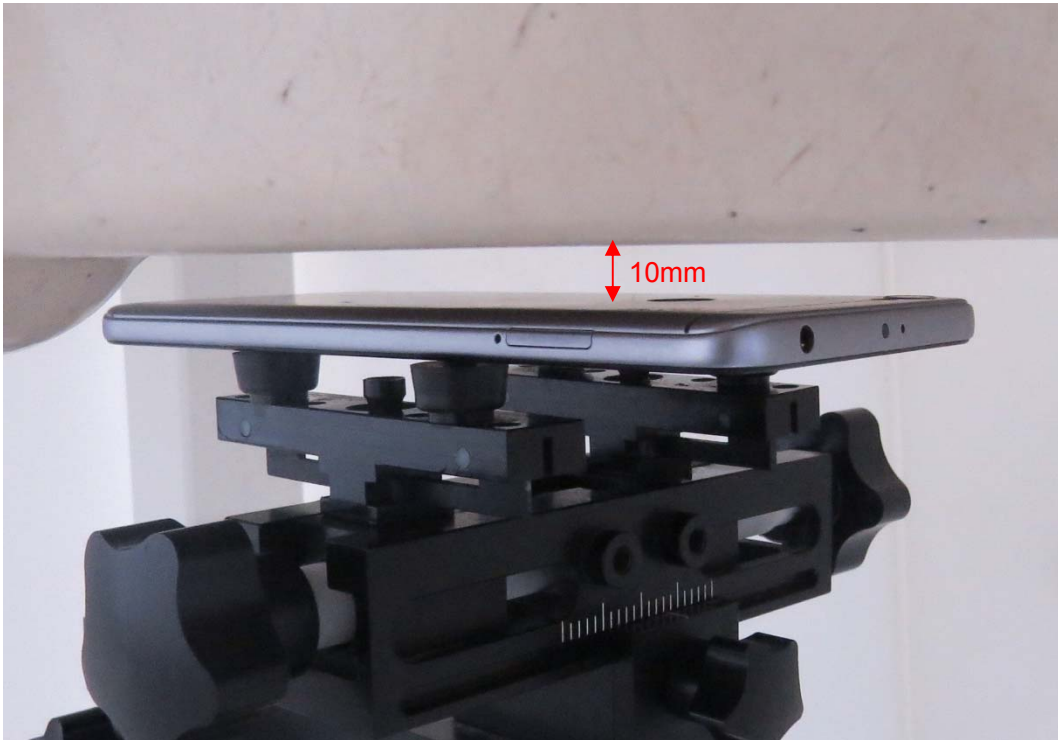

Picture 18: Back Side, the distance from handset to the bottom of the Phantom is 10mm



Picture 19: Front Side, the distance from handset to the bottom of the Phantom is 10mm



Picture 20: Left Side, the distance from handset to the bottom of the Phantom is 10mm



Picture 21: Right Side, the distance from handset to the bottom of the Phantom is 10mm

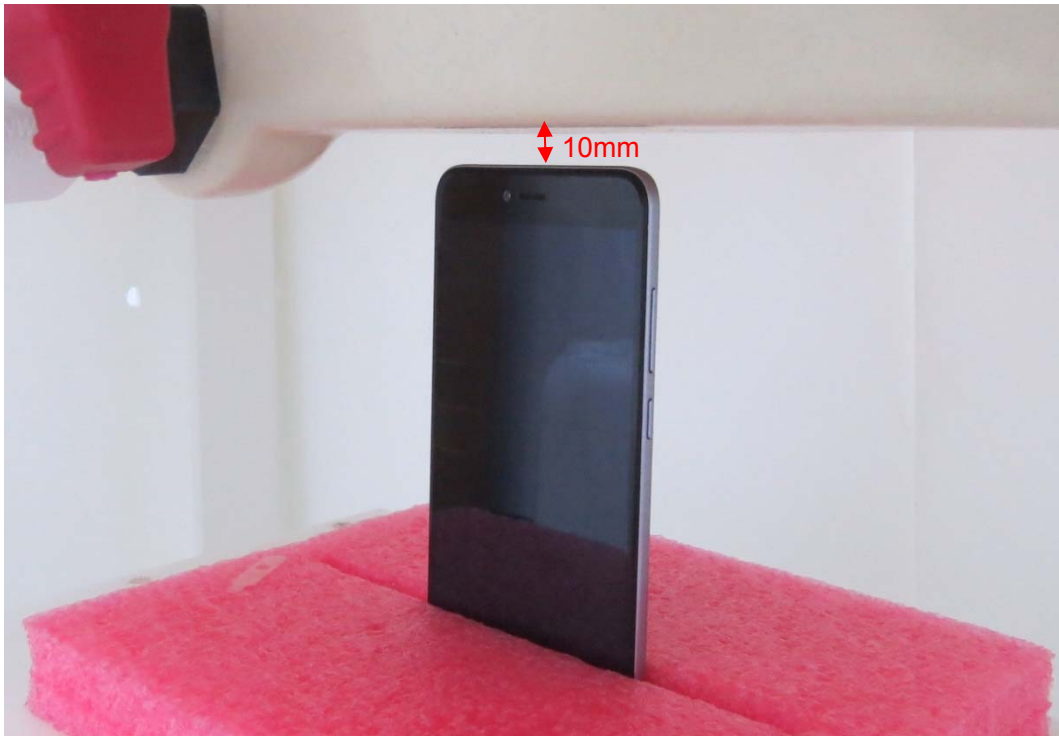

Picture 22: Top Side, the distance from handset to the bottom of the Phantom is 10mm

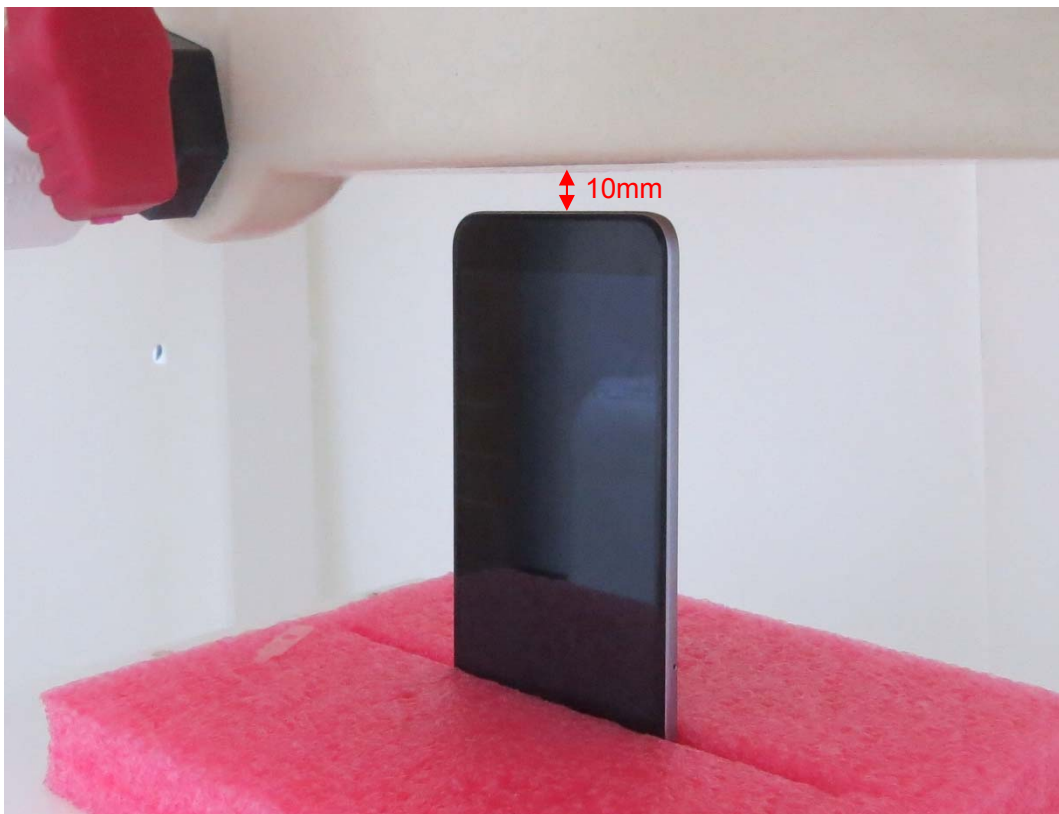

Picture 23: Bottom Side, the distance from handset to the bottom of the Phantom is 10mm