



FCC Test Report

APPLICANT : Xiaomi Communications Co., Ltd.
EQUIPMENT : Mobile Phone
BRAND NAME : MI
FCC ID : 2AFZZ-RMSG6
STANDARD : FCC 47 CFR FCC Part 15 Subpart B
CLASSIFICATION : Certification

The product was received on Jun. 23, 2017 and testing was completed on Jul. 04, 2017. We, Sporton International (KunShan) INC., would like to declare that the tested sample has been evaluated in accordance with the test procedures given in ANSI C63.4-2014 and has been in compliance with the applicable technical standards.

The test results in this report apply exclusively to the tested model / sample. Without written approval of Sporton International (KunShan) INC., the test report shall not be reproduced except in full.

Prepared by: James Huang / Manager

Approved by: Jones Tsai / Manager



Sporton International (KunShan) INC.

No.3-2, Pingxiang Road, Kunshan Development Zone, Jiangsu, China



TABLE OF CONTENTS

REVISION HISTORY..... 3

SUMMARY OF TEST RESULT 4

1. GENERAL DESCRIPTION 5

 1.1. Applicant..... 5

 1.2. Manufacturer 5

 1.3. Product Feature of Equipment Under Test 5

 1.4. Product Specification of Equipment Under Test 6

 1.5. Modification of EUT 6

 1.6. Test Location 7

 1.7. Applicable Standards 7

2. TEST CONFIGURATION OF EQUIPMENT UNDER TEST 8

 2.1. Test Mode 8

 2.2. Connection Diagram of Test System 9

 2.3. Support Unit used in test configuration and system 10

 2.4. EUT Operation Test Setup 11

3. TEST RESULT 12

 3.1. Test of AC Conducted Emission Measurement 12

 3.2. Test of Radiated Emission Measurement 18

4. LIST OF MEASURING EQUIPMENT 24

5. UNCERTAINTY OF EVALUATION 25

APPENDIX A. SETUP PHOTOGRAPHS



REVISION HISTORY

REPORT NO.	VERSION	DESCRIPTION	ISSUED DATE
FC762302	Rev. 01	Initial issue of report	Jul. 12, 2017



SUMMARY OF TEST RESULT

Report Section	FCC Rule	Description	Limit	Result	Remark
3.1	15.107	AC Conducted Emission	< 15.107 limits	PASS	Under limit 10.55 dB at 0.481 MHz
3.2	15.109	Radiated Emission	< 15.109 limits	PASS	Under limit 6.06 dB at 31.890 MHz for Quasi-Peak



1. General Description

1.1. Applicant

Xiaomi Communications Co., Ltd.

The Rainbow City of China Resources,NO.68,Qinghe Middle Street,Haidian District,Beijing,China

1.2. Manufacturer

Xiaomi Communications Co., Ltd.

The Rainbow City of China Resources,NO.68,Qinghe Middle Street,Haidian District,Beijing,China

1.3. Product Feature of Equipment Under Test

Product Feature	
Equipment	Mobile Phone
Brand Name	MI
FCC ID	2AFZZ-RMSG6
EUT supports Radios application	GSM/GPRS/EGPRS/WCDMA/HSPA/DC-HSDPA/HSPA+ (16QAM uplink is not supported)/LTE WLAN 2.4GHz 802.11b/g/n HT20/HT40 Bluetooth v3.0 + EDR/ Bluetooth v4.0 LE/ Bluetooth v4.2 LE
IMEI Code	Conduction: 865395030022923/865395030022931 Radiation: 865395030024580/865395030024598
HW Version	A
SW Version	MIUI 8
EUT Stage	Identical Prototype

Remark: The above EUT's information was declared by manufacturer. Please refer to the specifications or user's manual for more detailed description.

1.4. Product Specification of Equipment Under Test

Standards-related Product Specification	
Tx Frequency	GSM850: 824.2 MHz ~ 848.8 MHz GSM1900: 1850.2 MHz ~ 1909.8MHz WCDMA Band V: 826.4 MHz ~ 846.6 MHz WCDMA Band II: 1852.4 MHz ~ 1907.6 MHz LTE Band 4 : 1710.7 MHz ~ 1754.3 MHz LTE Band 5 : 824.7 MHz ~ 848.3 MHz LTE Band 7 : 2502.5 MHz ~ 2567.5 MHz LTE Band 38 : 2572.5 MHz ~ 2617.5 MHz 802.11b/g/n: 2412 MHz ~ 2462 MHz Bluetooth: 2402 MHz ~ 2480 MHz
Rx Frequency	GSM850: 869.2 MHz ~ 893.8 MHz GSM1900: 1930.2 MHz ~ 1989.8 MHz WCDMA Band V: 871.4 MHz ~ 891.6 MHz WCDMA Band II: 1932.4 MHz ~ 1987.6 MHz LTE Band 4 : 2110.7 MHz ~ 2154.3 MHz LTE Band 5 : 869.7 MHz ~ 893.3 MHz LTE Band 7 : 2622.5 MHz ~ 2687.5 MHz LTE Band 38 : 2572.5 MHz ~ 2617.5 MHz 802.11b/g/n: 2412 MHz ~ 2462 MHz Bluetooth: 2402 MHz ~ 2480 MHz GNSS : 1559 MHz ~ 1610 MHz FM : 88 MHz ~ 108 MHz
Antenna Type	WWAN : LDS Antenna WLAN : PIFA Antenna Bluetooth : PIFA Antenna GNSS: PIFA Antenna FM: External headset Antenna
Type of Modulation	GSM: GMSK GPRS: GMSK EDGE(MCS 0-4): GMSK / (MCS 5-9): 8PSK WCDMA : BPSK (Uplink) HSPA : QPSK (Uplink) HSPA+ : 16QAM (16QAM uplink is not supported) DC-HSDPA : 64QAM LTE: QPSK / 16QAM 802.11b : DSSS (DBPSK / DQPSK / CCK) 802.11g/n : OFDM (BPSK / QPSK / 16QAM / 64QAM) Bluetooth LE : GFSK Bluetooth (1Mbps) : GFSK Bluetooth (2Mbps) : $\pi/4$ -DQPSK Bluetooth (3Mbps) : 8-DPSK GPS : BPSK FM : FM

1.5. Modification of EUT

No modifications are made to the EUT during all test items.



1.6. Test Location

Test Site	Sporton International (KunShan) INC.		
Test Site Location	No.3-2, Pingxiang Road, Kunshan Development Zone, Jiangsu, China TEL: +86-0512-5790-0158 FAX: +86-0512-5790-0958		
Test Site No.	Sporton Site No.		FCC Registration No.
	CO01-KS	03CH03-KS	306251

Note: The test site complies with ANSI C63.4 2014 requirement.

1.7. Applicable Standards

According to the specifications of the manufacturer, the EUT must comply with the requirements of the following standards:

- ♦ FCC 47 CFR FCC Part 15 Subpart B
- ♦ ANSI C63.4-2014

Remark: All test items were verified and recorded according to the standards and without any deviation during the test.

2. Test Configuration of Equipment Under Test

2.1. Test Mode

The EUT has been associated with peripherals pursuant to ANSI C63.4-2014 and configuration operated in a manner tended to maximize its emission characteristics in a typical application.

Frequency range investigated: conduction (150 kHz to 30 MHz), radiation (30MHz to the 5th harmonic of the highest fundamental frequency or to 40 GHz, whichever is lower).

Test Items	Function Type
AC Conducted Emission	Mode 1: GSM850 Idle + Bluetooth Idle + WLAN Idle(2.4G) + USB Cable (Charging from Adapter) + Earphone + Camera(Rear) <Fig.1> Mode 2: GSM1900 Idle + Bluetooth Idle + WLAN Idle(2.4G) + USB Cable (Charging from Adapter) + Earphone + Camera(Front) <Fig.1> Mode 3: WCDMA Band V Idle + Bluetooth Idle + WLAN Idle(2.4G) + USB Cable (Charging from Adapter) + Earphone + MPEG4 <Fig.1> Mode 4: LTE Band 4 Idle + Bluetooth Idle + WLAN Idle(2.4G) + USB Cable (Data Link with Notebook) + Earphone + GNSS RX <Fig.2> Mode 5: FM Rx(88Mhz) + USB Cable (Charging from Adapter) + Earphone <Fig.3> Mode 6: FM Rx(98Mhz) + USB Cable (Charging from Adapter) + Earphone <Fig.3> Mode 7: FM Rx(108Mhz) + USB Cable (Charging from Adapter) + Earphone <Fig.3>
Radiated Emissions	Mode 1: GSM850 Idle + Bluetooth Idle + WLAN Idle(2.4G) + USB Cable (Charging from Adapter) + Earphone + Camera(Rear) <Fig.1> Mode 2: GSM1900 Idle + Bluetooth Idle + WLAN Idle(2.4G) + USB Cable (Charging from Adapter) + Earphone + Camera(Front) <Fig.1> Mode 3: WCDMA Band V Idle + Bluetooth Idle + WLAN Idle(2.4G) + USB Cable (Charging from Adapter) + Earphone + MPEG4 <Fig.1> Mode 4: LTE Band 4 Idle + Bluetooth Idle + WLAN Idle(2.4G) + USB Cable (Data Link with Notebook) + Earphone + GNSS RX <Fig.2> Mode 5: FM Rx(88Mhz) + USB Cable (Charging from Adapter) + Earphone <Fig.3> Mode 6: FM Rx(98Mhz) + USB Cable (Charging from Adapter) + Earphone <Fig.3> Mode 7: FM Rx(108Mhz) + USB Cable (Charging from Adapter) + Earphone <Fig.3>
Remark: <ol style="list-style-type: none"> The worst case of AC is mode 7, and the USB Link mode is mode 4, the test data of these modes are reported. The worst case of RE is mode 6, and the USB Link mode is mode 4, the test data of these modes are reported. Data Link with Notebook means data application transferred mode between EUT and Notebook. 	

2.2. Connection Diagram of Test System

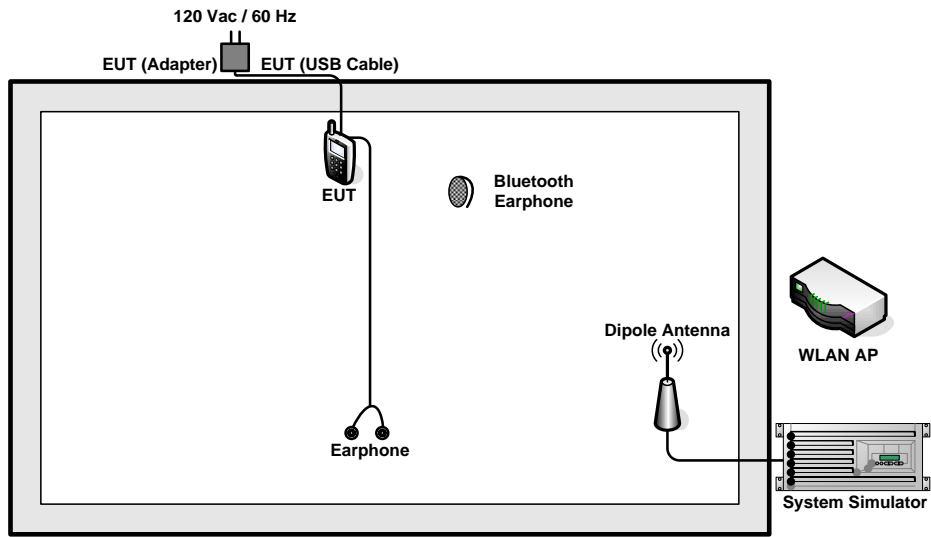

<Fig.1>

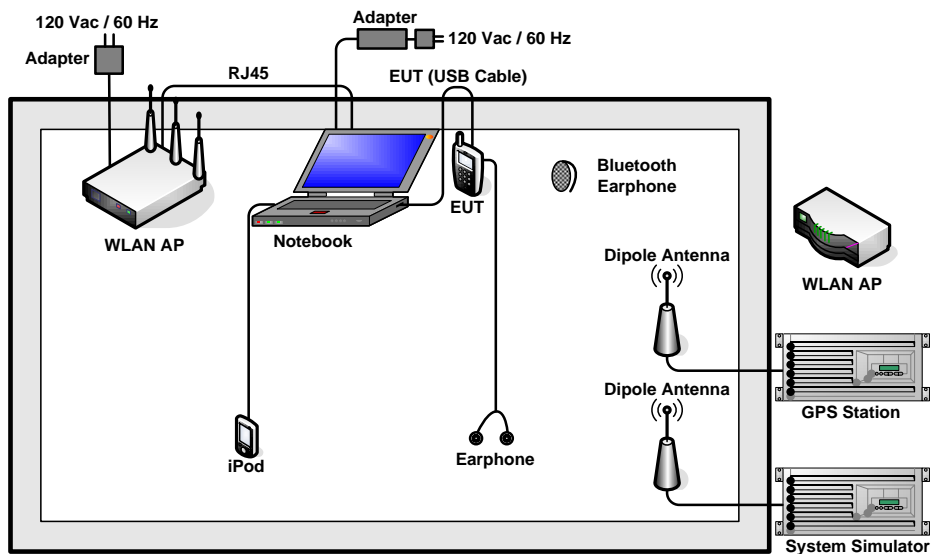

<Fig.2>

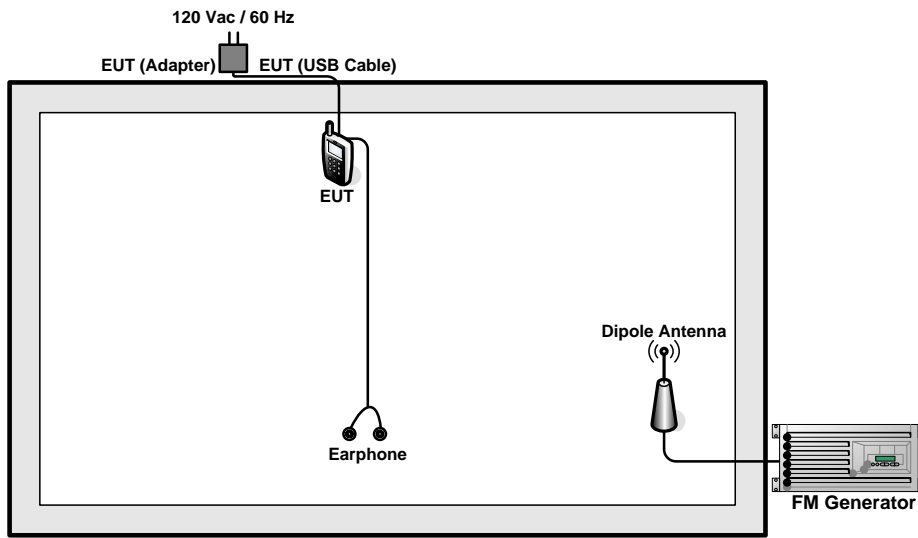

<Fig.3>

2.3. Support Unit used in test configuration and system

Item	Equipment	Trade Name	Model Name	FCC ID	Data Cable	Power Cord
1.	System Simulator	Anritsu	MT8820C	N/A	N/A	Unshielded, 1.8m
2.	GPS Station	ADIVIE	MP9000	N/A	N/A	Unshielded, 1.8m
3.	WLAN AP	ASUS	RT-AC66U	MSQ-RTAC66U	N/A	Unshielded, 1.8m
4.	Bluetooth Earphone	Samsung	HS3000	A3LHS3000	N/A	N/A
5.	Notebook	Lenovo	E540	FCC DoC	N/A	AC I/P : Unshielded, 1.2m DC O/P : Shielded, 1.8m
6.	Earphone	Lenovo	LH102	N/A	Unshielded, 1.2m	N/A
7.	FM Base Station	R&S	SMB100A	FCC DoC	N/A	Unshielded, 1.8m
8.	SD Card	Kingston	MicroSD HC	FCC DoC	N/A	N/A
9.	iPod	Apple	MC525 ZP/A	FCC DoC	Shielded, 1.0m	N/A



2.4. EUT Operation Test Setup

The EUT was in GSM or WCDMA or EDGE or HSDPA idle mode during the testing. The EUT was synchronized to the BCCH, and is in continuous receiving mode by setting system simulator's paging reorganization.

At the same time, the EUT was attached to the Bluetooth earphone or WLAN AP, and the following programs installed in the EUT were programmed during the test.

1. Data application is transferred between Notebook and EUT via USB cable.
2. Turn on GNSS function to make the EUT receive continuous signals from GNSS station.
3. Execute "Video Player" to play MPEG4 files.
4. Turn on camera to capture images.



3. Test Result

3.1. Test of AC Conducted Emission Measurement

3.1.1 Limits of AC Conducted Emission

For equipment that is designed to be connected to the public utility (AC) power line, the radio frequency voltage that is conducted back onto the AC power line on any frequency or frequencies within the band 150 kHz to 30 MHz shall not exceed the limits in the following table.

Frequency of emission (MHz)	Conducted limit (dBuV)	
	Quasi-peak	Average
0.15-0.5	66 to 56*	56 to 46*
0.5-5	56	46
5-30	60	50

*Decreases with the logarithm of the frequency.

3.1.2 Measuring Instruments

The measuring equipment is listed in the section 4 of this test report.

3.1.3 Test Procedure

1. The EUT was placed 0.4 meter from the conducting wall of the shielding room was kept at least 80 centimeters from any other grounded conducting surface.
2. Connect EUT to the power mains through a line impedance stabilization network (LISN).
3. All the support units are connecting to the other LISN.
4. The LISN provides 50 ohm coupling impedance for the measuring instrument.
5. The FCC states that a 50 ohm, 50 microhenry LISN should be used.
6. Both sides of AC line were checked for maximum conducted interference.
7. The frequency range from 150 kHz to 30 MHz was searched.
8. Set the test-receiver system to Peak Detect Function and specified bandwidth (IF Bandwidth = 9kHz) with Maximum Hold Mode. Then measurement is also conducted by Average Detector and Quasi-Peak Detector Function respectively.

3.1.4 Test Setup





3.1.5 Test Result of AC Conducted Emission

Test Mode :	Mode 4	Temperature :	22~24°C
Test Engineer :	Amos Zhang	Relative Humidity :	42~46%
Test Voltage :	120Vac / 60Hz	Phase :	Line
Function Type :	LTE Band 4 Idle + Bluetooth Idle + WLAN Idle(2.4G) + USB Cable (Data Link with Notebook) + Earphone + GNSS RX		

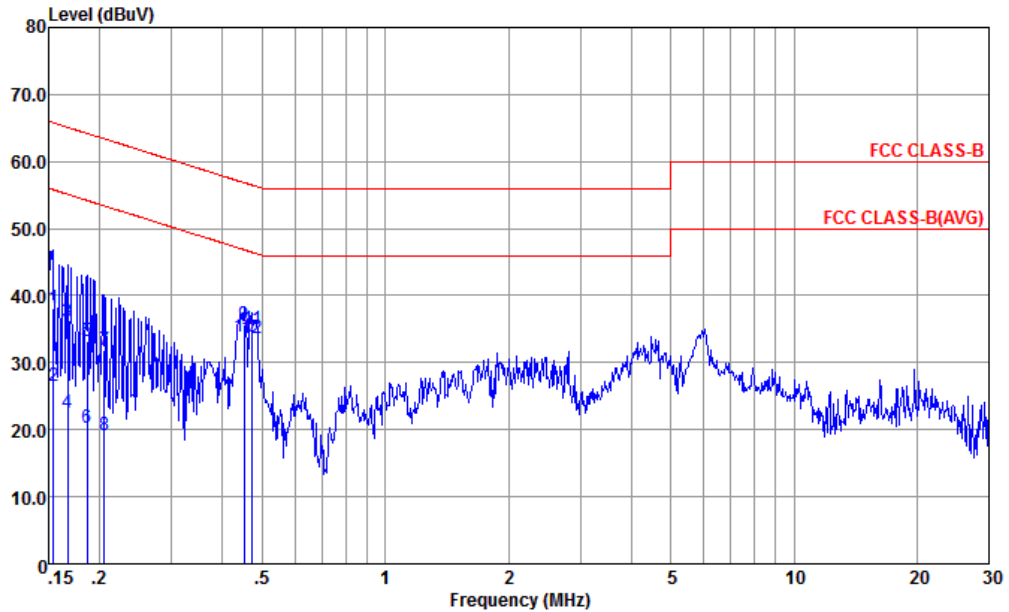

Site : CO01-KS
 Condition : FCC CLASS-B LISN-L-161017-060103 LINE
 mode : Mode 4
 : 865395030022923/865395030022931 #2

	Freq	Level	Over Limit	Limit	Read	LISN	Cable	Remark
	MHz	dBuV		dB	dBuV	dB	dB	
1	0.154	38.21	-27.57	65.78	27.29	0.53	10.39	QP
2	0.154	26.51	-29.27	55.78	15.59	0.53	10.39	Average
3	0.167	36.12	-29.00	65.12	25.30	0.45	10.37	QP
4	0.167	22.42	-32.70	55.12	11.60	0.45	10.37	Average
5	0.186	33.28	-30.92	64.20	22.60	0.33	10.35	QP
6	0.186	20.18	-34.02	54.20	9.50	0.33	10.35	Average
7	0.205	31.80	-31.60	63.40	21.20	0.27	10.33	QP
8	0.205	19.20	-34.20	53.40	8.60	0.27	10.33	Average
9	0.452	35.76	-21.09	56.85	25.30	0.27	10.19	QP
10	0.452	33.96	-12.89	46.85	23.50	0.27	10.19	Average
11	0.474	35.06	-21.39	56.45	24.60	0.27	10.19	QP
12 *	0.474	33.76	-12.69	46.45	23.30	0.27	10.19	Average



Test Mode :	Mode 4	Temperature :	22~24°C
Test Engineer :	Amos Zhang	Relative Humidity :	42~46%
Test Voltage :	120Vac / 60Hz	Phase :	Neutral
Function Type :	LTE Band 4 Idle + Bluetooth Idle + WLAN Idle(2.4G) + USB Cable (Data Link with Notebook) + Earphone + GNSS RX		

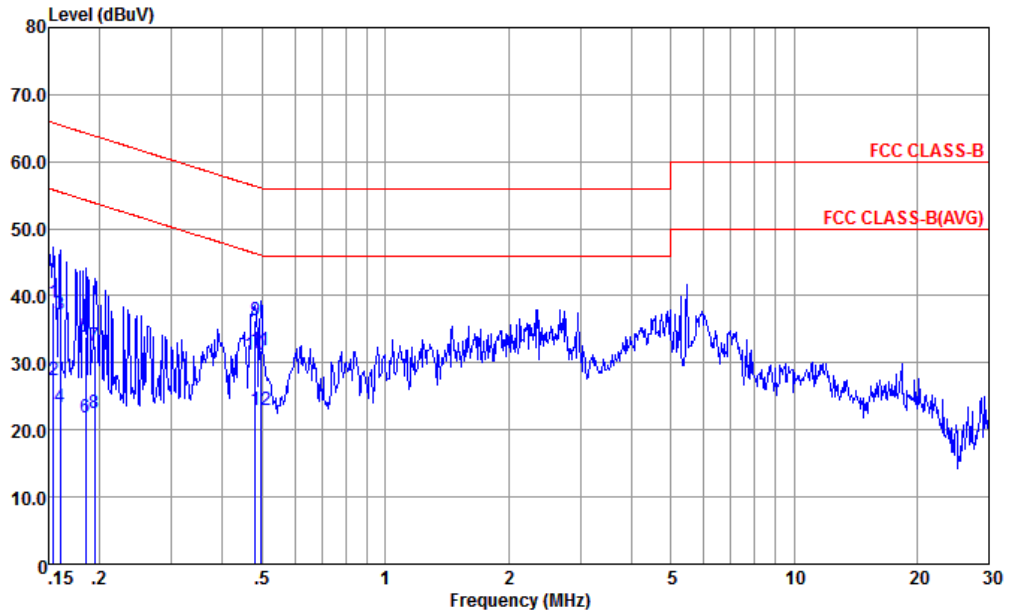

Site : CO01-KS
 Condition : FCC CLASS-B LISN-N-161017-060103 NEUTRAL

mode : Mode 4
 : 865395030022923/865395030022931 #2

	Freq	Level	Over Limit	Limit Line	Read Level	LISN Factor	Cable Loss	Remark
	MHz	dBuV	dB	dBuV	dBuV	dB	dB	
1	0.154	39.03	-26.75	65.78	28.30	0.34	10.39	QP
2	0.154	27.33	-28.45	55.78	16.60	0.34	10.39	Average
3	0.160	37.32	-28.15	65.47	26.60	0.34	10.38	QP
4	0.160	23.32	-32.15	55.47	12.60	0.34	10.38	Average
5	0.184	33.98	-30.30	64.28	23.30	0.33	10.35	QP
6	0.184	21.88	-32.40	54.28	11.20	0.33	10.35	Average
7	0.194	32.47	-31.37	63.84	21.80	0.33	10.34	QP
8	0.194	22.57	-31.27	53.84	11.90	0.33	10.34	Average
9	0.481	36.37	-19.95	56.32	25.80	0.38	10.19	QP
10 *	0.481	31.17	-15.15	46.32	20.60	0.38	10.19	Average
11	0.494	31.77	-24.33	56.10	21.20	0.38	10.19	QP
12	0.494	22.87	-23.23	46.10	12.30	0.38	10.19	Average



Test Mode :	Mode 7	Temperature :	22~24°C
Test Engineer :	Amos Zhang	Relative Humidity :	42~46%
Test Voltage :	120Vac / 60Hz	Phase :	Line
Function Type :	FM Rx(108Mhz) + USB Cable (Charging from Adapter) + Earphone		

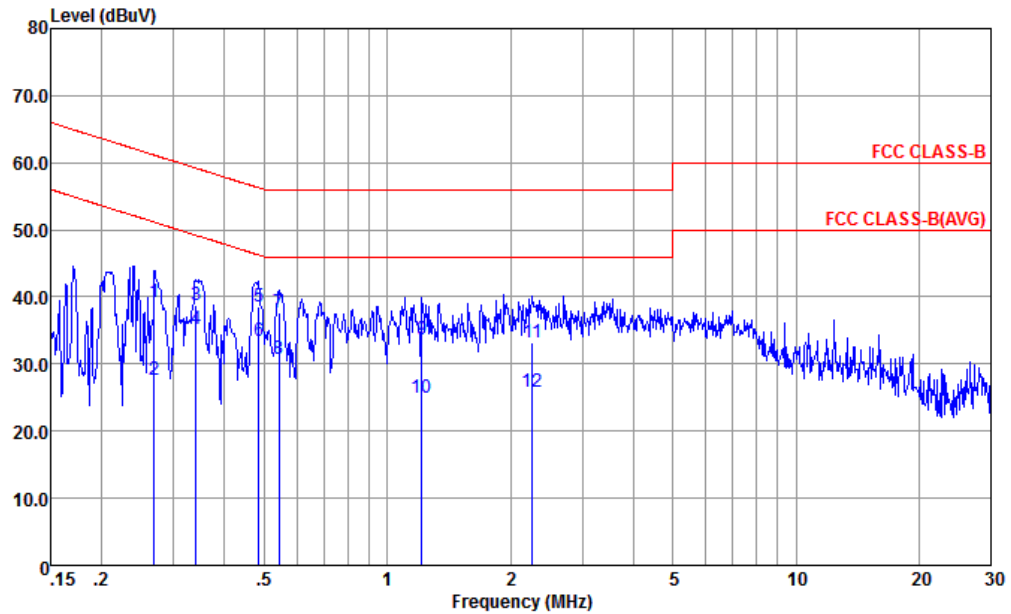

Site : CO01-KS
 Condition : FCC CLASS-B LISN-L-161017-060103 LINE

mode : Mode 7
 : 865395030022923/865395030022931 #2

	Freq	Level	Over Limit	Limit Line	Read Level	LISN Factor	Cable Loss	Remark
	MHz	dBuV	dB	dBuV	dBuV	dB	dB	
1	0.269	39.15	-22.01	61.16	28.60	0.27	10.28	QP
2	0.269	27.65	-23.51	51.16	17.10	0.27	10.28	Average
3	0.341	38.70	-20.48	59.18	28.20	0.27	10.23	QP
4	0.341	35.10	-14.08	49.18	24.60	0.27	10.23	Average
5	0.484	38.66	-17.61	56.27	28.20	0.27	10.19	QP
6 *	0.484	33.36	-12.91	46.27	22.90	0.27	10.19	Average
7	0.544	37.75	-18.25	56.00	27.30	0.26	10.19	QP
8	0.544	30.75	-15.25	46.00	20.30	0.26	10.19	Average
9	1.216	33.74	-22.26	56.00	23.30	0.25	10.19	QP
10	1.216	24.94	-21.06	46.00	14.50	0.25	10.19	Average
11	2.261	33.21	-22.79	56.00	22.80	0.21	10.20	QP
12	2.261	25.91	-20.09	46.00	15.50	0.21	10.20	Average



Test Mode :	Mode 7	Temperature :	22~24°C
Test Engineer :	Amos Zhang	Relative Humidity :	42~46%
Test Voltage :	120Vac / 60Hz	Phase :	Neutral
Function Type :	FM Rx(108Mhz) + USB Cable (Charging from Adapter) + Earphone		

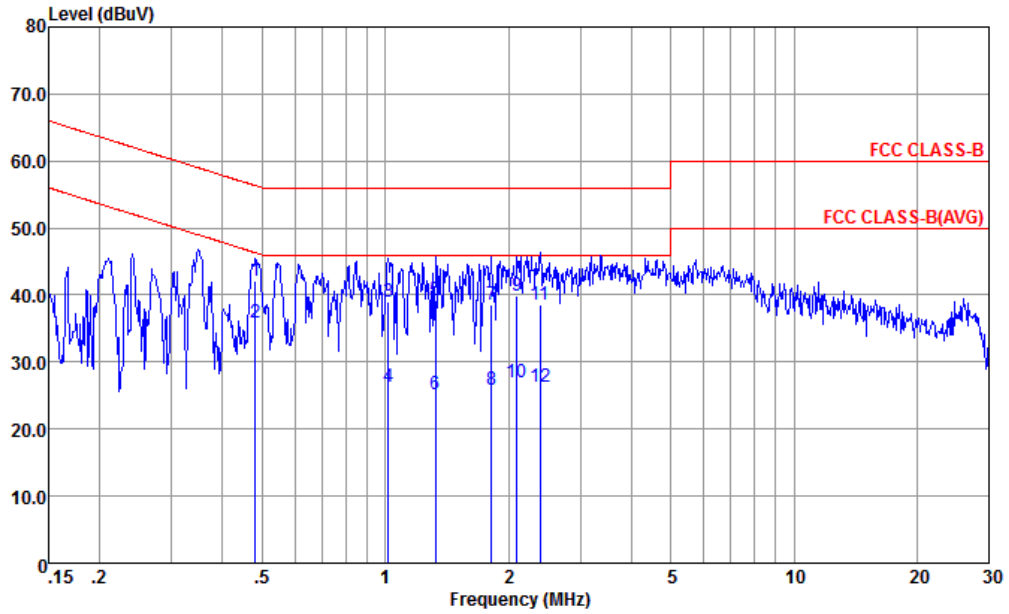

Site : CO01-KS
 Condition : FCC CLASS-B LISN-N-161017-060103 NEUTRAL

mode : Mode 7
 : 865395030022923/865395030022931 #2

	Freq	Level	Over Limit	Limit Line	Read Level	LISN Factor	Cable Loss	Remark
	MHz	dBuV	dB	dBuV	dBuV	dB	dB	
1	0.481	42.17	-14.15	56.32	31.60	0.38	10.19	QP
2 *	0.481	35.77	-10.55	46.32	25.20	0.38	10.19	Average
3	1.016	38.89	-17.11	56.00	28.30	0.40	10.19	QP
4	1.016	26.19	-19.81	46.00	15.60	0.40	10.19	Average
5	1.324	39.19	-16.81	56.00	28.60	0.40	10.19	QP
6	1.324	25.09	-20.91	46.00	14.50	0.40	10.19	Average
7	1.819	38.50	-17.50	56.00	27.90	0.41	10.19	QP
8	1.819	25.90	-20.10	46.00	15.30	0.41	10.19	Average
9	2.099	39.90	-16.10	56.00	29.30	0.41	10.19	QP
10	2.099	26.90	-19.10	46.00	16.30	0.41	10.19	Average
11	2.396	38.50	-17.50	56.00	27.90	0.40	10.20	QP
12	2.396	26.20	-19.80	46.00	15.60	0.40	10.20	Average



3.2. Test of Radiated Emission Measurement

3.2.1. Limit of Radiated Emission

The emissions from an unintentional radiator shall not exceed the field strength levels specified in the following table:

Frequency (MHz)	Field Strength (microvolts/meter)	Measurement Distance (meters)
30 – 88	100	3
88 – 216	150	3
216 - 960	200	3
Above 960	500	3

3.2.2. Measuring Instruments

The measuring equipment is listed in the section 4 of this test report.

3.2.3. Test Procedures

1. The EUT was placed on a turntable with 0.8 meter above ground.
2. The EUT was set 3 meters from the interference receiving antenna, which was mounted on the top of a variable height antenna tower.
3. The table was rotated 360 degrees to determine the position of the highest radiation.
4. The antenna is a Bi-Log antenna and its height is adjusted between one to four meters above ground to find the maximum value of the field strength for both horizontal polarization and vertical polarization of the antenna.
5. For each suspected emission, the EUT was arranged to its worst case and then tune the antenna tower (from 1 m to 4 m) and turntable (from 0 degree to 360 degrees) to find the maximum reading.
6. Set the test-receiver system to Peak Detect Function and specified bandwidth with Maximum Hold Mode (RBW=120kHz/VBW=300kHz for frequency below 1GHz; RBW=1MHz VBW=3MHz (Peak), RBW=1MHz/VBW=10Hz (Average) for frequency above 1GHz).
7. If the emission level of the EUT in peak mode was 3 dB lower than the limit specified, peak values of EUT will be reported. Otherwise, the emission will be repeated by using the quasi-peak method and reported.
8. Emission level (dBµV/m) = 20 log Emission level (µV/m)
9. Corrected Reading: Antenna Factor + Cable Loss + Read Level - Preamp Factor = Level

3.2.4. Test Setup of Radiated Emission

For radiated emissions from 30MHz to 1GHz



For radiated emissions above 1GHz

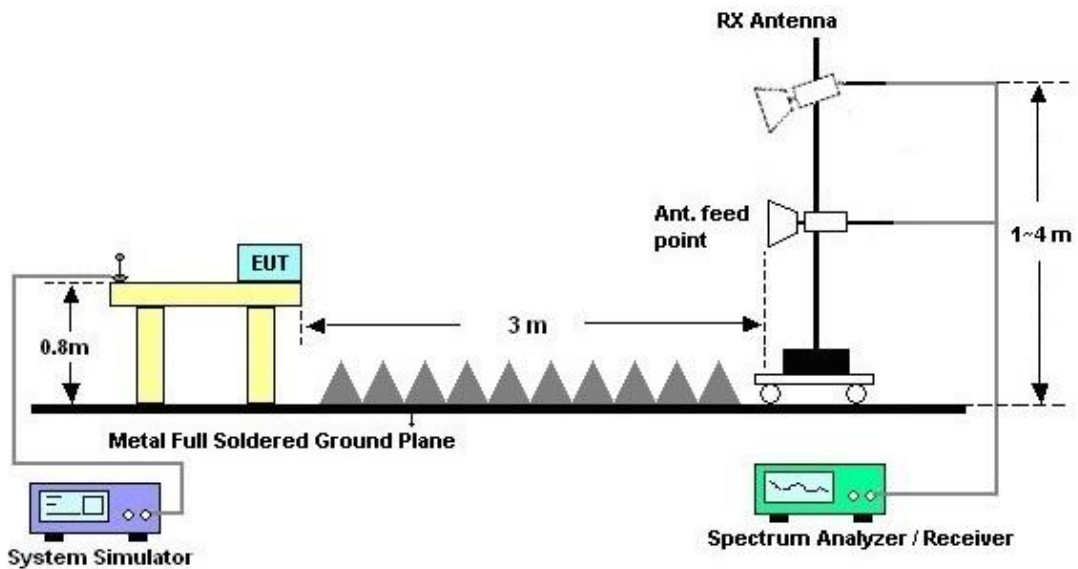



3.2.5. Test Result of Radiated Emission

Test Mode :	Mode 4	Temperature :	24~25°C
Test Engineer :	Clear Peng	Relative Humidity :	48~49%
Test Distance :	3m	Polarization :	Horizontal
Function Type :	LTE Band 4 Idle + Bluetooth Idle + WLAN Idle(2.4G) + USB Cable (Data Link with Notebook) + Earphone + GNSS RX		
Remark :	#7 is system simulator signal which can be ignored. #8, #9 are signals from BT/WLAN access point which can be ignored.		

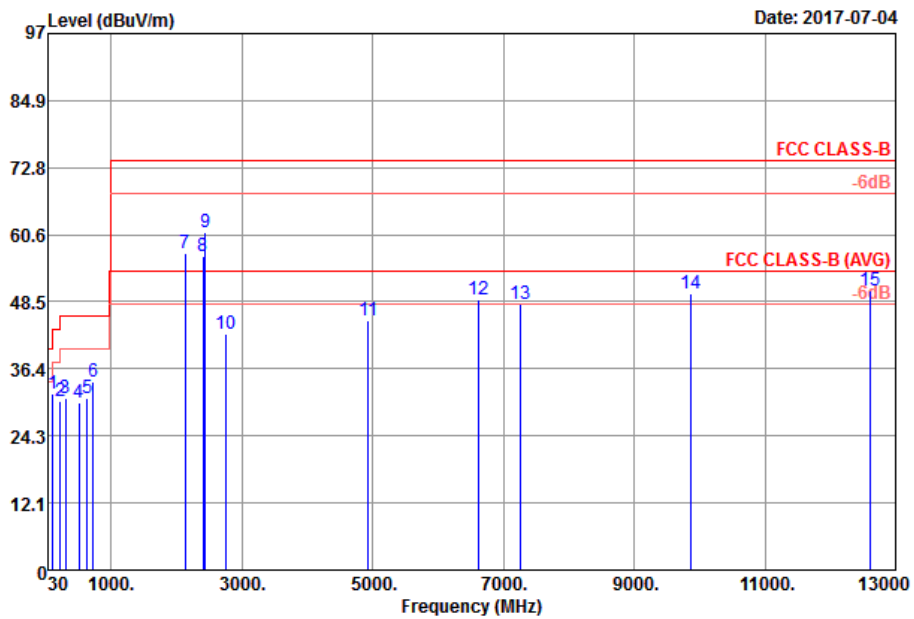

Site : 03CH03-SZ
Condition : FCC CLASS-B 3m HF_ANT(3117)_119436 HORIZONTAL

Mode : Mode 4
IMEI : 865395030024580/865395030024598
Plane : Y

	Freq	Level	Over	Limit	ReadAntenna	Cable	Preamp	A/Pos	T/Pos	Remark	
	MHz	dBuV/m	dB	dBuV/m	dBuV	dB/m	dB	dB	cm	deg	
1	99.93	31.93	-11.57	43.50	43.38	19.30	0.85	31.60	100	140 Peak	
2	214.14	30.48	-13.02	43.50	43.46	16.50	1.69	31.17	---	---	Peak
3	299.73	31.12	-14.88	46.00	41.88	18.50	2.04	31.30	---	---	Peak
4	500.20	30.20	-15.80	46.00	35.79	23.10	2.71	31.40	---	---	Peak
5	628.30	31.17	-14.83	46.00	34.24	25.34	3.09	31.50	---	---	Peak
6	720.00	34.03	-11.97	46.00	34.92	27.27	3.34	31.50	---	---	Peak
7	2132.00	57.24			78.48	29.57	6.29	57.10	---	---	Peak
8	2402.00	56.74			75.34	31.38	6.81	56.79	---	---	Peak
9	2438.00	61.18			79.31	31.74	6.86	56.73	---	---	Peak
10	2752.00	42.70	-31.30	74.00	59.45	32.60	7.40	56.75	---	---	Peak
11	4928.00	45.20	-28.80	74.00	56.93	33.36	10.99	56.08	---	---	Peak
12	6610.00	48.89	-25.11	74.00	54.75	35.98	15.58	57.42	---	---	Peak
13	7250.00	48.04	-25.96	74.00	57.27	35.49	13.46	58.18	---	---	Peak
14	9866.00	49.98	-24.02	74.00	54.60	37.67	13.93	56.22	---	---	Peak
15	12614.00	50.45	-23.55	74.00	54.00	38.89	15.08	57.52	100	145 Peak	



Test Mode :	Mode 4	Temperature :	24~25°C
Test Engineer :	Clear Peng	Relative Humidity :	48~49%
Test Distance :	3m	Polarization :	Vertical
Function Type :	LTE Band 4 Idle + Bluetooth Idle + WLAN Idle(2.4G) + USB Cable (Data Link with Notebook) + Earphone + GNSS RX		
Remark :	#7 is system simulator signal which can be ignored. #8, #9 are signals from BT/WLAN access point which can be ignored.		

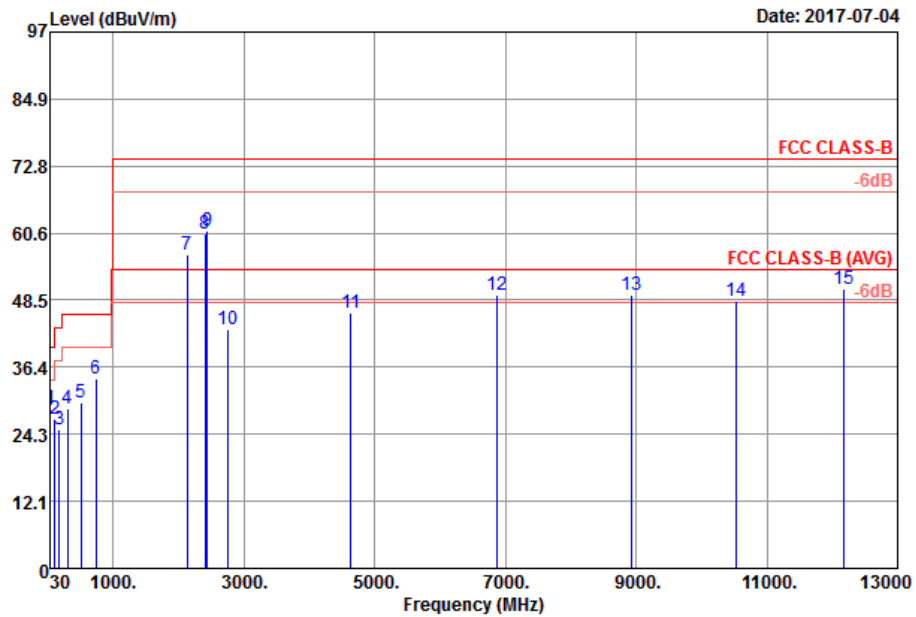

Site : 03CH03-SZ
Condition : FCC CLASS-B 3m HF_ANT(3117)_119436 VERTICAL

Mode : Mode 4
IMEI : 865395030024580/865395030024598
Plane : Y

	Freq	Level	Over	Limit	ReadAntenna	Cable	Preamp	A/Pos	T/Pos	Remark
	MHz	dBuV/m	Limit	Line	Level	Loss	Factor	cm	deg	
			dB	dBuV/m	dBuV	dB/m	dB	dB		
1	41.34	28.81	-11.19	40.00	38.52	21.34	0.40	31.45	200	189 Peak
2	99.66	26.99	-16.51	43.50	38.44	19.30	0.85	31.60	---	---
3	178.50	25.11	-18.39	43.50	37.96	16.96	1.47	31.28	---	---
4	300.00	28.91	-17.09	46.00	39.67	18.50	2.04	31.30	---	---
5	499.50	30.02	-15.98	46.00	35.58	23.13	2.71	31.40	---	---
6	735.40	34.37	-11.63	46.00	34.82	27.65	3.40	31.50	---	---
7	2132.00	56.87			78.11	29.57	6.29	57.10	---	---
8	2402.00	60.54			79.14	31.38	6.81	56.79	---	---
9	2438.00	61.01			79.14	31.74	6.86	56.73	---	---
10	2752.00	43.23	-30.77	74.00	59.98	32.60	7.40	56.75	---	---
11	4632.00	46.23	-27.77	74.00	59.43	33.18	10.68	57.06	---	---
12	6866.00	49.48	-24.52	74.00	55.79	35.93	15.59	57.83	---	---
13	8932.00	49.49	-24.51	74.00	55.23	36.47	12.81	55.02	---	---
14	10526.00	48.27	-25.73	74.00	52.25	37.90	14.65	56.53	---	---
15	12166.00	50.41	-23.59	74.00	53.56	38.80	15.02	56.97	120	130 Peak



Test Mode :	Mode 6	Temperature :	24~25°C
Test Engineer :	Clear Peng	Relative Humidity :	48~49%
Test Distance :	3m	Polarization :	Horizontal
Function Type :	FM Rx(98Mhz) + USB Cable (Charging from Adapter) + Earphone		
Remark :	#2 is Base station (FM option) signal which can be ignored.		

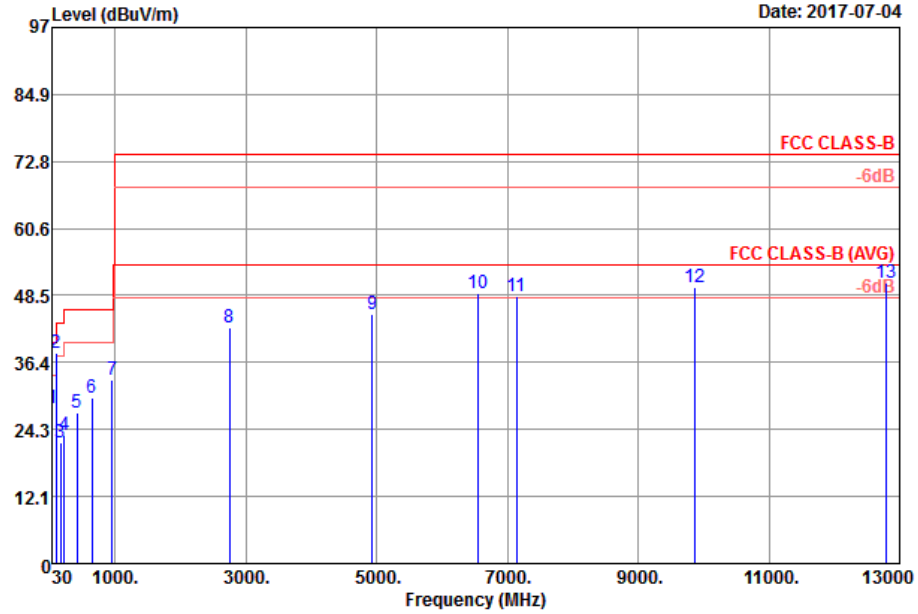

Site : 03CH03-SZ
 Condition : FCC CLASS-B 3m HF_ANT(3117)_119436 HORIZONTAL

Mode : Mode 6
 IMEI : 865395030024580/865395030024598
 Plane : Y

	Freq	Level	Over	Limit	ReadAntenna	Cable	Preamp	A/Pos	T/Pos	Remark	
	MHz	dBuV/m	dB	dBuV/m	dBuV	dB/m	dB	dB	cm	deg	
1	31.62	28.11	-11.89	40.00	33.49	26.00	0.27	31.65	130	168	Peak
2	98.04	38.05			50.04	18.78	0.83	31.60	---	---	Peak
3	162.57	22.00	-21.50	43.50	34.36	17.59	1.39	31.34	---	---	Peak
4	213.60	23.12	-20.38	43.50	36.13	16.48	1.68	31.17	---	---	Peak
5	414.10	27.35	-18.65	46.00	32.14	24.07	2.44	31.30	---	---	Peak
6	642.30	30.06	-15.94	46.00	32.92	25.51	3.13	31.50	---	---	Peak
7	948.20	33.11	-12.89	46.00	31.00	29.67	3.94	31.50	---	---	Peak
8	2752.00	42.70	-31.30	74.00	59.45	32.60	7.40	56.75	---	---	Peak
9	4928.00	45.20	-28.80	74.00	56.93	33.36	10.99	56.08	---	---	Peak
10	6552.00	49.02	-24.98	74.00	55.02	35.99	15.35	57.34	---	---	Peak
11	7144.00	48.24	-25.76	74.00	56.88	35.68	13.75	58.07	---	---	Peak
12	9866.00	49.98	-24.02	74.00	54.60	37.67	13.93	56.22	---	---	Peak
13	12786.00	50.79	-23.21	74.00	53.98	39.03	15.10	57.32	100	253	Peak



Test Mode :	Mode 6	Temperature :	24~25°C
Test Engineer :	Clear Peng	Relative Humidity :	48~49%
Test Distance :	3m	Polarization :	Vertical
Function Type :	FM Rx(98Mhz) + USB Cable (Charging from Adapter) + Earphone		
Remark :	#2 is Base station (FM option) signal which can be ignored.		

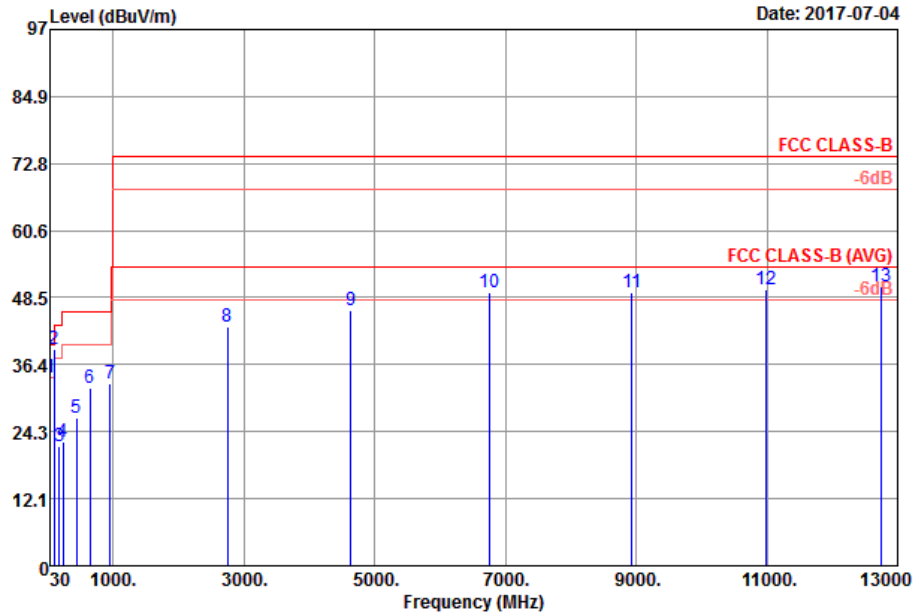

Site : 03CH03-SZ
 Condition : FCC CLASS-B 3m HF_ANT(3117)_119436 VERTICAL
 Mode : Mode 6
 IMEI : 865395030024580/865395030024598
 Plane : Y

	Freq	Level	Over	Limit	ReadAntenna	Cable	Preamp	A/Pos	T/Pos	Remark	
	MHz	dBuV/m	dB	dBuV/m	dBuV	dB/m	dB	dB	cm	deg	
1	31.89	33.94	-6.06	40.00	39.32	26.00	0.27	31.65	100	360 QP	
2	98.04	39.04			51.03	18.78	0.83	31.60	---	---	Peak
3	177.42	21.71	-21.79	43.50	34.52	17.00	1.47	31.28	---	---	Peak
4	230.34	22.56	-23.44	46.00	34.97	16.96	1.77	31.14	---	---	Peak
5	439.30	26.83	-19.17	46.00	31.23	24.37	2.53	31.30	---	---	Peak
6	638.10	32.19	-13.81	46.00	35.11	25.46	3.12	31.50	---	---	Peak
7	947.50	32.92	-13.08	46.00	30.83	29.65	3.94	31.50	---	---	Peak
8	2752.00	43.23	-30.77	74.00	59.98	32.60	7.40	56.75	---	---	Peak
9	4632.00	46.23	-27.77	74.00	59.43	33.18	10.68	57.06	---	---	Peak
10	6766.00	49.49	-24.51	74.00	55.41	35.95	15.80	57.67	---	---	Peak
11	8932.00	49.49	-24.51	74.00	55.23	36.47	12.81	55.02	---	---	Peak
12	10988.00	49.93	-24.07	74.00	52.77	38.00	14.76	55.60	---	---	Peak
13	12748.00	50.52	-23.48	74.00	53.78	39.00	15.10	57.36	120	315	Peak



4. List of Measuring Equipment

Instrument	Manufacturer	Model No.	Serial No.	Characteristics	Calibration Date	Test Date	Due Date	Remark
EMI Receiver	R&S	ESCI7	100768	9kHz~7GHz;	Apr. 20, 2017	Jul. 02, 2017	Apr. 19, 2018	Conduction (CO01-KS)
AC LISN	MessTec	AN3016	060103	9kHz~30MHz	Oct. 13, 2016	Jul. 02, 2017	Oct. 12, 2017	Conduction (CO01-KS)
AC LISN (for auxiliary equipment)	MessTec	AN3016	060105	9kHz~30MHz	Oct. 13, 2016	Jul. 02, 2017	Oct. 12, 2017	Conduction (CO01-KS)
AC Power Source	Chroma	61602	ABP0000008 11	AC 0V~300V, 45Hz~1000Hz	Oct. 13, 2016	Jul. 02, 2017	Oct. 12, 2017	Conduction (CO01-KS)
EMI Test Receiver	Keysight	N9038A	MY56400004	3Hz~8.5GHz;M ax 30dBm	Oct. 22.2016	Jul. 04, 2017	Oct. 21.2017	Radiation (03CH03-KS)
EXA Spectrum Analyzer	Keysight	N9010A	MY55150244	10Hz~44GHz	Apr. 18, 2017	Jul. 04, 2017	Apr.17, 2018	Radiation (03CH03-KS)
Bilog Antenna	TeseQ	CBL6112D	35406	25MHz~2GHz	Apr. 22, 2017	Jul. 04, 2017	Apr 21, 2018	Radiation (03CH03-KS)
Horn Antenna	Schwarzbeck	BBHA9120D	9120D-1356	1GHz~18GHz	Apr. 22, 2017	Jul. 04, 2017	Apr 21, 2018	Radiation (03CH03-KS)
Amplifier	com-power	PA-103A	161069	1MHz ~1000MHz / 32 dB	Apr 18, 2017	Jul. 04, 2017	Apr 17, 2018	Radiation (03CH03-KS)
Amplifier	Agilent	8449B	3008A02370	1GHz~26.5GHz	Oct. 13, 2016	Jul. 04, 2017	Oct. 12, 2017	Radiation (03CH03-KS)
AC Power Source	Chroma	61601	F104090004	N/A	NCR	Jul. 04, 2017	NCR	Radiation (03CH03-KS)
Turn Table	ChamPro	EM 1000-T	060762-T	0~360 degree	NCR	Jul. 04, 2017	NCR	Radiation (03CH03-KS)
Antenna Mast	ChamPro	EM 1000-A	060762-A	1 m~4 m	NCR	Jul. 04, 2017	NCR	Radiation (03CH03-KS)

NCR: No Calibration Required



5. Uncertainty of Evaluation

Uncertainty of Conducted Emission Measurement (150 kHz ~ 30 MHz)

Measuring Uncertainty for a Level of Confidence of 95% ($U = 2Uc(y)$)	2.3dB
-------------------------------------------------------------------------	-------

Uncertainty of Radiated Emission Measurement (30 MHz ~ 1000 MHz)

Measuring Uncertainty for a Level of Confidence of 95% ($U = 2Uc(y)$)	4.6dB
-------------------------------------------------------------------------	-------

Uncertainty of Radiated Emission Measurement (1000 MHz ~ 18000 MHz)

Measuring Uncertainty for a Level of Confidence of 95% ($U = 2Uc(y)$)	4.5dB
-------------------------------------------------------------------------	-------