



FCC RF Test Report

APPLICANT : Xiaomi Communications Co., Ltd.
EQUIPMENT : Mobile Phone
BRAND NAME : Redmi
MODEL NAME : M1810F6LG
FCC ID : 2AFZZ-RMSF6LG
STANDARD : 47 CFR Part 2, 22(H), 24(E), 27(L), 27(M)
CLASSIFICATION : PCS Licensed Transmitter Held to Ear (PCE)

The product was received on Dec. 18, 2018 and completely tested on Jan. 10, 2019. We, Sporton International (Kunshan) Inc., would like to declare that the tested sample has been evaluated in accordance with the procedures given in ANSI C63.26-2015 and shown compliance with the applicable technical standards.

The test results in this report apply exclusively to the tested model / sample. Without written approval of Sporton International (Kunshan) Inc., the test report shall not be reproduced except in full.



Approved by: James Huang / Manager

Sporton International (Kunshan) Inc.
No. 1098, Pengxi North Road, Kunshan Economic Development Zone,
Jiangsu Province 215335, China



TABLE OF CONTENTS

REVISION HISTORY..... 3
SUMMARY OF TEST RESULT 4
1 GENERAL DESCRIPTION 5
1.1 Applicant 5
1.2 Manufacturer 5
1.3 Product Feature of Equipment Under Test..... 5
1.4 Product Specification of Equipment Under Test..... 6
1.5 Modification of EUT 6
1.6 Maximum ERP/EIRP Power, Frequency Tolerance, and Emission Designator 7
1.7 Testing Location 11
1.8 Applicable Standards..... 11
2 TEST CONFIGURATION OF EQUIPMENT UNDER TEST 12
2.1 Test Mode 12
2.2 Connection Diagram of Test System..... 15
2.3 Support Unit used in test configuration and system 15
2.4 Measurement Results Explanation Example..... 15
2.5 Frequency List of Low/Middle/High Channels 16
3 CONDUCTED TEST ITEMS 19
3.1 Measuring Instruments 19
3.2 Test Setup 19
3.3 Test Result of Conducted Test 19
3.4 Conducted Output Power and ERP/EIRP 20
3.5 Peak-to-Average Ratio 21
3.6 Occupied Bandwidth 22
3.7 Conducted Band Edge 23
3.8 Conducted Spurious Emission 25
3.9 Frequency Stability 26
4 RADIATED TEST ITEMS 27
4.1 Measuring Instruments 27
4.2 Test Setup 27
4.3 Test Result of Radiated Test 27
4.4 Radiated Spurious Emission 28
5 LIST OF MEASURING EQUIPMENT 29
6 UNCERTAINTY OF EVALUATION 31
APPENDIX A. TEST RESULTS OF CONDUCTED TEST
APPENDIX B. TEST RESULTS OF RADIATED TEST
APPENDIX C. TEST SETUP PHOTOGRAPHS



REVISION HISTORY

REPORT NO.	VERSION	DESCRIPTION	ISSUED DATE
FG8D1803B	Rev. 01	Initial issue of report	Jan. 23, 2019



SUMMARY OF TEST RESULT

Report Section	FCC Rule	Description	Limit	Result	Remark
3.4	§2.1046	Conducted Output Power	Reporting Only	PASS	-
	§22.913(a)(5)	Effective Radiated Power (Band 5)	ERP < 7 Watt	PASS	-
	§24.232(c) §27.50(h)(2)	Equivalent Isotropic Radiated Power (Band 2) (Band 7) (Band 38)	EIRP < 2Watt	PASS	-
	§27.50(d)(4)	Equivalent Isotropic Radiated Power (Band 4)	EIRP < 1Watt	PASS	-
3.5	§24.232(d)	Peak-to-Average Ratio	<13 dB	PASS	-
3.6	§2.1049	Occupied Bandwidth	Reporting Only	PASS	-
3.7	§2.1051 §22.917(a) §24.238(a) §27.53(h)	Conducted Band Edge Measurement (Band 2) (Band 4) (Band 5)	< 43+10log ₁₀ (P[Watts])	PASS	-
	§27.53(m)(4)	Conducted Band Edge Measurement (Band 7) (Band 38)	§27.53(m)(4)		
3.8	§2.1051 §22.917(a) §24.238(a) §27.53(h)	Conducted Spurious Emission (Band 2) (Band 4) (Band 5)	< 43+10log ₁₀ (P[Watts])	PASS	-
	§2.1051 §27.53(m)(4)	Conducted Spurious Emission (Band 7) (Band 38)	< 55+10log ₁₀ (P[Watts])		
3.9	§2.1055 §22.355	Frequency Stability Temperature & Voltage	< 2.5 ppm for Part 22	PASS	-
	§2.1055 §24.235 §27.54		Within Authorized Band		
4.4	§2.1053 §22.917(a) §24.238(a) §27.53(h)	Radiated Spurious Emission (Band 2) (Band 4) (Band 5)	< 43+10log ₁₀ (P[Watts])	PASS	Under limit 29.39 dB at 7600.00 MHz
	§2.1053 §27.53(m)(4)	Radiated Spurious Emission (Band 7) (Band 38)	< 55+10log ₁₀ (P[Watts])		



1 General Description

1.1 Applicant

Xiaomi Communications Co., Ltd.

The Rainbow City of China Resources, NO.68, Qinghe Middle Street, Haidian District, Beijing, China

1.2 Manufacturer

Xiaomi Communications Co., Ltd.

The Rainbow City of China Resources, NO.68, Qinghe Middle Street, Haidian District, Beijing, China

1.3 Product Feature of Equipment Under Test

Product Feature	
Equipment	Mobile Phone
Brand Name	Redmi
Model Name	M1810F6LG
FCC ID	2AFZZ-RMSF6LG
EUT supports Radios application	GSM/GPRS/EGPRS/WCDMA/HSPA/DC-HSDPA/ HSPA+(16QAM Uplink is not supported)/LTE WLAN 2.4GHz 802.11b/g/n HT20 Bluetooth BR/EDR/LE
IMEI Code	Conducted: 866489040005017/866489040005025 866489040004630/866489040004648 Radiation: 866489040005116/866489040005124 866489040005975/866489040005983
HW Version	P2.0
SW Version	MIUI 10
EUT Stage	Identical Prototype



1.4 Product Specification of Equipment Under Test

Standards-related Product Specification	
Tx Frequency	LTE Band 2 : 1850.7 MHz ~ 1909.3 MHz LTE Band 4 : 1710.7 MHz ~ 1754.3 MHz LTE Band 5 : 824.7 MHz ~ 848.3 MHz LTE Band 7 : 2502.5 MHz ~ 2567.5 MHz LTE Band 38 : 2572.5MHz ~ 2617.5MHz
Rx Frequency	LTE Band 2 : 1930.7 MHz ~ 1989.3 MHz LTE Band 4 : 2110.7 MHz ~ 2154.3 MHz LTE Band 5 : 869.7 MHz ~ 893.3 MHz LTE Band 7 : 2622.5MHz ~ 2687.5 MHz LTE Band 38 : 2572.5MHz ~ 2617.5MHz
Bandwidth	LTE Band 2 : 1.4MHz / 3MHz / 5MHz / 10MHz / 15MHz / 20MHz LTE Band 4 : 1.4MHz / 3MHz / 5MHz / 10MHz / 15MHz / 20MHz LTE Band 5 : 1.4MHz / 3MHz / 5MHz / 10MHz LTE Band 7 : 5MHz / 10MHz / 15MHz / 20MHz LTE Band 38 : 5MHz / 10MHz / 15MHz / 20MHz
Maximum Output Power to Antenna	LTE Band 2 : 23.74 dBm LTE Band 4 : 23.30 dBm LTE Band 5 : 23.85 dBm LTE Band 7 : 23.81 dBm LTE Band 38 : 23.45 dBm
Antenna Gain	LTE Band 2 : 0.70 dBi LTE Band 4 : -1.20 dBi LTE Band 5 : -3.29 dBi LTE Band 7 : 0.10 dBi LTE Band 38 : -0.70 dBi
Type of Modulation	QPSK / 16QAM / 64QAM

1.5 Modification of EUT

No modifications are made to the EUT during all test items.



1.6 Maximum ERP/EIRP Power, Frequency Tolerance, and Emission Designator

LTE Band 2		QPSK			16QAM		
BW (MHz)	Frequency Range (MHz)	Emission Designator (99%OBW)	Frequency Tolerance (ppm)	Maximum EIRP(W)	Emission Designator (99%OBW)	Frequency Tolerance (ppm)	Maximum EIRP(W)
1.4	1850.7 ~ 1909.3	1M10G7D	-	0.2767	1M09W7D	-	0.2128
3	1851.5 ~ 1908.5	2M72G7D	-	0.2582	2M73W7D	-	0.2183
5	1852.5 ~ 1907.5	4M51G7D	-	0.2767	4M50W7D	-	0.2244
10	1855.0 ~ 1905.0	9M01G7D	0.0038	0.2723	8M99W7D	-	0.2009
15	1857.5 ~ 1902.5	13M4G7D	-	0.2704	13M4W7D	-	0.2023
20	1860.0 ~ 1900.0	18M3G7D	-	0.2780	18M3W7D	-	0.1968
LTE Band 2		64QAM					
BW (MHz)	Frequency Range (MHz)	Emission Designator (99%OBW)		Frequency Tolerance (ppm)	Maximum EIRP(W)		
1.4	1850.7 ~ 1909.3	1M10W7D		-	0.1837		
3	1851.5 ~ 1908.5	2M72W7D		-	0.1782		
5	1852.5 ~ 1907.5	4M50W7D		-	0.1862		
10	1855.0 ~ 1905.0	9M09W7D		-	0.1706		
15	1857.5 ~ 1902.5	13M4W7D		-	0.1803		
20	1860.0 ~ 1900.0	18M3W7D		-	0.1660		



LTE Band 4		QPSK			16QAM		
BW (MHz)	Frequency Range (MHz)	Emission Designator (99%OBW)	Frequency Tolerance (ppm)	Maximum EIRP(W)	Emission Designator (99%OBW)	Frequency Tolerance (ppm)	Maximum EIRP(W)
1.4	1710.7 ~ 1754.3	1M10G7D	-	0.1585	1M10W7D	-	0.1303
3	1711.5 ~ 1753.5	2M73G7D	-	0.1483	2M73W7D	-	0.1127
5	1712.5 ~ 1752.5	4M49G7D	-	0.1574	4M50W7D	-	0.1146
10	1715.0 ~ 1750.0	9M03G7D	0.0049	0.1574	9M01W7D	-	0.1156
15	1717.5 ~ 1747.5	13M5G7D	-	0.1560	13M4W7D	-	0.1189
20	1720.0 ~ 1745.0	18M3G7D	-	0.1622	18M3W7D	-	0.1178
LTE Band 4		64QAM					
BW (MHz)	Frequency Range (MHz)	Emission Designator (99%OBW)		Frequency Tolerance (ppm)	Maximum ERP(W)		
1.4	1710.7 ~ 1754.3	1M10W7D		-	0.1202		
3	1711.5 ~ 1753.5	2M72W7D		-	0.1125		
5	1712.5 ~ 1752.5	4M50W7D		-	0.1186		
10	1715.0 ~ 1750.0	8M99W7D		-	0.1119		
15	1717.5 ~ 1747.5	13M4W7D		-	0.1189		
20	1720.0 ~ 1745.0	18M3W7D		-	0.1122		
LTE Band 5		QPSK			16QAM		
BW (MHz)	Frequency Range (MHz)	Emission Designator (99%OBW)	Frequency Tolerance (ppm)	Maximum ERP(W)	Emission Designator (99%OBW)	Frequency Tolerance (ppm)	Maximum ERP(W)
1.4	824.7 ~ 848.3	1M09G7D	-	0.0692	1M10W7D	-	0.0531
3	825.5 ~ 847.5	2M73G7D	-	0.0641	2M74W7D	-	0.0505
5	826.5 ~ 846.5	4M48G7D	-	0.0687	4M49W7D	-	0.0558
10	829.0 ~ 844.0	9M01G7D	0.0072	0.0693	9M03W7D	-	0.0505
LTE Band 5		64QAM					
BW (MHz)	Frequency Range (MHz)	Emission Designator (99%OBW)		Frequency Tolerance (ppm)	Maximum ERP(W)		
1.4	824.7 ~ 848.3	1M10W7D		-	0.0453		
3	825.5 ~ 847.5	2M73W7D		-	0.0417		
5	826.5 ~ 846.5	4M49W7D		-	0.0453		
10	829.0 ~ 844.0	9M07W7D		-	0.0437		



LTE Band 7		QPSK			16QAM		
BW (MHz)	Frequency Range (MHz)	Emission Designator (99%OBW)	Frequency Tolerance (ppm)	Maximum EIRP(W)	Emission Designator (99%OBW)	Frequency Tolerance (ppm)	Maximum EIRP(W)
5	2502.5 ~ 2567.5	4M50G7D	-	0.2460	4M50W7D	-	0.1722
10	2505.0 ~ 2565.0	9M05G7D	0.0030	0.2393	9M03W7D	-	0.1746
15	2507.5 ~ 2562.5	13M4G7D	-	0.2415	13M5W7D	-	0.1742
20	2510.0 ~ 2560.0	18M4G7D	-	0.2312	18M3W7D	-	0.1734
LTE Band 7		64QAM					
BW (MHz)	Frequency Range (MHz)	Emission Designator (99%OBW)		Frequency Tolerance (ppm)		Maximum EIRP(W)	
5	2502.5 ~ 2567.5	4M51W7D		-		0.1614	
10	2505.0 ~ 2565.0	9M05W7D		-		0.1493	
15	2507.5 ~ 2562.5	13M4W7D		-		0.1614	
20	2510.0 ~ 2560.0	18M3W7D		-		0.1622	
LTE Band 38		QPSK			16QAM		
BW (MHz)	Frequency Range (MHz)	Emission Designator (99%OBW)	Frequency Tolerance (ppm)	Maximum EIRP(W)	Emission Designator (99%OBW)	Frequency Tolerance (ppm)	Maximum EIRP(W)
5	2572.5 ~ 2617.5	4M48G7D	-	0.1862	4M49W7D	-	0.1422
10	2575.0 ~ 2615.0	9M07G7D	0.0028	0.1879	9M03W7D	-	0.1439
15	2577.5 ~ 2612.5	13M5G7D	-	0.1871	13M5W7D	-	0.1476
20	2580.0 ~ 2610.0	18M4G7D	-	0.1884	18M3W7D	-	0.1403
LTE Band 38		64QAM					
BW (MHz)	Frequency Range (MHz)	Emission Designator (99%OBW)		Frequency Tolerance (ppm)		Maximum EIRP(W)	
5	2572.5 ~ 2617.5	4M48W7D		-		0.1315	
10	2575.0 ~ 2615.0	9M01W7D		-		0.1230	
15	2577.5 ~ 2612.5	13M5W7D		-		0.1330	
20	2580.0 ~ 2610.0	18M3W7D		-		0.1236	



LTE Band 7 CA	QPSK			16QAM		
BW (MHz)	Emission Designator (99%OBW)	Frequency Tolerance (ppm)	Maximum EIRP(W)	Emission Designator (99%OBW)	Frequency Tolerance (ppm)	Maximum EIRP(W)
10MHz+20MHz	28M0G7D	-	0.2553	28M0W7D	-	0.2328
15MHz+15MHz	28M4G7D	-	0.2547	28M5W7D	-	0.2350
15MHz+20MHz	32M6G7D	-	0.2559	32M5W7D	-	0.2307
15MHz+10MHz	23M5G7D	-	0.2523	23M4W7D	-	0.2328
20MHz+10MHz	27M8G7D	-	0.2535	28M0W7D	-	0.2249
20MHz+15MHz	32M7G7D	-	0.2564	32M7W7D	-	0.2355
20MHz+20MHz	37M3G7D	-	0.2564	37M3W7D	-	0.2472
LTE Band 7 CA	64QAM					
BW (MHz)	Emission Designator (99%OBW)		Frequency Tolerance (ppm)	Maximum EIRP(W)		
10MHz+20MHz	27M9W7D		-	0.1219		
15MHz+15MHz	28M4W7D		-	0.1172		
15MHz+20MHz	32M5W7D		-	0.1236		
15MHz+10MHz	23M4W7D		-	0.1219		
20MHz+10MHz	27M8W7D		-	0.1253		
20MHz+15MHz	32M6W7D		-	0.1250		
20MHz+20MHz	37M3W7D		-	0.2443		



1.7 Testing Location

Sporton Lab is accredited to ISO 17025 by National Voluntary Laboratory Accreditation Program (NVLAP code: 600155-0).

Test Site	Sporton International (Kunshan) Inc.		
Test Site Location	No. 1098, Pengxi North Road, Kunshan Economic Development Zone, Jiangsu Province 215335, China TEL : 86-512-57900158 FAX : 86-512-57900958		
Test Site No.	Sporton Site No.	FCC designation No.	FCC Test Firm Registration No.
	TH01-KS 03CH02-KS 03CH06-KS	CN5013	630927

1.8 Applicable Standards

According to the specifications of the manufacturer, the EUT must comply with the requirements of the following standards:

- 47 CFR Part 2, 22(H), 24(E), 27(L), 27(M)
- ANSI C63.26-2015
- FCC KDB 971168 D01 Power Meas License Digital Systems v03r01
- FCC KDB 412172 D01 Determining ERP and EIRP v01r01

Remark:

1. All test items were verified and recorded according to the standards and without any deviation during the test.
2. This EUT has also been tested and complied with the requirements of FCC Part 15, Subpart B, recorded in a separate test report.



2 Test Configuration of Equipment Under Test

2.1 Test Mode

Antenna port conducted and radiated test items listed below are performed according to KDB 971168 D01 Power Meas License Digital Systems v03r01 with maximum output power.

Radiated measurements are performed by rotating the EUT in three different orthogonal test planes to find the maximum emission.

Test Items	Band	Bandwidth (MHz)						Modulation			RB #			Test Channel		
		1.4	3	5	10	15	20	QPSK	16QAM	64QAM	1	Half	Full	L	M	H
Max. Output Power	2	v	v	v	v	v	v	v	v	v	v	v	v	v	v	v
	4	v	v	v	v	v	v	v	v	v	v	v	v	v	v	v
	5	v	v	v	v	-	-	v	v	v	v	v	v	v	v	v
	7	-	-	v	v	v	v	v	v	v	v	v	v	v	v	v
	38	-	-	v	v	v	v	v	v	v	v	v	v	v	v	v
Peak-to-Average Ratio	2						v	v	v	v	v		v	v	v	v
	4						v	v	v	v	v		v	v	v	v
	5				v	-	-	v	v	v	v		v	v	v	v
	7	-	-				v	v	v	v	v		v	v	v	v
	38	-	-				v	v	v	v	v		v	v	v	v
26dB and 99% Bandwidth	2	v	v	v	v	v	v	v	v	v			v	v	v	v
	4	v	v	v	v	v	v	v	v	v			v	v	v	v
	5	v	v	v	v	-	-	v	v	v			v	v	v	v
	7	-	-	v	v	v	v	v	v	v			v	v	v	v
	38	-	-	v	v	v	v	v	v	v			v	v	v	v
Conducted Band Edge	2	v	v	v	v	v	v	v	v	v	v		v	v		v
	4	v	v	v	v	v	v	v	v	v	v		v	v		v
	5	v	v	v	v	-	-	v	v	v	v		v	v		v
	7	-	-	v	v	v	v	v	v	v	v		v	v		v
	38	-	-	v	v	v	v	v	v	v	v		v	v		v



Test Items	Band	Bandwidth (MHz)						Modulation			RB #			Test Channel		
		1.4	3	5	10	15	20	QPSK	16QAM	64QAM	1	Half	Full	L	M	H
Conducted Spurious Emission	2	v	v	v	v	v	v	v	v	v	v			v	v	v
	4	v	v	v	v	v	v	v	v	v	v			v	v	v
	5	v	v	v	v	-	-	v	v	v	v			v	v	v
	7	-	-	v	v	v	v	v	v	v	v			v	v	v
	38	-	-	v	v	v	v	v	v	v	v			v	v	v
Frequency Stability	2				v			v					v		v	
	4				v			v					v		v	
	5				v	-	-	v					v		v	
	7	-	-		v			v					v		v	
	38	-	-		v			v					v		v	
E.R.P / E.I.R.P	2	v	v	v	v	v	v	v	v	v	v			v	v	v
	4	v	v	v	v	v	v	v	v	v	v			v	v	v
	5	v	v	v	v	-	-	v	v	v	v			v	v	v
	7	-	-	v	v	v	v	v	v	v	v			v	v	v
	38	-	-	v	v	v	v	v	v	v	v			v	v	v
Radiated Spurious Emission	2	Worst Case												v		
	4	Worst Case												v		
	5	Worst Case												v		
	7	Worst Case												v		
	38	Worst Case												v		
Note	<ol style="list-style-type: none"> The mark "v " means that this configuration is chosen for testing The mark "- " means that this bandwidth is not supported. The device is investigated from 30MHz to 10 times of fundamental signal for radiated spurious emission test under different RB size/offset and modulations in exploratory test. Subsequently, only the worst case emissions are reported. 															



Test Items	Band	Bandwidth (MHz)										Modulation			RB #			Test Channel				
		20+20	20+15	15+20	20+10	10+20	20+5	5+20	15+15	15+10	10+15	QPSK	16QAM	64QAM	1	Half	Full	L	M	H		
Max. Output Power	7_CA	v	v	v	v	v	-	-	v	v	-	v	v	v	v	v	v	v	v	v		
26dB and 99% Bandwidth	7_CA	v	v	v	v	v	-	-	v	v	-	v	v	v			v	v	v	v		
Conducted Band Edge	7_CA	v	v	v	v	v	-	-	v	v	-	v	v	v	v		v	v		v		
Conducted Spurious Emission	7_CA	v	v	v	v	v	-	-	v	v	-	v	v	v	v			v	v	v		
E.I.R.P.	7_CA	v	v	v	v	v	-	-	v	v	-	v	v	v	v			v	v	v		
Radiated Spurious Emission	7_CA	Worst Case																		v		
Note	<ol style="list-style-type: none"> The mark "v " means that this configuration is chosen for testing The mark "- " means that this bandwidth is not supported. The device is investigated from 30MHz to 10 times of fundamental signal for radiated spurious emission test under different RB size/offset and modulations in exploratory test. Subsequently, only the worst case emissions are reported. 																					

2.2 Connection Diagram of Test System

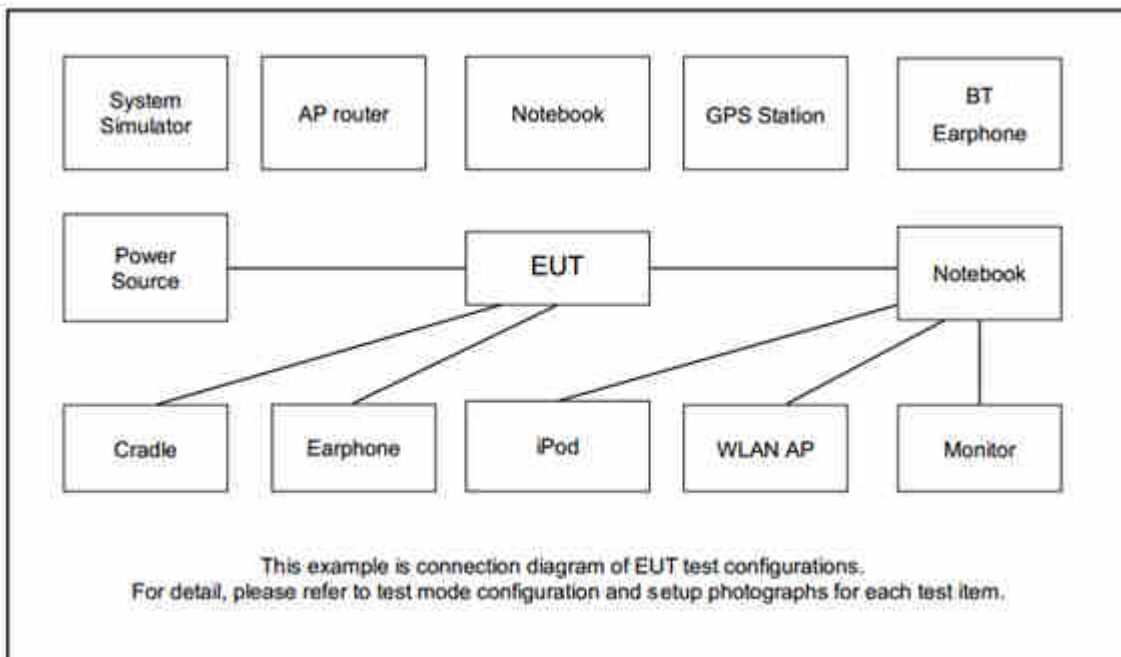

2.3 Support Unit used in test configuration and system

Item	Equipment	Trade Name	Model No.	FCC ID	Data Cable	Power Cord
1.	DC Power Supply	GW	GPS-3030D	N/A	N/A	Unshielded, 1.8 m
2.	LTE Base Station	Anritsu	MT8820C	N/A	N/A	Unshielded, 1.8 m
3.	Earphone	Xiaomi	EM023	N/A	N/A	Unshielded, 1.8 m

2.4 Measurement Results Explanation Example

For all conducted test items:

The offset level is set in the spectrum analyzer to compensate the RF cable loss between EUT conducted output port and spectrum analyzer. With the offset compensation, the spectrum analyzer reading level is exactly the EUT RF output level.

The spectrum analyzer offset is derived from RF cable loss.

$Offset = RF\ cable\ loss.$

Following shows an offset computation example with cable loss 5.0 dB.

Example :

$$Offset(dB) = RF\ cable\ loss(dB).$$

$$=5.0\ (dB)$$



2.5 Frequency List of Low/Middle/High Channels

LTE Band 2 Channel and Frequency List				
BW [MHz]	Channel/Frequency(MHz)	Lowest	Middle	Highest
20	Channel	18700	18900	19100
	Frequency	1860	1880	1900
15	Channel	18675	18900	19125
	Frequency	1857.5	1880	1902.5
10	Channel	18650	18900	19150
	Frequency	1855	1880	1905
5	Channel	18625	18900	19175
	Frequency	1852.5	1880	1907.5
3	Channel	18615	18900	19185
	Frequency	1851.5	1880	1908.5
1.4	Channel	18607	18900	19193
	Frequency	1850.7	1880	1909.3

LTE Band 4 Channel and Frequency List				
BW [MHz]	Channel/Frequency(MHz)	Lowest	Middle	Highest
20	Channel	20050	20175	20300
	Frequency	1720	1732.5	1745
15	Channel	20025	20175	20325
	Frequency	1717.5	1732.5	1747.5
10	Channel	20000	20175	20350
	Frequency	1715	1732.5	1750
5	Channel	19975	20175	20375
	Frequency	1712.5	1732.5	1752.5
3	Channel	19965	20175	20385
	Frequency	1711.5	1732.5	1753.5
1.4	Channel	19957	20175	20393
	Frequency	1710.7	1732.5	1754.3



LTE Band 5 Channel and Frequency List				
BW [MHz]	Channel/Frequency(MHz)	Lowest	Middle	Highest
10	Channel	20450	20525	20600
	Frequency	829	836.5	844
5	Channel	20425	20525	20625
	Frequency	826.5	836.5	846.5
3	Channel	20415	20525	20635
	Frequency	825.5	836.5	847.5
1.4	Channel	20407	20525	20643
	Frequency	824.7	836.5	848.3

LTE Band 7 Channel and Frequency List				
BW [MHz]	Channel/Frequency(MHz)	Lowest	Middle	Highest
20	Channel	20850	21100	21350
	Frequency	2510	2535	2560
15	Channel	20825	21100	21375
	Frequency	2507.5	2535	2562.5
10	Channel	20800	21100	21400
	Frequency	2505	2535	2565
5	Channel	20775	21100	21425
	Frequency	2502.5	2535	2567.5

LTE Band 38 Channel and Frequency List				
BW [MHz]	Channel/Frequency(MHz)	Lowest	Middle	Highest
20	Channel	37850	38000	38150
	Frequency	2580	2595	2610
15	Channel	37825	38000	38175
	Frequency	2577.5	2595	2612.5
10	Channel	37800	38000	38200
	Frequency	2575	2595	2615
5	Channel	37775	38000	38225
	Frequency	2572.5	2595	2617.5



LTE Band 7 Channel and Frequency List_CA					
BW [MHz]	Channel/Frequency(MHz)		Lowest	Middle	Highest
20 + 20	PCC	Channel	20850	21001	21152
		Frequency	2510.0	2525.1	2540.2
	SCC	Channel	21048	21199	21350
		Frequency	2529.8	2544.9	2560.0
20 + 15	PCC	Channel	20850	21026	21201
		Frequency	2510.0	2527.6	2545.1
	SCC	Channel	21021	21197	21372
		Frequency	2527.1	2544.7	2562.2
15 + 20	PCC	Channel	20828	21003	21179
		Frequency	2507.8	2525.3	2542.9
	SCC	Channel	20999	21174	21350
		Frequency	2524.9	2542.4	2560.0
20 + 10	PCC	Channel	20850	21051	21251
		Frequency	2510.0	2530.1	2550.1
	SCC	Channel	20994	21195	21395
		Frequency	2524.4	2544.5	2564.5
10 + 20	PCC	Channel	20805	21006	21206
		Frequency	2505.5	2525.6	2545.6
	SCC	Channel	20949	21150	21350
		Frequency	2519.9	2540.0	2560.0
15 + 15	PCC	Channel	20825	21025	21225
		Frequency	2507.5	2527.5	2547.5
	SCC	Channel	20975	21175	21375
		Frequency	2522.5	2542.5	2562.5
15 + 10	PCC	Channel	20825	21051	21277
		Frequency	2507.5	2530.1	2552.7
	SCC	Channel	20945	21171	21397
		Frequency	2519.5	2542.1	2564.7

3 Conducted Test Items

3.1 Measuring Instruments

See list of measuring instruments of this test report.

3.2 Test Setup

3.2.1 Conducted Output Power



3.2.2 Peak-to-Average Ratio, Occupied Bandwidth ,Conducted Band-Edge and Conducted Spurious Emission

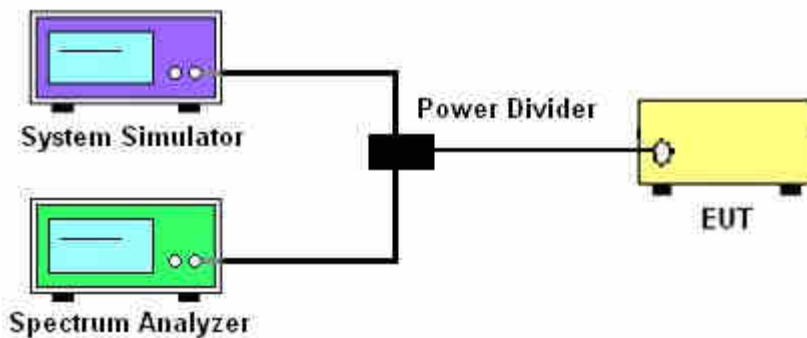

3.2.3 Frequency Stability

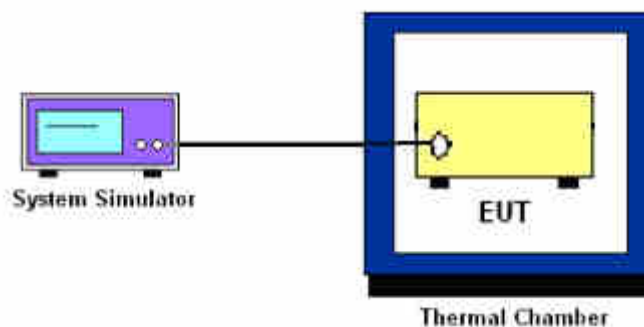

3.3 Test Result of Conducted Test

Please refer to Appendix A.



3.4 Conducted Output Power and ERP/EIRP

3.4.1 Description of the Conducted Output Power Measurement and ERP/EIRP Measurement

A system simulator was used to establish communication with the EUT. Its parameters were set to force the EUT transmitting at maximum output power. The measured power in the radio frequency on the transmitter output terminals shall be reported.

The ERP of mobile transmitters must not exceed 7 Watts for LTE Band 5.

The EIRP of mobile transmitters must not exceed 2 Watts for LTE Band 2 and Band 7 and Band 38.

The EIRP of mobile transmitters must not exceed 1 Watts for LTE Band 4.

According to KDB 412172 D01 Power Approach,

$EIRP = P_T + G_T - L_C$, $ERP = EIRP - 2.15$, where

P_T = transmitter output power in dBm

G_T = gain of the transmitting antenna in dBi

L_C = signal attenuation in the connecting cable between the transmitter and antenna in dB

3.4.2 Test Procedures

1. The testing follows ANSI C63.26 Section 5.2
2. The transmitter output port was connected to the system simulator.
3. Set EUT at maximum power through the system simulator.
4. Select lowest, middle, and highest channels for each band and different modulation.
5. Measure and record the power level from the system simulator.



3.5 Peak-to-Average Ratio

3.5.1 Description of the PAR Measurement

Power Complementary Cumulative Distribution Function (CCDF) curves provide a means for characterizing the power peaks of a digitally modulated signal on a statistical basis. A CCDF curve depicts the probability of the peak signal amplitude exceeding the average power level. Most contemporary measurement instrumentation include the capability to produce CCDF curves for an input signal provided that the instrument's resolution bandwidth can be set wide enough to accommodate the entire input signal bandwidth. In measuring transmissions in this band using an average power technique, the peak-to-average ratio (PAR) of the transmission may not exceed 13 dB.

3.5.2 Test Procedures

1. The testing follows ANSI C63.26 Section 5.2.3.4 (CCDF).
2. The EUT was connected to spectrum and system simulator via a power divider.
3. Set the CCDF (Complementary Cumulative Distribution Function) option in spectrum analyzer.
4. The highest RF powers were measured and recorded the maximum PAPR level associated with a probability of 0.1 %.
5. Record the deviation as Peak to Average Ratio.



3.6 Occupied Bandwidth

3.6.1 Description of Occupied Bandwidth Measurement

The occupied bandwidth is the width of a frequency band such that, below the lower and above the upper frequency limits, the mean powers emitted are each equal to a specified percentage 0.5% of the total mean transmitted power.

The 26 dB emission bandwidth is defined as the frequency range between two points, one above and one below the carrier frequency, at which the spectral density of the emission is attenuated 26 dB below the maximum in-band spectral density of the modulated signal. Spectral density (power per unit bandwidth) is to be measured with a detector of resolution bandwidth equal to approximately 1.0% of the emission bandwidth.

3.6.2 Test Procedures

1. The testing follows ANSI C63.26 Section 5.4
2. The EUT was connected to spectrum analyzer and system simulator via a power divider.
3. The spectrum analyzer center frequency is set to the nominal EUT channel center frequency. The span range for the spectrum analyzer shall be between two and five times the anticipated OBW.
4. The nominal resolution bandwidth (RBW) shall be in the range of 1 to 5 % of the anticipated OBW, and the VBW shall be at least 3 times the RBW.
5. Set the detection mode to peak, and the trace mode to max hold.
6. Determine the reference value: Set the EUT to transmit a modulated signal. Allow the trace to stabilize. Set the spectrum analyzer marker to the highest level of the displayed trace.
(this is the reference value)
7. Determine the “-26 dB down amplitude” as equal to (Reference Value – X).
8. Place two markers, one at the lowest and the other at the highest frequency of the envelope of the spectral display such that each marker is at or slightly below the “-X dB down amplitude” determined in step 6. If a marker is below this “-X dB down amplitude” value it shall be placed as close as possible to this value. The OBW is the positive frequency difference between the two markers.
9. Use the 99 % power bandwidth function of the spectrum analyzer and report the measured bandwidth.



3.7 Conducted Band Edge

3.7.1 Description of Conducted Band Edge Measurement

22.917(a)

For operations in the 824 – 849 MHz band, the FCC limit is $43 + 10\log_{10}(P[\text{Watts}])$ dB below the transmitter power $P(\text{Watts})$ in a 100kHz bandwidth. However, in the 1MHz bands immediately outside and adjacent to the licensee's frequency block, a resolution bandwidth of at least one percent of the emission bandwidth of the fundamental emission of the transmitter may be employed.

24.238 (a)

For operations in the 1850-1910 and 1930-1990 MHz band, the FCC limit is $43 + 10\log_{10}(P[\text{Watts}])$ dB below the transmitter power $P(\text{Watts})$ in a 1MHz bandwidth. However, in the 1 MHz bands immediately outside and adjacent to the frequency block a resolution bandwidth of at least one percent of the emission bandwidth of the fundamental emission of the transmitter may be employed.

27.53 (h)

For operations in the 1710 – 1755 MHz band, the FCC limit is $43 + 10\log_{10}(P[\text{Watts}])$ dB below the transmitter power $P(\text{Watts})$ in a 1 MHz bandwidth. However, in the 1MHz bands immediately outside and adjacent to the licensee's frequency block, a resolution bandwidth of at least one percent of the emission bandwidth of the fundamental emission of the transmitter may be employed.

27.53(m)(4)

For mobile digital stations, the attenuation factor shall be not less than $40 + 10 \log (P)$ dB on all frequencies between the channel edge and 5 megahertz from the channel edge, $43 + 10 \log (P)$ dB on all frequencies between 5 megahertz and X megahertz from the channel edge, and $55 + 10 \log (P)$ dB on all frequencies more than X megahertz from the channel edge, where X is the greater of 6 megahertz or the actual emission bandwidth as defined in paragraph (m)(6) of this section. In addition, the attenuation factor shall not be less that $43 + 10 \log (P)$ dB on all frequencies between 2490.5 MHz and 2496 MHz and $55 + 10 \log (P)$ dB at or below 2490.5 MHz. Mobile Satellite Service licensees operating on frequencies below 2495 MHz may also submit a documented interference complaint against BRS licensees operating on channel BRS Channel 1 on the same terms and conditions as adjacent channel BRS or EBS licensees.



3.7.2 Test Procedures

1. The testing follows ANSI C63.26 section 5.7
2. The EUT was connected to spectrum analyzer and system simulator via a power divider.
3. The band edges of low and high channels for the highest RF powers were measured.
4. Set RBW \geq 1% EBW in the 1MHz band immediately outside and adjacent to the band edge.
5. Beyond the 1 MHz band from the band edge, RBW=1MHz was used.
6. Set spectrum analyzer with RMS detector.
7. The RF fundamental frequency should be excluded against the limit line in the operating frequency band.
8. Checked that all the results comply with the emission limit line.

Example:

The limit line is derived from $43 + 10\log(P)$ dB below the transmitter power P(Watts)
= P(W)- [43 + 10log(P)] (dB)
= [30 + 10log(P)] (dBm) - [43 + 10log(P)] (dB) = -13dBm.

9. For LTE Band 7, 38, the other 40 dB, and 55 dB have additionally applied same calculation above.



3.8 Conducted Spurious Emission

3.8.1 Description of Conducted Spurious Emission Measurement

The power of any emission outside of the authorized operating frequency ranges must be lower than the transmitter power (P) by a factor of at least $43 + 10 \log (P)$ dB.

For Band 7,38:

The power of any emission outside of the authorized operating frequency ranges must be lower than the transmitter power (P) by a factor of at least $55 + 10 \log (P)$ dB.

It is measured by means of a calibrated spectrum analyzer and scanned from 30 MHz up to a frequency including its 10th harmonic.

3.8.2 Test Procedures

1. The testing follows ANSI C63.26 section 5.7
2. The EUT was connected to spectrum analyzer and system simulator via a power divider.
3. The RF output of EUT was connected to the spectrum analyzer by RF cable and attenuator. The path loss was compensated to the results for each measurement.
4. The middle channel for the highest RF power within the transmitting frequency was measured.
5. The conducted spurious emission for the whole frequency range was taken.
6. Make the measurement with the spectrum analyzer's RBW = 1MHz, VBW = 3MHz.
7. Set spectrum analyzer with RMS detector.
8. Taking the record of maximum spurious emission.
9. The RF fundamental frequency should be excluded against the limit line in the operating frequency band.
10. The limit line is derived from $43 + 10\log(P)$ dB below the transmitter power P(Watts)
 $= P(W) - [43 + 10\log(P)]$ (dB)
 $= [30 + 10\log(P)]$ (dBm) - $[43 + 10\log(P)]$ (dB)
 $= -13$ dBm.
11. For Band 7, 38
The limit line is derived from $55 + 10\log(P)$ dB below the transmitter power P(Watts)
 $= P(W) - [55 + 10\log(P)]$ (dB)
 $= [30 + 10\log(P)]$ (dBm) - $[55 + 10\log(P)]$ (dB)
 $= -25$ dBm.



3.9 Frequency Stability

3.9.1 Description of Frequency Stability Measurement

The frequency stability shall be measured by variation of ambient temperature and variation of primary supply voltage to ensure that the fundamental emission stays within the authorized frequency block. The frequency stability of the transmitter shall be maintained within $\pm 0.00025\%$ ($\pm 2.5\text{ppm}$) of the center frequency.

3.9.2 Test Procedures for Temperature Variation

1. The testing follows ANSI C63.26 section 5.6.4
2. The EUT was set up in the thermal chamber and connected with the system simulator.
3. With power OFF, the temperature was decreased to -30°C and the EUT was stabilized before testing. Power was applied and the maximum change in frequency was recorded within one minute.
4. With power OFF, the temperature was raised in 10°C step up to 50°C . The EUT was stabilized at each step for at least half an hour. Power was applied and the maximum frequency change was recorded within one minute.

3.9.3 Test Procedures for Voltage Variation

1. The testing follows ANSI C63.26 section 5.6.5
2. The EUT was placed in a temperature chamber at $20\pm 5^{\circ}\text{C}$ and connected with the system simulator.
3. The power supply voltage to the EUT was varied from 85% to 115% of the nominal value for other than hand carried battery equipment.
4. For hand carried, battery powered equipment, reduce the primary ac or dc supply voltage to the battery operating end point, which shall be specified by the manufacturer.
5. The variation in frequency was measured for the worst case.

4 Radiated Test Items

4.1 Measuring Instruments

See list of measuring instruments of this test report.

4.2 Test Setup

4.2.1 For radiated test from 30MHz to 1GHz

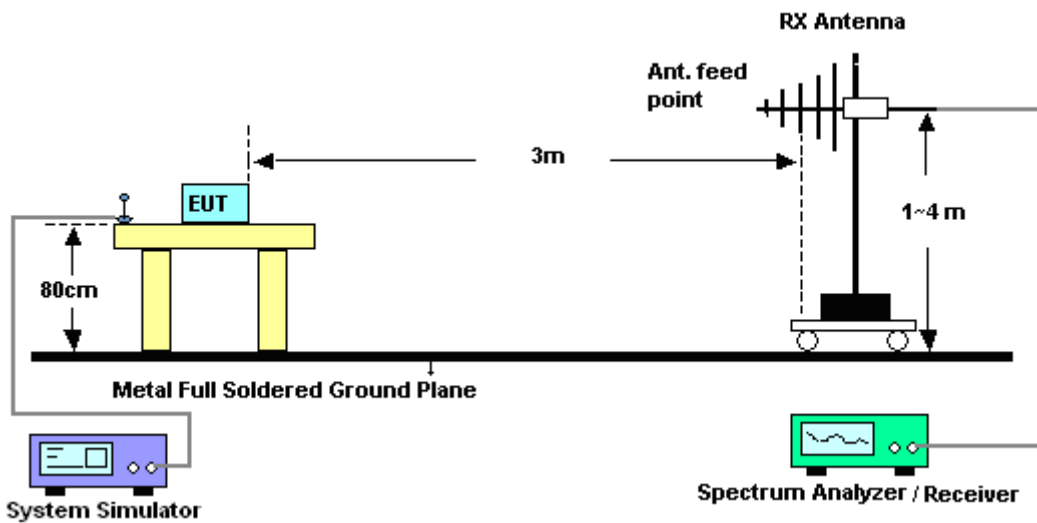

4.2.2 For radiated test above 1GHz

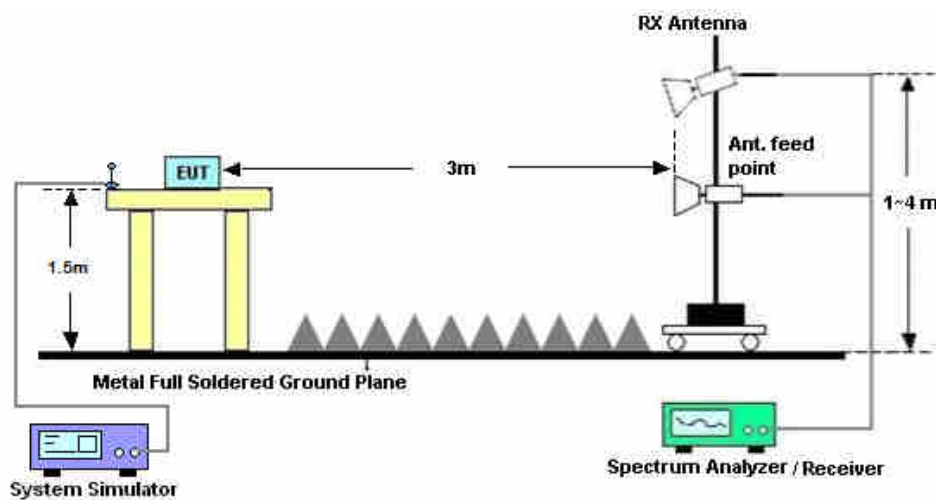

4.3 Test Result of Radiated Test

Please refer to Appendix B.



4.4 Radiated Spurious Emission

4.4.1 Description of Radiated Spurious Emission

The radiated spurious emission was measured by substitution method according to ANSI C63.26. The power of any emission outside of the authorized operating frequency ranges must be attenuated below the transmitter power (P) by a factor of at least $43 + 10 \log (P)$ dB.

For Band 7, 38

The power of any emission outside of the authorized operating frequency ranges must be attenuated below the transmitter power (P) by a factor of at least $55 + 10 \log (P)$ dB.

The spectrum is scanned from 30 MHz up to a frequency including its 10th harmonic.

4.4.2 Test Procedures

1. The testing follows ANSI C63.26 Section 5.5
2. The EUT was placed on a turntable with 0.8 meter height for frequency below 1GHz and 1.5 meter height for frequency above 1GHz respectively above ground.
3. The EUT was set 3 meters from the receiving antenna mounted on the antenna tower.
4. The table was rotated 360 degrees to determine the position of the highest spurious emission.
5. The height of the receiving antenna is varied between 1m to 4m to search the maximum spurious emission for both horizontal and vertical polarizations.
6. During the measurement, the system simulator parameters were set to force the EUT transmitting at maximum output power.
7. Make the measurement with the spectrum analyzer's RBW = 1MHz, VBW = 3MHz, taking the record of maximum spurious emission.
8. A horn antenna was substituted in place of the EUT and was driven by a signal generator.
9. Tune the output power of signal generator to the same emission level with EUT maximum spurious emission.
10. $EIRP (dBm) = S.G. Power - Tx Cable Loss + Tx Antenna Gain$
11. $ERP (dBm) = EIRP - 2.15$
12. The RF fundamental frequency should be excluded against the limit line in the operating frequency band.

The limit line is derived from $43 + 10\log(P)$ dB below the transmitter power P(Watts)
 $= P(W) - [43 + 10\log(P)] (dB)$
 $= [30 + 10\log(P)] (dBm) - [43 + 10\log(P)] (dB)$
 $= -13dBm.$

13. For Band 7, 38:

The limit line is derived from $55 + 10\log(P)$ dB below the transmitter power P(Watts)



5 List of Measuring Equipment

Instrument	Manufacturer	Model No.	Serial No.	Characteristics	Calibration Date	Test Date	Due Date	Remark
Spectrum Analyzer	R&S	FSV40	101040	10Hz~40GHz	Aug. 07, 2018	Dec. 24, 2018~Jan. 10, 2019	Aug. 06, 2019	Conducted (TH01-KS)
Radio communication analyzer	Anritsu	MT8820C	6201432830	2G/3G/LTE_ full band	Jan. 18, 2018	Dec. 24, 2018~Jan. 10, 2019	Jan. 17, 2019	Conducted (TH01-KS)
Thermal Chamber	Hongzhan	LP-150U	H2014011440	-40~+150°C 20%~95%RH	Jun. 27, 2018	Dec. 24, 2018~Jan. 10, 2019	Jun. 26, 2019	Conducted (TH01-KS)
EMI Test Receiver	R&S	ESR7	101403	9kHz~7GHz;Max 30dBm	Aug. 06, 2018	Dec. 27, 2018	Aug. 05, 2019	Radiation (03CH02-KS)
EXA Spectrum Analyzer	Keysight	N9010A	MY55150208	10Hz-44G,MAX 30dB	Apr.17, 2018	Dec. 27, 2018	Apr. 16, 2019	Radiation (03CH02-KS)
Bilog Antenna	TeseQ	CBL6112D	23182	30MHz-2GHz	Jan. 29, 2018	Dec. 27, 2018	Jan. 28, 2019	Radiation (03CH02-KS)
Double Ridge Horn Antenna	ETS-Lindgren	3117	75959	1GHz~18GHz	Jan. 21, 2018	Dec. 27, 2018	Jan. 20, 2019	Radiation (03CH02-KS)
SHF-EHF Horn	Schwarzbeck	BBHA 9170	BBHA170249	15GHz~40GHz	Feb. 07, 2018	Dec. 27, 2018	Feb. 06, 2019	Radiation (03CH02-KS)
high gain Amplifier	MITEQ	AMF-7D-00 101800-30-1 0P	2025788	100MHz-18GHz	Apr. 17, 2018	Dec. 27, 2018	Apr. 16, 2019	Radiation (03CH02-KS)
Amplifier	SONOMA	310N	187289	9KHz-1GHz	Aug. 06, 2018	Dec. 27, 2018	Aug. 05, 2019	Radiation (03CH02-KS)
Amplifier	Keysight	83017A	MY53270203	500MHz~26.5GHz	Apr. 18, 2018	Dec. 27, 2018	Apr. 17, 2019	Radiation (03CH02-KS)
Amplifier	MITEQ	TTA1840-35 -HG	1887435	18~40GHz	Feb. 08, 2018	Dec. 27, 2018	Feb. 07, 2019	Radiation (03CH02-KS)
AC Power Source	Chroma	61601	616010002473	N/A	NCR	Dec. 27, 2018	NCR	Radiation (03CH02-KS)
Turn Table	MF	MF7802	N/A	0~360 degree	NCR	Dec. 27, 2018	NCR	Radiation (03CH02-KS)
Antenna Mast	MF	MF7802	N/A	1 m~4 m	NCR	Dec. 27, 2018	NCR	Radiation (03CH02-KS)
EXA Spectrum Analyzer	Keysight	N9010B	MY57471084	10Hz-44GHz	Jun. 25, 2018	Jan. 07, 2019	Jun. 24, 2019	Radiation (03CH06-KS)
Bilog Antenna	TeseQ	CBL6111D	44483	30MHz-1GHz	Jan. 29, 2018	Jan. 07, 2019	Jan. 28, 2019	Radiation (03CH06-KS)
Double Ridge Horn Antenna	ETS-Lindgren	3117	75957	1GHz~18GHz	Oct. 20, 2018	Jan. 07, 2019	Oct. 19, 2019	Radiation (03CH06-KS)
SHF-EHF Horn	Schwarzbeck	BBHA 9170	BBHA170249	15GHz~40GHz	Feb. 07, 2018	Jan. 07, 2019	Feb. 06, 2019	Radiation (03CH06-KS)
Amplifier	SONOMA	310N	187289	9KHz ~1GHZ	Aug. 06, 2018	Jan. 07, 2019	Aug. 05, 2019	Radiation (03CH06-KS)
Amplifier	MITEQ	TTA1840-35 -HG	2014749	18~40GHz	Feb. 08, 2018	Jan. 07, 2019	Feb. 07, 2019	Radiation (03CH06-KS)
high gain Amplifier	MITEQ	AMF-7D-00 101800-30-1 0P	2025788	1Ghz-18Ghz	Apr. 17, 2018	Jan. 07, 2019	Apr. 16, 2019	Radiation (03CH06-KS)
Amplifier	Keysight	83017A	MY53270203	500MHz~26.5GHz	Apr. 18, 2018	Jan. 07, 2019	Apr. 17, 2019	Radiation (03CH06-KS)



AC Power Source	Chroma	61601	F104090004	N/A	NCR	Jan. 07, 2019	NCR	Radiation (03CH06-KS)
Turn Table	ChamPro	EM 1000-T	060762-T	0~360 degree	NCR	Jan. 07, 2019	NCR	Radiation (03CH06-KS)
Antenna Mast	ChamPro	EM 1000-A	060762-A	1 m~4 m	NCR	Jan. 07, 2019	NCR	Radiation (03CH06-KS)

NCR: No Calibration Required



6 Uncertainty of Evaluation

The measurement uncertainties shown below were calculated in accordance with the requirements of ANSI 63.26-2015. All the measurement uncertainty value were shown with a coverage K=2 to indicate 95% level of confidence. The measurement data show herein meets or exceeds the CISPR measurement uncertainty values specified in CISPR 16-4-2 and can be compared directly to specified limit to determine compliance.

Uncertainty of Radiated Emission Measurement (30 MHz ~ 1000 MHz) for 03CH02-KS

Measuring Uncertainty for a Level of Confidence of 95% (U = 2Uc(y))	3.3 dB
---	--------

Uncertainty of Radiated Emission Measurement (1 GHz ~ 40 GHz) for 03CH02-KS

Measuring Uncertainty for a Level of Confidence of 95% (U = 2Uc(y))	2.8 dB
---	--------

Uncertainty of Radiated Emission Measurement (30 MHz ~ 1000 MHz) for 03CH06-KS

Measuring Uncertainty for a Level of Confidence of 95% (U = 2Uc(y))	2.5 dB
---	--------

Uncertainty of Radiated Emission Measurement (1 GHz ~ 40 GHz) for 03CH06-KS

Measuring Uncertainty for a Level of Confidence of 95% (U = 2Uc(y))	2.0 dB
---	--------



Appendix A. Test Results of Conducted Test

Conducted Output Power(Average power)

LTE Band 2 Maximum Average Power [dBm]						
BW [MHz]	RB Size	RB Offset	Mod	Lowest	Middle	Highest
20	1	0	QPSK	23.01	23.00	22.97
20	1	49		23.41	23.74	23.56
20	1	99		23.09	23.18	23.23
20	50	0		22.35	22.39	22.37
20	50	24		22.19	22.36	22.34
20	50	50		22.17	22.29	22.35
20	100	0		22.27	22.35	22.34
20	1	0	16-QAM	22.20	22.10	22.15
20	1	49		22.09	22.15	22.24
20	1	99		21.97	21.97	22.19
20	50	0		21.30	21.36	21.21
20	50	24		21.18	21.24	21.22
20	50	50		21.11	21.27	21.21
20	100	0		21.21	21.17	21.30
20	1	0	64QAM	21.10	21.38	21.27
20	1	49		21.31	21.50	21.43
20	1	99		21.20	21.34	21.20
20	50	0		20.84	20.82	20.77
20	50	24		20.58	20.68	20.78
20	50	50		20.66	20.72	20.84
20	100	0		20.68	20.73	20.68
15	1	0	QPSK	23.34	23.46	23.20
15	1	37		23.62	23.55	23.30
15	1	74		23.24	23.31	23.47
15	36	0		22.42	22.40	22.34
15	36	20		22.36	22.35	22.29
15	36	39		22.22	22.39	22.35
15	75	0		22.34	22.33	22.41



15	1	0	16-QAM	22.18	22.27	22.21
15	1	37		22.22	22.21	22.36
15	1	74		22.04	22.11	22.31
15	36	0		21.20	21.29	21.24
15	36	20		21.23	21.24	21.20
15	36	39		21.11	21.20	21.29
15	75	0		21.32	21.32	21.41
15	1	0	64QAM	21.50	21.57	21.53
15	1	37		21.86	21.81	21.86
15	1	74		21.23	21.48	21.55
15	36	0		20.77	20.77	20.72
15	36	20		20.72	20.72	20.66
15	36	39		20.58	20.67	20.83
15	75	0		20.69	20.70	20.70



LTE Band 2 Maximum Average Power [dBm]						
BW [MHz]	RB Size	RB Offset	Mod	Lowest	Middle	Highest
10	1	0	QPSK	23.24	23.17	23.02
10	1	25		23.65	23.38	23.35
10	1	49		23.14	23.10	23.25
10	25	0		22.38	22.40	22.31
10	25	12		22.38	22.37	22.39
10	25	25		22.33	22.38	22.51
10	50	0		22.41	22.42	22.42
10	1	0	16-QAM	22.20	22.21	22.26
10	1	25		22.19	22.11	22.20
10	1	49		22.02	22.26	22.33
10	25	0		21.25	21.47	21.35
10	25	12		21.45	21.16	21.57
10	25	25		21.21	21.31	21.39
10	50	0		21.28	21.42	21.35
10	1	0	64QAM	21.21	21.61	21.29
10	1	25		21.48	21.59	21.59
10	1	49		21.33	21.62	21.31
10	25	0		20.84	20.87	20.83
10	25	12		20.74	20.74	20.88
10	25	25		20.78	20.80	20.92
10	50	0		20.75	20.71	20.81
5	1	0	QPSK	23.19	22.97	23.35
5	1	12		23.35	23.69	23.72
5	1	24		22.99	23.38	23.38
5	12	0		22.34	22.36	22.39
5	12	7		22.40	22.38	22.53
5	12	13		22.34	22.37	22.50
5	25	0		22.36	22.43	22.47
5	1	0	16-QAM	22.13	22.01	22.54
5	1	12		22.04	22.42	22.81
5	1	24		22.12	22.64	22.06
5	12	0		21.23	21.18	21.14
5	12	7		21.39	21.23	21.31



5	12	13	64QAM	21.43	21.24	21.36
5	25	0		21.25	21.32	21.50
5	1	0		21.42	21.24	21.56
5	1	12		22.00	21.68	21.89
5	1	24		21.31	21.39	21.12
5	12	0		20.78	20.61	20.60
5	12	7		20.66	20.57	20.94
5	12	13		20.70	20.59	20.90
5	25	0		20.81	20.88	20.89



LTE Band 2 Maximum Average Power [dBm]						
BW [MHz]	RB Size	RB Offset	Mod	Lowest	Middle	Highest
3	1	0	QPSK	23.17	23.28	23.42
3	1	8		23.18	23.13	23.35
3	1	14		23.16	23.23	23.17
3	8	0		22.23	22.43	22.68
3	8	4		22.30	22.40	22.49
3	8	7		22.33	22.29	22.50
3	15	0		22.30	22.40	22.61
3	1	0	16-QAM	22.17	22.25	22.69
3	1	8		22.04	22.10	22.65
3	1	14		22.20	22.03	22.43
3	8	0		21.22	21.27	21.16
3	8	4		21.18	21.31	21.47
3	8	7		21.23	21.32	21.47
3	15	0		21.18	21.01	21.38
3	1	0	64QAM	21.33	21.81	21.59
3	1	8		21.28	21.51	21.80
3	1	14		21.24	21.46	21.58
3	8	0		20.72	20.93	20.93
3	8	4		20.77	20.83	20.91
3	8	7		20.73	20.92	20.65
3	15	0		20.62	20.75	20.92
1.4	1	0	QPSK	23.18	23.41	23.50
1.4	1	3		23.28	23.44	23.43
1.4	1	5		23.15	23.35	23.27
1.4	3	0		23.32	23.41	23.44
1.4	3	1		23.28	23.35	23.54
1.4	3	3		23.50	23.41	23.72
1.4	6	0		22.22	22.42	22.52
1.4	1	0	16-QAM	22.18	22.22	22.44
1.4	1	3		22.28	22.39	22.50
1.4	1	5		22.40	22.19	22.43
1.4	3	0		22.44	22.42	22.58



1.4	3	1	64QAM	22.51	22.37	22.51
1.4	3	3		22.54	22.38	22.56
1.4	6	0		21.24	21.08	21.18
1.4	1	0		21.36	21.72	21.84
1.4	1	3		21.39	21.70	21.39
1.4	1	5		21.30	21.77	21.53
1.4	3	0		21.84	21.39	21.80
1.4	3	1		21.69	21.90	21.89
1.4	3	3		21.74	21.88	21.94
1.4	6	0		20.70	20.97	20.85



LTE Band 4 Maximum Average Power [dBm]						
BW [MHz]	RB Size	RB Offset	Mod	Lowest	Middle	Highest
20	1	0	QPSK	22.42	22.47	22.74
20	1	49		22.95	23.30	23.29
20	1	99		22.65	22.59	22.93
20	50	0		21.95	21.97	21.92
20	50	24		21.90	21.88	21.90
20	50	50		21.75	21.87	21.85
20	100	0		21.79	21.96	21.92
20	1	0	16-QAM	21.53	21.52	21.91
20	1	49		21.63	21.71	21.65
20	1	99		21.59	21.63	21.67
20	50	0		20.90	20.86	21.13
20	50	24		20.96	20.84	21.01
20	50	50		20.81	20.95	20.83
20	100	0		20.75	20.80	20.96
20	1	0	64QAM	21.03	21.01	21.36
20	1	49		21.42	21.43	21.37
20	1	99		21.30	21.45	21.70
20	50	0		20.96	20.86	20.89
20	50	24		20.95	20.95	20.95
20	50	50		20.87	20.94	20.92
20	100	0		20.77	20.82	20.98
15	1	0	QPSK	22.76	22.61	22.95
15	1	37		22.82	23.13	23.09
15	1	74		22.76	22.82	22.95
15	36	0		21.85	21.96	22.03
15	36	20		21.93	21.93	22.03
15	36	39		21.83	21.89	21.98
15	75	0		21.76	21.90	22.02
15	1	0	16-QAM	21.55	21.34	21.95
15	1	37		21.60	21.62	21.70
15	1	74		21.49	21.66	21.75
15	36	0		20.79	20.91	20.98
15	36	20		20.87	20.89	20.98



15	36	39	64QAM	20.78	20.88	20.95
15	75	0		20.78	20.97	21.08
15	1	0		21.39	21.55	21.40
15	1	37		21.65	21.90	21.95
15	1	74		21.24	21.35	21.44
15	36	0		20.79	20.92	20.95
15	36	20		20.99	20.90	20.90
15	36	39		20.77	20.97	20.90
15	75	0		20.82	20.86	20.98



LTE Band 4 Maximum Average Power [dBm]						
BW [MHz]	RB Size	RB Offset	Mod	Lowest	Middle	Highest
10	1	0	QPSK	22.46	22.58	22.69
10	1	25		22.91	22.98	23.17
10	1	49		22.49	22.45	22.69
10	25	0		21.80	21.92	22.08
10	25	12		21.89	21.90	22.09
10	25	25		21.94	21.90	21.88
10	50	0		21.95	21.95	21.97
10	1	0	16-QAM	21.56	21.53	21.72
10	1	25		21.66	21.65	21.68
10	1	49		21.57	21.49	21.83
10	25	0		20.93	20.89	21.06
10	25	12		20.95	20.84	21.06
10	25	25		21.22	21.16	21.24
10	50	0		21.02	20.92	21.04
10	1	0	64QAM	21.35	21.69	21.50
10	1	25		21.44	21.45	21.55
10	1	49		21.34	21.69	21.66
10	25	0		20.95	20.90	20.89
10	25	12		20.94	20.85	20.95
10	25	25		21.00	20.97	20.78
10	50	0		20.91	20.89	20.86
5	1	0	QPSK	22.54	22.47	22.65
5	1	12		23.01	23.17	22.99
5	1	24		22.57	22.78	22.61
5	12	0		21.68	21.97	21.96
5	12	7		21.76	21.95	21.95
5	12	13		21.81	21.77	22.06
5	25	0		21.72	21.91	21.92
5	1	0	16-QAM	21.48	21.63	21.73
5	1	12		21.49	21.55	21.53
5	1	24		21.50	21.52	21.79
5	12	0		20.79	20.96	20.83
5	12	7		20.72	21.02	21.02



5	12	13		20.98	20.80	21.19
5	25	0		20.87	20.92	20.94
5	1	0	64QAM	21.22	21.54	21.54
5	1	12		21.94	21.56	21.93
5	1	24		21.28	21.17	21.55
5	12	0		20.84	20.89	20.69
5	12	7		20.92	20.90	20.98
5	12	13		20.96	20.90	20.88
5	25	0		20.77	20.89	20.80



LTE Band 4 Maximum Average Power [dBm]						
BW [MHz]	RB Size	RB Offset	Mod	Lowest	Middle	Highest
3	1	0	QPSK	22.52	22.74	22.66
3	1	8		22.66	22.85	22.75
3	1	14		22.67	22.66	22.91
3	8	0		21.89	22.00	22.06
3	8	4		21.87	21.98	22.05
3	8	7		21.82	21.88	22.02
3	15	0		21.80	21.92	21.98
3	1	0	16-QAM	21.61	21.54	21.37
3	1	8		21.49	21.54	21.57
3	1	14		21.61	21.72	21.65
3	8	0		20.77	21.01	20.84
3	8	4		20.89	21.10	20.86
3	8	7		20.93	21.04	20.94
3	15	0		20.76	20.99	20.74
3	1	0	64QAM	21.23	21.52	21.39
3	1	8		21.49	21.52	21.48
3	1	14		21.34	21.48	21.71
3	8	0		20.74	20.97	20.88
3	8	4		20.80	20.89	20.82
3	8	7		20.82	20.97	20.89
3	15	0		20.74	20.98	20.83
1.4	1	0	QPSK	22.82	22.98	22.63
1.4	1	3		22.90	22.90	23.04
1.4	1	5		22.81	22.83	23.10
1.4	3	0		22.93	23.01	23.15
1.4	3	1		22.98	23.17	23.20
1.4	3	3		23.02	22.98	23.08
1.4	6	0		21.87	21.99	22.00
1.4	1	0	16-QAM	21.74	21.91	21.77
1.4	1	3		21.79	21.97	22.09
1.4	1	5		21.65	21.80	21.90
1.4	3	0		21.81	21.93	21.88
1.4	3	1		21.77	21.96	22.31



1.4	3	3	64QAM	21.81	21.56	22.35
1.4	6	0		20.78	20.92	20.85
1.4	1	0		21.34	21.36	21.52
1.4	1	3		21.41	21.68	21.92
1.4	1	5		21.36	21.43	21.98
1.4	3	0		21.75	21.86	21.90
1.4	3	1		21.89	22.00	21.90
1.4	3	3		21.95	21.99	21.95
1.4	6	0		20.83	20.85	20.80



LTE Band 5 Maximum Average Power [dBm]						
BW [MHz]	RB Size	RB Offset	Mod	Lowest	Middle	Highest
10	1	0	QPSK	23.52	23.26	23.22
10	1	25		23.85	23.73	23.59
10	1	49		23.70	23.32	23.45
10	25	0		22.52	22.42	22.46
10	25	12		22.67	22.53	22.61
10	25	25		22.69	22.58	22.64
10	50	0		22.67	22.46	22.53
10	1	0	16-QAM	22.42	22.22	22.35
10	1	25		22.47	22.22	22.37
10	1	49		22.28	22.36	22.17
10	25	0		21.63	21.52	21.30
10	25	12		21.55	21.38	21.48
10	25	25		21.64	21.48	21.49
10	50	0		21.58	21.38	21.49
10	1	0	64QAM	21.74	21.20	21.84
10	1	25		21.64	21.51	21.62
10	1	49		21.57	21.65	21.41
10	25	0		20.99	20.77	20.74
10	25	12		20.91	20.67	20.84
10	25	25		20.91	20.94	20.94
10	50	0		20.90	20.89	20.83
5	1	0	QPSK	23.29	23.03	23.43
5	1	12		23.65	23.73	23.81
5	1	24		23.24	23.23	23.27
5	12	0		22.62	22.35	22.48
5	12	7		22.59	22.45	22.58
5	12	13		22.55	22.40	22.59
5	25	0		22.60	22.45	22.56
5	1	0	16-QAM	22.39	22.07	22.31
5	1	12		22.15	22.16	22.91
5	1	24		22.32	22.35	22.32
5	12	0		21.45	21.47	21.53
5	12	7		21.62	21.46	21.62



5	12	13	64QAM	21.67	21.54	21.64
5	25	0		21.73	21.34	21.70
5	1	0		21.64	21.44	21.58
5	1	12		22.00	21.53	21.88
5	1	24		21.52	21.53	21.51
5	12	0		20.89	20.64	20.86
5	12	7		20.95	20.45	20.96
5	12	13		20.83	20.78	20.97
5	25	0		20.96	20.80	20.80



LTE Band 5 Maximum Average Power [dBm]						
BW [MHz]	RB Size	RB Offset	Mod	Lowest	Middle	Highest
3	1	0	QPSK	23.40	23.25	23.39
3	1	8		23.51	23.05	23.48
3	1	14		23.24	23.19	23.47
3	8	0		22.71	22.51	22.68
3	8	4		22.53	22.48	22.60
3	8	7		22.61	22.47	22.62
3	15	0		22.54	22.38	22.55
3	1	0	16-QAM	22.47	22.01	22.46
3	1	8		22.34	22.10	22.37
3	1	14		22.37	22.11	22.37
3	8	0		21.55	21.34	21.56
3	8	4		21.50	21.36	21.58
3	8	7		21.59	21.40	21.52
3	15	0		21.49	21.30	21.49
3	1	0	64QAM	21.58	21.32	21.57
3	1	8		21.64	21.35	21.22
3	1	14		21.58	21.42	21.58
3	8	0		20.89	20.94	20.96
3	8	4		20.79	20.92	20.91
3	8	7		20.74	20.91	20.84
3	15	0		20.84	20.48	20.78
1.4	1	0	QPSK	23.63	23.42	23.53
1.4	1	3		23.68	23.49	23.63
1.4	1	5		23.58	23.35	23.52
1.4	3	0		23.73	23.47	23.71
1.4	3	1		23.84	23.72	23.83
1.4	3	3		23.79	23.44	23.58
1.4	6	0		22.51	22.33	22.56
1.4	1	0	16-QAM	22.46	22.24	22.42
1.4	1	3		22.61	22.39	22.57
1.4	1	5		22.69	22.22	22.40
1.4	3	0		22.57	22.24	22.39
1.4	3	1		22.54	22.10	22.50



1.4	3	3	64QAM	22.54	22.32	22.59
1.4	6	0		21.51	21.04	21.54
1.4	1	0		21.33	21.41	21.61
1.4	1	3		21.81	21.58	21.36
1.4	1	5		21.53	21.29	21.50
1.4	3	0		21.96	21.70	21.98
1.4	3	1		22.00	21.80	21.99
1.4	3	3		21.98	21.79	21.91
1.4	6	0		20.90	20.62	20.71



LTE Band 7 Maximum Average Power [dBm]						
BW [MHz]	RB Size	RB Offset	Mod	Lowest	Middle	Highest
20	1	0	QPSK	23.00	22.98	22.99
20	1	49		23.40	23.45	23.54
20	1	99		23.37	23.33	23.12
20	50	0		22.39	22.38	22.37
20	50	24		22.37	22.42	22.43
20	50	50		22.33	22.36	22.22
20	100	0		22.31	22.41	22.43
20	1	0	16-QAM	22.11	22.18	22.27
20	1	49		22.29	22.28	22.16
20	1	99		22.06	22.11	21.95
20	50	0		21.46	21.52	21.27
20	50	24		21.38	21.47	21.46
20	50	50		21.35	21.43	21.21
20	100	0		21.31	21.27	21.27
20	1	0	64QAM	21.51	21.71	21.64
20	1	49		22.00	21.98	21.79
20	1	99		21.50	21.95	21.67
20	50	0		20.74	20.90	20.84
20	50	24		20.78	20.96	20.90
20	50	50		20.60	20.95	20.69
20	100	0		20.68	20.86	20.73
15	1	0	QPSK	23.17	23.16	23.38
15	1	37		23.66	23.73	23.49
15	1	74		23.16	23.32	23.15
15	36	0		22.37	22.47	22.39
15	36	20		22.39	22.44	22.29
15	36	39		22.40	22.46	22.20
15	75	0		22.46	22.44	22.30
15	1	0	16-QAM	22.22	22.31	22.05
15	1	37		22.26	22.21	22.02
15	1	74		22.09	22.28	21.81
15	36	0		21.40	21.35	21.33
15	36	20		21.35	21.43	21.17



15	36	39	64QAM	21.36	21.46	21.12
15	75	0		21.34	21.54	21.18
15	1	0		21.78	21.80	21.86
15	1	37		21.90	21.98	21.80
15	1	74		21.68	21.86	21.63
15	36	0		20.73	20.87	20.58
15	36	20		20.85	20.84	20.67
15	36	39		20.79	20.86	20.48
15	75	0		20.72	20.81	20.56



LTE Band 7 Maximum Average Power [dBm]						
BW [MHz]	RB Size	RB Offset	Mod	Lowest	Middle	Highest
10	1	0	QPSK	23.01	23.11	22.99
10	1	25		23.29	23.69	23.10
10	1	49		23.09	23.45	23.03
10	25	0		22.40	22.46	22.31
10	25	12		22.33	22.50	22.27
10	25	25		22.42	22.45	22.20
10	50	0		22.45	22.37	22.18
10	1	0	16-QAM	22.19	22.28	22.14
10	1	25		22.15	22.32	22.00
10	1	49		22.25	22.22	22.04
10	25	0		21.36	21.28	21.34
10	25	12		21.38	21.41	21.26
10	25	25		21.48	21.71	21.21
10	50	0		21.53	21.41	21.13
10	1	0	64QAM	21.64	21.51	21.10
10	1	25		21.45	21.55	20.93
10	1	49		21.32	21.54	21.08
10	25	0		20.81	20.88	20.83
10	25	12		20.77	20.91	20.61
10	25	25		20.72	20.88	20.74
10	50	0		20.82	20.95	20.69
5	1	0	QPSK	23.11	23.24	22.89
5	1	12		23.64	23.81	23.11
5	1	24		22.92	23.25	22.65
5	12	0		22.37	22.38	22.19
5	12	7		22.28	22.47	22.21
5	12	13		22.34	22.48	22.22
5	25	0		22.37	22.48	22.20
5	1	0	16-QAM	22.10	22.26	21.94
5	1	12		22.15	22.23	21.79
5	1	24		22.14	22.24	21.78
5	12	0		21.25	21.37	21.00



5	12	7		21.44	21.60	21.03
5	12	13		21.33	21.66	21.05
5	25	0		21.25	21.38	21.06
5	1	0	64QAM	21.88	21.90	21.70
5	1	12		21.98	21.61	21.95
5	1	24		21.85	21.98	21.45
5	12	0		20.63	20.87	20.43
5	12	7		20.66	20.89	20.54
5	12	13		20.72	20.91	20.48
5	25	0		20.84	20.88	20.51



LTE Band 38 Maximum Average Power [dBm]						
BW [MHz]	RB Size	RB Offset	Mod	Lowest	Middle	Highest
20	1	0	QPSK	23.15	23.11	23.13
20	1	49		23.45	23.22	23.20
20	1	99		23.19	23.18	23.19
20	50	0		22.22	22.24	22.31
20	50	24		22.34	22.28	22.33
20	50	50		22.29	22.27	22.32
20	100	0		22.29	22.26	22.28
20	1	0	16-QAM	21.92	21.89	21.92
20	1	49		22.17	21.97	22.07
20	1	99		21.94	21.89	21.88
20	50	0		21.23	21.23	21.13
20	50	24		21.21	21.07	21.46
20	50	50		21.28	21.28	21.14
20	100	0		21.16	21.16	21.22
20	1	0	64QAM	21.56	21.26	21.33
20	1	49		21.52	21.62	21.54
20	1	99		21.49	21.59	21.52
20	50	0		20.38	20.38	20.37
20	50	24		20.36	20.31	20.40
20	50	50		20.39	20.42	20.38
20	100	0		20.40	20.41	20.47
15	1	0	QPSK	23.05	23.05	22.98
15	1	37		23.42	23.40	23.26
15	1	74		23.12	23.28	23.03
15	36	0		22.49	22.24	22.16
15	36	20		22.47	22.47	22.28
15	36	39		22.23	22.25	22.27
15	75	0		22.27	22.26	22.34
15	1	0	16-QAM	21.95	21.94	21.92
15	1	37		22.32	22.39	22.38
15	1	74		22.16	22.16	21.99
15	36	0		21.43	21.18	21.01
15	36	20		21.20	21.08	21.24



15	36	39	64QAM	21.18	21.38	21.25
15	75	0		21.23	21.25	21.06
15	1	0		21.55	21.50	21.50
15	1	37		21.86	21.84	21.94
15	1	74		21.50	21.62	21.47
15	36	0		20.49	20.52	20.26
15	36	20		20.53	20.26	20.34
15	36	39		20.65	20.70	20.37
15	75	0		20.37	20.36	20.33



LTE Band 38 Maximum Average Power [dBm]						
BW [MHz]	RB Size	RB Offset	Mod	Lowest	Middle	Highest
10	1	0	QPSK	23.11	23.26	23.12
10	1	25		23.17	23.33	23.44
10	1	49		23.29	23.25	23.26
10	25	0		22.20	22.45	22.29
10	25	12		22.48	22.29	22.34
10	25	25		22.26	22.51	22.21
10	50	0		22.26	22.23	22.29
10	1	0	16-QAM	22.04	21.89	21.82
10	1	25		21.82	22.25	22.28
10	1	49		21.81	21.98	22.01
10	25	0		21.43	21.45	21.49
10	25	12		21.46	21.48	21.63
10	25	25		21.44	21.41	21.20
10	50	0		21.28	21.24	21.10
10	1	0	64QAM	21.58	21.52	21.58
10	1	25		21.46	21.60	21.58
10	1	49		21.41	21.57	21.59
10	25	0		20.69	20.71	20.65
10	25	12		20.66	20.73	20.76
10	25	25		20.72	20.75	20.66
10	50	0		20.42	20.38	20.44
5	1	0	QPSK	23.06	23.04	23.06
5	1	12		23.40	23.31	23.18
5	1	24		22.98	23.03	22.93
5	12	0		22.42	22.46	22.36
5	12	7		22.17	22.50	22.40
5	12	13		22.10	22.25	22.36
5	25	0		22.19	22.22	22.11
5	1	0	16-QAM	21.97	21.98	21.97
5	1	12		22.21	22.23	21.75
5	1	24		21.78	22.02	21.79
5	12	0		21.15	21.38	20.99
5	12	7		21.23	21.21	21.17



5	12	13	64QAM	21.14	21.09	21.21
5	25	0		21.45	21.41	21.04
5	1	0		21.47	21.48	21.49
5	1	12		21.89	21.79	21.81
5	1	24		21.44	21.48	21.45
5	12	0		20.40	20.23	20.18
5	12	7		20.49	20.29	20.38
5	12	13		20.38	20.26	20.42
5	25	0		20.34	20.38	20.57



CA Power

CA_7C								
Combination 20MHz+20MHz (100RB+100RB)								
PCC Channel	SCC Channel	Modulation	PCC		SCC		Total RB Size	Measured Power (dBm)
			RB Size	RB offset	RB Size	RB offset		
20850	21048	QPSK	0	0	1	99	1	23.67
			1	0	0	0	1	23.99
			100	0	0	0	100	23.00
			100	0	100	0	200	22.75
			1	0	1	99	2	16.30
			1	0	1	0	2	21.09
			1	99	1	0	2	23.98
			100	0	1	99	101	21.34
		16QAM	0	0	1	99	1	22.51
			1	0	0	0	1	23.04
			100	0	0	0	100	21.78
			100	0	100	0	200	21.93
			1	0	1	99	2	16.26
			1	0	1	0	2	21.23
			1	99	1	0	2	23.83
			100	0	1	99	101	21.66
		64QAM	0	0	1	99	1	22.33
			1	0	0	0	1	22.49
			100	0	0	0	100	20.83
			100	0	100	0	200	22.60
			1	0	1	99	2	16.28
			1	0	1	0	2	21.19
			1	99	1	0	2	23.78
			100	0	1	99	101	21.61



21001	21199	QPSK	0	0	1	99	1	23.54
			1	0	0	0	1	23.96
			100	0	0	0	100	23.05
			100	0	100	0	200	22.71
			1	0	1	99	2	16.43
			1	0	1	0	2	21.81
			1	99	1	0	2	23.98
			100	0	1	99	101	21.37
		16QAM	0	0	1	99	1	23.06
			1	23	0	0	1	22.66
			100	0	0	0	100	22.04
			100	0	100	0	200	21.74
			1	0	1	99	2	16.53
			1	0	1	0	2	21.23
			1	99	1	0	2	23.49
			100	0	1	99	101	21.35
		64QAM	0	0	1	99	1	21.99
			1	0	0	0	1	22.44
			100	0	0	0	100	21.11
			100	0	100	0	200	21.94
			1	0	1	99	2	16.98
			1	0	1	0	2	21.25
			1	99	1	0	2	22.19
			100	0	1	99	101	21.63



21152	21350	QPSK	0	0	1	99	1	22.78
			1	0	0	0	1	23.72
			100	0	0	0	100	22.81
			100	0	100	0	200	21.76
			1	0	1	99	2	16.45
			1	0	1	0	2	21.78
			1	99	1	0	2	23.91
			100	0	1	99	101	21.64
		16QAM	0	0	1	99	1	22.25
			1	0	0	0	1	23.76
			100	0	0	0	100	22.75
			100	0	100	0	200	22.00
			1	0	1	99	2	16.68
			1	0	1	0	2	21.97
			1	99	1	0	2	23.36
			100	0	1	99	101	21.47
		64QAM	0	0	1	99	1	21.89
			1	0	0	0	1	22.31
			100	0	0	0	100	21.87
			100	0	100	0	200	21.76
			1	0	1	99	2	16.53
			1	0	1	0	2	21.66
			1	99	1	0	2	21.94
			100	0	1	99	101	21.58



CA_7C								
Combination 20MHz+15MHz (100RB+75RB)								
PCC Channel	SCC Channel	Modulation	PCC		SCC		Total RB Size	Measured Power (dBm)
			RB Size	RB offset	RB Size	RB offset		
20850	21021	QPSK	100	0	75	0	175	21.78
		QPSK	1	0	1	74	2	15.43
		QPSK	1	99	1	0	2	23.99
		16QAM	100	0	75	0	175	20.83
		16QAM	1	0	1	74	2	15.65
		16QAM	1	99	1	0	2	23.62
		64QAM	100	0	75	0	175	20.76
		64QAM	1	0	1	74	2	15.52
		64QAM	1	99	1	0	2	20.66
21026	21197	QPSK	100	0	75	0	175	21.89
		QPSK	1	0	1	74	2	14.86
		QPSK	1	99	1	0	2	23.91
		16QAM	100	0	75	0	175	20.82
		16QAM	1	0	1	74	2	15.60
		16QAM	1	99	1	0	2	23.23
		64QAM	100	0	75	0	175	20.75
		64QAM	1	0	1	74	2	15.43
		64QAM	1	99	1	0	2	20.79
21201	21372	QPSK	100	0	75	0	175	22.04
		QPSK	1	0	1	74	2	15.06
		QPSK	1	99	1	0	2	23.76
		16QAM	100	0	75	0	175	21.01
		16QAM	1	0	1	74	2	15.47
		16QAM	1	99	1	0	2	23.00
		64QAM	100	0	75	0	175	20.87
		64QAM	1	0	1	74	2	15.51
		64QAM	1	99	1	0	2	20.72



Combination 15MHz+20MHz (75RB+100RB)								
PCC Channel	SCC Channel	Modulation	PCC		SCC		Total RB Size	Measured Power (dBm)
			RB Size	RB offset	RB Size	RB offset		
20828	20999	QPSK	75	0	100	0	175	21.56
		QPSK	1	0	1	99	2	15.53
		QPSK	1	74	1	0	2	23.98
		16QAM	75	0	100	0	175	20.76
		16QAM	1	0	1	99	2	15.53
		16QAM	1	74	1	0	2	23.53
		64QAM	75	0	100	0	175	20.67
		64QAM	1	0	1	99	2	15.44
		64QAM	1	74	1	0	2	20.59
21003	21174	QPSK	75	0	100	0	175	21.86
		QPSK	1	0	1	99	2	15.13
		QPSK	1	74	1	0	2	23.97
		16QAM	75	0	100	0	175	20.77
		16QAM	1	0	1	99	2	15.42
		16QAM	1	74	1	0	2	23.16
		64QAM	75	0	100	0	175	20.72
		64QAM	1	0	1	99	2	15.32
		64QAM	1	74	1	0	2	20.65
21179	21350	QPSK	75	0	100	0	175	22.06
		QPSK	1	0	1	99	2	15.24
		QPSK	1	74	1	0	2	23.90
		16QAM	75	0	100	0	175	21.17
		16QAM	1	0	1	99	2	15.27
		16QAM	1	74	1	0	2	23.16
		64QAM	75	0	100	0	175	20.82
		64QAM	1	0	1	99	2	15.38
		64QAM	1	74	1	0	2	20.64



Combination 20MHz+10MHz (100RB+50RB)								
PCC	SCC	Modulation	PCC		SCC		Total RB Size	Measured Power (dBm)
Channel	Channel		RB Size	RB offset	RB Size	RB offset		
20850	20994	QPSK	100	0	50	0	150	21.67
		QPSK	1	0	1	49	2	15.32
		QPSK	1	99	1	0	2	23.91
		16QAM	100	0	50	0	150	20.72
		16QAM	1	0	1	49	2	15.61
		16QAM	1	99	1	0	2	23.42
		64QAM	100	0	50	0	150	20.64
		64QAM	1	0	1	49	2	15.56
		64QAM	1	99	1	0	2	20.61
21051	21195	QPSK	100	0	50	0	150	21.75
		QPSK	1	0	1	49	2	15.26
		QPSK	1	99	1	0	2	23.76
		16QAM	100	0	50	0	150	20.68
		16QAM	1	0	1	49	2	15.37
		16QAM	1	99	1	0	2	23.22
		64QAM	100	0	50	0	150	20.63
		64QAM	1	0	1	49	2	15.27
		64QAM	1	99	1	0	2	20.59
21251	21395	QPSK	100	0	50	0	150	22.11
		QPSK	1	0	1	49	2	15.35
		QPSK	1	99	1	0	2	23.94
		16QAM	100	0	50	0	150	21.28
		16QAM	1	0	1	49	2	15.33
		16QAM	1	99	1	0	2	23.10
		64QAM	100	0	50	0	150	20.88
		64QAM	1	0	1	49	2	15.24
		64QAM	1	99	1	0	2	20.71



Combination 10MHz+20MHz (50RB+100RB)								
PCC	SCC	Modulation	PCC		SCC		Total RB Size	Measured Power (dBm)
Channel	Channel		RB Size	RB offset	RB Size	RB offset		
20805	20949	QPSK	50	0	100	0	150	21.64
		QPSK	1	0	1	99	2	15.32
		QPSK	1	49	1	0	2	23.97
		16QAM	50	0	100	0	150	20.65
		16QAM	1	0	1	99	2	15.46
		16QAM	1	49	1	0	2	23.57
		64QAM	50	0	100	0	150	20.64
		64QAM	1	0	1	99	2	15.38
		64QAM	1	49	1	0	2	20.63
21006	21150	QPSK	50	0	100	0	150	21.82
		QPSK	1	0	1	99	2	14.83
		QPSK	1	49	1	0	2	23.95
		16QAM	50	0	100	0	150	20.80
		16QAM	1	0	1	99	2	15.54
		16QAM	1	49	1	0	2	23.27
		64QAM	50	0	100	0	150	20.64
		64QAM	1	0	1	99	2	15.44
		64QAM	1	49	1	0	2	20.63
21206	21350	QPSK	50	0	100	0	150	22.11
		QPSK	1	0	1	99	2	15.09
		QPSK	1	49	1	0	2	23.85
		16QAM	50	0	100	0	150	21.13
		16QAM	1	0	1	99	2	15.49
		16QAM	1	49	1	0	2	23.06
		64QAM	50	0	100	0	150	20.76
		64QAM	1	0	1	99	2	15.47
		64QAM	1	49	1	0	2	20.58



Combination 15MHz+15MHz (75RB+75RB)								
PCC	SCC	Modulation	PCC		SCC		Total RB Size	Measured Power (dBm)
Channel	Channel		RB Size	RB offset	RB Size	RB offset		
20825	20975	QPSK	75	0	75	0	150	21.51
		QPSK	1	0	1	74	2	15.23
		QPSK	1	74	1	0	2	23.96
		16QAM	75	0	75	0	150	20.43
		16QAM	1	0	1	74	2	15.24
		16QAM	1	74	1	0	2	23.61
		64QAM	75	0	75	0	150	20.59
		64QAM	1	0	1	74	2	15.19
		64QAM	1	74	1	0	2	20.48
21025	21175	QPSK	75	0	75	0	150	21.67
		QPSK	1	0	1	74	2	15.01
		QPSK	1	74	1	0	2	23.90
		16QAM	75	0	75	0	150	20.72
		16QAM	1	0	1	74	2	15.35
		16QAM	1	74	1	0	2	23.18
		64QAM	75	0	75	0	150	20.56
		64QAM	1	0	1	74	2	15.40
		64QAM	1	74	1	0	2	20.52
21225	21375	QPSK	75	0	75	0	150	22.18
		QPSK	1	0	1	74	2	15.27
		QPSK	1	74	1	0	2	23.86
		16QAM	75	0	75	0	150	21.34
		16QAM	1	0	1	74	2	15.53
		16QAM	1	74	1	0	2	23.16
		64QAM	75	0	75	0	150	20.58
		64QAM	1	0	1	74	2	15.57
		64QAM	1	74	1	0	2	20.32



Combination 15MHz+10MHz (75RB+50RB)								
PCC	SCC	Modulation	PCC		SCC		Total RB Size	Measured Power (dBm)
Channel	Channel		RB Size	RB offset	RB Size	RB offset		
20825	20945	QPSK	75	0	50	0	125	21.56
		QPSK	1	0	1	49	2	15.32
		QPSK	1	74	1	0	2	23.92
		16QAM	75	0	50	0	125	20.38
		16QAM	1	0	1	49	2	15.48
		16QAM	1	74	1	0	2	23.57
		64QAM	75	0	50	0	125	20.76
		64QAM	1	0	1	49	2	15.36
		64QAM	1	74	1	0	2	20.37
21051	21171	QPSK	75	0	50	0	125	21.78
		QPSK	1	0	1	49	2	15.28
		QPSK	1	74	1	0	2	23.86
		16QAM	75	0	50	0	125	20.57
		16QAM	1	0	1	49	2	15.42
		16QAM	1	74	1	0	2	23.33
		64QAM	75	0	50	0	125	20.48
		64QAM	1	0	1	49	2	15.51
		64QAM	1	74	1	0	2	20.48
21277	21397	QPSK	75	0	50	0	125	22.23
		QPSK	1	0	1	49	2	15.17
		QPSK	1	74	1	0	2	23.76
		16QAM	75	0	50	0	125	21.43
		16QAM	1	0	1	49	2	15.49
		16QAM	1	74	1	0	2	22.78
		64QAM	75	0	50	0	125	20.64
		64QAM	1	0	1	49	2	15.38
		64QAM	1	74	1	0	2	20.49



ERP/EIRP

LTE Band 2 (GT - LC = 0.70 dB) QPSK									
Bandwidth	1.4M			3M			5M		
Channel	18607	18900	19193	18615	18900	19185	18625	18900	19175
	(Low)	(Mid)	(High)	(Low)	(Mid)	(High)	(Low)	(Mid)	(High)
Frequency	1850.7	1880	1909.3	1851.5	1880	1908.5	1852.5	1880	1907.5
(MHz)									
Conducted Power (dBm)	23.50	23.41	23.72	23.17	23.28	23.42	23.35	23.69	23.72
Conducted Power (Watts)	0.2239	0.2193	0.2355	0.2075	0.2128	0.2198	0.2163	0.2339	0.2355
EIRP(dBm)	24.20	24.11	24.42	23.87	23.98	24.12	24.05	24.39	24.42
EIRP(Watts)	0.2630	0.2576	0.2767	0.2438	0.2500	0.2582	0.2541	0.2748	0.2767

LTE Band 2 (GT - LC = 0.70 dB) QPSK									
Bandwidth	10M			15M			20M		
Channel	18650	18900	19150	18675	18900	19125	18650	18900	19100
	(Low)	(Mid)	(High)	(Low)	(Mid)	(High)	(Low)	(Mid)	(High)
Frequency	1855	1880	1905	1857.5	1880	1902.5	1860	1880	1900
(MHz)									
Conducted Power (dBm)	23.65	23.38	23.35	23.62	23.55	23.30	23.41	23.74	23.56
Conducted Power (Watts)	0.2317	0.2178	0.2163	0.2301	0.2265	0.2138	0.2193	0.2366	0.2270
EIRP(dBm)	24.35	24.08	24.05	24.32	24.25	24.00	24.11	24.44	24.26
EIRP(Watts)	0.2723	0.2559	0.2541	0.2704	0.2661	0.2512	0.2576	0.2780	0.2667



LTE Band 2 (GT - LC = 0.70 dB) 16QAM									
Bandwidth	1.4M			3M			5M		
Channel	18607	18900	19193	18615	18900	19185	18625	18900	19175
	(Low)	(Mid)	(High)	(Low)	(Mid)	(High)	(Low)	(Mid)	(High)
Frequency (MHz)	1850.7	1880	1909.3	1851.5	1880	1908.5	1852.5	1880	1907.5
Conducted Power (dBm)	22.44	22.42	22.58	22.17	22.25	22.69	22.04	22.42	22.81
Conducted Power (Watts)	0.1754	0.1746	0.1811	0.1648	0.1679	0.1858	0.1600	0.1746	0.1910
EIRP(dBm)	23.14	23.12	23.28	22.87	22.95	23.39	22.74	23.12	23.51
EIRP(Watts)	0.2061	0.2051	0.2128	0.1936	0.1972	0.2183	0.1879	0.2051	0.2244

LTE Band 2 (GT - LC = 0.70 dB) 16QAM									
Bandwidth	10M			15M			20M		
Channel	18650	18900	19150	18675	18900	19125	18650	18900	19100
	(Low)	(Mid)	(High)	(Low)	(Mid)	(High)	(Low)	(Mid)	(High)
Frequency (MHz)	1855	1880	1905	1857.5	1880	1902.5	1860	1880	1900
Conducted Power (dBm)	22.02	22.26	22.33	22.22	22.21	22.36	22.09	22.15	22.24
Conducted Power (Watts)	0.1592	0.1683	0.1710	0.1667	0.1663	0.1722	0.1618	0.1641	0.1675
EIRP(dBm)	22.72	22.96	23.03	22.92	22.91	23.06	22.79	22.85	22.94
EIRP(Watts)	0.1871	0.1977	0.2009	0.1959	0.1954	0.2023	0.1901	0.1928	0.1968



LTE Band 2 (GT - LC = 0.70 dB) 64QAM									
Bandwidth	1.4M			3M			5M		
Channel	18607	18900	19193	18615	18900	19185	18625	18900	19175
	(Low)	(Mid)	(High)	(Low)	(Mid)	(High)	(Low)	(Mid)	(High)
Frequency (MHz)	1850.7	1880	1909.3	1851.5	1880	1908.5	1852.5	1880	1907.5
Conducted Power (dBm)	21.74	21.88	21.94	21.33	21.81	21.59	22.00	21.68	21.89
Conducted Power (Watts)	0.1493	0.1542	0.1563	0.1358	0.1517	0.1442	0.1585	0.1472	0.1545
EIRP(dBm)	22.44	22.58	22.64	22.03	22.51	22.29	22.70	22.38	22.59
EIRP(Watts)	0.1754	0.1811	0.1837	0.1596	0.1782	0.1694	0.1862	0.1730	0.1816

LTE Band 2 (GT - LC = 0.70 dB) 64QAM									
Bandwidth	10M			15M			20M		
Channel	18650	18900	19150	18675	18900	19125	18650	18900	19100
	(Low)	(Mid)	(High)	(Low)	(Mid)	(High)	(Low)	(Mid)	(High)
Frequency (MHz)	1855	1880	1905	1857.5	1880	1902.5	1860	1880	1900
Conducted Power (dBm)	21.33	21.62	21.31	21.86	21.81	21.86	21.31	21.50	21.43
Conducted Power (Watts)	0.1358	0.1452	0.1352	0.1535	0.1517	0.1535	0.1352	0.1413	0.1390
EIRP(dBm)	22.03	22.32	22.01	22.56	22.51	22.56	22.01	22.20	22.13
EIRP(Watts)	0.1596	0.1706	0.1589	0.1803	0.1782	0.1803	0.1589	0.1660	0.1633



LTE Band 4 (GT - LC = -1.20 dB) QPSK									
Bandwidth	1.4M			3M			5M		
Channel	19957	20175	20393	19965	20175	20385	19975	20175	20375
	(Low)	(Mid)	(High)	(Low)	(Mid)	(High)	(Low)	(Mid)	(High)
Frequency (MHz)	1710.7	1732.5	1754.3	1711.5	1732.5	1753.5	1712.5	1732.5	1752.5
Conducted Power (dBm)	22.98	23.17	23.20	22.67	22.66	22.91	23.01	23.17	22.99
Conducted Power (Watts)	0.1986	0.2075	0.2089	0.1849	0.1845	0.1954	0.2000	0.2075	0.1991
EIRP(dBm)	21.78	21.97	22.00	21.47	21.46	21.71	21.81	21.97	21.79
EIRP(Watts)	0.1507	0.1574	0.1585	0.1403	0.1400	0.1483	0.1517	0.1574	0.1510

LTE Band 4 (GT - LC = -1.20 dB) QPSK									
Bandwidth	10M			15M			20M		
Channel	20000	20175	20350	20025	20175	20325	20050	20175	20300
	(Low)	(Mid)	(High)	(Low)	(Mid)	(High)	(Low)	(Mid)	(High)
Frequency (MHz)	1715	1732.5	1750	1717.5	1732.5	1747.5	1720	1732.5	1745
Conducted Power (dBm)	22.91	22.98	23.17	22.82	23.13	23.09	22.95	23.30	23.29
Conducted Power (Watts)	0.1954	0.1986	0.2075	0.1914	0.2056	0.2037	0.1972	0.2138	0.2133
EIRP(dBm)	21.71	21.78	21.97	21.62	21.93	21.89	21.75	22.10	22.09
EIRP(Watts)	0.1483	0.1507	0.1574	0.1452	0.1560	0.1545	0.1496	0.1622	0.1618



LTE Band 4 (GT - LC = -1.20 dB) 16QAM									
Bandwidth	1.4M			3M			5M		
Channel	19957	20175	20393	19965	20175	20385	19975	20175	20375
	(Low)	(Mid)	(High)	(Low)	(Mid)	(High)	(Low)	(Mid)	(High)
Frequency (MHz)	1710.7	1732.5	1754.3	1711.5	1732.5	1753.5	1712.5	1732.5	1752.5
Conducted Power (dBm)	21.81	21.56	22.35	21.61	21.72	21.65	21.50	21.52	21.79
Conducted Power (Watts)	0.1517	0.1432	0.1718	0.1449	0.1486	0.1462	0.1413	0.1419	0.1510
EIRP(dBm)	20.61	20.36	21.15	20.41	20.52	20.45	20.30	20.32	20.59
EIRP(Watts)	0.1151	0.1086	0.1303	0.1099	0.1127	0.1109	0.1072	0.1076	0.1146

LTE Band 4 (GT - LC = -1.20 dB) 16QAM									
Bandwidth	10M			15M			20M		
Channel	20000	20175	20350	20025	20175	20325	20050	20175	20300
	(Low)	(Mid)	(High)	(Low)	(Mid)	(High)	(Low)	(Mid)	(High)
Frequency (MHz)	1715	1732.5	1750	1717.5	1732.5	1747.5	1720	1732.5	1745
Conducted Power (dBm)	21.57	21.49	21.83	21.55	21.34	21.95	21.53	21.52	21.91
Conducted Power (Watts)	0.1435	0.1409	0.1524	0.1429	0.1361	0.1567	0.1422	0.1419	0.1552
EIRP(dBm)	20.37	20.29	20.63	20.35	20.14	20.75	20.33	20.32	20.71
EIRP(Watts)	0.1089	0.1069	0.1156	0.1084	0.1033	0.1189	0.1079	0.1076	0.1178



LTE Band 4 (G _T - L _C = -1.20 dB) 64QAM									
Bandwidth	1.4M			3M			5M		
Channel	19957	20175	20393	19965	20175	20385	19975	20175	20375
	(Low)	(Mid)	(High)	(Low)	(Mid)	(High)	(Low)	(Mid)	(High)
Frequency (MHz)	1710.7	1732.5	1754.3	1711.5	1732.5	1753.5	1712.5	1732.5	1752.5
Conducted Power (dBm)	21.89	22.00	21.90	21.34	21.48	21.71	21.94	21.56	21.93
Conducted Power (Watts)	0.1545	0.1585	0.1549	0.1361	0.1406	0.1483	0.1563	0.1432	0.1560
EIRP(dBm)	20.69	20.80	20.70	20.14	20.28	20.51	20.74	20.36	20.73
EIRP(Watts)	0.1172	0.1202	0.1175	0.1033	0.1067	0.1125	0.1186	0.1086	0.1183

LTE Band 4 (G _T - L _C = -1.20 dB) 64QAM									
Bandwidth	10M			15M			20M		
Channel	20000	20175	20350	20025	20175	20325	20050	20175	20300
	(Low)	(Mid)	(High)	(Low)	(Mid)	(High)	(Low)	(Mid)	(High)
Frequency (MHz)	1715	1732.5	1750	1717.5	1732.5	1747.5	1720	1732.5	1745
Conducted Power (dBm)	21.34	21.69	21.66	21.65	21.90	21.95	21.30	21.45	21.70
Conducted Power (Watts)	0.1361	0.1476	0.1466	0.1462	0.1549	0.1567	0.1349	0.1396	0.1479
EIRP(dBm)	20.14	20.49	20.46	20.45	20.70	20.75	20.10	20.25	20.50
EIRP(Watts)	0.1033	0.1119	0.1112	0.1109	0.1175	0.1189	0.1023	0.1059	0.1122



LTE Band 5 (GT - LC = -3.29 dB) QPSK									
Bandwidth	1.4M			3M			5M		
Channel	20407	20525	20643	20415	20525	20635	20425	20525	20625
	(Low)	(Mid)	(High)	(Low)	(Mid)	(High)	(Low)	(Mid)	(High)
Frequency (MHz)	824.7	836.5	848.3	825.5	836.5	847.5	826.5	836.5	846.5
Conducted Power (dBm)	23.84	23.72	23.83	23.51	23.05	23.48	23.65	23.73	23.81
Conducted Power (Watts)	0.2421	0.2355	0.2415	0.2244	0.2018	0.2228	0.2317	0.2360	0.2404
ERP(dBm)	18.40	18.28	18.39	18.07	17.61	18.04	18.21	18.29	18.37
ERP(Watts)	0.0692	0.0673	0.0690	0.0641	0.0577	0.0637	0.0662	0.0675	0.0687

LTE Band 5 (GT - LC = -3.29 dB) QPSK			
Bandwidth	10M		
Channel	20450	20525	20600
	(Low)	(Mid)	(High)
Frequency (MHz)	829	836.5	844
Conducted Power (dBm)	23.85	23.73	23.59
Conducted Power (Watts)	0.2427	0.2360	0.2286
ERP(dBm)	18.41	18.29	18.15
ERP(Watts)	0.0693	0.0675	0.0653



LTE Band 5 (GT - LC = -3.29 dB) 16QAM									
Bandwidth	1.4M			3M			5M		
Channel	20407	20525	20643	20415	20525	20635	20425	20525	20625
	(Low)	(Mid)	(High)	(Low)	(Mid)	(High)	(Low)	(Mid)	(High)
Frequency (MHz)	824.7	836.5	848.3	825.5	836.5	847.5	826.5	836.5	846.5
Conducted Power (dBm)	22.69	22.22	22.40	22.47	22.01	22.46	22.15	22.16	22.91
Conducted Power (Watts)	0.1858	0.1667	0.1738	0.1766	0.1589	0.1762	0.1641	0.1644	0.1954
ERP(dBm)	17.25	16.78	16.96	17.03	16.57	17.02	16.71	16.72	17.47
ERP(Watts)	0.0531	0.0476	0.0497	0.0505	0.0454	0.0504	0.0469	0.0470	0.0558

LTE Band 5 (GT - LC = -3.29 dB) 16QAM			
Bandwidth	10M		
Channel	20450	20525	20600
	(Low)	(Mid)	(High)
Frequency (MHz)	829	836.5	844
Conducted Power (dBm)	22.47	22.22	22.37
Conducted Power (Watts)	0.1766	0.1667	0.1726
ERP(dBm)	17.03	16.78	16.93
ERP(Watts)	0.0505	0.0476	0.0493



LTE Band 5 (G _T - L _C = -3.29 dB) 64QAM									
Bandwidth	1.4M			3M			5M		
Channel	20407	20525	20643	20415	20525	20635	20425	20525	20625
	(Low)	(Mid)	(High)	(Low)	(Mid)	(High)	(Low)	(Mid)	(High)
Frequency (MHz)	824.7	836.5	848.3	825.5	836.5	847.5	826.5	836.5	846.5
Conducted Power (dBm)	22.00	21.80	21.99	21.64	21.35	21.22	22.00	21.53	21.88
Conducted Power (Watts)	0.1585	0.1514	0.1581	0.1459	0.1365	0.1324	0.1585	0.1422	0.1542
ERP(dBm)	16.56	16.36	16.55	16.20	15.91	15.78	16.56	16.09	16.44
ERP(Watts)	0.0453	0.0433	0.0452	0.0417	0.0390	0.0378	0.0453	0.0406	0.0441

LTE Band 5 (G _T - L _C = -3.29 dB) 64QAM			
Bandwidth	10M		
Channel	20450	20525	20600
	(Low)	(Mid)	(High)
Frequency (MHz)	829	836.5	844
Conducted Power (dBm)	21.74	21.20	21.84
Conducted Power (Watts)	0.1493	0.1318	0.1528
ERP(dBm)	16.30	15.76	16.40
ERP(Watts)	0.0427	0.0377	0.0437



LTE Band 7 (GT - LC = 0.10 dB) QPSK			
Bandwidth	5M		
Channel	20775	21100	21425
	(Low)	(Mid)	(High)
Frequency	2502.5	2535	2567.5
(MHz)			
Conducted Power (dBm)	23.64	23.81	23.11
Conducted Power (Watts)	0.2312	0.2404	0.2046
EIRP(dBm)	23.74	23.91	23.21
EIRP(Watts)	0.2366	0.2460	0.2094

LTE Band 7 (GT - LC = 0.10 dB) QPSK									
Bandwidth	10M			15M			20M		
Channel	20800	21100	21400	20825	21100	21375	20850	21100	21350
	(Low)	(Mid)	(High)	(Low)	(Mid)	(High)	(Low)	(Mid)	(High)
Frequency	2505	2535	2565	2507.5	2535	2562.5	2510	2535	2560
(MHz)									
Conducted Power (dBm)	23.29	23.69	23.10	23.66	23.73	23.49	23.40	23.45	23.54
Conducted Power (Watts)	0.2133	0.2339	0.2042	0.2323	0.2360	0.2234	0.2188	0.2213	0.2259
EIRP(dBm)	23.39	23.79	23.20	23.76	23.83	23.59	23.50	23.55	23.64
EIRP(Watts)	0.2183	0.2393	0.2089	0.2377	0.2415	0.2286	0.2239	0.2265	0.2312



LTE Band 7 (GT - LC = 0.10 dB) 16QAM			
Bandwidth	5M		
Channel	20775	21100	21425
	(Low)	(Mid)	(High)
Frequency	2502.5	2535	2567.5
(MHz)			
Conducted Power (dBm)	22.10	22.26	21.94
Conducted Power (Watts)	0.1622	0.1683	0.1563
EIRP(dBm)	22.20	22.36	22.04
EIRP(Watts)	0.1660	0.1722	0.1600

LTE Band 7 (GT - LC = 0.10 dB) 16QAM									
Bandwidth	10M			15M			20M		
Channel	20800	21100	21400	20825	21100	21375	20850	21100	21350
	(Low)	(Mid)	(High)	(Low)	(Mid)	(High)	(Low)	(Mid)	(High)
Frequency	2505	2535	2565	2507.5	2535	2562.5	2510	2535	2560
(MHz)									
Conducted Power (dBm)	22.15	22.32	22.00	22.22	22.31	22.05	22.29	22.28	22.16
Conducted Power (Watts)	0.1641	0.1706	0.1585	0.1667	0.1702	0.1603	0.1694	0.1690	0.1644
EIRP(dBm)	22.25	22.42	22.10	22.32	22.41	22.15	22.39	22.38	22.26
EIRP(Watts)	0.1679	0.1746	0.1622	0.1706	0.1742	0.1641	0.1734	0.1730	0.1683



LTE Band 7 ($G_T - L_C = 0.10$ dB) 64QAM			
Bandwidth	5M		
Channel	20775	21100	21425
	(Low)	(Mid)	(High)
Frequency (MHz)	2502.5	2535	2567.5
	Conducted Power (dBm)	21.98	21.61
Conducted Power (Watts)	0.1578	0.1449	0.1567
EIRP(dBm)	22.08	21.71	22.05
EIRP(Watts)	0.1614	0.1483	0.1603

LTE Band 7 ($G_T - L_C = 0.10$ dB) 64QAM									
Bandwidth	10M			15M			20M		
Channel	20800	21100	21400	20825	21100	21375	20850	21100	21350
	(Low)	(Mid)	(High)	(Low)	(Mid)	(High)	(Low)	(Mid)	(High)
Frequency (MHz)	2505	2535	2565	2507.5	2535	2562.5	2510	2535	2560
	Conducted Power (dBm)	21.64	21.51	21.10	21.90	21.98	21.80	22.00	21.98
Conducted Power (Watts)	0.1459	0.1416	0.1288	0.1549	0.1578	0.1514	0.1585	0.1578	0.1510
EIRP(dBm)	21.74	21.61	21.20	22.00	22.08	21.90	22.10	22.08	21.89
EIRP(Watts)	0.1493	0.1449	0.1318	0.1585	0.1614	0.1549	0.1622	0.1614	0.1545



LTE Band 38 (GT - LC = -0.70 dB) QPSK			
Bandwidth	5M		
Channel	37775	38000	38225
	(Low)	(Mid)	(High)
Frequency	2572.5	2595	2617.5
(MHz)			
Conducted Power (dBm)	23.40	23.31	23.18
Conducted Power (Watts)	0.2188	0.2143	0.2080
EIRP(dBm)	22.70	22.61	22.48
EIRP(Watts)	0.1862	0.1824	0.1770

LTE Band 38 (GT - LC = -0.70 dB) QPSK									
Bandwidth	10M			15M			20M		
Channel	37800	38000	38200	37825	38000	38175	37850	38000	38150
	(Low)	(Mid)	(High)	(Low)	(Mid)	(High)	(Low)	(Mid)	(Mid)
Frequency	2575	2595	2615	2577.5	2595	2612.5	2580	2595	2610
(MHz)									
Conducted Power (dBm)	23.17	23.33	23.44	23.42	23.40	23.26	23.45	23.22	23.20
Conducted Power (Watts)	0.2075	0.2153	0.2208	0.2198	0.2188	0.2118	0.2213	0.2099	0.2089
EIRP(dBm)	22.47	22.63	22.74	22.72	22.70	22.56	22.75	22.52	22.50
EIRP(Watts)	0.1766	0.1832	0.1879	0.1871	0.1862	0.1803	0.1884	0.1786	0.1778



LTE Band 38 (GT - LC = -0.70 dB) 16QAM			
Bandwidth	5M		
Channel	37775	38000	38225
	(Low)	(Mid)	(High)
Frequency	2572.5	2595	2617.5
(MHz)			
Conducted Power (dBm)	22.21	22.23	21.75
Conducted Power (Watts)	0.1663	0.1671	0.1496
EIRP(dBm)	21.51	21.53	21.05
EIRP(Watts)	0.1416	0.1422	0.1274

LTE Band 38 (GT - LC = -0.70 dB) 16QAM									
Bandwidth	10M			15M			20M		
Channel	37800	38000	38200	37825	38000	38175	37850	38000	38150
	(Low)	(Mid)	(High)	(Low)	(Mid)	(High)	(Low)	(Mid)	(Mid)
Frequency	2575	2595	2615	2577.5	2595	2612.5	2580	2595	2610
(MHz)									
Conducted Power (dBm)	21.82	22.25	22.28	22.32	22.39	22.38	22.17	21.97	22.07
Conducted Power (Watts)	0.1521	0.1679	0.1690	0.1706	0.1734	0.1730	0.1648	0.1574	0.1611
EIRP(dBm)	21.12	21.55	21.58	21.62	21.69	21.68	21.47	21.27	21.37
EIRP(Watts)	0.1294	0.1429	0.1439	0.1452	0.1476	0.1472	0.1403	0.1340	0.1371



LTE Band 38 (G _T - L _C = -0.70 dB) 64QAM			
Bandwidth	5M		
Channel	37775	38000	38225
	(Low)	(Mid)	(High)
Frequency	2572.5	2595	2617.5
(MHz)			
Conducted Power (dBm)	21.89	21.79	21.81
Conducted Power (Watts)	0.1545	0.1510	0.1517
EIRP(dBm)	21.19	21.09	21.11
EIRP(Watts)	0.1315	0.1285	0.1291

LTE Band 38 (G _T - L _C = -0.70 dB) 64QAM									
Bandwidth	10M			15M			20M		
Channel	37800	38000	38200	37825	38000	38175	37850	38000	38150
	(Low)	(Mid)	(High)	(Low)	(Mid)	(High)	(Low)	(Mid)	(Mid)
Frequency	2575	2595	2615	2577.5	2595	2612.5	2580	2595	2610
(MHz)									
Conducted Power (dBm)	21.46	21.60	21.58	21.86	21.84	21.94	21.52	21.62	21.54
Conducted Power (Watts)	0.1400	0.1445	0.1439	0.1535	0.1528	0.1563	0.1419	0.1452	0.1426
EIRP(dBm)	20.76	20.90	20.88	21.16	21.14	21.24	20.82	20.92	20.84
EIRP(Watts)	0.1191	0.1230	0.1225	0.1306	0.1300	0.1330	0.1208	0.1236	0.1213



CA EIRP

LTE Band 7 CA (GT - LC = 0.10 dB) QPSK									
Bandwidth	15M + 15M			10M + 20M			20M+10M		
Channel PCC	20825	21025	21225	20805	21006	21206	20850	21051	21251
	(Low)	(Mid)	(High)	(Low)	(Mid)	(High)	(Low)	(Mid)	(High)
Channel SCC	20975	21175	21375	20949	21150	21350	20994	21195	21395
	(Low)	(Mid)	(High)	(Low)	(Mid)	(High)	(Low)	(Mid)	(High)
Conducted Power (dBm)	23.96	23.9	23.86	23.97	23.95	23.85	23.91	23.76	23.94
Conducted Power (Watts)	0.2489	0.2455	0.2432	0.2495	0.2483	0.2427	0.2460	0.2377	0.2477
EIRP(dBm)	24.06	24.00	23.96	24.07	24.05	23.95	24.01	23.86	24.04
EIRP(Watts)	0.2547	0.2512	0.2489	0.2553	0.2541	0.2483	0.2518	0.2432	0.2535

LTE Band 7 CA (GT - LC = 0.10 dB) QPSK									
Bandwidth	15M+20M			20M+15M			20M + 20M		
Channel PCC	20828	21003	21179	20850	21026	21201	20850	21001	21152
	(Low)	(Mid)	(High)	(Low)	(Mid)	(High)	(Low)	(Mid)	(High)
Channel SCC	20999	21174	21350	21021	21197	21372	21048	21199	21350
	(Low)	(Mid)	(High)	(Low)	(Mid)	(High)	(Low)	(Mid)	(High)
Conducted Power (dBm)	23.98	23.97	23.90	23.99	23.91	23.76	23.99	23.98	23.91
Conducted Power (Watts)	0.2500	0.2495	0.2455	0.2506	0.2460	0.2377	0.2506	0.2500	0.2460
EIRP(dBm)	24.08	24.07	24.00	24.09	24.01	23.86	24.09	24.08	24.01
EIRP(Watts)	0.2559	0.2553	0.2512	0.2564	0.2518	0.2432	0.2564	0.2559	0.2518



LTE Band 7 CA (GT - LC = 0.10 dB) 16QAM									
Bandwidth	15M + 15M			10M + 20M			20M+10M		
Channel PCC	20825	21025	21225	20805	21006	21206	20850	21051	21251
	(Low)	(Mid)	(High)	(Low)	(Mid)	(High)	(Low)	(Mid)	(High)
Channel SCC	20975	21175	21375	20949	21150	21350	20994	21195	21395
	(Low)	(Mid)	(High)	(Low)	(Mid)	(High)	(Low)	(Mid)	(High)
Conducted Power (dBm)	23.61	23.18	23.16	23.57	23.27	23.06	23.42	23.22	23.10
Conducted Power (Watts)	0.2296	0.2080	0.2070	0.2275	0.2123	0.2023	0.2198	0.2099	0.2042
EIRP(dBm)	23.71	23.28	23.26	23.67	23.37	23.16	23.52	23.32	23.20
EIRP(Watts)	0.2350	0.2128	0.2118	0.2328	0.2173	0.2070	0.2249	0.2148	0.2089

LTE Band 7 CA (GT - LC = 0.10 dB) 16QAM									
Bandwidth	15M+20M			20M+15M			20M + 20M		
Channel PCC	20828	21003	21179	20850	21026	21201	20850	21001	21152
	(Low)	(Mid)	(High)	(Low)	(Mid)	(High)	(Low)	(Mid)	(High)
Channel SCC	20999	21174	21350	21021	21197	21372	21048	21199	21350
	(Low)	(Mid)	(High)	(Low)	(Mid)	(High)	(Low)	(Mid)	(High)
Conducted Power (dBm)	23.53	23.16	23.16	23.62	23.23	23.00	23.83	23.49	23.76
Conducted Power (Watts)	0.2254	0.2070	0.2070	0.2301	0.2104	0.1995	0.2415	0.2234	0.2377
EIRP(dBm)	23.63	23.26	23.26	23.72	23.33	23.10	23.93	23.59	23.86
EIRP(Watts)	0.2307	0.2118	0.2118	0.2355	0.2153	0.2042	0.2472	0.2286	0.2432



LTE Band 7 CA (GT - LC = 0.10 dB) 64QAM									
Bandwidth	15M + 15M			10M + 20M			20M+10M		
Channel PCC	20825	21025	21225	20805	21006	21206	20850	21051	21251
	(Low)	(Mid)	(High)	(Low)	(Mid)	(High)	(Low)	(Mid)	(High)
Channel SCC	20975	21175	21375	20949	21150	21350	20994	21195	21395
	(Low)	(Mid)	(High)	(Low)	(Mid)	(High)	(Low)	(Mid)	(High)
Conducted Power (dBm)	20.59	20.56	20.58	20.64	20.64	20.76	20.64	20.63	20.88
Conducted Power (Watts)	0.1146	0.1138	0.1143	0.1159	0.1159	0.1191	0.1159	0.1156	0.1225
EIRP(dBm)	20.69	20.66	20.68	20.74	20.74	20.86	20.74	20.73	20.98
EIRP(Watts)	0.1172	0.1164	0.1169	0.1186	0.1186	0.1219	0.1186	0.1183	0.1253

LTE Band 7 CA (GT - LC = 0.10 dB) 64QAM									
Bandwidth	15M+20M			20M+15M			20M + 20M		
Channel PCC	20828	21003	21179	20850	21026	21201	20850	21001	21152
	(Low)	(Mid)	(High)	(Low)	(Mid)	(High)	(Low)	(Mid)	(High)
Channel SCC	20999	21174	21350	21021	21197	21372	21048	21199	21350
	(Low)	(Mid)	(High)	(Low)	(Mid)	(High)	(Low)	(Mid)	(High)
Conducted Power (dBm)	20.67	20.72	20.82	20.76	20.79	20.87	23.78	22.44	22.31
Conducted Power (Watts)	0.1167	0.1180	0.1208	0.1191	0.1199	0.1222	0.2388	0.1754	0.1702
EIRP(dBm)	20.77	20.82	20.92	20.86	20.89	20.97	23.88	22.54	22.41
EIRP(Watts)	0.1194	0.1208	0.1236	0.1219	0.1227	0.1250	0.2443	0.1795	0.1742



LTE Band 7 CA (GT - LC = 0.10 dB) QPSK			
Bandwidth	15M + 10M		
Channel PCC	20825	21025	21225
	(Low)	(Mid)	(High)
Channel SCC	20975	21175	21375
	(Low)	(Mid)	(High)
Conducted Power (dBm)	23.92	23.86	23.76
Conducted Power (Watts)	0.2466	0.2432	0.2377
EIRP(dBm)	24.02	23.96	23.86
EIRP(Watts)	0.2523	0.2489	0.2432

LTE Band 7 CA (GT - LC = 0.10 dB) 16QAM			
Bandwidth	15M + 10M		
Channel PCC	20825	21025	21225
	(Low)	(Mid)	(High)
Channel SCC	20975	21175	21375
	(Low)	(Mid)	(High)
Conducted Power (dBm)	23.57	23.33	22.78
Conducted Power (Watts)	0.2275	0.2153	0.1897
EIRP(dBm)	23.67	23.43	22.88
EIRP(Watts)	0.2328	0.2203	0.1941

LTE Band 7 CA (GT - LC = 0.10 dB) 64QAM			
Bandwidth	15M + 10M		
Channel PCC	20825	21025	21225
	(Low)	(Mid)	(High)
Channel SCC	20975	21175	21375
	(Low)	(Mid)	(High)
Conducted Power (dBm)	20.76	20.48	20.64
Conducted Power (Watts)	0.1191	0.1117	0.1159
EIRP(dBm)	20.86	20.58	20.74
EIRP(Watts)	0.1219	0.1143	0.1186



Peak-to-Average Ratio

Mode	LTE Band 2 / 20MHz				
Mod.	QPSK		16QAM		Limit: 13dB
RB Size	1RB	Full RB	1RB	Full RB	Result
Lowest CH	4.12	4.52	4.78	5.57	PASS
Middle CH	4.17	4.41	4.84	5.39	
Highest CH	4.06	4.41	4.78	5.42	
Mod.	64QAM		Limit: 13dB		
RB Size	1RB	Full RB	Result		
Lowest CH	5.77	6	PASS		
Middle CH	5.91	5.91			
Highest CH	5.71	5.97			

Mode	LTE Band 4 / 20MHz				
Mod.	QPSK		16QAM		Limit: 13dB
RB Size	1RB	Full RB	1RB	Full RB	Result
Lowest CH	4.75	5.07	5.3	5.94	PASS
Middle CH	4.81	4.93	5.51	6	
Highest CH	4.58	5.07	5.3	5.97	
Mod.	64QAM		Limit: 13dB		
RB Size	1RB	Full RB	Result		
Lowest CH	6.38	6.43	PASS		
Middle CH	6.49	6.41			
Highest CH	6.72	6.35			



Mode	LTE Band 5 / 10MHz				
Mod.	QPSK		16QAM		Limit: 13dB
RB Size	1RB	Full RB	1RB	Full RB	Result
Lowest CH	3.36	4.99	4.41	5.8	PASS
Middle CH	3.88	4.78	4.93	5.77	
Highest CH	3.45	4.43	4.49	5.42	
Mod.	64QAM		Limit: 13dB		
RB Size	1RB	Full RB	Result		
Lowest CH	5.1	6.29	PASS		
Middle CH	5.9	6.23			
Highest CH	5.51	5.88			

Mode	LTE Band 7 / 20MHz				
Mod.	QPSK		16QAM		Limit: 13dB
RB Size	1RB	Full RB	1RB	Full RB	Result
Lowest CH	4	4.67	5.13	5.80	PASS
Middle CH	4.06	4.52	4.93	5.51	
Highest CH	4.03	4.67	4.96	5.71	
Mod.	64QAM		Limit: 13dB		
RB Size	1RB	Full RB	Result		
Lowest CH	6	6.29	PASS		
Middle CH	5.77	6.09			
Highest CH	6.12	6.26			

Mode	LTE Band 38 / 20MHz				
Mod.	QPSK		16QAM		Limit: 13dB
RB Size	1RB	Full RB	1RB	Full RB	Result
Lowest CH	4.99	5.19	6.72	6.00	PASS
Middle CH	6.26	6.14	6.17	5.94	
Highest CH	4.81	4.99	6.70	5.94	
Mod.	64QAM		Limit: 13dB		
RB Size	1RB	Full RB	Result		
Lowest CH	6.35	6.49	PASS		
Middle CH	6.23	6.43			
Highest CH	6.32	6.49			



LTE Band 2 / 20MHz / QPSK

Lowest Channel / 1RB

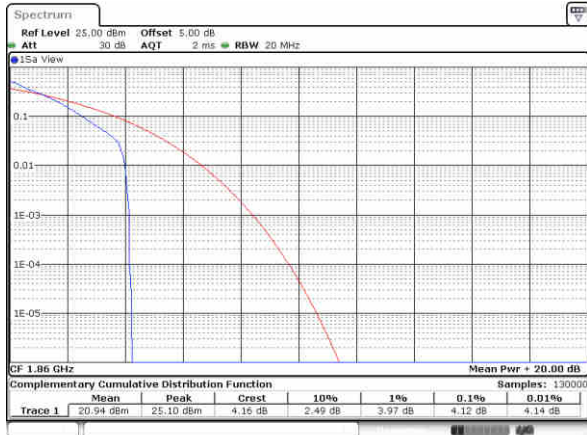

Date: 24 DEC 2018 15:03:16

Lowest Channel / Full RB

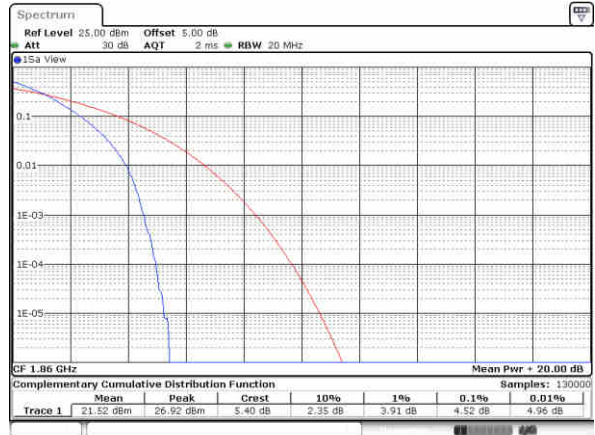

Date: 24 DEC 2018 15:02:45

Middle Channel / 1RB

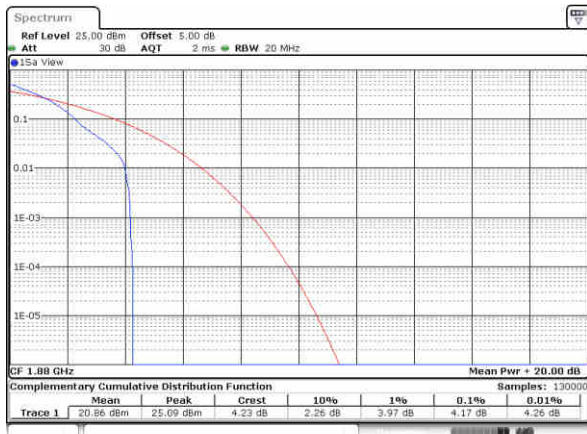

Date: 24 DEC 2018 15:03:26

Middle Channel / Full RB

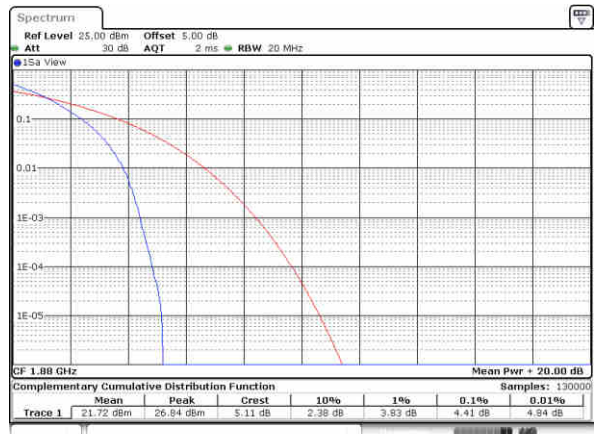

Date: 24 DEC 2018 15:03:57

Highest Channel / 1RB



Date: 24 DEC 2018 15:04:45

Highest Channel / Full RB

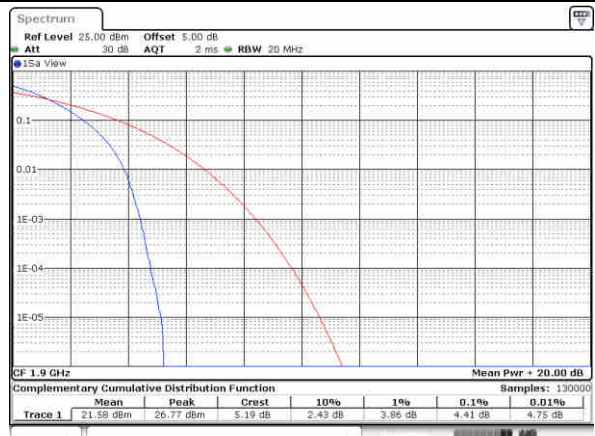

Date: 24 DEC 2018 15:04:12



LTE Band 2 / 20MHz / 16QAM

Lowest Channel / 1RB



Date: 24 DEC 2018 11:19:23

Lowest Channel / Full RB

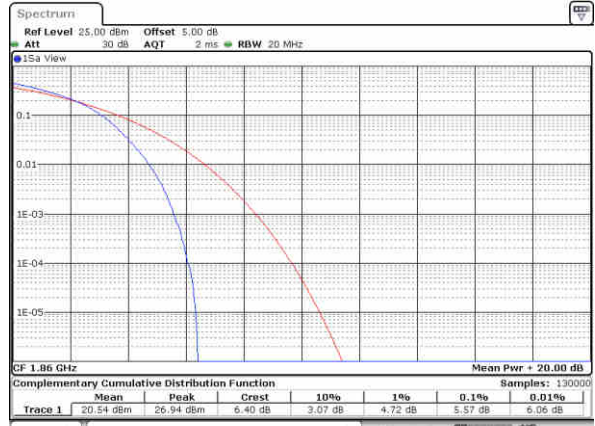

Date: 24 DEC 2018 11:19:33

Middle Channel / 1RB

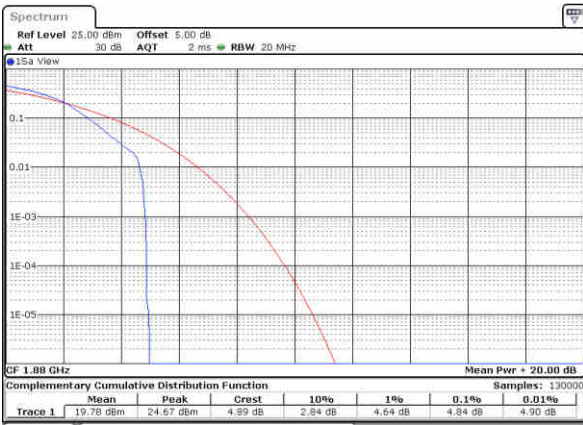

Date: 24 DEC 2018 11:19:42

Middle Channel / Full RB

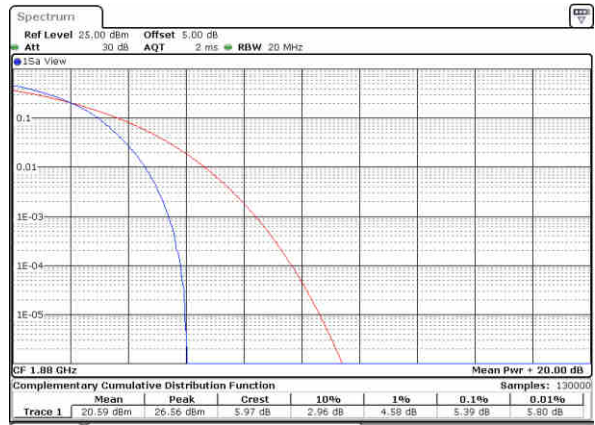

Date: 24 DEC 2018 11:19:51

Highest Channel / 1RB



Date: 24 DEC 2018 11:20:00

Highest Channel / Full RB



Date: 24 DEC 2018 11:20:10



LTE Band 2 / 20MHz / 64QAM

Lowest Channel / 1RB

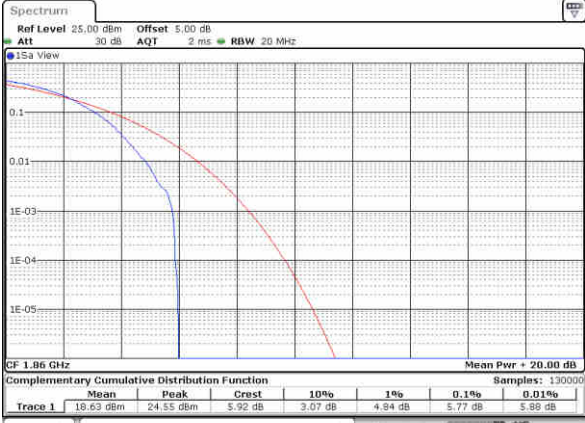

Date: 24 DEC 2018 15:03:06

Lowest Channel / Full RB



Date: 24 DEC 2018 15:02:55

Middle Channel / 1RB

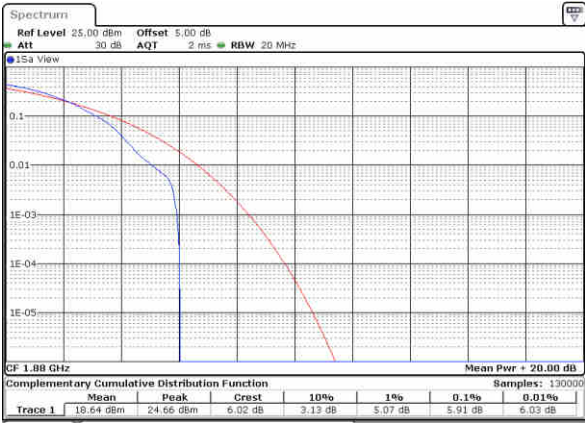

Date: 24 DEC 2018 15:03:37

Middle Channel / Full RB

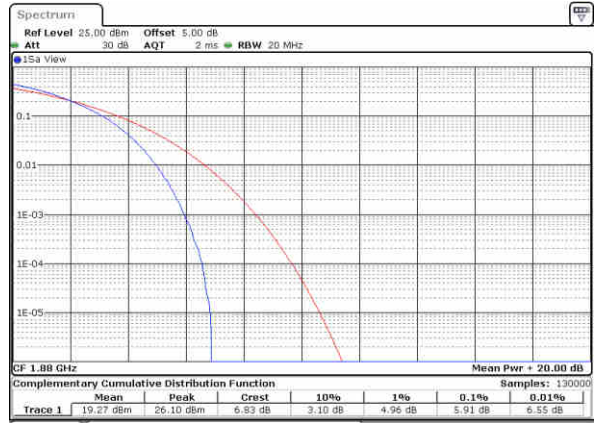

Date: 24 DEC 2018 15:03:47

Highest Channel / 1RB

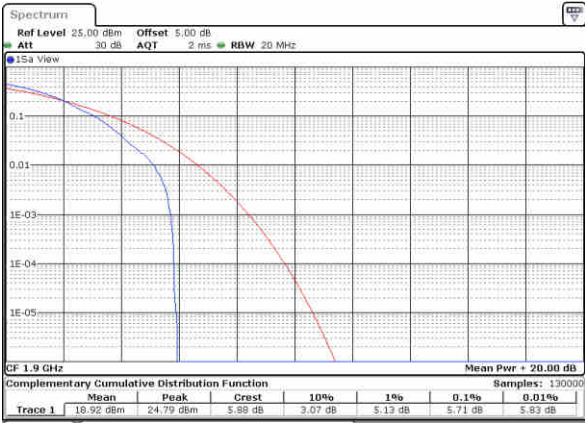

Date: 24 DEC 2018 15:04:34

Highest Channel / Full RB

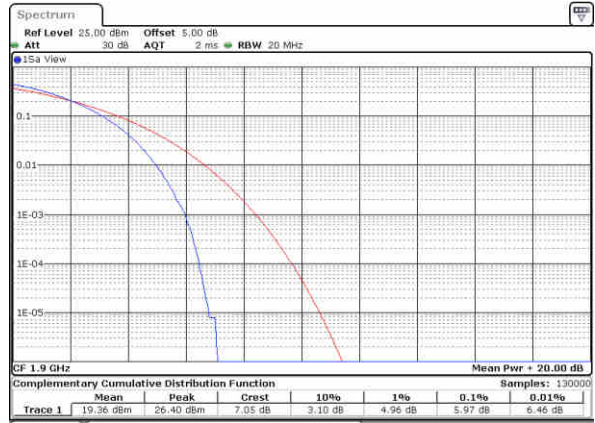

Date: 24 DEC 2018 15:04:23



LTE Band 4 / 20MHz / QPSK

Lowest Channel / 1RB

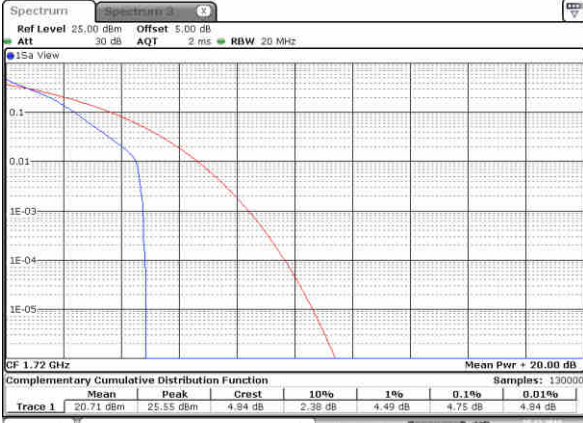

Date: 25 DEC 2018 13:24:30

Lowest Channel / Full RB

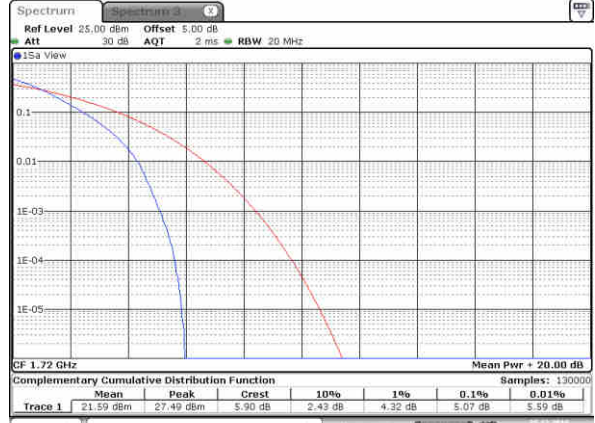

Date: 25 DEC 2018 13:24:41

Middle Channel / 1RB

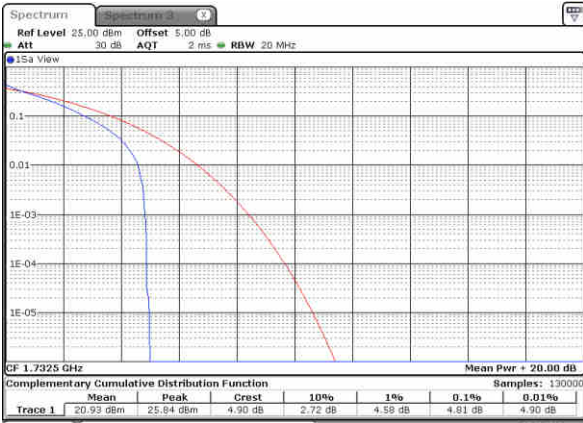

Date: 25 DEC 2018 13:25:03

Middle Channel / Full RB

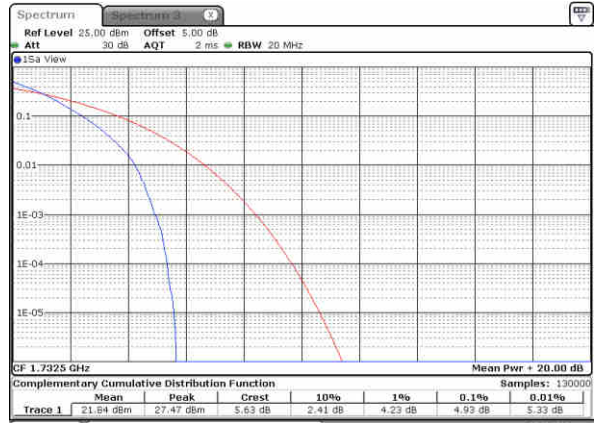

Date: 25 DEC 2018 13:24:52

Highest Channel / 1RB

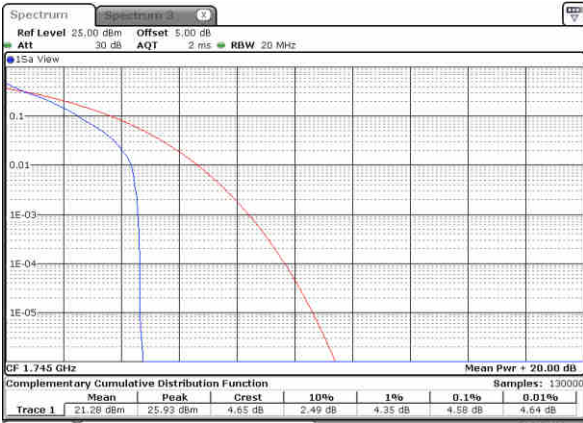

Date: 25 DEC 2018 13:25:15

Highest Channel / Full RB

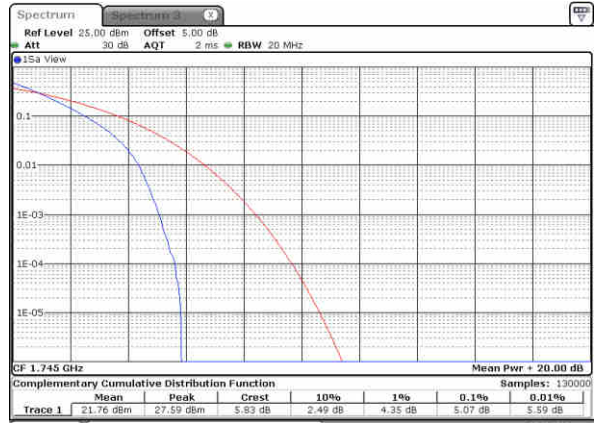

Date: 25 DEC 2018 13:25:26



LTE Band 4 / 20MHz / 16QAM

Lowest Channel / 1RB



Date: 24 DEC 2018 16:51:35

Lowest Channel / Full RB

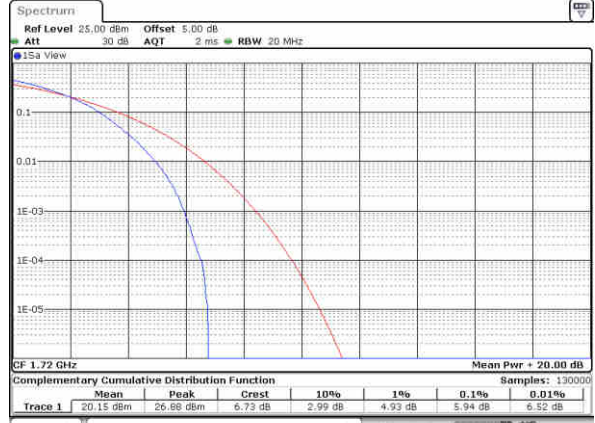

Date: 24 DEC 2018 16:51:44

Middle Channel / 1RB

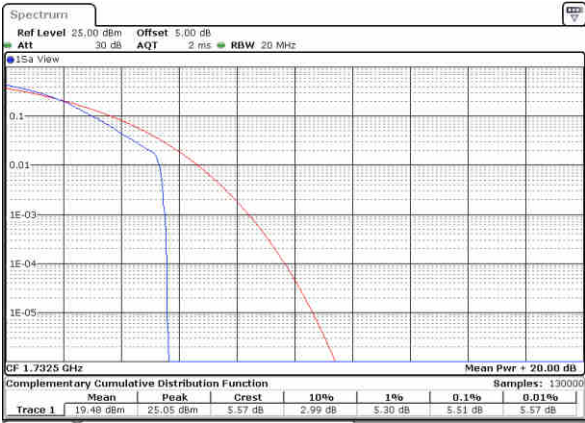

Date: 24 DEC 2018 16:51:54

Middle Channel / Full RB

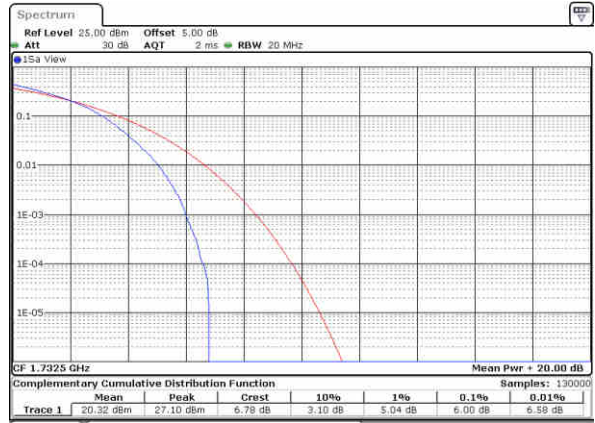

Date: 24 DEC 2018 16:52:03

Highest Channel / 1RB



Date: 24 DEC 2018 16:52:13

Highest Channel / Full RB

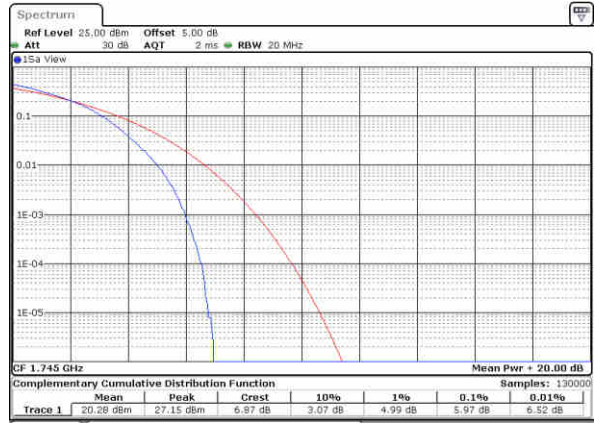

Date: 24 DEC 2018 16:52:22



LTE Band 4 / 20MHz / 64QAM

Lowest Channel / 1RB

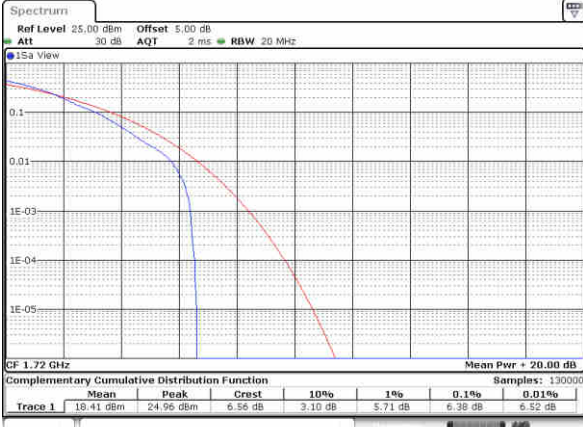

Date: 24 DEC 2018 17:49:57

Lowest Channel / Full RB

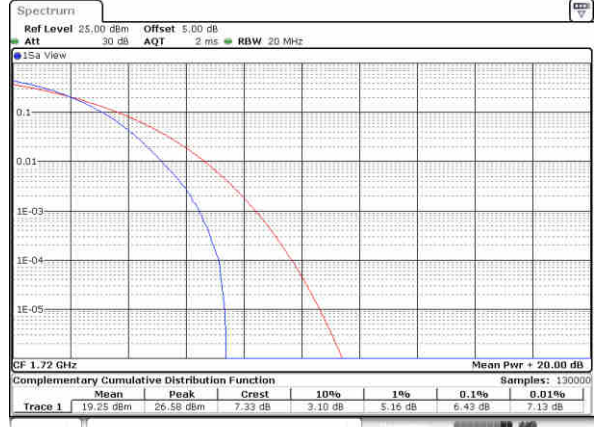

Date: 24 DEC 2018 17:50:07

Middle Channel / 1RB

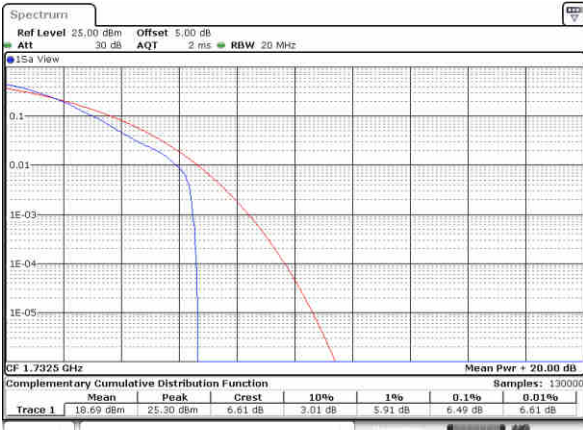

Date: 24 DEC 2018 17:50:17

Middle Channel / Full RB

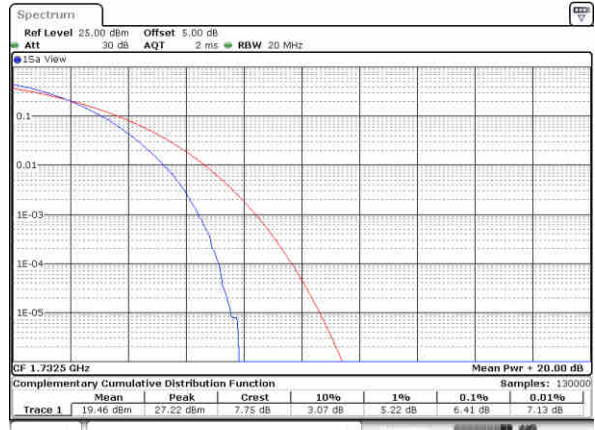

Date: 24 DEC 2018 17:50:26

Highest Channel / 1RB

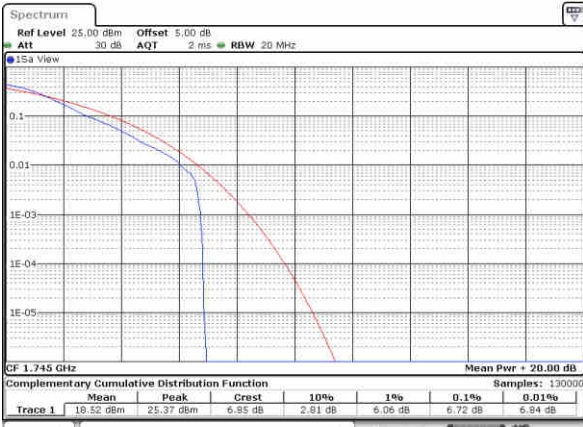

Date: 24 DEC 2018 17:50:35

Highest Channel / Full RB

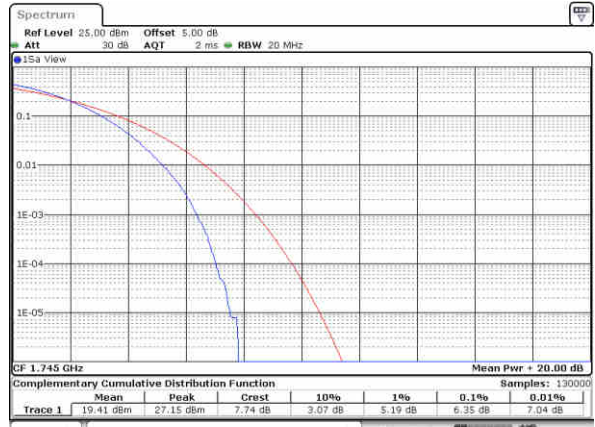

Date: 24 DEC 2018 17:50:44



LTE Band 5 / 10MHz / QPSK

Lowest Channel / 1RB

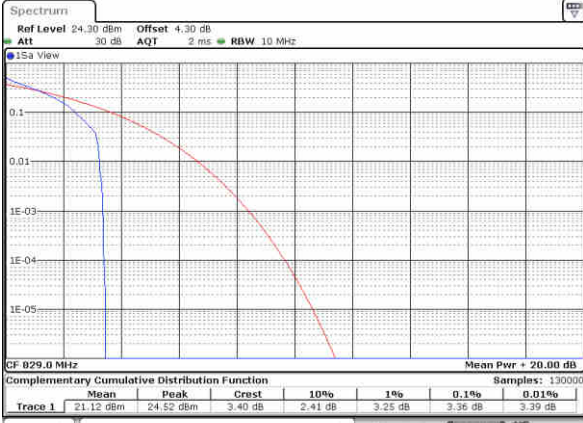

Date: 28 DEC 2018 16:56:47

Lowest Channel / Full RB



Date: 28 DEC 2018 16:57:23

Middle Channel / 1RB

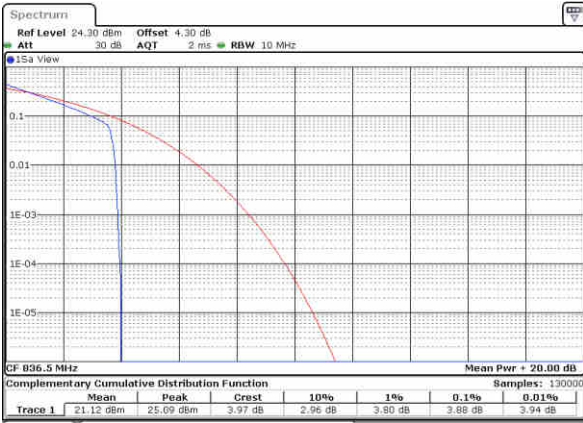

Date: 28 DEC 2018 16:58:10

Middle Channel / Full RB

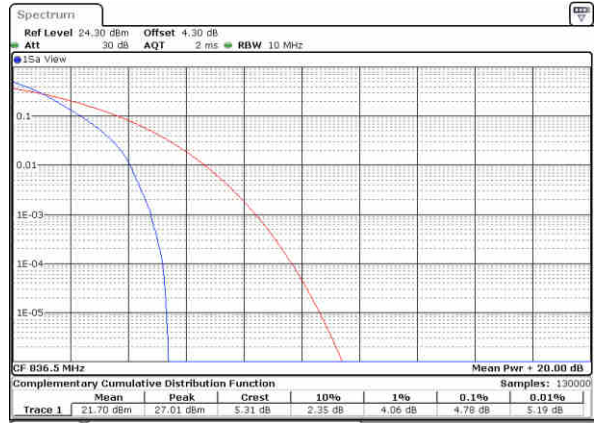

Date: 28 DEC 2018 16:57:36

Highest Channel / 1RB

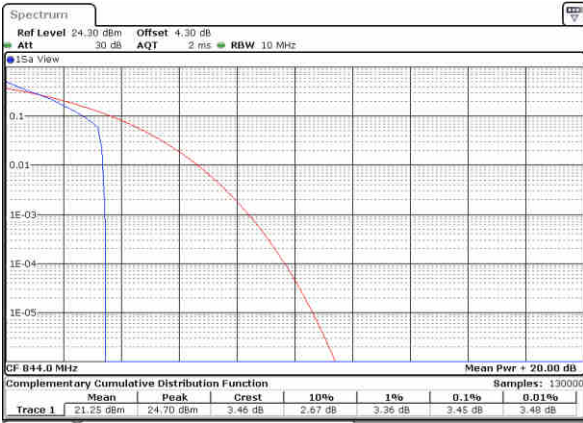

Date: 28 DEC 2018 16:58:22

Highest Channel / Full RB

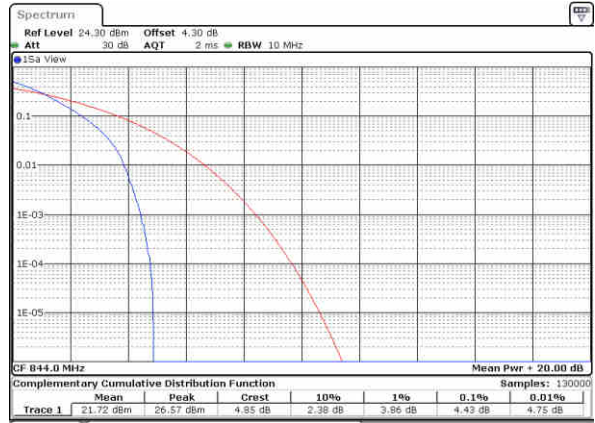

Date: 28 DEC 2018 16:58:33



LTE Band 5 / 10MHz / 16QAM

Lowest Channel / 1RB

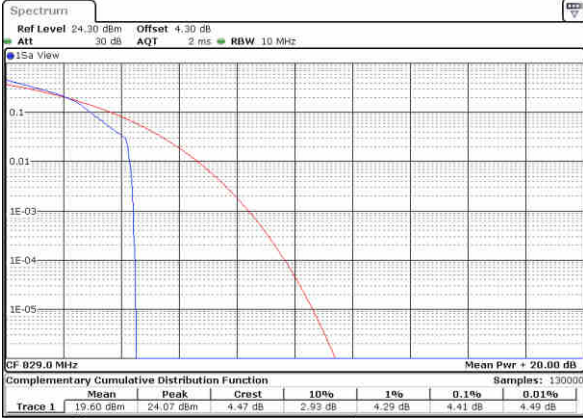

Date: 28 DEC 2018 16:59:31

Lowest Channel / Full RB

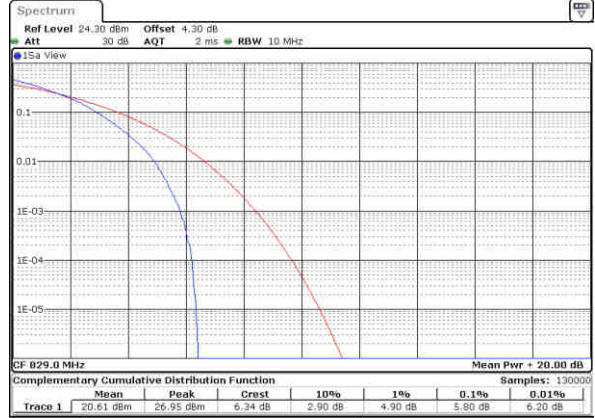

Date: 28 DEC 2018 16:57:12

Middle Channel / 1RB

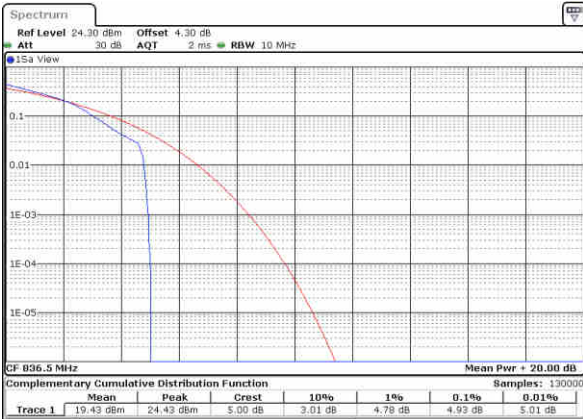

Date: 28 DEC 2018 16:57:59

Middle Channel / Full RB

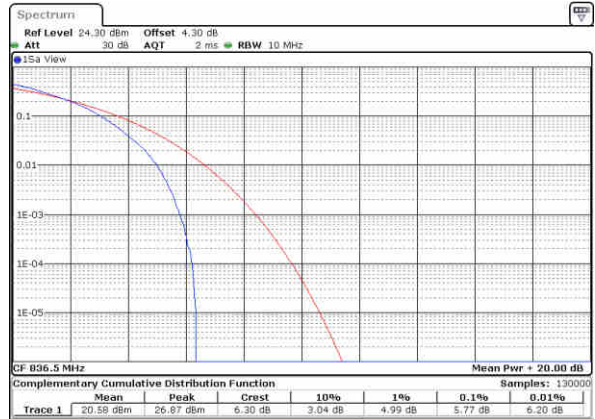

Date: 28 DEC 2018 16:57:47

Highest Channel / 1RB

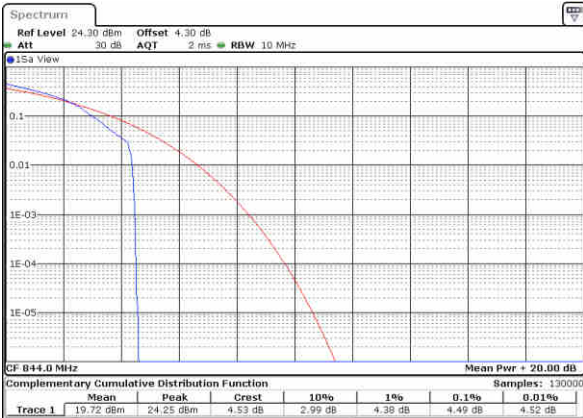

Date: 28 DEC 2018 16:59:05

Highest Channel / Full RB

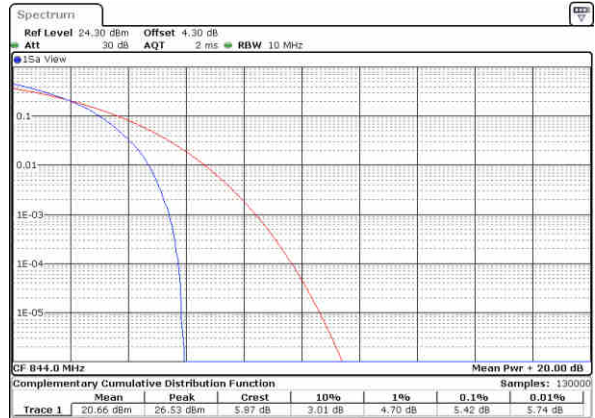

Date: 28 DEC 2018 16:58:44



LTE Band 5 / 10MHz / 64QAM

Lowest Channel / 1RB

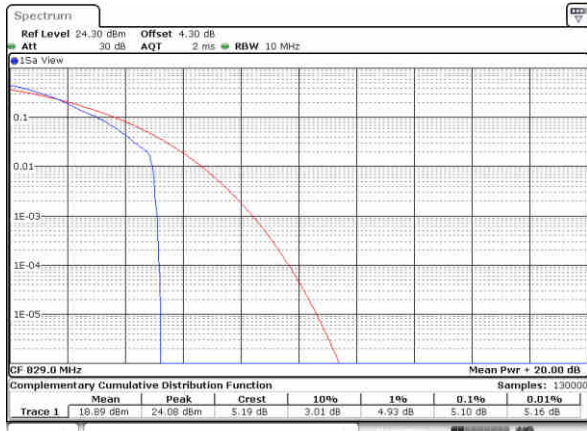

Date: 28 DEC 2018 16:51:59

Lowest Channel / Full RB

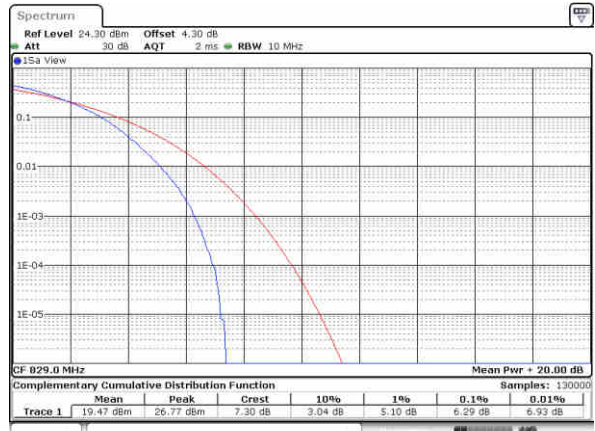

Date: 28 DEC 2018 16:52:07

Middle Channel / 1RB

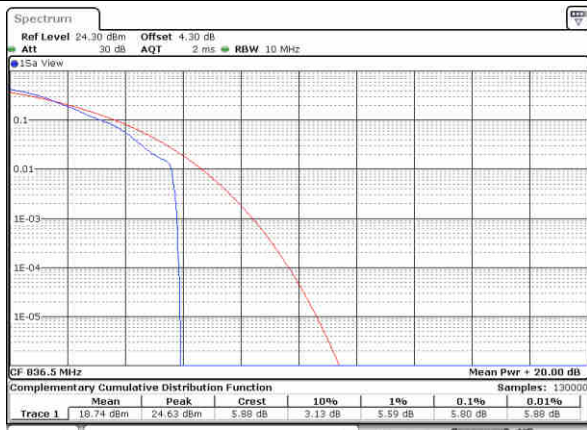

Date: 28 DEC 2018 16:51:50

Middle Channel / Full RB

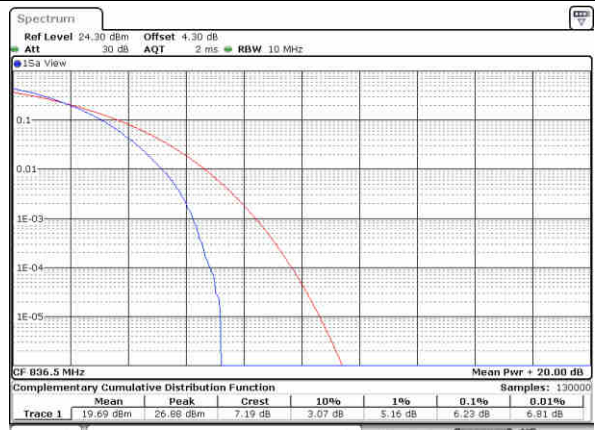

Date: 28 DEC 2018 16:51:41

Highest Channel / 1RB

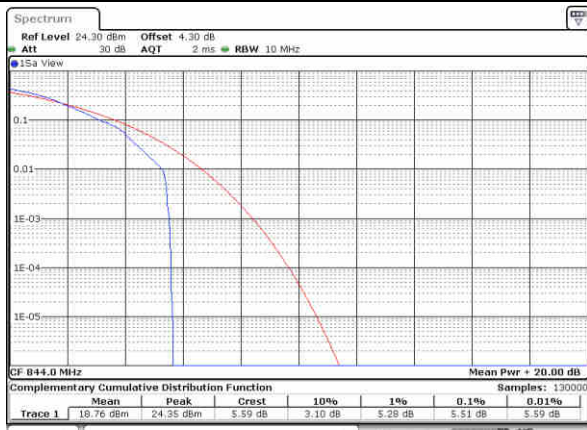

Date: 28 DEC 2018 16:51:24

Highest Channel / Full RB

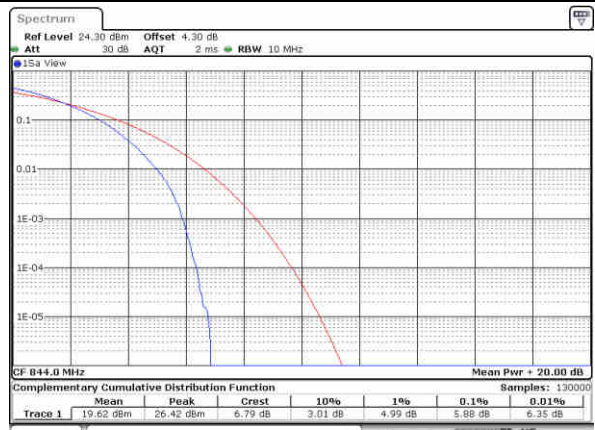

Date: 28 DEC 2018 16:51:32



LTE Band 7 / 20MHz / QPSK

Lowest Channel / 1RB

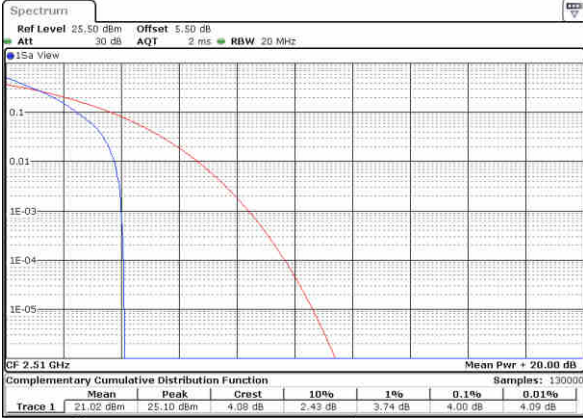

Date: 4 JAN 2019 17:19:56

Lowest Channel / Full RB

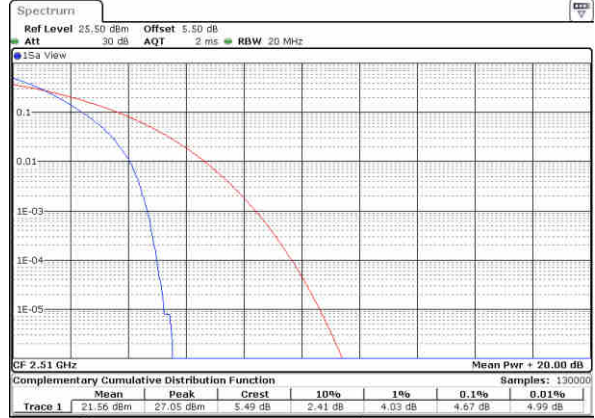

Date: 4 JAN 2019 17:20:05

Middle Channel / 1RB

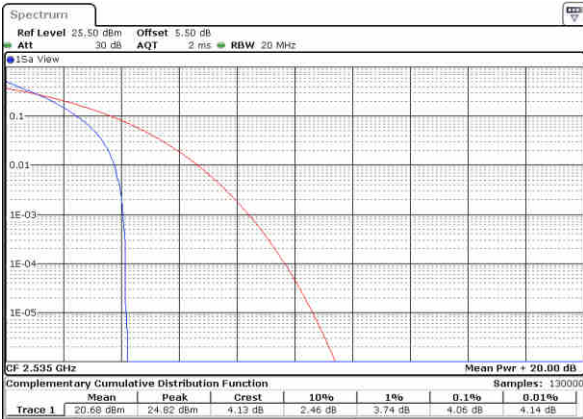

Date: 4 JAN 2019 17:20:41

Middle Channel / Full RB



Date: 4 JAN 2019 17:20:32

Highest Channel / 1RB



Date: 4 JAN 2019 17:21:08

Highest Channel / Full RB

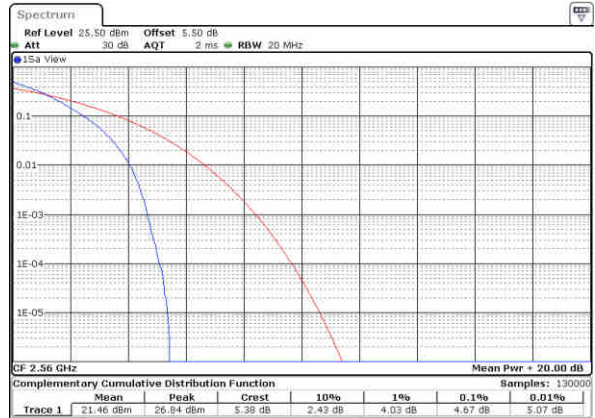

Date: 4 JAN 2019 17:21:17



LTE Band 7 / 20MHz / 16QAM

Lowest Channel / 1RB



Date: 4 JAN 2019 17:19:48

Lowest Channel / Full RB

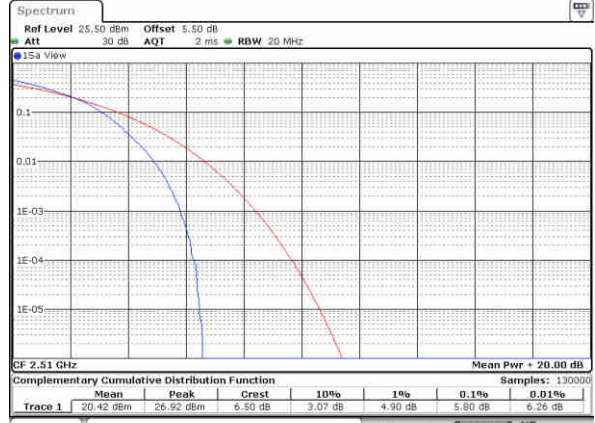

Date: 4 JAN 2019 17:20:14

Middle Channel / 1RB



Date: 4 JAN 2019 17:20:50

Middle Channel / Full RB



Date: 4 JAN 2019 17:20:23

Highest Channel / 1RB

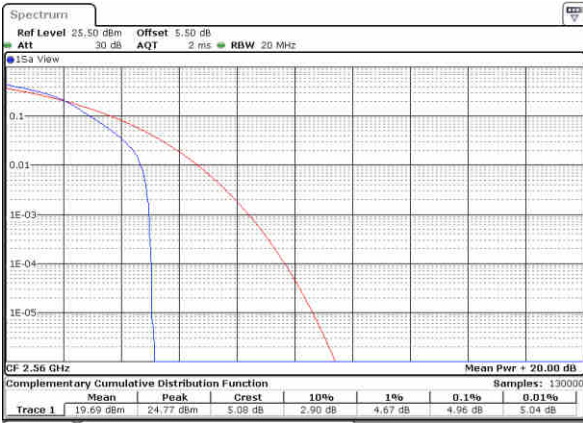

Date: 4 JAN 2019 17:20:59

Highest Channel / Full RB

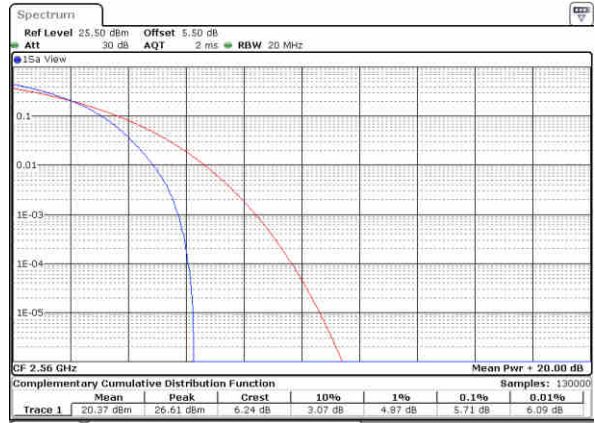

Date: 4 JAN 2019 17:21:28



LTE Band 7 / 20MHz / 64QAM

Lowest Channel / 1RB

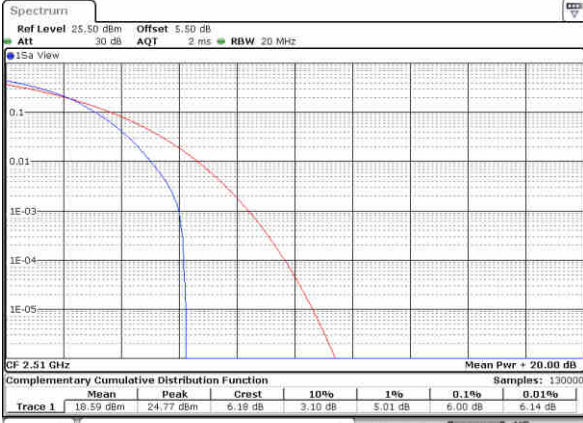

Date: 4 JAN 2019 16:16:03

Lowest Channel / Full RB

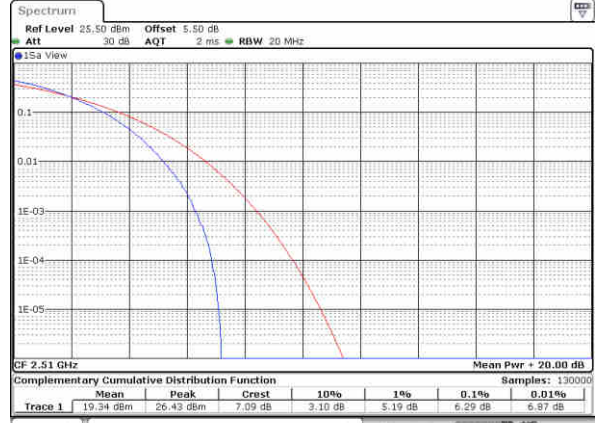

Date: 4 JAN 2019 16:16:12

Middle Channel / 1RB

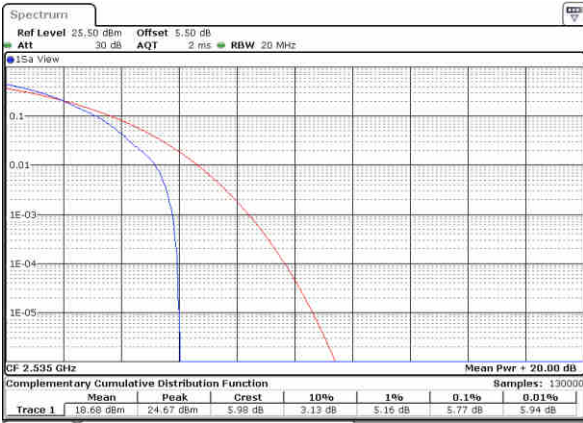

Date: 4 JAN 2019 16:16:30

Middle Channel / Full RB

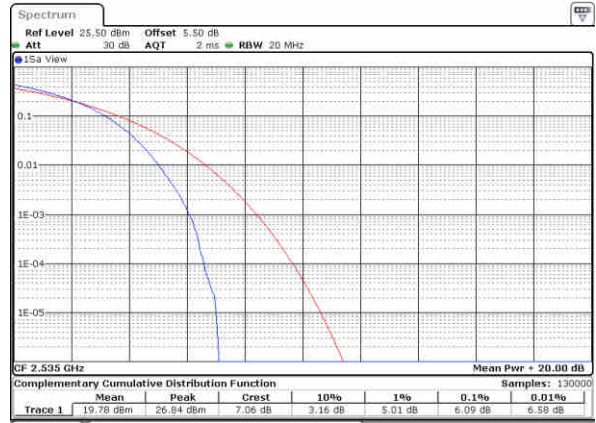

Date: 4 JAN 2019 16:16:21

Highest Channel / 1RB



Date: 4 JAN 2019 16:16:39

Highest Channel / Full RB

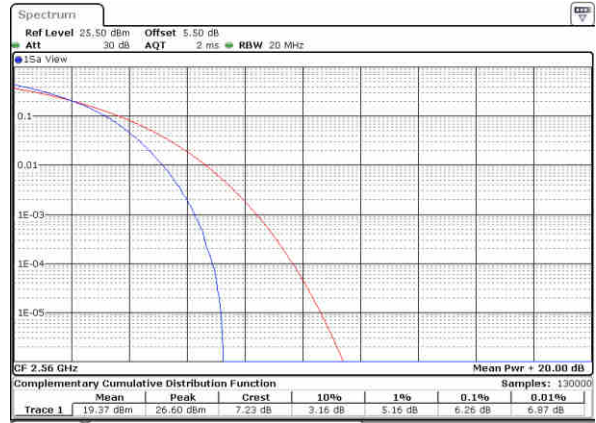

Date: 4 JAN 2019 16:16:48



LTE Band 38 / 20MHz / QPSK

Lowest Channel / 1RB



Date: 7 JAN 2019 19:31:02

Lowest Channel / Full RB



Date: 7 JAN 2019 19:27:18

Middle Channel / 1RB

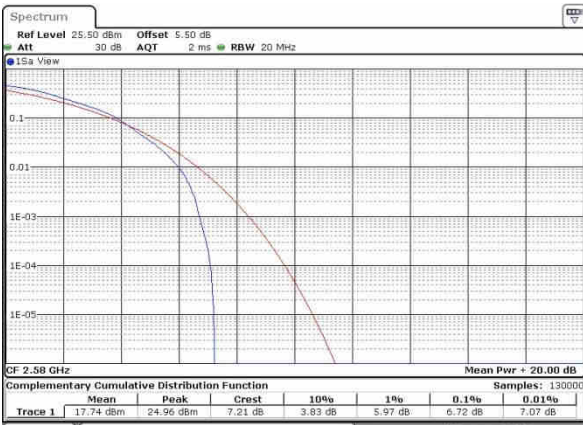

Date: 7 JAN 2019 19:31:26

Middle Channel / Full RB



Date: 7 JAN 2019 19:25:57

Highest Channel / 1RB



Date: 7 JAN 2019 19:35:58

Highest Channel / Full RB

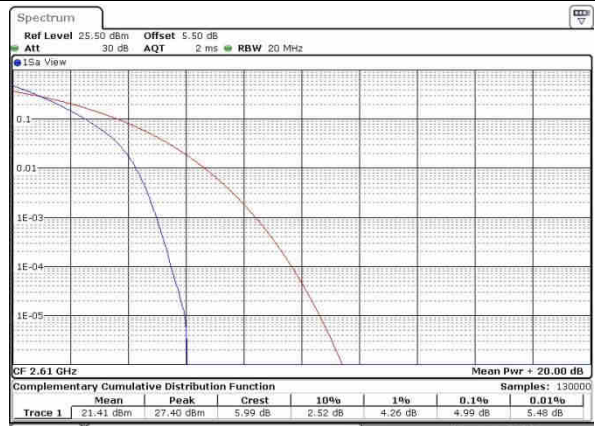

Date: 7 JAN 2019 19:18:01



LTE Band 38 / 20MHz / 16QAM

Lowest Channel / 1RB



Date: 7 JAN 2019 19:31:26

Lowest Channel / Full RB



Date: 7 JAN 2019 19:25:57

Middle Channel / 1RB



Date: 7 JAN 2019 19:34:50

Middle Channel / Full RB

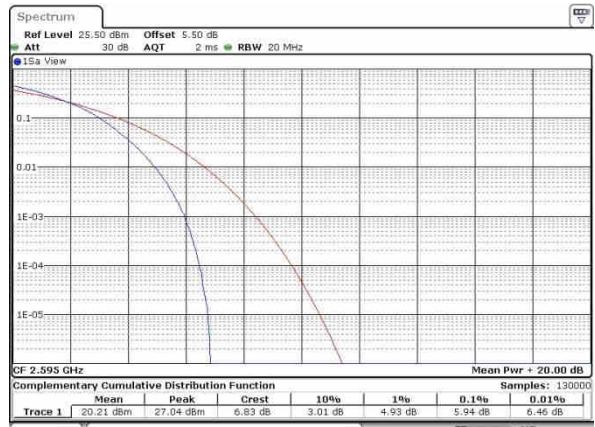

Date: 7 JAN 2019 19:21:04

Highest Channel / 1RB

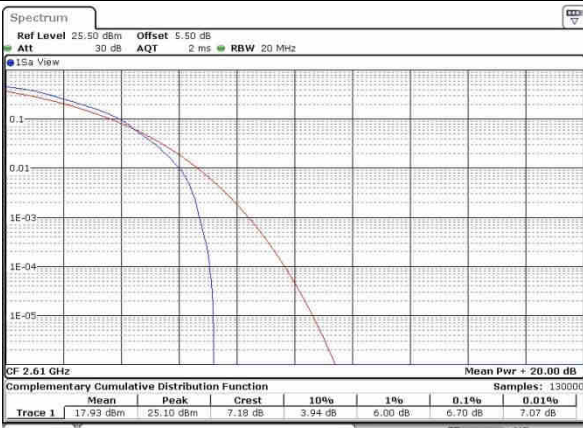

Date: 7 JAN 2019 19:36:30

Highest Channel / Full RB

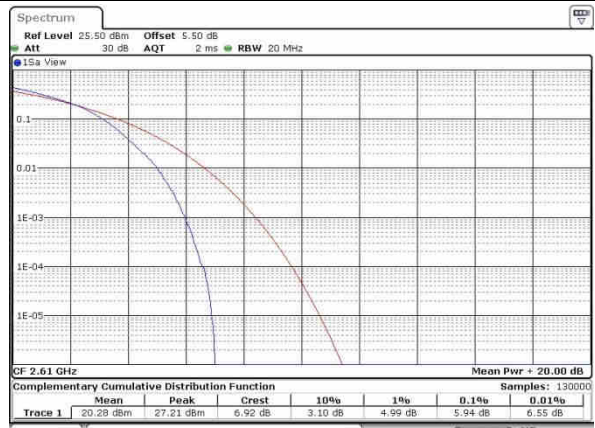

Date: 7 JAN 2019 19:17:00



LTE Band 38 / 20MHz / 64QAM

Lowest Channel / 1RB



Date: 7 JAN 2019 19:32:02

Lowest Channel / Full RB



Date: 7 JAN 2019 19:24:56

Middle Channel / 1RB



Date: 7 JAN 2019 19:33:48

Middle Channel / Full RB



Date: 7 JAN 2019 19:23:10

Highest Channel / 1RB



Date: 7 JAN 2019 19:36:50

Highest Channel / Full RB



Date: 7 JAN 2019 19:15:38



26dB Bandwidth

Mode	LTE Band 2 : 26dB BW(MHz)											
BW	1.4MHz		3MHz		5MHz		10MHz		15MHz		20MHz	
Mod.	QPSK	16QAM	QPSK	16QAM	QPSK	16QAM	QPSK	16QAM	QPSK	16QAM	QPSK	16QAM
Lowest CH	1.259	1.284	2.973	2.997	4.985	4.875	9.73	9.89	14.266	14.535	20.18	20.18
Middle CH	1.287	1.290	2.979	3.039	4.965	4.885	9.67	9.75	14.356	14.356	20.22	20.02
Highest CH	1.281	1.273	3.027	3.003	4.925	4.895	9.85	9.85	14.655	14.446	20.18	20.18
Mode	LTE Band 2 : 26dB BW(MHz)											
BW	1.4MHz		3MHz		5MHz		10MHz		15MHz		20MHz	
Mod.	64QAM		64QAM		64QAM		64QAM		64QAM		64QAM	
Lowest CH	1.292		3.015		4.905		10.03		14.296		20.06	
Middle CH	1.295		3.039		4.885		9.77		14.535		20.10	
Highest CH	1.278		3.033		4.795		9.89		14.386		20.30	

Mode	LTE Band 4 : 26dB BW(MHz)											
BW	1.4MHz		3MHz		5MHz		10MHz		15MHz		20MHz	
Mod.	QPSK	16QAM	QPSK	16QAM	QPSK	16QAM	QPSK	16QAM	QPSK	16QAM	QPSK	16QAM
Lowest CH	1.281	1.290	2.991	3.045	4.825	4.895	9.73	9.95	14.326	14.446	20.42	20.14
Middle CH	1.281	1.270	3.015	3.021	4.945	4.905	9.91	9.67	14.356	14.356	20.22	20.02
Highest CH	1.242	1.290	2.973	2.985	4.895	4.925	9.75	9.67	14.446	14.206	20.10	20.14
Mode	LTE Band 4 : 26dB BW(MHz)											
BW	1.4MHz		3MHz		5MHz		10MHz		15MHz		20MHz	
Mod.	64QAM		64QAM		64QAM		64QAM		64QAM		64QAM	
Lowest CH	1.262		3.015		4.905		9.71		14.236		19.94	
Middle CH	1.264		2.997		4.955		9.83		14.356		20.18	
Highest CH	1.270		3.009		4.965		9.63		14.266		20.06	



LTE Band 5 : 26dB BW(MHz)												
Mode	1.4MHz		3MHz		5MHz		10MHz		15MHz		20MHz	
BW	1.4MHz	3MHz	5MHz	10MHz	15MHz	20MHz						
Mod.	QPSK	16QAM	QPSK	16QAM	QPSK	16QAM	QPSK	16QAM	QPSK	16QAM	QPSK	16QAM
Lowest CH	1.309	1.259	2.991	3.003	4.965	4.945	9.87	9.85				
Middle CH	1.273	1.264	3.003	3.021	4.935	4.855	9.89	9.83				
Highest CH	1.276	1.292	3.009	3.039	4.875	4.795	9.91	9.79				

LTE Band 5 : 26dB BW(MHz)												
Mode	1.4MHz		3MHz		5MHz		10MHz		15MHz		20MHz	
BW	1.4MHz	3MHz	5MHz	10MHz	15MHz	20MHz						
Mod.	64QAM	64QAM	64QAM	64QAM	64QAM	64QAM						
Lowest CH	1.292		2.967		4.955		9.79					
Middle CH	1.290		2.967		4.905		9.95					
Highest CH	1.301		3.009		4.905		9.71					

LTE Band 7 : 26dB BW(MHz)												
Mode	1.4MHz		3MHz		5MHz		10MHz		15MHz		20MHz	
BW	1.4MHz	3MHz	5MHz	10MHz	15MHz	20MHz						
Mod.	QPSK	16QAM	QPSK	16QAM	QPSK	16QAM	QPSK	16QAM	QPSK	16QAM	QPSK	16QAM
Lowest CH					4.905	4.925	9.97	9.85	14.476	14.356	20.18	19.98
Middle CH					4.905	4.955	9.81	9.79	14.266	14.326	20.22	20.06
Highest CH					4.825	4.935	9.83	9.71	14.446	14.326	20.06	20.30

LTE Band 7 : 26dB BW(MHz)												
Mode	1.4MHz		3MHz		5MHz		10MHz		15MHz		20MHz	
BW	1.4MHz	3MHz	5MHz	10MHz	15MHz	20MHz						
Mod.	64QAM	64QAM	64QAM	64QAM	64QAM	64QAM						
Lowest CH					4.805		9.69		14.416		20.50	
Middle CH					4.965		9.87		14.505		20.14	
Highest CH					4.975		9.85		14.416		20.10	

LTE Band 38 : 26dB BW(MHz)												
Mode	1.4MHz		3MHz		5MHz		10MHz		15MHz		20MHz	
BW	1.4MHz	3MHz	5MHz	10MHz	15MHz	20MHz						
Mod.	QPSK	16QAM	QPSK	16QAM	QPSK	16QAM	QPSK	16QAM	QPSK	16QAM	QPSK	16QAM
Lowest CH					4.925	4.905	9.63	9.75	14.446	14.476	20.42	20.02
Middle CH					4.865	4.845	9.67	9.97	14.176	14.116	20.02	20.14
Highest CH					4.945	4.875	9.83	9.71	14.655	14.266	20.14	20.14

LTE Band 38 : 26dB BW(MHz)												
Mode	1.4MHz		3MHz		5MHz		10MHz		15MHz		20MHz	
BW	1.4MHz	3MHz	5MHz	10MHz	15MHz	20MHz						
Mod.	64QAM	64QAM	64QAM	64QAM	64QAM	64QAM						
Lowest CH					4.815		9.81		14.326		20.10	
Middle CH					4.745		9.63		14.206		20.10	
Highest CH					4.885		9.81		14.356		20.18	



Mode	LTE Band 7C : 26dB BW(MHz)			
QPSK				
BW	10MHz+20MHz	-	15MHz+10MHz	15MHz+15MHz
Lowest CH	29.97	-	25.325	30.509
Middle CH	29.91	-	25.524	30.629
Highest CH	29.97	-	25.425	30.749
BW	15MHz+20MHz	20MHz+10MHz	20MHz+15MHz	20MHz+20MHz
Lowest CH	34.755	29.91	34.755	39.8
Middle CH	34.895	30.03	35.035	39.8
Highest CH	34.895	30.15	34.965	39.88

Mode	LTE Band 7 : 26dB BW(MHz)			
16QAM				
BW	10MHz+20MHz	-	15MHz+10MHz	15MHz+15MHz
Lowest CH	29.85	-	25.425	30.45
Middle CH	29.85	-	25.524	30.39
Highest CH	29.67	-	25.275	30.33
BW	15MHz+20MHz	20MHz+10MHz	20MHz+15MHz	20MHz+20MHz
Lowest CH	34.825	30.09	34.755	39.8
Middle CH	34.965	30.03	34.895	39.8
Highest CH	34.755	30.03	34.755	39.64

Mode	LTE Band 7 : 26dB BW(MHz)			
64QAM				
BW	10MHz+20MHz	-	15MHz+10MHz	15MHz+15MHz
Lowest CH	29.73	-	25.375	30.509
Middle CH	29.91	-	25.275	30.509
Highest CH	29.85	-	25.225	30.509
BW	15MHz+20MHz	20MHz+10MHz	20MHz+15MHz	20MHz+20MHz
Lowest CH	34.755	29.97	34.895	39.72
Middle CH	34.825	30.09	34.895	39.72
Highest CH	34.825	29.91	34.895	39.72



LTE Band 2

Lowest Channel / 1.4MHz / QPSK

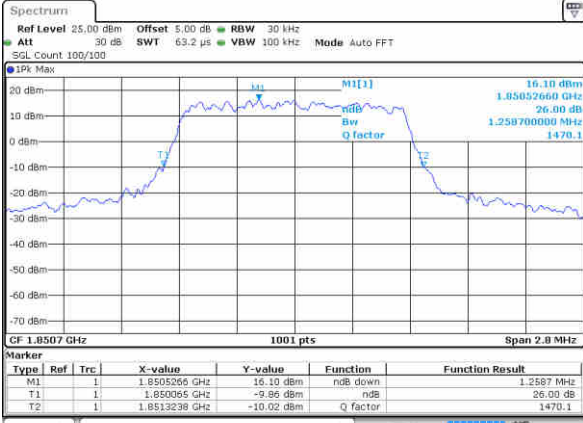

Date: 24 DEC 2018 09:31:27

Lowest Channel / 1.4MHz / 16QAM

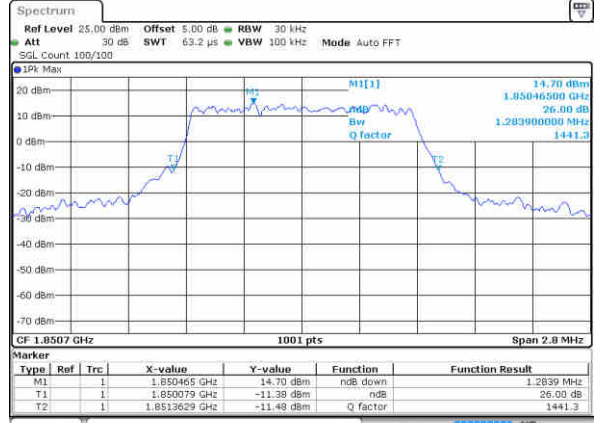

Date: 24 DEC 2018 09:31:37

Middle Channel / 1.4MHz / QPSK

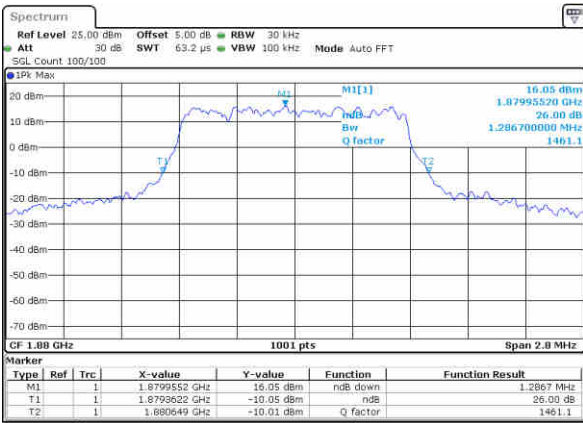

Date: 24 DEC 2018 09:46:41

Middle Channel / 1.4MHz / 16QAM

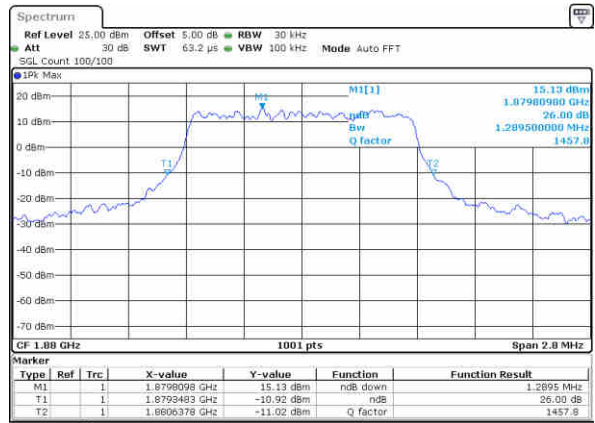

Date: 24 DEC 2018 09:46:51

Highest Channel / 1.4MHz / QPSK

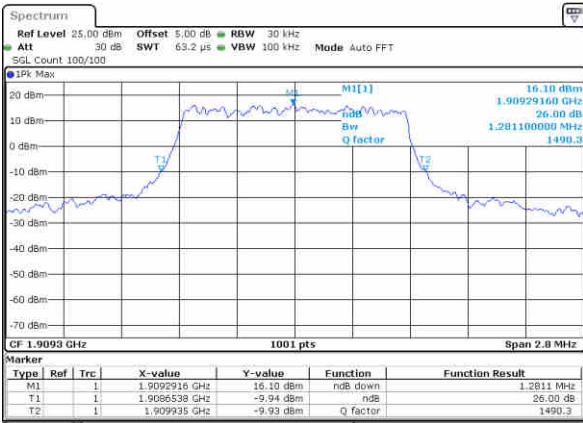

Date: 24 DEC 2018 09:49:11

Highest Channel / 1.4MHz / 16QAM

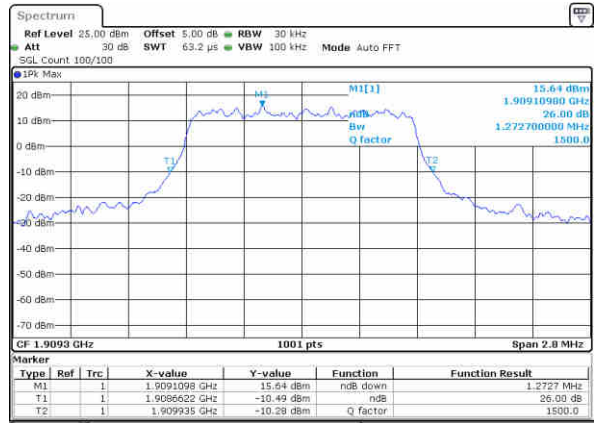

Date: 24 DEC 2018 09:49:21



LTE Band 2

Lowest Channel / 3MHz / QPSK



Date: 24 DEC 2018 09:56:10

Lowest Channel / 3MHz / 16QAM

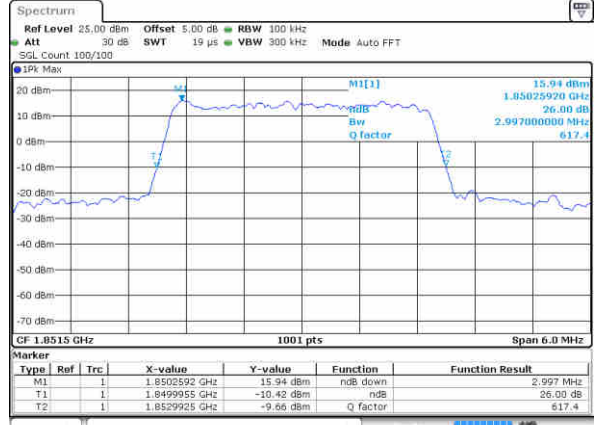

Date: 24 DEC 2018 09:56:21

Middle Channel / 3MHz / QPSK

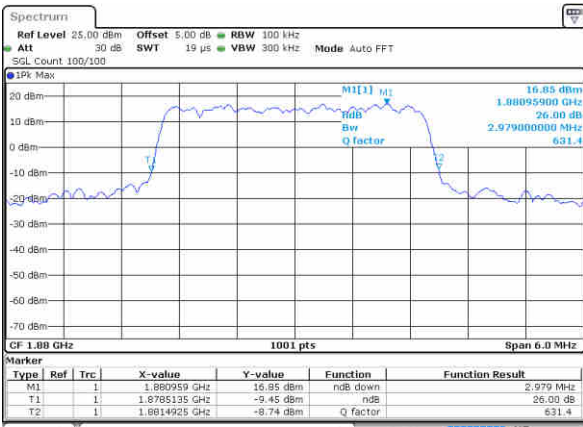

Date: 24 DEC 2018 10:03:10

Middle Channel / 3MHz / 16QAM

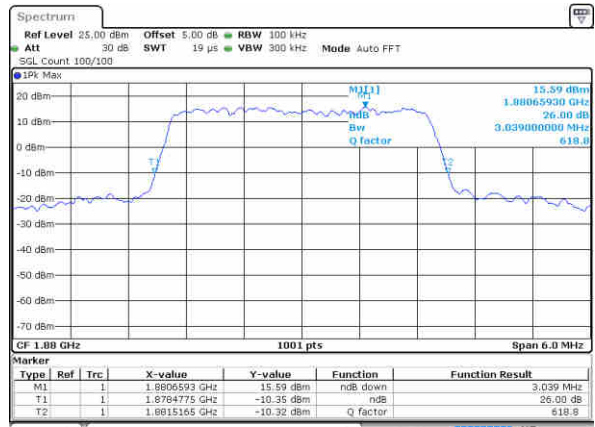

Date: 24 DEC 2018 10:03:20

Highest Channel / 3MHz / QPSK

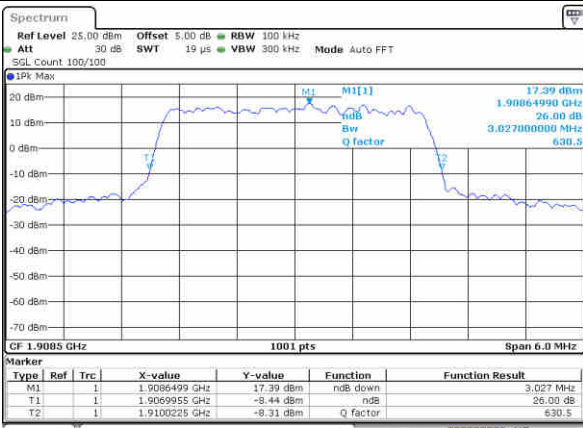

Date: 24 DEC 2018 10:05:40

Highest Channel / 3MHz / 16QAM

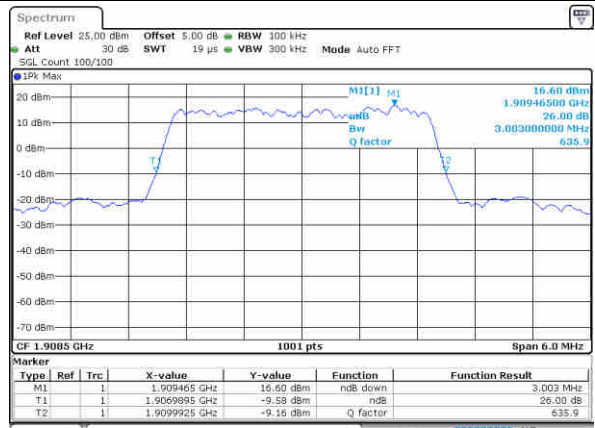

Date: 24 DEC 2018 10:05:50



LTE Band 2

Lowest Channel / 5MHz / QPSK

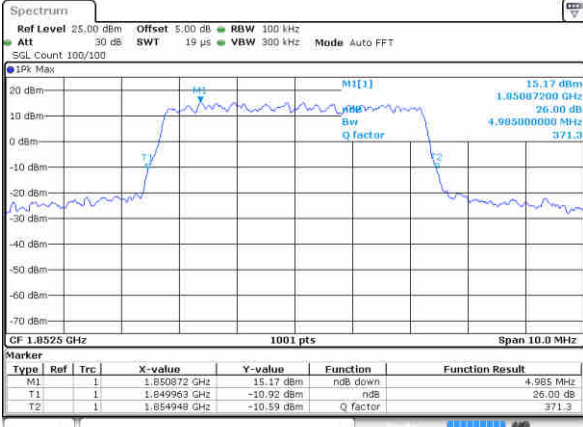

Date: 24 DEC 2018 10:12:40

Lowest Channel / 5MHz / 16QAM

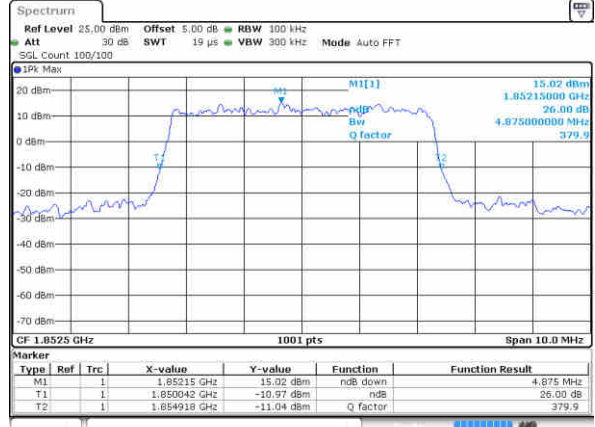

Date: 24 DEC 2018 10:12:50

Middle Channel / 5MHz / QPSK

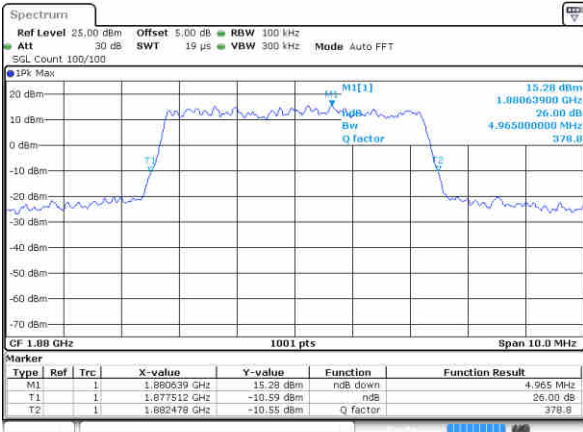

Date: 24 DEC 2018 10:19:40

Middle Channel / 5MHz / 16QAM

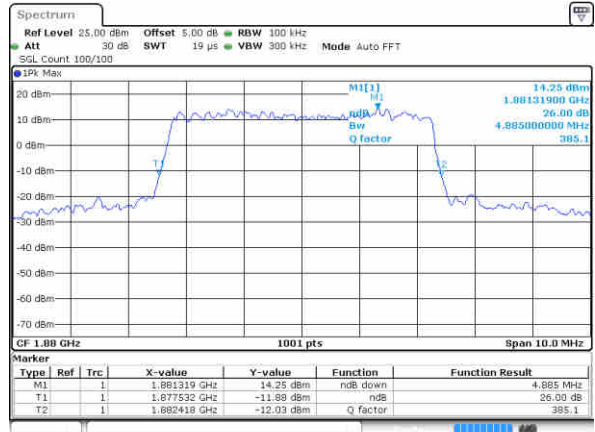

Date: 24 DEC 2018 10:19:50

Highest Channel / 5MHz / QPSK

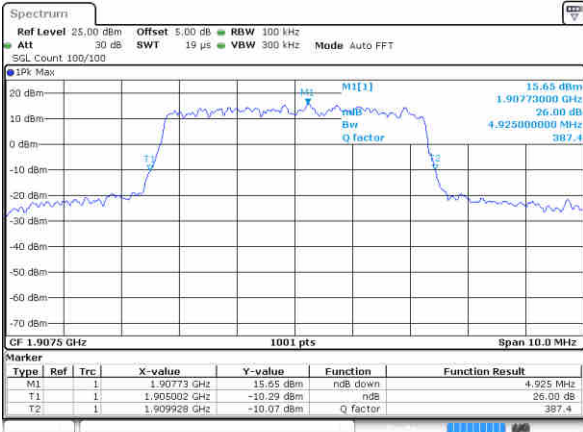

Date: 24 DEC 2018 10:22:10

Highest Channel / 5MHz / 16QAM

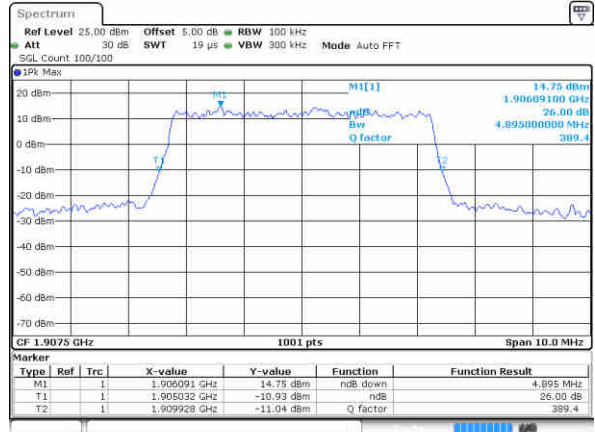

Date: 24 DEC 2018 10:22:20



LTE Band 2

Lowest Channel / 10MHz / QPSK

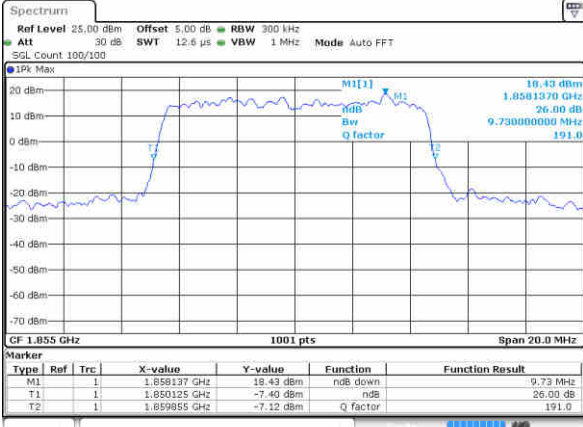

Date: 24 DEC 2018 10:29:10

Lowest Channel / 10MHz / 16QAM



Date: 24 DEC 2018 10:29:20

Middle Channel / 10MHz / QPSK

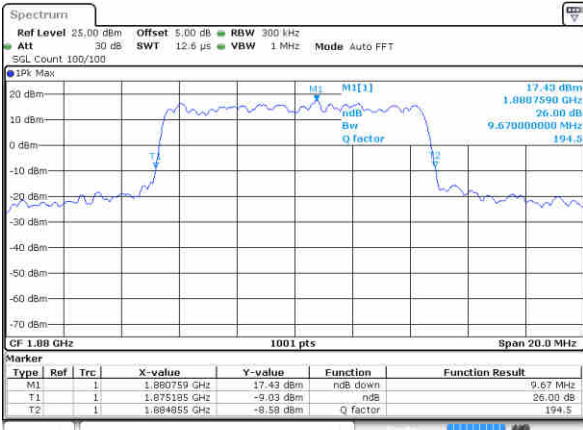

Date: 24 DEC 2018 10:38:09

Middle Channel / 10MHz / 16QAM

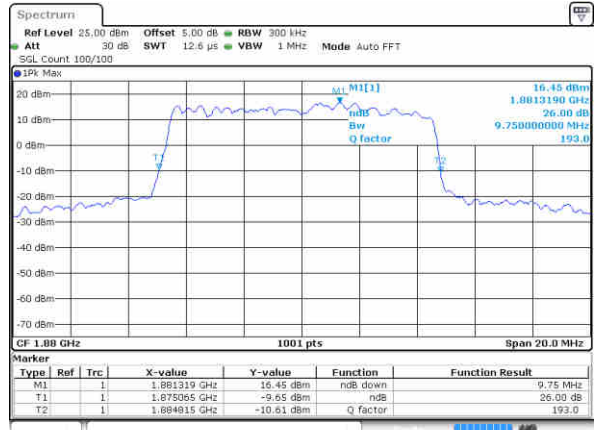

Date: 24 DEC 2018 10:38:19

Highest Channel / 10MHz / QPSK

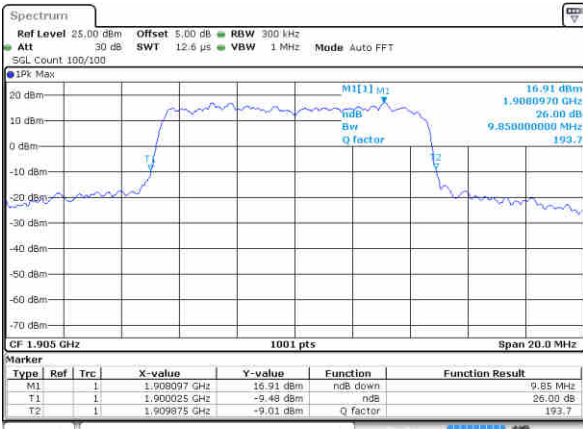

Date: 24 DEC 2018 10:38:39

Highest Channel / 10MHz / 16QAM

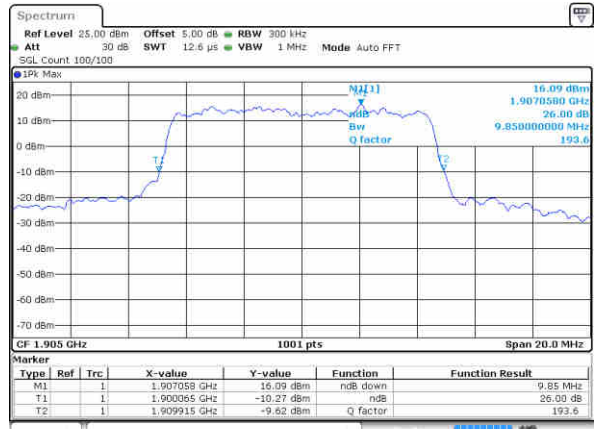

Date: 24 DEC 2018 10:38:49



LTE Band 2

Lowest Channel / 15MHz / QPSK

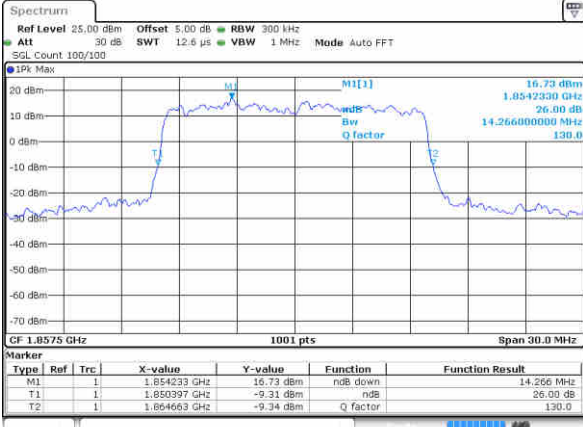

Date: 24 DEC 2018 10:45:39

Lowest Channel / 15MHz / 16QAM

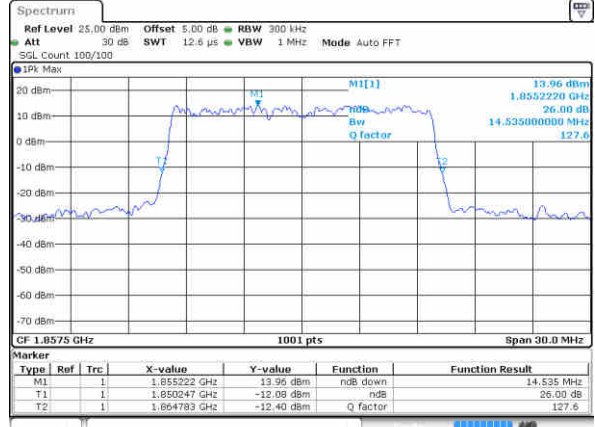

Date: 24 DEC 2018 10:45:49

Middle Channel / 15MHz / QPSK

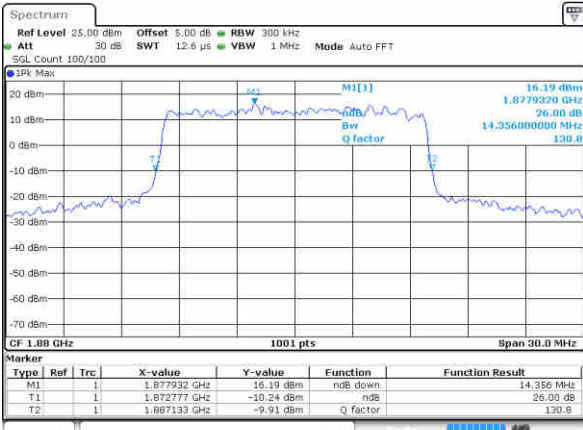

Date: 24 DEC 2018 10:52:39

Middle Channel / 15MHz / 16QAM

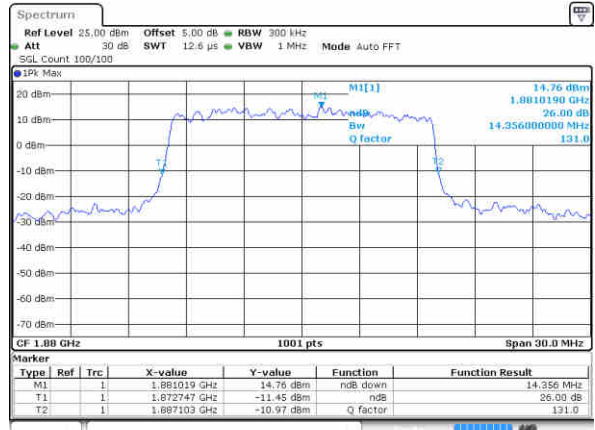

Date: 24 DEC 2018 10:52:49

Highest Channel / 15MHz / QPSK

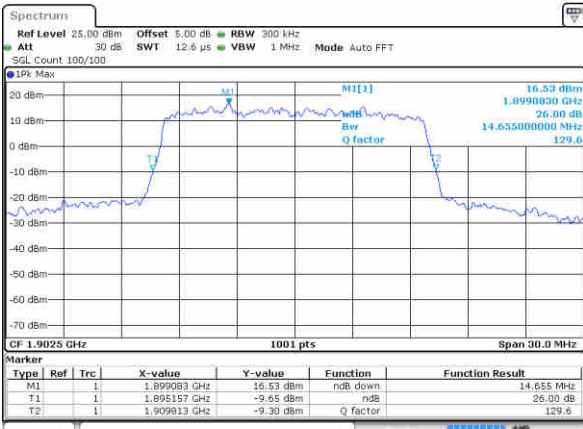

Date: 24 DEC 2018 10:55:09

Highest Channel / 15MHz / 16QAM

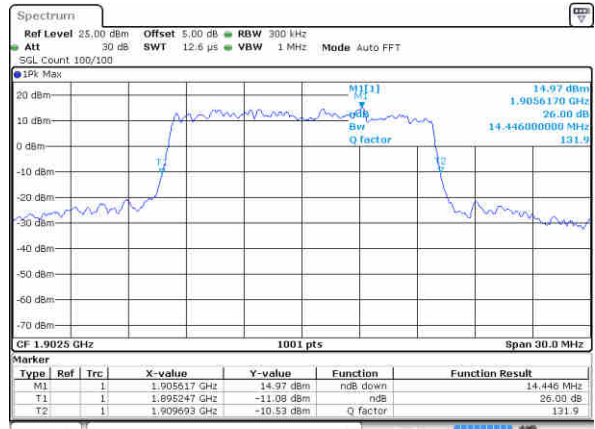

Date: 24 DEC 2018 10:55:19