



# FCC Test Report

**APPLICANT** : Xiaomi Communications Co., Ltd.  
**EQUIPMENT** : Mobile Phone  
**BRAND NAME** : MI  
**MODEL NAME** : M1803E6G  
**FCC ID** : 2AFZZ-RMSE6G  
**STANDARD** : FCC 47 CFR FCC Part 15 Subpart B  
**CLASSIFICATION** : Certification

The product was received on Feb. 08, 2018 and testing was completed on Mar. 08, 2018. We, Sporton International (Kunshan) Inc., would like to declare that the tested sample has been evaluated in accordance with the test procedures given in ANSI C63.4-2014 and has been in compliance with the applicable technical standards.

The test results in this report apply exclusively to the tested model / sample. Without written approval of Sporton International (Kunshan) Inc., the test report shall not be reproduced except in full.



Approved by: James Huang / Manager

**Sporton International (Kunshan) Inc.**

**No.3-2 Ping-Xiang Rd, Kunshan Development Zone Kunshan City Jiangsu Province 215335  
China**



# TABLE OF CONTENTS

**REVISION HISTORY.....3**

**SUMMARY OF TEST RESULT .....4**

**1. GENERAL DESCRIPTION .....5**

    1.1. Applicant.....5

    1.2. Manufacturer .....5

    1.3. Product Feature of Equipment Under Test .....5

    1.4. Product Specification of Equipment Under Test .....6

    1.5. Modification of EUT .....6

    1.6. Test Location .....7

    1.7. Applicable Standards .....7

**2. TEST CONFIGURATION OF EQUIPMENT UNDER TEST.....8**

    2.1. Test Mode .....8

    2.2. Connection Diagram of Test System ..... 10

    2.3. Support Unit used in test configuration and system..... 12

    2.4. EUT Operation Test Setup ..... 12

**3. TEST RESULT.....13**

    3.1. Test of AC Conducted Emission Measurement .....13

    3.2. Test of Radiated Emission Measurement .....20

**4. LIST OF MEASURING EQUIPMENT .....26**

**5. UNCERTAINTY OF EVALUATION .....27**

**APPENDIX A. SETUP PHOTOGRAPHS**



### REVISION HISTORY

REPORT NO.	VERSION	DESCRIPTION	ISSUED DATE
FC820819	Rev. 01	Initial issue of report	Apr. 04, 2018



### SUMMARY OF TEST RESULT

Report Section	FCC Rule	Description	Limit	Result	Remark
3.1	15.107	AC Conducted Emission	< 15.107 limits	PASS	Under limit 6.08 dB at 0.187 MHz
3.2	15.109	Radiated Emission	< 15.109 limits	PASS	Under limit 5.15 dB at 44.580 MHz for quasi-peak



# 1. General Description

## 1.1. Applicant

**Xiaomi Communications Co., Ltd.**

The Rainbow City of China Resources,NO.68,Qinghe Middle Street,Haidian District,Beijing,China

## 1.2. Manufacturer

**Xiaomi Communications Co., Ltd.**

The Rainbow City of China Resources,NO.68,Qinghe Middle Street,Haidian District,Beijing,China

## 1.3. Product Feature of Equipment Under Test

Product Feature	
<b>Equipment</b>	Mobile Phone
<b>Brand Name</b>	MI
<b>Model Name</b>	M1803E6G
<b>FCC ID</b>	2AFZZ-RMSE6G
<b>EUT supports Radios application</b>	GSM/GPRS/EGPRS/WCDMA/HSPA/DC-HSDPA/ HSPA+(16QAM uplink is not supported)/LTE/ WLAN 2.4GHz 802.11b/g/n HT20/ Bluetooth v3.0 + EDR/Bluetooth v4.0 LE/v4.2LE
<b>IMEI Code</b>	Conduction: 868041030029339/868041030029347 for Sample 1 868041030040617/868041030040625 for Sample 2 Radiation: 868041030029834/868041030029842 for Sample 1 868041030040617 868041030040625 for Sample 2
<b>HW Version</b>	P2
<b>SW Version</b>	MIUI 9
<b>EUT Stage</b>	Identical Prototype

**Remark:**

1. The above EUT's information was declared by manufacturer. Please refer to the specifications or user's manual for more detailed description.
2. There are two types of EUT sample 1 and sample 2, the differences between two samples are only for Flash, sample 1 is 3GB+32GB, sample 2 is 4GB+64GB. We chose the sample 1 to perform all tests and the sample 2 verified worst cases.



### 1.4. Product Specification of Equipment Under Test

Standards-related Product Specification	
<b>Tx Frequency</b>	GSM850: 824.2 MHz ~ 848.8 MHz GSM1900: 1850.2 MHz ~ 1909.8MHz WCDMA Band V: 826.4 MHz ~ 846.6 MHz WCDMA Band II: 1852.4 MHz ~ 1907.6 MHz LTE Band 4 : 1710.7 MHz ~ 1754.3 MHz LTE Band 5 : 824.7 MHz ~ 848.3 MHz LTE Band 7 : 2502.5 MHz ~ 2567.5 MHz LTE Band 38 : 2572.5 MHz ~ 2617.5 MHz 802.11b/g/n: 2412 MHz ~ 2462 MHz Bluetooth: 2402 MHz ~ 2480 MHz
<b>Rx Frequency</b>	GSM850: 869.2 MHz ~ 893.8 MHz GSM1900: 1930.2 MHz ~ 1989.8 MHz WCDMA Band V: 871.4 MHz ~ 891.6 MHz WCDMA Band II: 1932.4 MHz ~ 1987.6 MHz LTE Band 4 : 2110.7 MHz ~ 2154.3 MHz LTE Band 5 : 869.7 MHz ~ 893.3 MHz LTE Band 7 : 2622.5 MHz ~ 2687.5 MHz LTE Band 38: 2572.5 MHz ~ 2617.5 MHz 802.11b/g/n: 2412 MHz ~ 2462 MHz Bluetooth: 2402 MHz ~ 2480 MHz GNSS : 1559 MHz ~ 1610 MHz FM : 88 MHz ~ 108 MHz
<b>Antenna Type</b>	WWAN : LDS Antenna WLAN : LDS Antenna Bluetooth : LDS Antenna GNSS: LDS Antenna FM: External headset Antenna
<b>Type of Modulation</b>	GSM: GMSK GPRS: GMSK EDGE(MCS 0-4): GMSK / (MCS 5-9): 8PSK WCDMA : BPSK (Uplink) HSDPA/DC-HSDPA : QPSK (Uplink) HSUPA : QPSK (Uplink) HSPA+ : 16QAM (Uplink) DC-HSDPA : 64QAM LTE: QPSK / 16QAM / 64QAM 802.11b : DSSS (DBPSK / DQPSK / CCK) Bluetooth LE : GFSK Bluetooth (1Mbps) : GFSK Bluetooth (2Mbps) : $\pi/4$ -DQPSK Bluetooth (3Mbps) : 8-DPSK GNSS : BPSK FM: FM

GNSS Rx = GPS + GLONASS + BDS + SBAS

### 1.5. Modification of EUT

No modifications are made to the EUT during all test items.



### 1.6. Test Location

Sporton International (Kunshan) Inc. is accredited to ISO 17025 by National Voluntary Laboratory Accreditation Program (NVLAP code: 600155-0) and the FCC designation No. is CN5013.

<b>Test Site</b>	Sporton International (Kunshan) Inc.		
<b>Test Site Location</b>	No.3-2 Ping-Xiang Rd, Kunshan Development Zone Kunshan City Jiangsu Province 215335 China TEL : +86-512-57900158 FAX : +86-512-57900958		
<b>Test Site No.</b>	<b>Sporton Site No.</b>		<b>FCC Test Firm Registration No.</b>
	CO01-KS	03CH02-KS	630927

**Note:** The test site complies with ANSI C63.4 2014 requirement.

### 1.7. Applicable Standards

According to the specifications of the manufacturer, the EUT must comply with the requirements of the following standards:

- FCC 47 CFR FCC Part 15 Subpart B
- ANSI C63.4-2014

**Remark:** All test items were verified and recorded according to the standards and without any deviation during the test.



## 2. Test Configuration of Equipment Under Test

### 2.1. Test Mode

The EUT has been associated with peripherals pursuant to ANSI C63.4-2014 and configuration operated in a manner tended to maximize its emission characteristics in a typical application.

Frequency range investigated: conduction (150 kHz to 30 MHz), radiation (30MHz to the 5th harmonic of the highest fundamental frequency or to 40 GHz, whichever is lower).

Test Items	Function Type
AC Conducted Emission	Mode 1: GSM850 Idle + Bluetooth Idle + WLAN (2.4G) Idle + USB Cable 1(Charging from Adapter1) + Camera (Rear) for Sample 1 <Fig.1>
	Mode 2: GSM1900 Idle + Bluetooth Idle + WLAN (2.4G) Idle + USB Cable 1(Charging from Adapter1) + Camera (Front) for Sample 1<Fig.1>
	Mode 3: WCDMA Band V Idle + Bluetooth Idle + WLAN (2.4G) Idle + USB Cable 1(Charging from Adapter1) + MPEG4 for Sample 1<Fig.1>
	Mode 4: WCDMA Band II Idle + Bluetooth Idle + WLAN (2.4G) Idle + USB Cable 1(Data Link with Notebook) + GNSS Rx for Sample 1<Fig.2>
	Mode 5: LTE Band 4 Idle + Bluetooth Idle + WLAN (2.4G) Idle + USB Cable 2(Data Link with Notebook) + GNSS Rx for Sample 1<Fig.2>
	Mode 6: LTE Band 7 Idle + Bluetooth Idle + WLAN (2.4G) Idle + USB Cable 2(Charging from Adapter1) + Earphone + FM RX for Sample 1 <Fig.3>
	Mode 7: LTE Band 7 Idle + Bluetooth Idle + WLAN (2.4G) Idle + USB Cable 2(Charging from Adapter2) + Earphone + FM RX for Sample 1 <Fig.3>
	Mode 8: LTE Band 4 Idle + Bluetooth Idle + WLAN (2.4G) Idle + USB Cable 2(Data Link with Notebook) + GNSS Rx for Sample 2<Fig.2>





Radiated Emissions < 1GHz	<p>Mode 1: GSM850 Idle + Bluetooth Idle + WLAN (2.4G) Idle + USB Cable 1(Charging from Adapter1) + Camera (Rear) for Sample 1 &lt;Fig.1&gt;</p> <p>Mode 2: GSM1900 Idle + Bluetooth Idle + WLAN (2.4G) Idle + USB Cable 1(Charging from Adapter1) + Camera (Front) for Sample 1 &lt;Fig.1&gt;</p> <p>Mode 3: WCDMA Band V Idle + Bluetooth Idle + WLAN (2.4G) Idle + USB Cable 1(Charging from Adapter1) + MPEG4 for Sample 1 &lt;Fig.1&gt;</p> <p>Mode 4: WCDMA Band II Idle + Bluetooth Idle + WLAN (2.4G) Idle + USB Cable 1(Data Link with Notebook) + GNSS Rx for Sample 1 &lt;Fig.2&gt;</p> <p>Mode 5: LTE Band 4 Idle + Bluetooth Idle + WLAN (2.4G) Idle + USB Cable 2(Data Link with Notebook) + GNSS Rx for Sample 1&lt;Fig.2&gt;</p> <p>Mode 6: LTE Band 7 Idle + Bluetooth Idle + WLAN (2.4G) Idle + USB Cable 2(Charging from Adapter1) + Earphone + FM RX(98MHz) for Sample 1&lt;Fig.3&gt;</p> <p>Mode 7: LTE Band 7 Idle + Bluetooth Idle + WLAN (2.4G) Idle + USB Cable 2(Charging from Adapter2) + Earphone + FM RX(98MHz) for Sample 1 &lt;Fig.3&gt;</p> <p>Mode 8: WCDMA Band II Idle + Bluetooth Idle + WLAN (2.4G) Idle + USB Cable 1(Data Link with Notebook) + GNSS Rx for Sample 2 &lt;Fig.2&gt;</p>
Radiated Emissions ≥ 1GHz	<p>Mode 1: LTE Band 7 Idle + Bluetooth Idle + WLAN (2.4G) Idle + USB Cable 2(Charging from Adapter1) + Earphone + FM RX(98MHz) for Sample 1 &lt;Fig.3&gt;</p> <p>Mode 2: WCDMA Band II Idle + Bluetooth Idle + WLAN (2.4G) Idle + USB Cable 1(Data Link with Notebook) + GNSS Rx for Sample 1 &lt;Fig.2&gt;</p>
<p><b>Remark:</b></p> <ol style="list-style-type: none"> <li>1. The worst case of AC is mode 7; and the USB data link mode is mode 5, the test data of these modes are reported.</li> <li>2. The worst case of RE &lt; 1G is mode 6; and the USB data link mode is mode 4, the test data of these modes are reported.</li> <li>3. Data Link with Notebook means data application transferred mode between EUT and Notebook.</li> </ol>	

## 2.2. Connection Diagram of Test System

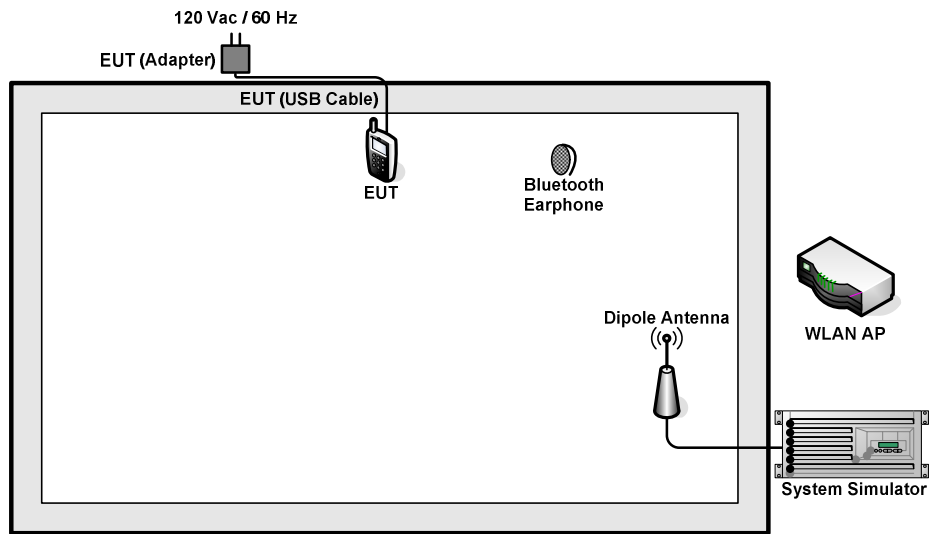

<Fig.1>

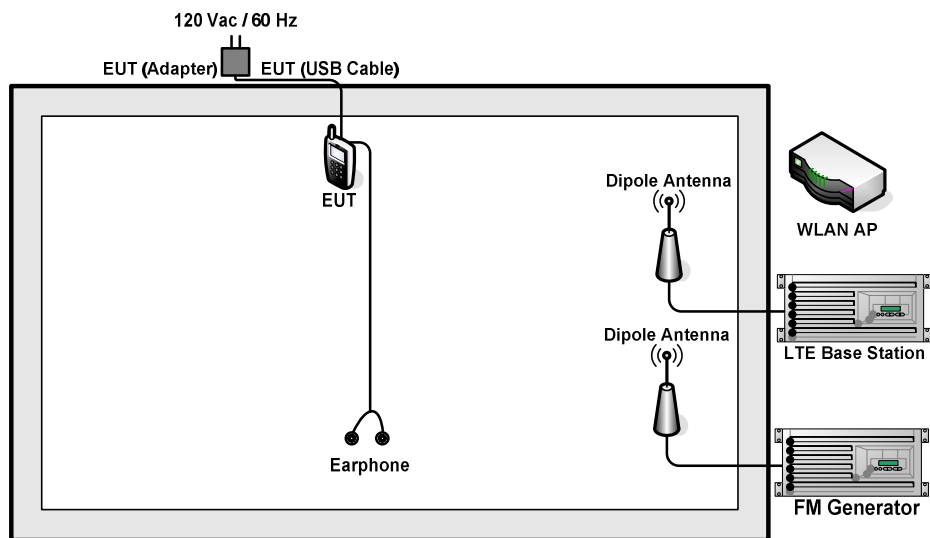

<Fig.2>

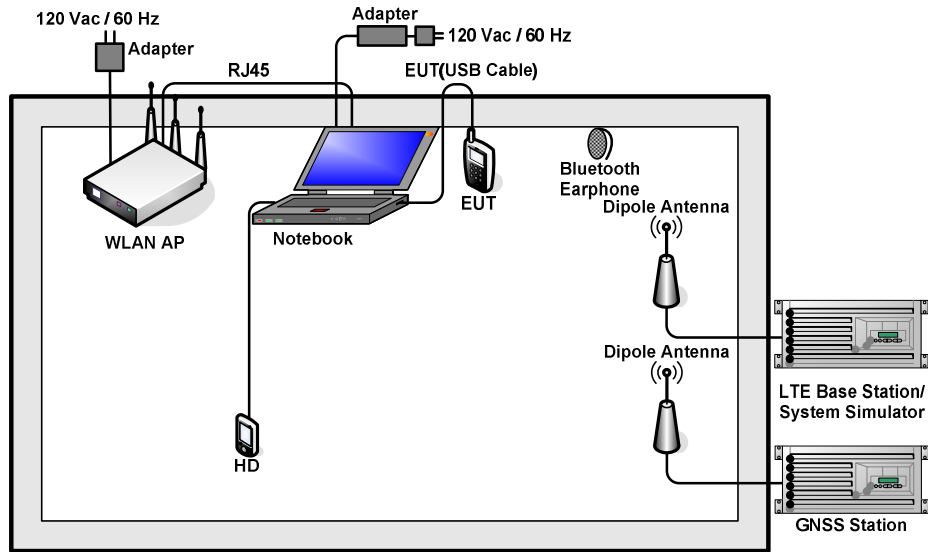

<Fig.3>

### 2.3. Support Unit used in test configuration and system

Item	Equipment	Trade Name	Model Name	FCC ID	Data Cable	Power Cord
1.	System Simulator	R&S	CMU 200	N/A	N/A	Unshielded, 1.8 m
2.	LTE Base Station	Anritsu	MT8820C	N/A	N/A	Unshielded, 1.8 m
3.	FM Station	R&S	SMBV100A	258305	N/A	Unshielded, 1.8 m
4.	GNSS Station	ADIVIC	MP9000	N/A	N/A	Unshielded, 1.8 m
5.	GNSS Station	RACELOGIC	RLLS03-2RP	N/A	N/A	Unshielded, 1.8 m
6.	WLAN AP	D-Link	DIR-855	KA2DIR855A2	N/A	Unshielded, 1.8 m
7.	WLAN AP	TP-Link	TL-WDR5600	N/A	N/A	Unshielded, 1.8 m
8.	Notebook	Lenovo	G480	N/A	N/A	AC I/P: Unshielded, 1.8 m DC O/P: Shielded, 1.8 m
9.	Notebook	Dell	Latitude3440	N/A	N/A	AC I/P: Unshielded, 1.8 m DC O/P: Shielded, 1.8 m
10.	Bluetooth Earphone	Xiaomi	LYEJ02LM	N/A	N/A	N/A
11.	iPod	Apple	A1199	Fcc DoC	Shielded, 1.2m	iPod
12.	SD Card	Kingston	8GB	N/A	N/A	N/A
13.	Earphone	Lenovo	SH100	N/A	Unshielded, 1.0 m	N/A

### 2.4. EUT Operation Test Setup

The EUT was in GSM or WCDMA or LTE idle mode during the testing. The EUT was synchronized to the BCCH, and is in continuous receiving mode by setting system simulator’s paging reorganization.

At the same time, the EUT was attached to the Bluetooth earphone or WLAN AP, and the following programs installed in the EUT were programmed during the test.

1. Data application is transferred between Notebook and EUT via USB cable.
2. Turn on GNSS function to make the EUT receive continuous signals from GNSS station.
3. Turn on FM function to make the EUT receive continuous signals from FM Generator.
4. Execute “Video Player” to play MPEG4 files.
5. Turn on camera to capture images.

### 3. Test Result

#### 3.1. Test of AC Conducted Emission Measurement

##### 3.1.1 Limits of AC Conducted Emission

For equipment that is designed to be connected to the public utility (AC) power line, the radio frequency voltage that is conducted back onto the AC power line on any frequency or frequencies within the band 150 kHz to 30 MHz shall not exceed the limits in the following table.

Frequency of emission (MHz)	Conducted limit (dBuV)	
	Quasi-peak	Average
0.15-0.5	66 to 56*	56 to 46*
0.5-5	56	46
5-30	60	50

\*Decreases with the logarithm of the frequency.

##### 3.1.2 Measuring Instruments

The measuring equipment is listed in the section 4 of this test report.

##### 3.1.3 Test Procedure

1. The EUT was placed 0.4 meter from the conducting wall of the shielding room was kept at least 80 centimeters from any other grounded conducting surface.
2. Connect EUT to the power mains through a line impedance stabilization network (LISN).
3. All the support units are connecting to the other LISN.
4. The LISN provides 50 ohm coupling impedance for the measuring instrument.
5. The FCC states that a 50 ohm, 50 microhenry LISN should be used.
6. Both sides of AC line were checked for maximum conducted interference.
7. The frequency range from 150 kHz to 30 MHz was searched.
8. Set the test-receiver system to Peak Detect Function and specified bandwidth (IF Bandwidth = 9kHz) with Maximum Hold Mode. Then measurement is also conducted by Average Detector and Quasi-Peak Detector Function respectively.

### 3.1.4 Test Setup

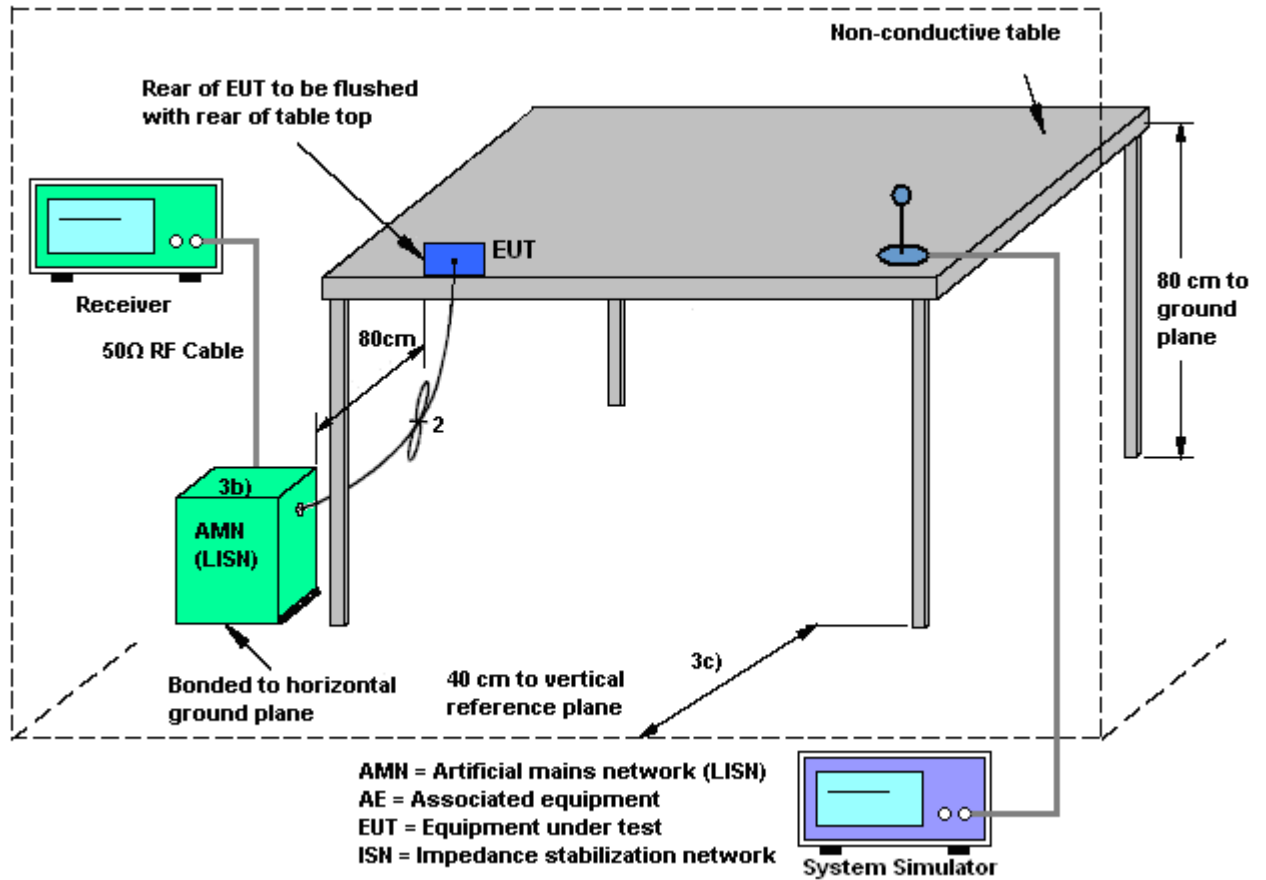



3.1.5 Test Result of AC Conducted Emission

Test Mode :	Mode 5	Temperature :	21~23°C
Test Engineer :	Amos Zhang	Relative Humidity :	42~44%
Test Voltage :	120Vac / 60Hz	Phase :	Line
Function Type :	LTE Band 4 Idle + Bluetooth Idle + WLAN (2.4G) Idle + USB Cable 2(Data Link with Notebook) + GNSS Rx for Sample 1		

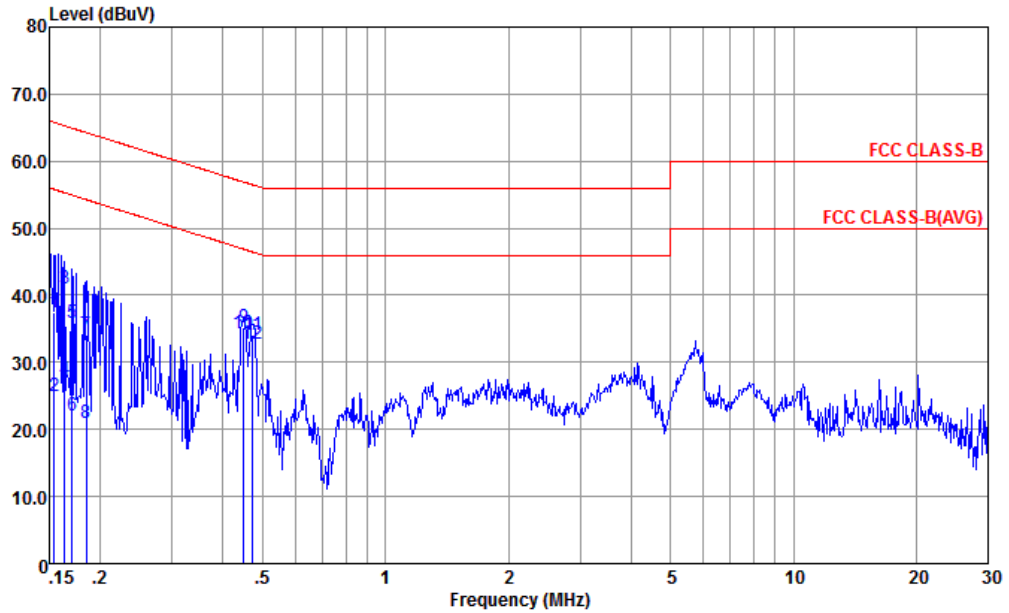

Site : CO01-KS  
 Condition : FCC CLASS-B LISN-L-171013-060103 LINE  
 mode : Mode 5  
 : 868041030029339/868041030029347 #7

	Freq	Level	Over Limit	Limit Line	Read Level	LISN Factor	Cable Loss	Remark
	MHz	dBuV	dB	dBuV	dBuV	dB	dB	
1	0.154	37.37	-28.41	65.78	26.61	0.16	10.60	QP
2	0.154	24.97	-30.81	55.78	14.21	0.16	10.60	Average
3	0.163	40.94	-24.36	65.30	30.20	0.17	10.57	QP
4	0.163	27.34	-27.96	55.30	16.60	0.17	10.57	Average
5	0.170	35.93	-29.01	64.94	25.20	0.18	10.55	QP
6	0.170	22.03	-32.91	54.94	11.30	0.18	10.55	Average
7	0.184	34.19	-30.09	64.28	23.50	0.19	10.50	QP
8	0.184	20.89	-33.39	54.28	10.20	0.19	10.50	Average
9	0.449	35.11	-21.78	56.89	24.50	0.25	10.36	QP
10 *	0.449	34.41	-12.48	46.89	23.80	0.25	10.36	Average
11	0.474	34.19	-22.26	56.45	23.60	0.26	10.33	QP
12	0.474	32.69	-13.76	46.45	22.10	0.26	10.33	Average



Test Mode :	Mode 5	Temperature :	21~23°C
Test Engineer :	Amos Zhang	Relative Humidity :	42~44%
Test Voltage :	120Vac / 60Hz	Phase :	Neutral
Function Type :	LTE Band 4 Idle + Bluetooth Idle + WLAN (2.4G) Idle + USB Cable 2(Data Link with Notebook) + GNSS Rx for Sample 1		

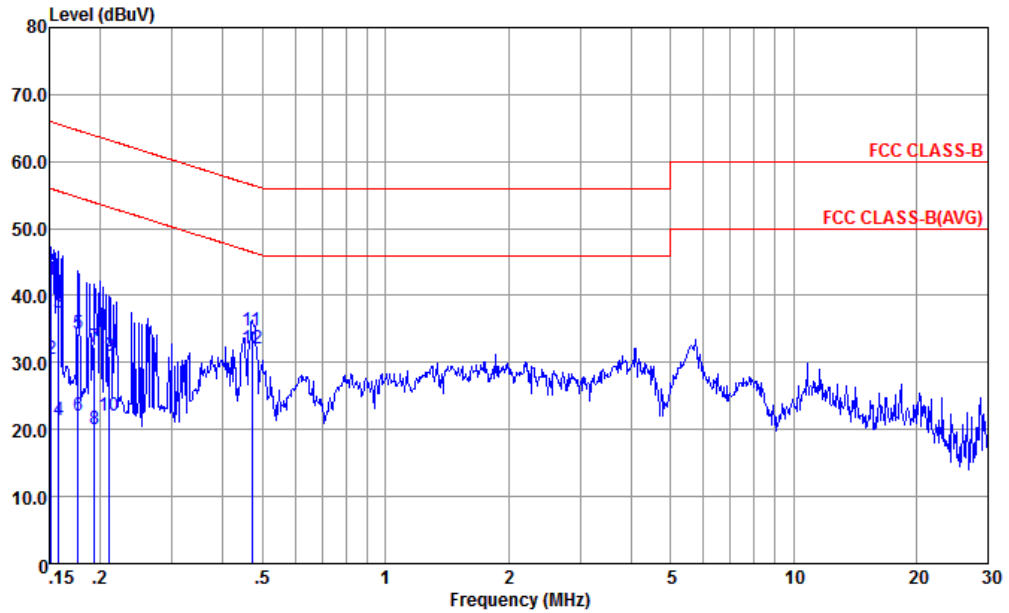

Site : CO01-KS  
 Condition : FCC CLASS-B LISN-N-171013-060103 NEUTRAL

mode : Mode 5  
 : 868041030029339/868041030029347 #7

	Freq	Level	Over Limit	Limit Line	Read Level	LISN Factor	Cable Loss	Remark
	MHz	dBuV	dB	dBuV	dBuV	dB	dB	
1	0.152	42.39	-23.52	65.91	31.50	0.28	10.61	QP
2	0.152	30.49	-25.42	55.91	19.60	0.28	10.61	Average
3	0.158	37.47	-28.09	65.56	26.60	0.28	10.59	QP
4	0.158	21.47	-34.09	55.56	10.60	0.28	10.59	Average
5	0.177	34.41	-30.23	64.64	23.60	0.28	10.53	QP
6	0.177	22.01	-32.63	54.64	11.20	0.28	10.53	Average
7	0.193	32.35	-31.54	63.89	21.60	0.28	10.47	QP
8	0.193	20.05	-33.84	53.89	9.30	0.28	10.47	Average
9	0.211	30.93	-32.25	63.18	20.20	0.28	10.45	QP
10	0.211	22.03	-31.15	53.18	11.30	0.28	10.45	Average
11	0.471	34.82	-21.67	56.49	24.20	0.29	10.33	QP
12 *	0.471	32.12	-14.37	46.49	21.50	0.29	10.33	Average





Test Mode :	Mode 7	Temperature :	21~23°C
Test Engineer :	Amos Zhang	Relative Humidity :	42~44%
Test Voltage :	120Vac / 60Hz	Phase :	Line
Function Type :	LTE Band 7 Idle + Bluetooth Idle + WLAN (2.4G) Idle + USB Cable 2(Charging from Adapter2) + Earphone + FM RX for Sample 1		

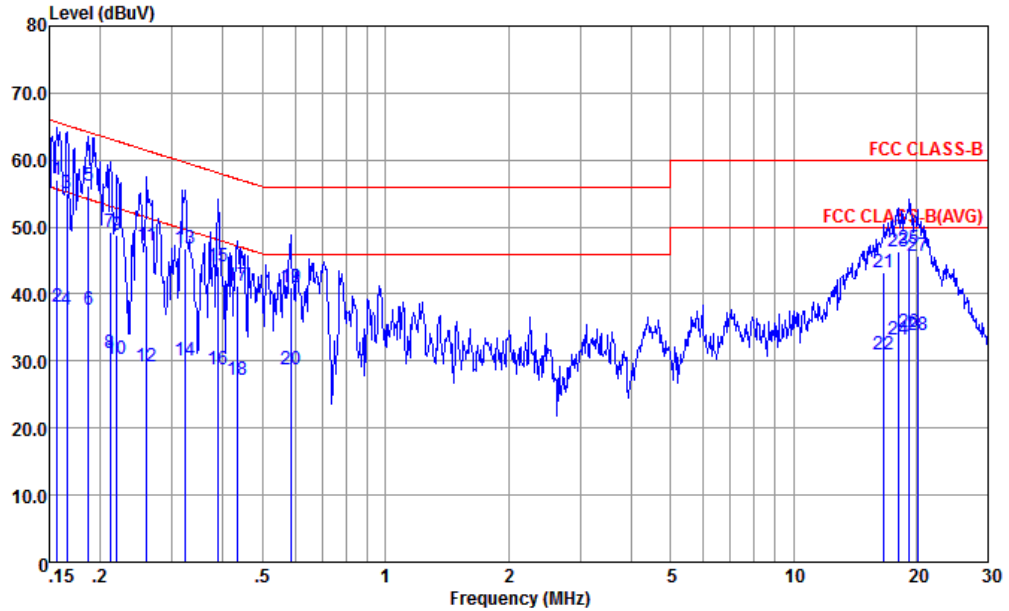

Site : CO01-KS  
 Condition : FCC CLASS-B LISN-L-171013-060103 LINE  
 mode : Mode 7  
 : 868041030029339/868041030029347 #7

	Freq	Level	Over Limit	Limit	Read	LISN	Cable	
	MHz	dBuV	dB	dBuV	dBuV	dB	dB	Remark
1	0.156	56.96	-8.69	65.65	46.20	0.17	10.59	QP
2	0.156	38.06	-17.59	55.65	27.30	0.17	10.59	Average
3	0.166	55.03	-10.13	65.16	44.30	0.17	10.56	QP
4	0.166	37.63	-17.53	55.16	26.90	0.17	10.56	Average
5 *	0.187	56.18	-7.97	64.15	45.50	0.19	10.49	QP
6	0.187	37.58	-16.57	54.15	26.90	0.19	10.49	Average
7	0.212	49.26	-13.88	63.14	38.61	0.20	10.45	QP
8	0.212	31.26	-21.88	53.14	20.61	0.20	10.45	Average
9	0.220	48.86	-13.97	62.83	38.20	0.21	10.45	QP
10	0.220	30.26	-22.57	52.83	19.60	0.21	10.45	Average
11	0.260	47.25	-14.17	61.42	36.59	0.22	10.44	QP
12	0.260	29.25	-22.17	51.42	18.59	0.22	10.44	Average
13	0.323	46.85	-12.77	59.62	36.20	0.23	10.42	QP
14	0.323	30.15	-19.47	49.62	19.50	0.23	10.42	Average
15	0.387	44.15	-13.97	58.12	33.50	0.24	10.41	QP
16	0.387	28.85	-19.27	48.12	18.20	0.24	10.41	Average
17	0.435	41.22	-15.93	57.15	30.60	0.25	10.37	QP



Test Mode :	Mode 7	Temperature :	21~23°C
Test Engineer :	Amos Zhang	Relative Humidity :	42~44%
Test Voltage :	120Vac / 60Hz	Phase :	Line
Function Type :	LTE Band 7 Idle + Bluetooth Idle + WLAN (2.4G) Idle + USB Cable 2(Charging from Adapter2) + Earphone + FM RX for Sample 1		

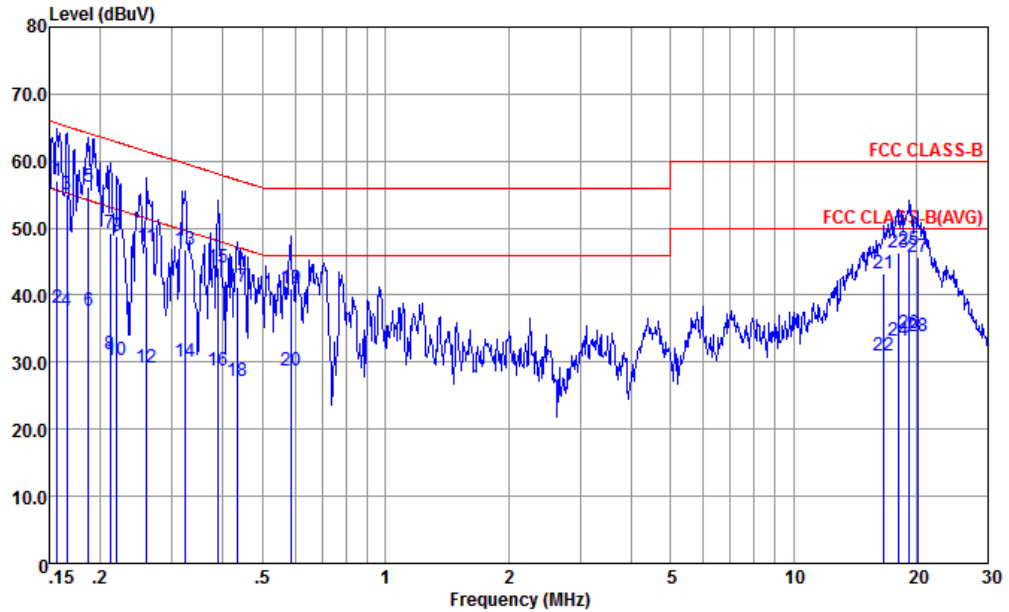

Site : CO01-KS  
 Condition : FCC CLASS-B LISN-L-171013-060103 LINE  
 Project : (FC) 820819  
 mode : Mode 7  
 : 868041030029339/868041030029347 #7

Freq	Level	Over	Limit	Read	LISN	Cable	Remark
MHz	dBuV	dB	dBuV	dBuV	dB	dB	
18	0.435	27.22	-19.93	47.15	16.60	0.25	10.37 Average
19	0.585	41.10	-14.90	56.00	30.60	0.26	10.24 QP
20	0.585	28.70	-17.30	46.00	18.20	0.26	10.24 Average
21	16.661	43.27	-16.73	60.00	32.60	0.23	10.44 QP
22	16.661	30.87	-19.13	50.00	20.20	0.23	10.44 Average
23	18.039	46.27	-13.73	60.00	35.60	0.21	10.46 QP
24	18.039	33.27	-16.73	50.00	22.60	0.21	10.46 Average
25	19.224	46.86	-13.14	60.00	36.20	0.19	10.47 QP
26	19.224	34.26	-15.74	50.00	23.60	0.19	10.47 Average
27	20.162	45.77	-14.23	60.00	35.10	0.19	10.48 QP
28	20.162	33.97	-16.03	50.00	23.30	0.19	10.48 Average



Test Mode :	Mode 7	Temperature :	21~23°C
Test Engineer :	Amos Zhang	Relative Humidity :	42~44%
Test Voltage :	120Vac / 60Hz	Phase :	Neutral
Function Type :	LTE Band 7 Idle + Bluetooth Idle + WLAN (2.4G) Idle + USB Cable 2(Charging from Adapter2) + Earphone + FM RX for Sample 1		

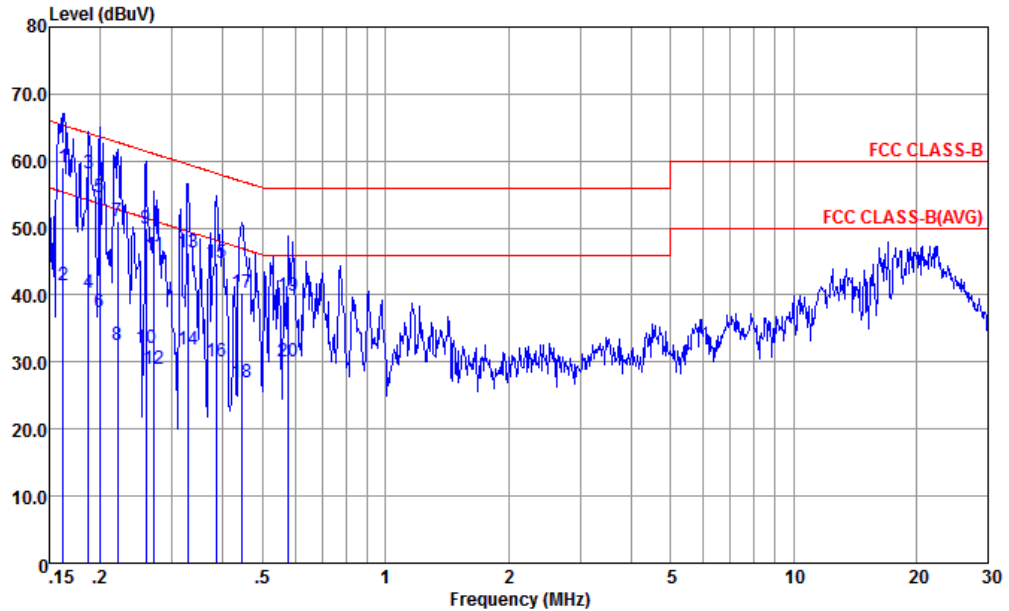

Site : CO01-KS  
 Condition : FCC CLASS-B LISN-N-171013-060103 NEUTRAL  
 mode : Mode 7  
 : 868041030029339/868041030029347 #7

	Freq	Level	Over Limit	Limit	Read	LISN	Cable	
	MHz	dBuV	dB	dBuV	dBuV	dB	dB	Remark
1	0.162	58.95	-6.39	65.34	48.10	0.28	10.57	QP
2	0.162	41.45	-13.89	55.34	30.60	0.28	10.57	Average
3 *	0.187	58.07	-6.08	64.15	47.30	0.28	10.49	QP
4	0.187	40.37	-13.78	54.15	29.60	0.28	10.49	Average
5	0.200	54.64	-8.98	63.62	43.90	0.28	10.46	QP
6	0.200	37.34	-16.28	53.62	26.60	0.28	10.46	Average
7	0.221	51.03	-11.76	62.79	40.30	0.28	10.45	QP
8	0.221	32.63	-20.16	52.79	21.90	0.28	10.45	Average
9	0.259	49.92	-11.55	61.47	39.20	0.28	10.44	QP
10	0.259	32.02	-19.45	51.47	21.30	0.28	10.44	Average
11	0.272	45.92	-15.15	61.07	35.21	0.28	10.43	QP
12	0.272	28.92	-22.15	51.07	18.21	0.28	10.43	Average
13	0.329	46.31	-13.18	59.49	35.60	0.29	10.42	QP
14	0.329	31.91	-17.58	49.49	21.20	0.29	10.42	Average
15	0.385	44.80	-13.37	58.17	34.10	0.29	10.41	QP
16	0.385	30.00	-18.17	48.17	19.30	0.29	10.41	Average
17	0.444	40.25	-16.73	56.98	29.60	0.29	10.36	QP
18	0.444	26.95	-20.03	46.98	16.30	0.29	10.36	Average
19	0.579	39.84	-16.16	56.00	29.31	0.29	10.24	QP
20	0.579	30.14	-15.86	46.00	19.61	0.29	10.24	Average



### 3.2. Test of Radiated Emission Measurement

#### 3.2.1. Limit of Radiated Emission

The emissions from an unintentional radiator shall not exceed the field strength levels specified in the following table:

Frequency (MHz)	Field Strength (microvolts/meter)	Measurement Distance (meters)
30 – 88	100	3
88 – 216	150	3
216 - 960	200	3
Above 960	500	3

#### 3.2.2. Measuring Instruments

The measuring equipment is listed in the section 4 of this test report.

#### 3.2.3. Test Procedures

1. The EUT was placed on a turntable with 0.8 meter above ground.
2. The EUT was set 3 meters from the interference receiving antenna, which was mounted on the top of a variable height antenna tower.
3. The table was rotated 360 degrees to determine the position of the highest radiation.
4. The antenna is a Bi-Log antenna and its height is adjusted between one to four meters above ground to find the maximum value of the field strength for both horizontal polarization and vertical polarization of the antenna.
5. For each suspected emission, the EUT was arranged to its worst case and then tune the antenna tower (from 1 m to 4 m) and turntable (from 0 degree to 360 degrees) to find the maximum reading.
6. Set the test-receiver system to Peak Detect Function and specified bandwidth with Maximum Hold Mode (RBW=120kHz/VBW=300kHz for frequency below 1GHz; RBW=1MHz VBW=3MHz (Peak), RBW=1MHz/VBW=10Hz (Average) for frequency above 1GHz).
7. If the emission level of the EUT in peak mode was 3 dB lower than the limit specified, peak values of EUT will be reported. Otherwise, the emission will be repeated by using the quasi-peak method and reported.
8. Emission level (dBµV/m) = 20 log Emission level (µV/m)
9. Corrected Reading: Antenna Factor + Cable Loss + Read Level - Preamp Factor = Level

### 3.2.4. Test Setup of Radiated Emission

For radiated emissions from 30MHz to 1GHz

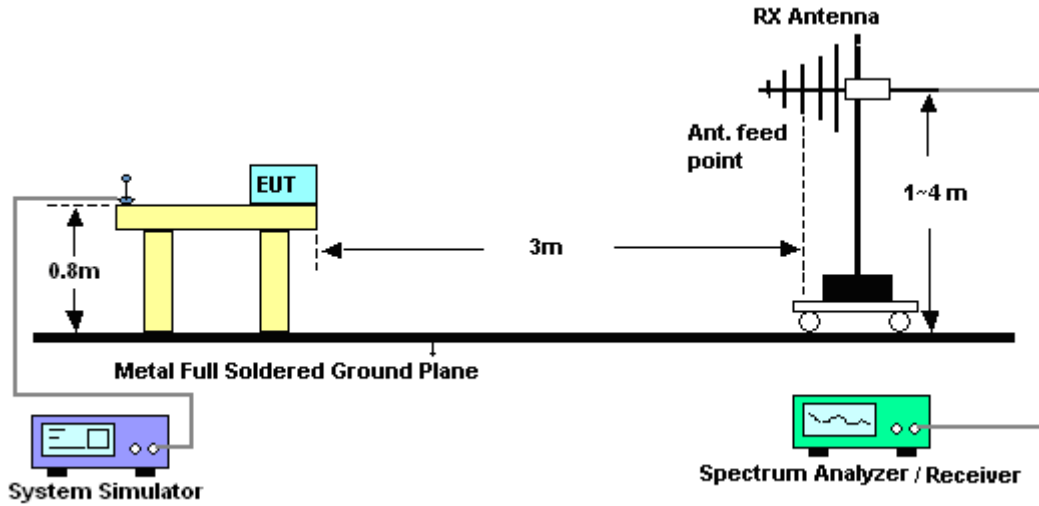

For radiated emissions above 1GHz

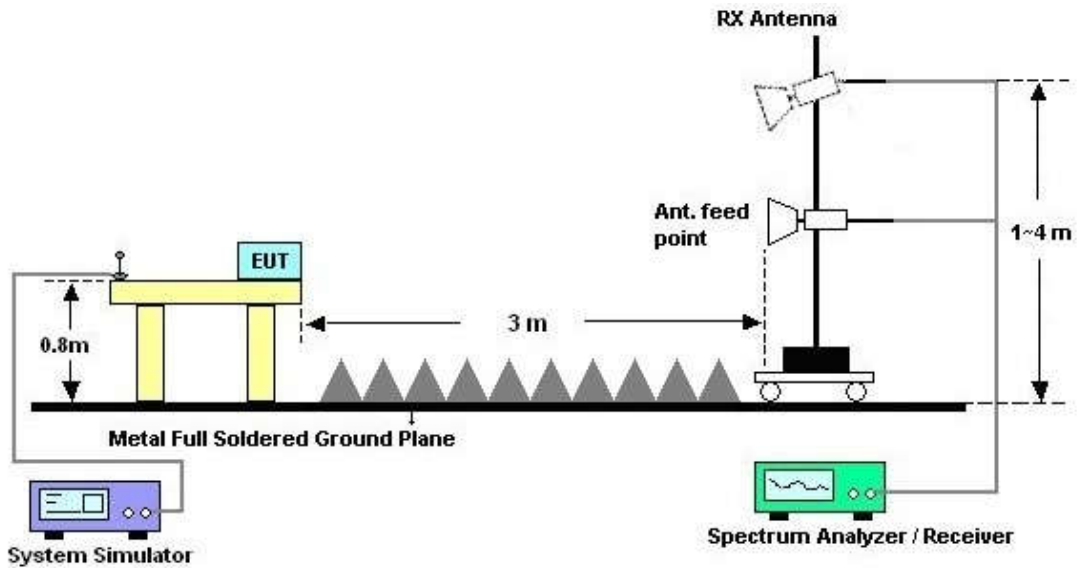



3.2.5. Test Result of Radiated Emission

Test Mode :	Mode 4	Temperature :	21~22°C
Test Engineer :	Maker Qi	Relative Humidity :	41~42%
Test Distance :	3m	Polarization :	Horizontal
Function Type :	WCDMA Band II Idle + Bluetooth Idle + WLAN (2.4G) Idle + USB Cable 1(Data Link with Notebook) + GNSS Rx for Sample 1		

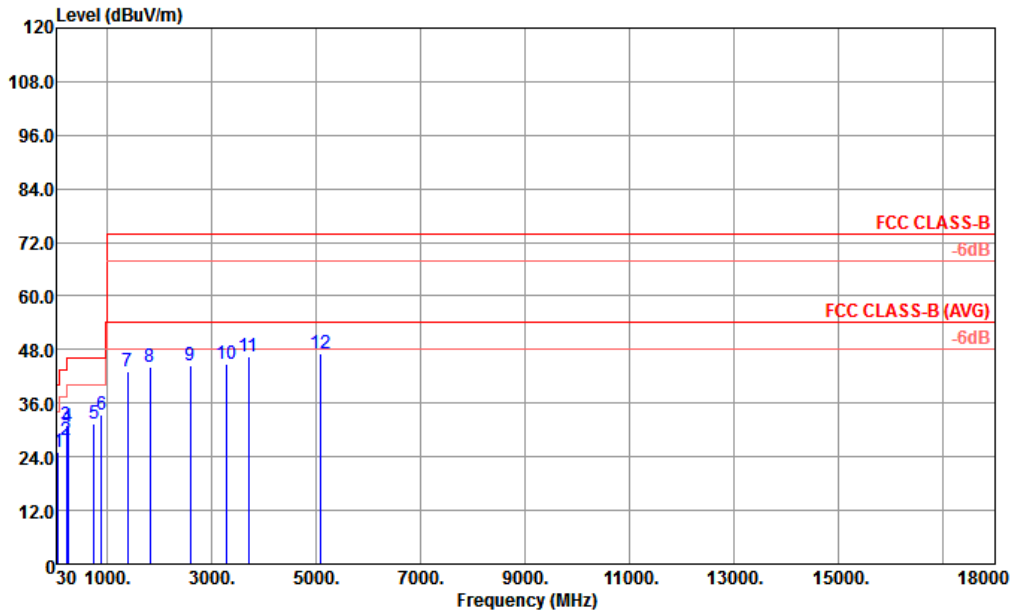

Site : 03CH02-KS  
 Condition : FCC CLASS-B 3m LF 47610 HORIZONTAL  
 Mode : 4  
 IMEI : 868041030029834 868041030029842 #12

	Freq	Level	Over Limit	Limit Line	ReadAntenna Level	Cable Factor	Preamp Loss	A/Pos	T/Pos	Remark	
	MHz	dBuV/m	dB	dBuV/m	dBuV	dB/m	dB	dB	cm	deg	
1	72.66	25.13	-14.87	40.00	43.80	12.52	0.86	32.05	---	---	Peak
2	217.92	27.79	-18.21	46.00	42.65	15.22	1.55	31.63	---	---	Peak
3	229.80	31.06	-14.94	46.00	44.73	16.30	1.63	31.60	---	---	Peak
4	254.10	30.60	-15.40	46.00	41.40	18.96	1.76	31.52	---	---	Peak
5	745.90	31.54	-14.46	46.00	31.76	25.65	2.81	28.68	---	---	Peak
6	897.80	33.52	-12.48	46.00	31.37	26.59	3.09	27.53	100	0	Peak
7	1388.00	43.13	-30.87	74.00	45.42	28.67	3.88	34.84	---	---	Peak
8	1822.00	44.15	-29.85	74.00	44.24	29.37	4.46	33.92	---	---	Peak
9	2590.00	44.37	-29.63	74.00	38.01	31.65	5.34	30.63	---	---	Peak
10	3273.00	44.87	-29.13	74.00	35.20	33.21	6.24	29.78	---	---	Peak
11	3708.00	46.54	-27.46	74.00	35.55	34.37	6.55	29.93	---	---	Peak
12	5088.00	46.98	-27.02	74.00	37.85	35.45	7.81	34.13	---	---	Peak



Test Mode :	Mode 4	Temperature :	21~22°C
Test Engineer :	Maker Qi	Relative Humidity :	41~42%
Test Distance :	3m	Polarization :	Vertical
Function Type :	WCDMA Band II Idle + Bluetooth Idle + WLAN (2.4G) Idle + USB Cable 1(Data Link with Notebook) + GNSS Rx for Sample 1		

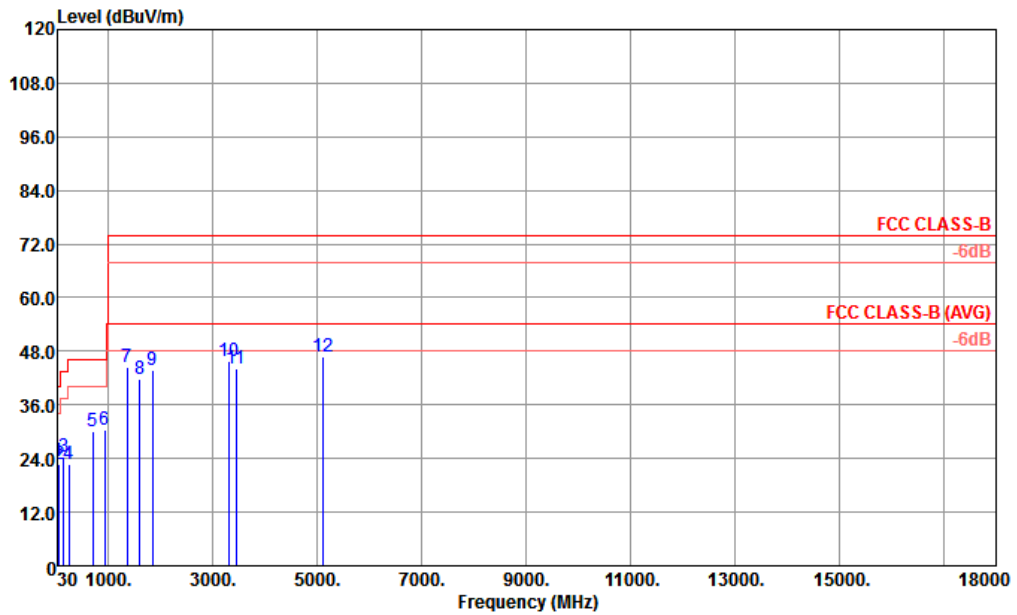

Site : 03CH02-KS  
 Condition : FCC CLASS-B 3m LF 47610 VERTICAL  
 Project : (FC)820819  
 IMEI : 868041030029834 868041030029842 #12

	Freq	Level	Over Limit	Limit Line	ReadAntenna Level	Cable Factor	Preamp Loss	A/Pos	T/Pos	Remark	
	MHz	dBuV/m	dB	dBuV/m	dBuV	dB/m	dB	dB	cm	deg	
1	30.00	23.53	-16.47	40.00	29.99	25.00	0.57	32.03	---	---	Peak
2	71.58	22.64	-17.36	40.00	41.37	12.45	0.86	32.04	---	---	Peak
3	153.12	24.29	-19.21	43.50	38.47	16.38	1.27	31.83	---	---	Peak
4	255.18	22.77	-23.23	46.00	33.41	19.10	1.77	31.51	---	---	Peak
5	712.30	29.99	-16.01	46.00	30.89	25.16	2.77	28.83	---	---	Peak
6	932.10	30.45	-15.55	46.00	27.77	26.79	3.16	27.27	100	0	Peak
7	1366.00	44.31	-29.69	74.00	46.72	28.63	3.85	34.89	---	---	Peak
8	1606.00	41.94	-32.06	74.00	43.40	29.00	4.20	34.66	---	---	Peak
9	1858.00	43.95	-30.05	74.00	43.71	29.43	4.50	33.69	---	---	Peak
10	3309.00	45.63	-28.37	74.00	36.08	33.26	6.25	29.96	---	---	Peak
11	3447.00	44.17	-29.83	74.00	34.25	33.46	6.32	29.86	---	---	Peak
12	5112.00	46.63	-27.37	74.00	37.60	35.42	7.80	34.19	---	---	Peak



Test Mode :	Mode 6	Temperature :	21~22°C
Test Engineer :	Maker Qi	Relative Humidity :	41~42%
Test Distance :	3m	Polarization :	Horizontal
Function Type :	LTE Band 7 Idle + Bluetooth Idle + WLAN (2.4G) Idle + USB Cable 2(Charging from Adapter1) + Earphone + FM RX(98MHz) for Sample 1		
Remark :	#3 is system simulator (FM Option) signal which can be ignored.		

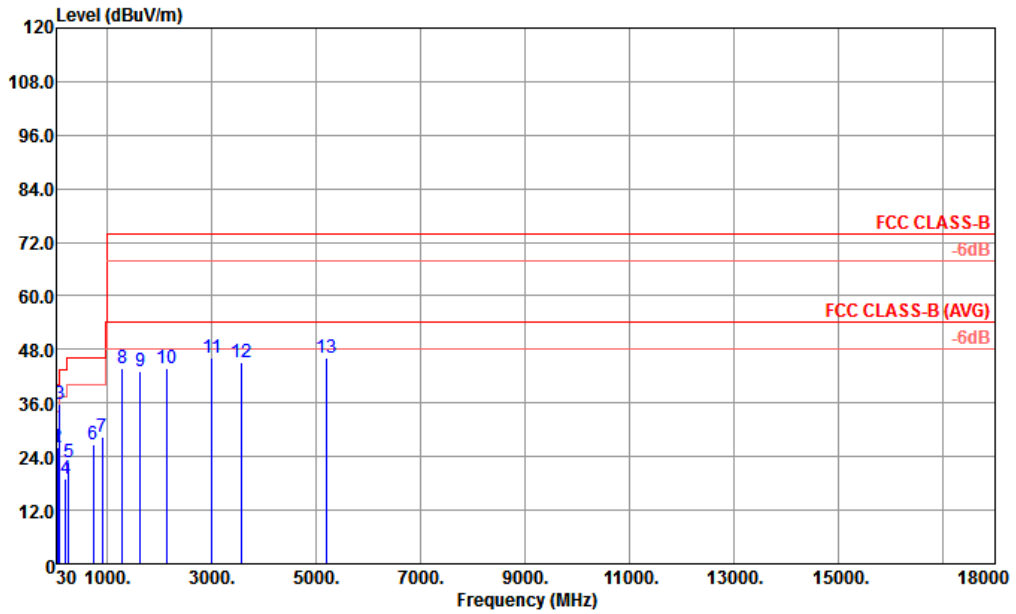

Site : 03CH02-KS  
 Condition : FCC CLASS-B 3m LF 47610 HORIZONTAL  
 Mode : 6  
 IMEI : 868041030029834 868041030029842 #12

	Freq	Level	Limit	Line	Level	Factor	Cable Loss	Preamp	A/Pos	T/Pos	Remark
	MHz	dBuV/m	dB	dBuV/m	dBuV	dB/m	dB	dB	cm	deg	
1	32.16	26.15	-13.85	40.00	33.70	23.88	0.60	32.03	100		Peak
2	45.12	25.96	-14.04	40.00	41.46	15.95	0.66	32.11	---	---	Peak
3	98.04	35.75			50.29	16.42	1.00	31.96	---	---	Peak
4	207.93	19.01	-24.49	43.50	33.84	15.33	1.49	31.65	---	---	Peak
5	259.50	22.73	-23.27	46.00	32.62	19.80	1.78	31.47	---	---	Peak
6	743.10	26.62	-19.38	46.00	26.90	25.60	2.81	28.69	---	---	Peak
7	907.60	28.57	-17.43	46.00	26.26	26.65	3.11	27.45	---	---	Peak
8	1298.00	43.74	-30.26	74.00	46.49	28.50	3.75	35.00	---	---	Peak
9	1640.00	43.25	-30.75	74.00	44.59	29.05	4.26	34.65	---	---	Peak
10	2140.00	43.74	-30.26	74.00	40.42	30.77	4.86	32.31	---	---	Peak
11	3012.00	46.13	-27.87	74.00	37.46	32.60	5.98	29.91	---	---	Peak
12	3576.00	45.28	-28.72	74.00	34.80	33.67	6.43	29.62	---	---	Peak
13	5196.00	46.17	-27.83	74.00	37.55	35.35	7.74	34.47	---	---	Peak





Test Mode :	Mode 6	Temperature :	21~22°C
Test Engineer :	Maker Qi	Relative Humidity :	41~42%
Test Distance :	3m	Polarization :	Vertical
Function Type :	LTE Band 7 Idle + Bluetooth Idle + WLAN (2.4G) Idle + USB Cable 2(Charging from Adapter1) + Earphone + FM RX(98MHz) for Sample 1		
Remark :	#5 is system simulator (FM Option) signal which can be ignored.		

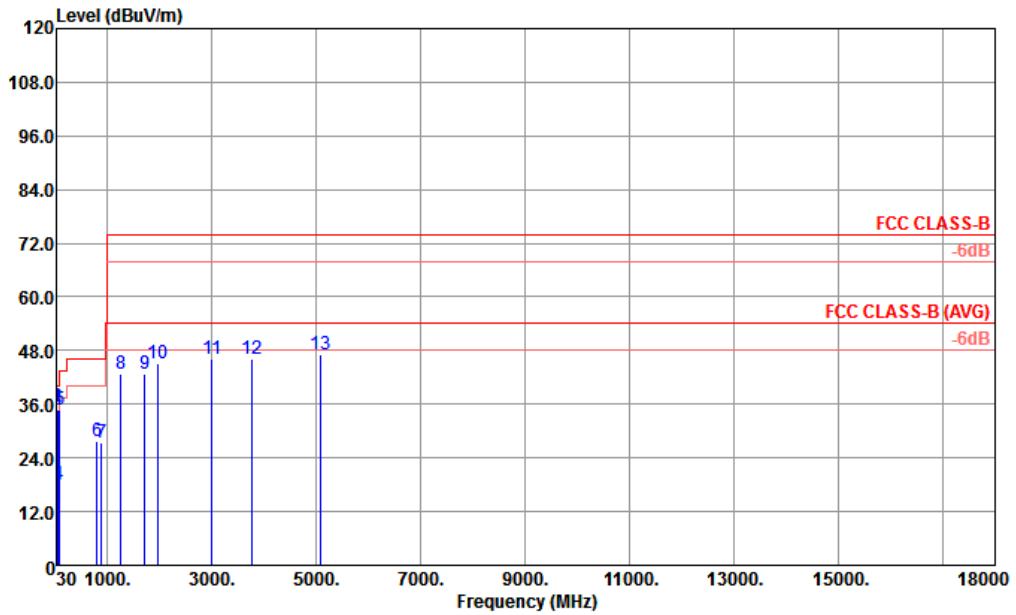

Site : 03CH02-KS  
 Condition : FCC CLASS-B 3m LF 47610 VERTICAL  
 Mode : 6  
 IMEI : 868041030029834 868041030029842 #12

	Freq	Level	Limit	Line	Level	Factor	Cable	Preamp	A/Pos	T/Pos	Remark
	MHz	dBuV/m	dB	dBuV/m	dBuV	dB/m	dB	dB	cm	deg	
1 !	33.24	35.49	-4.51	40.00	43.60	23.32	0.61	32.04	---	---	Peak
2 !	40.53	35.42	-4.58	40.00	48.21	18.62	0.64	32.05	---	---	Peak
3 !	44.58	34.85	-5.15	40.00	50.00	16.30	0.66	32.11	100	0	QP
4	66.45	18.14	-21.86	40.00	37.02	12.33	0.85	32.06	---	---	Peak
5	98.04	34.68			49.22	16.42	1.00	31.96	---	---	Peak
6	811.70	27.70	-18.30	46.00	27.20	25.99	2.74	28.23	---	---	Peak
7	890.10	27.25	-18.75	46.00	25.21	26.54	3.09	27.59	---	---	Peak
8	1268.00	42.70	-31.30	74.00	45.61	28.43	3.72	35.06	---	---	Peak
9	1720.00	42.76	-31.24	74.00	43.63	29.17	4.35	34.39	---	---	Peak
10	1974.00	45.01	-28.99	74.00	43.77	30.07	4.61	33.44	---	---	Peak
11	3012.00	46.20	-27.80	74.00	37.53	32.60	5.98	29.91	---	---	Peak
12	3777.00	46.10	-27.90	74.00	34.87	34.73	6.61	30.11	---	---	Peak
13	5079.00	47.15	-26.85	74.00	38.02	35.45	7.81	34.13	---	---	Peak



### 4. List of Measuring Equipment

Instrument	Manufacturer	Model No.	Serial No.	Characteristics	Calibration Date	Test Date	Due Date	Remark
EMI Receiver	R&S	ESC17	100768	9kHz~7GHz;	Apr. 20, 2017	Mar. 07, 2018	Apr. 19, 2018	Conduction (CO01-KS)
AC LISN	MessTec	AN3016	060103	9kHz~30MHz	Oct. 13, 2017	Mar. 07, 2018	Oct. 12, 2018	Conduction (CO01-KS)
AC LISN (for auxiliary equipment)	MessTec	AN3016	060105	9kHz~30MHz	Oct. 13, 2017	Mar. 07, 2018	Oct. 12, 2018	Conduction (CO01-KS)
AC Power Source	Chroma	61602	ABP0000008 11	AC 0V~300V, 45Hz~1000Hz	Oct. 12, 2017	Mar. 07, 2018	Oct. 11, 2018	Conduction (CO01-KS)
EMI Test Receiver	R&S	ESR7	101403	9kHz~7GHz; Max 30dBm	Aug. 08, 2017	Mar. 08, 2018	Aug. 07, 2018	Radiation (03CH02-KS)
EXA Spectrum Analyzer	Keysight	N9010A	MY55150208	10Hz~44GHz, MAX 30dB	Apr. 18, 2017	Mar. 08, 2018	Apr. 17, 2018	Radiation (03CH02-KS)
Bilog Antenna	TeseQ	CBL6112D	23188	30MHz~2GHz	Apr. 25, 2017	Mar. 08, 2018	Apr. 24, 2018	Radiation (03CH02-KS)
Double Ridge Horn Antenna	ETS-Lindgren	3117	75957	1GHz~18GHz	Oct. 21, 2017	Mar. 08, 2018	Oct. 20, 2018	Radiation (03CH02-KS)
SHF-EHF Horn	Schwarzbeck	BBHA 9170	BBHA170249	15GHz~40GHz	Feb. 07, 2018	Mar. 08, 2018	Feb. 06, 2019	Radiation (03CH02-KS)
Amplifier	MITEQ	TTA1840-35-H G	1887435	18GHz~40GHz	Oct. 12, 2017	Mar. 08, 2018	Oct. 11, 2018	Radiation (03CH02-KS)
Amplifier	SONOMA	310N	187289	9kHz~1GHz	Aug. 07, 2017	Mar. 08, 2018	Aug. 06, 2018	Radiation (03CH02-KS)
Amplifier	Agilent	8449B	3008A02384	1-26.5GHz Gain 30dB	Oct. 12, 2017	Mar. 08, 2018	Oct. 11, 2018	Radiation (03CH02-KS)
AC Power Source	Chroma	61601	61601000247 3	N/A	NCR	Mar. 08, 2018	NCR	Radiation (03CH02-KS)
Turn Table	MF	MF7802	N/A	0~360 degree	NCR	Mar. 08, 2018	NCR	Radiation (03CH02-KS)
Antenna Mast	MF	MF7802	N/A	1 m~4 m	NCR	Mar. 08, 2018	NCR	Radiation (03CH02-KS)

NCR: No Calibration Required



## 5. Uncertainty of Evaluation

### Uncertainty of Conducted Emission Measurement (150 kHz ~ 30 MHz)

Measuring Uncertainty for a Level of Confidence of 95% ( $U = 2Uc(y)$ )	2.3dB
---	-------

### Uncertainty of Radiated Emission Measurement (30 MHz ~ 1000 MHz)

Measuring Uncertainty for a Level of Confidence of 95% ( $U = 2Uc(y)$ )	4.5dB
---	-------

### Uncertainty of Radiated Emission Measurement (1GHz ~ 18GHz)

Measuring Uncertainty for a Level of Confidence of 95% ( $U = 2Uc(y)$ )	4.2dB
---	-------

### Uncertainty of Radiated Emission Measurement (18GHz ~ 40GHz)

Measuring Uncertainty for a Level of Confidence of 95% ( $U = 2Uc(y)$ )	4.7dB
---	-------