



FCC RF Test Report

APPLICANT : Xiaomi Communications Co., Ltd.
EQUIPMENT : Mobile Phone
BRAND NAME : MI
MODEL NAME : M1803E6G
FCC ID : 2AFZZ-RMSE6G
STANDARD : 47 CFR Part 2, 22(H), 24(E), 27(L), 27(M)
CLASSIFICATION : PCS Licensed Transmitter Held to Ear (PCE)

The product was received on Feb. 08, 2018 and completely tested on Mar. 22, 2018. We, Sporton International (Kunshan) Inc., would like to declare that the tested sample has been evaluated in accordance with the test procedures given in ANSI / TIA-603-E and the testing has shown the tested sample to be in compliance with the applicable technical standards.

The test results in this report apply exclusively to the tested model / sample. Without written approval of Sporton International (Kunshan) Inc., the test report shall not be reproduced except in full.



Approved by: James Huang / Manager

Sporton International (Kunshan) Inc.
No.3-2 Ping-Xiang Rd, Kunshan Development Zone Kunshan City Jiangsu Province 215335
China



TABLE OF CONTENTS

1 GENERAL DESCRIPTION 6
1.1 Applicant 6
1.2 Manufacturer 6
1.3 Product Feature of Equipment Under Test 6
1.4 Product Specification of Equipment Under Test 7
1.5 Maximum ERP/EIRP Power, Frequency Tolerance, and Emission Designator 8
1.6 Modification of EUT 9
1.7 Testing Location 10
1.8 Applicable Standards 10
2 TEST CONFIGURATION OF EQUIPMENT UNDER TEST 11
2.1 Test Mode 11
2.2 Connection Diagram of Test System 13
2.3 Support Unit used in test configuration and system 13
2.4 Measurement Results Explanation Example 13
2.5 Frequency List of Low/Middle/High Channels 14
3 CONDUCTED TEST ITEMS 16
3.1 Measuring Instruments 16
3.2 Test Setup 16
3.3 Test Result of Conducted Test 16
3.4 Conducted Output Power and ERP/EIRP 17
3.5 Peak-to-Average Ratio 18
3.6 Occupied Bandwidth 19
3.7 Conducted Band Edge 20
3.8 Conducted Spurious Emission 22
3.9 Frequency Stability 23
4 RADIATED TEST ITEMS 24
4.1 Measuring Instruments 24
4.2 Test Setup 24
4.3 Test Result of Radiated Test 24
4.4 Radiated Spurious Emission 25
5 LIST OF MEASURING EQUIPMENT 26
6 UNCERTAINTY OF EVALUATION 27
APPENDIX A. TEST RESULTS OF CONDUCTED TEST
APPENDIX B. TEST RESULTS OF RADIATED TEST
APPENDIX C. TEST SETUP PHOTOGRAPHS



REVISION HISTORY

REPORT NO.	VERSION	DESCRIPTION	ISSUED DATE
FG820819B	Rev. 01	Initial issue of report	Apr. 04, 2018



SUMMARY OF TEST RESULT

Report Section	FCC Rule	Description	Limit	Result	Remark
3.4	§2.1046	Conducted Output Power	Reporting Only	PASS	-
	§22.913(a)(2)	Effective Radiated Power (Band 5)	ERP < 7 Watt		
	§27.50(h)(2)	Equivalent Isotropic Radiated Power (Band 7)(Band 38)	EIRP < 2Watt		
	§27.50(d)(4)	Equivalent Isotropic Radiated Power (Band 4)	EIRP < 1Watt		
3.5	N/A	Peak-to-Average Ratio	<13 dB	PASS	-
3.6	§2.1049	Occupied Bandwidth	Reporting Only	PASS	-
3.7	§2.1051 §22.917(a) §27.53(h)	Conducted Band Edge Measurement (Band 4) (Band 5)	< 43+10log ₁₀ (P[Watts])	PASS	-
	§27.53(m)(4)	Conducted Band Edge Measurement (Band 7) (Band 38)	§27.53(m)(4)		
3.8	§2.1051 §22.917(a) §27.53(h)	Conducted Spurious Emission (Band 4) (Band 5)	< 43+10log ₁₀ (P[Watts])	PASS	-
	§2.1051 §27.53(m)(4)	Conducted Spurious Emission (Band 7)(Band 38)	< 55+10log ₁₀ (P[Watts])		
3.9	§2.1055 §22.355	Frequency Stability Temperature & Voltage	< 2.5 ppm for Part 22	PASS	-
	§2.1055 §27.54		Within Authorized Band		



Report Section	FCC Rule	Description	Limit	Result	Remark
4.4	§2.1053 §22.917(a) §27.53(h)	Radiated Spurious Emission (Band 4) (Band 5)	$< 43+10\log_{10}(P[\text{Watts}])$	PASS	Under limit 30.50 dB at 5172.000 MHz
	§2.1053 §27.53(m)(4)	Radiated Spurious Emission (Band 7) (Band 38)	$< 55+10\log_{10}(P[\text{Watts}])$		



1 General Description

1.1 Applicant

Xiaomi Communications Co., Ltd.

The Rainbow City of China Resources, NO.68, Qinghe Middle Street, Haidian District, Beijing, China

1.2 Manufacturer

Xiaomi Communications Co., Ltd.

The Rainbow City of China Resources, NO.68, Qinghe Middle Street, Haidian District, Beijing, China

1.3 Product Feature of Equipment Under Test

Product Feature	
Equipment	Mobile Phone
Brand Name	MI
Model Name	M1803E6G
FCC ID	2AFZZ-RMSE6G
EUT supports Radios application	GSM/GPRS/EGPRS/WCDMA/HSPA/DC-HSDPA/HSPA+(16QAM uplink is not supported)/LTE/WLAN 2.4GHz 802.11b/g/n HT20/Bluetooth v3.0 + EDR/Bluetooth v4.0 LE / v4.2LE
IMEI Code	Conducted: 868041030029271/868041030029289 Radiation: 868041030029834/868041030029842
HW Version	P2
SW Version	MIUI 9
EUT Stage	Identical Prototype

Remark: There are two types of EUT sample 1 and sample 2, the differences between two samples are only for Flash, sample 1 is 3GB+32GB, sample 2 is 4GB+64GB. According to the difference, choose sample 1 to perform full tests.



1.4 Product Specification of Equipment Under Test

Standards-related Product Specification	
Tx Frequency	LTE Band 4 : 1710.7 MHz ~ 1754.3 MHz LTE Band 5 : 824.7 MHz ~ 848.3 MHz LTE Band 7 : 2502.5 MHz ~ 2567.5 MHz LTE Band 38 : 2572.5MHz ~ 2617.5MHz
Rx Frequency	LTE Band 4 : 2110.7 MHz ~ 2154.3 MHz LTE Band 5 : 869.7 MHz ~ 893.3 MHz LTE Band 7 : 2622.5MHz ~ 2687.5 MHz LTE Band 38 : 2572.5MHz ~ 2617.5MHz
Bandwidth	LTE Band 4 : 1.4MHz / 3MHz / 5MHz / 10MHz / 15MHz / 20MHz LTE Band 5 : 1.4MHz / 3MHz / 5MHz / 10MHz LTE Band 7 : 5MHz / 10MHz / 15MHz / 20MHz LTE Band 38 : 5MHz / 10MHz / 15MHz / 20MHz
Maximum Output Power to Antenna	LTE Band 4 : 23.32 dBm LTE Band 5 : 23.24 dBm LTE Band 7 : 22.85 dBm LTE Band 38 : 22.42 dBm
Antenna Gain	LTE Band 4 : 2.67 dBi LTE Band 5 : -1.16 dBi LTE Band 7 : 2.45 dBi LTE Band 38 : 2.45 dBi
Type of Modulation	QPSK / 16QAM



1.5 Maximum ERP/EIRP Power, Frequency Tolerance, and Emission Designator

LTE Band 4		QPSK			16QAM		
BW (MHz)	Frequency Range (MHz)	Emission Designator (99%OBW)	Frequency Tolerance (ppm)	Maximum EIRP(W)	Emission Designator (99%OBW)	Frequency Tolerance (ppm)	Maximum EIRP(W)
1.4	1710.7 ~ 1754.3	1M10G7D	-	0.3776	1M10W7D	-	0.3155
3	1711.5 ~ 1753.5	2M72G7D	-	0.3890	2M73W7D	-	0.2891
5	1712.5 ~ 1752.5	4M49G7D	-	0.3908	4M50W7D	-	0.2871
10	1715.0 ~ 1750.0	8M97G7D	0.0030	0.3926	9M03W7D	-	0.2864
15	1717.5 ~ 1747.5	13M5G7D	-	0.3811	13M4W7D	-	0.2851
20	1720.0 ~ 1745.0	18M3G7D	-	0.3972	18M4W7D	-	0.2818
LTE Band 5		QPSK			16QAM		
BW (MHz)	Frequency Range (MHz)	Emission Designator (99%OBW)	Frequency Tolerance (ppm)	Maximum ERP(W)	Emission Designator (99%OBW)	Frequency Tolerance (ppm)	Maximum ERP(W)
1.4	824.7 ~ 848.3	1M10G7D	-	0.0977	1M10W7D	-	0.0881
3	825.5 ~ 847.5	2M72G7D	-	0.0975	2M73W7D	-	0.0875
5	826.5 ~ 846.5	4M47G7D	-	0.0982	4M49W7D	-	0.0863
10	829.0 ~ 844.0	9M05G7D	0.0060	0.0984	9M07W7D	-	0.0910
LTE Band 7		QPSK			16QAM		
BW (MHz)	Frequency Range (MHz)	Emission Designator (99%OBW)	Frequency Tolerance (ppm)	Maximum EIRP(W)	Emission Designator (99%OBW)	Frequency Tolerance (ppm)	Maximum EIRP(W)
5	2502.5 ~ 2567.5	4M49G7D	-	0.3214	4M49W7D	-	0.2564
10	2505.0 ~ 2565.0	9M01G7D	0.0032	0.3373	8M99W7D	-	0.2449
15	2507.5 ~ 2562.5	13M4G7D	-	0.3381	13M4W7D	-	0.2477
20	2510.0 ~ 2560.0	18M4G7D	-	0.3388	18M3W7D	-	0.2427
LTE Band 38		QPSK			16QAM		
BW (MHz)	Frequency Range (MHz)	Emission Designator (99%OBW)	Frequency Tolerance (ppm)	Maximum EIRP(W)	Emission Designator (99%OBW)	Frequency Tolerance (ppm)	Maximum EIRP(W)
5	2572.5 ~ 2617.5	4M49G7D	-	0.2958	4M49W7D	-	0.2388
10	2575.0 ~ 2615.0	9M01G7D	0.0026	0.3062	9M05W7D	-	0.2438
15	2577.5 ~ 2612.5	13M4G7D	-	0.3020	13M4W7D	-	0.2477
20	2580.0 ~ 2610.0	18M3G7D	-	0.3069	18M3W7D	-	0.2477



1.6 Modification of EUT

No modifications are made to the EUT during all test items.



1.7 Testing Location

Sporton International (Kunshan) Inc. is accredited to ISO 17025 by National Voluntary Laboratory Accreditation Program (NVLAP code: 600155-0) and the FCC designation No. is CN5013.

Test Site	Sporton International (Kunshan) Inc.		
Test Site Location	No.3-2 Ping-Xiang Rd, Kunshan Development Zone Kunshan City Jiangsu Province 215335 China TEL : +86-512-57900158 FAX : +86-512-57900958		
Test Site No.	Sporton Site No.		FCC Test Firm Registration No.
	CO01-KS	03CH03-KS	630927

Note: The test site complies with ANSI C63.4 2014 requirement.

1.8 Applicable Standards

According to the specifications of the manufacturer, the EUT must comply with the requirements of the following standards:

- 47 CFR Part 2, 22(H), 24(E), 27(L), 27(M)
- ANSI / TIA-603-E
- FCC KDB 971168 D01 Power Meas. License Digital Systems v03
- FCC KDB 412172 D01 Determining ERP and EIRP v01r01

Remark:

1. All test items were verified and recorded according to the standards and without any deviation during the test.
2. This EUT has also been tested and complied with the requirements of FCC Part 15, Subpart B, Subpart B, recorded in a separate test report.



2 Test Configuration of Equipment Under Test

2.1 Test Mode

Antenna port conducted and radiated test items listed below are performed according to KDB 971168 D01 Power Meas. License Digital Systems v03 with maximum output power.

Radiated measurements are performed by rotating the EUT in three different orthogonal test planes to find the maximum emission.

Test Items	Band	Bandwidth (MHz)						Modulation			RB #			Test Channel		
		1.4	3	5	10	15	20	QPSK	16QAM	64QAM	1	Half	Full	L	M	H
Max. Output Power	4	v	v	v	v	v	v	v	v	v	v	v	v	v	v	v
	5	v	v	v	v	-	-	v	v	v	v	v	v	v	v	v
	7	-	-	v	v	v	v	v	v	v	v	v	v	v	v	v
	38	-	-	v	v	v	v	v	v	v	v	v	v	v	v	v
Peak-to-Average Ratio	4						v	v	v	v	v		v	v	v	v
	5				v	-	-	v	v	v	v		v	v	v	v
	7	-	-				v	v	v	v	v		v	v	v	v
	38	-	-				v	v	v	v	v		v	v	v	v
26dB and 99% Bandwidth	4	v	v	v	v	v	v	v	v	v			v	v	v	v
	5	v	v	v	v	-	-	v	v	v			v	v	v	v
	7	-	-	v	v	v	v	v	v	v			v	v	v	v
	38	-	-	v	v	v	v	v	v	v			v	v	v	v
Conducted Band Edge	4	v	v	v	v	v	v	v	v	v	v		v	v		v
	5	v	v	v	v	-	-	v	v	v	v		v	v		v
	7	-	-	v	v	v	v	v	v	v	v		v	v		v
	38	-	-	v	v	v	v	v	v	v	v		v	v		v



Test Items	Band	Bandwidth (MHz)						Modulation			RB #			Test Channel		
		1.4	3	5	10	15	20	QPSK	16QAM	64QAM	1	Half	Full	L	M	H
Conducted Spurious Emission	4	v	v	v	v	v	v	v	v	v	v			v	v	v
	5	v	v	v	v	-	-	v	v	v	v			v	v	v
	7	-	-	v	v	v	v	v	v	v	v			v	v	v
	38	-	-	v	v	v	v	v	v	v	v			v	v	v
Frequency Stability	4				v			v					v		v	
	5				v	-	-	v					v		v	
	7	-	-		v			v					v		v	
	38	-	-		v			v					v		v	
E.R.P / E.I.R.P	4	v	v	v	v	v	v	v	v	v	v			v	v	v
	5	v	v	v	v	-	-	v	v	v	v			v	v	v
	7	-	-	v	v	v	v	v	v	v	v			v	v	v
	38	-	-	v	v	v	v	v	v	v	v			v	v	v
Radiated Spurious Emission	4						v	v			v				v	
	5				v			v			v				v	
	7						v	v			v				v	
	38						v	v			v				v	
Note	1. The mark "v" means that this configuration is chosen for testing 2. The mark "-" means that this bandwidth is not supported. 3. The device is investigated from 30MHz to 10 times of fundamental signal for radiated spurious emission test under different RB size/offset and modulations in exploratory test. Subsequently, only the worst case emissions are reported.															

2.2 Connection Diagram of Test System

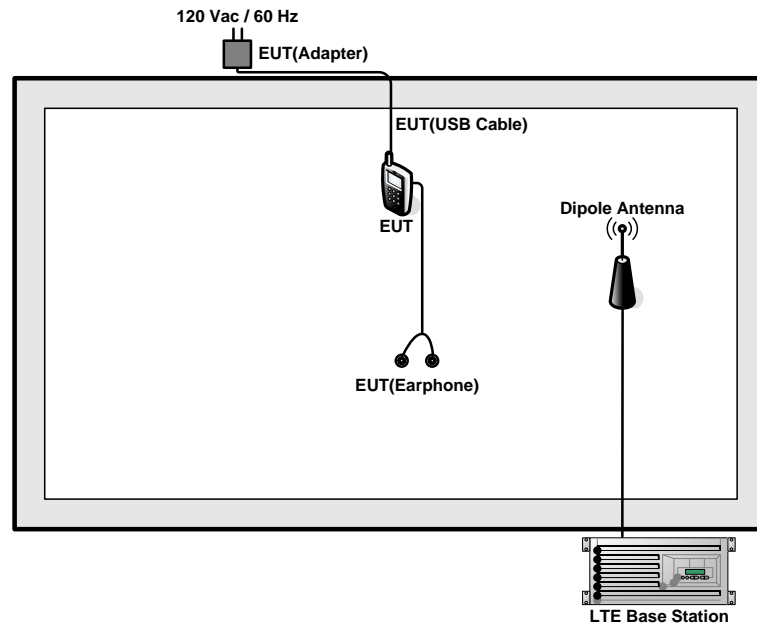

2.3 Support Unit used in test configuration and system

Item	Equipment	Trade Name	Model No.	FCC ID	Data Cable	Power Cord
1.	LTE Base Station	Anritsu	MT8820C	N/A	N/A	Unshielded, 1.8 m
2.	DC Power Supply	GW	GPS-3030D	N/A	N/A	Unshielded, 1.8 m

2.4 Measurement Results Explanation Example

For all conducted test items:

The offset level is set in the spectrum analyzer to compensate the RF cable loss between EUT conducted output port and spectrum analyzer. With the offset compensation, the spectrum analyzer reading level is exactly the EUT RF output level.

The spectrum analyzer offset is derived from RF cable loss.

Offset = RF cable loss.

Following shows an offset computation example with cable loss 5.1 dB.

Example :

$$\begin{aligned} \text{Offset(dB)} &= \text{RF cable loss(dB)}. \\ &= 5.1 \text{ (dB)} \end{aligned}$$



2.5 Frequency List of Low/Middle/High Channels

LTE Band 4 Channel and Frequency List				
BW [MHz]	Channel/Frequency(MHz)	Lowest	Middle	Highest
20	Channel	20050	20175	20300
	Frequency	1720	1732.5	1745
15	Channel	20025	20175	20325
	Frequency	1717.5	1732.5	1747.5
10	Channel	20000	20175	20350
	Frequency	1715	1732.5	1750
5	Channel	19975	20175	20375
	Frequency	1712.5	1732.5	1752.5
3	Channel	19965	20175	20385
	Frequency	1711.5	1732.5	1753.5
1.4	Channel	19957	20175	20393
	Frequency	1710.7	1732.5	1754.3

LTE Band 5 Channel and Frequency List				
BW [MHz]	Channel/Frequency(MHz)	Lowest	Middle	Highest
10	Channel	20450	20525	20600
	Frequency	829	836.5	844
5	Channel	20425	20525	20625
	Frequency	826.5	836.5	846.5
3	Channel	20415	20525	20635
	Frequency	825.5	836.5	847.5
1.4	Channel	20407	20525	20643
	Frequency	824.7	836.5	848.3



LTE Band 7 Channel and Frequency List				
BW [MHz]	Channel/Frequency(MHz)	Lowest	Middle	Highest
20	Channel	20850	21100	21350
	Frequency	2510	2535	2560
15	Channel	20825	21100	21375
	Frequency	2507.5	2535	2562.5
10	Channel	20800	21100	21400
	Frequency	2505	2535	2565
5	Channel	20775	21100	21425
	Frequency	2502.5	2535	2567.5

LTE Band 38 Channel and Frequency List				
BW [MHz]	Channel/Frequency(MHz)	Lowest	Middle	Highest
20	Channel	37850	38000	38150
	Frequency	2580	2595	2610
15	Channel	37825	38000	38175
	Frequency	2577.5	2595	2612.5
10	Channel	37800	38000	38200
	Frequency	2575	2595	2615
5	Channel	37775	38000	38225
	Frequency	2572.5	2595	2617.5

3 Conducted Test Items

3.1 Measuring Instruments

See list of measuring instruments of this test report.

3.2 Test Setup

3.2.1 Conducted Output Power

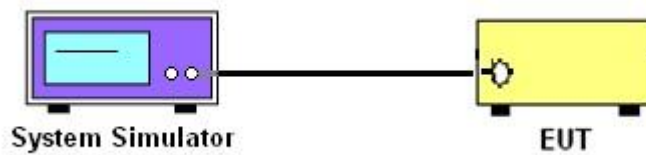

3.2.2 Peak-to-Average Ratio, Occupied Bandwidth ,Conducted Band-Edge and Conducted Spurious Emission

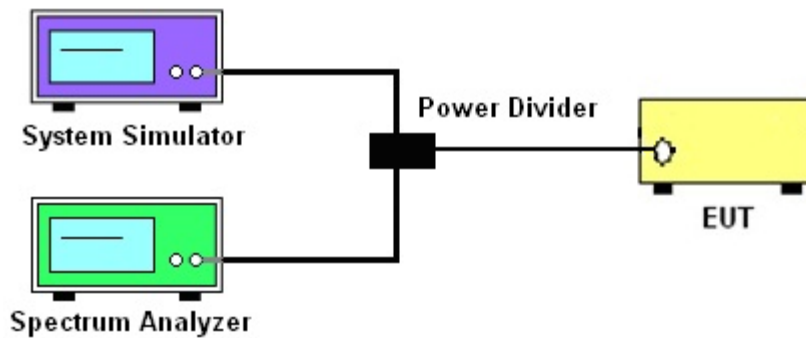

3.2.3 Frequency Stability

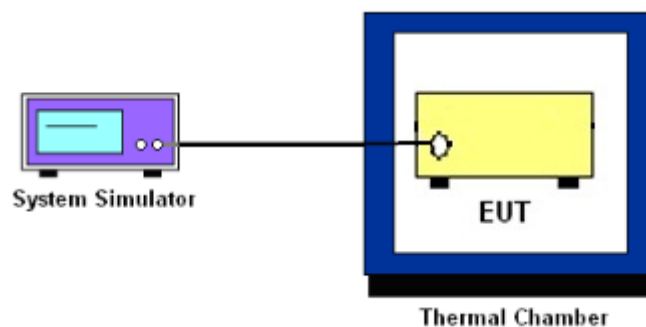

3.3 Test Result of Conducted Test

Please refer to Appendix A.



3.4 Conducted Output Power and ERP/EIRP

3.4.1 Description of the Conducted Output Power Measurement and ERP/EIRP Measurement

A system simulator was used to establish communication with the EUT. Its parameters were set to force the EUT transmitting at maximum output power. The measured power in the radio frequency on the transmitter output terminals shall be reported.

The ERP of mobile transmitters must not exceed 7 Watts for LTE Band 5.

The EIRP of mobile transmitters must not exceed 2 Watts for LTE Band 7 and Band 38.

The EIRP of mobile transmitters must not exceed 1 Watts for LTE Band 4.

According to KDB 412172 D01 Power Approach,

$EIRP = P_T + G_T - L_C$, $ERP = EIRP - 2.15$, where

P_T = transmitter output power in dBm

G_T = gain of the transmitting antenna in dBi

L_C = signal attenuation in the connecting cable between the transmitter and antenna in dB

3.4.2 Test Procedures

1. The transmitter output port was connected to the system simulator.
2. Set EUT at maximum power through the system simulator.
3. Select lowest, middle, and highest channels for each band and different modulation.
4. Measure and record the power level from the system simulator.



3.5 Peak-to-Average Ratio

3.5.1 Description of the PAR Measurement

Power Complementary Cumulative Distribution Function (CCDF) curves provide a means for characterizing the power peaks of a digitally modulated signal on a statistical basis. A CCDF curve depicts the probability of the peak signal amplitude exceeding the average power level. Most contemporary measurement instrumentation include the capability to produce CCDF curves for an input signal provided that the instrument's resolution bandwidth can be set wide enough to accommodate the entire input signal bandwidth. In measuring transmissions in this band using an average power technique, the peak-to-average ratio (PAR) of the transmission may not exceed 13 dB.

3.5.2 Test Procedures

The testing follows FCC KDB 971168 v03 Section 5.7.1

1. The EUT was connected to spectrum and system simulator via a power divider.
2. Set the CCDF (Complementary Cumulative Distribution Function) option in spectrum analyzer.
3. The highest RF powers were measured and recorded the maximum PAPR level associated with a probability of 0.1 %.
4. Record the deviation as Peak to Average Ratio.



3.6 Occupied Bandwidth

3.6.1 Description of Occupied Bandwidth Measurement

The occupied bandwidth is the width of a frequency band such that, below the lower and above the upper frequency limits, the mean powers emitted are each equal to a specified percentage 0.5% of the total mean transmitted power.

The 26 dB emission bandwidth is defined as the frequency range between two points, one above and one below the carrier frequency, at which the spectral density of the emission is attenuated 26 dB below the maximum in-band spectral density of the modulated signal. Spectral density (power per unit bandwidth) is to be measured with a detector of resolution bandwidth equal to approximately 1.0% of the emission bandwidth.

3.6.2 Test Procedures

The testing follows FCC KDB 971168 v03 Section 4.2

1. The EUT was connected to spectrum analyzer and system simulator via a power divider.
2. The spectrum analyzer center frequency is set to the nominal EUT channel center frequency. The span range for the spectrum analyzer shall be between two and five times the anticipated OBW.
3. The nominal resolution bandwidth (RBW) shall be in the range of 1 to 5 % of the anticipated OBW, and the VBW shall be at least 3 times the RBW.
4. Set the detection mode to peak, and the trace mode to max hold.
5. Determine the reference value: Set the EUT to transmit a modulated signal. Allow the trace to stabilize. Set the spectrum analyzer marker to the highest level of the displayed trace.
(this is the reference value)
6. Determine the “-26 dB down amplitude” as equal to (Reference Value – X).
7. Place two markers, one at the lowest and the other at the highest frequency of the envelope of the spectral display such that each marker is at or slightly below the “-X dB down amplitude” determined in step 6. If a marker is below this “-X dB down amplitude” value it shall be placed as close as possible to this value. The OBW is the positive frequency difference between the two markers.
8. Use the 99 % power bandwidth function of the spectrum analyzer and report the measured bandwidth.



3.7 Conducted Band Edge

3.7.1 Description of Conducted Band Edge Measurement

22.917(a)

For operations in the 824 – 849 MHz band, the FCC limit is $43 + 10\log_{10}(P[\text{Watts}])$ dB below the transmitter power $P(\text{Watts})$ in a 100kHz bandwidth. However, in the 1MHz bands immediately outside and adjacent to the licensee's frequency block, a resolution bandwidth of at least one percent of the emission bandwidth of the fundamental emission of the transmitter may be employed.

27.53 (h)

For operations in the 1710 – 1755 MHz band, the FCC limit is $43 + 10\log_{10}(P[\text{Watts}])$ dB below the transmitter power $P(\text{Watts})$ in a 1 MHz bandwidth. However, in the 1MHz bands immediately outside and adjacent to the licensee's frequency block, a resolution bandwidth of at least one percent of the emission bandwidth of the fundamental emission of the transmitter may be employed.

27.53(m)(4)

For mobile digital stations, the attenuation factor shall be not less than $40 + 10 \log (P)$ dB on all frequencies between the channel edge and 5 megahertz from the channel edge, $43 + 10 \log (P)$ dB on all frequencies between 5 megahertz and X megahertz from the channel edge, and $55 + 10 \log (P)$ dB on all frequencies more than X megahertz from the channel edge, where X is the greater of 6 megahertz or the actual emission bandwidth as defined in paragraph (m)(6) of this section. In addition, the attenuation factor shall not be less that $43 + 10 \log (P)$ dB on all frequencies between 2490.5 MHz and 2496 MHz and $55 + 10 \log (P)$ dB at or below 2490.5 MHz. Mobile Satellite Service licensees operating on frequencies below 2495 MHz may also submit a documented interference complaint against BRS licensees operating on channel BRS Channel 1 on the same terms and conditions as adjacent channel BRS or EBS licensees.



3.7.2 Test Procedures

The testing follows FCC KDB 971168 v03 Section 6.0.

1. The EUT was connected to spectrum analyzer and system simulator via a power divider.
2. The band edges of low and high channels for the highest RF powers were measured.
3. Set RBW \geq 1% EBW in the 1MHz band immediately outside and adjacent to the band edge.
4. Beyond the 1 MHz band from the band edge, RBW=1MHz was used.
5. Set spectrum analyzer with RMS detector.
6. The RF fundamental frequency should be excluded against the limit line in the operating frequency band.
7. Checked that all the results comply with the emission limit line.
The limit line is derived from $43 + 10\log(P)$ dB below the transmitter power P(Watts)
8. For LTE Band 7, 38, the other 40 dB, and 55 dB have additionally applied same calculation above.



3.8 Conducted Spurious Emission

3.8.1 Description of Conducted Spurious Emission Measurement

The power of any emission outside of the authorized operating frequency ranges must be lower than the transmitter power (P) by a factor of at least $43 + 10 \log (P)$ dB.

For Band 7,38:

The power of any emission outside of the authorized operating frequency ranges must be lower than the transmitter power (P) by a factor of at least $55 + 10 \log (P)$ dB.

It is measured by means of a calibrated spectrum analyzer and scanned from 30 MHz up to a frequency including its 10th harmonic.

3.8.2 Test Procedures

The testing follows FCC KDB 971168 v03 Section 6.0.

1. The EUT was connected to spectrum analyzer and system simulator via a power divider.
2. The RF output of EUT was connected to the spectrum analyzer by RF cable and attenuator. The path loss was compensated to the results for each measurement.
3. The middle channel for the highest RF power within the transmitting frequency was measured.
4. The conducted spurious emission for the whole frequency range was taken.
5. Make the measurement with the spectrum analyzer's RBW = 1MHz, VBW = 3MHz.
6. Set spectrum analyzer with RMS detector.
7. Taking the record of maximum spurious emission.
8. The RF fundamental frequency should be excluded against the limit line in the operating frequency band.
9. The limit line is derived from $43 + 10\log(P)$ dB below the transmitter power P(Watts)
10. For Band 7, 38
The limit line is derived from $55 + 10\log(P)$ dB below the transmitter power P(Watts)



3.9 Frequency Stability

3.9.1 Description of Frequency Stability Measurement

The frequency stability shall be measured by variation of ambient temperature and variation of primary supply voltage to ensure that the fundamental emission stays within the authorized frequency block. The frequency stability of the transmitter shall be maintained within $\pm 0.00025\%$ ($\pm 2.5\text{ppm}$) of the center frequency.

3.9.2 Test Procedures for Temperature Variation

The testing follows FCC KDB 971168 v03 Section 9.0.

1. The EUT was set up in the thermal chamber and connected with the system simulator.
2. With power OFF, the temperature was decreased to -30°C and the EUT was stabilized before testing. Power was applied and the maximum change in frequency was recorded within one minute.
3. With power OFF, the temperature was raised in 10°C step up to 50°C . The EUT was stabilized at each step for at least half an hour. Power was applied and the maximum frequency change was recorded within one minute.

3.9.3 Test Procedures for Voltage Variation

The testing follows FCC KDB 971168 v03 Section 9.0.

1. The EUT was placed in a temperature chamber at $20\pm 5^{\circ}\text{C}$ and connected with the system simulator.
2. The power supply voltage to the EUT was varied from 85% to 115% of the nominal value measured at the input to the EUT.
3. The variation in frequency was measured for the worst case.

4 Radiated Test Items

4.1 Measuring Instruments

See list of measuring instruments of this test report.

4.2 Test Setup

4.2.1 For radiated test from 30MHz to 1GHz

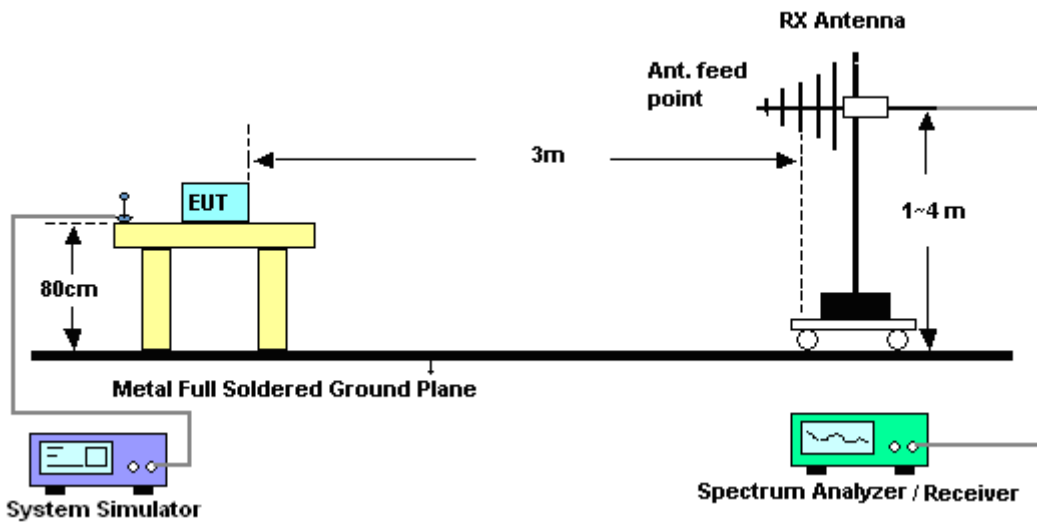

4.2.2 For radiated test above 1GHz

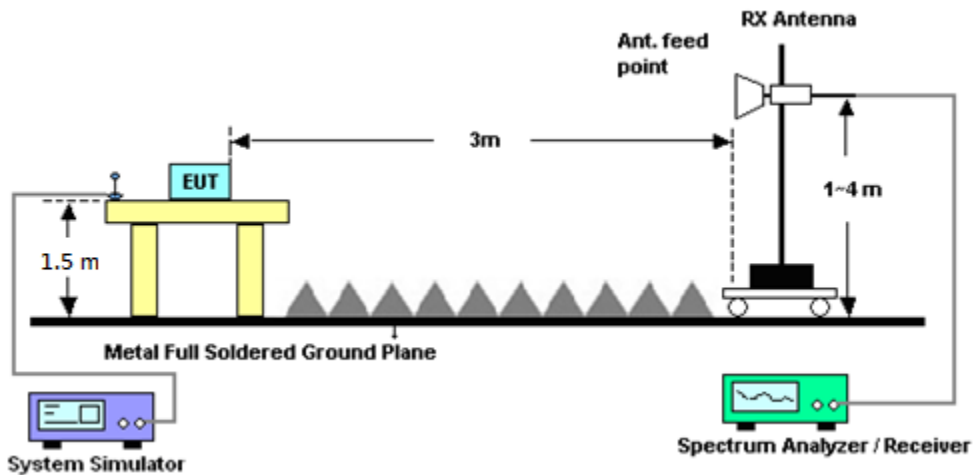

4.3 Test Result of Radiated Test

Please refer to Appendix B.



4.4 Radiated Spurious Emission

4.4.1 Description of Radiated Spurious Emission

The radiated spurious emission was measured by substitution method according to ANSI / TIA-603-E. The power of any emission outside of the authorized operating frequency ranges must be attenuated below the transmitter power (P) by a factor of at least $43 + 10 \log (P)$ dB.

For Band 7, 38

The power of any emission outside of the authorized operating frequency ranges must be attenuated below the transmitter power (P) by a factor of at least $55 + 10 \log (P)$ dB.

The spectrum is scanned from 30 MHz up to a frequency including its 10th harmonic.

4.4.2 Test Procedures

The testing follows FCC KDB 971168 v03 Section 5.8 and ANSI / TIA-603-E Section 2.2.12.

1. The EUT was placed on a turntable with 0.8 meter for frequency below 1GHz and 1.5 meter for frequency above 1GHz respectively above ground.
2. The EUT was set 3 meters from the receiving antenna, which was mounted on the antenna tower.
3. The table was rotated 360 degrees to determine the position of the highest spurious emission.
4. The height of the receiving antenna is varied between one meter and four meters to search the maximum spurious emission for both horizontal and vertical polarizations.
5. Make the measurement with the spectrum analyzer's RBW = 1MHz, VBW = 3MHz, taking the record of maximum spurious emission.
6. A horn antenna was substituted in place of the EUT and was driven by a signal generator.
7. Tune the output power of signal generator to the same emission level with EUT maximum spurious emission.
8. Taking the record of output power at antenna port.
9. Repeat step 7 to step 8 for another polarization.
10. The RF fundamental frequency should be excluded against the limit line in the operating frequency band.

The limit line is derived from $43 + 10\log(P)$ dB below the transmitter power P(Watts)

11. For Band 7, 38:

The limit line is derived from $55 + 10\log(P)$ dB below the transmitter power P(Watts)

$EIRP \text{ (dBm)} = S.G. \text{ Power} - Tx \text{ Cable Loss} + Tx \text{ Antenna Gain}$

$ERP \text{ (dBm)} = EIRP - 2.15$



5 List of Measuring Equipment

Instrument	Manufacturer	Model No.	Serial No.	Characteristics	Calibration Date	Test Date	Due Date	Remark
Spectrum Analyzer	R&S	FSV40	101040	10Hz~40GHz	Aug. 08, 2017	Mar. 18, 2018~ Mar. 22, 2018	Aug. 07, 2018	Conducted (TH01-KS)
Radio communication analyzer	Anritsu	MT8820C	620130065 2	2G/3G/LTE_ full band	Aug. 08, 2017	Mar. 18, 2018~ Mar. 22, 2018	Aug. 07, 2018	Conducted (TH01-KS)
Thermal Chamber	Hongzhan	LP-150U	HZ014011 440	-40~+150°C 20%~95%RH	Apr. 18, 2017	Mar. 18, 2018~ Mar. 22, 2018	Apr. 17, 2018	Conducted (TH01-KS)
EMI Test Receiver	R&S	ESR7	101403	9kHz~7GHz;Ma x 30dBm	Aug..08.2017	Mar. 22, 2018	Aug.07.2018	Radiation (03CH02-KS)
EXA Spectrum Analyzer	Keysight	N9010A	MY551502 08	10Hz-44G,MAX 30dB	Apr.18, 2017	Mar. 22, 2018	Apr. 17, 2018	Radiation (03CH02-KS)
Bilog Antenna	TeseQ	CBL6112D	35407	30MHz-2GHz	May. 10, 2017	Mar. 22, 2018	May. 09, 2018	Radiation (03CH02-SZ)
Double Ridge Horn Antenna	ETS-Lindgren	3117	75957	1GHz~18GHz	Oct. 21, 2017	Mar. 22, 2018	Oct. 20, 2018	Radiation (03CH02-KS)
Bilog Antenna	TeseQ	CBL6112D	23188	30MHz-2GHz	Apr. 25, 2017	Mar. 22, 2018	Apr. 24, 2018	Radiation (03CH02-KS)
high gain Amplifier	MITEQ	AMF-7D-0010 1800-30-10P	2012228	100MHz-18GHz	Apr.18,2017	Mar. 22, 2018	Apr.17,2018	Radiation (03CH02-KS)
SHF-EHF Horn	Schwarzbeck	BBHA 9170	BBHA1702 49	15GHz~40GHz	Feb. 07, 2018	Mar. 22, 2018	Oct.06, 2019	Radiation (03CH02-KS)
Amplifier	SONOMA	310N	187289	9KHz-1GHz	Aug.07,2017	Mar. 22, 2018	Aug.06,2018	Radiation (03CH02-KS)
Amplifier	Agilent	8449B	3008A023 84	1-26.5GHz Gain 30dB	Oct. 12, 2017	Mar. 22, 2018	Oct. 11, 2018	Radiation (03CH02-KS)
Amplifier	MITEQ	TTA1840-35- HG	1887435	18~40GHz	Oct. 12, 2017	Mar. 22, 2018	Oct. 11, 2018	Radiation (03CH02-KS)
AC Power Source	Chroma	61601	616010002 473	N/A	NCR	Mar. 22, 2018	NCR	Radiation (03CH02-KS)
Turn Table	MF	MF7802	N/A	0~360 degree	NCR	Mar. 22, 2018	NCR	Radiation (03CH02-KS)
Antenna Mast	MF	MF7802	N/A	1 m~4 m	NCR	Mar. 22, 2018	NCR	Radiation (03CH02-KS)

NCR: No Calibration Required



6 Uncertainty of Evaluation

Uncertainty of Radiated Emission Measurement (30 MHz ~ 1000 MHz)

Measuring Uncertainty for a Level of Confidence of 95% ($U = 2Uc(y)$)	2.8 dB
---	--------

Uncertainty of Radiated Emission Measurement (1 GHz ~ 40 GHz)

Measuring Uncertainty for a Level of Confidence of 95% ($U = 2Uc(y)$)	3.3 dB
---	--------



Appendix A. Test Results of Conducted Test

LTE Band 4 Maximum Average Power [dBm]						
BW [MHz]	RB Size	RB Offset	Mod	Lowest	Middle	Highest
20	1	0	QPSK	22.74	22.53	22.69
20	1	49		23.32	22.72	22.71
20	1	99		22.63	22.40	22.57
20	50	0		21.98	21.70	21.77
20	50	24		21.95	21.65	21.54
20	50	50		21.71	21.58	21.58
20	100	0		21.94	21.61	21.62
20	1	0	16-QAM	21.83	21.69	21.71
20	1	49		21.70	21.47	21.34
20	1	99		21.37	21.26	21.36
20	50	0		20.98	20.70	20.72
20	50	24		20.91	20.59	20.60
20	50	50		20.74	20.57	20.52
20	100	0		20.86	20.55	20.61
15	1	0	QPSK	23.06	22.72	22.44
15	1	37		23.14	22.82	22.72
15	1	74		22.70	22.49	22.51
15	36	0		21.99	21.70	21.53
15	36	20		22.04	21.68	21.48
15	36	39		21.75	21.61	21.61
15	75	0		21.87	21.67	21.49
15	1	0	16-QAM	21.88	21.56	21.49
15	1	37		21.69	21.35	21.29
15	1	74		21.56	21.25	21.31
15	36	0		20.99	20.66	20.57
15	36	20		20.90	20.57	20.51
15	36	39		20.75	20.56	20.56
15	75	0		20.87	20.81	20.63



LTE Band 4 Maximum Average Power [dBm]						
BW [MHz]	RB Size	RB Offset	Mod	Lowest	Middle	Highest
10	1	0	QPSK	22.92	22.48	22.28
10	1	25		23.27	22.53	22.58
10	1	49		22.77	22.27	22.43
10	25	0		22.04	21.69	21.45
10	25	12		21.93	21.60	21.59
10	25	25		21.97	21.59	21.57
10	50	0		22.07	21.64	21.60
10	1	0	16-QAM	21.90	21.47	21.35
10	1	25		21.74	21.47	21.40
10	1	49		21.61	21.33	21.35
10	25	0		21.05	20.69	20.49
10	25	12		20.95	20.62	20.62
10	25	25		20.89	20.59	20.72
10	50	0		20.98	20.68	20.65
5	1	0	QPSK	22.83	22.40	22.30
5	1	12		23.25	22.53	22.50
5	1	24		22.94	22.43	22.39
5	12	0		22.10	21.65	21.53
5	12	7		22.02	21.69	21.59
5	12	13		21.98	21.68	21.52
5	25	0		22.06	21.67	21.56
5	1	0	16-QAM	21.81	21.41	21.66
5	1	12		21.69	21.39	21.91
5	1	24		21.64	21.34	21.33
5	12	0		20.97	20.65	20.36
5	12	7		21.04	20.76	20.55
5	12	13		21.09	20.84	20.57
5	25	0		21.06	20.61	20.53



LTE Band 4 Maximum Average Power [dBm]						
BW [MHz]	RB Size	RB Offset	Mod	Lowest	Middle	Highest
3	1	0	QPSK	23.21	22.62	22.49
3	1	8		23.23	22.62	22.71
3	1	14		22.88	22.67	22.31
3	8	0		22.10	21.68	21.39
3	8	4		22.01	21.65	21.47
3	8	7		21.94	21.68	21.50
3	15	0		22.13	21.68	21.49
3	1	0	16-QAM	21.94	21.47	21.20
3	1	8		21.65	21.38	21.06
3	1	14		21.81	21.46	21.18
3	8	0		21.10	20.67	20.47
3	8	4		21.27	20.77	20.56
3	8	7		21.05	20.69	20.57
3	15	0		21.15	20.64	20.55
1.4	1	0	QPSK	22.75	22.61	22.40
1.4	1	3		23.09	22.70	22.46
1.4	1	5		23.08	22.53	22.39
1.4	3	0		23.10	22.65	22.52
1.4	3	1		23.10	22.66	22.70
1.4	3	3		23.05	22.63	22.44
1.4	6	0		22.11	21.67	21.51
1.4	1	0	16-QAM	22.19	21.52	21.32
1.4	1	3		22.26	21.42	21.23
1.4	1	5		21.72	21.29	21.34
1.4	3	0		21.95	21.89	21.50
1.4	3	1		22.30	21.82	21.55
1.4	3	3		22.32	21.89	21.54
1.4	6	0		21.02	20.70	20.54



LTE Band 5 Maximum Average Power [dBm]						
BW [MHz]	RB Size	RB Offset	Mod	Lowest	Middle	Highest
10	1	0	QPSK	22.78	22.86	22.97
10	1	25		22.95	22.95	23.24
10	1	49		22.90	22.89	22.45
10	25	0		22.50	22.60	22.74
10	25	12		22.57	22.63	22.75
10	25	25		22.64	22.67	22.93
10	50	0		22.59	22.63	22.75
10	1	0	16-QAM	22.07	22.90	22.49
10	1	25		22.39	22.82	22.69
10	1	49		22.33	22.55	21.85
10	25	0		21.31	21.48	21.64
10	25	12		21.42	21.60	21.75
10	25	25		21.48	21.62	21.98
10	50	0		21.43	21.29	21.74
5	1	0	QPSK	22.50	22.61	23.23
5	1	12		23.09	22.95	23.16
5	1	24		22.74	22.76	22.42
5	12	0		22.43	22.53	22.93
5	12	7		22.41	22.56	22.92
5	12	13		22.38	22.58	22.93
5	25	0		22.41	22.55	22.84
5	1	0	16-QAM	22.24	22.34	22.67
5	1	12		22.26	22.28	22.59
5	1	24		22.13	22.33	21.77
5	12	0		21.34	21.49	21.95
5	12	7		21.34	21.33	21.90
5	12	13		21.17	21.46	21.94
5	25	0		21.38	21.44	21.85



LTE Band 5 Maximum Average Power [dBm]						
BW [MHz]	RB Size	RB Offset	Mod	Lowest	Middle	Highest
3	1	0	QPSK	22.84	22.99	23.18
3	1	8		22.81	23.18	23.20
3	1	14		22.86	22.77	22.84
3	8	0		22.47	22.51	22.88
3	8	4		22.43	22.60	22.94
3	8	7		22.38	22.56	22.99
3	15	0		22.50	22.58	22.98
3	1	0	16-QAM	22.37	22.37	22.73
3	1	8		22.59	22.09	22.71
3	1	14		22.38	22.50	22.18
3	8	0		21.40	21.23	21.97
3	8	4		21.37	21.47	21.90
3	8	7		21.39	21.47	21.89
3	15	0		21.51	21.16	21.73
1.4	1	0	QPSK	22.96	22.92	22.95
1.4	1	3		22.85	22.97	23.21
1.4	1	5		22.79	22.95	23.17
1.4	3	0		22.93	22.99	23.17
1.4	3	1		22.89	23.11	23.16
1.4	3	3		22.83	23.00	23.10
1.4	6	0		22.26	22.47	22.99
1.4	1	0	16-QAM	22.25	22.64	22.64
1.4	1	3		22.57	22.76	22.69
1.4	1	5		22.17	22.60	22.45
1.4	3	0		22.31	22.39	22.53
1.4	3	1		22.33	22.54	22.52
1.4	3	3		22.27	22.38	22.47
1.4	6	0		21.24	21.18	21.95



LTE Band 7 Maximum Average Power [dBm]						
BW [MHz]	RB Size	RB Offset	Mod	Lowest	Middle	Highest
20	1	0	QPSK	21.88	22.37	22.25
20	1	49		22.26	22.63	22.85
20	1	99		21.91	22.27	22.71
20	50	0		21.29	21.56	21.65
20	50	24		21.37	21.43	21.66
20	50	50		21.36	21.59	21.59
20	100	0		21.35	21.55	21.62
20	1	0	16-QAM	21.01	21.28	21.40
20	1	49		21.17	21.26	21.37
20	1	99		20.94	21.34	21.36
20	50	0		20.26	20.53	20.72
20	50	24		20.33	20.50	20.61
20	50	50		20.33	20.49	20.64
20	100	0		20.33	20.55	20.58
15	1	0	QPSK	22.01	22.40	22.36
15	1	37		22.29	22.56	22.84
15	1	74		22.27	22.44	22.43
15	36	0		21.35	21.61	21.49
15	36	20		21.45	21.48	21.68
15	36	39		21.43	21.62	21.69
15	75	0		21.43	21.62	21.68
15	1	0	16-QAM	21.21	21.42	21.38
15	1	37		21.16	21.31	21.41
15	1	74		21.07	21.49	21.43
15	36	0		20.23	20.49	20.45
15	36	20		20.31	20.45	20.65
15	36	39		20.32	20.43	20.67
15	75	0		20.37	20.52	20.70



LTE Band 7 Maximum Average Power [dBm]						
BW [MHz]	RB Size	RB Offset	Mod	Lowest	Middle	Highest
10	1	0	QPSK	22.04	22.47	22.33
10	1	25		22.34	22.83	22.60
10	1	49		22.03	22.66	22.34
10	25	0		21.36	21.50	21.69
10	25	12		21.34	21.52	21.68
10	25	25		21.46	21.53	21.65
10	50	0		21.41	21.60	21.64
10	1	0	16-QAM	21.14	21.41	21.44
10	1	25		21.12	21.30	21.44
10	1	49		21.22	21.48	21.44
10	25	0		20.39	20.78	20.67
10	25	12		20.42	20.81	20.75
10	25	25		20.40	20.81	20.65
10	50	0		20.21	20.56	20.51
5	1	0	QPSK	21.89	22.18	22.38
5	1	12		22.31	22.62	22.42
5	1	24		21.99	22.32	22.32
5	12	0		21.32	21.59	21.61
5	12	7		21.33	21.48	21.67
5	12	13		21.34	21.55	21.57
5	25	0		21.26	21.54	21.57
5	1	0	16-QAM	21.04	21.35	21.64
5	1	12		21.10	21.25	21.41
5	1	24		21.01	21.31	21.40
5	12	0		20.00	20.50	20.40
5	12	7		20.27	20.64	20.46
5	12	13		20.25	20.60	20.41
5	25	0		20.37	20.74	20.40



LTE Band 38 Maximum Average Power [dBm]						
BW [MHz]	RB Size	RB Offset	Mod	Lowest	Middle	Highest
20	1	0	QPSK	22.42	22.09	21.98
20	1	49		22.32	22.05	21.89
20	1	99		22.30	21.86	21.62
20	50	0		21.49	21.31	21.07
20	50	24		21.39	21.25	20.95
20	50	50		21.42	21.13	20.85
20	100	0		21.42	21.17	20.95
20	1	0	16-QAM	20.99	20.85	20.96
20	1	49		21.49	21.03	20.74
20	1	99		21.36	20.50	20.56
20	50	0		20.48	20.15	19.90
20	50	24		20.48	20.11	19.86
20	50	50		20.50	19.99	19.82
20	100	0		20.32	20.15	19.94
15	1	0	QPSK	22.21	22.25	22.00
15	1	37		22.32	22.35	21.94
15	1	74		22.25	22.05	21.60
15	36	0		21.45	21.24	21.01
15	36	20		21.46	21.18	20.88
15	36	39		21.39	21.15	20.86
15	75	0		21.39	21.21	20.92
15	1	0	16-QAM	21.11	21.20	20.63
15	1	37		21.49	21.13	20.78
15	1	74		21.39	20.89	20.50
15	36	0		20.41	20.13	20.02
15	36	20		20.49	20.09	20.00
15	36	39		20.44	20.08	19.92
15	75	0		20.45	20.17	19.91



LTE Band 38 Maximum Average Power [dBm]						
BW [MHz]	RB Size	RB Offset	Mod	Lowest	Middle	Highest
10	1	0	QPSK	22.26	22.16	21.93
10	1	25		22.32	22.06	21.89
10	1	49		22.41	21.99	21.73
10	25	0		21.40	21.23	20.86
10	25	12		21.40	21.23	20.87
10	25	25		21.45	21.20	20.88
10	50	0		21.44	21.22	20.95
10	1	0	16-QAM	21.23	21.04	20.82
10	1	25		21.42	20.82	20.69
10	1	49		20.94	20.89	20.58
10	25	0		20.48	20.15	19.82
10	25	12		20.47	20.11	19.85
10	25	25		20.41	20.22	20.01
10	50	0		20.50	20.34	19.95
5	1	0	QPSK	22.07	21.96	21.70
5	1	12		22.26	22.24	21.99
5	1	24		22.02	21.79	21.57
5	12	0		21.39	21.21	20.92
5	12	7		21.43	21.20	20.87
5	12	13		21.34	21.23	20.84
5	25	0		21.40	21.23	20.80
5	1	0	16-QAM	20.85	21.13	20.61
5	1	12		21.33	21.18	20.86
5	1	24		21.21	20.70	20.60
5	12	0		20.41	20.06	19.83
5	12	7		20.44	20.10	19.82
5	12	13		20.24	20.10	19.74
5	25	0		20.42	20.04	20.02



ERP/EIRP

LTE Band 4 (G _T - L _C = 2.67 dB) QPSK									
Bandwidth	1.4M			3M			5M		
Channel	19957	20175	20393	19965	20175	20385	19975	20175	20375
	(Low)	(Mid)	(High)	(Low)	(Mid)	(High)	(Low)	(Mid)	(High)
Frequency	1710.7	1732.5	1754.3	1711.5	1732.5	1753.5	1712.5	1732.5	1752.5
(MHz)									
Conducted Power (dBm)	23.10	22.66	22.70	23.23	22.62	22.71	23.25	22.53	22.50
Conducted Power (Watts)	0.2042	0.1845	0.1862	0.2104	0.1828	0.1866	0.2113	0.1791	0.1778
EIRP(dBm)	25.77	25.33	25.37	25.90	25.29	25.38	25.92	25.20	25.17
EIRP(Watts)	0.3776	0.3412	0.3443	0.3890	0.3381	0.3451	0.3908	0.3311	0.3289

LTE Band 4 (G _T - L _C = 2.67 dB) QPSK									
Bandwidth	10M			15M			20M		
Channel	20000	20175	20350	20025	20175	20325	20050	20175	20300
	(Low)	(Mid)	(High)	(Low)	(Mid)	(High)	(Low)	(Mid)	(High)
Frequency	1715	1732.5	1750	1717.5	1732.5	1747.5	1720	1732.5	1745
(MHz)									
Conducted Power (dBm)	23.27	22.53	22.58	23.14	22.82	22.72	23.32	22.72	22.71
Conducted Power (Watts)	0.2123	0.1791	0.1811	0.2061	0.1914	0.1871	0.2148	0.1871	0.1866
EIRP(dBm)	25.94	25.20	25.25	25.81	25.49	25.39	25.99	25.39	25.38
EIRP(Watts)	0.3926	0.3311	0.3350	0.3811	0.3540	0.3459	0.3972	0.3459	0.3451



LTE Band 4 ($G_T - L_C = 2.67$ dB) 16QAM									
Bandwidth	1.4M			3M			5M		
Channel	19957	20175	20393	19965	20175	20385	19975	20175	20375
	(Low)	(Mid)	(High)	(Low)	(Mid)	(High)	(Low)	(Mid)	(High)
Frequency (MHz)	1710.7	1732.5	1754.3	1711.5	1732.5	1753.5	1712.5	1732.5	1752.5
Conducted Power (dBm)	22.32	21.89	21.54	21.94	21.47	21.20	21.69	21.39	21.91
Conducted Power (Watts)	0.1706	0.1545	0.1426	0.1563	0.1403	0.1318	0.1476	0.1377	0.1552
EIRP(dBm)	24.99	24.56	24.21	24.61	24.14	23.87	24.36	24.06	24.58
EIRP(Watts)	0.3155	0.2858	0.2636	0.2891	0.2594	0.2438	0.2729	0.2547	0.2871

LTE Band 4 ($G_T - L_C = 2.67$ dB) 16QAM									
Bandwidth	10M			15M			20M		
Channel	20000	20175	20350	20025	20175	20325	20050	20175	20300
	(Low)	(Mid)	(High)	(Low)	(Mid)	(High)	(Low)	(Mid)	(High)
Frequency (MHz)	1715	1732.5	1750	1717.5	1732.5	1747.5	1720	1732.5	1745
Conducted Power (dBm)	21.90	21.47	21.35	21.88	21.56	21.49	21.83	21.69	21.71
Conducted Power (Watts)	0.1549	0.1403	0.1365	0.1542	0.1432	0.1409	0.1524	0.1476	0.1483
EIRP(dBm)	24.57	24.14	24.02	24.55	24.23	24.16	24.50	24.36	24.38
EIRP(Watts)	0.2864	0.2594	0.2523	0.2851	0.2649	0.2606	0.2818	0.2729	0.2742



LTE Band 5 (G _T - L _C = -1.16 dB) QPSK									
Bandwidth	1.4M			3M			5M		
Channel	20407	20525	20643	20415	20525	20635	20425	20525	20625
	(Low)	(Mid)	(High)	(Low)	(Mid)	(High)	(Low)	(Mid)	(High)
Frequency (MHz)	824.7	836.5	848.3	825.5	836.5	847.5	826.5	836.5	846.5
Conducted Power (dBm)	22.85	22.97	23.21	22.81	23.18	23.20	22.50	22.61	23.23
Conducted Power (Watts)	0.1928	0.1982	0.2094	0.1910	0.2080	0.2089	0.1778	0.1824	0.2104
ERP(dBm)	19.54	19.66	19.90	19.50	19.87	19.89	19.19	19.30	19.92
ERP(Watts)	0.0899	0.0925	0.0977	0.0891	0.0971	0.0975	0.0830	0.0851	0.0982

LTE Band 5 (G _T - L _C = -1.16 dB) QPSK			
Bandwidth	10M		
Channel	20450	20525	20600
	(Low)	(Mid)	(High)
Frequency (MHz)	829	836.5	844
Conducted Power (dBm)	22.95	22.95	23.24
Conducted Power (Watts)	0.1972	0.1972	0.2109
ERP(dBm)	19.64	19.64	19.93
ERP(Watts)	0.0920	0.0920	0.0984



LTE Band 5 ($G_T - L_C = -1.16$ dB) 16QAM									
Bandwidth	1.4M			3M			5M		
Channel	20407	20525	20643	20415	20525	20635	20425	20525	20625
	(Low)	(Mid)	(High)	(Low)	(Mid)	(High)	(Low)	(Mid)	(High)
Frequency (MHz)	824.7	836.5	848.3	825.5	836.5	847.5	826.5	836.5	846.5
Conducted Power (dBm)	22.57	22.76	22.69	22.37	22.37	22.73	22.24	22.34	22.67
Conducted Power (Watts)	0.1807	0.1888	0.1858	0.1726	0.1726	0.1875	0.1675	0.1714	0.1849
ERP(dBm)	19.26	19.45	19.38	19.06	19.06	19.42	18.93	19.03	19.36
ERP(Watts)	0.0843	0.0881	0.0867	0.0805	0.0805	0.0875	0.0782	0.0800	0.0863

LTE Band 5 ($G_T - L_C = -1.16$ dB) 16QAM			
Bandwidth	10M		
Channel	20450	20525	20600
	(Low)	(Mid)	(High)
Frequency (MHz)	829	836.5	844
Conducted Power (dBm)	22.07	22.90	22.49
Conducted Power (Watts)	0.1611	0.1950	0.1774
ERP(dBm)	18.76	19.59	19.18
ERP(Watts)	0.0752	0.0910	0.0828



LTE Band 7 ($G_T - L_C = 2.45$ dB) QPSK			
Bandwidth	5M		
Channel	20775	21100	21425
	(Low)	(Mid)	(High)
Frequency	2502.5	2535	2567.5
(MHz)			
Conducted Power (dBm)	22.31	22.62	22.42
Conducted Power (Watts)	0.1702	0.1828	0.1746
EIRP(dBm)	24.76	25.07	24.87
EIRP(Watts)	0.2992	0.3214	0.3069

LTE Band 7 ($G_T - L_C = 2.45$ dB) QPSK									
Bandwidth	10M			15M			20M		
Channel	20800	21100	21400	20825	21100	21375	20850	21100	21350
	(Low)	(Mid)	(High)	(Low)	(Mid)	(High)	(Low)	(Mid)	(High)
Frequency	2505	2535	2565	2507.5	2535	2562.5	2510	2535	2560
(MHz)									
Conducted Power (dBm)	22.34	22.83	22.60	22.29	22.56	22.84	22.26	22.63	22.85
Conducted Power (Watts)	0.1714	0.1919	0.1820	0.1694	0.1803	0.1923	0.1683	0.1832	0.1928
EIRP(dBm)	24.79	25.28	25.05	24.74	25.01	25.29	24.71	25.08	25.30
EIRP(Watts)	0.3013	0.3373	0.3199	0.2979	0.3170	0.3381	0.2958	0.3221	0.3388



LTE Band 7 ($G_T - L_C = 2.45$ dB) 16QAM			
Bandwidth	5M		
Channel	20775	21100	21425
	(Low)	(Mid)	(High)
Frequency (MHz)	2502.5	2535	2567.5
	Conducted Power (dBm)	21.04	21.35
Conducted Power (Watts)	0.1271	0.1365	0.1459
EIRP(dBm)	23.49	23.80	24.09
EIRP(Watts)	0.2234	0.2399	0.2564

LTE Band 7 ($G_T - L_C = 2.45$ dB) 16QAM									
Bandwidth	10M			15M			20M		
Channel	20800	21100	21400	20825	21100	21375	20850	21100	21350
	(Low)	(Mid)	(High)	(Low)	(Mid)	(High)	(Low)	(Mid)	(High)
Frequency (MHz)	2505	2535	2565	2507.5	2535	2562.5	2510	2535	2560
	Conducted Power (dBm)	21.22	21.48	21.44	21.07	21.49	21.43	21.01	21.28
Conducted Power (Watts)	0.1324	0.1406	0.1393	0.1279	0.1409	0.1390	0.1262	0.1343	0.1380
EIRP(dBm)	23.67	23.93	23.89	23.52	23.94	23.88	23.46	23.73	23.85
EIRP(Watts)	0.2328	0.2472	0.2449	0.2249	0.2477	0.2443	0.2218	0.2360	0.2427



LTE Band 38 (G _T - L _C = 2.45 dB) QPSK			
Bandwidth	5M		
Channel	37775	38000	38225
	(Low)	(Mid)	(High)
Frequency	2572.5	2595	2617.5
(MHz)			
Conducted Power (dBm)	22.26	22.24	21.99
Conducted Power (Watts)	0.1683	0.1675	0.1581
EIRP(dBm)	24.71	24.69	24.44
EIRP(Watts)	0.2958	0.2944	0.2780

LTE Band 38 (G _T - L _C = 2.45 dB) QPSK									
Bandwidth	10M			15M			20M		
Channel	37800	38000	38200	37825	38000	38175	37850	38000	38150
	(Low)	(Mid)	(High)	(Low)	(Mid)	(High)	(Low)	(Mid)	(Mid)
Frequency	2575	2595	2615	2577.5	2595	2612.5	2580	2595	2610
(MHz)									
Conducted Power (dBm)	22.41	21.99	21.73	22.32	22.35	21.94	22.42	22.09	21.98
Conducted Power (Watts)	0.1742	0.1581	0.1489	0.1706	0.1718	0.1563	0.1746	0.1618	0.1578
EIRP(dBm)	24.86	24.44	24.18	24.77	24.80	24.39	24.87	24.54	24.43
EIRP(Watts)	0.3062	0.2780	0.2618	0.2999	0.3020	0.2748	0.3069	0.2844	0.2773



LTE Band 38 (G _T - L _C = 2.45 dB) 16QAM			
Bandwidth	5M		
Channel	37775	38000	38225
	(Low)	(Mid)	(High)
Frequency	2572.5	2595	2617.5
(MHz)			
Conducted Power (dBm)	21.33	21.18	20.86
Conducted Power (Watts)	0.1358	0.1312	0.1219
EIRP(dBm)	23.78	23.63	23.31
EIRP(Watts)	0.2388	0.2307	0.2143

LTE Band 38 (G _T - L _C = 2.45 dB) 16QAM									
Bandwidth	10M			15M			20M		
Channel	37800	38000	38200	37825	38000	38175	37850	38000	38150
	(Low)	(Mid)	(High)	(Low)	(Mid)	(High)	(Low)	(Mid)	(Mid)
Frequency	2575	2595	2615	2577.5	2595	2612.5	2580	2595	2610
(MHz)									
Conducted Power (dBm)	21.42	20.82	20.69	21.49	21.13	20.78	21.49	21.03	20.74
Conducted Power (Watts)	0.1387	0.1208	0.1172	0.1409	0.1297	0.1197	0.1409	0.1268	0.1186
EIRP(dBm)	23.87	23.27	23.14	23.94	23.58	23.23	23.94	23.48	23.19
EIRP(Watts)	0.2438	0.2123	0.2061	0.2477	0.2280	0.2104	0.2477	0.2228	0.2084



Peak-to-Average Ratio

Mode	LTE Band 4 / 20MHz				
Mod.	QPSK		16QAM		Limit: 13dB
RB Size	1RB	Full RB	1RB	Full RB	Result
Lowest CH	4.58	4.67	5.65	5.77	PASS
Middle CH	4.26	4.87	5.3	5.83	
Highest CH	4.32	4.78	5.48	5.91	

Mode	LTE Band 5 / 10MHz				
Mod.	QPSK		16QAM		Limit: 13dB
RB Size	1RB	Full RB	1RB	Full RB	Result
Lowest CH	3.16	4.58	3.83	5.54	PASS
Middle CH	3.65	4.55	4.43	5.57	
Highest CH	3.3	4.43	4.23	5.45	

Mode	LTE Band 7 / 20MHz				
Mod.	QPSK		16QAM		Limit: 13dB
RB Size	1RB	Full RB	1RB	Full RB	Result
Lowest CH	4.14	4.61	4.81	5.77	PASS
Middle CH	4.32	4.7	5.16	5.68	
Highest CH	4.29	4.61	5.16	5.65	

Mode	LTE Band 38 / 20MHz				
Mod.	QPSK		16QAM		Limit: 13dB
RB Size	1RB	Full RB	1RB	Full RB	Result
Lowest CH	4.32	5.13	5.54	5.71	PASS
Middle CH	6.9	5.3	5.65	5.94	
Highest CH	6.67	6.58	6.43	5.91	



LTE Band 4 / 20MHz / QPSK

Lowest Channel / 1RB

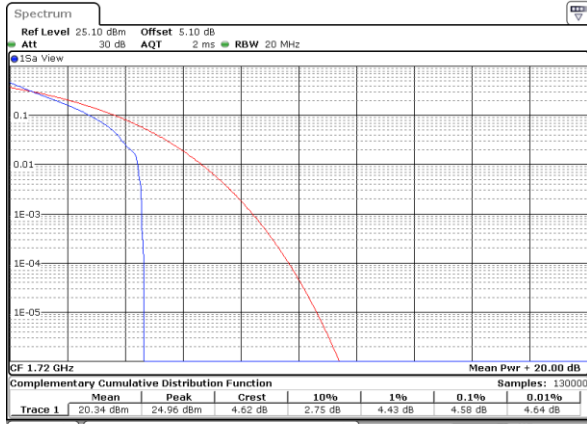

Date: 19 MAR 2018 21:33:41

Lowest Channel / Full RB

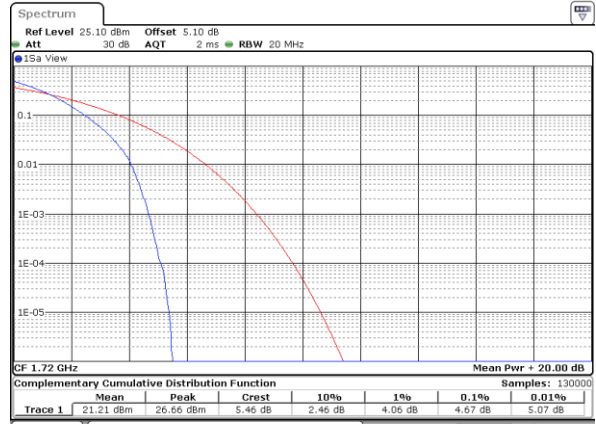

Date: 19 MAR 2018 21:33:29

Middle Channel / 1RB

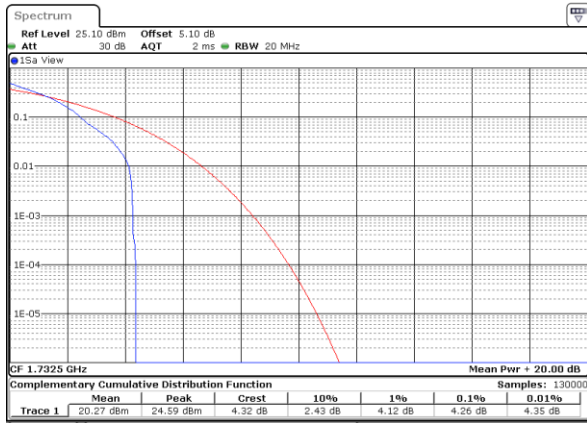

Date: 19 MAR 2018 21:34:00

Middle Channel / Full RB

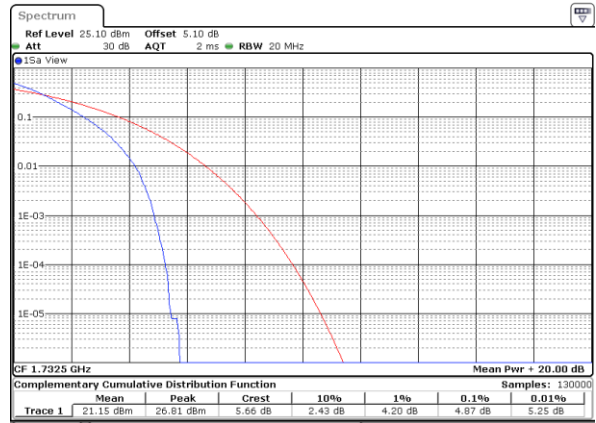

Date: 19 MAR 2018 21:33:17

Highest Channel / 1RB

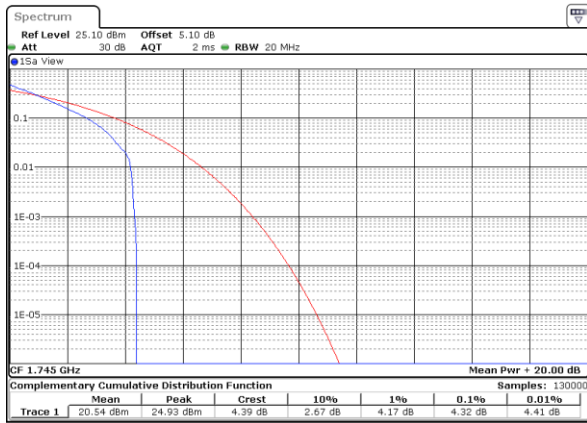

Date: 19 MAR 2018 21:34:13

Highest Channel / Full RB

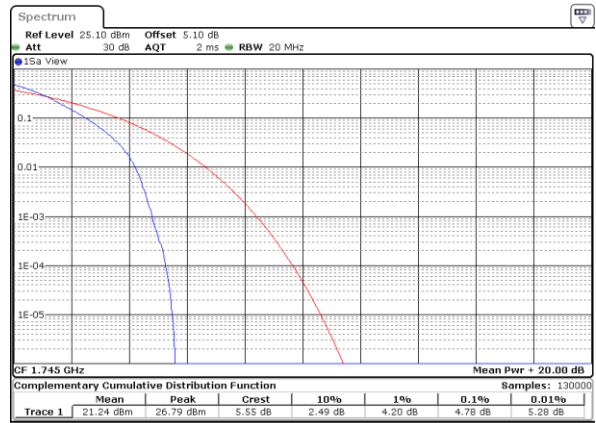

Date: 19 MAR 2018 21:33:06



LTE Band 4 / 20MHz / 16QAM

Lowest Channel / 1RB

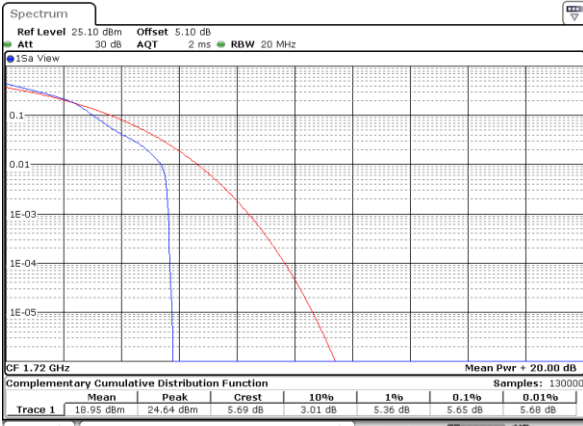

Date: 19 MAR 2018 21:32:03

Lowest Channel / Full RB

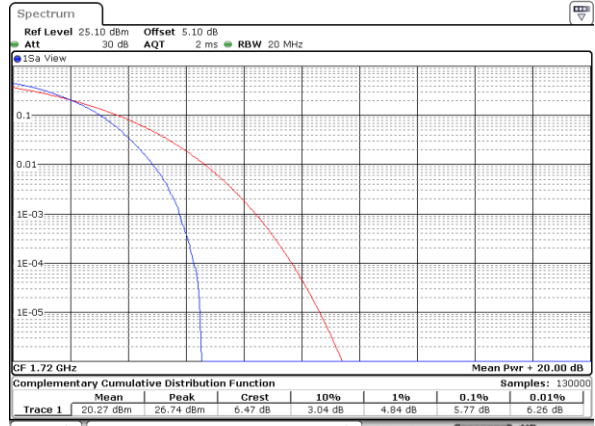

Date: 19 MAR 2018 21:32:12

Middle Channel / 1RB

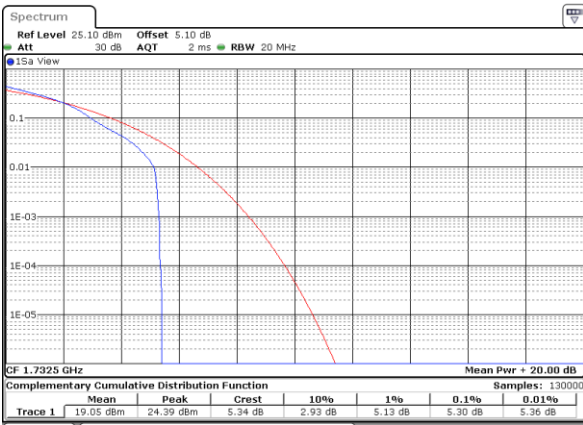

Date: 19 MAR 2018 21:32:21

Middle Channel / Full RB

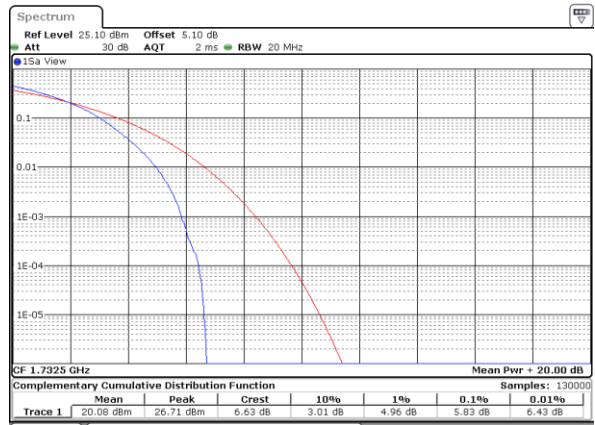

Date: 19 MAR 2018 21:32:31

Highest Channel / 1RB

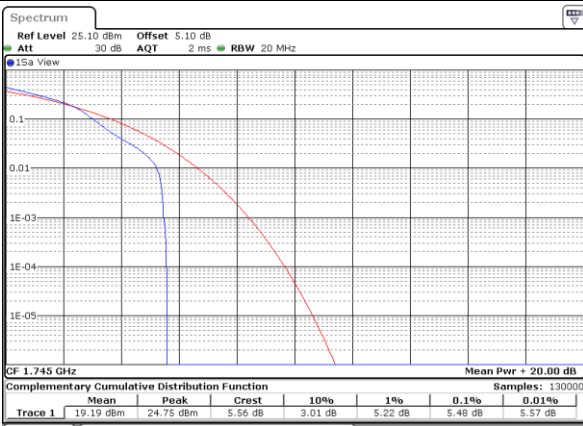

Date: 19 MAR 2018 21:32:40

Highest Channel / Full RB

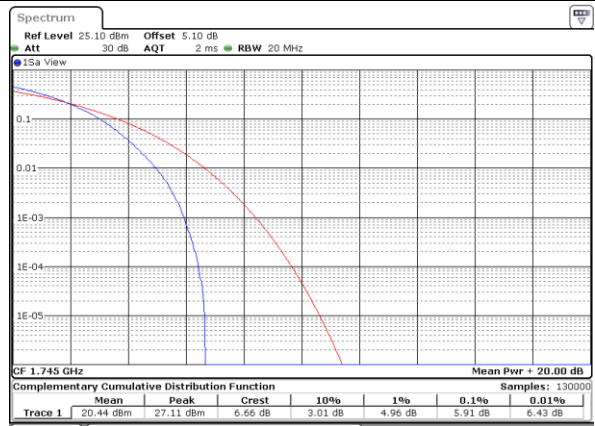

Date: 19 MAR 2018 21:32:49



LTE Band 5 / 10MHz / QPSK

Lowest Channel / 1RB

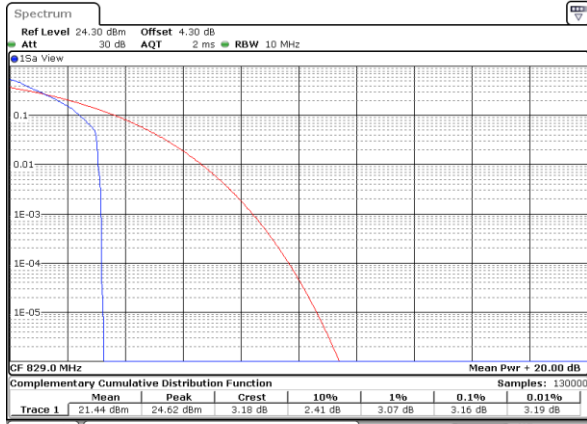

Date: 18 MAR 2018 07:30:12

Lowest Channel / Full RB

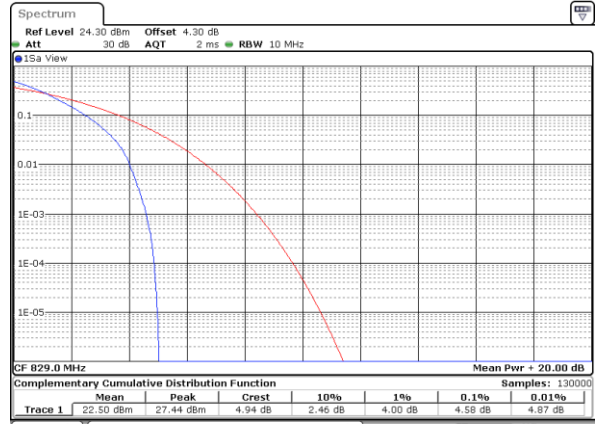

Date: 18 MAR 2018 07:30:25

Middle Channel / 1RB

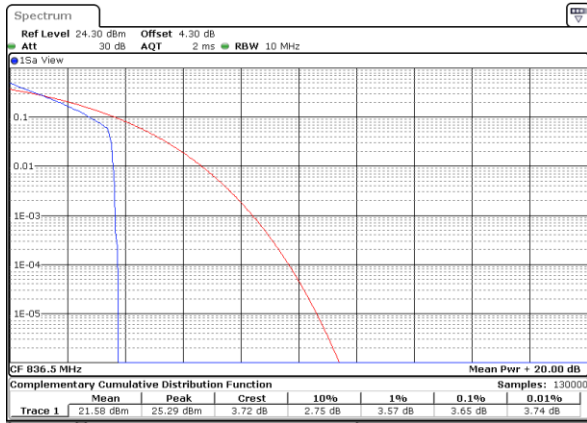

Date: 18 MAR 2018 07:30:50

Middle Channel / Full RB

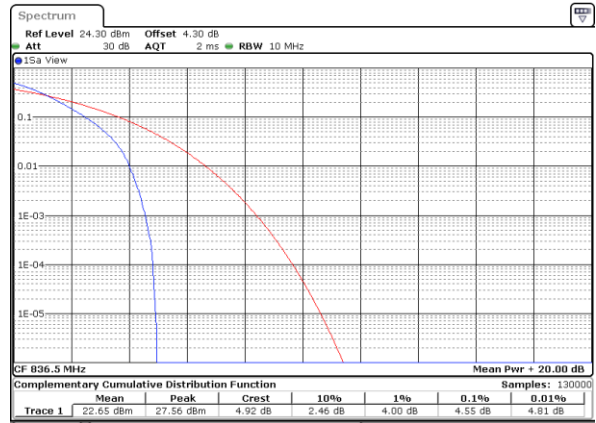

Date: 18 MAR 2018 07:30:38

Highest Channel / 1RB

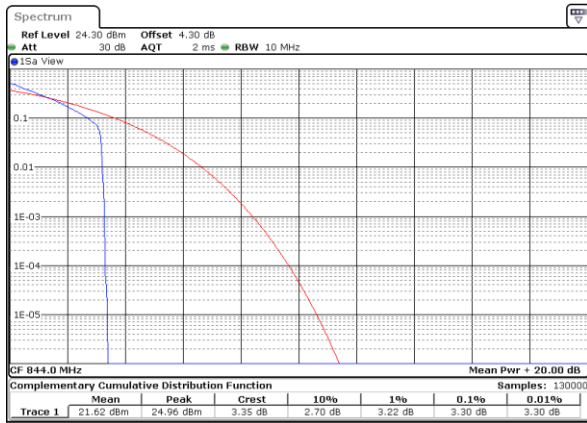

Date: 18 MAR 2018 07:31:03

Highest Channel / Full RB

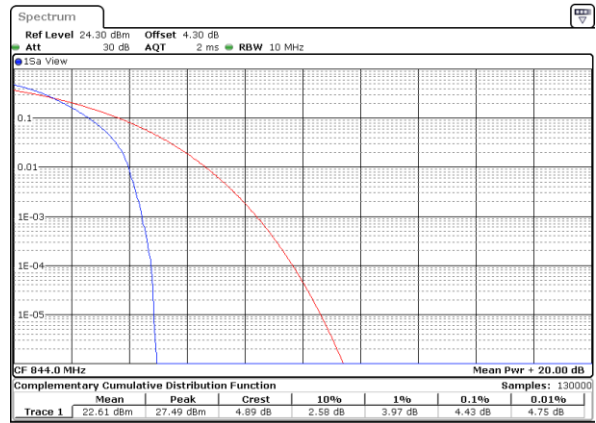

Date: 18 MAR 2018 07:31:16



LTE Band 5 / 10MHz / 16QAM

Lowest Channel / 1RB

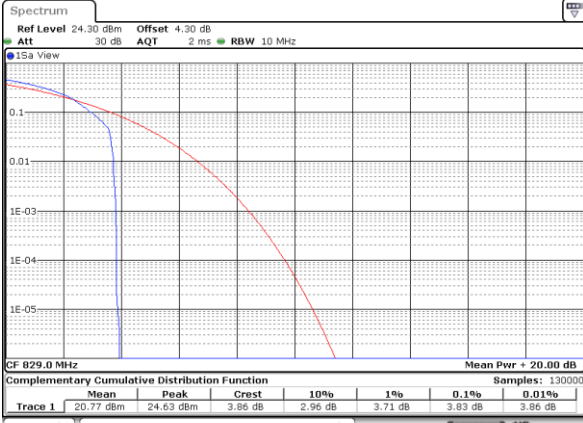

Date: 18 MAR 2018 07:28:54

Lowest Channel / Full RB

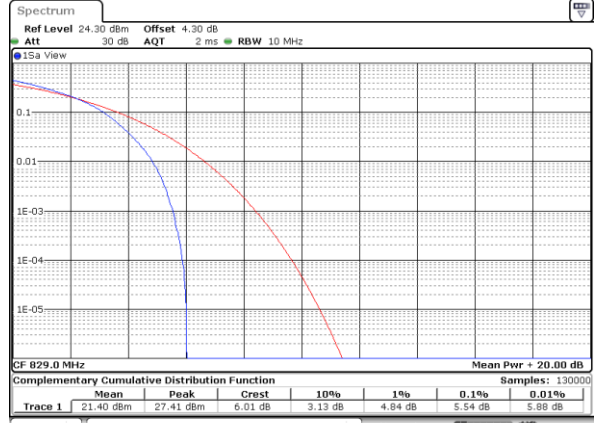

Date: 18 MAR 2018 07:29:04

Middle Channel / 1RB

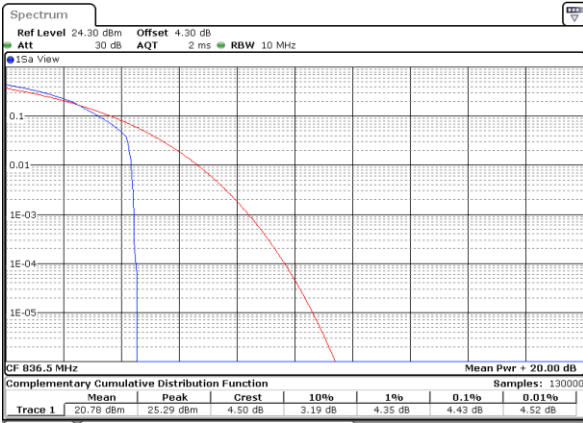

Date: 18 MAR 2018 07:29:14

Middle Channel / Full RB

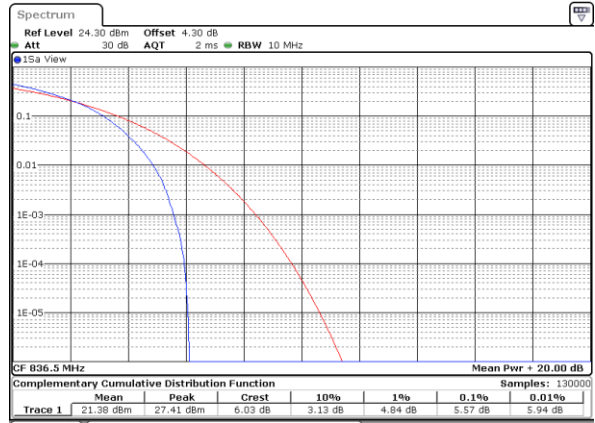

Date: 18 MAR 2018 07:29:24

Highest Channel / 1RB

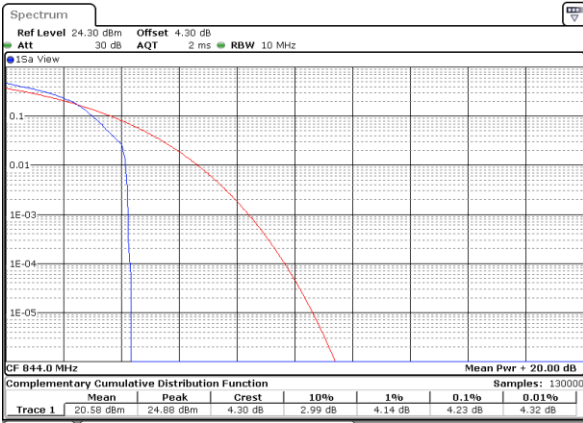

Date: 18 MAR 2018 07:29:35

Highest Channel / Full RB

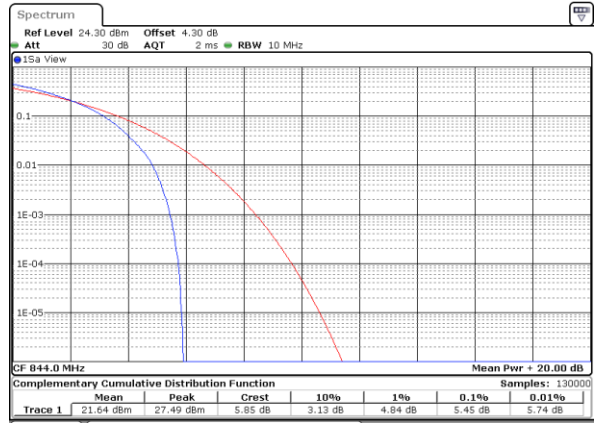

Date: 18 MAR 2018 07:29:45



LTE Band 7 / 20MHz / QPSK

Lowest Channel / 1RB

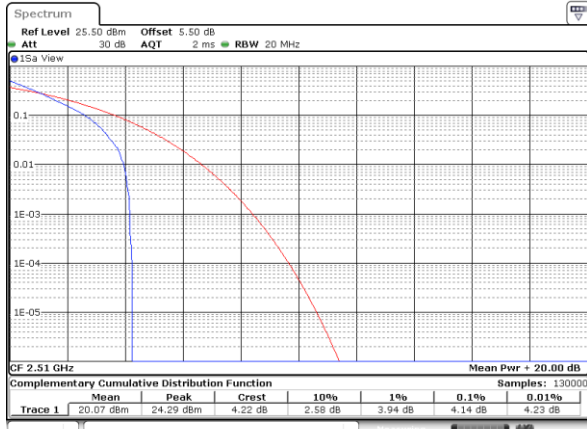

Date: 19 MAR 2018 22:31:53

Lowest Channel / Full RB

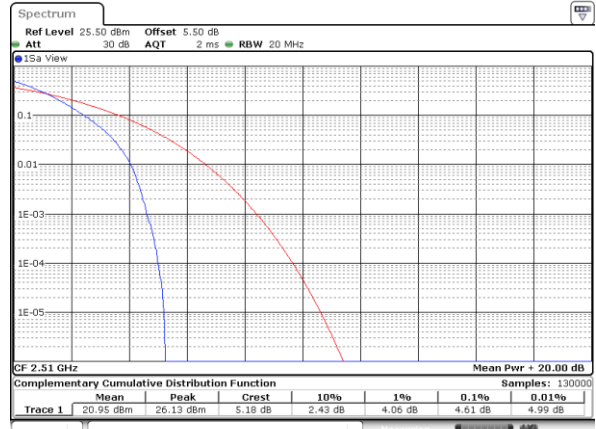

Date: 19 MAR 2018 22:32:04

Middle Channel / 1RB

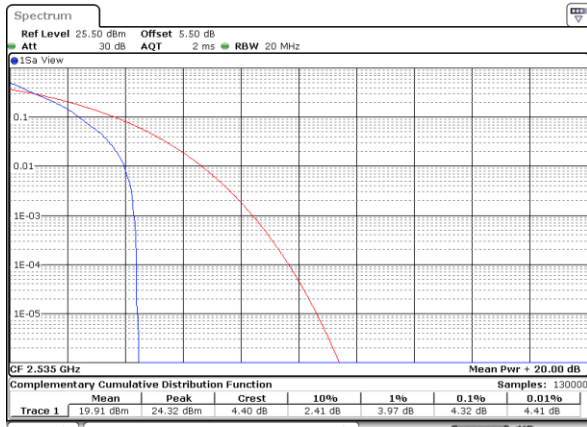

Date: 19 MAR 2018 22:33:04

Middle Channel / Full RB

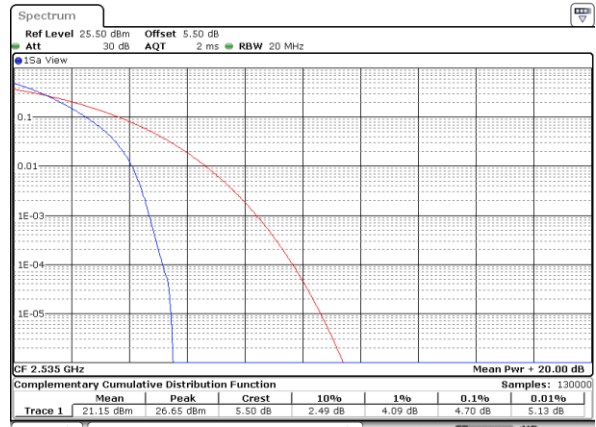

Date: 19 MAR 2018 22:32:55

Highest Channel / 1RB

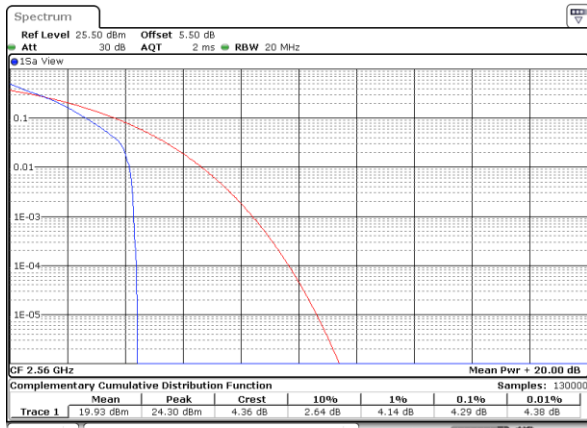

Date: 19 MAR 2018 22:33:36

Highest Channel / Full RB

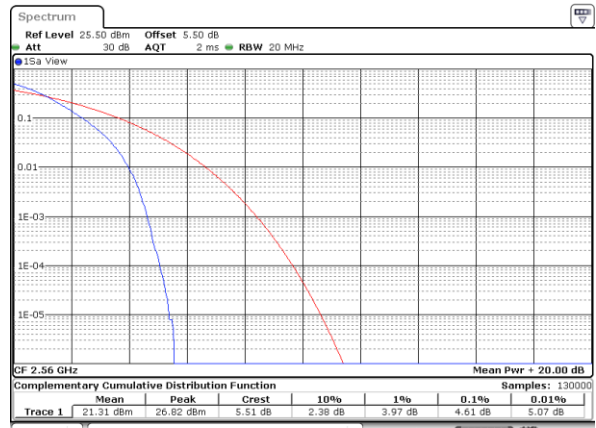

Date: 19 MAR 2018 22:33:46



LTE Band 7 / 20MHz / 16QAM

Lowest Channel / 1RB

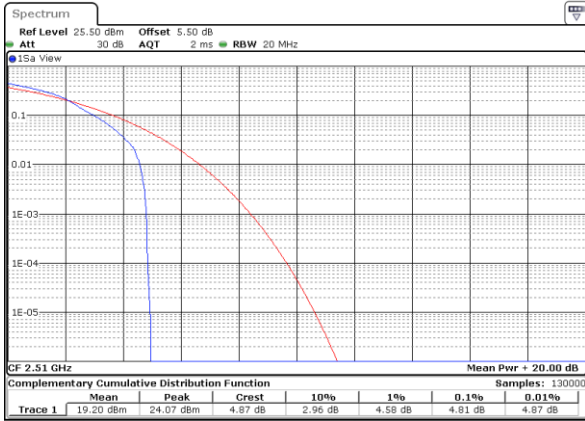

Date: 19 MAR 2018 22:31:43

Lowest Channel / Full RB

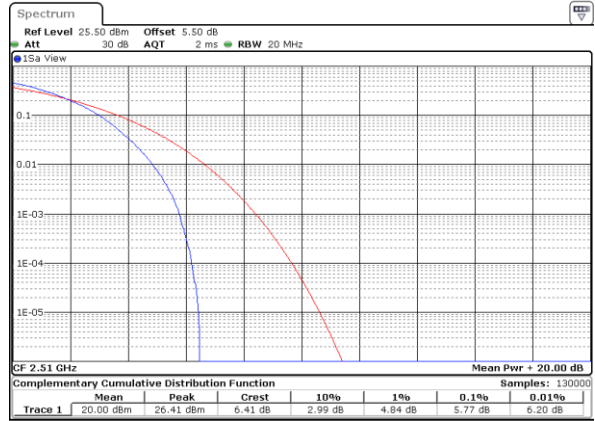

Date: 19 MAR 2018 22:32:13

Middle Channel / 1RB

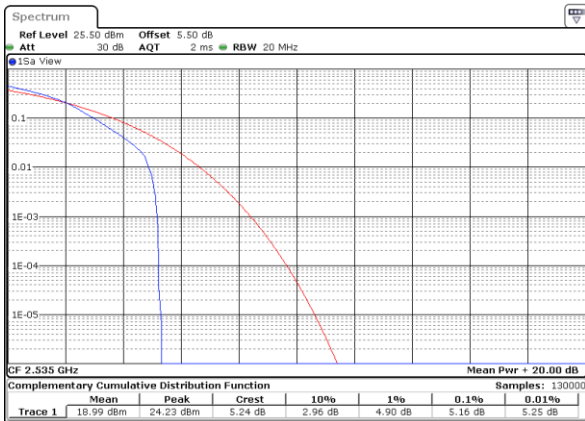

Date: 19 MAR 2018 22:33:13

Middle Channel / Full RB

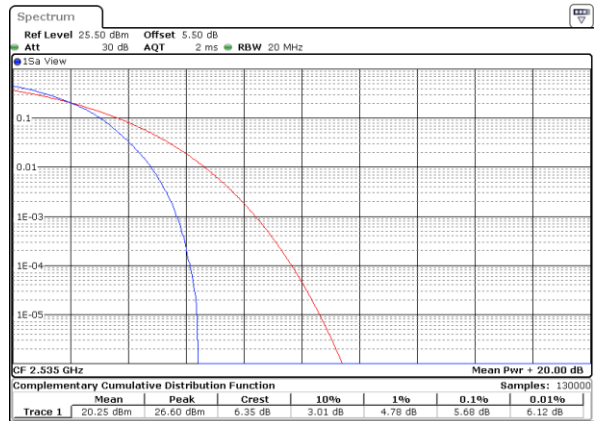

Date: 19 MAR 2018 22:32:28

Highest Channel / 1RB



Date: 19 MAR 2018 22:33:26

Highest Channel / Full RB



Date: 19 MAR 2018 22:33:55



LTE Band 38 / 20MHz / QPSK

Lowest Channel / 1RB

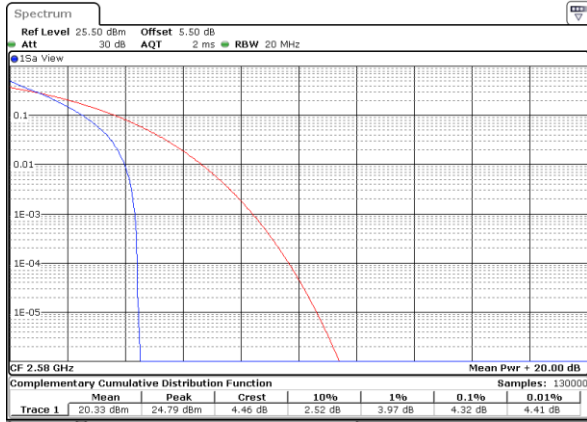

Date: 20 MAR 2018 01:51:58

Lowest Channel / Full RB

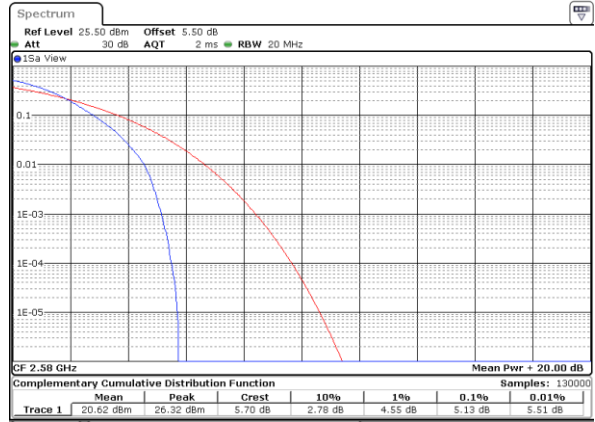

Date: 20 MAR 2018 01:52:08

Middle Channel / 1RB

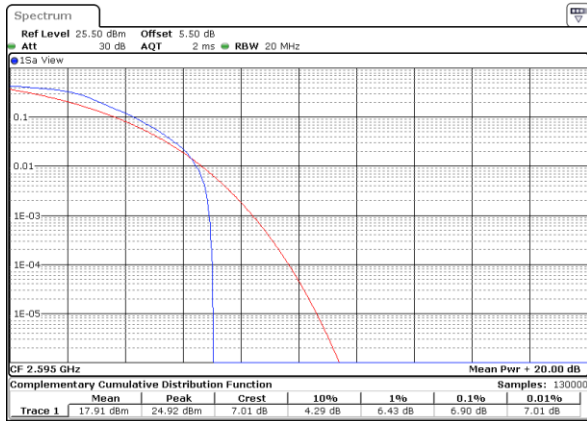

Date: 20 MAR 2018 01:52:20

Middle Channel / Full RB

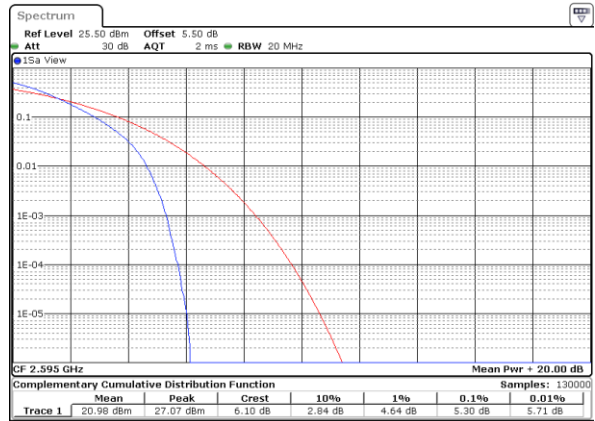

Date: 20 MAR 2018 01:52:38

Highest Channel / 1RB

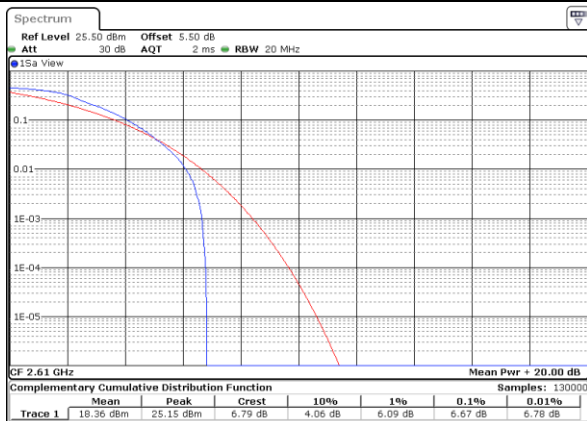

Date: 20 MAR 2018 01:52:48

Highest Channel / Full RB

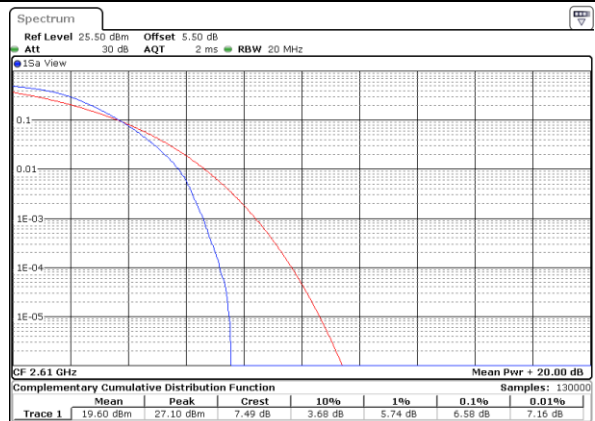

Date: 20 MAR 2018 01:52:57



LTE Band 38 / 20MHz / 16QAM

Lowest Channel / 1RB

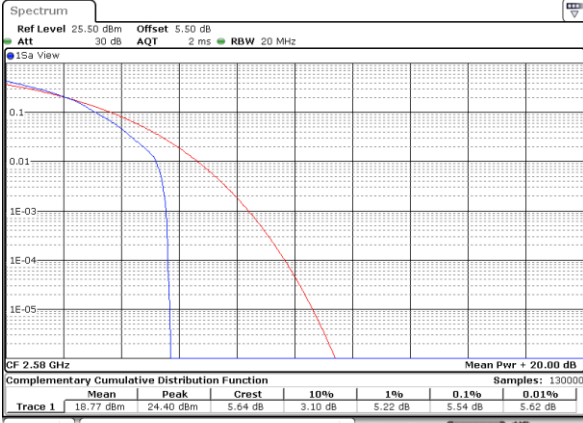

Date: 20 MAR 2018 01:50:32

Lowest Channel / Full RB

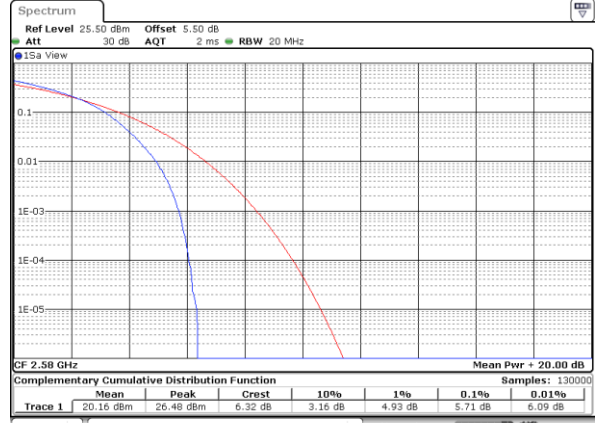

Date: 20 MAR 2018 01:50:50

Middle Channel / 1RB

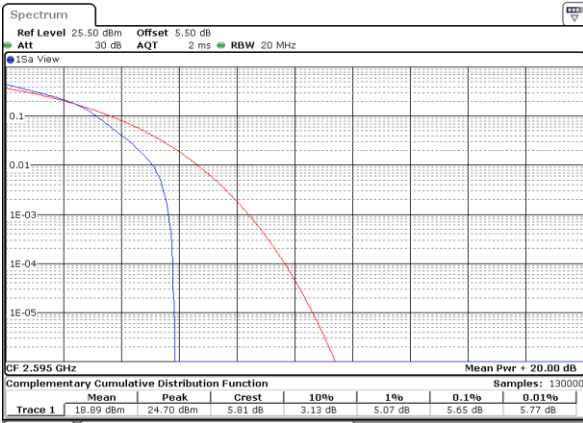

Date: 20 MAR 2018 01:51:05

Middle Channel / Full RB

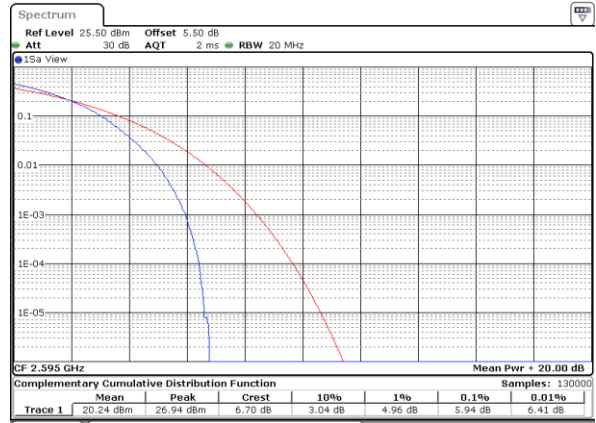

Date: 20 MAR 2018 01:51:20

Highest Channel / 1RB

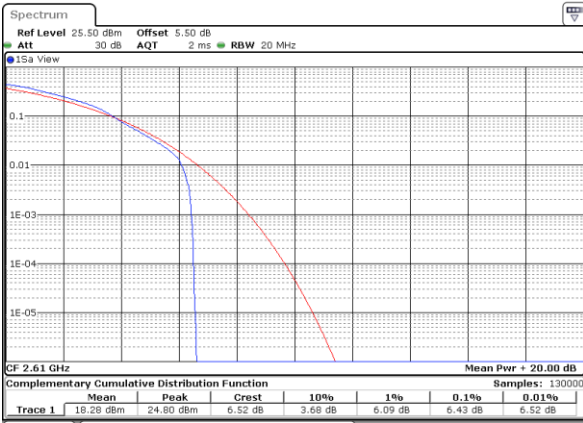

Date: 20 MAR 2018 01:51:34

Highest Channel / Full RB

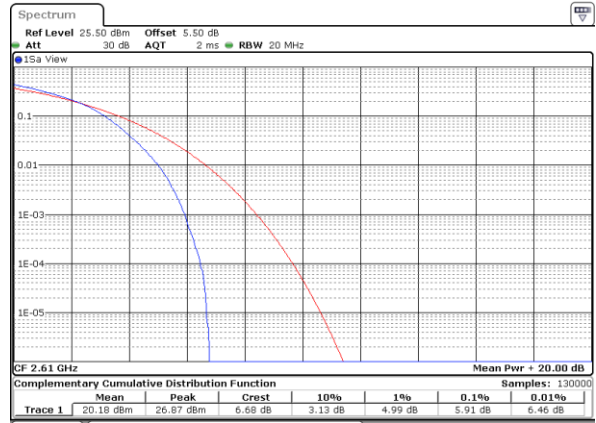

Date: 20 MAR 2018 01:51:48



26dB Bandwidth

Mode	LTE Band 4 : 26dB BW(MHz)											
	1.4MHz		3MHz		5MHz		10MHz		15MHz		20MHz	
Mod.	QPSK	16QAM	QPSK	16QAM	QPSK	16QAM	QPSK	16QAM	QPSK	16QAM	QPSK	16QAM
Lowest CH	1.27	1.253	3.057	3.015	4.765	4.945	9.81	9.75	14.176	14.655	20.34	20.18
Middle CH	1.306	1.264	3.009	3.003	4.915	4.955	9.63	9.79	14.416	14.266	20.18	20.06
Highest CH	1.273	1.278	2.991	3.033	4.955	4.895	9.81	9.81	14.236	14.446	20.26	20.22

Mode	LTE Band 5 : 26dB BW(MHz)											
	1.4MHz		3MHz		5MHz		10MHz		15MHz		20MHz	
Mod.	QPSK	16QAM	QPSK	16QAM	QPSK	16QAM	QPSK	16QAM	QPSK	16QAM	QPSK	16QAM
Lowest CH	1.278	1.281	3.003	2.967	4.815	4.925	9.95	9.75	-	-	-	-
Middle CH	1.298	1.248	2.949	3.039	4.895	4.935	9.79	9.75	-	-	-	-
Highest CH	1.236	1.273	3.009	2.997	4.895	4.945	9.75	9.79	-	-	-	-

Mode	LTE Band 7 : 26dB BW(MHz)											
	1.4MHz		3MHz		5MHz		10MHz		15MHz		20MHz	
Mod.	QPSK	16QAM	QPSK	16QAM	QPSK	16QAM	QPSK	16QAM	QPSK	16QAM	QPSK	16QAM
Lowest CH	-	-	-	-	4.785	4.925	9.89	9.71	14.356	14.446	20.06	20.14
Middle CH	-	-	-	-	4.895	4.925	9.87	9.89	14.296	14.505	20.1	20.14
Highest CH	-	-	-	-	4.945	4.915	9.73	9.73	14.266	14.446	20.06	20.06

Mode	LTE Band 38 : 26dB BW(MHz)											
	1.4MHz		3MHz		5MHz		10MHz		15MHz		20MHz	
Mod.	QPSK	16QAM	QPSK	16QAM	QPSK	16QAM	QPSK	16QAM	QPSK	16QAM	QPSK	16QAM
Lowest CH	-	-	-	-	4.835	4.905	9.69	9.75	14.146	14.206	19.98	20.06
Middle CH	-	-	-	-	4.945	4.795	9.75	9.63	14.446	14.655	20.1	20.06
Highest CH	-	-	-	-	4.825	4.885	9.77	9.77	14.505	14.236	20.06	20.06



LTE Band 4

Lowest Channel / 1.4MHz / QPSK

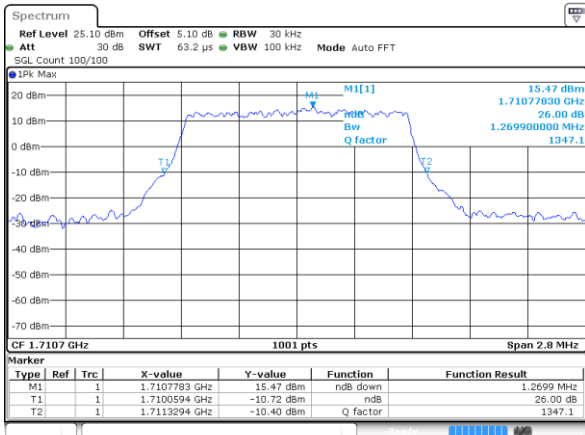

Date: 19 MAR 2018 19:52:35

Lowest Channel / 1.4MHz / 16QAM

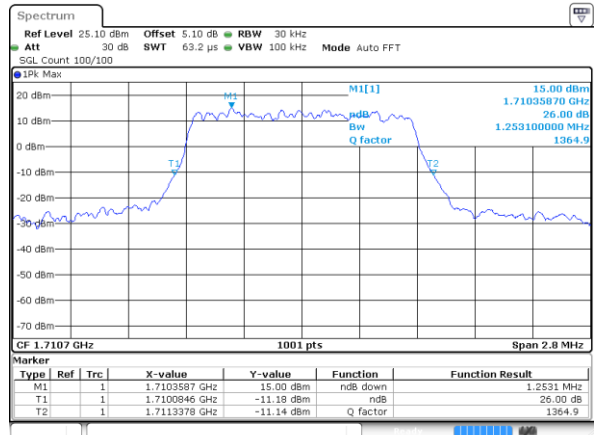

Date: 19 MAR 2018 19:52:45

Middle Channel / 1.4MHz / QPSK

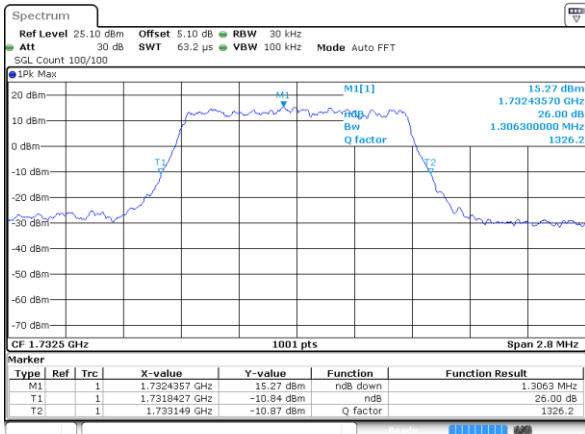

Date: 19 MAR 2018 19:59:40

Middle Channel / 1.4MHz / 16QAM

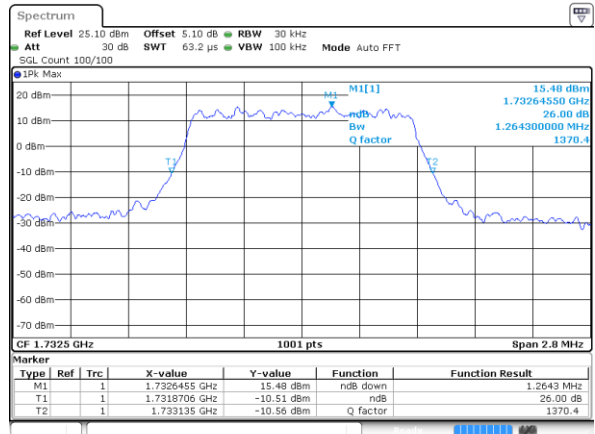

Date: 19 MAR 2018 19:59:50

Highest Channel / 1.4MHz / QPSK

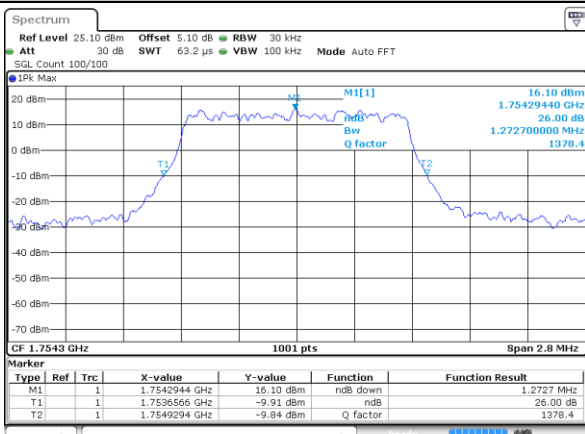

Date: 19 MAR 2018 20:02:10

Highest Channel / 1.4MHz / 16QAM

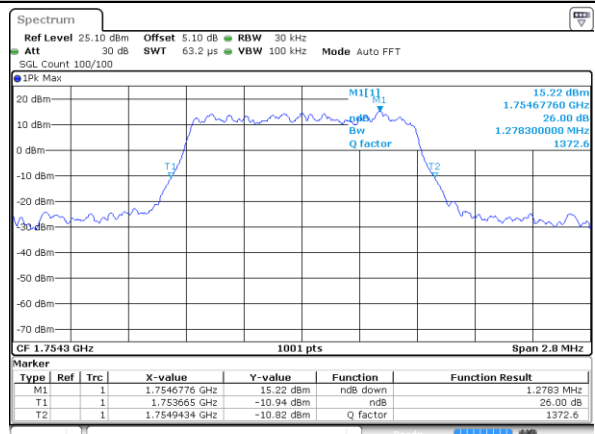

Date: 19 MAR 2018 20:02:20



LTE Band 4

Lowest Channel / 3MHz / QPSK

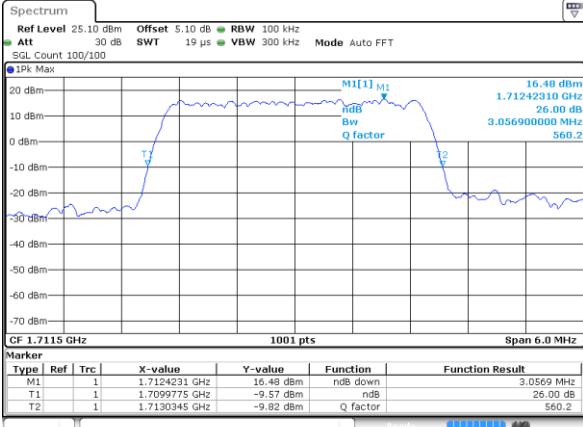

Date: 19 MAR 2018 20:09:18

Lowest Channel / 3MHz / 16QAM

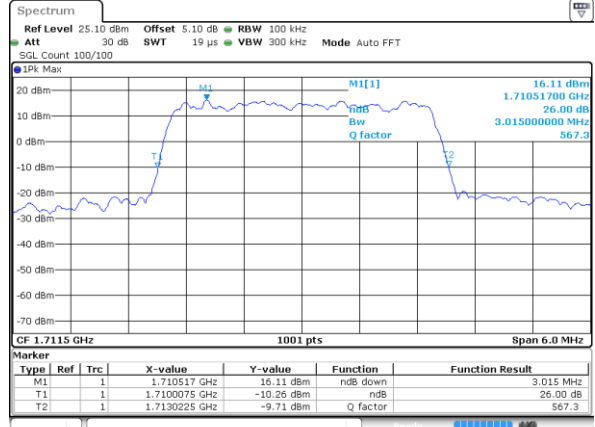

Date: 19 MAR 2018 20:09:28

Middle Channel / 3MHz / QPSK

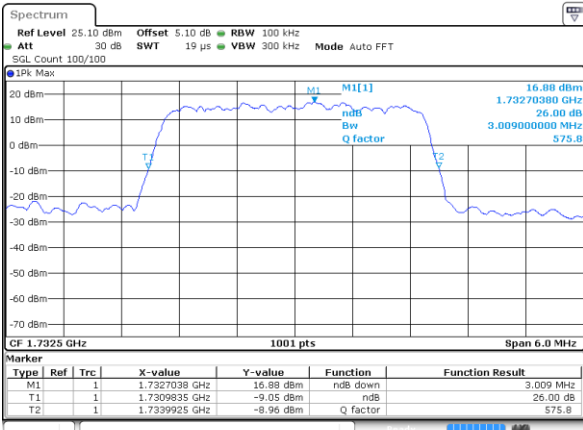

Date: 19 MAR 2018 20:16:22

Middle Channel / 3MHz / 16QAM

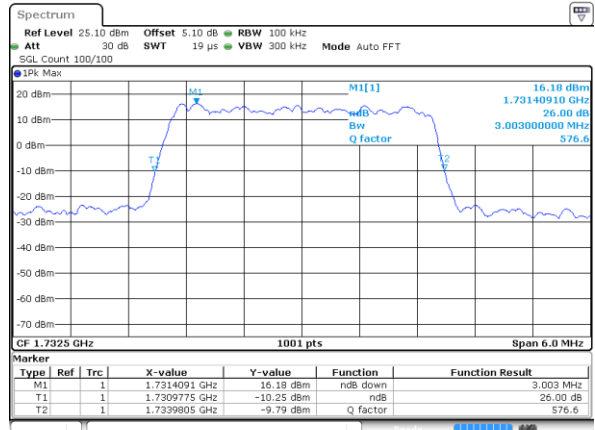

Date: 19 MAR 2018 20:16:32

Highest Channel / 3MHz / QPSK

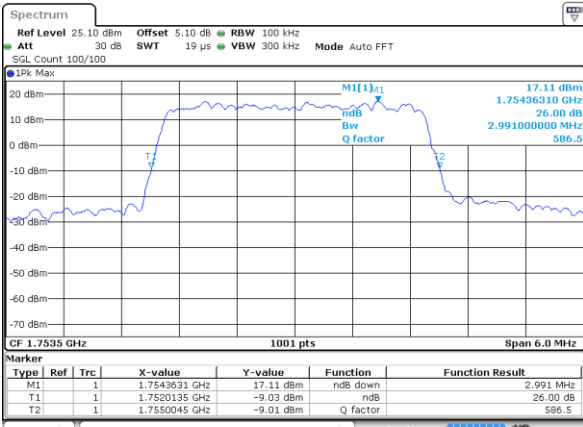

Date: 19 MAR 2018 20:18:54

Highest Channel / 3MHz / 16QAM

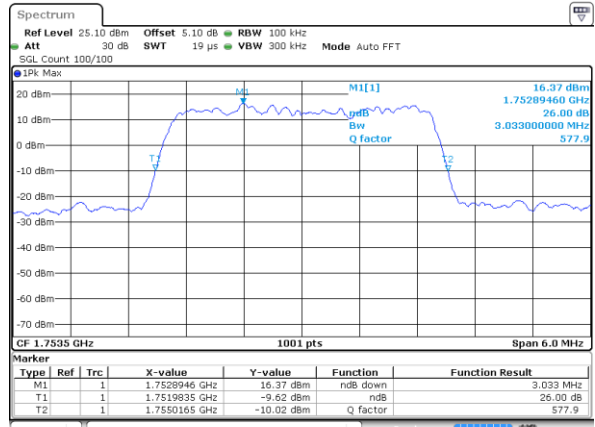

Date: 19 MAR 2018 20:19:04



LTE Band 4

Lowest Channel / 5MHz / QPSK

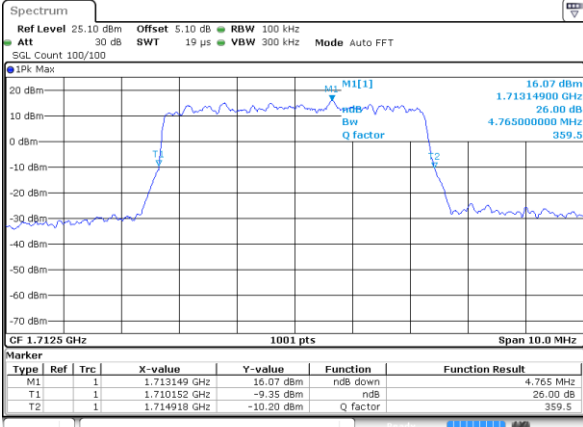

Date: 19 MAR 2018 20:25:57

Lowest Channel / 5MHz / 16QAM

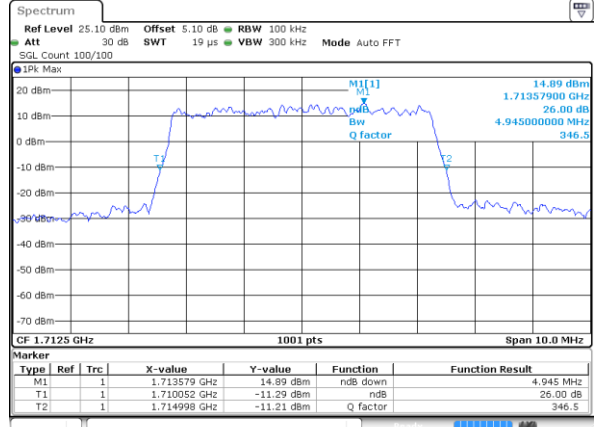

Date: 19 MAR 2018 20:26:07

Middle Channel / 5MHz / QPSK

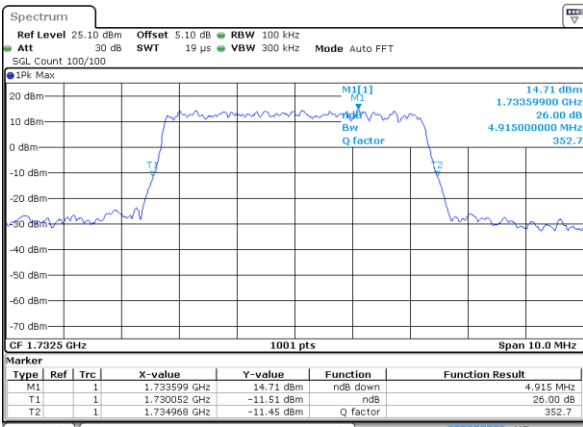

Date: 19 MAR 2018 20:32:58

Middle Channel / 5MHz / 16QAM

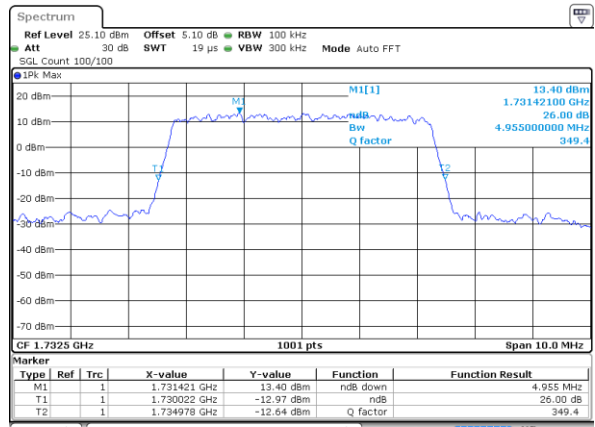

Date: 19 MAR 2018 20:33:09

Highest Channel / 5MHz / QPSK

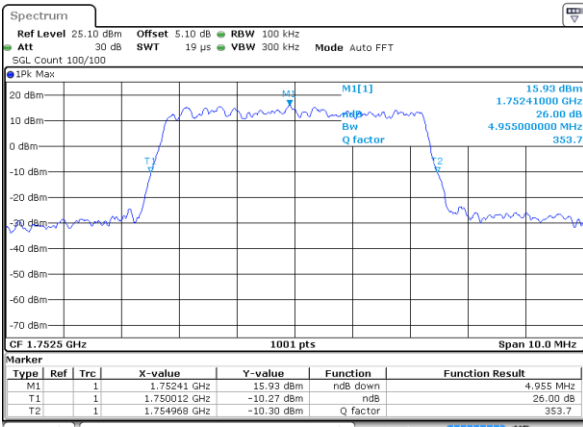

Date: 19 MAR 2018 20:35:31

Highest Channel / 5MHz / 16QAM

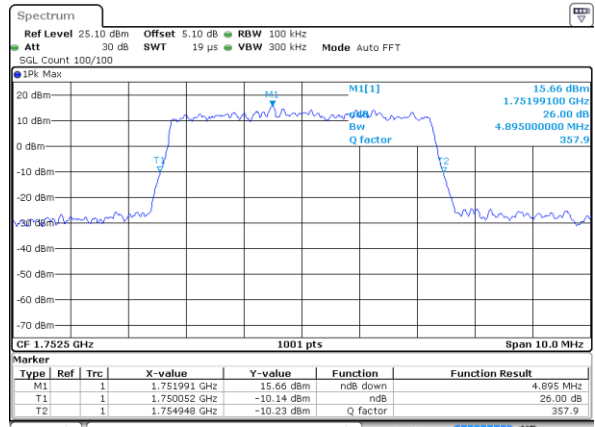

Date: 19 MAR 2018 20:35:41



LTE Band 4

Lowest Channel / 10MHz / QPSK

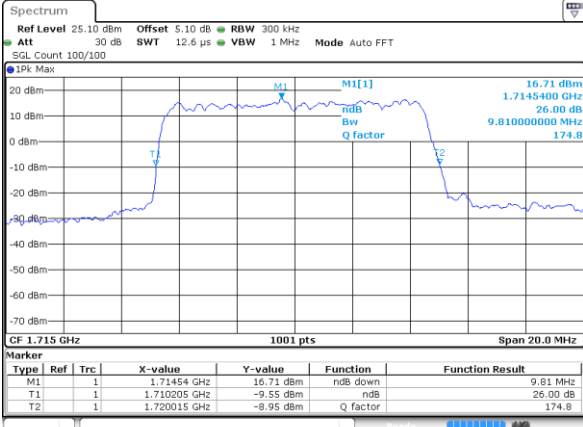

Date: 19 MAR 2018 20:42:35

Lowest Channel / 10MHz / 16QAM

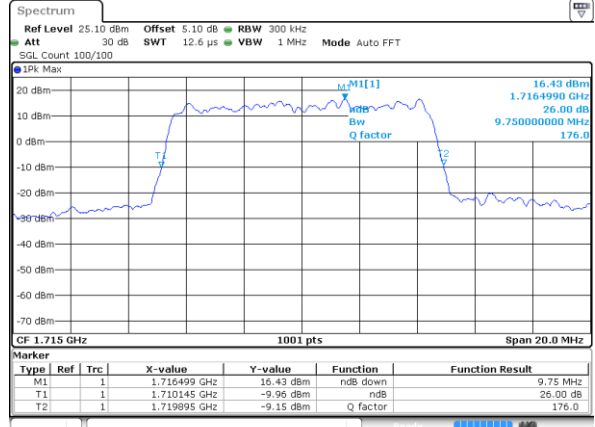

Date: 19 MAR 2018 20:42:45

Middle Channel / 10MHz / QPSK

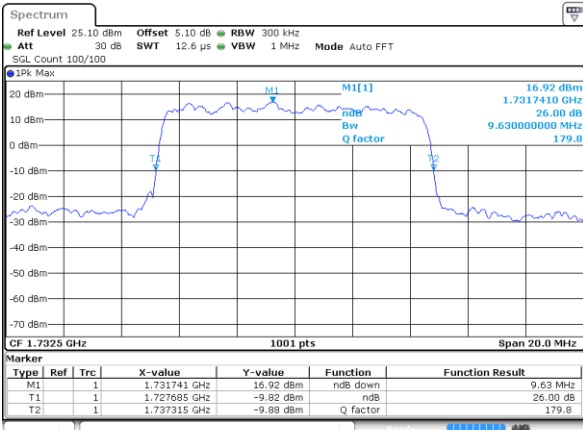

Date: 19 MAR 2018 20:49:37

Middle Channel / 10MHz / 16QAM

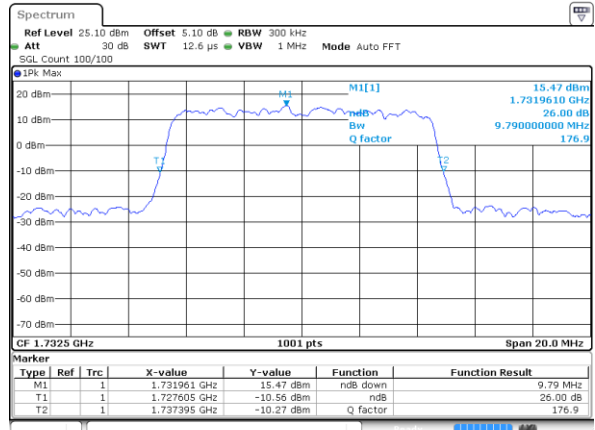

Date: 19 MAR 2018 20:49:47

Highest Channel / 10MHz / QPSK

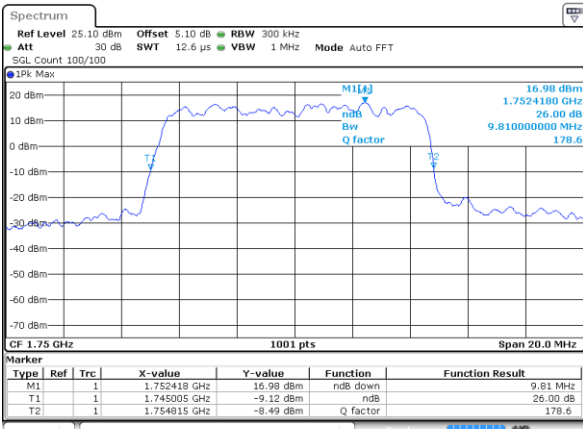

Date: 19 MAR 2018 20:52:16

Highest Channel / 10MHz / 16QAM

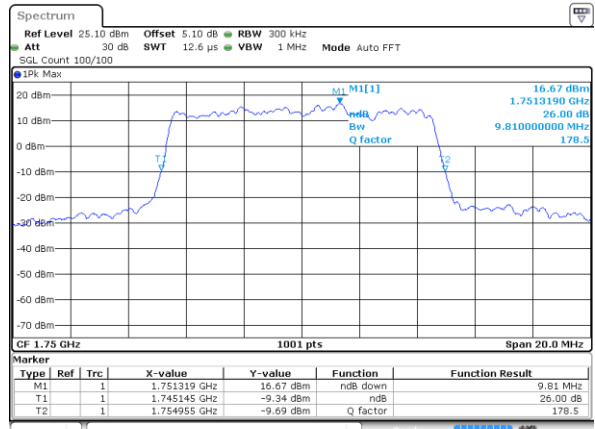

Date: 19 MAR 2018 20:52:26



LTE Band 4

Lowest Channel / 15MHz / QPSK

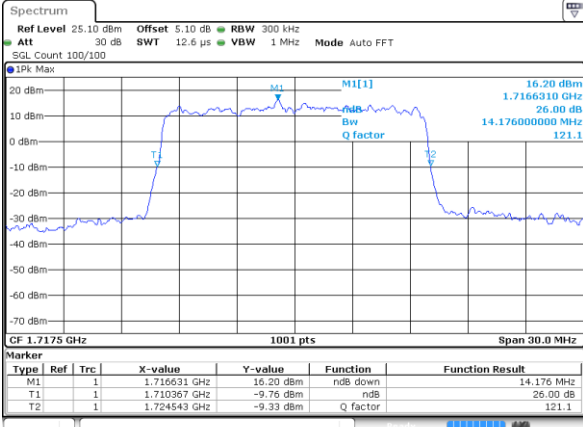

Date: 19 MAR 2018 20:59:16

Lowest Channel / 15MHz / 16QAM

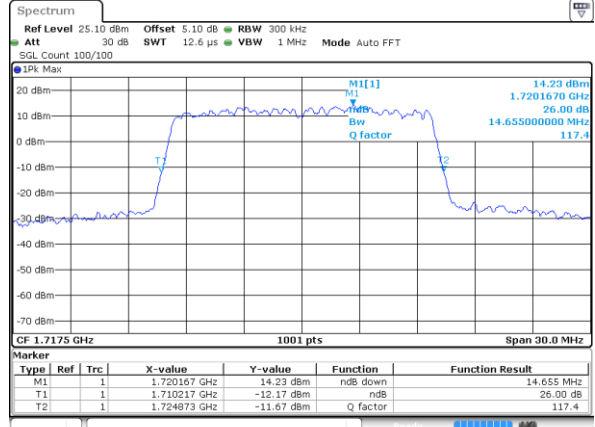

Date: 19 MAR 2018 20:59:26

Middle Channel / 15MHz / QPSK

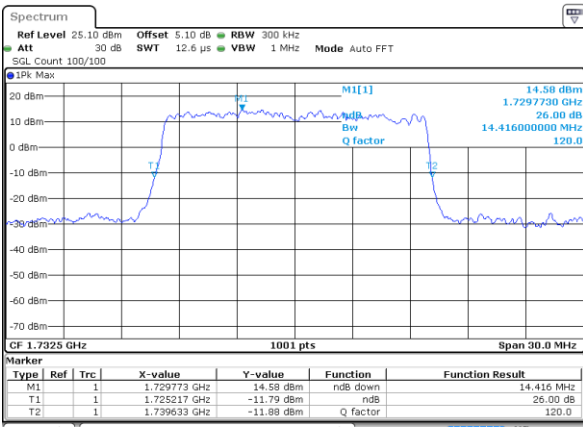

Date: 19 MAR 2018 21:06:17

Middle Channel / 15MHz / 16QAM

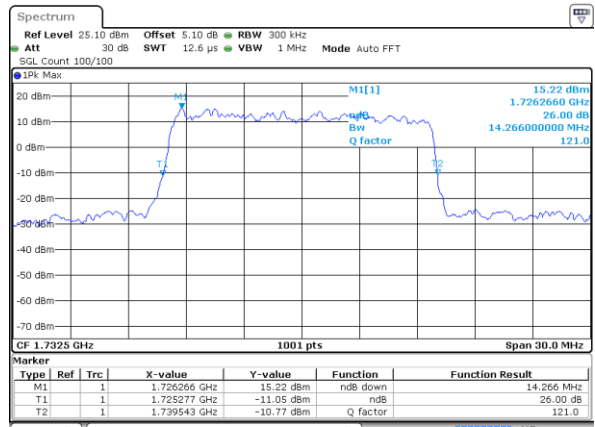

Date: 19 MAR 2018 21:06:27

Highest Channel / 15MHz / QPSK

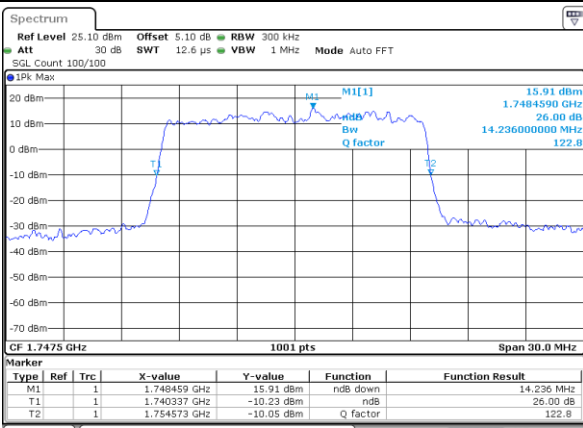

Date: 19 MAR 2018 21:08:47

Highest Channel / 15MHz / 16QAM

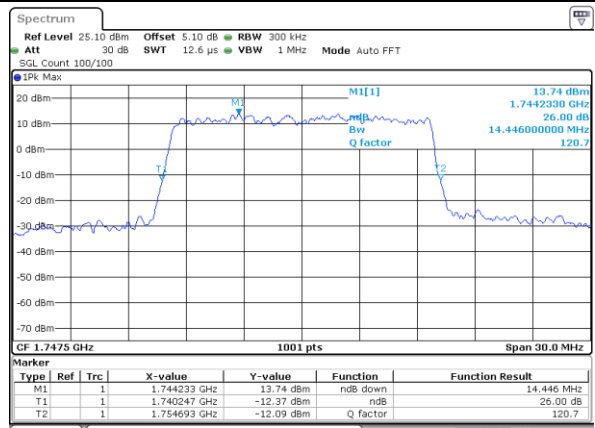

Date: 19 MAR 2018 21:08:57



LTE Band 4

Lowest Channel / 20MHz / QPSK

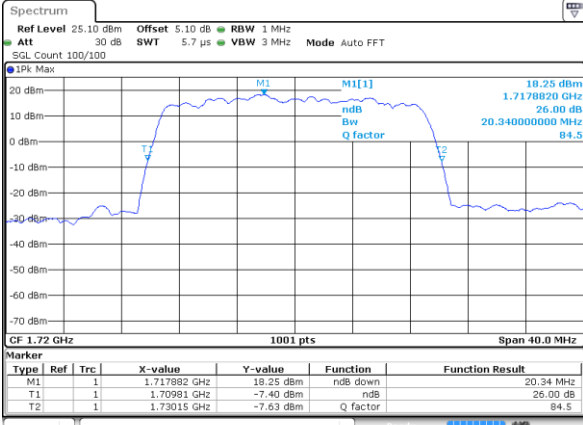

Date: 19 MAR 2018 21:15:47

Lowest Channel / 20MHz / 16QAM

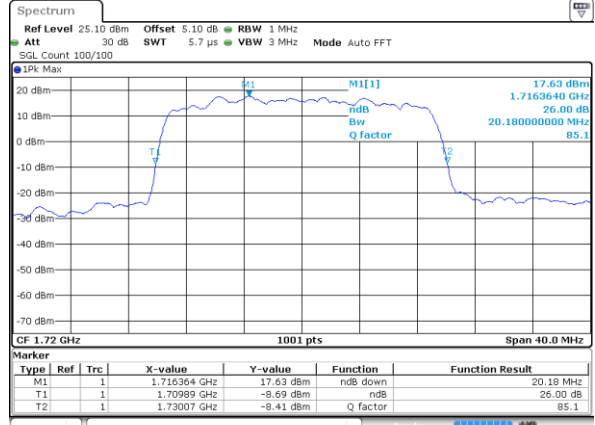

Date: 19 MAR 2018 21:15:57

Middle Channel / 20MHz / QPSK

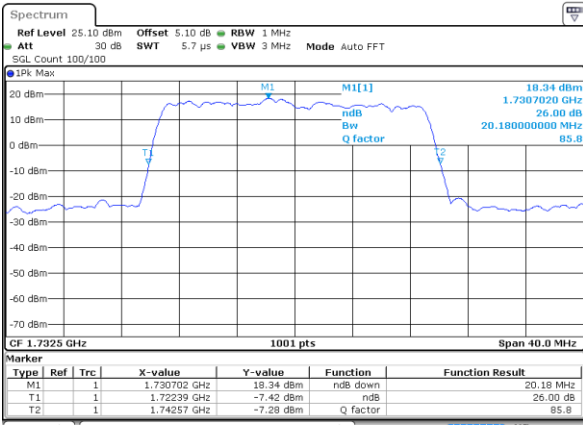

Date: 19 MAR 2018 21:22:48

Middle Channel / 20MHz / 16QAM

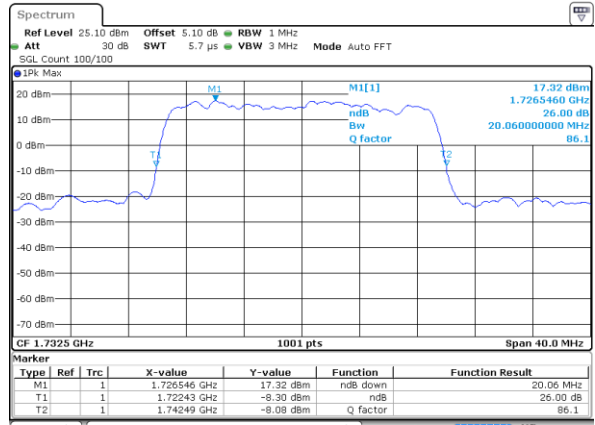

Date: 19 MAR 2018 21:22:58

Highest Channel / 20MHz / QPSK

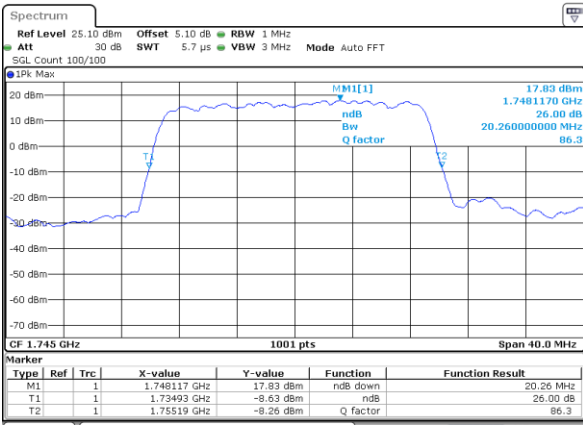

Date: 19 MAR 2018 21:25:17

Highest Channel / 20MHz / 16QAM

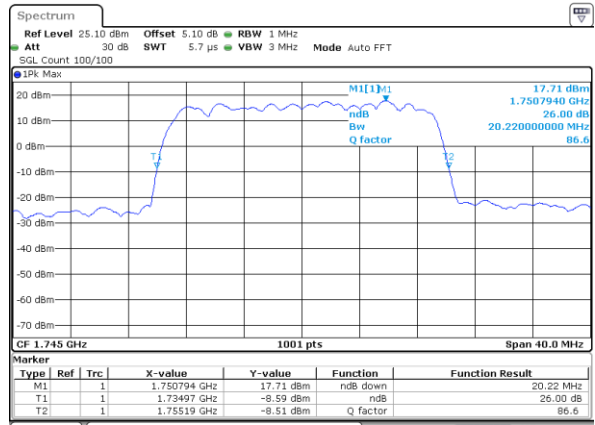

Date: 19 MAR 2018 21:25:28



LTE Band 5

Lowest Channel / 1.4MHz / QPSK

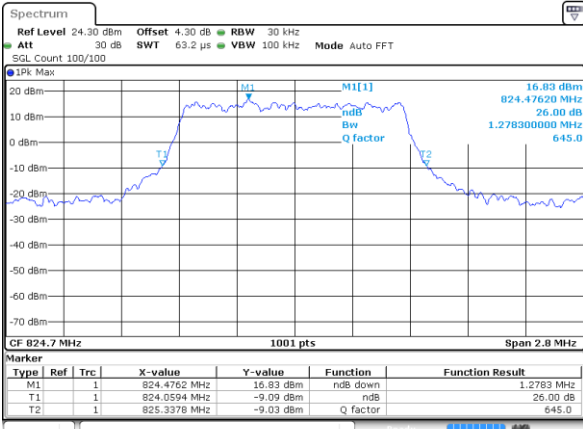

Date: 18 MAR 2018 06:05:10

Lowest Channel / 1.4MHz / 16QAM

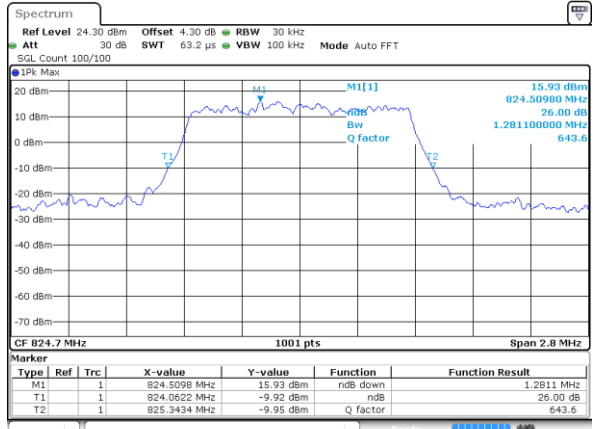

Date: 18 MAR 2018 06:04:59

Middle Channel / 1.4MHz / QPSK

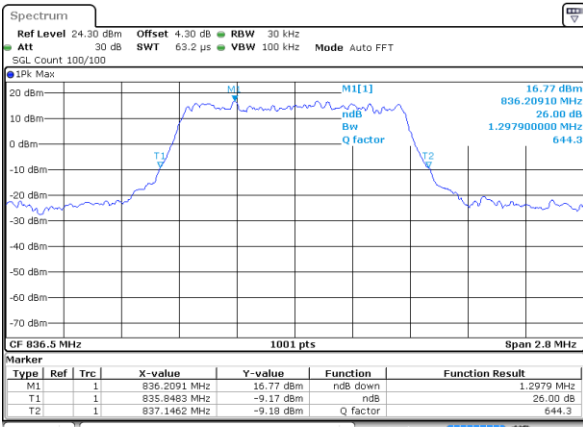

Date: 18 MAR 2018 06:14:05

Middle Channel / 1.4MHz / 16QAM

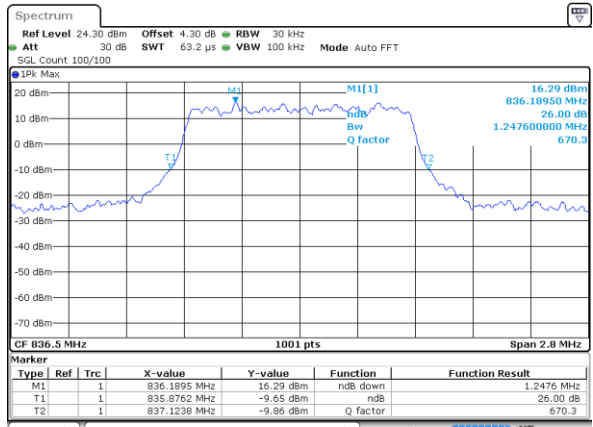

Date: 18 MAR 2018 06:14:16

Highest Channel / 1.4MHz / QPSK

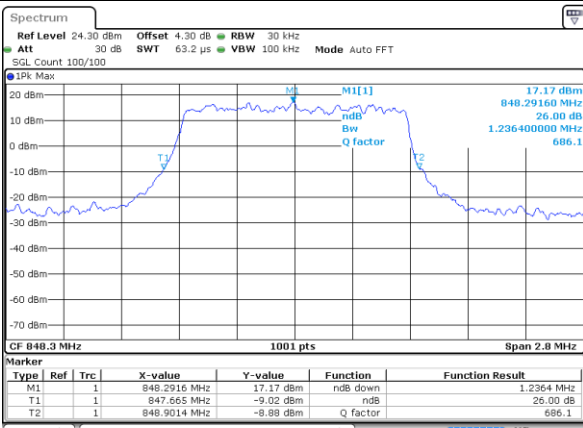

Date: 18 MAR 2018 06:16:44

Highest Channel / 1.4MHz / 16QAM

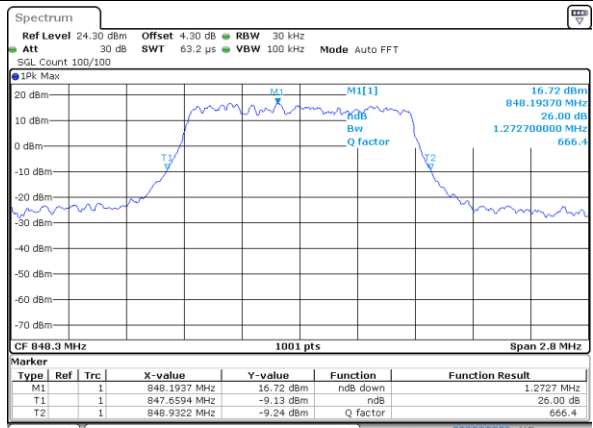

Date: 18 MAR 2018 06:16:56



LTE Band 5

Lowest Channel / 3MHz / QPSK

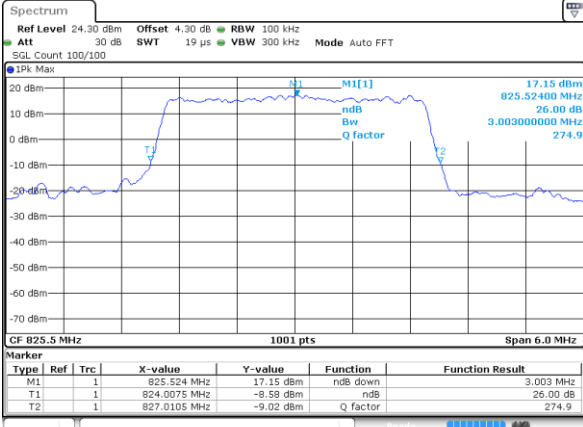

Date: 18 MAR 2018 06:26:01

Lowest Channel / 3MHz / 16QAM

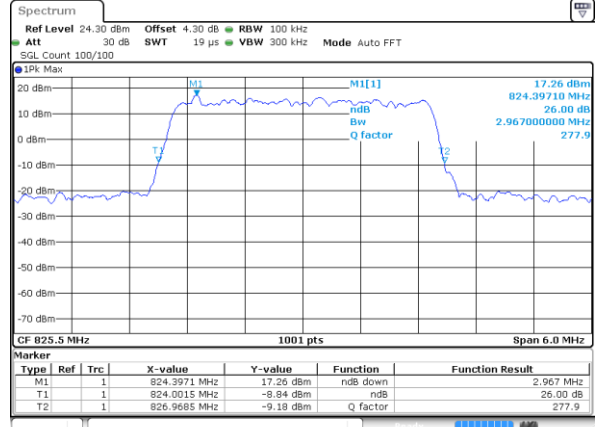

Date: 18 MAR 2018 06:26:11

Middle Channel / 3MHz / QPSK

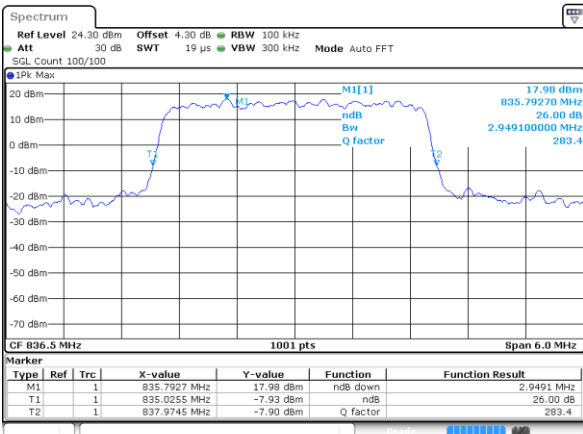

Date: 18 MAR 2018 06:35:13

Middle Channel / 3MHz / 16QAM

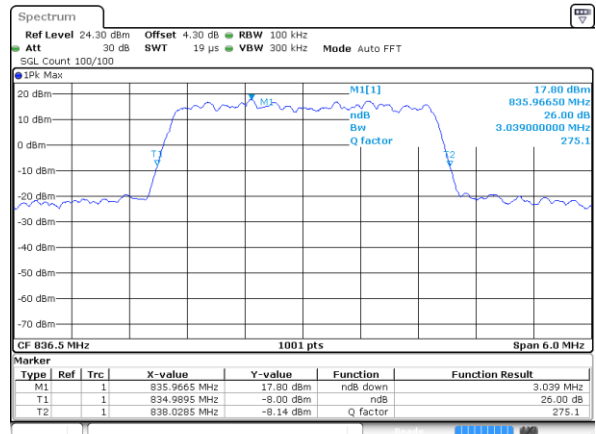

Date: 18 MAR 2018 06:35:24

Highest Channel / 3MHz / QPSK

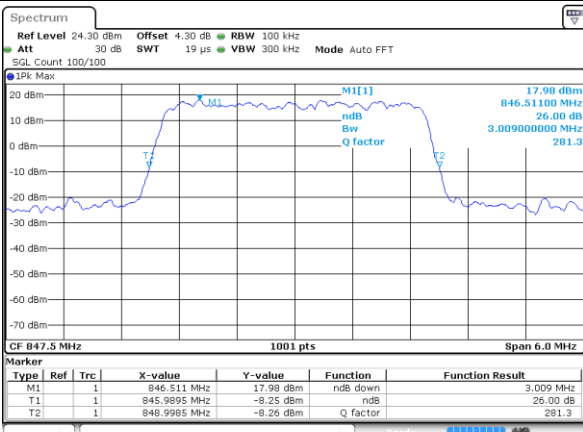

Date: 18 MAR 2018 06:37:50

Highest Channel / 3MHz / 16QAM

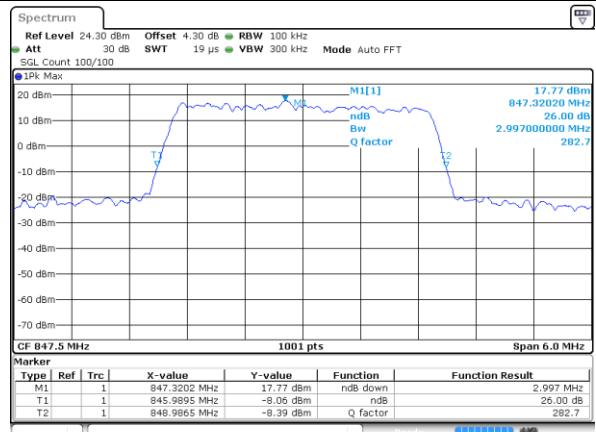

Date: 18 MAR 2018 06:38:02



LTE Band 5

Lowest Channel / 5MHz / QPSK

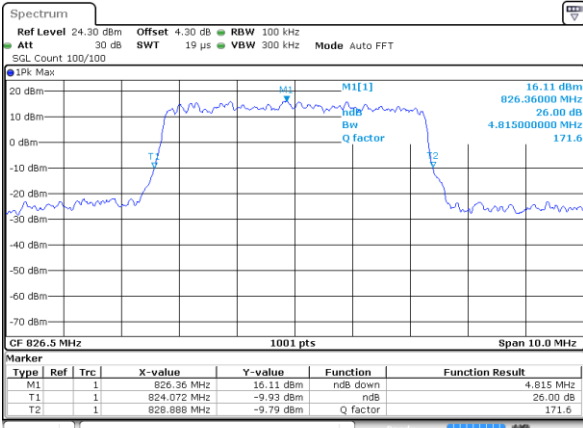

Date: 18 MAR 2018 06:47:06

Lowest Channel / 5MHz / 16QAM

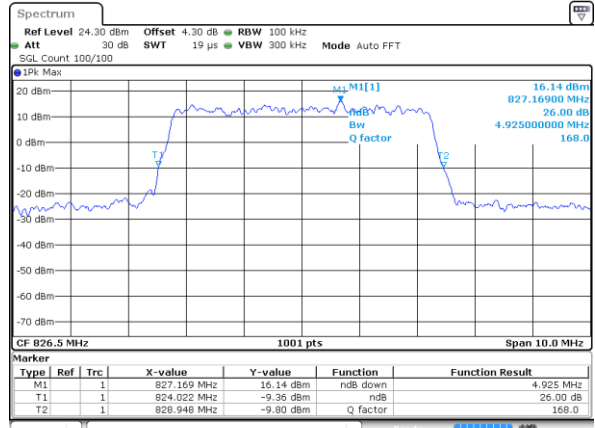

Date: 18 MAR 2018 06:47:17

Middle Channel / 5MHz / QPSK

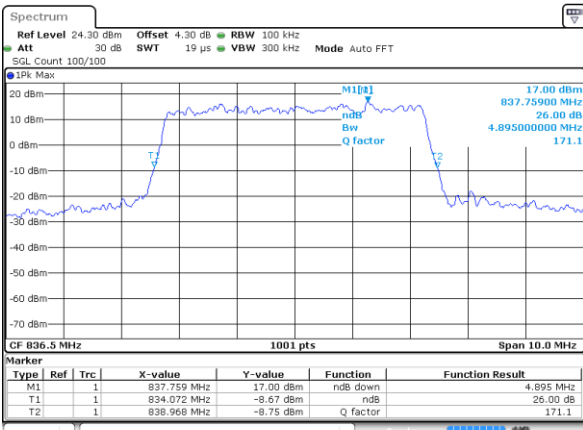

Date: 18 MAR 2018 06:56:16

Middle Channel / 5MHz / 16QAM

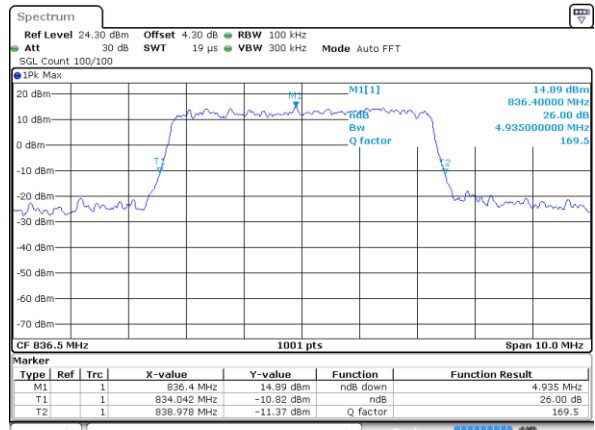

Date: 18 MAR 2018 06:56:28

Highest Channel / 5MHz / QPSK

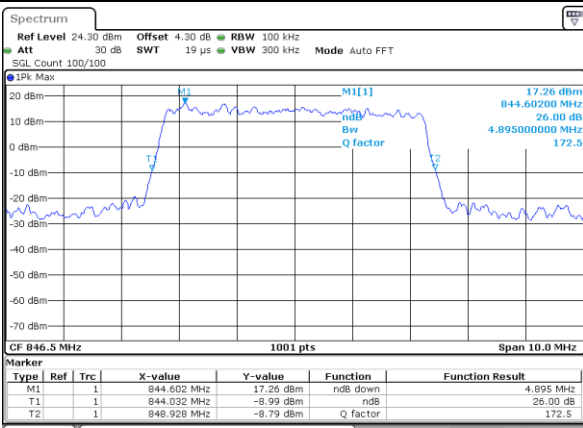

Date: 18 MAR 2018 06:58:56

Highest Channel / 5MHz / 16QAM

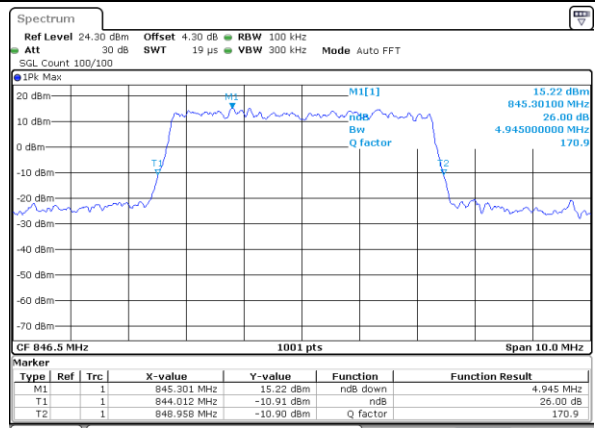

Date: 18 MAR 2018 06:59:07



LTE Band 5

Lowest Channel / 10MHz / QPSK

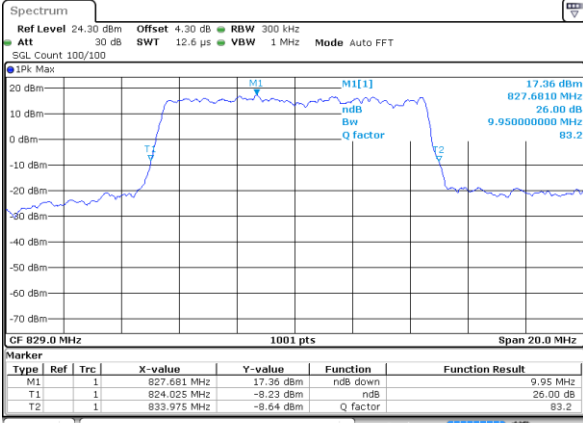

Date: 18 MAR 2018 07:08:09

Lowest Channel / 10MHz / 16QAM

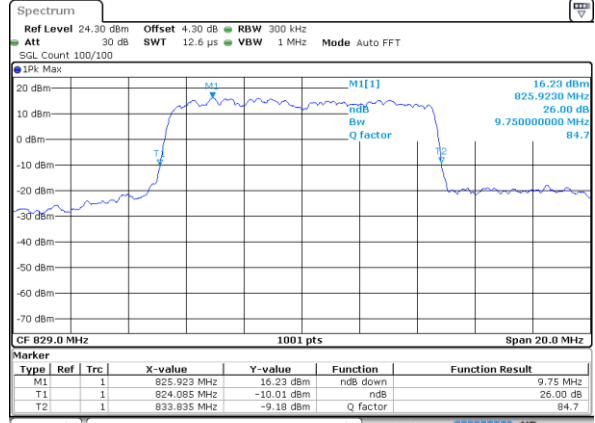

Date: 18 MAR 2018 07:08:20

Middle Channel / 10MHz / QPSK

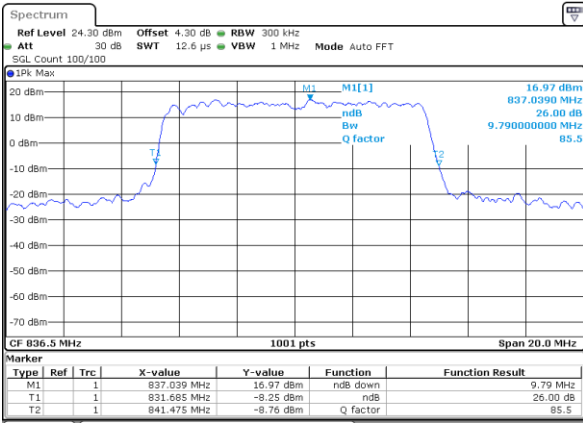

Date: 18 MAR 2018 07:17:21

Middle Channel / 10MHz / 16QAM

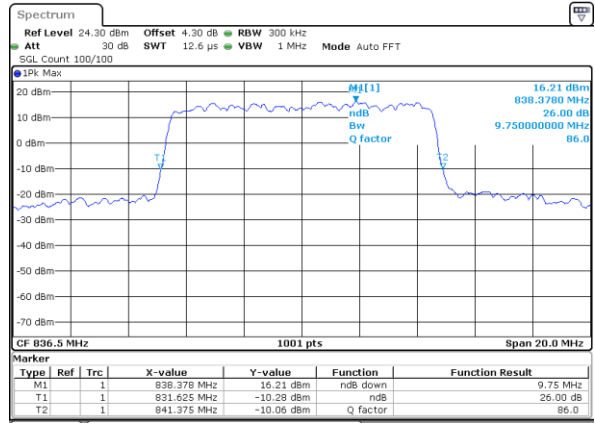

Date: 18 MAR 2018 07:17:32

Highest Channel / 10MHz / QPSK

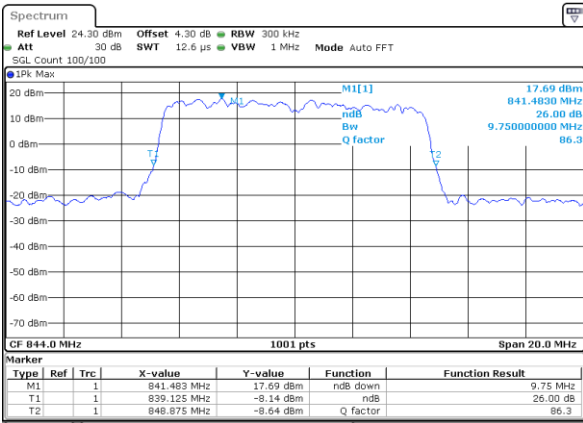

Date: 18 MAR 2018 07:19:58

Highest Channel / 10MHz / 16QAM

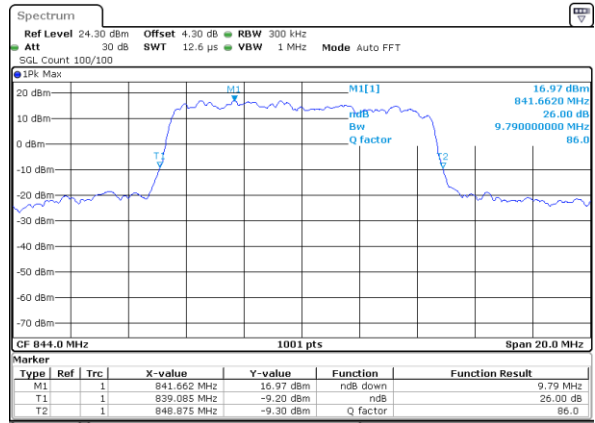

Date: 18 MAR 2018 07:20:10