

#01_GSM850_GPRS (4 Tx slots)_Right Cheek_Ch251

Communication System: GSM850; Frequency: 848.8 MHz; Duty Cycle: 1:2.08

Medium: HSL_850_180508 Medium parameters used: $f = 849$ MHz; $\sigma = 0.931$ S/m; $\epsilon_r = 41.303$; $\rho = 1000$ kg/m³

Ambient Temperature : 23.3 °C; Liquid Temperature : 22.3 °C

DASY5 Configuration

- Probe: EX3DV4 - SN7306; ConvF(9.79, 9.79, 9.79); Calibrated: 2017/7/24;
- Sensor-Surface: 1.4mm (Mechanical Surface Detection)
- Electronics: DAE3 Sn577; Calibrated: 2017/9/25
- Phantom: SAM LEFT; Type: QD000P40CD; Serial: TP:1718
- Measurement SW: DASY52, Version 52.8 (8); SEMCAD X Version 14.6.10 (7373)

Area Scan (61x111x1): Interpolated grid: dx=1.500 mm, dy=1.500 mm

Maximum value of SAR (interpolated) = 0.560 W/kg

Zoom Scan (5x5x7)/Cube 0: Measurement grid: dx=8mm, dy=8mm, dz=5mm

Reference Value = 25.10 V/m; Power Drift = -0.14 dB

Peak SAR (extrapolated) = 0.619 W/kg

SAR(1 g) = 0.465 W/kg; SAR(10 g) = 0.351 W/kg

Maximum value of SAR (measured) = 0.556 W/kg

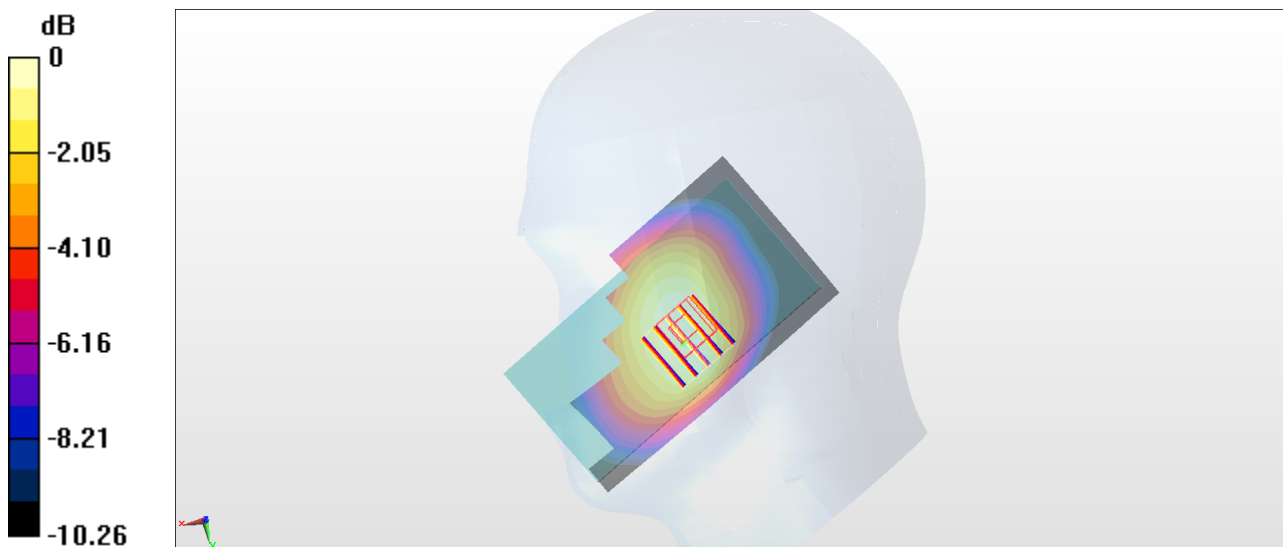

0 dB = 0.556 W/kg = -2.55 dBW/kg

#02_GSM1900_GPRS (4 Tx slots)_Right Cheek_Ch810

Communication System: PCS ; Frequency: 1909.8 MHz;Duty Cycle: 1:2.08

Medium: HSL_1900_180507 Medium parameters used: $f = 1910$ MHz; $\sigma = 1.439$ S/m; $\epsilon_r = 39.922$; $\rho = 1000$ kg/m³

Ambient Temperature : 23.3 °C ; Liquid Temperature : 22.3 °C

DASY5 Configuration

- Probe: EX3DV4 - SN7306; ConvF(8.34, 8.34, 8.34); Calibrated: 2017/7/24;
- Sensor-Surface: 1.4mm (Mechanical Surface Detection)
- Electronics: DAE3 Sn577; Calibrated: 2017/9/25
- Phantom: SAM LEFT; Type: QD000P40CD; Serial: TP:1718
- Measurement SW: DASY52, Version 52.8 (8); SEMCAD X Version 14.6.10 (7373)

Area Scan (61x111x1): Interpolated grid: dx=1.500 mm, dy=1.500 mm

Maximum value of SAR (interpolated) = 0.403 W/kg

Zoom Scan (5x5x7)/Cube 0: Measurement grid: dx=8mm, dy=8mm, dz=5mm

Reference Value = 15.13 V/m; Power Drift = 0.13 dB

Peak SAR (extrapolated) = 0.427 W/kg

SAR(1 g) = 0.267 W/kg; SAR(10 g) = 0.162 W/kg

Maximum value of SAR (measured) = 0.366 W/kg

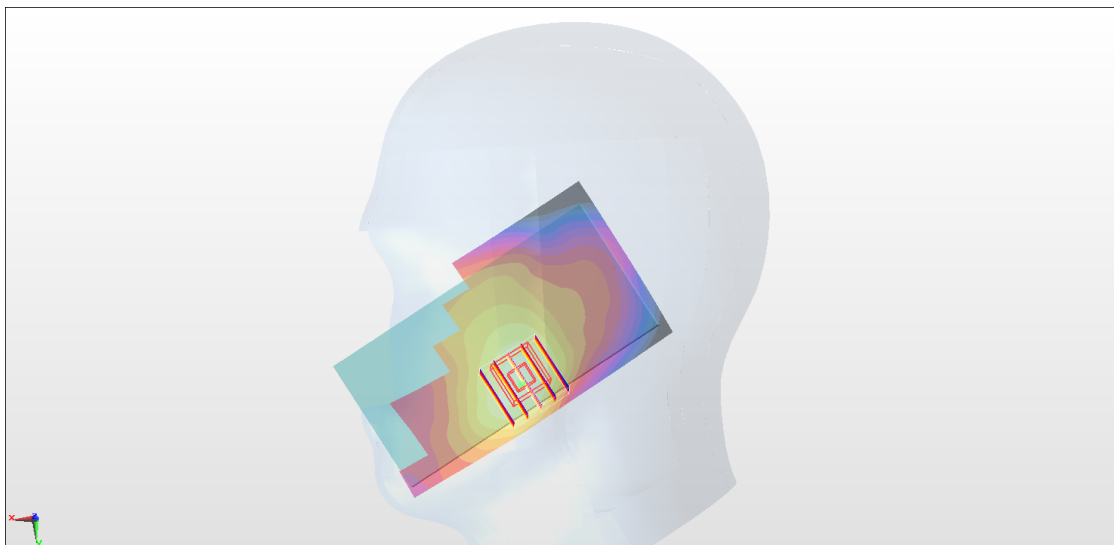
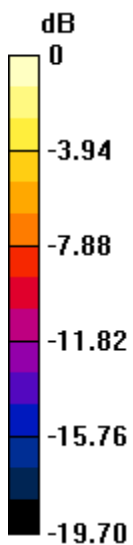

0 dB = 0.403 W/kg = -3.95 dBW/kg

#03_WCDMA II_RMC 12.2Kbps_Right Cheek_Ch9538

Communication System: WCDMA ; Frequency: 1907.6 MHz;Duty Cycle: 1:1

Medium: HSL_1900_180507 Medium parameters used: $f = 1908$ MHz; $\sigma = 1.437$ S/m; $\epsilon_r = 39.929$; $\rho = 1000$ kg/m³

Ambient Temperature : 23.3 °C ; Liquid Temperature : 22.3 °C

DASY5 Configuration

- Probe: EX3DV4 - SN7306; ConvF(8.34, 8.34, 8.34); Calibrated: 2017/7/24;
- Sensor-Surface: 1.4mm (Mechanical Surface Detection)
- Electronics: DAE3 Sn577; Calibrated: 2017/9/25
- Phantom: SAM LEFT; Type: QD000P40CD; Serial: TP:1718
- Measurement SW: DASY52, Version 52.8 (8); SEMCAD X Version 14.6.10 (7373)

Area Scan (61x111x1): Interpolated grid: dx=1.500 mm, dy=1.500 mm

Maximum value of SAR (interpolated) = 0.257 W/kg

Zoom Scan (5x5x7)/Cube 0: Measurement grid: dx=8mm, dy=8mm, dz=5mm

Reference Value = 12.50 V/m; Power Drift = 0.12 dB

Peak SAR (extrapolated) = 0.282 W/kg

SAR(1 g) = 0.174 W/kg; SAR(10 g) = 0.105 W/kg

Maximum value of SAR (measured) = 0.234 W/kg

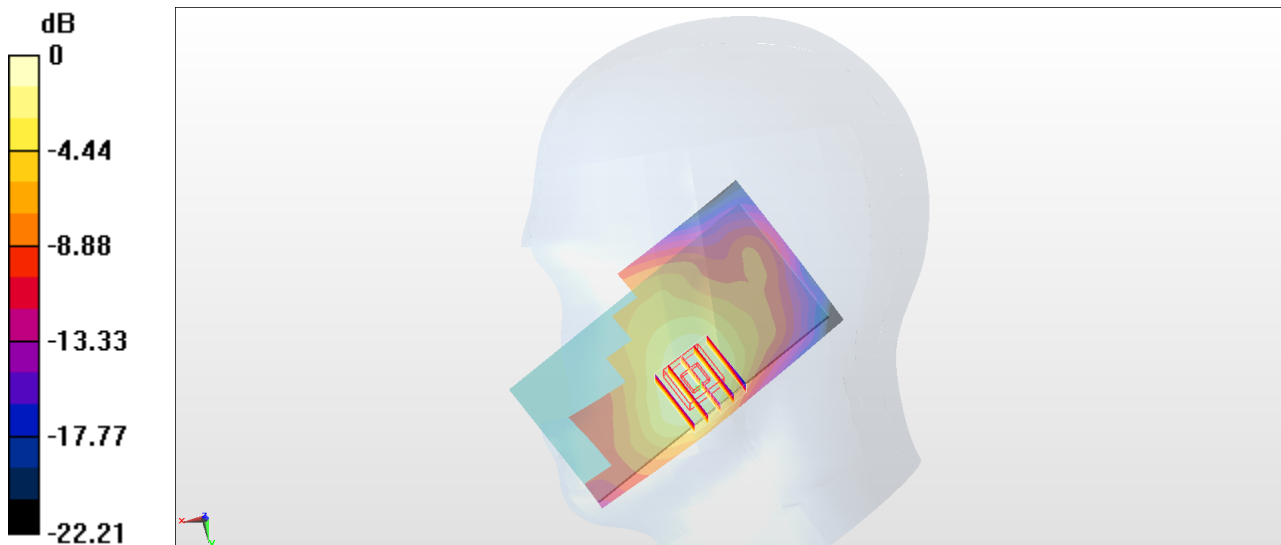

0 dB = 0.257 W/kg = -5.90 dBW/kg

#04_WCDMA IV_RMC 12.2Kbps_Right Cheek_Ch1513

Communication System: WCDMA; Frequency: 1752.6 MHz; Duty Cycle: 1:1
Medium: HSL_1750_180523 Medium parameters used: $f = 1753$ MHz; $\sigma = 1.371$ S/m; $\epsilon_r = 40.046$;
 $\rho = 1000$ kg/m³
Ambient Temperature : 23.3 °C; Liquid Temperature : 22.3 °C

DASY5 Configuration:

- Probe: EX3DV4 - SN7306; ConvF(8.64, 8.64, 8.64); Calibrated: 2017/7/24;
- Sensor-Surface: 1.4mm (Mechanical Surface Detection)
- Electronics: DAE3 Sn577; Calibrated: 2017/9/25
- Phantom: SAM-Right; Type: SAM; Serial: TP-1503
- Measurement SW: DASY52, Version 52.10 (0); SEMCAD X Version 14.6.10 (7417)

Area Scan (61x101x1): Interpolated grid: dx=1.500 mm, dy=1.500 mm
Maximum value of SAR (interpolated) = 0.179 W/kg

Zoom Scan (5x5x7)/Cube 0: Measurement grid: dx=8mm, dy=8mm, dz=5mm
Reference Value = 10.46 V/m; Power Drift = 0.07 dB
Peak SAR (extrapolated) = 0.193 W/kg
SAR(1 g) = 0.126 W/kg; SAR(10 g) = 0.079 W/kg
Maximum value of SAR (measured) = 0.169 W/kg



0 dB = 0.169 W/kg = -7.72 dBW/kg

#05_WCDMA V_RMC 12.2Kbps_Right Cheek_Ch4182

Communication System: WCDMA; Frequency: 836.4 MHz; Duty Cycle: 1:1

Medium: HSL_850_180508 Medium parameters used: $f = 836.4$ MHz; $\sigma = 0.92$ S/m; $\epsilon_r = 41.469$; $\rho = 1000$ kg/m³

Ambient Temperature : 23.3 °C ; Liquid Temperature : 22.3 °C

DASY5 Configuration

- Probe: EX3DV4 - SN7306; ConvF(9.79, 9.79, 9.79); Calibrated: 2017/7/24;
- Sensor-Surface: 1.4mm (Mechanical Surface Detection)
- Electronics: DAE3 Sn577; Calibrated: 2017/9/25
- Phantom: SAM LEFT; Type: QD000P40CD; Serial: TP:1718
- Measurement SW: DASY52, Version 52.8 (8); SEMCAD X Version 14.6.10 (7373)

Area Scan (61x111x1): Interpolated grid: dx=1.500 mm, dy=1.500 mm

Maximum value of SAR (interpolated) = 0.424 W/kg

Zoom Scan (5x5x7)/Cube 0: Measurement grid: dx=8mm, dy=8mm, dz=5mm

Reference Value = 17.86 V/m; Power Drift = -0.03 dB

Peak SAR (extrapolated) = 0.471 W/kg

SAR(1 g) = 0.350 W/kg; SAR(10 g) = 0.263 W/kg

Maximum value of SAR (measured) = 0.422 W/kg

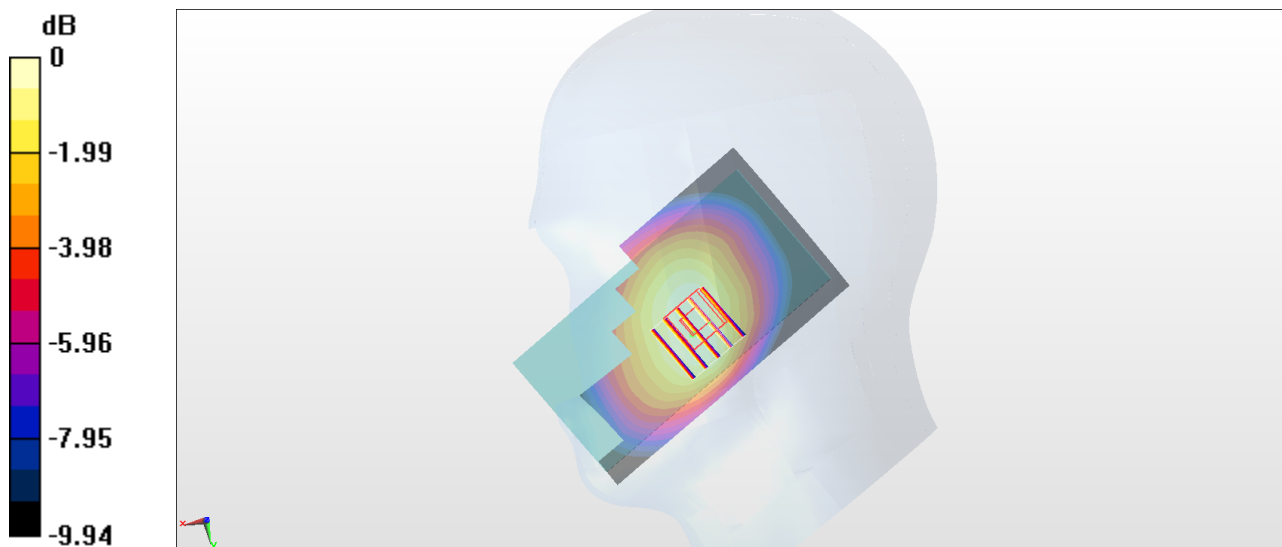

0 dB = 0.422 W/kg = -3.75 dBW/kg

#06_LTE Band 2_20M_QPSK_1_49_Right Cheek_Ch19100

Communication System: LTE ; Frequency: 1900 MHz;Duty Cycle: 1:1

Medium: HSL_1900_180507 Medium parameters used: $f = 1900$ MHz; $\sigma = 1.428$ S/m; $\epsilon_r = 39.951$; $\rho = 1000$ kg/m³

Ambient Temperature : 23.3 °C ; Liquid Temperature : 22.3 °C

DASY5 Configuration

- Probe: EX3DV4 - SN7306; ConvF(8.34, 8.34, 8.34); Calibrated: 2017/7/24;
- Sensor-Surface: 1.4mm (Mechanical Surface Detection)
- Electronics: DAE3 Sn577; Calibrated: 2017/9/25
- Phantom: SAM LEFT; Type: QD000P40CD; Serial: TP:1718
- Measurement SW: DASY52, Version 52.8 (8); SEMCAD X Version 14.6.10 (7373)

Area Scan (61x111x1): Interpolated grid: dx=1.500 mm, dy=1.500 mm

Maximum value of SAR (interpolated) = 0.301 W/kg

Zoom Scan (5x5x7)/Cube 0: Measurement grid: dx=8mm, dy=8mm, dz=5mm

Reference Value = 13.50 V/m; Power Drift = 0.08 dB

Peak SAR (extrapolated) = 0.322 W/kg

SAR(1 g) = 0.202 W/kg; SAR(10 g) = 0.123 W/kg

Maximum value of SAR (measured) = 0.269 W/kg



0 dB = 0.301 W/kg = -5.22 dBW/kg

#07_LTE Band 4_20M_QPSK_1_49_Right Cheek_Ch20175

Communication System: LTE ; Frequency: 1732.5 MHz;Duty Cycle: 1:1

Medium: HSL_1750_180507 Medium parameters used : $f = 1732.5$ MHz; $\sigma = 1.351$ S/m; $\epsilon_r = 41.37$; $\rho = 1000$ kg/m³

Ambient Temperature : 23.3 °C ; Liquid Temperature : 22.3 °C

DASY5 Configuration

- Probe: EX3DV4 - SN7306; ConvF(8.64, 8.64, 8.64); Calibrated: 2017/7/24;
- Sensor-Surface: 1.4mm (Mechanical Surface Detection)
- Electronics: DAE3 Sn577; Calibrated: 2017/9/25
- Phantom: SAM LEFT; Type: QD000P40CD; Serial: TP:1718
- Measurement SW: DASY52, Version 52.8 (8); SEMCAD X Version 14.6.10 (7373)

Area Scan (61x111x1): Interpolated grid: dx=1.500 mm, dy=1.500 mm

Maximum value of SAR (interpolated) = 0.199 W/kg

Zoom Scan (5x5x7)/Cube 0: Measurement grid: dx=8mm, dy=8mm, dz=5mm

Reference Value = 11.00 V/m; Power Drift = 0.13 dB

Peak SAR (extrapolated) = 0.209 W/kg

SAR(1 g) = 0.136 W/kg; SAR(10 g) = 0.086 W/kg

Maximum value of SAR (measured) = 0.180 W/kg



0 dB = 0.180 W/kg = -7.45 dBW/kg

#08_LTE Band 5_10M_QPSK_1_25_Right Cheek_Ch20525

Communication System: LTE; Frequency: 836.5 MHz; Duty Cycle: 1:1

Medium: HSL_850_180508 Medium parameters used: $f = 836.5$ MHz; $\sigma = 0.92$ S/m; $\epsilon_r = 41.468$; $\rho = 1000$ kg/m³

Ambient Temperature : 23.3 °C ; Liquid Temperature : 22.3 °C

DASY5 Configuration

- Probe: EX3DV4 - SN7306; ConvF(9.79, 9.79, 9.79); Calibrated: 2017/7/24;
- Sensor-Surface: 1.4mm (Mechanical Surface Detection)
- Electronics: DAE3 Sn577; Calibrated: 2017/9/25
- Phantom: SAM LEFT; Type: QD000P40CD; Serial: TP:1718
- Measurement SW: DASY52, Version 52.8 (8); SEMCAD X Version 14.6.10 (7373)

Area Scan (61x111x1): Interpolated grid: dx=1.500 mm, dy=1.500 mm

Maximum value of SAR (interpolated) = 0.396 W/kg

Zoom Scan (5x5x7)/Cube 0: Measurement grid: dx=8mm, dy=8mm, dz=5mm

Reference Value = 17.73 V/m; Power Drift = -0.14 dB

Peak SAR (extrapolated) = 0.431 W/kg

SAR(1 g) = 0.329 W/kg; SAR(10 g) = 0.247 W/kg

Maximum value of SAR (measured) = 0.388 W/kg

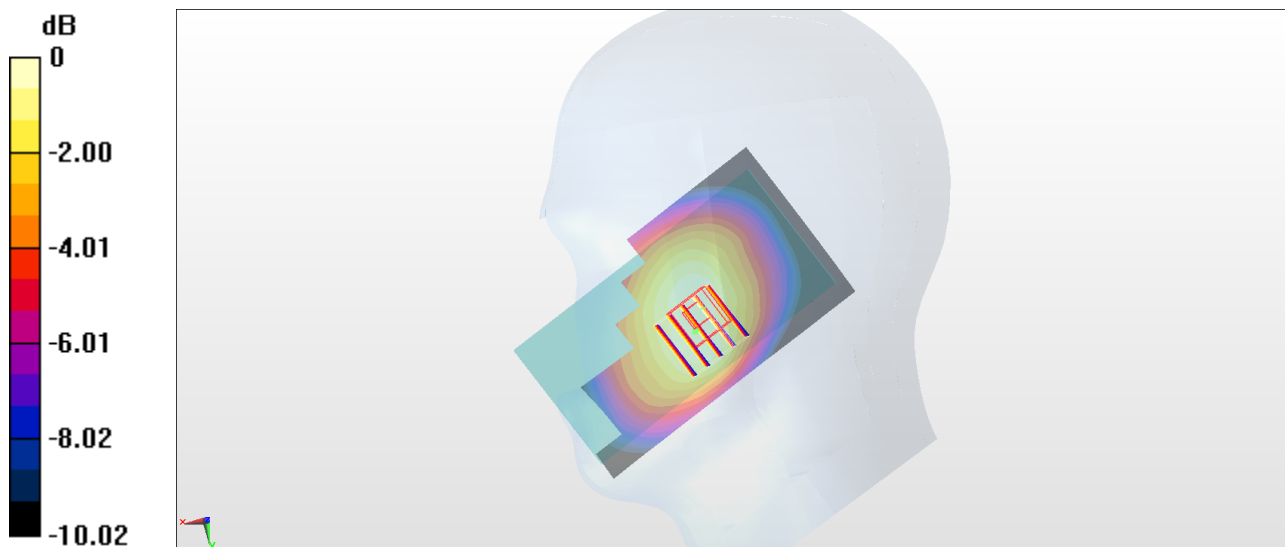

0 dB = 0.388 W/kg = -4.11 dBW/kg

#09_LTE Band 7_20M_QPSK_1_49_Right Cheek_Ch20850

Communication System: LTE; Frequency: 2510 MHz; Duty Cycle: 1:1

Medium: HSL_2600_180510 Medium parameters used: $f = 2510$ MHz; $\sigma = 1.85$ S/m; $\epsilon_r = 38.557$; $\rho = 1000$ kg/m³

Ambient Temperature : 23.4 °C ; Liquid Temperature : 22.4 °C

DASY5 Configuration

- Probe: EX3DV4 - SN3976; ConvF(7.54, 7.54, 7.54); Calibrated: 2018/1/23;
- Sensor-Surface: 1.4mm (Mechanical Surface Detection)
- Electronics: DAE3 Sn495; Calibrated: 2017/5/22
- Phantom: SAM_Right; Type: QD000P40CD; Serial: S/N:1796
- Measurement SW: DASY52, Version 52.10 (0); SEMCAD X Version 14.6.10 (7417)

Area Scan (81x151x1): Interpolated grid: dx=1.200 mm, dy=1.200 mm

Maximum value of SAR (interpolated) = 0.127 W/kg

Zoom Scan (7x7x7)/Cube 0: Measurement grid: dx=5mm, dy=5mm, dz=5mm

Reference Value = 6.279 V/m; Power Drift = -0.04 dB

Peak SAR (extrapolated) = 0.157 W/kg

SAR(1 g) = 0.083 W/kg; SAR(10 g) = 0.044 W/kg

Maximum value of SAR (measured) = 0.130 W/kg

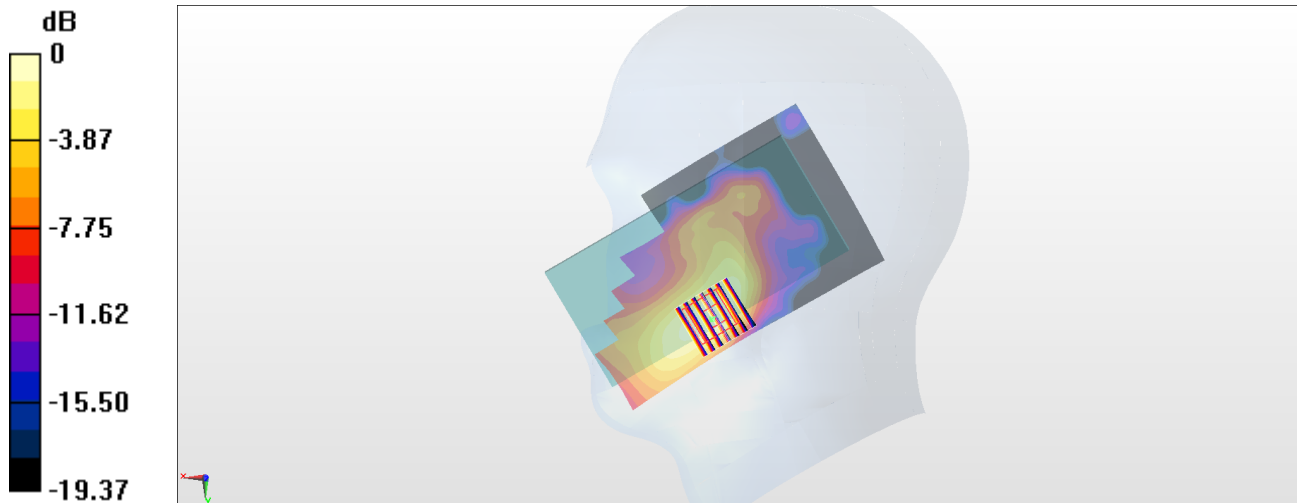

#10_LTE Band 38_20M_QPSK_1_49_Right Cheek_Ch37850

Communication System: LTE ; Frequency: 2580 MHz;Duty Cycle: 1:1.59

Medium: HSL_2600_180512 Medium parameters used: $f = 2580$ MHz; $\sigma = 2$ S/m; $\epsilon_r = 39.448$; $\rho = 1000$ kg/m³

Ambient Temperature : 23.6 °C ; Liquid Temperature : 22.6 °C

DASY5 Configuration:

- Probe: EX3DV4 - SN7306; ConvF(7.36, 7.36, 7.36); Calibrated: 2017/7/24
- Sensor-Surface: 1.4mm (Mechanical Surface Detection)
- Electronics: DAE3 Sn577; Calibrated: 2017/9/25
- Phantom: SAM_Left; Type: QD000P40CD; Serial: TP:1815
- Measurement SW: DASY52, Version 52.10 (1);SEMCAD X Version 14.6.11 (7437)

Area Scan (81x151x1): Interpolated grid: dx=1.200 mm, dy=1.200 mm

Maximum value of SAR (interpolated) = 0.171 W/kg

Zoom Scan (7x7x7)/Cube 0: Measurement grid: dx=5mm, dy=5mm, dz=5mm

Reference Value = 6.064 V/m; Power Drift = 0.18 dB

Peak SAR (extrapolated) = 0.215 W/kg

SAR(1 g) = 0.112 W/kg; SAR(10 g) = 0.058 W/kg

Maximum value of SAR (measured) = 0.174 W/kg

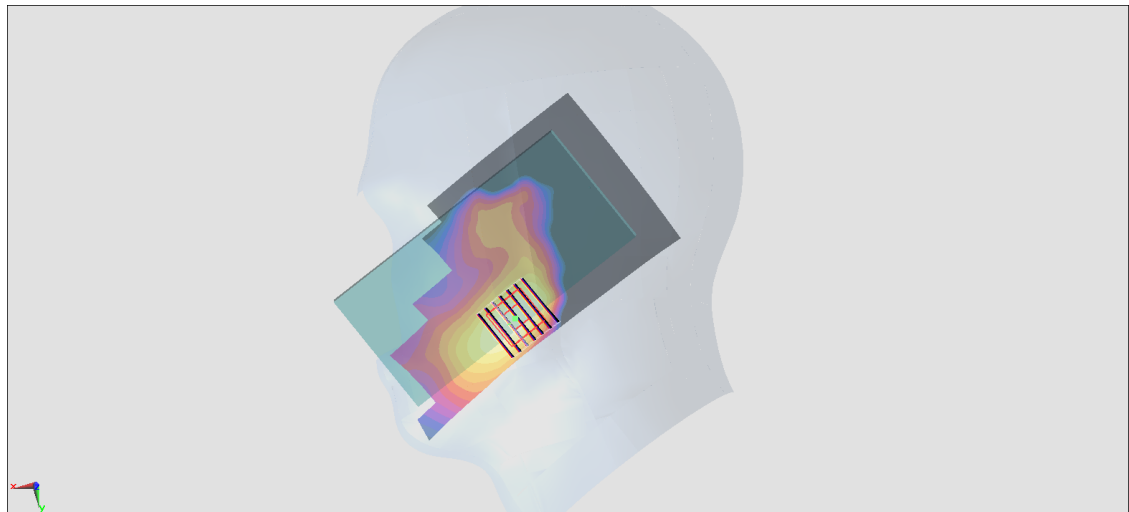
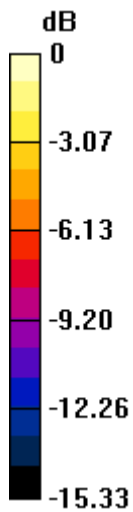

0 dB = 0.174 W/kg = -7.59 dBW/kg

#11_WLAN2.4GHz_802.11b 1Mbps_Left Tilted_Ch6

Communication System: 802.11b; Frequency: 2437 MHz; Duty Cycle: 1:1.007

Medium: HSL_2450_180510 Medium parameters used: $f = 2437$ MHz; $\sigma = 1.775$ S/m; $\epsilon_r = 38.822$; $\rho = 1000$ kg/m³

Ambient Temperature : 23.4 °C ; Liquid Temperature : 22.4 °C

DASY5 Configuration

- Probe: EX3DV4 - SN3976; ConvF(7.75, 7.75, 7.75); Calibrated: 2018/1/23;
- Sensor-Surface: 1.4mm (Mechanical Surface Detection)
- Electronics: DAE3 Sn495; Calibrated: 2017/5/22
- Phantom: SAM_Right; Type: QD000P40CD; Serial: S/N:1796
- Measurement SW: DASY52, Version 52.10 (0); SEMCAD X Version 14.6.10 (7417)

Area Scan (81x71x1): Interpolated grid: dx=1.200 mm, dy=1.200 mm

Maximum value of SAR (interpolated) = 1.12 W/kg

Zoom Scan (7x7x7)/Cube 0: Measurement grid: dx=5mm, dy=5mm, dz=5mm

Reference Value = 17.55 V/m; Power Drift = -0.13 dB

Peak SAR (extrapolated) = 1.33 W/kg

SAR(1 g) = 0.544 W/kg; SAR(10 g) = 0.246 W/kg

Maximum value of SAR (measured) = 0.973 W/kg

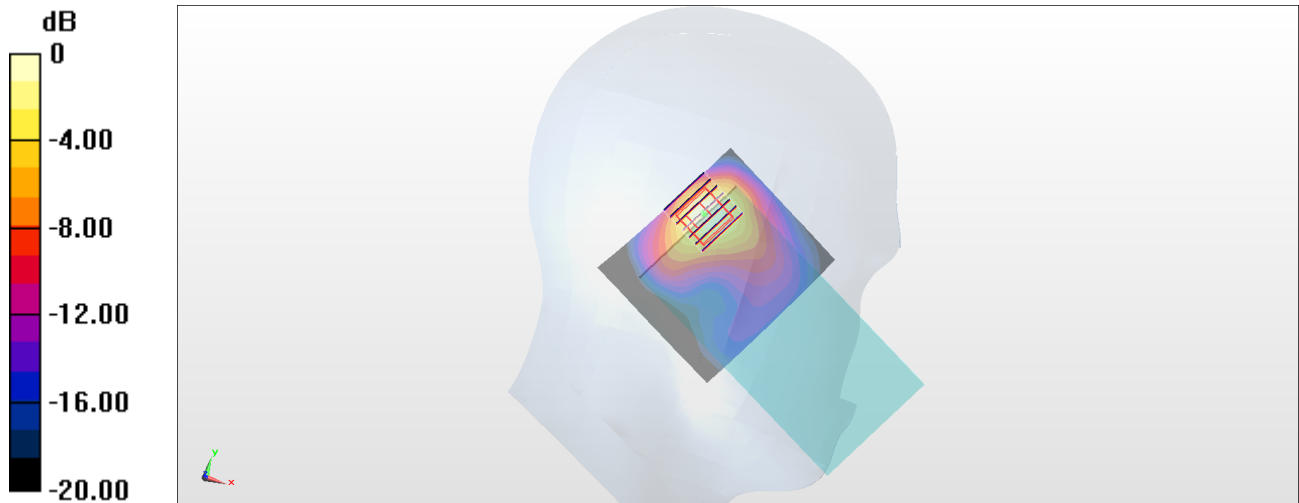

0 dB = 0.973 W/kg = -0.12 dBW/kg

#12_GSM850_GPRS (4 Tx slots)_Left Side_10mm_Ch251

Communication System: GSM850; Frequency: 848.8 MHz; Duty Cycle: 1:2.08

Medium: MSL_850_180506 Medium parameters used: $f = 849$ MHz; $\sigma = 0.988$ S/m; $\epsilon_r = 56.175$; $\rho = 1000$ kg/m³

Ambient Temperature : 23.3 °C; Liquid Temperature : 22.3 °C

DASY5 Configuration

- Probe: EX3DV4 - SN7306; ConvF(9.85, 9.85, 9.85); Calibrated: 2017/7/24;
- Sensor-Surface: 1.4mm (Mechanical Surface Detection)
- Electronics: DAE3 Sn577; Calibrated: 2017/9/25
- Phantom: SAM LEFT; Type: QD000P40CD; Serial: TP:1718
- Measurement SW: DASY52, Version 52.8 (8); SEMCAD X Version 14.6.10 (7373)

Area Scan (31x101x1): Interpolated grid: dx=1.500 mm, dy=1.500 mm

Maximum value of SAR (interpolated) = 0.883 W/kg

Zoom Scan (5x5x7)/Cube 0: Measurement grid: dx=8mm, dy=8mm, dz=5mm

Reference Value = 30.85 V/m; Power Drift = -0.06 dB

Peak SAR (extrapolated) = 0.990 W/kg

SAR(1 g) = 0.669 W/kg; SAR(10 g) = 0.462 W/kg

Maximum value of SAR (measured) = 0.877 W/kg

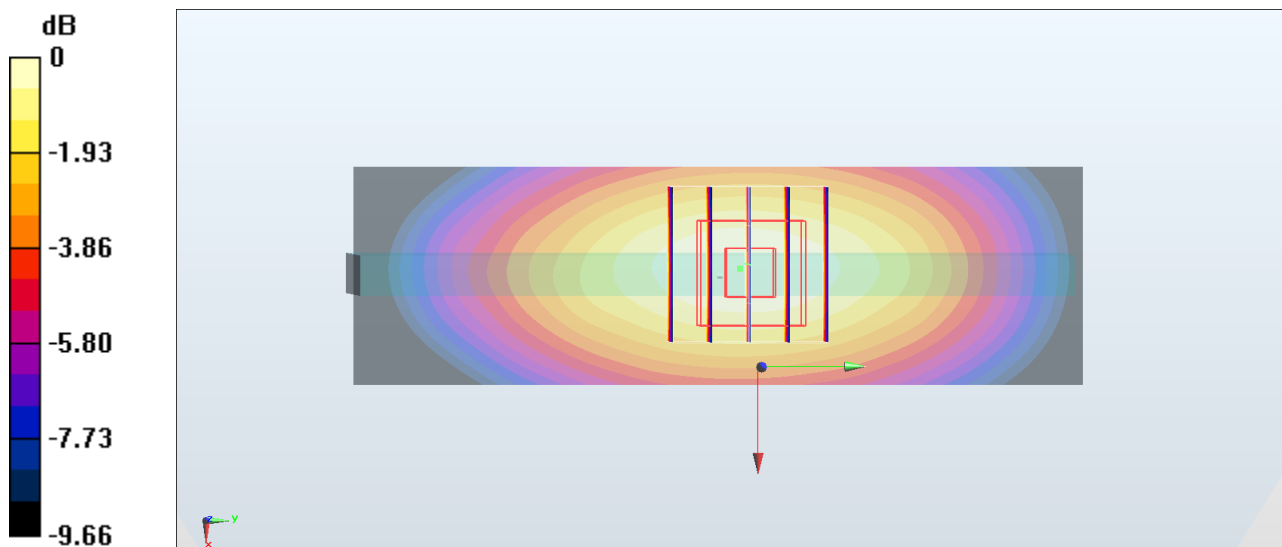

0 dB = 0.877 W/kg = -0.57 dBW/kg

#13_GSM1900_GPRS (4 Tx slots)_Bottom Side_10mm_Ch661

Communication System: PCS ; Frequency: 1880 MHz;Duty Cycle: 1:2.08

Medium: MSL_1900_180505 Medium parameters used: $f = 1880$ MHz; $\sigma = 1.532$ S/m; $\epsilon_r = 51.834$; $\rho = 1000$ kg/m³

Ambient Temperature : 23.7 °C ; Liquid Temperature : 22.7 °C

DASY5 Configuration

- Probe: EX3DV4 - SN7306; ConvF(7.98, 7.98, 7.98); Calibrated: 2017/7/24;
- Sensor-Surface: 1.4mm (Mechanical Surface Detection)
- Electronics: DAE3 Sn577; Calibrated: 2017/9/25
- Phantom: SAM LEFT; Type: QD000P40CD; Serial: TP:1718
- Measurement SW: DASY52, Version 52.8 (8); SEMCAD X Version 14.6.10 (7373)

Area Scan (41x61x1): Interpolated grid: dx=1.500 mm, dy=1.500 mm

Maximum value of SAR (interpolated) = 1.48 W/kg

Zoom Scan (5x5x7)/Cube 0: Measurement grid: dx=8mm, dy=8mm, dz=5mm

Reference Value = 28.14 V/m; Power Drift = 0.07 dB

Peak SAR (extrapolated) = 1.63 W/kg

SAR(1 g) = 0.964 W/kg; SAR(10 g) = 0.506 W/kg

Maximum value of SAR (measured) = 1.41 W/kg

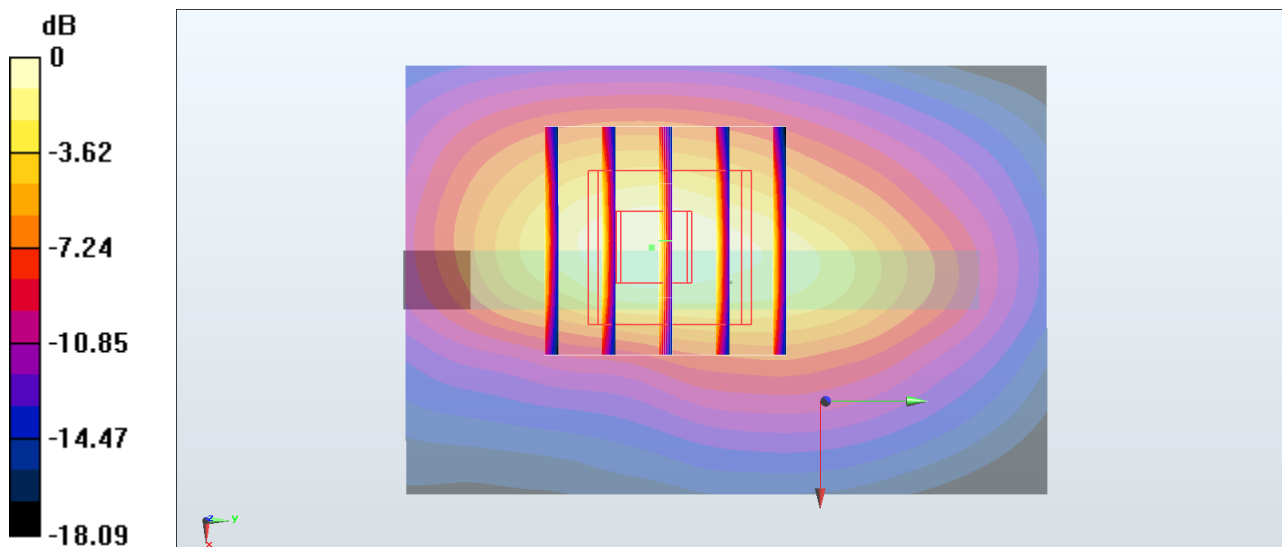

0 dB = 1.41 W/kg = 1.49 dBW/kg

#14_WCDMA II_RMC 12.2Kbps_Bottom Side_10mm_Ch9538

Communication System: WCDMA ; Frequency: 1907.6 MHz; Duty Cycle: 1:1

Medium: MSL_1900_180505 Medium parameters used: $f = 1908$ MHz; $\sigma = 1.563$ S/m; $\epsilon_r = 51.717$; $\rho = 1000$ kg/m³

Ambient Temperature : 23.7 °C ; Liquid Temperature : 22.7 °C

DASY5 Configuration

- Probe: EX3DV4 - SN7306; ConvF(7.98, 7.98, 7.98); Calibrated: 2017/7/24;
- Sensor-Surface: 1.4mm (Mechanical Surface Detection)
- Electronics: DAE3 Sn577; Calibrated: 2017/9/25
- Phantom: SAM LEFT; Type: QD000P40CD; Serial: TP:1718
- Measurement SW: DASY52, Version 52.8 (8); SEMCAD X Version 14.6.10 (7373)

Area Scan (41x61x1): Interpolated grid: dx=1.500 mm, dy=1.500 mm

Maximum value of SAR (interpolated) = 1.08 W/kg

Zoom Scan (5x5x7)/Cube 0: Measurement grid: dx=8mm, dy=8mm, dz=5mm

Reference Value = 24.59 V/m; Power Drift = 0.09 dB

Peak SAR (extrapolated) = 1.22 W/kg

SAR(1 g) = 0.715 W/kg; SAR(10 g) = 0.375 W/kg

Maximum value of SAR (measured) = 1.03 W/kg

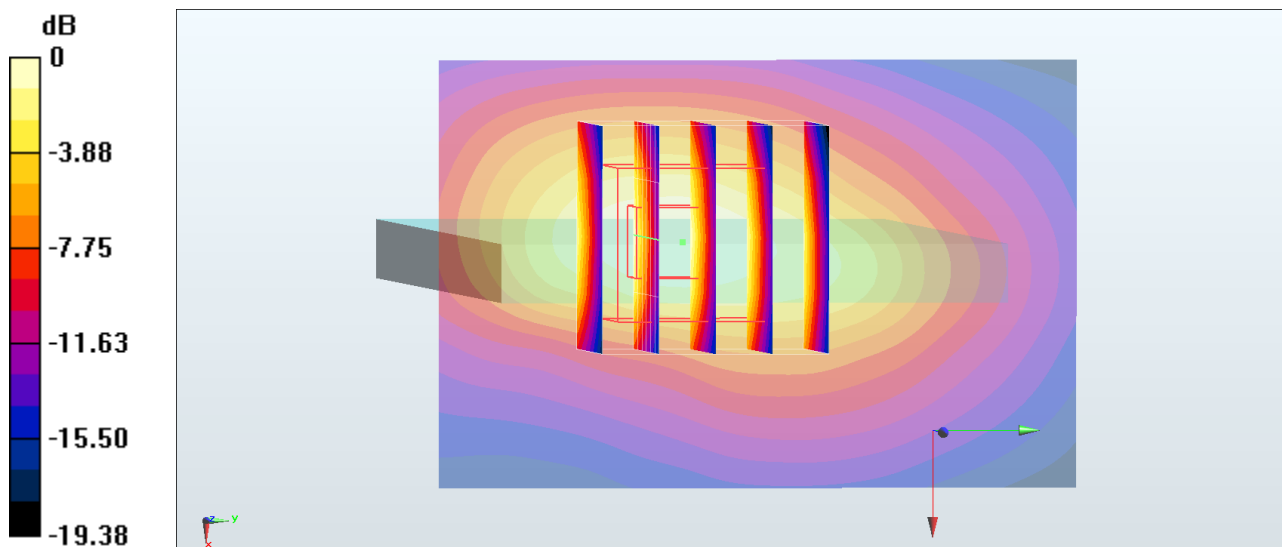

0 dB = 1.03 W/kg = 0.13 dBW/kg

#15_WCDMA_IV_RMC_12.2Kbps_Bottom_Side_10mm_Ch1312

Communication System: WCDMA; Frequency: 1712.4 MHz; Duty Cycle: 1:1
Medium: MSL_1750_180523 Medium parameters used : $f = 1712.4$ MHz; $\sigma = 1.425$ S/m; $\epsilon_r = 55.155$; $\rho = 1000$ kg/m³
Ambient Temperature : 23.3 °C; Liquid Temperature : 22.3 °C

DASY5 Configuration:

- Probe: EX3DV4 - SN7306; ConvF(8.29, 8.29, 8.29); Calibrated: 2017/7/24;
- Sensor-Surface: 1.4mm (Mechanical Surface Detection)
- Electronics: DAE3 Sn577; Calibrated: 2017/9/25
- Phantom: SAM_Left; Type: QD000P40CD; Serial: TP:1431
- Measurement SW: DASY52, Version 52.10 (0); SEMCAD X Version 14.6.10 (7417)

Area Scan (41x61x1): Interpolated grid: dx=1.500 mm, dy=1.500 mm
Maximum value of SAR (interpolated) = 1.63 W/kg

Zoom Scan (5x5x7)/Cube 0: Measurement grid: dx=8mm, dy=8mm, dz=5mm
Reference Value = 36.08 V/m; Power Drift = -0.00 dB
Peak SAR (extrapolated) = 1.89 W/kg
SAR(1 g) = 1.06 W/kg; SAR(10 g) = 0.603 W/kg
Maximum value of SAR (measured) = 1.53 W/kg

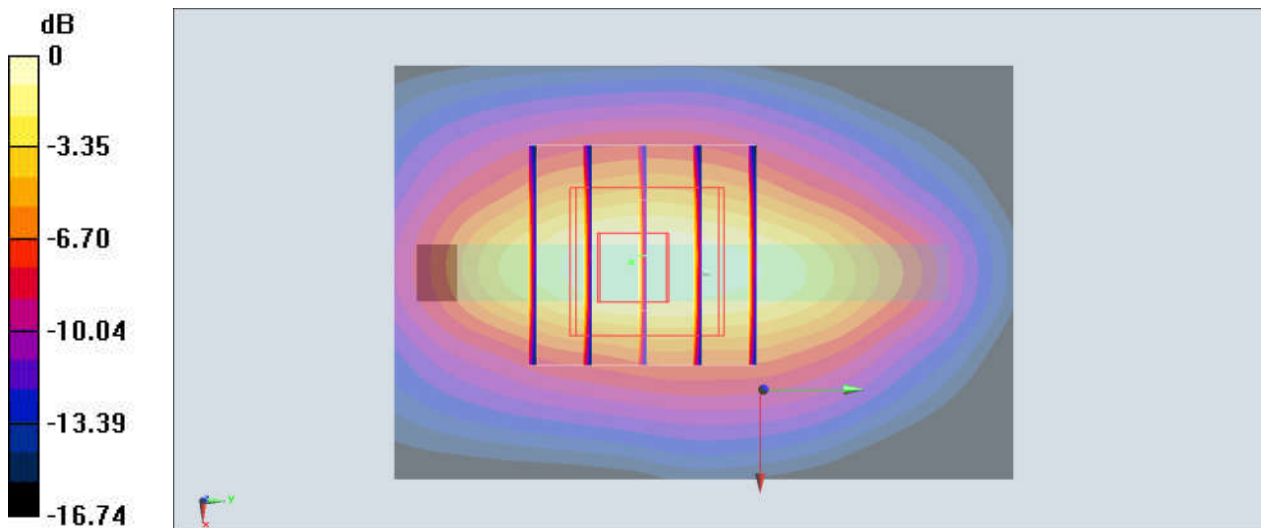

0 dB = 1.53 W/kg = 1.85 dBW/kg

#16_WCDMA V_RMC 12.2Kbps_Left Side_10mm_Ch4182

Communication System: WCDMA; Frequency: 836.4 MHz; Duty Cycle: 1:1

Medium: MSL_850_180506 Medium parameters used: $f = 836.4$ MHz; $\sigma = 0.977$ S/m; $\epsilon_r = 56.287$; $\rho = 1000$ kg/m³

Ambient Temperature : 23.3 °C ; Liquid Temperature : 22.3 °C

DASY5 Configuration

- Probe: EX3DV4 - SN7306; ConvF(9.85, 9.85, 9.85); Calibrated: 2017/7/24;
- Sensor-Surface: 1.4mm (Mechanical Surface Detection)
- Electronics: DAE3 Sn577; Calibrated: 2017/9/25
- Phantom: SAM LEFT; Type: QD000P40CD; Serial: TP:1718
- Measurement SW: DASY52, Version 52.8 (8); SEMCAD X Version 14.6.10 (7373)

Area Scan (31x101x1): Interpolated grid: dx=1.500 mm, dy=1.500 mm

Maximum value of SAR (interpolated) = 0.611 W/kg

Zoom Scan (5x5x7)/Cube 0: Measurement grid: dx=8mm, dy=8mm, dz=5mm

Reference Value = 25.56 V/m; Power Drift = 0.02 dB

Peak SAR (extrapolated) = 0.680 W/kg

SAR(1 g) = 0.469 W/kg; SAR(10 g) = 0.325 W/kg

Maximum value of SAR (measured) = 0.603 W/kg

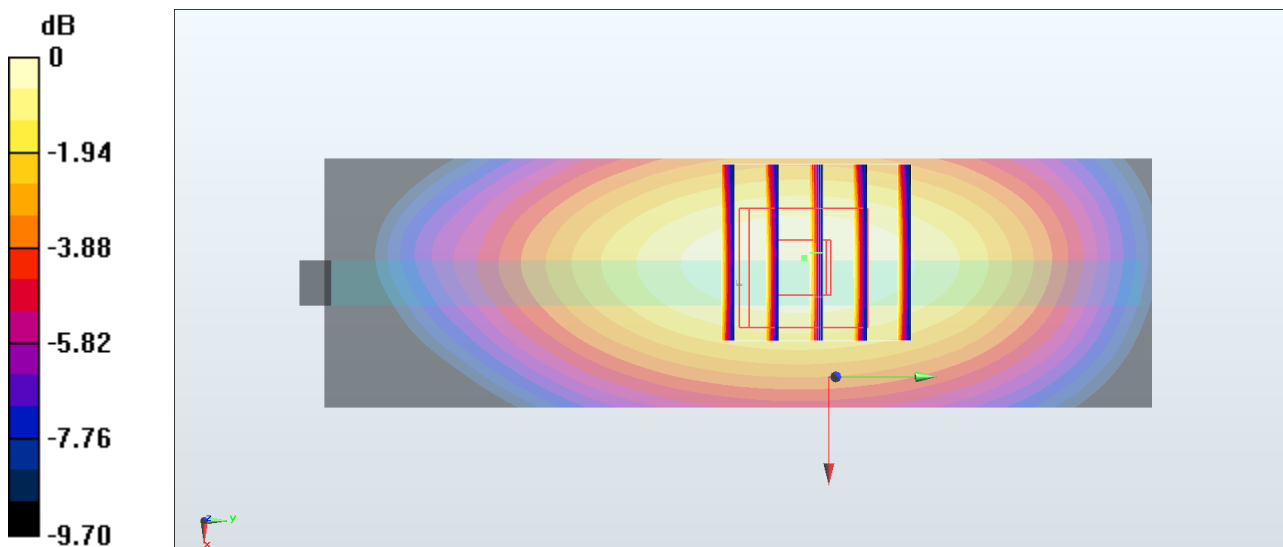

0 dB = 0.603 W/kg = -2.20 dBW/kg

#17_LTE Band 2_20M_QPSK_1_49_Bottom Side_10mm_Ch18700

Communication System: LTE ; Frequency: 1860 MHz;Duty Cycle: 1:1

Medium: MSL_1900_180505 Medium parameters used: $f = 1860$ MHz; $\sigma = 1.51$ S/m; $\epsilon_r = 51.893$; $\rho = 1000$ kg/m³

Ambient Temperature : 23.7 °C ; Liquid Temperature : 22.7 °C

DASY5 Configuration

- Probe: EX3DV4 - SN7306; ConvF(7.98, 7.98, 7.98); Calibrated: 2017/7/24;
- Sensor-Surface: 1.4mm (Mechanical Surface Detection)
- Electronics: DAE3 Sn577; Calibrated: 2017/9/25
- Phantom: SAM LEFT; Type: QD000P40CD; Serial: TP:1718
- Measurement SW: DASY52, Version 52.8 (8); SEMCAD X Version 14.6.10 (7373)

Area Scan (41x61x1): Interpolated grid: dx=1.500 mm, dy=1.500 mm

Maximum value of SAR (interpolated) = 1.35 W/kg

Zoom Scan (5x5x7)/Cube 0: Measurement grid: dx=8mm, dy=8mm, dz=5mm

Reference Value = 27.54 V/m; Power Drift = 0.03 dB

Peak SAR (extrapolated) = 1.52 W/kg

SAR(1 g) = 0.895 W/kg; SAR(10 g) = 0.470 W/kg

Maximum value of SAR (measured) = 1.32 W/kg

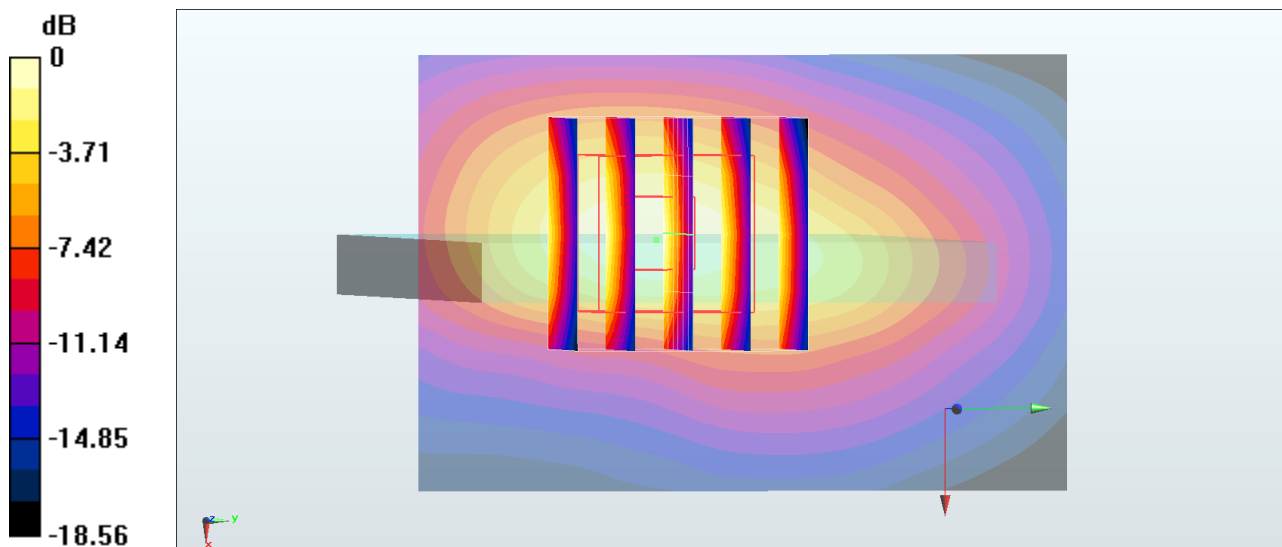

#18_LTE Band 4_20M_QPSK_1_49_Bottom Side_10mm_Ch20175

Communication System: LTE ; Frequency: 1732.5 MHz;Duty Cycle: 1:1

Medium: MSL_1750_180505 Medium parameters used : $f = 1732.5$ MHz; $\sigma = 1.473$ S/m; $\epsilon_r = 52.696$; $\rho = 1000$ kg/m³

Ambient Temperature : 23.5 °C ; Liquid Temperature : 22.5 °C

DASY5 Configuration

- Probe: EX3DV4 - SN7306; ConvF(8.29, 8.29, 8.29); Calibrated: 2017/7/24;
- Sensor-Surface: 1.4mm (Mechanical Surface Detection)
- Electronics: DAE3 Sn577; Calibrated: 2017/9/25
- Phantom: SAM LEFT; Type: QD000P40CD; Serial: TP:1718
- Measurement SW: DASY52, Version 52.8 (8); SEMCAD X Version 14.6.10 (7373)

Area Scan (41x61x1): Interpolated grid: dx=1.500 mm, dy=1.500 mm

Maximum value of SAR (interpolated) = 1.49 W/kg

Zoom Scan (5x5x7)/Cube 0: Measurement grid: dx=8mm, dy=8mm, dz=5mm

Reference Value = 28.09 V/m; Power Drift = 0.17 dB

Peak SAR (extrapolated) = 1.57 W/kg

SAR(1 g) = 0.953 W/kg; SAR(10 g) = 0.519 W/kg

Maximum value of SAR (measured) = 1.34 W/kg

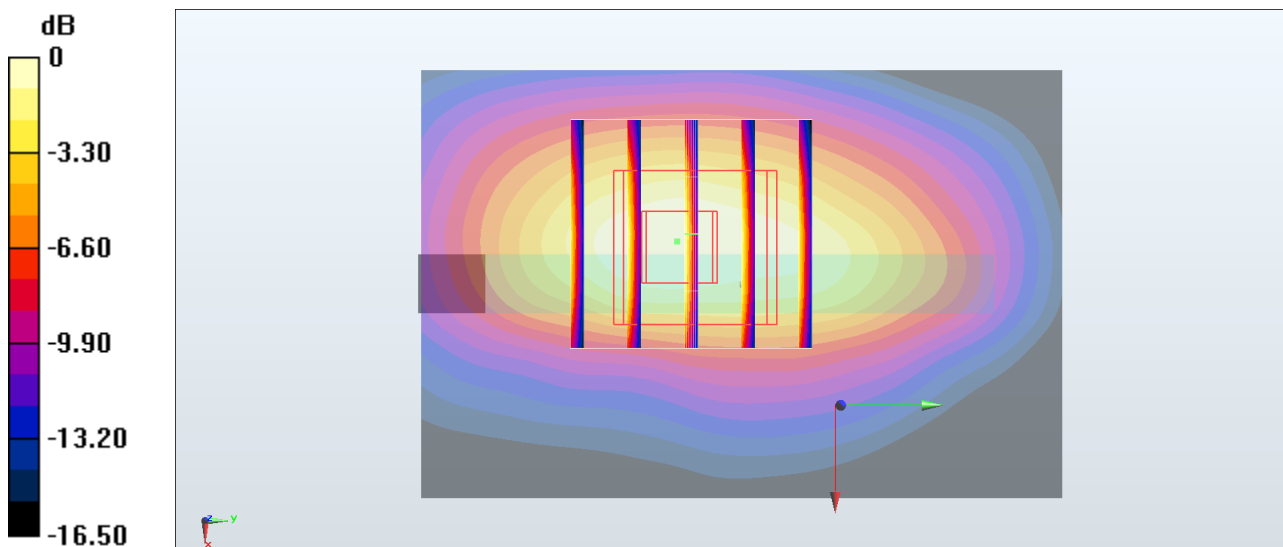

0 dB = 1.34 W/kg = 1.27 dBW/kg

#19_LTE Band 5_10M_QPSK_1_25_Left Side_10mm_Ch20525

Communication System: LTE; Frequency: 836.5 MHz; Duty Cycle: 1:1

Medium: MSL_850_180506 Medium parameters used: $f = 836.5$ MHz; $\sigma = 0.977$ S/m; $\epsilon_r = 56.286$; $\rho = 1000$ kg/m³

Ambient Temperature : 23.3 °C ; Liquid Temperature : 22.3 °C

DASY5 Configuration

- Probe: EX3DV4 - SN7306; ConvF(9.85, 9.85, 9.85); Calibrated: 2017/7/24;
- Sensor-Surface: 1.4mm (Mechanical Surface Detection)
- Electronics: DAE3 Sn577; Calibrated: 2017/9/25
- Phantom: SAM LEFT; Type: QD000P40CD; Serial: TP:1718
- Measurement SW: DASY52, Version 52.8 (8); SEMCAD X Version 14.6.10 (7373)

Area Scan (31x101x1): Interpolated grid: dx=1.500 mm, dy=1.500 mm

Maximum value of SAR (interpolated) = 0.604 W/kg

Zoom Scan (5x5x7)/Cube 0: Measurement grid: dx=8mm, dy=8mm, dz=5mm

Reference Value = 25.78 V/m; Power Drift = 0.02 dB

Peak SAR (extrapolated) = 0.679 W/kg

SAR(1 g) = 0.467 W/kg; SAR(10 g) = 0.322 W/kg

Maximum value of SAR (measured) = 0.600 W/kg

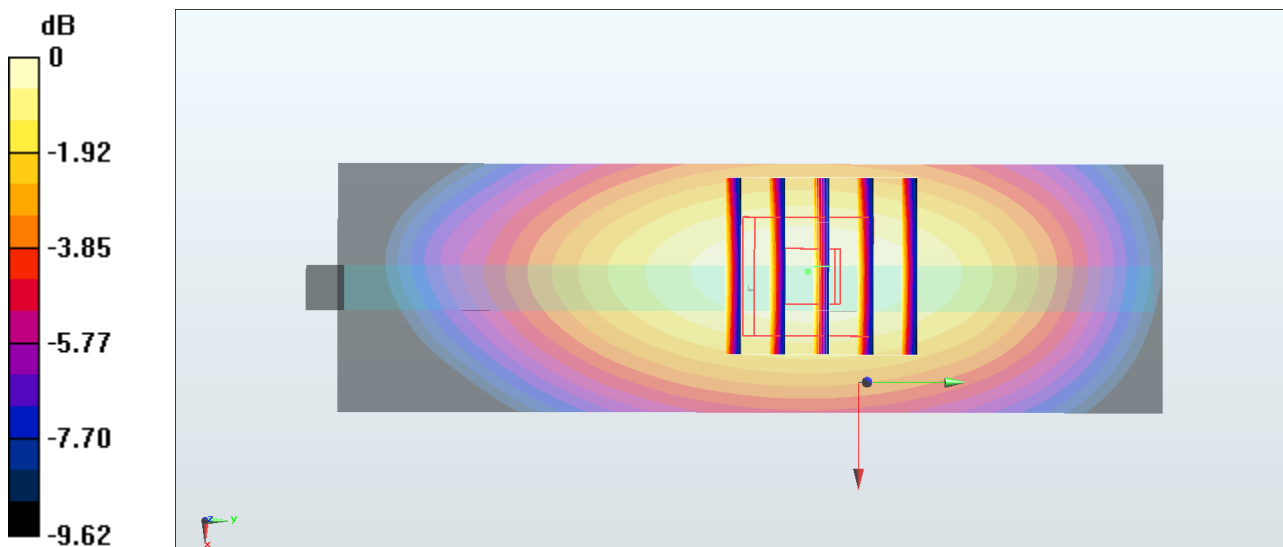

0 dB = 0.600 W/kg = -2.22 dBW/kg

#20_LTE Band 7_20M_QPSK_1_49_Back_10mm_Ch21100

Communication System: LTE; Frequency: 2535 MHz; Duty Cycle: 1:1

Medium: MSL_2600_180506 Medium parameters used: $f = 2535$ MHz; $\sigma = 2.084$ S/m; $\epsilon_r = 50.762$; $\rho = 1000$ kg/m³

Ambient Temperature : 23.4 °C ; Liquid Temperature : 22.4 °C

DASY5 Configuration

- Probe: EX3DV4 - SN7306; ConvF(7.46, 7.46, 7.46); Calibrated: 2017/7/24;
- Sensor-Surface: 1.4mm (Mechanical Surface Detection)
- Electronics: DAE3 Sn577; Calibrated: 2017/9/25
- Phantom: SAM LEFT; Type: QD000P40CD; Serial: TP:1718
- Measurement SW: DASY52, Version 52.8 (8); SEMCAD X Version 14.6.10 (7373)

Area Scan (81x81x1): Interpolated grid: dx=1.200 mm, dy=1.200 mm

Maximum value of SAR (interpolated) = 1.72 W/kg

Zoom Scan (7x7x7)/Cube 0: Measurement grid: dx=5mm, dy=5mm, dz=5mm

Reference Value = 6.720 V/m; Power Drift = -0.03 dB

Peak SAR (extrapolated) = 2.19 W/kg

SAR(1 g) = 1.06 W/kg; SAR(10 g) = 0.470 W/kg

Maximum value of SAR (measured) = 1.77 W/kg

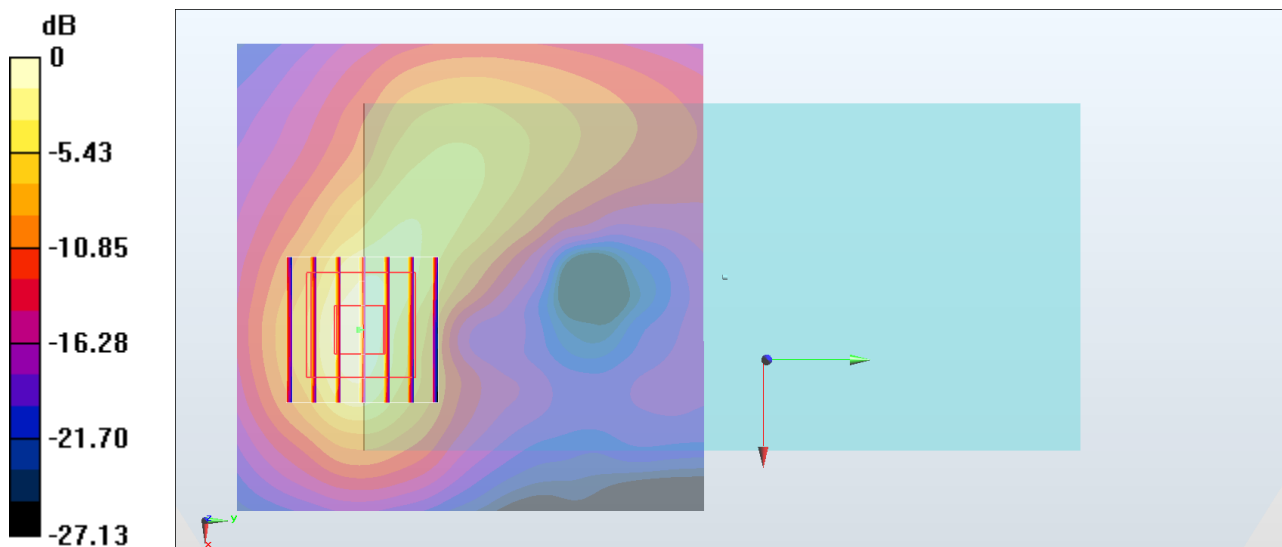

0 dB = 1.77 W/kg = 2.48 dBW/kg

#21_LTE Band 38_20M_QPSK_1_49_Back_10mm_Ch37850

Communication System: LTE ; Frequency: 2580 MHz;Duty Cycle: 1:1.59

Medium: MSL_2600_180512 Medium parameters used: $f = 2580$ MHz; $\sigma = 2.172$ S/m; $\epsilon_r = 51.886$; $\rho = 1000$ kg/m³

Ambient Temperature : 23.6 °C ; Liquid Temperature : 22.6 °C

DASY5 Configuration:

- Probe: EX3DV4 - SN7306; ConvF(7.46, 7.46, 7.46); Calibrated: 2017/7/24
- Sensor-Surface: 1.4mm (Mechanical Surface Detection)
- Electronics: DAE3 Sn577; Calibrated: 2017/9/25
- Phantom: SAM_Right; Type: QD000P40CD; Serial: 1719
- Measurement SW: DASY52, Version 52.10 (1);SEMCAD X Version 14.6.11 (7437)

Area Scan (81x81x1): Interpolated grid: dx=1.200 mm, dy=1.200 mm

Maximum value of SAR (interpolated) = 1.42 W/kg

Zoom Scan (7x7x7)/Cube 0: Measurement grid: dx=5mm, dy=5mm, dz=5mm

Reference Value = 16.34 V/m; Power Drift = 0.04 dB

Peak SAR (extrapolated) = 1.76 W/kg

SAR(1 g) = 0.843 W/kg; SAR(10 g) = 0.376 W/kg

Maximum value of SAR (measured) = 1.32 W/kg

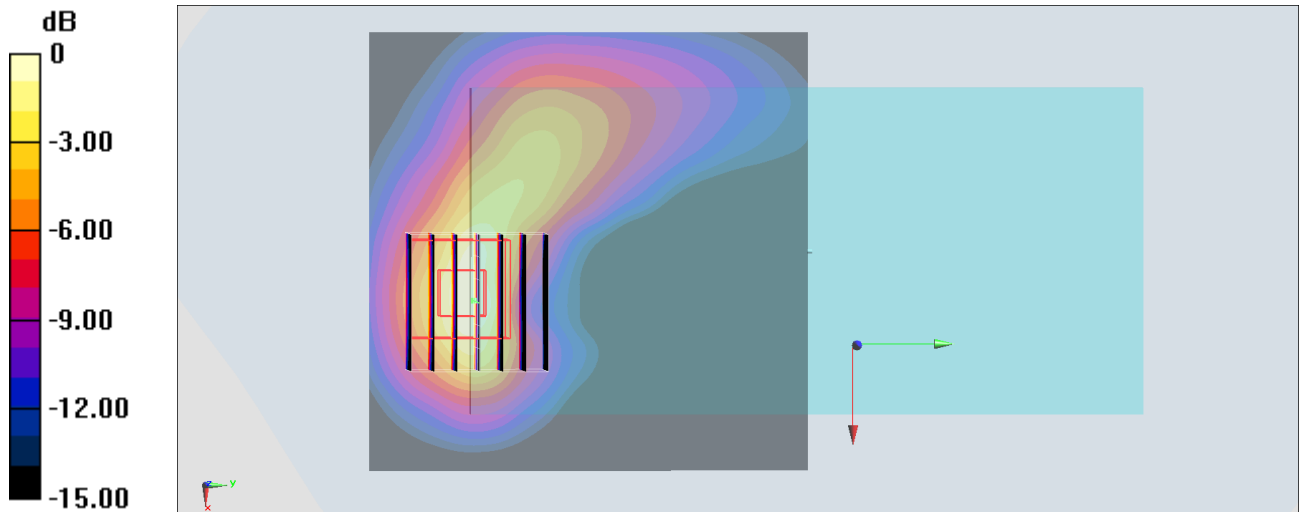

0 dB = 1.32 W/kg = 1.21 dBW/kg

#22_WLAN2.4GHz_802.11b 1Mbps_Back_10mm_Ch6

Communication System: 802.11b; Frequency: 2437 MHz; Duty Cycle: 1:1.007

Medium: MSL_2450_180510 Medium parameters used: $f = 2437$ MHz; $\sigma = 1.921$ S/m; $\epsilon_r = 53.325$; $\rho = 1000$ kg/m³

Ambient Temperature : 23.4 °C ; Liquid Temperature : 22.4 °C

DASY5 Configuration

- Probe: EX3DV4 - SN3976; ConvF(7.8, 7.8, 7.8); Calibrated: 2018/1/23;
- Sensor-Surface: 1.4mm (Mechanical Surface Detection)
- Electronics: DAE3 Sn495; Calibrated: 2017/5/22
- Phantom: SAM_Left; Type: QD000P40CD; Serial: S/N:1801
- Measurement SW: DASY52, Version 52.10 (0); SEMCAD X Version 14.6.10 (7417)

Area Scan (81x101x1): Interpolated grid: dx=1.200 mm, dy=1.200 mm

Maximum value of SAR (interpolated) = 0.257 W/kg

Zoom Scan (7x8x7)/Cube 0: Measurement grid: dx=5mm, dy=5mm, dz=5mm

Reference Value = 11.16 V/m; Power Drift = -0.01 dB

Peak SAR (extrapolated) = 0.316 W/kg

SAR(1 g) = 0.155 W/kg; SAR(10 g) = 0.082 W/kg

Maximum value of SAR (measured) = 0.250 W/kg

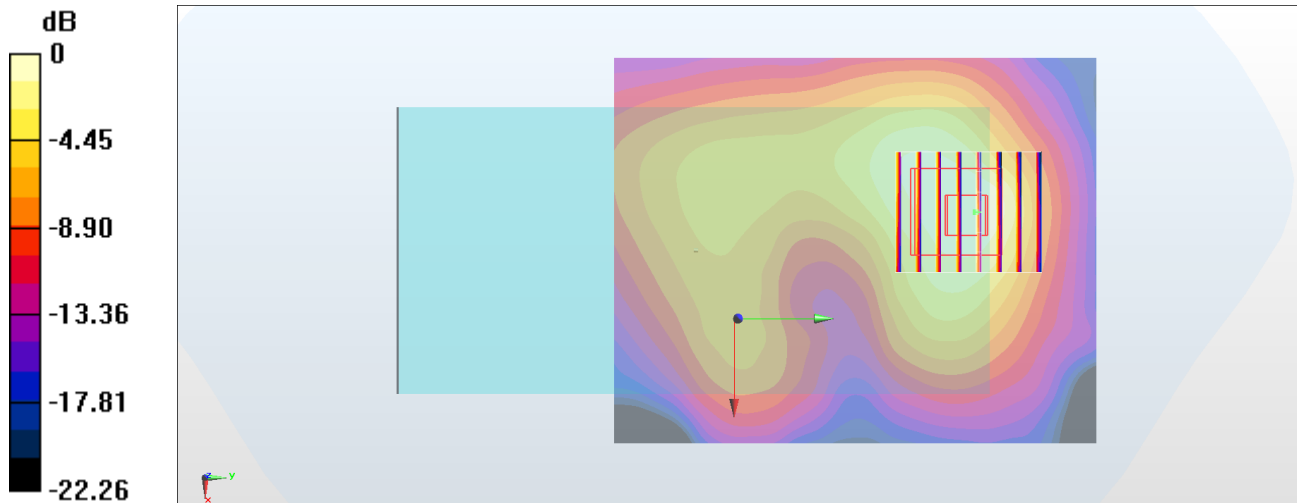

0 dB = 0.250 W/kg = -6.02 dBW/kg

#23_GSM850_GPRS (4 Tx slots)_Back_10mm_Ch251

Communication System: GSM850; Frequency: 848.8 MHz; Duty Cycle: 1:2.08

Medium: MSL_850_180506 Medium parameters used: $f = 849$ MHz; $\sigma = 0.988$ S/m; $\epsilon_r = 56.175$; $\rho = 1000$ kg/m³

Ambient Temperature : 23.3 °C ; Liquid Temperature : 22.3 °C

DASY5 Configuration

- Probe: EX3DV4 - SN7306; ConvF(9.85, 9.85, 9.85); Calibrated: 2017/7/24;
- Sensor-Surface: 1.4mm (Mechanical Surface Detection)
- Electronics: DAE3 Sn577; Calibrated: 2017/9/25
- Phantom: SAM LEFT; Type: QD000P40CD; Serial: TP:1718
- Measurement SW: DASY52, Version 52.8 (8); SEMCAD X Version 14.6.10 (7373)

Area Scan (61x121x1): Interpolated grid: dx=1.500 mm, dy=1.500 mm

Maximum value of SAR (interpolated) = 0.770 W/kg

Zoom Scan (5x5x7)/Cube 0: Measurement grid: dx=8mm, dy=8mm, dz=5mm

Reference Value = 28.49 V/m; Power Drift = -0.06 dB

Peak SAR (extrapolated) = 0.831 W/kg

SAR(1 g) = 0.640 W/kg; SAR(10 g) = 0.492 W/kg

Maximum value of SAR (measured) = 0.768 W/kg

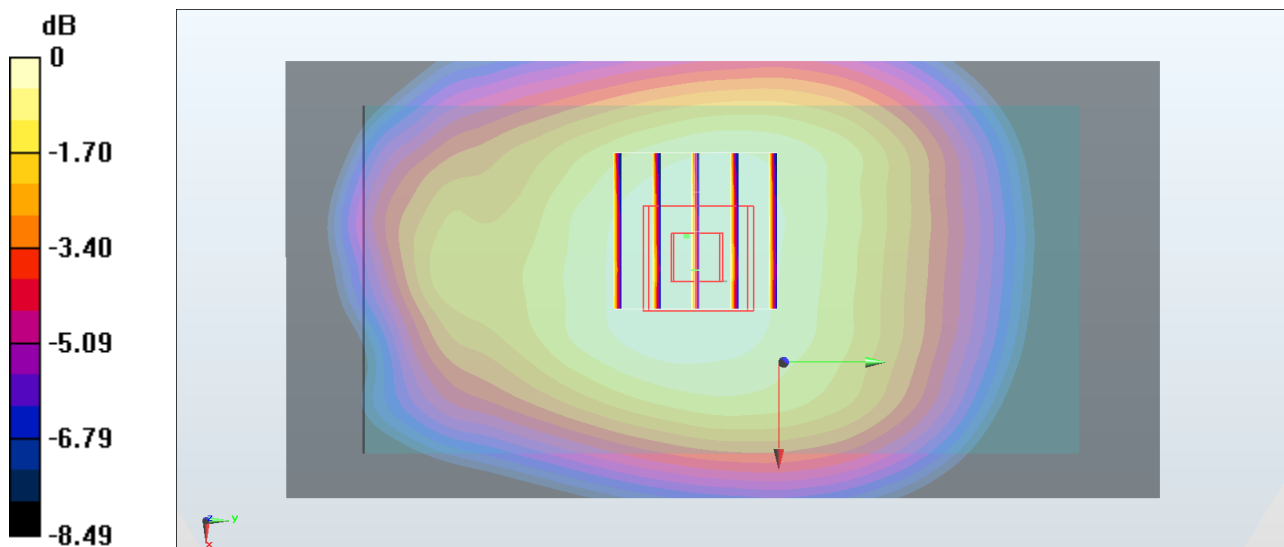

0 dB = 0.768 W/kg = -1.15 dBW/kg

#24_GSM1900_GPRS (4 Tx slots)_Back_10mm_Ch810

Communication System: PCS ; Frequency: 1909.8 MHz;Duty Cycle: 1:2.08

Medium: MSL_1900_180505 Medium parameters used: $f = 1910$ MHz; $\sigma = 1.566$ S/m; $\epsilon_r = 51.709$; $\rho = 1000$ kg/m³

Ambient Temperature : 23.7 °C ; Liquid Temperature : 22.7 °C

DASY5 Configuration

- Probe: EX3DV4 - SN7306; ConvF(7.98, 7.98, 7.98); Calibrated: 2017/7/24;
- Sensor-Surface: 1.4mm (Mechanical Surface Detection)
- Electronics: DAE3 Sn577; Calibrated: 2017/9/25
- Phantom: SAM LEFT; Type: QD000P40CD; Serial: TP:1718
- Measurement SW: DASY52, Version 52.8 (8); SEMCAD X Version 14.6.10 (7373)

Area Scan (61x61x1): Interpolated grid: dx=1.500 mm, dy=1.500 mm

Maximum value of SAR (interpolated) = 1.06 W/kg

Zoom Scan (5x5x7)/Cube 0: Measurement grid: dx=8mm, dy=8mm, dz=5mm

Reference Value = 18.30 V/m; Power Drift = 0.11 dB

Peak SAR (extrapolated) = 1.61 W/kg

SAR(1 g) = 0.910 W/kg; SAR(10 g) = 0.456 W/kg

Maximum value of SAR (measured) = 1.31 W/kg

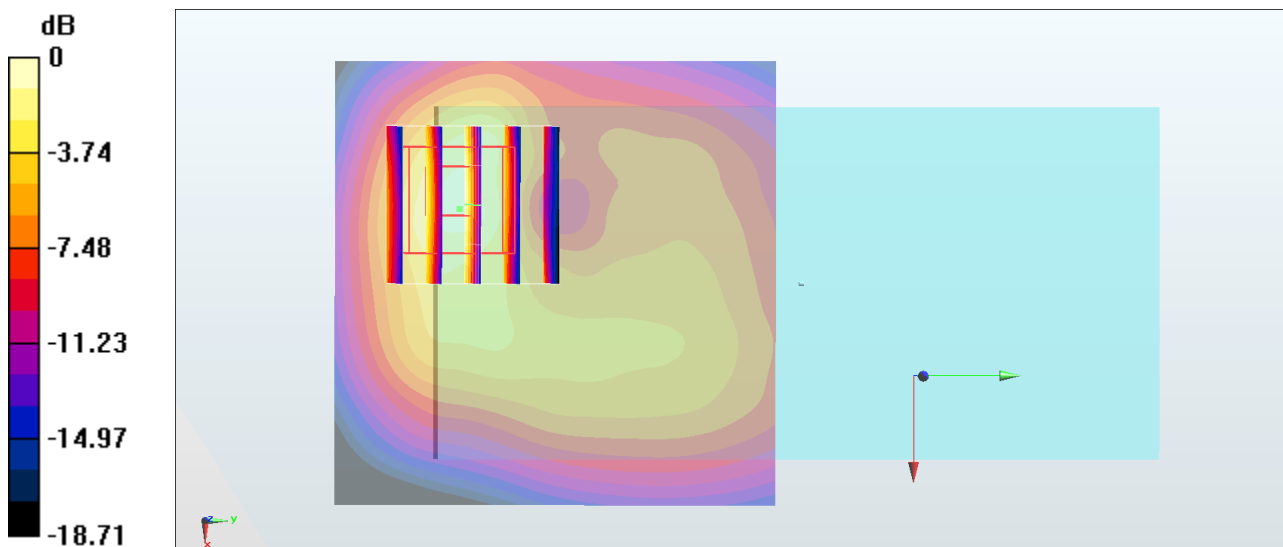

0 dB = 1.31 W/kg = 1.17 dBW/kg

#25_WCDMA II_RMC 12.2Kbps_Back_10mm_Ch9538

Communication System: WCDMA ; Frequency: 1907.6 MHz; Duty Cycle: 1:1

Medium: MSL_1900_180505 Medium parameters used: $f = 1908$ MHz; $\sigma = 1.563$ S/m; $\epsilon_r = 51.717$; $\rho = 1000$ kg/m³

Ambient Temperature : 23.7 °C ; Liquid Temperature : 22.7 °C

DASY5 Configuration

- Probe: EX3DV4 - SN7306; ConvF(7.98, 7.98, 7.98); Calibrated: 2017/7/24;
- Sensor-Surface: 1.4mm (Mechanical Surface Detection)
- Electronics: DAE3 Sn577; Calibrated: 2017/9/25
- Phantom: SAM LEFT; Type: QD000P40CD; Serial: TP:1718
- Measurement SW: DASY52, Version 52.8 (8); SEMCAD X Version 14.6.10 (7373)

Area Scan (61x61x1): Interpolated grid: dx=1.500 mm, dy=1.500 mm

Maximum value of SAR (interpolated) = 0.785 W/kg

Zoom Scan (5x5x7)/Cube 0: Measurement grid: dx=8mm, dy=8mm, dz=5mm

Reference Value = 15.80 V/m; Power Drift = 0.09 dB

Peak SAR (extrapolated) = 1.08 W/kg

SAR(1 g) = 0.617 W/kg; SAR(10 g) = 0.311 W/kg

Maximum value of SAR (measured) = 0.886 W/kg

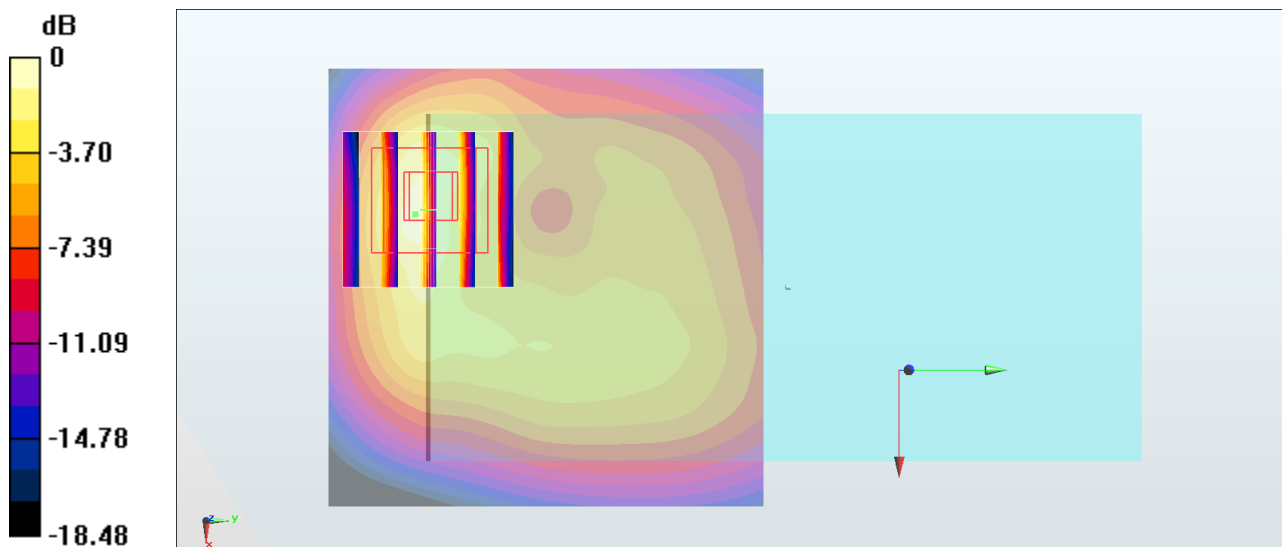

0 dB = 0.886 W/kg = -0.53 dBW/kg

#26_WCDMA_IV_RMC_12.2Kbps_Back_10mm_Ch1312

Communication System: WCDMA; Frequency: 1712.4 MHz; Duty Cycle: 1:1
Medium: MSL_1750_180523 Medium parameters used : $f = 1712.4$ MHz; $\sigma = 1.425$ S/m; $\epsilon_r = 55.155$; $\rho = 1000$ kg/m³
Ambient Temperature : 23.3 °C; Liquid Temperature : 22.3 °C

DASY5 Configuration:

- Probe: EX3DV4 - SN7306; ConvF(8.29, 8.29, 8.29); Calibrated: 2017/7/24;
- Sensor-Surface: 1.4mm (Mechanical Surface Detection)
- Electronics: DAE3 Sn577; Calibrated: 2017/9/25
- Phantom: SAM_Left; Type: QD000P40CD; Serial: TP:1431
- Measurement SW: DASY52, Version 52.10 (0); SEMCAD X Version 14.6.10 (7417)

Area Scan (61x61x1): Interpolated grid: dx=1.500 mm, dy=1.500 mm
Maximum value of SAR (interpolated) = 1.51 W/kg

Zoom Scan (5x5x7)/Cube 0: Measurement grid: dx=8mm, dy=8mm, dz=5mm
Reference Value = 25.89 V/m; Power Drift = -0.01 dB
Peak SAR (extrapolated) = 1.84 W/kg
SAR(1 g) = 1.02 W/kg; SAR(10 g) = 0.531 W/kg
Maximum value of SAR (measured) = 1.48 W/kg

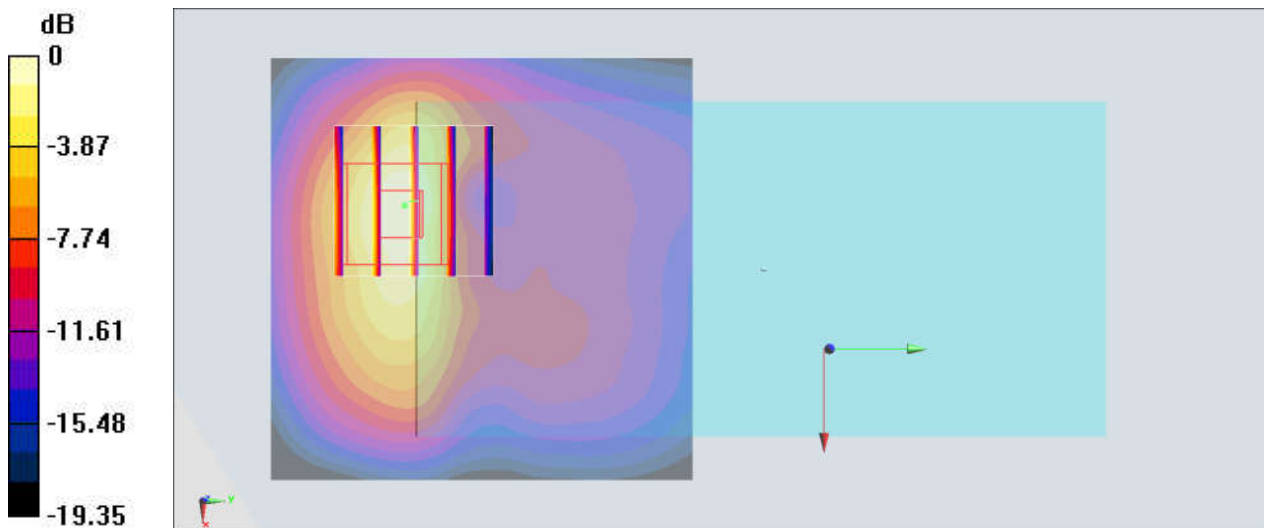

0 dB = 1.48 W/kg = 1.70 dBW/kg

#27_WCDMA V_RMC 12.2Kbps_Back_10mm_Ch4182

Communication System: WCDMA; Frequency: 836.4 MHz; Duty Cycle: 1:1

Medium: MSL_850_180506 Medium parameters used: $f = 836.4$ MHz; $\sigma = 0.977$ S/m; $\epsilon_r = 56.287$; $\rho = 1000$ kg/m³

Ambient Temperature : 23.3 °C ; Liquid Temperature : 22.3 °C

DASY5 Configuration

- Probe: EX3DV4 - SN7306; ConvF(9.85, 9.85, 9.85); Calibrated: 2017/7/24;
- Sensor-Surface: 1.4mm (Mechanical Surface Detection)
- Electronics: DAE3 Sn577; Calibrated: 2017/9/25
- Phantom: SAM LEFT; Type: QD000P40CD; Serial: TP:1718
- Measurement SW: DASY52, Version 52.8 (8); SEMCAD X Version 14.6.10 (7373)

Area Scan (61x121x1): Interpolated grid: dx=1.500 mm, dy=1.500 mm

Maximum value of SAR (interpolated) = 0.547 W/kg

Zoom Scan (5x5x7)/Cube 0: Measurement grid: dx=8mm, dy=8mm, dz=5mm

Reference Value = 24.08 V/m; Power Drift = 0.13 dB

Peak SAR (extrapolated) = 0.596 W/kg

SAR(1 g) = 0.459 W/kg; SAR(10 g) = 0.354 W/kg

Maximum value of SAR (measured) = 0.549 W/kg

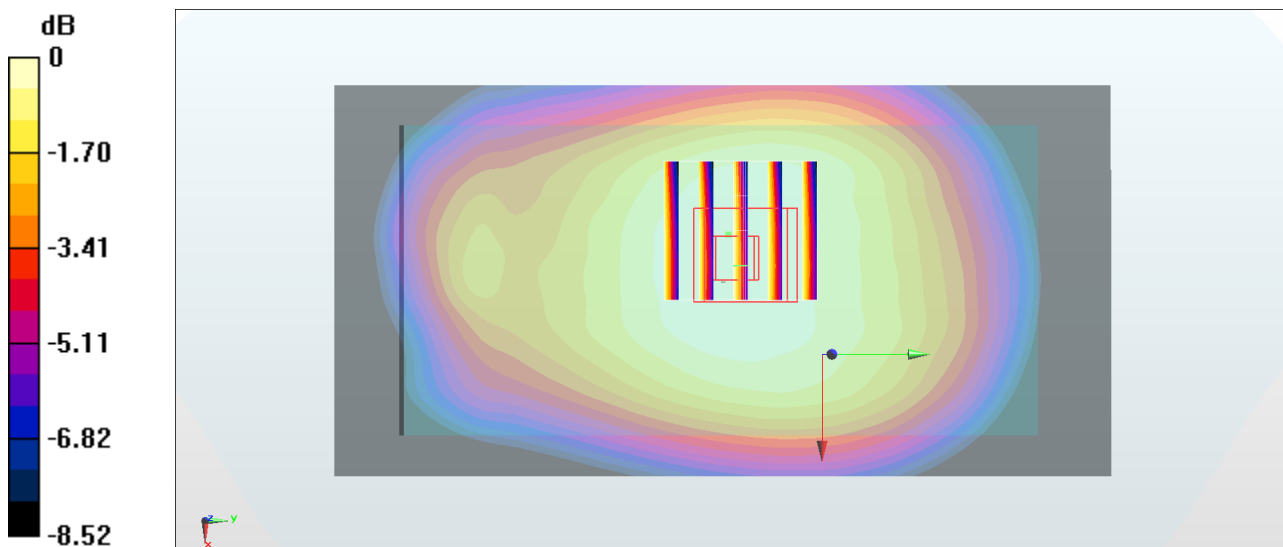

0 dB = 0.549 W/kg = -2.60 dBW/kg

#28_LTE Band 2_20M_QPSK_1_49_Back_10mm_Ch18700

Communication System: LTE ; Frequency: 1860 MHz;Duty Cycle: 1:1

Medium: MSL_1900_180505 Medium parameters used: $f = 1860$ MHz; $\sigma = 1.51$ S/m; $\epsilon_r = 51.893$; $\rho = 1000$ kg/m³

Ambient Temperature : 23.7 °C ; Liquid Temperature : 22.7 °C

DASY5 Configuration

- Probe: EX3DV4 - SN7306; ConvF(7.98, 7.98, 7.98); Calibrated: 2017/7/24;
- Sensor-Surface: 1.4mm (Mechanical Surface Detection)
- Electronics: DAE3 Sn577; Calibrated: 2017/9/25
- Phantom: SAM LEFT; Type: QD000P40CD; Serial: TP:1718
- Measurement SW: DASY52, Version 52.8 (8); SEMCAD X Version 14.6.10 (7373)

Area Scan (61x61x1): Interpolated grid: dx=1.500 mm, dy=1.500 mm

Maximum value of SAR (interpolated) = 0.971 W/kg

Zoom Scan (5x5x7)/Cube 0: Measurement grid: dx=8mm, dy=8mm, dz=5mm

Reference Value = 14.74 V/m; Power Drift = 0.09 dB

Peak SAR (extrapolated) = 1.43 W/kg

SAR(1 g) = 0.817 W/kg; SAR(10 g) = 0.414 W/kg

Maximum value of SAR (measured) = 1.21 W/kg

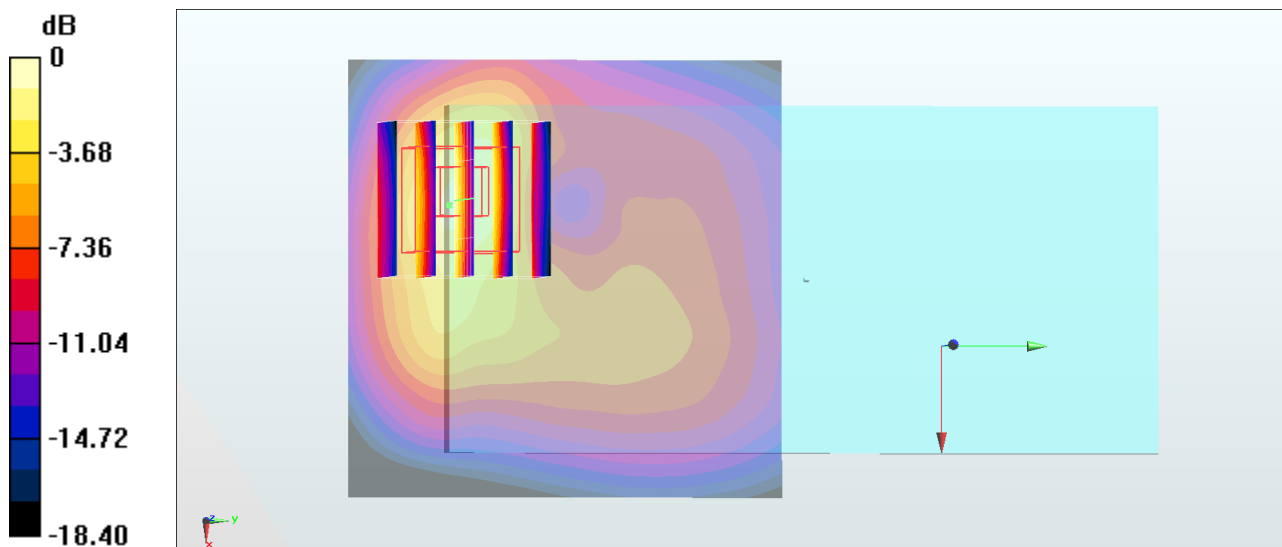

0 dB = 1.21 W/kg = 0.83 dBW/kg

#29_LTE Band 4_20M_QPSK_1_49_Back_10mm_Ch20175

Communication System: LTE; Frequency: 1732.5 MHz; Duty Cycle: 1:1

Medium: MSL_1750_180505 Medium parameters used: $f = 1732.5$ MHz; $\sigma = 1.473$ S/m; $\epsilon_r = 52.696$; $\rho = 1000$ kg/m³

Ambient Temperature : 23.5 °C ; Liquid Temperature : 22.5 °C

DASY5 Configuration

- Probe: EX3DV4 - SN7306; ConvF(8.29, 8.29, 8.29); Calibrated: 2017/7/24;
- Sensor-Surface: 1.4mm (Mechanical Surface Detection)
- Electronics: DAE3 Sn577; Calibrated: 2017/9/25
- Phantom: SAM LEFT; Type: QD000P40CD; Serial: TP:1718
- Measurement SW: DASY52, Version 52.8 (8); SEMCAD X Version 14.6.10 (7373)

Area Scan (61x61x1): Interpolated grid: dx=1.500 mm, dy=1.500 mm

Maximum value of SAR (interpolated) = 1.28 W/kg

Zoom Scan (5x5x7)/Cube 0: Measurement grid: dx=8mm, dy=8mm, dz=5mm

Reference Value = 13.91 V/m; Power Drift = 0.09 dB

Peak SAR (extrapolated) = 1.47 W/kg

SAR(1 g) = 0.860 W/kg; SAR(10 g) = 0.452 W/kg

Maximum value of SAR (measured) = 1.27 W/kg

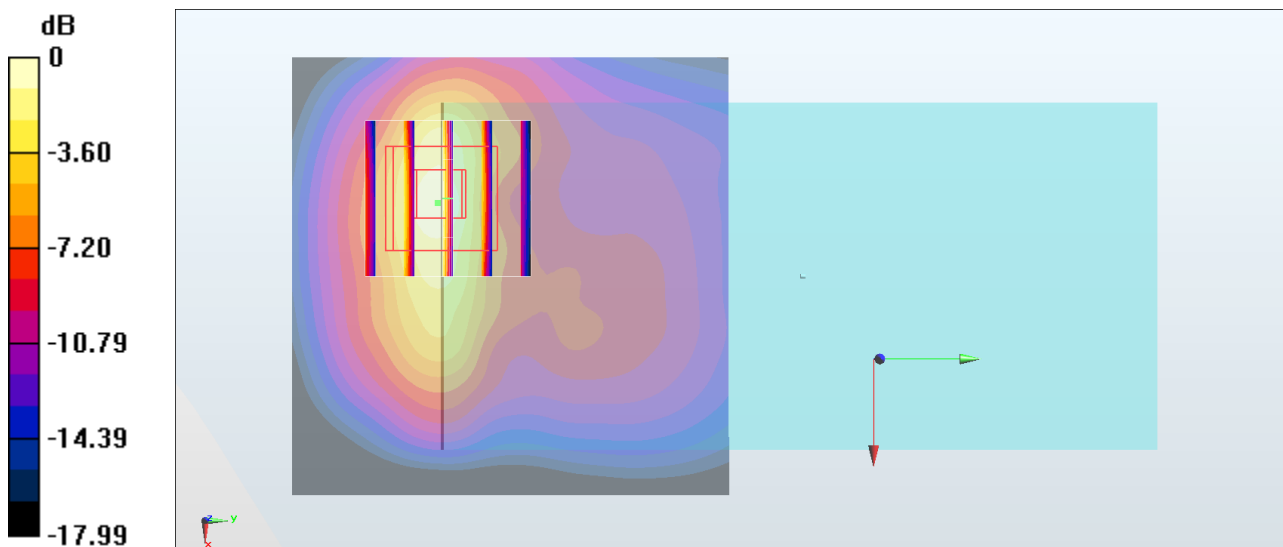

0 dB = 1.27 W/kg = 1.04 dBW/kg

#30_LTE Band 5_10M_QPSK_1_25_Back_10mm_Ch20525

Communication System: LTE; Frequency: 836.5 MHz; Duty Cycle: 1:1

Medium: MSL_850_180506 Medium parameters used: $f = 836.5$ MHz; $\sigma = 0.977$ S/m; $\epsilon_r = 56.286$; $\rho = 1000$ kg/m³

Ambient Temperature : 23.3 °C ; Liquid Temperature : 22.3 °C

DASY5 Configuration

- Probe: EX3DV4 - SN7306; ConvF(9.85, 9.85, 9.85); Calibrated: 2017/7/24;
- Sensor-Surface: 1.4mm (Mechanical Surface Detection)
- Electronics: DAE3 Sn577; Calibrated: 2017/9/25
- Phantom: SAM LEFT; Type: QD000P40CD; Serial: TP:1718
- Measurement SW: DASY52, Version 52.8 (8); SEMCAD X Version 14.6.10 (7373)

Area Scan (61x121x1): Interpolated grid: dx=1.500 mm, dy=1.500 mm

Maximum value of SAR (interpolated) = 0.525 W/kg

Zoom Scan (5x5x7)/Cube 0: Measurement grid: dx=8mm, dy=8mm, dz=5mm

Reference Value = 23.60 V/m; Power Drift = 0.10 dB

Peak SAR (extrapolated) = 0.569 W/kg

SAR(1 g) = 0.437 W/kg; SAR(10 g) = 0.337 W/kg

Maximum value of SAR (measured) = 0.523 W/kg

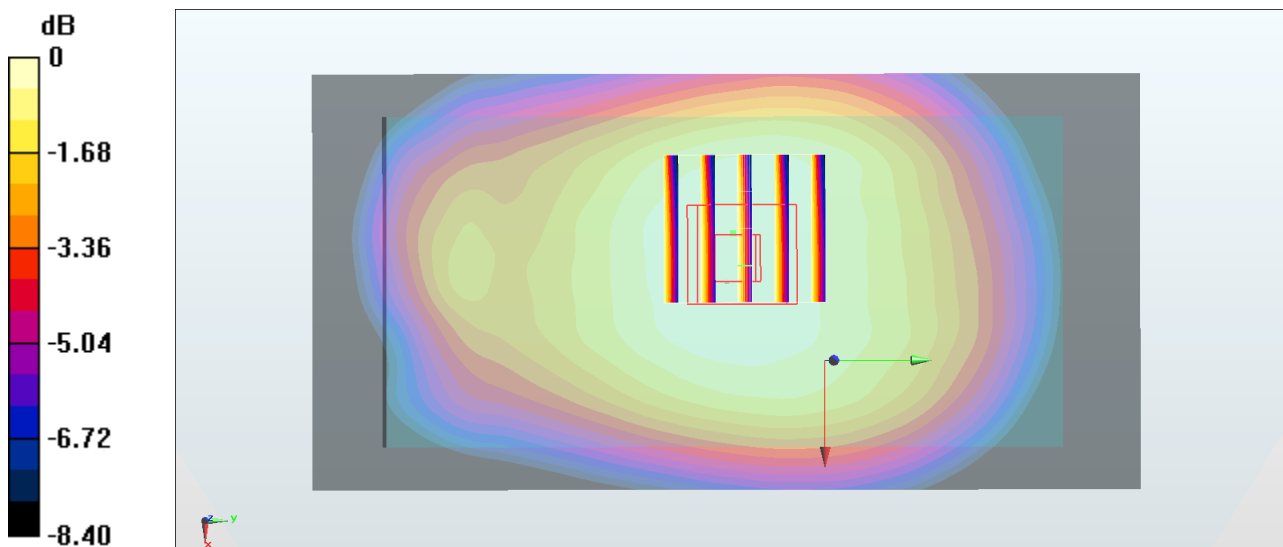

0 dB = 0.523 W/kg = -2.81 dBW/kg

#31_LTE Band 7_20M_QPSK_1_49_Back_10mm_Ch21100

Communication System: LTE; Frequency: 2535 MHz; Duty Cycle: 1:1

Medium: MSL_2600_180506 Medium parameters used: $f = 2535$ MHz; $\sigma = 2.084$ S/m; $\epsilon_r = 50.762$; $\rho = 1000$ kg/m³

Ambient Temperature : 23.4 °C ; Liquid Temperature : 22.4 °C

DASY5 Configuration

- Probe: EX3DV4 - SN7306; ConvF(7.46, 7.46, 7.46); Calibrated: 2017/7/24;
- Sensor-Surface: 1.4mm (Mechanical Surface Detection)
- Electronics: DAE3 Sn577; Calibrated: 2017/9/25
- Phantom: SAM LEFT; Type: QD000P40CD; Serial: TP:1718
- Measurement SW: DASY52, Version 52.8 (8); SEMCAD X Version 14.6.10 (7373)

Area Scan (81x81x1): Interpolated grid: dx=1.200 mm, dy=1.200 mm

Maximum value of SAR (interpolated) = 1.72 W/kg

Zoom Scan (7x7x7)/Cube 0: Measurement grid: dx=5mm, dy=5mm, dz=5mm

Reference Value = 6.720 V/m; Power Drift = -0.03 dB

Peak SAR (extrapolated) = 2.19 W/kg

SAR(1 g) = 1.06 W/kg; SAR(10 g) = 0.470 W/kg

Maximum value of SAR (measured) = 1.77 W/kg

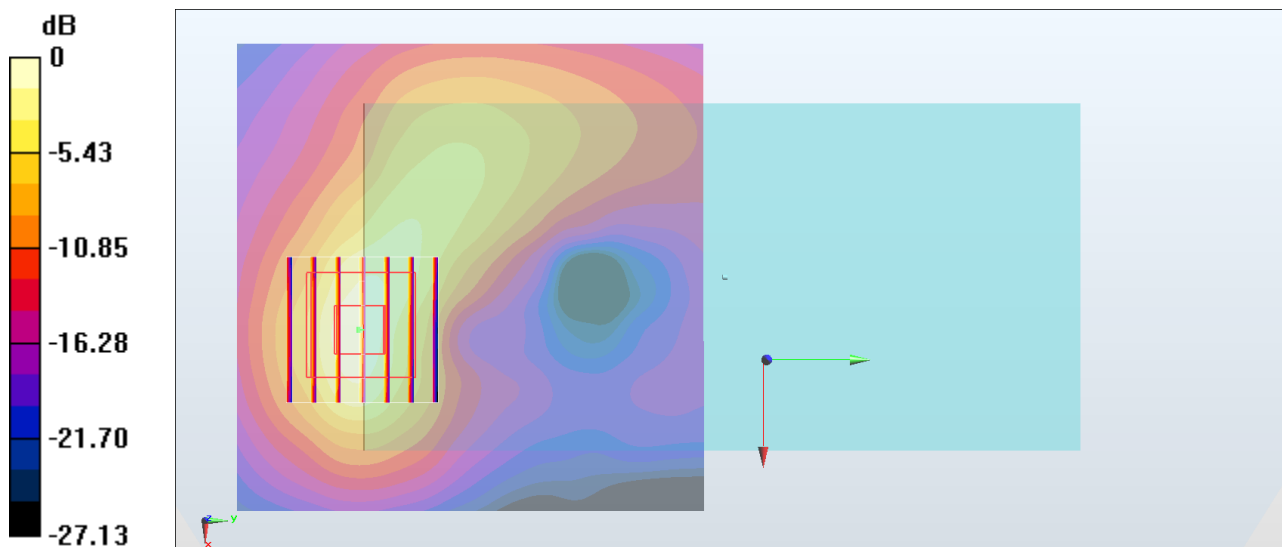

0 dB = 1.77 W/kg = 2.48 dBW/kg

#32_LTE Band 38_20M_QPSK_1_49_Back_10mm_Ch37850

Communication System: LTE ; Frequency: 2580 MHz;Duty Cycle: 1:1.59

Medium: MSL_2600_180512 Medium parameters used: $f = 2580$ MHz; $\sigma = 2.172$ S/m; $\epsilon_r = 51.886$; $\rho = 1000$ kg/m³

Ambient Temperature : 23.6 °C ; Liquid Temperature : 22.6 °C

DASY5 Configuration:

- Probe: EX3DV4 - SN7306; ConvF(7.46, 7.46, 7.46); Calibrated: 2017/7/24
- Sensor-Surface: 1.4mm (Mechanical Surface Detection)
- Electronics: DAE3 Sn577; Calibrated: 2017/9/25
- Phantom: SAM_Right; Type: QD000P40CD; Serial: 1719
- Measurement SW: DASY52, Version 52.10 (1);SEMCAD X Version 14.6.11 (7437)

Area Scan (81x81x1): Interpolated grid: dx=1.200 mm, dy=1.200 mm

Maximum value of SAR (interpolated) = 1.42 W/kg

Zoom Scan (7x7x7)/Cube 0: Measurement grid: dx=5mm, dy=5mm, dz=5mm

Reference Value = 16.34 V/m; Power Drift = 0.04 dB

Peak SAR (extrapolated) = 1.76 W/kg

SAR(1 g) = 0.843 W/kg; SAR(10 g) = 0.376 W/kg

Maximum value of SAR (measured) = 1.32 W/kg

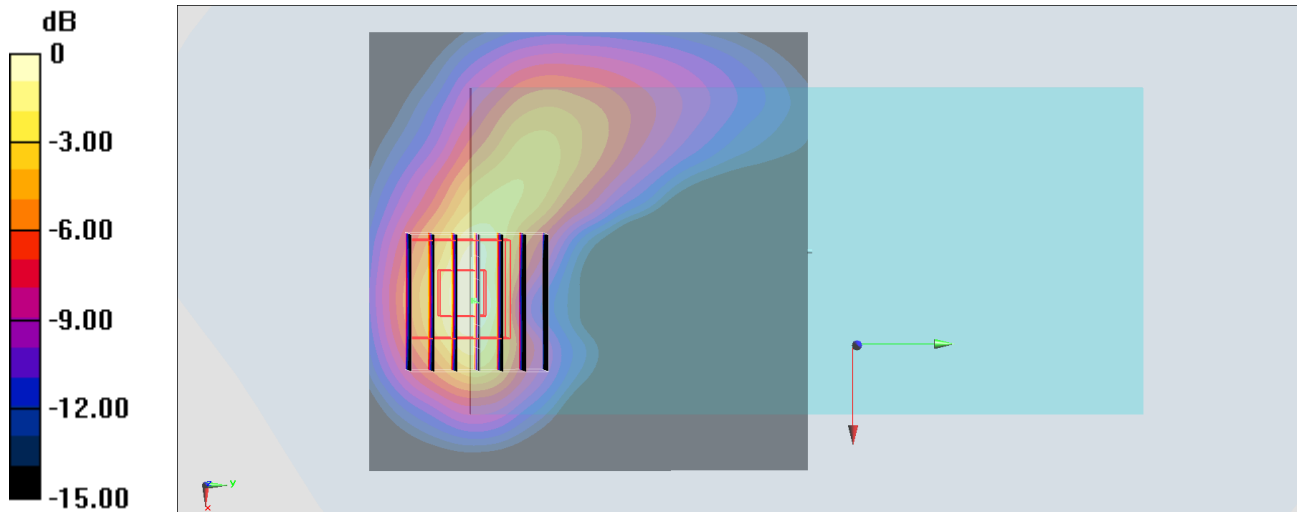

0 dB = 1.32 W/kg = 1.21 dBW/kg

#33_WLAN2.4GHz_802.11b 1Mbps_Back_10mm_Ch6

Communication System: 802.11b; Frequency: 2437 MHz; Duty Cycle: 1:1.007

Medium: MSL_2450_180510 Medium parameters used: $f = 2437$ MHz; $\sigma = 1.921$ S/m; $\epsilon_r = 53.325$; $\rho = 1000$ kg/m³

Ambient Temperature : 23.4 °C ; Liquid Temperature : 22.4 °C

DASY5 Configuration

- Probe: EX3DV4 - SN3976; ConvF(7.8, 7.8, 7.8); Calibrated: 2018/1/23;
- Sensor-Surface: 1.4mm (Mechanical Surface Detection)
- Electronics: DAE3 Sn495; Calibrated: 2017/5/22
- Phantom: SAM_Left; Type: QD000P40CD; Serial: S/N:1801
- Measurement SW: DASY52, Version 52.10 (0); SEMCAD X Version 14.6.10 (7417)

Area Scan (81x101x1): Interpolated grid: dx=1.200 mm, dy=1.200 mm

Maximum value of SAR (interpolated) = 0.257 W/kg

Zoom Scan (7x8x7)/Cube 0: Measurement grid: dx=5mm, dy=5mm, dz=5mm

Reference Value = 11.16 V/m; Power Drift = -0.01 dB

Peak SAR (extrapolated) = 0.316 W/kg

SAR(1 g) = 0.155 W/kg; SAR(10 g) = 0.082 W/kg

Maximum value of SAR (measured) = 0.250 W/kg

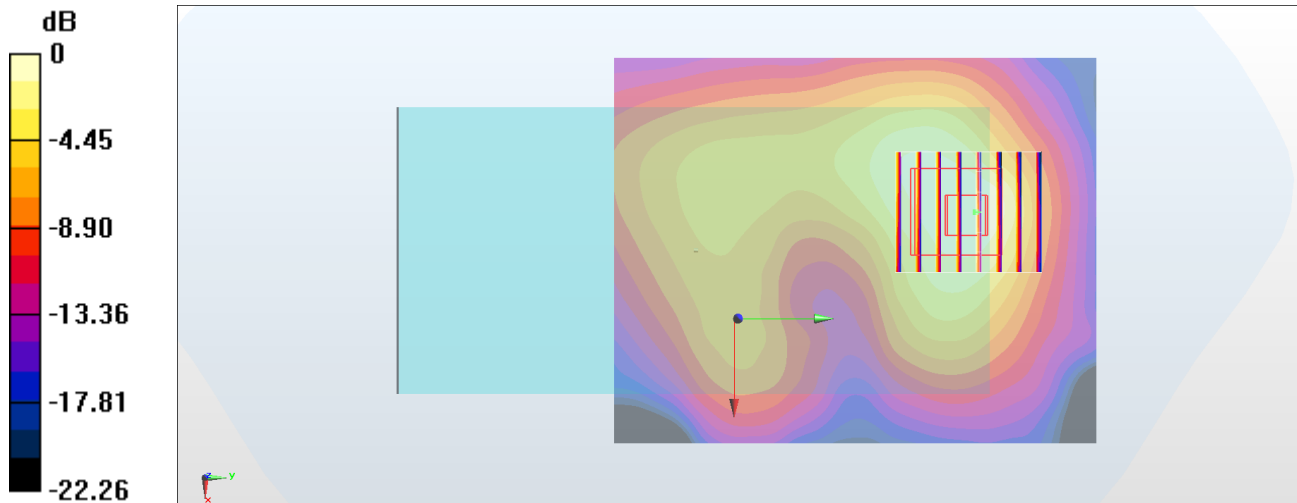

0 dB = 0.250 W/kg = -6.02 dBW/kg