



FCC SAR Test Report

APPLICANT : Xiaomi Communications Co., Ltd.
EQUIPMENT : Mobile Phone
BRAND NAME : MI
MODEL NAME : MEG7
FCC ID : 2AFZZ-RMMEG7
STANDARD : FCC 47 CFR Part 2 (2.1093)
ANSI/IEEE C95.1-1992
IEEE 1528-2013

We, Sporton International (Kunshan) Inc., would like to declare that the tested sample has been evaluated in accordance with the procedures and had been in compliance with the applicable technical standards.

The test results in this report apply exclusively to the tested model / sample. Without written approval of Sporton International (Kunshan) Inc., the test report shall not be reproduced except in full.

Approved by: Mark Qu / Manager



Sporton International (Kunshan) Inc.

No.3-2 Ping-Xiang Rd, Kunshan Development Zone Kunshan City Jiangsu Province 215335 China



Table of Contents

1. Statement of Compliance 4
2. Administration Data 5
3. Guidance Applied 5
4. Equipment Under Test (EUT) Information 6
4.1 General Information 6
4.2 General LTE SAR Test and Reporting Considerations 7
5. RF Exposure Limits 9
5.1 Uncontrolled Environment 9
5.2 Controlled Environment 9
6. Specific Absorption Rate (SAR) 10
6.1 Introduction 10
6.2 SAR Definition 10
7. System Description and Setup 11
7.1 E-Field Probe 12
7.2 Data Acquisition Electronics (DAE) 12
7.3 Phantom 13
7.4 Device Holder 14
8. Measurement Procedures 15
8.1 Spatial Peak SAR Evaluation 15
8.2 Power Reference Measurement 16
8.3 Area Scan 16
8.4 Zoom Scan 17
8.5 Volume Scan Procedures 17
8.6 Power Drift Monitoring 17
9. Test Equipment List 18
10. System Verification 19
10.1 Tissue Simulating Liquids 19
10.2 Tissue Verification 20
10.3 System Performance Check Results 21
11. RF Exposure Positions 22
11.1 Ear and handset reference point 22
11.2 Definition of the cheek position 23
11.3 Definition of the tilt position 24
11.4 Body Worn Accessory 25
11.5 Extremity Exposure 26
11.6 Wireless Router 26
12. Conducted RF Output Power (Unit: dBm) 27
13. Bluetooth Exclusions Applied 53
14. Antenna Location 54
15. SAR Test Results 55
15.1 Head SAR 57
15.2 Hotspot SAR 60
15.3 Body Worn Accessory SAR 63
15.4 Product specific 10g SAR 65
15.5 Repeated SAR Measurement 66
16. Simultaneous Transmission Analysis 67
16.1 Head Exposure Conditions 68
16.2 Hotspot Exposure Conditions 69
16.3 Body-Worn Accessory Exposure Conditions 71
16.4 Product Specific 10g SAR Exposure Conditions 72
17. Uncertainty Assessment 73
18. References 76
Appendix A. Plots of System Performance Check
Appendix B. Plots of High SAR Measurement
Appendix C. DASy Calibration Certificate
Appendix D. Test Setup Photos



Revision History

REPORT NO.	VERSION	DESCRIPTION	ISSUED DATE
FA782506	Rev. 01	Initial issue of report.	Oct. 16, 2017

1. Statement of Compliance

The maximum results of Specific Absorption Rate (SAR) found during testing for **Xiaomi Communications Co., Ltd., Mobile Phone**, are as follows.

Highest 1g SAR Summary						
Equipment Class	Frequency Band		Head (Separation 0mm)	Hotspot (Separation 10mm)	Body-worn (Separation 15mm)	Highest Simultaneous Transmission 1g SAR (W/kg)
			1g SAR (W/kg)			
Licensed	GSM	GSM850	0.21	0.31	0.27	1.48
		GSM1900	0.16	0.60	0.18	
	WCDMA	Band V	0.24	0.35	0.30	
		Band II	0.28	1.06	0.46	
	LTE	Band 5	0.19	0.28	0.23	
		Band 4	0.29	0.92	0.52	
		Band 7	0.11	1.03	0.89	
Band 38	<0.10	0.76	0.51			
DTS	WLAN	2.4GHz WLAN	0.91	0.17	<0.10	1.20
NII		5GHz WLAN	1.19	0.39	0.14	1.48
Highest 10g SAR Summary						
Equipment Class	Frequency Band		Product Specific 10g SAR (W/kg) (Separation 0mm)			Highest Simultaneous Transmission 10g SAR (W/kg)
Licensed	WCDMA	Band II	2.61			3.98
	LTE	Band 4	2.64			
		Band 7	3.62			
NII	WLAN	5GHz WLAN	0.66			3.98
Date of Testing:			2017/9/12 ~ 2017/9/24			

This device is in compliance with Specific Absorption Rate (SAR) for general population/uncontrolled exposure limits (1.6W/kg as averaged over any 1 gram of tissue; 10-gram SAR for Product Specific 10g SAR, limit: 4.0W/kg) specified in FCC 47 CFR part 2 (2.1093) and ANSI/IEEE C95.1-1992, and had been tested in accordance with the measurement methods and procedures specified in IEEE 1528-2013 and FCC KDB publications.



2. Administration Data

Testing Laboratory	
Test Site	Sporton International (Kunshan) Inc.
Test Site Location	No.3-2 Ping-Xiang Rd, Kunshan Development Zone Kunshan City Jiangsu Province 215335 China TEL : +86-512-57900158 FAX : +86-512-57900958

Applicant	
Company Name	Xiaomi Communications Co., Ltd.
Address	The Rainbow City of China Resources, NO.68, Qinghe Middle Street, Haidian District, Beijing, China

Manufacturer	
Company Name	Xiaomi Communications Co., Ltd.
Address	The Rainbow City of China Resources, NO.68, Qinghe Middle Street, Haidian District, Beijing, China

3. Guidance Applied

The Specific Absorption Rate (SAR) testing specification, method, and procedure for this device is in accordance with the following standards:

- FCC 47 CFR Part 2 (2.1093)
- ANSI/IEEE C95.1-1992
- IEEE 1528-2013
- FCC KDB 865664 D01 SAR Measurement 100 MHz to 6 GHz v01r04
- FCC KDB 865664 D02 SAR Reporting v01r02
- FCC KDB 447498 D01 General RF Exposure Guidance v06
- FCC KDB 648474 D04 SAR Evaluation Considerations for Wireless Handsets v01r03
- FCC KDB 248227 D01 802.11 Wi-Fi SAR v02r02
- FCC KDB 941225 D01 3G SAR Procedures v03r01
- FCC KDB 941225 D05 SAR for LTE Devices v02r05
- FCC KDB 941225 D05A Rel.10 LTE SAR Test Guidance v01r02
- FCC KDB 941225 D06 Hotspot Mode SAR v02r01



4. Equipment Under Test (EUT) Information

4.1 General Information

Product Feature & Specification	
Equipment Name	Mobile Phone
Brand Name	MI
FCC ID	2AFZZ-RMMEG7
IMEI Code	SIM1: 865060030040966 SIM2: 865060030040974
Wireless Technology and Frequency Range	GSM850: 824.2 MHz ~ 848.8 MHz GSM1900: 1850.2 MHz ~ 1909.8 MHz WCDMA Band II: 1852.4 MHz ~ 1907.6 MHz WCDMA Band V: 826.4 MHz ~ 846.6 MHz LTE Band 4: 1710.7 MHz ~ 1754.3 MHz LTE Band 5: 824.7 MHz ~ 848.3 MHz LTE Band 7: 2502.5 MHz ~ 2567.5 MHz LTE Band 38: 2572.5 MHz ~ 2617.5 MHz WLAN 2.4GHz Band: 2412 MHz ~ 2462 MHz WLAN 5.2GHz Band: 5180 MHz ~ 5240 MHz WLAN 5.3GHz Band: 5260 MHz ~ 5320 MHz WLAN 5.5GHz Band: 5500 MHz ~ 5720 MHz WLAN 5.8GHz Band: 5745 MHz ~ 5825 MHz Bluetooth: 2402 MHz ~ 2480 MHz
Mode	GSM/GPRS/EGPRS RMC/AMR 12.2Kbps HSDPA HSUPA DC-HSDPA HSPA+(16QAM uplink is not supported) LTE WLAN 2.4GHz 802.11b/g/n HT20/HT40 WLAN 5GHz 802.11a/n HT20/HT40 Bluetooth v3.0+EDR, Bluetooth v4.0 LE, Bluetooth v4.1 LE, Bluetooth v4.2 LE
HW Version	P2
SW Version	MIUI9
GSM / (E)GPRS Transfer mode	Class B – EUT cannot support Packet Switched and Circuit Switched Network simultaneously but can automatically switch between Packet and Circuit Switched Network.
EUT Stage	Identical Prototype
Remark:	
<ol style="list-style-type: none"> WLAN operation in 5600 MHz ~ 5650 MHz is notched. This device supports VoIP in GPRS, EGPRS, WCDMA and LTE (e.g. for 3rd-party VoIP), LTE supports VoLTE operation. This device 2.4GHz WLAN/5.2GHz WLAN/5.8GHz WLAN support hotspot operation, and 5.2GHz WLAN/5.8GHz WLAN supports WiFi Direct (GC/GO), and 5.3GHz / 5.5GHz supports WiFi Direct (GC only). This device does not support DTM operation and supports GRPS/EGRPS mode up to multi-slot class 33. When hotspot mode is enabled, power reduction will be activated to limit the maximum power of WCDMA B2 and LTE B4 / B7. The dual SIM card mobile has 2 SIM slots and supports dual SIM dual standby. The WWAN radio transmission will be enabled by either one SIM at a time (single active). After pre-scan two SIM cards power, we found test result of the SIM1 was the worse, so we chose dual SIM1 card to perform all tests. 	



4.2 General LTE SAR Test and Reporting Considerations

Summarized necessary items addressed in KDB 941225 D05 v02r05																																							
FCC ID	2AFZZ-RMMEG7																																						
Equipment Name	Mobile Phone																																						
Operating Frequency Range of each LTE transmission band	LTE Band 4: 1710.7 MHz ~ 1754.3 MHz LTE Band 5: 824.7 MHz ~ 848.3 MHz LTE Band 7: 2502.5 MHz ~ 2567.5 MHz LTE Band 38: 2572.5 MHz ~ 2617.5 MHz																																						
Channel Bandwidth	LTE Band 4: 1.4MHz, 3MHz, 5MHz, 10MHz, 15MHz, 20MHz LTE Band 5: 1.4MHz, 3MHz, 5MHz, 10MHz LTE Band 7: 5MHz, 10MHz, 15MHz, 20MHz LTE Band 38: 5MHz, 10MHz, 15MHz, 20MHz																																						
uplink modulations used	QPSK, and 16QAM																																						
LTE Voice / Data requirements	Voice and Data																																						
LTE Release Version	R10, Cat 4																																						
CA Support	Yes, Downlink Only																																						
LTE MPR permanently built-in by design	<p style="text-align: center;">Table 6.2.3-1: Maximum Power Reduction (MPR) for Power Class 3</p> <table border="1"> <thead> <tr> <th rowspan="2">Modulation</th> <th colspan="6">Channel bandwidth / Transmission bandwidth (RB)</th> <th rowspan="2">MPR (dB)</th> </tr> <tr> <th>1.4 MHz</th> <th>3.0 MHz</th> <th>5 MHz</th> <th>10 MHz</th> <th>15 MHz</th> <th>20 MHz</th> </tr> </thead> <tbody> <tr> <td>QPSK</td> <td>>5</td> <td>>4</td> <td>>8</td> <td>>12</td> <td>>16</td> <td>>18</td> <td>≤ 1</td> </tr> <tr> <td>16 QAM</td> <td>≤ 5</td> <td>≤ 4</td> <td>≤ 8</td> <td>≤ 12</td> <td>≤ 16</td> <td>≤ 18</td> <td>≤ 1</td> </tr> <tr> <td>16 QAM</td> <td>>5</td> <td>>4</td> <td>>8</td> <td>>12</td> <td>>16</td> <td>>18</td> <td>≤ 2</td> </tr> </tbody> </table>	Modulation	Channel bandwidth / Transmission bandwidth (RB)						MPR (dB)	1.4 MHz	3.0 MHz	5 MHz	10 MHz	15 MHz	20 MHz	QPSK	>5	>4	>8	>12	>16	>18	≤ 1	16 QAM	≤ 5	≤ 4	≤ 8	≤ 12	≤ 16	≤ 18	≤ 1	16 QAM	>5	>4	>8	>12	>16	>18	≤ 2
Modulation	Channel bandwidth / Transmission bandwidth (RB)						MPR (dB)																																
	1.4 MHz	3.0 MHz	5 MHz	10 MHz	15 MHz	20 MHz																																	
QPSK	>5	>4	>8	>12	>16	>18	≤ 1																																
16 QAM	≤ 5	≤ 4	≤ 8	≤ 12	≤ 16	≤ 18	≤ 1																																
16 QAM	>5	>4	>8	>12	>16	>18	≤ 2																																
LTE A-MPR	In the base station simulator configuration, Network Setting value is set to NS_01 to disable A-MPR during SAR testing and the LTE SAR tests was transmitting on all TTI frames (Maximum TTI)																																						
Spectrum plots for RB configuration	A properly configured base station simulator was used for the SAR and power measurement; therefore, spectrum plots for each RB allocation and offset configuration are not included in the SAR report.																																						
Power reduction applied to satisfy SAR compliance	Yes, when operating in hotspot mode that LTE B4 / B7 power reduction applied to satisfy SAR compliance.																																						
LTE Carrier Aggregation Combinations	Intra-Band possible combinations as below page and the detail power verification please referred to section 12.																																						
LTE Carrier Aggregation Additional Information	This device supports maximum of 2 carriers in the downlink only. All uplink communications are identical to the Release 8 Specifications. Uplink communications are done on the PCC. Due to carrier capability, only the combinations listed above are supported. The following LTE Release features are not supported: Relay, HetNet, Enhanced MIMO, eICI, WiFi Offloading, MDH, eMBMA, Cross-Carrier Scheduling, Enhanced SC-FDMA.																																						



Transmission (H, M, L) channel numbers and frequencies in each LTE band												
LTE Band 4												
	Bandwidth 1.4 MHz		Bandwidth 3 MHz		Bandwidth 5 MHz		Bandwidth 10 MHz		Bandwidth 15 MHz		Bandwidth 20 MHz	
	Ch. #	Freq. (MHz)	Ch. #	Freq. (MHz)	Ch. #	Freq. (MHz)	Ch. #	Freq. (MHz)	Ch. #	Freq. (MHz)	Ch. #	Freq. (MHz)
L	19957	1710.7	19965	1711.5	19975	1712.5	20000	1715	20025	1717.5	20050	1720
M	20175	1732.5	20175	1732.5	20175	1732.5	20175	1732.5	20175	1732.5	20175	1732.5
H	20393	1754.3	20385	1753.5	20375	1752.5	20350	1750	20325	1747.5	20300	1745
LTE Band 5												
	Bandwidth 1.4 MHz		Bandwidth 3 MHz		Bandwidth 5 MHz		Bandwidth 10 MHz					
	Ch. #	Freq. (MHz)	Ch. #	Freq. (MHz)	Ch. #	Freq. (MHz)	Ch. #	Freq. (MHz)	Ch. #	Freq. (MHz)	Ch. #	Freq. (MHz)
L	20407	824.7	20415	825.5	20425	826.5	20450	829				
M	20525	836.5	20525	836.5	20525	836.5	20525	836.5	20525	836.5		836.5
H	20643	848.3	20635	847.5	20625	846.5	20600	844				
LTE Band 7												
	Bandwidth 5 MHz		Bandwidth 10 MHz		Bandwidth 15 MHz		Bandwidth 20 MHz					
	Ch. #	Freq. (MHz)	Ch. #	Freq. (MHz)	Ch. #	Freq. (MHz)	Ch. #	Freq. (MHz)	Ch. #	Freq. (MHz)	Ch. #	Freq. (MHz)
L	20775	2502.5	20800	2505	20825	2507.5	20850	2510				
M	21100	2535	21100	2535	21100	2535	21100	2535	21100	2535		2535
H	21425	2567.5	21400	2565	21375	2562.5	21350	2560				
LTE Band 38												
	Bandwidth 5 MHz		Bandwidth 10 MHz		Bandwidth 15 MHz		Bandwidth 20 MHz					
	Ch. #	Freq. (MHz)	Ch. #	Freq. (MHz)	Ch. #	Freq. (MHz)	Ch. #	Freq. (MHz)	Ch. #	Freq. (MHz)	Ch. #	Freq. (MHz)
L	37775	2572.5	37800	2575	37825	2577.5	37850	2580				
M	38000	2595	38000	2595	38000	2595	38000	2595	38000	2595		2595
H	38225	2617.5	38200	2615	38175	2612.5	38150	2610				

5. RF Exposure Limits

5.1 Uncontrolled Environment

Uncontrolled Environments are defined as locations where there is the exposure of individuals who have no knowledge or control of their exposure. The general population/uncontrolled exposure limits are applicable to situations in which the general public may be exposed or in which persons who are exposed as a consequence of their employment may not be made fully aware of the potential for exposure or cannot exercise control over their exposure. Members of the general public would come under this category when exposure is not employment-related; for example, in the case of a wireless transmitter that exposes persons in its vicinity.

5.2 Controlled Environment

Controlled Environments are defined as locations where there is exposure that may be incurred by persons who are aware of the potential for exposure, (i.e. as a result of employment or occupation). In general, occupational/controlled exposure limits are applicable to situations in which persons are exposed as a consequence of their employment, who have been made fully aware of the potential for exposure and can exercise control over their exposure. The exposure category is also applicable when the exposure is of a transient nature due to incidental passage through a location where the exposure levels may be higher than the general population/uncontrolled limits, but the exposed person is fully aware of the potential for exposure and can exercise control over his or her exposure by leaving the area or by some other appropriate means.

Limits for Occupational/Controlled Exposure (W/kg)

Whole-Body	Partial-Body	Hands, Wrists, Feet and Ankles
0.4	8.0	20.0

Limits for General Population/Uncontrolled Exposure (W/kg)

Whole-Body	Partial-Body	Hands, Wrists, Feet and Ankles
0.08	1.6	4.0

Whole-Body SAR is averaged over the entire body, partial-body SAR is averaged over any 1gram of tissue defined as a tissue volume in the shape of a cube. SAR for hands, wrists, feet and ankles is averaged over any 10 grams of tissue defined as a tissue volume in the shape of a cube.

6. Specific Absorption Rate (SAR)

6.1 Introduction

SAR is related to the rate at which energy is absorbed per unit mass in an object exposed to a radio field. The SAR distribution in a biological body is complicated and is usually carried out by experimental techniques or numerical modeling. The standard recommends limits for two tiers of groups, occupational/controlled and general population/uncontrolled, based on a person's awareness and ability to exercise control over his or her exposure. In general, occupational/controlled exposure limits are higher than the limits for general population/uncontrolled.

6.2 SAR Definition

The SAR definition is the time derivative (rate) of the incremental energy (dW) absorbed by (dissipated in) an incremental mass (dm) contained in a volume element (dv) of a given density (ρ). The equation description is as below:

$$SAR = \frac{d}{dt} \left(\frac{dW}{dm} \right) = \frac{d}{dt} \left(\frac{dW}{\rho dv} \right)$$

SAR is expressed in units of Watts per kilogram (W/kg)

$$SAR = \frac{\sigma |E|^2}{\rho}$$

Where: σ is the conductivity of the tissue, ρ is the mass density of the tissue and E is the RMS electrical field strength.

7. System Description and Setup

The DASY system used for performing compliance tests consists of the following items:

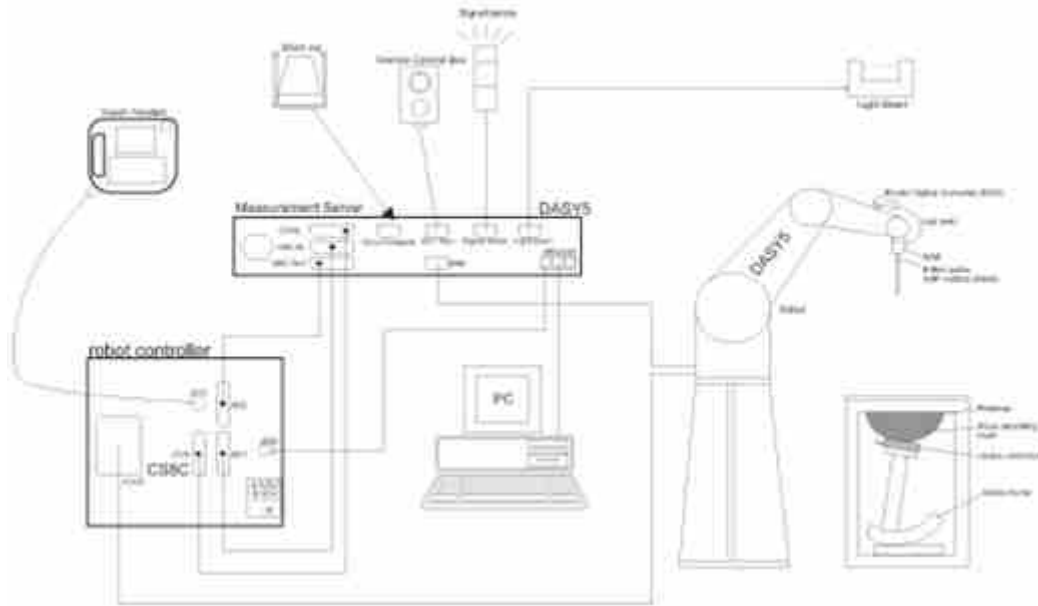

- A standard high precision 6-axis robot with controller, teach pendant and software. An arm extension for accommodating the data acquisition electronics (DAE).
- An isotropic Field probe optimized and calibrated for the targeted measurement.
- A data acquisition electronics (DAE) which performs the signal amplification, signal multiplexing, AD-conversion, offset measurements, mechanical surface detection, collision detection, etc. The unit is battery powered with standard or rechargeable batteries. The signal is optically transmitted to the EOC.
- The Electro-optical converter (EOC) performs the conversion from optical to electrical signals for the digital communication to the DAE. To use optical surface detection, a special version of the EOC is required. The EOC signal is transmitted to the measurement server.
- The function of the measurement server is to perform the time critical tasks such as signal filtering, control of the robot operation and fast movement interrupts.
- The Light Beam used is for probe alignment. This improves the (absolute) accuracy of the probe positioning.
- A computer running WinXP or Win7 and the DASY5 software.
- Remote control and teach pendant as well as additional circuitry for robot safety such as warning lamps, etc.
- The phantom, the device holder and other accessories according to the targeted measurement.

7.1 E-Field Probe

The SAR measurement is conducted with the dosimetric probe (manufactured by SPEAG).The probe is specially designed and calibrated for use in liquid with high permittivity. The dosimetric probe has special calibration in liquid at different frequency. This probe has a built in optical surface detection system to prevent from collision with phantom.

<EX3DV4 Probe>

Construction	Symmetric design with triangular core Built-in shielding against static charges PEEK enclosure material (resistant to organic solvents, e.g., DGBE)	
Frequency	10 MHz – >6 GHz Linearity: ±0.2 dB (30 MHz – 6 GHz)	
Directivity	±0.3 dB in TSL (rotation around probe axis) ±0.5 dB in TSL (rotation normal to probe axis)	
Dynamic Range	10 µW/g – >100 mW/g Linearity: ±0.2 dB (noise: typically <1 µW/g)	
Dimensions	Overall length: 337 mm (tip: 20 mm) Tip diameter: 2.5 mm (body: 12 mm) Typical distance from probe tip to dipole centers: 1 mm	

7.2 Data Acquisition Electronics (DAE)

The data acquisition electronics (DAE) consists of a highly sensitive electrometer-grade preamplifier with auto-zeroing, a channel and gain-switching multiplexer, a fast 16 bit AD-converter and a command decoder and control logic unit. Transmission to the measurement server is accomplished through an optical downlink for data and status information as well as an optical uplink for commands and the clock.

The input impedance of the DAE is 200 MOhm; the inputs are symmetrical and floating. Common mode rejection is above 80 dB.



Fig 5.1 Photo of DAE

7.3 Phantom

<SAM Twin Phantom>

Shell Thickness	2 ± 0.2 mm; Center ear point: 6 ± 0.2 mm
Filling Volume	Approx. 25 liters
Dimensions	Length: 1000 mm; Width: 500 mm; Height: adjustable feet
Measurement Areas	Left Hand, Right Hand, Flat Phantom



The bottom plate contains three pair of bolts for locking the device holder. The device holder positions are adjusted to the standard measurement positions in the three sections. A white cover is provided to tap the phantom during off-periods to prevent water evaporation and changes in the liquid parameters. On the phantom top, three reference markers are provided to identify the phantom position with respect to the robot.

<ELI Phantom>

Shell Thickness	2 ± 0.2 mm (sagging: <1%)
Filling Volume	Approx. 30 liters
Dimensions	Major ellipse axis: 600 mm Minor axis: 400 mm



The ELI phantom is intended for compliance testing of handheld and body-mounted wireless devices in the frequency range of 30 MHz to 6 GHz. ELI4 is fully compatible with standard and all known tissue simulating liquids.

7.4 Device Holder

<Mounting Device for Hand-Held Transmitter>

In combination with the Twin SAM V5.0/V5.0c or ELI phantoms, the Mounting Device for Hand-Held Transmitters enables rotation of the mounted transmitter device to specified spherical coordinates. At the heads, the rotation axis is at the ear opening. Transmitter devices can be easily and accurately positioned according to IEC 62209-1, IEEE 1528, FCC, or other specifications. The device holder can be locked for positioning at different phantom sections (left head, right head, flat). And upgrade kit to Mounting Device to enable easy mounting of wider devices like big smart-phones, e-books, small tablets, etc. It holds devices with width up to 140 mm.



Mounting Device for Hand-Held Transmitters



Mounting Device Adaptor for Wide-Phones

<Mounting Device for Laptops and other Body-Worn Transmitters>

The extension is lightweight and made of POM, acrylic glass and foam. It fits easily on the upper part of the mounting device in place of the phone positioned. The extension is fully compatible with the SAM Twin and ELI phantoms.



Mounting Device for Laptops



8. Measurement Procedures

The measurement procedures are as follows:

<Conducted power measurement>

- (a) For WWAN power measurement, use base station simulator to configure EUT WWAN transmission in conducted connection with RF cable, at maximum power in each supported wireless interface and frequency band.
- (b) Read the WWAN RF power level from the base station simulator.
- (c) For WLAN/BT power measurement, use engineering software to configure EUT WLAN/BT continuously transmission, at maximum RF power in each supported wireless interface and frequency band
- (d) Connect EUT RF port through RF cable to the power meter, and measure WLAN/BT output power

<SAR measurement>

- (a) Use base station simulator to configure EUT WWAN transmission in radiated connection, and engineering software to configure EUT WLAN/BT continuously transmission, at maximum RF power, in the highest power channel.
- (b) Place the EUT in the positions as Appendix D demonstrates.
- (c) Set scan area, grid size and other setting on the DASY software.
- (d) Measure SAR results for the highest power channel on each testing position.
- (e) Find out the largest SAR result on these testing positions of each band
- (f) Measure SAR results for other channels in worst SAR testing position if the reported SAR of highest power channel is larger than 0.8 W/kg

According to the test standard, the recommended procedure for assessing the peak spatial-average SAR value consists of the following steps:

- (a) Power reference measurement
- (b) Area scan
- (c) Zoom scan
- (d) Power drift measurement

8.1 Spatial Peak SAR Evaluation

The procedure for spatial peak SAR evaluation has been implemented according to the test standard. It can be conducted for 1g and 10g, as well as for user-specific masses. The DASY software includes all numerical procedures necessary to evaluate the spatial peak SAR value.

The base for the evaluation is a "cube" measurement. The measured volume must include the 1g and 10g cubes with the highest averaged SAR values. For that purpose, the center of the measured volume is aligned to the interpolated peak SAR value of a previously performed area scan.

The entire evaluation of the spatial peak values is performed within the post-processing engine (SEMCAD). The system always gives the maximum values for the 1g and 10g cubes. The algorithm to find the cube with highest averaged SAR is divided into the following stages:

- (a) Extraction of the measured data (grid and values) from the Zoom Scan
- (b) Calculation of the SAR value at every measurement point based on all stored data (A/D values and measurement parameters)
- (c) Generation of a high-resolution mesh within the measured volume
- (d) Interpolation of all measured values from the measurement grid to the high-resolution grid
- (e) Extrapolation of the entire 3-D field distribution to the phantom surface over the distance from sensor to surface
- (f) Calculation of the averaged SAR within masses of 1g and 10g

8.2 Power Reference Measurement

The Power Reference Measurement and Power Drift Measurements are for monitoring the power drift of the device under test in the batch process. The minimum distance of probe sensors to surface determines the closest measurement point to phantom surface. This distance cannot be smaller than the distance of sensor calibration points to probe tip as defined in the probe properties.

8.3 Area Scan

The area scan is used as a fast scan in two dimensions to find the area of high field values, before doing a fine measurement around the hot spot. The sophisticated interpolation routines implemented in DASY software can find the maximum found in the scanned area, within a range of the global maximum. The range (in dB) is specified in the standards for compliance testing. For example, a 2 dB range is required in IEEE standard 1528 and IEC 62209 standards, whereby 3 dB is a requirement when compliance is assessed in accordance with the ARIB standard (Japan), if only one zoom scan follows the area scan, then only the absolute maximum will be taken as reference. For cases where multiple maximums are detected, the number of zoom scans has to be increased accordingly.

Area scan parameters extracted from FCC KDB 865664 D01v01r04 SAR measurement 100 MHz to 6 GHz.

	≤ 3 GHz	> 3 GHz
Maximum distance from closest measurement point (geometric center of probe sensors) to phantom surface	5 ± 1 mm	$\frac{1}{2} \cdot \delta \cdot \ln(2) \pm 0.5$ mm
Maximum probe angle from probe axis to phantom surface normal at the measurement location	30° ± 1°	20° ± 1°
Maximum area scan spatial resolution: Δx_{Area} , Δy_{Area}	≤ 2 GHz: ≤ 15 mm 2 – 3 GHz: ≤ 12 mm	3 – 4 GHz: ≤ 12 mm 4 – 6 GHz: ≤ 10 mm
	When the x or y dimension of the test device, in the measurement plane orientation, is smaller than the above, the measurement resolution must be ≤ the corresponding x or y dimension of the test device with at least one measurement point on the test device.	

8.4 Zoom Scan

Zoom scans are used assess the peak spatial SAR values within a cubic averaging volume containing 1 gram and 10 gram of simulated tissue. The zoom scan measures points (refer to table below) within a cube shoes base faces are centered on the maxima found in a preceding area scan job within the same procedure. When the measurement is done, the zoom scan evaluates the averaged SAR for 1 gram and 10 gram and displays these values next to the job's label.

Zoom scan parameters extracted from FCC KDB 865664 D01v01r04 SAR measurement 100 MHz to 6 GHz.

		≤ 3 GHz	> 3 GHz	
Maximum zoom scan spatial resolution: $\Delta x_{Zoom}, \Delta y_{Zoom}$		≤ 2 GHz: ≤ 8 mm 2 – 3 GHz: ≤ 5 mm*	3 – 4 GHz: ≤ 5 mm* 4 – 6 GHz: ≤ 4 mm*	
Maximum zoom scan spatial resolution, normal to phantom surface	uniform grid: $\Delta z_{Zoom}(n)$	≤ 5 mm	3 – 4 GHz: ≤ 4 mm 4 – 5 GHz: ≤ 3 mm 5 – 6 GHz: ≤ 2 mm	
	graded grid	$\Delta z_{Zoom}(1)$: between 1 st two points closest to phantom surface	≤ 4 mm	3 – 4 GHz: ≤ 3 mm 4 – 5 GHz: ≤ 2.5 mm 5 – 6 GHz: ≤ 2 mm
		$\Delta z_{Zoom}(n>1)$: between subsequent points	$\leq 1.5 \cdot \Delta z_{Zoom}(n-1)$	
Minimum zoom scan volume	x, y, z	≥ 30 mm	3 – 4 GHz: ≥ 28 mm 4 – 5 GHz: ≥ 25 mm 5 – 6 GHz: ≥ 22 mm	
Note: δ is the penetration depth of a plane-wave at normal incidence to the tissue medium; see draft standard IEEE P1528-2011 for details. * When zoom scan is required and the <i>reported</i> SAR from the <i>area scan based 1-g SAR estimation</i> procedures of KDB 447498 is ≤ 1.4 W/kg, ≤ 8 mm, ≤ 7 mm and ≤ 5 mm zoom scan resolution may be applied, respectively, for 2 GHz to 3 GHz, 3 GHz to 4 GHz and 4 GHz to 6 GHz.				

8.5 Volume Scan Procedures

The volume scan is used for assess overlapping SAR distributions for antennas transmitting in different frequency bands. It is equivalent to an oversized zoom scan used in standalone measurements. The measurement volume will be used to enclose all the simultaneous transmitting antennas. For antennas transmitting simultaneously in different frequency bands, the volume scan is measured separately in each frequency band. In order to sum correctly to compute the 1g aggregate SAR, the EUT remain in the same test position for all measurements and all volume scan use the same spatial resolution and grid spacing. When all volume scan were completed, the software, SEMCAD postprocessor can combine and subsequently superpose these measurement data to calculating the multiband SAR.

8.6 Power Drift Monitoring

All SAR testing is under the EUT install full charged battery and transmit maximum output power. In DASy measurement software, the power reference measurement and power drift measurement procedures are used for monitoring the power drift of EUT during SAR test. Both these procedures measure the field at a specified reference position before and after the SAR testing. The software will calculate the field difference in dB. If the power drifts more than 5%, the SAR will be retested.



9. Test Equipment List

Manufacturer	Name of Equipment	Type/Model	Serial Number	Calibration	
				Last Cal.	Due Date
SPEAG	835MHz System Validation Kit	D835V2	4d091	2016/11/22	2017/11/21
SPEAG	1750MHz System Validation Kit	D1750V2	1069	2016/11/23	2017/11/22
SPEAG	1900MHz System Validation Kit	D1900V2	5d118	2016/11/24	2017/11/23
SPEAG	2450MHz System Validation Kit	D2450V2	840	2016/11/25	2017/11/24
SPEAG	2600MHz System Validation Kit	D2600V2	1061	2016/11/24	2017/11/23
SPEAG	5000MHz System Validation Kit	D5GHzV2	1113	2016/12/13	2017/12/12
SPEAG	Data Acquisition Electronics	DAE4	1210	2017/5/25	2018/5/24
SPEAG	Dosimetric E-Field Probe	EX3DV4	3857	2017/5/26	2018/5/25
SPEAG	SAM Twin Phantom	QD 000 P40 CB	TP-1644	NCR	NCR
SPEAG	SAM Twin Phantom	QD 000 P40 CB	TP-1542	NCR	NCR
SPEAG	SAM Twin Phantom	QD 000 P40 CB	TP-1164	NCR	NCR
SPEAG	Phone Positioner	N/A	N/A	NCR	NCR
Anritsu	Radio communication analyzer	MT8820C	6201563814	2017/1/19	2018/1/18
Agilent	Wireless Communication Test Set	E5515C	MY52102706	2017/4/18	2018/4/17
Agilent	ENA Series Network Analyzer	E5071C	MY46111157	2017/4/18	2018/4/17
SPEAG	DAK Kit	DAK3.5	1144	2016/11/23	2017/11/22
R&S	Signal Generator	SMR40	100455	2017/1/19	2018/1/18
Anritsu	Power Sensor	MA2411B	1644003	2016/12/23	2017/12/22
Anritsu	Power Meter	ML2495A	1531197	2016/12/23	2017/12/22
Anritsu	Power Sensor	MA2411B	1644004	2016/12/23	2017/12/22
Anritsu	Power Meter	ML2495A	1531198	2016/12/23	2017/12/22
R&S	CBT BLUETOOTH TESTER	CBT	100783	2017/8/8	2018/8/7
EXA	Spectrum Analyzer	N9010A	MY55150244	2017/4/18	2018/4/17
WISEWIND	Hygrometer	WISEWIND 0905	0905	2017/4/20	2018/4/19
JM	DIGITAC THERMOMETER	JM222	AA1207166	2017/4/19	2018/4/18
ARRA	Power Divider	A3200-2	N/A		Note
Agilent	Dual Directional Coupler	778D	50422		Note
PASTERNAK	Dual Directional Coupler	PE2214-10	N/A		Note
MCL	Attenuation1	BW-S10W5+	N/A		Note
MCL	Attenuation2	BW-S10W5+	N/A		Note
MCL	Attenuation3	BW-S10W5+	N/A		Note
AR	Amplifier	5S1G4	333096		Note
mini-circuits	Amplifier	ZVE-3W-83+	162601250		Note

Note:

Prior to system verification and validation, the path loss from the signal generator to the system check source and the power meter, which includes the amplifier, cable, attenuator and directional coupler, was measured by the network analyzer. The reading of the power meter was offset by the path loss difference between the path to the power meter and the path to the system check source to monitor the actual power level fed to the system check.

10. System Verification

10.1 Tissue Simulating Liquids

For the measurement of the field distribution inside the SAM phantom with DASY, the phantom must be filled with around 25 liters of homogeneous body tissue simulating liquid. For head SAR testing, the liquid height from the ear reference point (ERP) of the phantom to the liquid top surface is larger than 15 cm, which is shown in Fig. 10.1. For body SAR testing, the liquid height from the center of the flat phantom to the liquid top surface is larger than 15 cm, which is shown in Fig. 10.2.



Fig 10.1 Photo of Liquid Height for Head SAR

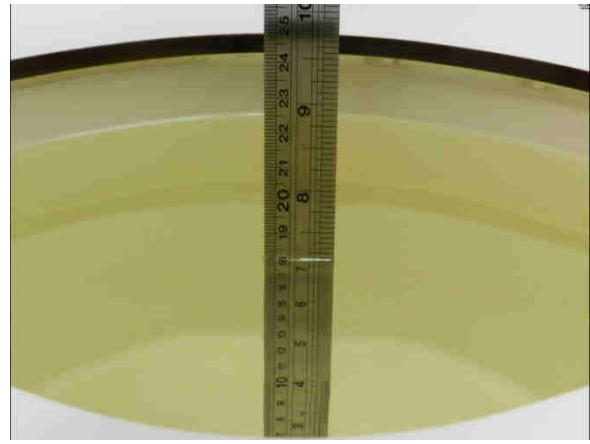

Fig 10.2 Photo of Liquid Height for Body SAR



10.2 Tissue Verification

The following tissue formulations are provided for reference only as some of the parameters have not been thoroughly verified. The composition of ingredients may be modified accordingly to achieve the desired target tissue parameters required for routine SAR evaluation.

Frequency (MHz)	Water (%)	Sugar (%)	Cellulose (%)	Salt (%)	Preventol (%)	DGBE (%)	Conductivity (σ)	Permittivity (ϵ_r)
For Head								
835	40.3	57.9	0.2	1.4	0.2	0	0.90	41.5
1800, 1900, 2000	55.2	0	0	0.3	0	44.5	1.40	40.0
2450	55.0	0	0	0	0	45.0	1.80	39.2
2600	54.8	0	0	0.1	0	45.1	1.96	39.0
For Body								
835	50.8	48.2	0	0.9	0.1	0	0.97	55.2
1800, 1900, 2000	70.2	0	0	0.4	0	29.4	1.52	53.3
2450	68.6	0	0	0	0	31.4	1.95	52.7
2600	68.1	0	0	0.1	0	31.8	2.16	52.5

Simulating Liquid for 5GHz, Manufactured by SPEAG

Ingredients	(% by weight)
Water	64~78%
Mineral oil	11~18%
Emulsifiers	9~15%
Additives and Salt	2~3%

<Tissue Dielectric Parameter Check Results>

Frequency (MHz)	Tissue Type	Liquid Temp. (°C)	Conductivity (σ)	Permittivity (ϵ_r)	Conductivity Target (σ)	Permittivity Target (ϵ_r)	Delta (σ) (%)	Delta (ϵ_r) (%)	Limit (%)	Date
835	Head	22.8	0.909	42.380	0.90	41.50	1.00	2.12	±5	2017/9/16
1750	Head	22.7	1.362	39.639	1.37	40.10	-0.58	-1.15	±5	2017/9/16
1900	Head	22.7	1.385	39.334	1.40	40.00	-1.07	-1.66	±5	2017/9/16
2450	Head	22.5	1.877	38.333	1.80	39.20	4.28	-2.21	±5	2017/9/20
2600	Head	22.8	2.050	37.758	1.96	39.00	4.59	-3.18	±5	2017/9/16
5250	Head	22.6	4.631	36.749	4.71	35.90	-1.68	2.36	±5	2017/9/21
5600	Head	22.9	5.039	35.963	5.07	35.50	-0.61	1.30	±5	2017/9/21
5750	Head	22.9	5.221	35.639	5.22	35.40	0.02	0.68	±5	2017/9/21
835	Body	22.8	0.977	55.111	0.97	55.20	0.72	-0.16	±5	2017/9/12
1750	Body	22.7	1.460	53.900	1.49	53.40	-2.01	0.94	±5	2017/9/17
1900	Body	22.7	1.556	53.612	1.52	53.30	2.37	0.59	±5	2017/9/17
2450	Body	22.5	1.961	52.567	1.95	52.70	0.56	-0.25	±5	2017/9/21
2600	Body	22.7	2.166	52.048	2.16	52.50	0.28	-0.86	±5	2017/9/18
5250	Body	22.7	5.382	47.699	5.36	48.90	0.41	-2.46	±5	2017/9/23
5600	Body	22.6	5.888	46.875	5.77	48.50	2.05	-3.35	±5	2017/9/24
5750	Body	22.7	5.901	46.562	5.94	48.30	-0.66	-3.60	±5	2017/9/23

10.3 System Performance Check Results

Comparing to the original SAR value provided by SPEAG, the verification data should be within its specification of 10 %. Below table shows the target SAR and measured SAR after normalized to 1W input power. The table below indicates the system performance check can meet the variation criterion and the plots can be referred to Appendix A of this report.

<1g SAR>

Date	Frequency (MHz)	Tissue Type	Input Power (mW)	Dipole S/N	Probe S/N	DAE S/N	Measured 1g SAR (W/kg)	Targeted 1g SAR (W/kg)	Normalized 1g SAR (W/kg)	Deviation (%)
2017/9/16	835	Head	250	4d091	3857	1210	2.44	9.31	9.76	4.83
2017/9/16	1750	Head	250	1069	3857	1210	9.55	37.50	38.20	1.87
2017/9/16	1900	Head	250	5d118	3857	1210	9.52	40.40	38.08	-5.74
2017/9/20	2450	Head	250	840	3857	1210	12.90	54.00	51.60	-4.44
2017/9/16	2600	Head	250	1061	3857	1210	14.30	56.00	57.20	2.14
2017/9/21	5250	Head	100	1113	3857	1210	7.68	76.40	76.80	0.52
2017/9/21	5600	Head	100	1113	3857	1210	7.78	80.80	77.80	-3.71
2017/9/21	5750	Head	100	1113	3857	1210	7.71	80.30	77.10	-3.99
2017/9/12	835	Body	250	4d091	3857	1210	2.49	9.68	9.96	2.89
2017/9/17	1750	Body	250	1069	3857	1210	9.14	37.70	36.56	-3.02
2017/9/17	1900	Body	250	5d118	3857	1210	9.79	40.80	39.16	-4.02
2017/9/21	2450	Body	250	840	3857	1210	12.60	50.90	50.40	-0.98
2017/9/18	2600	Body	250	1061	3857	1210	13.30	55.40	53.20	-3.97
2017/9/23	5250	Body	100	1113	3857	1210	7.11	76.10	71.10	-6.57
2017/9/24	5600	Body	100	1113	3857	1210	7.57	79.80	75.70	-5.14
2017/9/23	5750	Body	100	1113	3857	1210	7.21	75.20	72.10	-4.12

<10g SAR>

Date	Frequency (MHz)	Tissue Type	Input Power (mW)	Dipole S/N	Probe S/N	DAE S/N	Measured 10g SAR (W/kg)	Targeted 10g SAR (W/kg)	Normalized 1g SAR (W/kg)	Deviation (%)
2017/9/17	1750	Body	250	1069	3857	1210	4.94	20.3	19.76	-2.66
2017/9/17	1900	Body	250	5d118	3857	1210	5.09	21.3	20.36	-4.41
2017/9/18	2600	Body	250	1061	3857	1210	6.18	25.4	24.72	-2.68
2017/9/23	5250	Body	100	1113	3857	1210	2.11	21.5	21.1	-1.86
2017/9/24	5600	Body	100	1113	3857	1210	2.21	22.6	22.1	-2.21

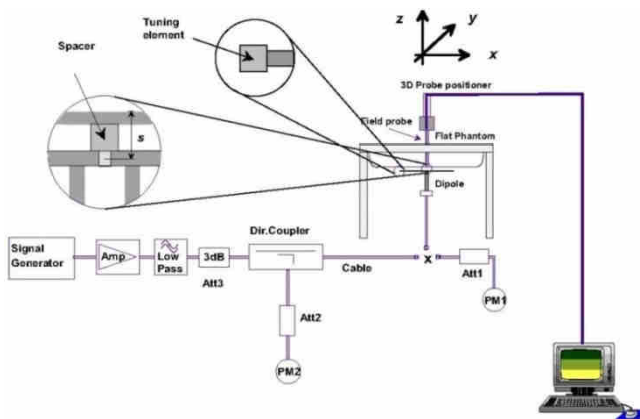

Fig 8.3.1 System Performance Check Setup



Fig 8.3.2 Setup Photo

11. RF Exposure Positions

11.1 Ear and handset reference point

Figure 9.1.1 shows the front, back, and side views of the SAM phantom. The center-of-mouth reference point is labeled “M,” the left ear reference point (ERP) is marked “LE,” and the right ERP is marked “RE.” Each ERP is 15 mm along the B-M (back-mouth) line behind the entrance-to-ear-canal (EEC) point, as shown in Figure 9.1.2 The Reference Plane is defined as passing through the two ear reference points and point M. The line N-F (neck-front), also called the reference pivoting line, is normal to the Reference Plane and perpendicular to both a line passing through RE and LE and the B-M line (see Figure 9.1.3). Both N-F and B-M lines should be marked on the exterior of the phantom shell to facilitate handset positioning. Posterior to the N-F line the ear shape is a flat surface with 6 mm thickness at each ERP, and forward of the N-F line the ear is truncated, as illustrated in Figure 9.1.2. The ear truncation is introduced to preclude the ear lobe from interfering with handset tilt, which could lead to unstable positioning at the cheek.

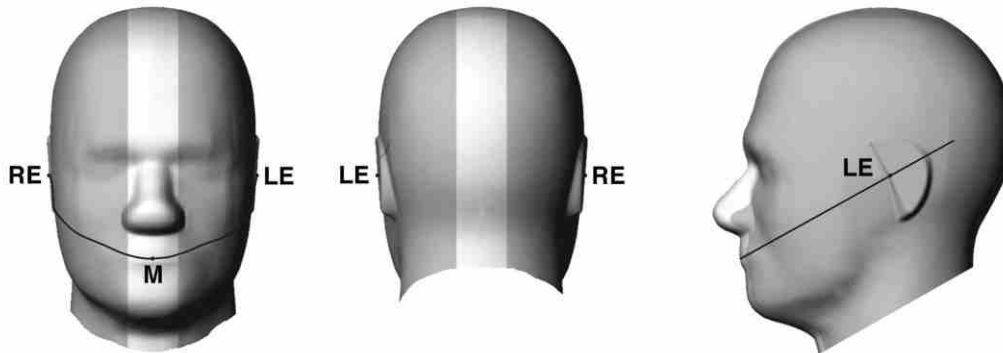

Fig 9.1.1 Front, back, and side views of SAM twin phantom

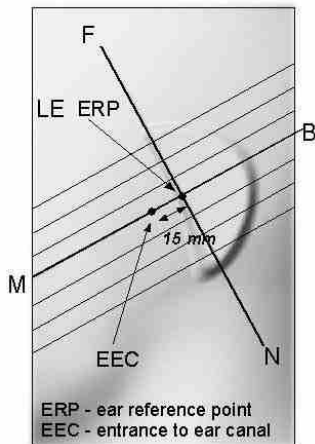

Fig 9.1.2 Close-up side view of phantom showing the ear region.

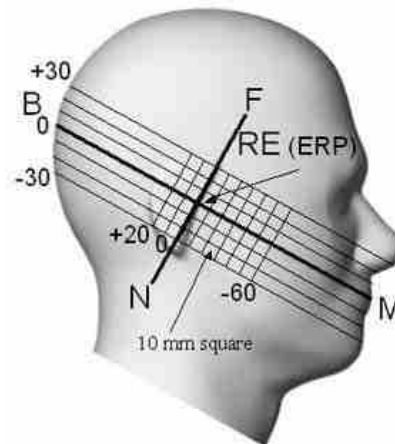

Fig 9.1.3 Side view of the phantom showing relevant markings and seven cross-sectional plane locations

11.2 Definition of the cheek position

1. Ready the handset for talk operation, if necessary. For example, for handsets with a cover piece (flip cover), open the cover. If the handset can transmit with the cover closed, both configurations must be tested.
2. Define two imaginary lines on the handset—the vertical centerline and the horizontal line. The vertical centerline passes through two points on the front side of the handset—the midpoint of the width w_t of the handset at the level of the acoustic output (point A in Figure 9.2.1 and Figure 9.2.2), and the midpoint of the width w_b of the bottom of the handset (point B). The horizontal line is perpendicular to the vertical centerline and passes through the center of the acoustic output (see Figure 9.2.1). The two lines intersect at point A. Note that for many handsets, point A coincides with the center of the acoustic output; however, the acoustic output may be located elsewhere on the horizontal line. Also note that the vertical centerline is not necessarily parallel to the front face of the handset (see Figure 9.2.2), especially for clamshell handsets, handsets with flip covers, and other irregularly-shaped handsets.
3. Position the handset close to the surface of the phantom such that point A is on the (virtual) extension of the line passing through points RE and LE on the phantom (see Figure 9.2.3), such that the plane defined by the vertical centerline and the horizontal line of the handset is approximately parallel to the sagittal plane of the phantom.
4. Translate the handset towards the phantom along the line passing through RE and LE until handset point A touches the pinna at the ERP.
5. While maintaining the handset in this plane, rotate it around the LE-RE line until the vertical centerline is in the plane normal to the plane containing B-M and N-F lines, i.e., the Reference Plane.
6. Rotate the handset around the vertical centerline until the handset (horizontal line) is parallel to the N-F line.
7. While maintaining the vertical centerline in the Reference Plane, keeping point A on the line passing through RE and LE, and maintaining the handset contact with the pinna, rotate the handset about the N-F line until any point on the handset is in contact with a phantom point below the pinna on the cheek. See Figure 9.2.3. The actual rotation angles should be documented in the test report.

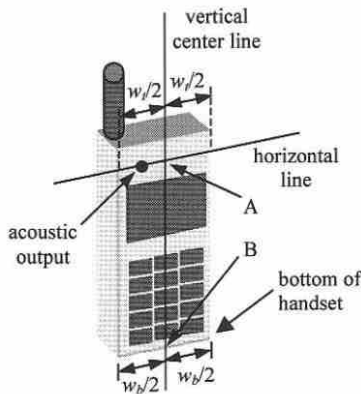

Fig 9.2.1 Handset vertical and horizontal reference lines—“fixed case”

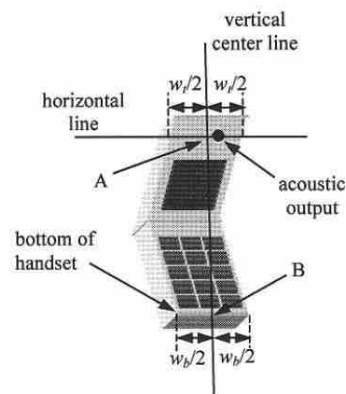

Fig 9.2.2 Handset vertical and horizontal reference lines—“clam-shell case”

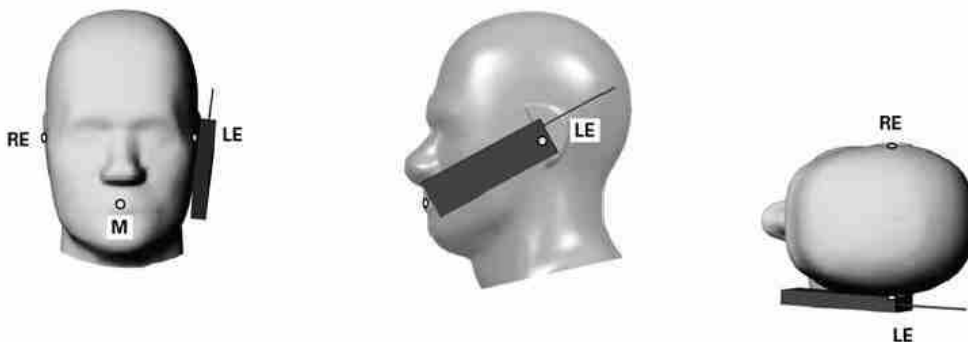

Fig 9.2.3 cheek or touch position. The reference points for the right ear (RE), left ear (LE), and mouth (M), which establish the Reference Plane for handset positioning, are indicated.

11.3 Definition of the tilt position

1. Ready the handset for talk operation, if necessary. For example, for handsets with a cover piece (flip cover), open the cover. If the handset can transmit with the cover closed, both configurations must be tested.
2. While maintaining the orientation of the handset, move the handset away from the pinna along the line passing through RE and LE far enough to allow a rotation of the handset away from the cheek by 15°.
3. Rotate the handset around the horizontal line by 15°.
4. While maintaining the orientation of the handset, move the handset towards the phantom on the line passing through RE and LE until any part of the handset touches the ear. The tilt position is obtained when the contact point is on the pinna. See Figure 9.3.1. If contact occurs at any location other than the pinna, e.g., the antenna at the back of the phantom head, the angle of the handset should be reduced. In this case, the tilt position is obtained if any point on the handset is in contact with the pinna and a second point

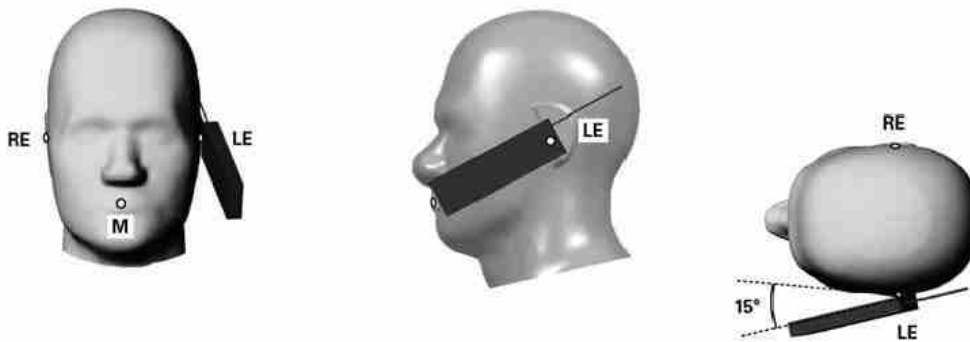

Fig 9.3.1 Tilt position. The reference points for the right ear (RE), left ear (LE), and mouth (M), which define the Reference Plane for handset positioning, are indicated.

11.4 Body Worn Accessory

Body-worn operating configurations are tested with the belt-clips and holsters attached to the device and positioned against a flat phantom in a normal use configuration (see Figure 9.4). Per KDB648474 D04v01r03, body-worn accessory exposure is typically related to voice mode operations when handsets are carried in body-worn accessories. The body-worn accessory procedures in FCC KDB 447498 D01v06 should be used to test for body-worn accessory SAR compliance, without a headset connected to it. This enables the test results for such configuration to be compatible with that required for hotspot mode when the body-worn accessory test separation distance is greater than or equal to that required for hotspot mode, when applicable. When the reported SAR for body-worn accessory, measured without a headset connected to the handset is $> 1.2 \text{ W/kg}$, the highest reported SAR configuration for that wireless mode and frequency band should be repeated for that body-worn accessory with a handset attached to the handset.

Accessories for body-worn operation configurations are divided into two categories: those that do not contain metallic components and those that do contain metallic components. When multiple accessories that do not contain metallic components are supplied with the device, the device is tested with only the accessory that dictates the closest spacing to the body. Then multiple accessories that contain metallic components are test with the device with each accessory. If multiple accessories share an identical metallic component (i.e. the same metallic belt-chip used with different holsters with no other metallic components) only the accessory that dictates the closest spacing to the body is tested.

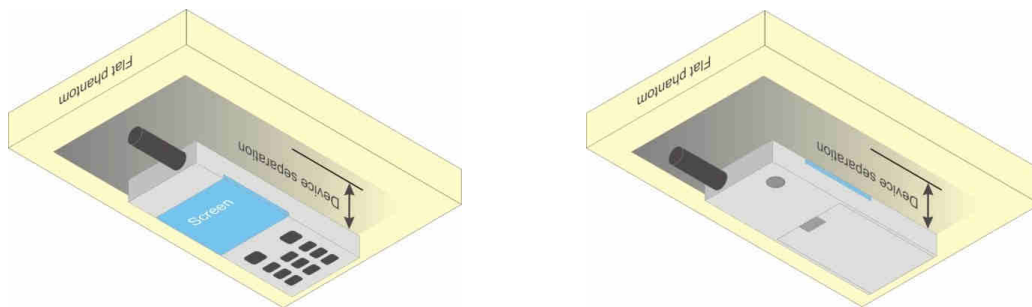

Fig 9.4 Body Worn Position



11.5 Extremity Exposure

For smart phones with a display diagonal dimension > 15.0 cm or an overall diagonal dimension > 16.0 cm that provide similar mobile web access and multimedia support found in mini-tablets or UMPC mini-tablets that support voice calls next to the ear, According to KDB648474 D04v01r03, the following phablet procedures should be applied to evaluate SAR compliance for each applicable wireless modes and frequency band. Devices marketed as phablets, regardless of form factors and operating characteristics must be tested as a phablet to determine SAR compliance

1. The normally required head and body-worn accessory SAR test procedures for handsets, including hotspot mode, must be applied.
2. The UMPC mini-tablet procedures must also be applied to test the SAR of all surfaces and edges with an antenna located at ≤ 25 mm from that surface or edge, in direct contact with a flat phantom, for 10-g extremity SAR according to the body-equivalent tissue dielectric parameters in KDB 865664 to address interactive hand use exposure conditions.6 The UMPC mini-tablet 1-g SAR at 5 mm is not required. When hotspot mode applies, 10-g extremity SAR is required only for the surfaces and edges with hotspot mode 1-g reported SAR > 1.2 W/kg.

11.6 Wireless Router

Some battery-operated handsets have the capability to transmit and receive user through simultaneous transmission of WIFI simultaneously with a separate licensed transmitter. The FCC has provided guidance in FCC KDB Publication 941225 D06 v02r01 where SAR test considerations for handsets ($L \times W \geq 9$ cm x 5 cm) are based on a composite test separation distance of 10mm from the front, back and edges of the device containing transmitting antennas within 2.5cm of their edges, determined from general mixed use conditions for this type of devices. Since the hotspot SAR results may overlap with the body-worn accessory SAR requirements, the more conservative configurations can be considered, thus excluding some body-worn accessory SAR tests.

When the user enables the personal wireless router functions for the handset, actual operations include simultaneous transmission of both the WIFI transmitter and another licensed transmitter. Both transmitters often do not transmit at the same transmitting frequency and thus cannot be evaluated for SAR under actual use conditions due to the limitations of the SAR assessment probes. Therefore, SAR must be evaluated for each frequency transmission and mode separately and spatially summed with the WIFI transmitter according to FCC KDB Publication 447498 D01v06 publication procedures. The "Portable Hotspot" feature on the handset was NOT activated during SAR assessments, to ensure the SAR measurements were evaluated for a single transmission frequency RF signal at a time.



12. Conducted RF Output Power (Unit: dBm)

<GSM Conducted Power>

- Per KDB 447498 D01v06, the maximum output power channel is used for SAR testing and for further SAR test reduction.
- Per KDB 941225 D01v03r01, for SAR test reduction for GSM / GPRS / EDGE modes is determined by the source-based time-averaged output power including tune-up tolerance. The mode with highest specified time-averaged output power should be tested for SAR compliance in the applicable exposure conditions. For modes with the same specified maximum output power and tolerance, the higher number time-slot configuration should be tested. Therefore, the GPRS (4Tx slots) for GSM850 and the GPRS (1Tx slot) for GSM1900 are considered as the primary mode.
- Other configurations of GSM / GPRS / EDGE are considered as secondary modes. The 3G SAR test reduction procedure is applied, when the maximum output power and tune-up tolerance specified for production units in a secondary mode is $\leq \frac{1}{4}$ dB higher than the primary mode, SAR measurement is not required for the secondary mode.

<Full Power Mode>

GSM850 Tx Channel	Burst Average Power (dBm)			Tune-up Limit (dBm)	Frame-Average Power (dBm)			Tune-up Limit (dBm)
	128	189	251		128	189	251	
Frequency (MHz)	824.2	836.4	848.8		824.2	836.4	848.8	
GSM 1 Tx slot	33.85	33.91	33.55	34.00	24.85	24.91	24.55	25.00
GPRS 1 Tx slot	33.84	33.90	33.54	34.00	24.84	24.90	24.54	25.00
GPRS 2 Tx slots	30.32	30.52	30.53	31.00	24.32	24.52	24.53	25.00
GPRS 3 Tx slots	28.50	28.75	28.80	29.00	24.24	24.49	24.54	24.74
GPRS 4 Tx slots	27.44	27.63	27.35	28.00	24.44	24.63	24.35	25.00
EDGE 1 Tx slot	26.25	26.45	26.58	27.00	17.25	17.45	17.58	18.00
EDGE 2 Tx slots	23.90	24.04	24.21	24.50	17.90	18.04	18.21	18.50
EDGE 3 Tx slots	23.10	23.21	23.30	23.50	18.84	18.95	19.04	19.24
EDGE 4 Tx slots	21.90	22.10	22.28	22.50	18.90	19.10	19.28	19.50
GSM1900								
	Burst Average Power (dBm)			Tune-up Limit (dBm)	Frame-Average Power (dBm)			Tune-up Limit (dBm)
Tx Channel	512	661	810		512	661	810	
Frequency (MHz)	1850.2	1880	1909.8		1850.2	1880	1909.8	
GSM 1 Tx slot	29.22	29.40	29.45	30.00	20.22	20.40	20.45	21.00
GPRS 1 Tx slot	29.21	29.40	29.43	30.00	20.21	20.40	20.43	21.00
GPRS 2 Tx slots	25.46	25.57	25.52	26.00	19.46	19.57	19.52	20.00
GPRS 3 Tx slots	23.85	23.90	23.83	24.50	19.59	19.64	19.57	20.24
GPRS 4 Tx slots	21.50	21.50	21.35	22.00	18.50	18.50	18.35	19.00
EDGE 1 Tx slot	25.67	25.67	25.57	26.00	16.67	16.67	16.57	17.00
EDGE 2 Tx slots	23.50	23.55	23.31	24.00	17.50	17.55	17.31	18.00
EDGE 3 Tx slots	21.03	20.96	20.73	21.50	16.77	16.70	16.47	17.24
EDGE 4 Tx slots	17.94	17.90	17.59	18.50	14.94	14.90	14.59	15.50

Remark: The frame-averaged power is linearly scaled the maximum burst averaged power over 8 time slots.

The calculated method are shown as below:

- Frame-averaged power = Maximum burst averaged power (1 Tx Slot) - 9 dB
- Frame-averaged power = Maximum burst averaged power (2 Tx Slots) - 6 dB
- Frame-averaged power = Maximum burst averaged power (3 Tx Slots) - 4.26 dB
- Frame-averaged power = Maximum burst averaged power (4 Tx Slots) - 3 dB

<WCDMA Conducted Power>

1. The following tests were conducted according to the test requirements outlines in 3GPP TS 34.121 specification.
2. The procedures in KDB 941225 D01v03r01 are applied for 3GPP Rel. 6 HSPA to configure the device in the required sub-test mode(s) to determine SAR test exclusion.
3. For DC-HSDPA, the device was configured according to the H-Set 12, Fixed Reference Channel (FRC) configuration in Table C.8.1.12 of 3GPP TS 34.121-1, with the primary and the secondary serving HS-DSCH Cell enabled during the power measurement.

A summary of these settings are illustrated below:

HSDPA Setup Configuration:

- a. The EUT was connected to Base Station Agilent E5515C referred to the Setup Configuration.
- b. The RF path losses were compensated into the measurements.
- c. A call was established between EUT and Base Station with following setting:
 - i. Set Gain Factors (β_c and β_d) and parameters were set according to each
 - ii. Specific sub-test in the following table, C10.1.4, quoted from the TS 34.121
 - iii. Set RMC 12.2Kbps + HSDPA mode.
 - iv. Set Cell Power = -86 dBm
 - v. Set HS-DSCH Configuration Type to FRC (H-set 1, QPSK)
 - vi. Select HSDPA Uplink Parameters
 - vii. Set Delta ACK, Delta NACK and Delta CQI = 8
 - viii. Set Ack-Nack Repetition Factor to 3
 - ix. Set CQI Feedback Cycle (k) to 4 ms
 - x. Set CQI Repetition Factor to 2
 - xi. Power Ctrl Mode = All Up bits
- d. The transmitted maximum output power was recorded.

Table C.10.1.4: β values for transmitter characteristics tests with HS-DPCCH

Sub-test	β_c	β_d	β_d (SF)	β_c/β_d	β_{HS} (Note 1, Note 2)	CM (dB) (Note 3)	MPR (dB) (Note 3)
1	2/15	15/15	64	2/15	4/15	0.0	0.0
2	12/15 (Note 4)	15/15 (Note 4)	64	12/15 (Note 4)	24/15	1.0	0.0
3	15/15	8/15	64	15/8	30/15	1.5	0.5
4	15/15	4/15	64	15/4	30/15	1.5	0.5

Note 1: Δ_{ACK} , Δ_{NACK} and $\Delta_{CQI} = 30/15$ with $\beta_{HS} = 30/15 * \beta_c$.

Note 2: For the HS-DPCCH power mask requirement test in clause 5.2C, 5.7A, and the Error Vector Magnitude (EVM) with HS-DPCCH test in clause 5.13.1A, and HSDPA EVM with phase discontinuity in clause 5.13.1AA, Δ_{ACK} and $\Delta_{NACK} = 30/15$ with $\beta_{HS} = 30/15 * \beta_c$, and $\Delta_{CQI} = 24/15$ with $\beta_{HS} = 24/15 * \beta_c$.

Note 3: CM = 1 for $\beta_c/\beta_d = 12/15$, $\beta_{HS}/\beta_c = 24/15$. For all other combinations of DPCCH, DPDCCH and HS-DPCCH the MPR is based on the relative CM difference. This is applicable for only UEs that support HSDPA in release 6 and later releases.

Note 4: For subtest 2 the β_c/β_d ratio of 12/15 for the TFC during the measurement period (TF1, TF0) is achieved by setting the signalled gain factors for the reference TFC (TF1, TF1) to $\beta_c = 11/15$ and $\beta_d = 15/15$.

Setup Configuration

HSUPA Setup Configuration:

- a. The EUT was connected to Base Station Agilent E5515C referred to the Setup Configuration.
- b. The RF path losses were compensated into the measurements.
- c. A call was established between EUT and Base Station with following setting * :
 - i. Call Configs = 5.2B, 5.9B, 5.10B, and 5.13.2B with QPSK
 - ii. Set the Gain Factors (β_c and β_d) and parameters (AG Index) were set according to each specific sub-test in the following table, C11.1.3, quoted from the TS 34.121
 - iii. Set Cell Power = -86 dBm
 - iv. Set Channel Type = 12.2k + HSPA
 - v. Set UE Target Power
 - vi. Power Ctrl Mode= Alternating bits
 - vii. Set and observe the E-TFCl
 - viii. Confirm that E-TFCl is equal to the target E-TFCl of 75 for sub-test 1, and other subtest's E-TFCl
- d. The transmitted maximum output power was recorded.

Table C.11.1.3: β values for transmitter characteristics tests with HS-DPCCH and E-DCH

Sub-test	β_c	β_d	β_d (SF)	β_c/β_d	β_{HS} (Note 1)	β_{EC}	β_{ed} (Note 4) (Note 5)	β_{ed} (SF)	β_{ed} (Codes)	CM (dB) (Note 2)	MPR (dB) (Note 2) (Note 6)	AG Index (Note 5)	E-TFCl
1	11/15 (Note 3)	15/15 (Note 3)	64	11/15 (Note 3)	22/15	209/25	1309/225	4	1	1.0	0.0	20	75
2	6/15	15/15	64	6/15	12/15	12/15	94/75	4	1	3.0	2.0	12	67
3	15/15	9/15	64	15/9	30/15	30/15	$\beta_{ed1}: 47/15$ $\beta_{ed2}: 47/15$	4	2	2.0	1.0	15	92
4	2/15	15/15	64	2/15	4/15	2/15	56/75	4	1	3.0	2.0	17	71
5	15/15	0	-	-	5/15	5/15	47/15	4	1	1.0	0.0	12	67

Note 1: For sub-test 1 to 4, Δ_{ACK} , Δ_{NACK} and $\Delta_{CQI} = 30/15$ with $\beta_{HS} = 30/15 * \beta_c$. For sub-test 5, Δ_{ACK} , Δ_{NACK} and $\Delta_{CQI} = 5/15$ with $\beta_{HS} = 5/15 * \beta_c$.

Note 2: CM = 1 for $\beta_c/\beta_d = 12/15$, $\beta_{HS}/\beta_c = 24/15$. For all other combinations of DPDCH, DPCCH, HS-DPCCH, E-DPDCH and E-DPCCH the MPR is based on the relative CM difference.

Note 3: For subtest 1 the β_c/β_d ratio of 11/15 for the TFC during the measurement period (TF1, TF0) is achieved by setting the signalled gain factors for the reference TFC (TF1, TF1) to $\beta_c = 10/15$ and $\beta_d = 15/15$.

Note 4: In case of testing by UE using E-DPDCH Physical Layer category 1, Sub-test 3 is omitted according to TS25.306 Table 5.1g.

Note 5: β_{ed} can not be set directly; it is set by Absolute Grant Value.

Note 6: For subtests 2, 3 and 4, UE may perform E-DPDCH power scaling at max power which could results in slightly smaller MPR values.

Setup Configuration

DC-HSDPA 3GPP release 8 Setup Configuration:

- a. The EUT was connected to Base Station Agilent E5515C referred to the Setup Configuration below
- b. The RF path losses were compensated into the measurements.
- c. A call was established between EUT and Base Station with following setting:
 - i. Set RMC 12.2Kbps + HSDPA mode.
 - ii. Set Cell Power = -25 dBm
 - iii. Set HS-DSCH Configuration Type to FRC (H-set 12, QPSK)
 - iv. Select HSDPA Uplink Parameters
 - v. Set Gain Factors (β_c and β_d) and parameters were set according to each Specific sub-test in the following table, C10.1.4, quoted from the TS 34.121
 - a). Subtest 1: $\beta_c/\beta_d=2/15$
 - b). Subtest 2: $\beta_c/\beta_d=12/15$
 - c). Subtest 3: $\beta_c/\beta_d=15/8$
 - d). Subtest 4: $\beta_c/\beta_d=15/4$
 - vi. Set Delta ACK, Delta NACK and Delta CQI = 8
 - vii. Set Ack-Nack Repetition Factor to 3
 - viii. Set CQI Feedback Cycle (k) to 4 ms
 - ix. Set CQI Repetition Factor to 2
 - x. Power Ctrl Mode = All Up bits
- d. The transmitted maximum output power was recorded.

The following tests were conducted according to the test requirements outlines in 3GPP TS 34.121 specification. A summary of these settings are illustrated below:

C.8.1.12 Fixed Reference Channel Definition H-Set 12

Table C.8.1.12: Fixed Reference Channel H-Set 12

Parameter	Unit	Value
Nominal Avg. Inf. Bit Rate	kbps	60
Inter-TTI Distance	TTI's	1
Number of HARQ Processes	Processes	6
Information Bit Payload (N_{inf})	Bits	120
Number Code Blocks	Blocks	1
Binary Channel Bits Per TTI	Bits	960
Total Available SML's in UE	SML's	19200
Number of SML's per HARQ Proc.	SML's	3200
Coding Rate		0.15
Number of Physical Channel Codes	Codes	1
Modulation		QPSK
Note 1: The RMC is intended to be used for DC-HSDPA mode and both cells shall transmit with identical parameters as listed in the table. Note 2: Maximum number of transmission is limited to 1, i.e., retransmission is not allowed. The redundancy and constellation version 0 shall be used.		

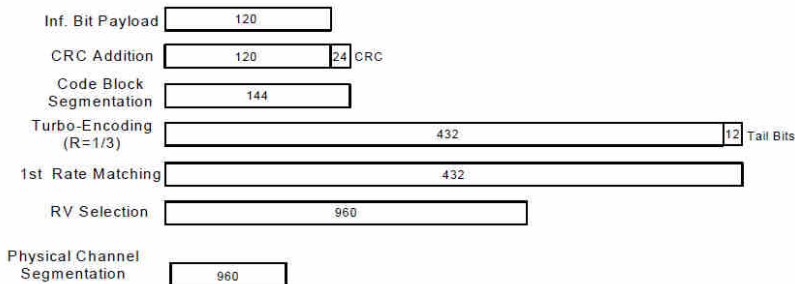

Figure C.8.19: Coding rate for Fixed reference Channel H-Set 12 (QPSK)

Setup Configuration



<WCDMA Conducted Power>

General Note:

1. Per KDB 941225 D01v03r01, for SAR testing is measured using a 12.2 kbps RMC with TPC bits configured to all "1's".
2. Per KDB 941225 D01v03r01, RMC 12.2kbps setting is used to evaluate SAR. The maximum output power and tune-up tolerance specified for production units in HSDPA / HSUPA / DC-HSDPA is ≤ ¼ dB higher than RMC 12.2Kbps or when the highest reported SAR of the RMC12.2Kbps is scaled by the ratio of specified maximum output power and tune-up tolerance of HSDPA / HSUPA / DC-HSDPA to RMC12.2Kbps and the adjusted SAR is ≤ 1.2 W/kg, SAR measurement is not required for HSDPA / HSUPA / DC-HSDPA, and according to the following RF output power, the output power results of the secondary modes (HSUPA, HSDPA, DC-HSDPA) are less than ¼ dB higher than the primary modes; therefore, SAR measurement is not required for HSDPA / HSUPA / DC-HSDPA.

<Full Power Mode>

Band		WCDMA Band II			Tune-up Limit (dBm)	WCDMA Band V			Tune-up Limit (dBm)
Tx Channel		9262	9400	9538		4132	4182	4233	
Rx Channel		9662	9800	9938		4357	4407	4458	
Frequency (MHz)		1852.4	1880	1907.6		826.4	836.4	846.6	
3GPP Rel 99	AMR 12.2Kbps	23.44	23.26	23.30	24.00	23.62	23.40	23.65	24.00
3GPP Rel 99	RMC 12.2Kbps	23.46	23.28	23.31	24.00	23.64	23.40	23.67	24.00
3GPP Rel 6	HSDPA Subtest-1	22.28	22.24	22.07	22.50	22.28	22.12	22.43	23.00
3GPP Rel 6	HSDPA Subtest-2	22.43	22.35	22.24	22.50	22.38	22.18	22.44	23.00
3GPP Rel 6	HSDPA Subtest-3	21.92	21.87	21.77	22.00	21.91	21.72	21.97	22.50
3GPP Rel 6	HSDPA Subtest-4	21.93	21.90	21.76	22.00	21.91	21.73	21.98	22.50
3GPP Rel 8	DC-HSDPA Subtest-1	21.81	21.49	21.39	22.50	22.38	22.27	22.31	23.00
3GPP Rel 8	DC-HSDPA Subtest-2	21.74	21.50	21.36	22.50	22.36	22.25	22.32	23.00
3GPP Rel 8	DC-HSDPA Subtest-3	21.78	21.57	21.37	22.00	22.37	22.23	22.35	22.50
3GPP Rel 8	DC-HSDPA Subtest-4	21.81	21.56	21.49	22.00	22.33	22.17	22.30	22.50
3GPP Rel 6	HSUPA Subtest-1	22.35	22.22	22.17	22.50	22.26	22.18	22.30	22.50
3GPP Rel 6	HSUPA Subtest-2	20.35	20.14	19.95	20.50	20.30	20.17	20.35	20.50
3GPP Rel 6	HSUPA Subtest-3	21.42	21.19	21.13	21.50	21.28	21.15	21.34	21.50
3GPP Rel 6	HSUPA Subtest-4	20.43	20.22	19.99	20.50	20.38	20.23	20.46	20.50
3GPP Rel 6	HSUPA Subtest-5	22.28	22.13	22.07	22.50	22.30	22.20	22.30	22.50

<Reduced Power Mode for Hotspot On>

Band		WCDMA Band II			Tune-up Limit (dBm)
Tx Channel		9262	9400	9538	
Rx Channel		9662	9800	9938	
Frequency (MHz)		1852.4	1880	1907.6	
3GPP Rel 99	AMR 12.2Kbps	20.61	20.44	20.60	21.00
3GPP Rel 99	RMC 12.2Kbps	20.62	20.45	20.61	21.00
3GPP Rel 6	HSDPA Subtest-1	19.40	19.41	19.40	20.00
3GPP Rel 6	HSDPA Subtest-2	19.54	19.54	19.54	20.00
3GPP Rel 6	HSDPA Subtest-3	19.05	19.07	19.08	19.50
3GPP Rel 6	HSDPA Subtest-4	19.05	19.07	19.09	19.50
3GPP Rel 8	DC-HSDPA Subtest-1	18.92	18.68	18.69	20.00
3GPP Rel 8	DC-HSDPA Subtest-2	18.87	18.70	18.67	20.00
3GPP Rel 8	DC-HSDPA Subtest-3	18.90	18.74	18.70	19.50
3GPP Rel 8	DC-HSDPA Subtest-4	18.92	18.75	18.79	19.50
3GPP Rel 6	HSUPA Subtest-1	19.48	19.42	19.48	20.00
3GPP Rel 6	HSUPA Subtest-2	17.47	17.31	17.28	18.00
3GPP Rel 6	HSUPA Subtest-3	18.53	18.38	18.43	19.00
3GPP Rel 6	HSUPA Subtest-4	17.56	17.42	17.30	18.00
3GPP Rel 6	HSUPA Subtest-5	19.40	19.30	19.40	20.00



<LTE Conducted Power>

General Note:

1. Anritsu MT8820C base station simulator was used to setup the connection with EUT; the frequency band, channel bandwidth, RB allocation configuration, modulation type are set in the base station simulator to configure EUT transmitting at maximum power and at different configurations which are requested to be reported to FCC, for conducted power measurement and SAR testing.
2. Per KDB 941225 D05v02r05, when a properly configured base station simulator is used for the SAR and power measurements, spectrum plots for each RB allocation and offset configuration is not required.
3. Per KDB 941225 D05v02r05, start with the largest channel bandwidth and measure SAR for QPSK with 1 RB allocation, using the RB offset and required test channel combination with the highest maximum output power for RB offsets at the upper edge, middle and lower edge of each required test channel.
4. Per KDB 941225 D05v02r05, 50% RB allocation for QPSK SAR testing follows 1RB QPSK allocation procedure.
5. Per KDB 941225 D05v02r05, For QPSK with 100% RB allocation, SAR is not required when the highest maximum output power for 100 % RB allocation is less than the highest maximum output power in 50% and 1 RB allocations and the highest reported SAR for 1 RB and 50% RB allocation are ≤ 0.8 W/kg. Otherwise, SAR is measured for the highest output power channel; and if the reported SAR is > 1.45 W/kg, the remaining required test channels must also be tested.
6. Per KDB 941225 D05v02r05, 16QAM output power for each RB allocation configuration is $>$ not $\frac{1}{2}$ dB higher than the same configuration in QPSK and the reported SAR for the QPSK configuration is ≤ 1.45 W/kg; Per KDB 941225 D05v02r05, 16QAM SAR testing is not required.
7. Per KDB 941225 D05v02r05, Smaller bandwidth output power for each RB allocation configuration is $>$ not $\frac{1}{2}$ dB higher than the same configuration in the largest supported bandwidth, and the reported SAR for the largest supported bandwidth is ≤ 1.45 W/kg; Per KDB 941225 D05v02r05, smaller bandwidth SAR testing is not required.
8. For LTE B4 / B5 / B38 the maximum bandwidth does not support three non-overlapping channels, per KDB 941225 D05v02r05, when a device supports overlapping channel assignment in a channel bandwidth configuration, the middle channel of the group of overlapping channels should be selected for testing.



<Full Power Mode>

<LTE Band 4>

BW [MHz]	Modulation	RB Size	RB Offset	Power Low Ch. / Freq.	Power Middle Ch. / Freq.	Power High Ch. / Freq.	Tune-up limit (dBm)	MPR (dB)
Channel				20050	20175	20300		
Frequency (MHz)				1720	1732.5	1745		
20	QPSK	1	0	23.39	23.25	23.49	24	0
20	QPSK	1	49	23.57	23.48	23.59		
20	QPSK	1	99	23.36	23.37	23.27		
20	QPSK	50	0	22.62	22.42	22.72	23	1
20	QPSK	50	24	22.44	22.34	22.69		
20	QPSK	50	50	22.49	22.39	22.61		
20	QPSK	100	0	22.47	22.47	22.68	23	1
20	16QAM	1	0	22.56	22.27	22.34		
20	16QAM	1	49	22.24	22.16	22.45		
20	16QAM	1	99	22.12	22.1	22.33	22	2
20	16QAM	50	0	21.46	21.37	21.63		
20	16QAM	50	24	21.2	21.39	21.7		
20	16QAM	50	50	21.44	21.2	21.56	22	2
20	16QAM	100	0	21.3	21.35	21.67		
Channel				20025	20175	20325		
Frequency (MHz)				1717.5	1732.5	1747.5		
15	QPSK	1	0	23.63	23.28	23.62	24	0
15	QPSK	1	37	23.76	23.35	23.57		
15	QPSK	1	74	23.22	23.35	23.15		
15	QPSK	36	0	22.63	22.45	22.74	23	1
15	QPSK	36	20	22.53	22.41	22.64		
15	QPSK	36	39	22.44	22.41	22.56		
15	QPSK	75	0	22.44	22.42	22.58	23	1
15	16QAM	1	0	22.57	22.34	22.56		
15	16QAM	1	37	22.62	22.15	22.27		
15	16QAM	1	74	22.29	22.05	22.35	22	2
15	16QAM	36	0	21.51	21.34	21.7		
15	16QAM	36	20	21.47	21.37	21.62		
15	16QAM	36	39	21.39	21.22	21.56	22	2
15	16QAM	75	0	21.28	21.4	21.57		



Channel				20000	20175	20350	Tune-up limit (dBm)	MPR (dB)
Frequency (MHz)				1715	1732.5	1750		
10	QPSK	1	0	23.37	23.18	23.71	24	0
10	QPSK	1	25	23.63	23.44	23.49		
10	QPSK	1	49	23.07	23.31	23.36		
10	QPSK	25	0	22.58	22.41	22.64	23	1
10	QPSK	25	12	22.5	22.39	22.63		
10	QPSK	25	25	22.47	22.37	22.63		
10	QPSK	50	0	22.5	22.38	22.57	23	1
10	16QAM	1	0	22.43	22.15	22.59		
10	16QAM	1	25	22.25	22.11	22.4		
10	16QAM	1	49	22.15	21.93	22.38	22	2
10	16QAM	25	0	21.62	21.37	21.61		
10	16QAM	25	12	21.53	21.55	21.63		
10	16QAM	25	25	21.5	21.26	21.57	22	2
10	16QAM	50	0	21.42	21.37	21.4		
Channel				19975	20175	20375	Tune-up limit (dBm)	MPR (dB)
Frequency (MHz)				1712.5	1732.5	1752.5		
5	QPSK	1	0	23.21	23.21	23.37	24	0
5	QPSK	1	12	23.72	23.36	23.66		
5	QPSK	1	24	23.43	23.05	23.27		
5	QPSK	12	0	22.65	22.36	22.65	23	1
5	QPSK	12	7	22.49	22.33	22.6		
5	QPSK	12	13	22.53	22.42	22.62		
5	QPSK	25	0	22.53	22.42	22.57	23	1
5	16QAM	1	0	22.36	22.09	22.32		
5	16QAM	1	12	22.19	22.08	22.3		
5	16QAM	1	24	22.16	22.03	22.3	22	2
5	16QAM	12	0	21.31	21.44	21.41		
5	16QAM	12	7	21.25	21.43	21.56		
5	16QAM	12	13	21.28	21.5	21.44	22	2
5	16QAM	25	0	21.26	21.5	21.61		



Channel				19965	20175	20385	Tune-up limit (dBm)	MPR (dB)
Frequency (MHz)				1711.5	1732.5	1753.5		
3	QPSK	1	0	23.53	23.08	23.35	24	0
3	QPSK	1	8	23.7	23.29	23.6		
3	QPSK	1	14	23.24	23.09	23.11		
3	QPSK	8	0	22.74	22.48	22.43	23	1
3	QPSK	8	4	22.61	22.55	22.43		
3	QPSK	8	7	22.67	22.5	22.45		
3	QPSK	15	0	22.76	22.48	22.46	23	1
3	16QAM	1	0	22.78	22.28	22.25		
3	16QAM	1	8	22.31	22.14	22.24		
3	16QAM	1	14	22.4	22.3	21.62	22	2
3	16QAM	8	0	21.58	21.47	21.28		
3	16QAM	8	4	21.49	21.36	21.26		
3	16QAM	8	7	21.49	21.42	21.42	22	2
3	16QAM	15	0	21.66	21.25	21.27		
Channel				19957	20175	20393	Tune-up limit (dBm)	MPR (dB)
Frequency (MHz)				1710.7	1732.5	1754.3		
1.4	QPSK	1	0	23.69	23.4	23.46	24	0
1.4	QPSK	1	3	23.75	23.4	23.53		
1.4	QPSK	1	5	23.52	23.33	23.44		
1.4	QPSK	3	0	23.74	23.43	23.51		
1.4	QPSK	3	1	23.69	23.38	23.68		
1.4	QPSK	3	3	23.79	23.43	23.58		
1.4	QPSK	6	0	22.68	22.35	22.5	23	1
1.4	16QAM	1	0	22.41	22.21	22.28	23	1
1.4	16QAM	1	3	22.44	22.18	22.19		
1.4	16QAM	1	5	22.49	22.21	22.08		
1.4	16QAM	3	0	22.47	22.37	22.73		
1.4	16QAM	3	1	22.85	22.48	22.69		
1.4	16QAM	3	3	22.95	22.47	22.71		
1.4	16QAM	6	0	21.64	21.27	21.37	22	2



<LTE Band 5>

BW [MHz]	Modulation	RB Size	RB Offset	Power Low Ch. / Freq.	Power Middle Ch. / Freq.	Power High Ch. / Freq.	Tune-up limit (dBm)	MPR (dB)
Channel				20450	20525	20600		
Frequency (MHz)				829	836.5	844		
10	QPSK	1	0	23.09	23.23	22.99	24	0
10	QPSK	1	25	23.3	23.25	23.59		
10	QPSK	1	49	23.22	22.94	23.54		
10	QPSK	25	0	22.45	22.34	22.46	23	1
10	QPSK	25	12	22.36	22.32	22.3		
10	QPSK	25	25	22.39	22.26	22.4		
10	QPSK	50	0	22.36	22.29	22.42	23	1
10	16QAM	1	0	22.11	22.14	22.09		
10	16QAM	1	25	22.42	22.03	22.24		
10	16QAM	1	49	22.14	22.09	22.25	22	2
10	16QAM	25	0	21.36	21.41	21.31		
10	16QAM	25	12	21.4	21.35	21.42		
10	16QAM	25	25	21.37	21.26	21.65	22	2
10	16QAM	50	0	21.5	21.37	21.4		
Channel				20425	20525	20625		
Frequency (MHz)				826.5	836.5	846.5		
5	QPSK	1	0	22.68	22.58	22.64	24	0
5	QPSK	1	12	23	22.87	23.37		
5	QPSK	1	24	22.61	22.52	22.66		
5	QPSK	12	0	22.16	21.99	22.14	23	1
5	QPSK	12	7	22.05	22.01	22.11		
5	QPSK	12	13	22.03	22.06	22.12		
5	QPSK	25	0	22.16	22.03	22.16	23	1
5	16QAM	1	0	21.8	21.59	21.13		
5	16QAM	1	12	21.89	21.79	22.18		
5	16QAM	1	24	21.79	21.39	21.68	22	2
5	16QAM	12	0	21.12	20.98	20.72		
5	16QAM	12	7	21.1	21.05	20.93		
5	16QAM	12	13	21.2	21.01	21.11	22	2
5	16QAM	25	0	21.02	21.01	21.12		



Channel				20415	20525	20635	Tune-up limit (dBm)	MPR (dB)
Frequency (MHz)				825.5	836.5	847.5		
3	QPSK	1	0	22.92	22.72	22.94	24	0
3	QPSK	1	8	23.06	23.04	23.42		
3	QPSK	1	14	22.82	22.61	22.95		
3	QPSK	8	0	22.21	22.29	22.27	23	1
3	QPSK	8	4	22.17	22.09	22.2		
3	QPSK	8	7	22.06	22.1	22.2		
3	QPSK	15	0	22.13	21.98	22.06	23	1
3	16QAM	1	0	22.05	21.76	21.95		
3	16QAM	1	8	21.81	21.84	22.22		
3	16QAM	1	14	21.85	21.86	21.9	22	2
3	16QAM	8	0	21.29	21.1	21.18		
3	16QAM	8	4	20.84	20.8	21.07		
3	16QAM	8	7	20.77	20.77	21.23	22	2
3	16QAM	15	0	21.2	21.02	21.15		
Channel				20407	20525	20643	Tune-up limit (dBm)	MPR (dB)
Frequency (MHz)				824.7	836.5	848.3		
1.4	QPSK	1	0	22.83	22.89	22.96	24	0
1.4	QPSK	1	3	22.86	22.99	23.05		
1.4	QPSK	1	5	22.86	22.76	23.08		
1.4	QPSK	3	0	23.13	23.1	23.05		
1.4	QPSK	3	1	23.3	23.15	23.15		
1.4	QPSK	3	3	23.3	22.88	23.17		
1.4	QPSK	6	0	22.03	21.97	21.99	23	1
1.4	16QAM	1	0	22.03	22.44	21.98	23	1
1.4	16QAM	1	3	22.12	21.98	21.98		
1.4	16QAM	1	5	22.21	22.1	22.13		
1.4	16QAM	3	0	22.26	22.23	22.05		
1.4	16QAM	3	1	22.49	22.3	22.13		
1.4	16QAM	3	3	21.95	22.34	22.05		
1.4	16QAM	6	0	20.87	20.96	21.1	22	2



<LTE Band 7>

BW [MHz]	Modulation	RB Size	RB Offset	Power Low Ch. / Freq.	Power Middle Ch. / Freq.	Power High Ch. / Freq.	Tune-up limit (dBm)	MPR (dB)
Channel				20850	21100	21350		
Frequency (MHz)				2510	2535	2560		
20	QPSK	1	0	23.2	23.67	23.54	24	0
20	QPSK	1	49	23.72	23.56	23.86		
20	QPSK	1	99	23.26	23.73	23.46		
20	QPSK	50	0	22.34	22.66	22.7	23	1
20	QPSK	50	24	22.33	22.59	22.63		
20	QPSK	50	50	22.48	22.58	22.66		
20	QPSK	100	0	22.16	22.61	22.64	23	1
20	16QAM	1	0	22.09	22.46	22.45		
20	16QAM	1	49	22.19	22.42	22.49		
20	16QAM	1	99	22.1	22.36	22.69	22	2
20	16QAM	50	0	21.49	21.58	21.66		
20	16QAM	50	24	21.63	21.63	21.67		
20	16QAM	50	50	21.46	21.47	21.76	22	2
20	16QAM	100	0	21.46	21.45	21.69		
Channel				20825	21100	21375	Tune-up limit (dBm)	MPR (dB)
Frequency (MHz)				2507.5	2535	2562.5		
15	QPSK	1	0	23.13	23.68	23.67	24	0
15	QPSK	1	37	23.64	23.83	23.52		
15	QPSK	1	74	23.34	23.57	23.65		
15	QPSK	36	0	22.55	22.56	22.74	23	1
15	QPSK	36	20	22.44	22.63	22.7		
15	QPSK	36	39	22.46	22.66	22.76		
15	QPSK	75	0	22.49	22.57	22.7	23	1
15	16QAM	1	0	22.13	22.42	22.56		
15	16QAM	1	37	22.18	22.38	22.48		
15	16QAM	1	74	22.28	22.38	22.76	22	2
15	16QAM	36	0	21.45	21.55	21.64		
15	16QAM	36	20	21.76	21.62	21.57		
15	16QAM	36	39	21.5	21.6	21.84	22	2
15	16QAM	75	0	21.23	21.46	21.58		



Channel				20800	21100	21400	Tune-up limit (dBm)	MPR (dB)
Frequency (MHz)				2505	2535	2565		
10	QPSK	1	0	23.13	23.72	23.5	24	0
10	QPSK	1	25	23.3	23.49	23.89		
10	QPSK	1	49	23.03	23.45	23.62		
10	QPSK	25	0	22.5	22.59	22.66	23	1
10	QPSK	25	12	22.4	22.61	22.72		
10	QPSK	25	25	22.43	22.58	22.7		
10	QPSK	50	0	22.36	22.54	22.64	23	1
10	16QAM	1	0	22.06	22.42	22.62		
10	16QAM	1	25	22.49	22.41	22.61		
10	16QAM	1	49	22.14	22.41	22.6	22	2
10	16QAM	25	0	21.31	21.69	21.72		
10	16QAM	25	12	21.51	21.58	21.86		
10	16QAM	25	25	21.71	21.59	21.82	22	2
10	16QAM	50	0	21.57	21.63	21.66		
Channel				20775	21100	21425	Tune-up limit (dBm)	MPR (dB)
Frequency (MHz)				2502.5	2535	2567.5		
5	QPSK	1	0	22.91	23.27	23.17	24	0
5	QPSK	1	12	23.24	23.85	23.62		
5	QPSK	1	24	22.92	23.11	23.65		
5	QPSK	12	0	22.21	22.6	22.57	23	1
5	QPSK	12	7	22.31	22.69	22.68		
5	QPSK	12	13	22.3	22.54	22.66		
5	QPSK	25	0	22.29	22.55	22.65	23	1
5	16QAM	1	0	22.24	22.29	22.47		
5	16QAM	1	12	22	22.01	22.79		
5	16QAM	1	24	22.02	22.28	22.33	22	2
5	16QAM	12	0	21.17	21.31	21.67		
5	16QAM	12	7	21.38	21.31	21.62		
5	16QAM	12	13	21.12	21.37	21.59	22	2
5	16QAM	25	0	21.33	21.47	21.59		



<Reduced Power Mode for Hotspot On>

<LTE Band 4>

BW [MHz]	Modulation	RB Size	RB Offset	Power Low Ch. / Freq.	Power Middle Ch. / Freq.	Power High Ch. / Freq.	Tune-up limit (dBm)	MPR (dB)
Channel				20050	20175	20300		
Frequency (MHz)				1720	1732.5	1745		
20	QPSK	1	0	20.13	19.94	20.03	21	0
20	QPSK	1	49	20.79	20.38	20.81		
20	QPSK	1	99	19.74	19.84	20.49		
20	QPSK	50	0	20.31	20.13	20.45	21	0
20	QPSK	50	24	20.17	20.06	20.44		
20	QPSK	50	50	20.22	20.05	20.3		
20	QPSK	100	0	20.17	20.08	20.47		
20	16QAM	1	0	20.31	20.08	20.15	21	0
20	16QAM	1	49	20.03	19.96	20.12		
20	16QAM	1	99	19.85	19.81	20.05		
20	16QAM	50	0	20.31	20.19	20.22	21	0
20	16QAM	50	24	20.14	20.13	20.51		
20	16QAM	50	50	20.23	20.12	20.36		
20	16QAM	100	0	20.14	20.15	20.44		
Channel				20025	20175	20325	Tune-up limit (dBm)	MPR (dB)
Frequency (MHz)				1717.5	1732.5	1747.5		
15	QPSK	1	0	20.28	20.09	20.17	21	0
15	QPSK	1	37	20.58	20.38	20.44		
15	QPSK	1	74	20.3	20.1	20.27		
15	QPSK	36	0	20.38	20.09	20.46	21	0
15	QPSK	36	20	20.32	20.12	20.31		
15	QPSK	36	39	20.18	20.14	20.33		
15	QPSK	75	0	20.13	20.14	20.28		
15	16QAM	1	0	20.19	20.06	20.35	21	0
15	16QAM	1	37	20	19.88	20.09		
15	16QAM	1	74	20.01	20.03	20.09		
15	16QAM	36	0	20.39	20.15	20.4	21	0
15	16QAM	36	20	20.28	20.08	20.32		
15	16QAM	36	39	20.09	20.2	20.22		
15	16QAM	75	0	20.31	20.2	20.32		



Channel				20000	20175	20350	Tune-up limit (dBm)	MPR (dB)
Frequency (MHz)				1715	1732.5	1750		
10	QPSK	1	0	20.1	19.79	20.2	21	0
10	QPSK	1	25	20.69	19.97	20.5		
10	QPSK	1	49	19.78	19.79	20.05		
10	QPSK	25	0	20.39	20.11	20.3	21	0
10	QPSK	25	12	20.3	20.08	20.36		
10	QPSK	25	25	20.25	20.09	20.31		
10	QPSK	50	0	20.21	20.08	20.34	21	0
10	16QAM	1	0	20.29	19.89	20.21		
10	16QAM	1	25	19.99	19.81	20.04		
10	16QAM	1	49	19.89	19.82	20.1	21	0
10	16QAM	25	0	20.51	20.14	20.43		
10	16QAM	25	12	20.51	20.16	20.33		
10	16QAM	25	25	20.33	20.05	20.37	21	0
10	16QAM	50	0	20.11	20.14	20.4		
Channel				19975	20175	20375		
Frequency (MHz)				1712.5	1732.5	1752.5		
5	QPSK	1	0	20.33	19.63	20.18	21	0
5	QPSK	1	12	20.56	20.31	20.32		
5	QPSK	1	24	20.19	19.65	19.91		
5	QPSK	12	0	20.28	20.16	20.34	21	0
5	QPSK	12	7	20.3	20.22	20.43		
5	QPSK	12	13	20.25	20.13	20.33		
5	QPSK	25	0	20.26	20.13	20.3	21	0
5	16QAM	1	0	20.02	19.83	20		
5	16QAM	1	12	19.94	19.88	19.98		
5	16QAM	1	24	19.84	19.8	19.75	21	0
5	16QAM	12	0	20.23	19.94	20.48		
5	16QAM	12	7	20.33	20.09	20.44		
5	16QAM	12	13	20.56	20.1	20.29	21	0
5	16QAM	25	0	20.36	20.12	20.35		



Channel				19965	20175	20385	Tune-up limit (dBm)	MPR (dB)
Frequency (MHz)				1711.5	1732.5	1753.5		
3	QPSK	1	0	20.14	19.92	19.99	21	0
3	QPSK	1	8	20.33	20.1	20.13		
3	QPSK	1	14	20.05	19.9	19.81		
3	QPSK	8	0	20.27	20.08	20.29	21	0
3	QPSK	8	4	20.28	20.15	20.19		
3	QPSK	8	7	20.26	20.12	20.14		
3	QPSK	15	0	20.29	20.18	20.21	21	0
3	16QAM	1	0	20.17	19.89	20.01		
3	16QAM	1	8	19.94	20.2	19.57		
3	16QAM	1	14	20.4	20.19	19.96	21	0
3	16QAM	8	0	20.79	20.46	20.18		
3	16QAM	8	4	20.33	20.06	20.08		
3	16QAM	8	7	20.31	20.13	20.14	21	0
3	16QAM	15	0	20.4	20.01	20.06		
Channel				19957	20175	20393	Tune-up limit (dBm)	MPR (dB)
Frequency (MHz)				1710.7	1732.5	1754.3		
1.4	QPSK	1	0	20.27	20.09	19.92	21	0
1.4	QPSK	1	3	20.33	20.11	19.89		
1.4	QPSK	1	5	20.28	20.16	19.83		
1.4	QPSK	3	0	20.42	20.24	20.24		
1.4	QPSK	3	1	20.57	20.26	20.33		
1.4	QPSK	3	3	20.39	20.06	20.17		
1.4	QPSK	6	0	20.22	20.03	20.14	21	0
1.4	16QAM	1	0	20.11	19.86	19.97	21	0
1.4	16QAM	1	3	20.13	19.85	19.95		
1.4	16QAM	1	5	20.19	19.92	19.99		
1.4	16QAM	3	0	20.45	20.15	20.22		
1.4	16QAM	3	1	20.57	20.13	20.21		
1.4	16QAM	3	3	20.51	20.1	20.27		
1.4	16QAM	6	0	20.3	19.93	20.07	21	0



<LTE Band 7>

BW [MHz]	Modulation	RB Size	RB Offset	Power Low Ch. / Freq.	Power Middle Ch. / Freq.	Power High Ch. / Freq.	Tune-up limit (dBm)	MPR (dB)
Channel				20850	21100	21350		
Frequency (MHz)				2510	2535	2560		
20	QPSK	1	0	20.95	21.24	21.32	22.5	0
20	QPSK	1	49	21.57	21.99	21.81		
20	QPSK	1	99	21.22	21.27	21.79		
20	QPSK	50	0	21.44	21.74	21.68	22.5	0
20	QPSK	50	24	21.36	21.6	21.64		
20	QPSK	50	50	21.41	21.64	21.61		
20	QPSK	100	0	21.37	21.65	21.64	22.5	0
20	16QAM	1	0	21.59	21.43	21.19		
20	16QAM	1	49	20.75	21.46	21.63		
20	16QAM	1	99	21.13	21.45	21.73	22.5	0
20	16QAM	50	0	21.37	21.64	21.79		
20	16QAM	50	24	21.44	21.5	21.69		
20	16QAM	50	50	21.33	21.44	21.81	22.5	0
20	16QAM	100	0	21.35	21.64	21.76		
Channel				20825	21100	21375		
Frequency (MHz)				2507.5	2535	2562.5		
15	QPSK	1	0	21.19	21.56	21.42	22.5	0
15	QPSK	1	37	21.56	21.77	21.68		
15	QPSK	1	74	21.5	21.57	21.75		
15	QPSK	36	0	21.36	21.65	21.73	22.5	0
15	QPSK	36	20	21.48	21.62	21.73		
15	QPSK	36	39	21.4	21.71	21.79		
15	QPSK	75	0	21.46	21.66	21.66	22.5	0
15	16QAM	1	0	21.19	21.52	21.59		
15	16QAM	1	37	21.23	21.75	21.38		
15	16QAM	1	74	21.33	21.44	21.75	22.5	0
15	16QAM	36	0	21.43	21.64	21.68		
15	16QAM	36	20	21.58	21.63	21.63		
15	16QAM	36	39	21.39	21.53	21.72	22.5	0
15	16QAM	75	0	21.45	21.76	21.8		



Channel				20800	21100	21400	Tune-up limit (dBm)	MPR (dB)
Frequency (MHz)				2505	2535	2565		
10	QPSK	1	0	21.13	21.31	21.42	22.5	0
10	QPSK	1	25	21.28	21.53	21.69		
10	QPSK	1	49	21.06	21.31	21.47		
10	QPSK	25	0	21.38	21.65	21.64	22.5	0
10	QPSK	25	12	21.41	21.6	21.77		
10	QPSK	25	25	21.47	21.61	21.72		
10	QPSK	50	0	21.33	21.63	21.68	22.5	0
10	16QAM	1	0	20.93	21.35	21.52		
10	16QAM	1	25	21.12	21.38	21.49		
10	16QAM	1	49	21.09	21.31	21.51	22.5	0
10	16QAM	25	0	21.37	21.61	21.74		
10	16QAM	25	12	21.36	21.91	21.83		
10	16QAM	25	25	21.46	21.64	21.73	22.5	0
10	16QAM	50	0	21.52	21.69	21.83		
Channel				20775	21100	21425	Tune-up limit (dBm)	MPR (dB)
Frequency (MHz)				2502.5	2535	2567.5		
5	QPSK	1	0	20.81	21.31	21.43	22.5	0
5	QPSK	1	12	21.44	21.5	21.83		
5	QPSK	1	24	20.85	21.21	21.32		
5	QPSK	12	0	21.31	21.64	21.72	22.5	0
5	QPSK	12	7	21.32	21.66	21.77		
5	QPSK	12	13	21.31	21.54	21.75		
5	QPSK	25	0	21.28	21.56	21.68	22.5	0
5	16QAM	1	0	21.37	21.27	21.41		
5	16QAM	1	12	21.57	21.3	21.38		
5	16QAM	1	24	21.02	21.34	21.5	22.5	0
5	16QAM	12	0	21.01	21.38	21.65		
5	16QAM	12	7	21.15	21.53	21.71		
5	16QAM	12	13	21.05	21.57	21.72	22.5	0
5	16QAM	25	0	21.3	21.67	21.85		

<TDD LTE SAR Measurement>

TDD LTE configuration setup for SAR measurement

SAR was tested with a fixed periodic duty factor according to the highest transmission duty factor implemented for the device and supported by 3GPP.

- a. 3GPP TS 36.211 section 4.2 for Type 2 Frame Structure and Table 4.2-2 for uplink-downlink configurations
- b. "special subframe S" contains both uplink and downlink transmissions, it has been taken into consideration to determine the transmission duty factor according to the worst case uplink and downlink cyclic prefix requirements for UpPTS
- c. Establishing connections with base station simulators ensure a consistent means for testing SAR and recommended for evaluating SAR. The Anritsu MT8820C (firmware: #22.52#004) was used for LTE output power measurements and SAR testing.

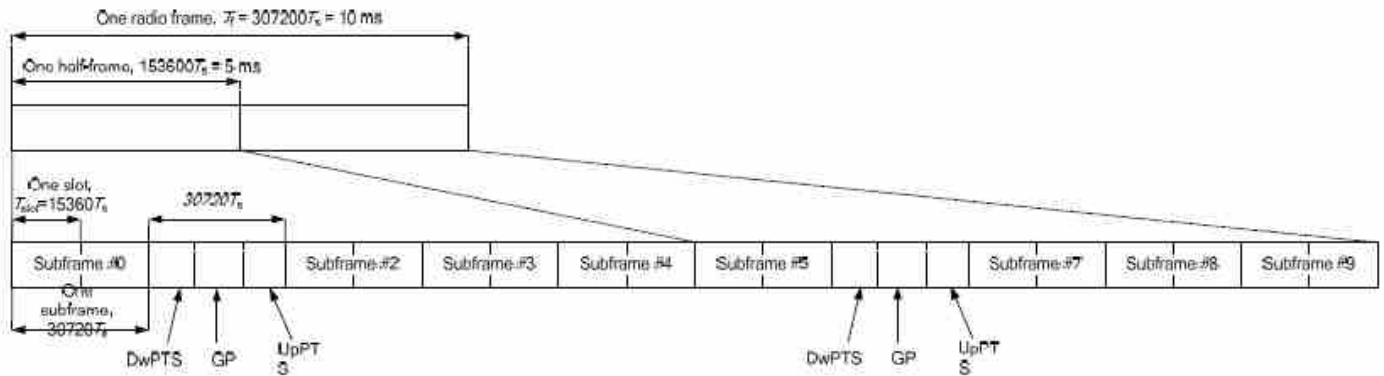

Figure 4.2-1: Frame structure type 2 (for 5 ms switch-point periodicity).

Table 4.2-2: Uplink-downlink configurations.

Uplink-downlink configuration	Downlink-to-Uplink Switch-point periodicity	Subframe number									
		0	1	2	3	4	5	6	7	8	9
0	5 ms	D	S	U	U	U	D	S	U	U	U
1	5 ms	D	S	U	U	D	D	S	U	U	D
2	5 ms	D	S	U	D	D	D	S	U	D	D
3	10 ms	D	S	U	U	U	D	D	D	D	D
4	10 ms	D	S	U	U	D	D	D	D	D	D
5	10 ms	D	S	U	D	D	D	D	D	D	D
6	5 ms	D	S	U	U	U	D	S	U	U	D

Table 4.2-1: Configuration of special subframe (lengths of DwPTS/GP/UpPTS).

Special subframe configuration	Normal cyclic prefix in downlink			Extended cyclic prefix in downlink		
	DwPTS	UpPTS		DwPTS	UpPTS	
		Normal cyclic prefix in uplink	Extended cyclic prefix in uplink		Normal cyclic prefix in uplink	Extended cyclic prefix in uplink
0	$6592 \cdot T_s$	$2192 \cdot T_s$	$2560 \cdot T_s$	$7680 \cdot T_s$	$2192 \cdot T_s$	$2560 \cdot T_s$
1	$19760 \cdot T_s$			$20480 \cdot T_s$		
2	$21952 \cdot T_s$			$23040 \cdot T_s$		
3	$24144 \cdot T_s$			$25600 \cdot T_s$		
4	$26336 \cdot T_s$	$4384 \cdot T_s$	$5120 \cdot T_s$	$7680 \cdot T_s$	$4384 \cdot T_s$	$5120 \cdot T_s$
5	$6592 \cdot T_s$			$20480 \cdot T_s$		
6	$19760 \cdot T_s$			$23040 \cdot T_s$		
7	$21952 \cdot T_s$			$12800 \cdot T_s$		
8	$24144 \cdot T_s$	-	-	-	-	-
9	$13168 \cdot T_s$	-	-	-	-	-

Special subframe (30720·T _s): Normal cyclic prefix in downlink (UpPTS)			
	Special subframe configuration	Normal cyclic prefix in uplink	Extended cyclic prefix in uplink
Uplink duty factor in one special subframe	0~4	7.13%	8.33%
	5~9	14.3%	16.7%

Special subframe(30720·T _s): Extended cyclic prefix in downlink (UpPTS)			
	Special subframe configuration	Normal cyclic prefix in uplink	Extended cyclic prefix in uplink
Uplink duty factor in one special subframe	0~3	7.13%	8.33%
	4~7	14.3%	16.7%

The highest duty factor is resulted from:

- i. Uplink-downlink configuration: 0. In a half-frame consisted of 5 subframes, uplink operation is in 3 uplink subframes and 1 special subframe.
- ii. special subframe configuration: 5-9 for normal cyclic prefix in downlink, 4-7 for extended cyclic prefix in downlink
- iii. for special subframe with extended cyclic prefix in uplink, the total uplink duty factor in one half-frame is: $(3+0.167)/5 = 63.3\%$
- iv. for special subframe with normal cyclic prefix in uplink, the total uplink duty factor in one half-frame is: $(3+0.143)/5 = 62.9\%$
- v. For TDD LTE SAR measurement, the duty cycle 1:1.59 (62.9 %) was used perform testing and considering the theoretical duty cycle of 63.3% for extended cyclic prefix in the uplink, and the theoretical duty cycle of 62.9% for normal cyclic prefix in uplink, a scaling factor of extended cyclic prefix $63.3\%/62.9\% = 1.006$ is applied to scale-up the measured SAR result. The scaled TDD LTE SAR = measured SAR (W/kg)* Tune-up Scaling Factor* scaling factor for extended cyclic prefix.



<Full Power Mode>

<LTE Band 38>

BW [MHz]	Modulation	RB Size	RB Offset	Power Low Ch. / Freq.	Power Middle Ch. / Freq.	Power High Ch. / Freq.	Tune-up limit (dBm)	MPR (dB)
Channel				37850	38000	38150		
Frequency (MHz)				2580	2595	2610		
20	QPSK	1	0	22.34	22.26	22.27	23	0
20	QPSK	1	49	22.47	22.62	22.28		
20	QPSK	1	99	22.4	22.32	22.25		
20	QPSK	50	0	21.45	21.54	21.46	22	1
20	QPSK	50	24	21.41	21.31	21.45		
20	QPSK	50	50	21.38	21.35	21.29		
20	QPSK	100	0	21.32	21.34	21.3	22	1
20	16QAM	1	0	20.86	20.93	20.86		
20	16QAM	1	49	21.62	21.52	21.49		
20	16QAM	1	99	20.82	20.69	20.71	21	2
20	16QAM	50	0	20.49	20.67	20.37		
20	16QAM	50	24	20.66	20.46	20.39		
20	16QAM	50	50	20.41	20.48	20.53	21	2
20	16QAM	100	0	20.35	20.37	20.32		
Channel				37825	38000	38175		
Frequency (MHz)				2577.5	2595	2612.5		
15	QPSK	1	0	22.37	22.25	22.17	23	0
15	QPSK	1	37	22.61	22.54	22.59		
15	QPSK	1	74	22.27	22.22	22.19		
15	QPSK	36	0	21.46	21.36	21.32	22	1
15	QPSK	36	20	21.46	21.39	21.32		
15	QPSK	36	39	21.33	21.61	21.34		
15	QPSK	75	0	21.45	21.37	21.47	22	1
15	16QAM	1	0	20.86	20.86	20.84		
15	16QAM	1	37	21.33	21.54	21.41		
15	16QAM	1	74	20.82	20.85	21.17	21	2
15	16QAM	36	0	20.41	20.31	20.17		
15	16QAM	36	20	20.53	20.48	20.34		
15	16QAM	36	39	20.5	20.4	20.21	21	2
15	16QAM	75	0	20.37	20.42	20.39		



Channel				37800	38000	38200	Tune-up limit (dBm)	MPR (dB)
Frequency (MHz)				2575	2595	2615		
10	QPSK	1	0	22.31	22.35	22.29	23	0
10	QPSK	1	25	22.55	22.54	22.6		
10	QPSK	1	49	22.5	22.42	22.43		
10	QPSK	25	0	21.35	21.58	21.5	22	1
10	QPSK	25	12	21.36	21.36	21.49		
10	QPSK	25	25	21.39	21.34	21.38		
10	QPSK	50	0	21.42	21.41	21.35	22	1
10	16QAM	1	0	20.78	20.83	20.8		
10	16QAM	1	25	21.54	21.03	21.12		
10	16QAM	1	49	20.82	21.15	20.73	21	2
10	16QAM	25	0	20.68	20.32	20.66		
10	16QAM	25	12	20.69	20.7	20.63		
10	16QAM	25	25	20.71	20.57	20.6	21	2
10	16QAM	50	0	20.33	20.5	20.37		
Channel				37775	38000	38225		
Frequency (MHz)				2572.5	2595	2617.5		
5	QPSK	1	0	22.1	22.12	22.27	23	0
5	QPSK	1	12	22.46	22.5	22.54		
5	QPSK	1	24	22.23	22.25	22.21		
5	QPSK	12	0	21.26	21.35	21.3	22	1
5	QPSK	12	7	21.31	21.32	21.32		
5	QPSK	12	13	21.33	21.39	21.32		
5	QPSK	25	0	21.3	21.37	21.4	22	1
5	16QAM	1	0	20.69	20.94	21.08		
5	16QAM	1	12	21.56	21.08	21.36		
5	16QAM	1	24	21.09	21.06	21.05	21	2
5	16QAM	12	0	20.3	20.26	20.48		
5	16QAM	12	7	20.38	20.37	20.5		
5	16QAM	12	13	20.39	20.46	20.38	21	2
5	16QAM	25	0	20.63	20.62	20.75		



<LTE Carrier Aggregation>

General Note:

This device supports Carrier Aggregation on downlink for intra band, uplink CA is not supported. For the device supports bands and bandwidths and configurations are provided as follow table was according to 3GPP.

E-UTRA CA configuration / Bandwidth combination set									
E-UTRA CA configuration	Uplink CA configurations	Component carriers in order of increasing carrier frequency				Maximum aggregated bandwidth [MHz]	Bandwidth combination set		
		Channel bandwidths for carrier [MHz]	Channel bandwidths for carrier [MHz]	Channel bandwidths for carrier [MHz]	Channel bandwidths for carrier [MHz]				
CA_7C	-	15	15			40	0		
		20	20						
		10	20						
				15	15, 20			40	1
				20	10, 15, 20				
				15	10, 15				
				20	15, 20			40	2

<Full Power Mode>

Configure		PCC							SCC				Power	
		LTE Band	BW (MHz)	UL Freq. (MHz)	UL Channel	Mod.	UL# RB	UL RB Offset	LTE Band	BW (MHz)	DL Freq. (MHz)	DL Channel	With CA Tx. Power (dBm)	Without CA Tx. Power (dBm)
Intra-Band	Contiguous	Band 7	20M	2560	21350	QPSK	1	49	Band 7	20M	2660.2	3152	23.84	23.86

<Reduced Power Mode for Hotspot On>

Configure		PCC							SCC				Power	
		LTE Band	BW (MHz)	UL Freq. (MHz)	UL Channel	Mod.	UL# RB	UL RB Offset	LTE Band	BW (MHz)	DL Freq. (MHz)	DL Channel	With CA Tx. Power (dBm)	Without CA Tx. Power (dBm)
Intra-Band	Contiguous	Band 7	20M	2535	21100	QPSK	1	49	Band 7	20M	2674.8	3298	21.97	21.99



<WLAN Conducted Power>

General Note:

1. Per KDB 248227 D01v02r02, SAR test reduction is determined according to 802.11 transmission mode configurations and certain exposure conditions with multiple test positions. In the 2.4 GHz band, separate SAR procedures are applied to DSSS and OFDM configurations to simplify DSSS test requirements. For OFDM, in both 2.4 and 5 GHz bands, an initial test configuration must be determined for each standalone and aggregated frequency band, according to the transmission mode configuration with the highest maximum output power specified for production units to perform SAR measurements. If the same highest maximum output power applies to different combinations of channel bandwidths, modulations and data rates, additional procedures are applied to determine which test configurations require SAR measurement. When applicable, an initial test position may be applied to reduce the number of SAR measurements required for next to the ear, UMPC mini-tablet or hotspot mode configurations with multiple test positions.
2. For 2.4 GHz 802.11b DSSS, either the initial test position procedure for multiple exposure test positions or the DSSS procedure for fixed exposure position is applied; these are mutually exclusive. For 2.4 GHz and 5 GHz OFDM configurations, the initial test configuration is applied to measure SAR using either the initial test position procedure for multiple exposure test position configurations or the initial test configuration procedures for fixed exposure test conditions. Based on the reported SAR of the measured configurations and maximum output power of the transmission mode configurations that are not included in the initial test configuration, the subsequent test configuration and initial test position procedures are applied to determine if SAR measurements are required for the remaining OFDM transmission configurations. In general, the number of test channels that require SAR measurement is minimized based on maximum output power measured for the test sample(s).
3. For OFDM transmission configurations in the 2.4 GHz and 5 GHz bands, When the same maximum power is specified for multiple transmission modes in a frequency band, the largest channel bandwidth, lowest order modulation, lowest data rate and lowest order 802.11a/g/n/ac mode is used for SAR measurement, on the highest measured output power channel for each frequency band.
4. DSSS and OFDM configurations are considered separately according to the required SAR procedures. SAR is measured in the initial test position using the 802.11 transmission mode configuration required by the DSSS procedure or initial test configuration and subsequent test configuration(s) according to the OFDM procedures.18 The initial test position procedure is described in the following:
 - a. When the reported SAR of the initial test position is ≤ 0.4 W/kg, further SAR measurement is not required for the other test positions in that exposure configuration and 802.11 transmission mode combinations within the frequency band or aggregated band.
 - b. When the reported SAR of the test position is > 0.4 W/kg, SAR is repeated for the 802.11 transmission mode configuration tested in the initial test position to measure the subsequent next closet/smallest test separation distance and maximum coupling test position on the highest maximum output power channel, until the report SAR is ≤ 0.8 W/kg or all required test position are tested.
 - c. For all positions/configurations, when the reported SAR is > 0.8 W/kg, SAR is measured for these test positions/configurations on the subsequent next highest measured output power channel(s) until the reported SAR is ≤ 1.2 W/kg or all required channels are tested.

<2.4GHz WLAN>

	Mode	Channel	Frequency (MHz)	Average power (dBm)	Tune-Up Limit	Duty Cycle %
2.4GHz WLAN	802.11b 1Mbps	1	2412	15.45	16.00	97.63
		6	2437	15.80	16.00	
		11	2462	15.31	16.00	
	802.11g 6Mbps	1	2412	14.02	15.00	87.18
		6	2437	13.82	15.00	
		11	2462	13.85	15.00	
	802.11n-HT20 MCS0	1	2412	12.43	13.00	86.49
		6	2437	12.18	13.00	
		11	2462	12.48	13.00	
	802.11n-HT40 MCS0	3	2422	11.90	13.00	85.42
		6	2437	12.11	13.00	
		9	2452	11.96	13.00	



<5GHz WLAN>

5.2GHz WLAN	Mode	Channel	Frequency (MHz)	Average power (dBm)	Tune-Up Limit	Duty Cycle %
	802.11a 6Mbps	36	5180	10.90	11.50	87.26
		40	5200	10.88	11.50	
		44	5220	10.70	11.50	
		48	5240	10.71	11.50	
	802.11n-HT20 MCS0	36	5180	10.58	11.00	86.49
		40	5200	10.56	11.00	
		44	5220	10.55	11.00	
		48	5240	10.54	11.00	
	802.11n-HT40 MCS0	38	5190	10.58	11.00	85.71
46		5230	10.52	11.00		

5.3GHz WLAN	Mode	Channel	Frequency (MHz)	Average power (dBm)	Tune-Up Limit	Duty Cycle %
	802.11a 6Mbps	52	5260	10.66	11.50	87.26
		56	5280	10.64	11.50	
		60	5300	10.62	11.50	
		64	5320	10.86	11.50	
	802.11n-HT20 MCS0	52	5260	10.56	11.00	86.49
		56	5280	10.60	11.00	
		60	5300	10.61	11.00	
		64	5320	10.85	11.00	
	802.11n-HT40 MCS0	54	5270	10.62	11.00	85.71
62		5310	10.82	11.00		



5.5GHz WLAN	Mode	Channel	Frequency (MHz)	Average power (dBm)	Tune-Up Limit	Duty Cycle %
	802.11a 6Mbps	100	5500	10.90	11.00	87.26
		116	5580	10.76	11.00	
		132	5660	10.61	11.00	
		140	5700	10.72	11.00	
		144	5720	10.65	11.00	
	802.11n-HT20 MCS0	100	5500	10.51	11.50	86.49
		116	5580	10.58	11.50	
		132	5660	10.49	11.50	
		140	5700	10.71	11.50	
		144	5720	10.55	11.50	
	802.11n-HT40 MCS0	102	5510	10.89	11.00	85.71
		110	5550	10.68	11.00	
		134	5670	10.69	11.00	
142		5710	10.64	11.00		

5.8GHz WLAN	Mode	Channel	Frequency (MHz)	Average power (dBm)	Tune-Up Limit	Duty Cycle %
	802.11a 6Mbps	149	5745	10.64	11.00	87.26
		157	5785	10.69	11.00	
		165	5825	10.70	11.00	
	802.11n-HT20 MCS0	149	5745	10.58	11.50	86.49
		157	5785	10.60	11.50	
		165	5825	10.59	11.50	
	802.11n-HT40 MCS0	151	5755	10.65	11.00	85.71
		159	5795	10.64	11.00	



13. Bluetooth Exclusions Applied

Mode Band	Average power(dBm)	
	Bluetooth v3.0+EDR	Bluetooth v4.0/4.2 LE
2.4GHz Bluetooth	3.0	3.0

Note:

Per KDB 447498 D01v06, the 1-g and 10-g SAR test exclusion thresholds for 100 MHz to 6 GHz at *test separation distances* ≤ 50 mm are determined by:

$$[(\text{max. power of channel, including tune-up tolerance, mW}) / (\text{min. test separation distance, mm})] \cdot [\sqrt{f(\text{GHz})}] \leq 3.0 \text{ for 1-g SAR and } \leq 7.5 \text{ for 10-g extremity SAR}$$

- f(GHz) is the RF channel transmit frequency in GHz
- Power and distance are rounded to the nearest mW and mm before calculation
- The result is rounded to one decimal place for comparison

Bluetooth Max Power (dBm)	Frequency (GHz)	Separation Distance (mm)		Exclusion Thresholds	
		1-g SAR	10-g extremity SAR	1-g SAR	10-g extremity SAR
3.0	2.48	15	0	0.2	0.6

Note:

1. Per KDB 447498 D01v06, a distance of 15 mm is applied to determine 1g SAR test exclusion. The test exclusion threshold is 0.2 which is ≤ 3, SAR testing is not required.
2. Per KDB 447498 D01v06, when the minimum test separation distance is < 5 mm, a distance of 5 mm is applied to determine SAR 10g SAR test exclusion. The test exclusion threshold is 0.6 which is ≤ 7.5, SAR testing is not required.

14. Antenna Location

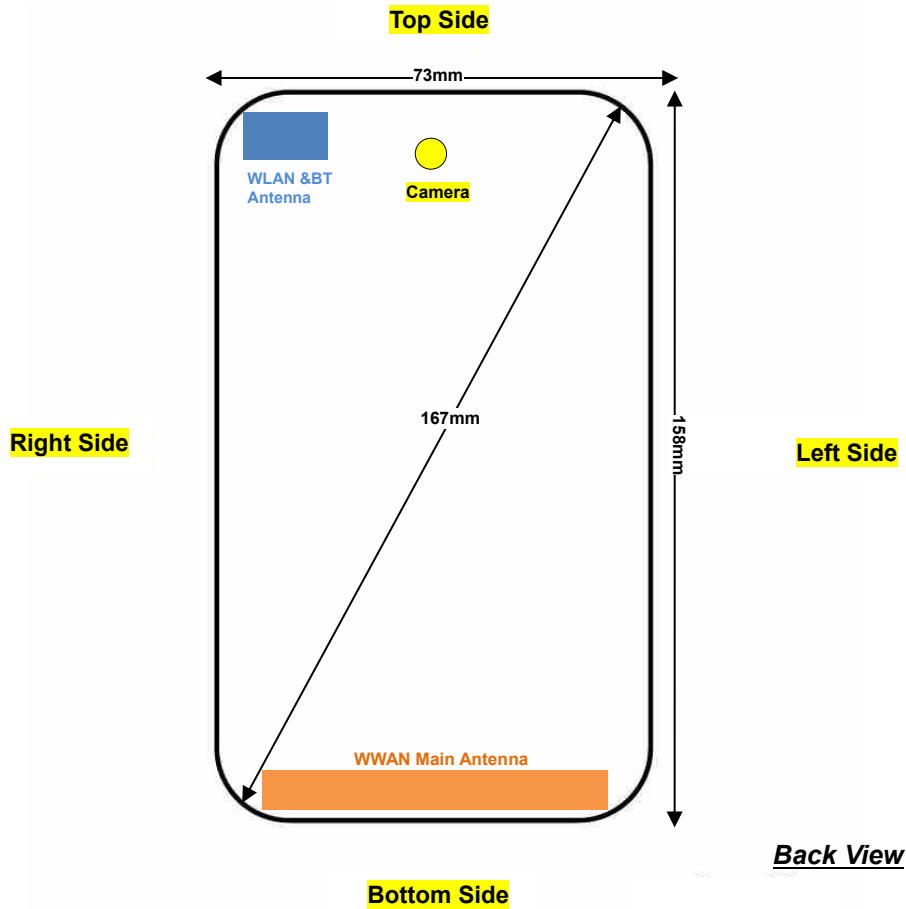

Distance of the Antenna to the EUT surface/edge						
Antennas	Back	Front	Top Side	Bottom Side	Right Side	Left Side
WWAN Main Antenna	≤ 25mm	≤ 25mm	>25mm	≤ 25mm	≤ 25mm	≤ 25mm
WLAN & BT	≤ 25mm	≤ 25mm	≤ 25mm	>25mm	≤ 25mm	>25mm

Positions for SAR tests; Hotspot mode						
Antennas	Back	Front	Top Side	Bottom Side	Right Side	Left Side
WWAN Main Antenna	Yes	Yes	No	Yes	Yes	Yes
WLAN & BT	Yes	Yes	Yes	No	Yes	No

General Note:

Referring to KDB 941225 D06 v02r01, when the overall device length and width are ≥ 9cm*5cm, the test distance is 10 mm. SAR must be measured for all sides and surfaces with a transmitting antenna located within 25mm from that surface or edge.



15. SAR Test Results

General Note:

1. Per KDB 447498 D01v06, the reported SAR is the measured SAR value adjusted for maximum tune-up tolerance.
 - a. Tune-up scaling Factor = tune-up limit power (mW) / EUT RF power (mW), where tune-up limit is the maximum rated power among all production units.
 - b. For SAR testing of WLAN signal with non-100% duty cycle, the measured SAR is scaled-up by the duty cycle scaling factor which is equal to "1/(duty cycle)"
 - c. For WWAN: Reported SAR(W/kg)= Measured SAR(W/kg)*Tune-up Scaling Factor
 - d. For WLAN: Reported SAR(W/kg)= Measured SAR(W/kg)* Duty Cycle scaling factor * Tune-up scaling factor
 - e. For TDD LTE SAR measurement, the duty cycle 1:1.59 (62.9 %) was used perform testing and considering the theoretical duty cycle of 63.3% for extended cyclic prefix in the uplink, and the theoretical duty cycle of 62.9% for normal cyclic prefix in uplink, a scaling factor of extended cyclic prefix 63.3%/62.9% = 1.006 is applied to scale-up the measured SAR result. The Reported TDD LTE SAR = measured SAR (W/kg)* Tune-up Scaling Factor* scaling factor for extended cyclic prefix.
2. Per KDB 447498 D01v06, for each exposure position, testing of other required channels within the operating mode of a frequency band is not required when the *reported* 1-g or 10-g SAR for the mid-band or highest output power channel is:
 - ≤ 0.8 W/kg or 2.0 W/kg, for 1-g or 10-g respectively, when the transmission band is ≤ 100 MHz
 - ≤ 0.6 W/kg or 1.5 W/kg, for 1-g or 10-g respectively, when the transmission band is between 100 MHz and 200 MHz
 - ≤ 0.4 W/kg or 1.0 W/kg, for 1-g or 10-g respectively, when the transmission band is ≥ 200 MHz
3. Per KDB 865664 D01v01r04, for each frequency band, repeated SAR measurement is required only when the measured SAR is ≥ 0.8 W/kg.
4. Per KDB 648474 D04v01r03, when the reported SAR for a body-worn accessory measured without a headset connected to the handset is ≤ 1.2 W/kg, SAR testing with a headset connected to the handset is not required.
5. Per KDB648474 D04v01r03, for smart phones with a display diagonal dimension > 15.0 cm or an overall diagonal dimension > 16.0 cm, when hotspot mode applies, 10-g product specific SAR is required only for the surfaces and edges with hotspot mode 1-g reported SAR > 1.2 W/kg, however, when power reduction applies to hotspot mode the measured SAR must be scaled to the maximum output power, including tolerance, allowed for phablet modes to compare with the 1.2 W/kg SAR test reduction threshold.
 - a. For this device only back/bottom side SAR for WWAN transmitter scaled to maximum output power is higher than 1.2W/kg of WCDMA B2 and LTE B4 / B7, therefore product specific SAR is necessary.
 - b. WLAN 5.3/5.5GHz tested the product specific 10g SAR since it has no hotspot mode.
 - c. When 10-g product specific 10g SAR is considered, SAR thresholds is specified in the procedures for SAR test reduction and exclusion should be multiplied by 2.5.

GSM Note:

1. Per KDB 941225 D01v03r01, for SAR test reduction for GSM / GPRS / EDGE modes is determined by the source-based time-averaged output power including tune-up tolerance. The mode with highest specified time-averaged output power should be tested for SAR compliance in the applicable exposure conditions. For modes with the same specified maximum output power and tolerance, the higher number time-slot configuration should be tested. Therefore, the GPRS (4Tx slots) for GSM850 and the GPRS (1Tx slot) for GSM1900 are considered as the primary mode.
2. Other configurations of GSM / GPRS / EDGE are considered as secondary modes. The 3G SAR test reduction procedure is applied, when the maximum output power and tune-up tolerance specified for production units in a secondary mode is $\leq 1/4$ dB higher than the primary mode, SAR measurement is not required for the secondary mode.

WCDMA Note:

1. Per KDB 941225 D01v03r01, for SAR testing is measured using a 12.2 kbps RMC with TPC bits configured to all "1's".
2. Per KDB 941225 D01v03r01, RMC 12.2kbps setting is used to evaluate SAR. The maximum output power and tune-up tolerance specified for production units in HSDPA / HSUPA / DC-HSDPA is $\leq 1/4$ dB higher than RMC 12.2Kbps or when the highest reported SAR of the RMC12.2Kbps is scaled by the ratio of specified maximum output power and tune-up tolerance of HSDPA / HSUPA / DC-HSDPA to RMC12.2Kbps and the adjusted SAR is ≤ 1.2 W/kg, SAR measurement is not required for HSDPA / HSUPA / DC-HSDPA, and according to the following RF output power, the output power results of the secondary modes (HSDPA, HSUPA, DC-HSDPA) are less than $1/4$ dB higher than the primary modes; therefore, SAR measurement is not required for HSDPA / HSUPA / DC-HSDPA.



LTE Note:

1. Per KDB 941225 D05v02r05, start with the largest channel bandwidth and measure SAR for QPSK with 1 RB allocation, using the RB offset and required test channel combination with the highest maximum output power for RB offsets at the upper edge, middle and lower edge of each required test channel.
2. Per KDB 941225 D05v02r05, 50% RB allocation for QPSK SAR testing follows 1RB QPSK allocation procedure.
3. Per KDB 941225 D05v02r05, For QPSK with 100% RB allocation, SAR is not required when the highest maximum output power for 100 % RB allocation is less than the highest maximum output power in 50% and 1 RB allocations and the highest reported SAR for 1 RB and 50% RB allocation are ≤ 0.8 W/kg. Otherwise, SAR is measured for the highest output power channel; and if the reported SAR is > 1.45 W/kg, the remaining required test channels must also be tested.
4. Per KDB 941225 D05v02r05, 16QAM output power for each RB allocation configuration is $>$ not $\frac{1}{2}$ dB higher than the same configuration in QPSK and the reported SAR for the QPSK configuration is ≤ 1.45 W/kg; Per KDB 941225 D05v02r05, 16QAM SAR testing is not required.
5. Per KDB 941225 D05v02r05, smaller bandwidth output power for each RB allocation configuration is $>$ not $\frac{1}{2}$ dB higher than the same configuration in the largest supported bandwidth, and the reported SAR for the largest supported bandwidth is ≤ 1.45 W/kg; Per KDB 941225 D05v02r05, smaller bandwidth SAR testing is not required.
6. For LTE B4 / B5 / B38 the maximum bandwidth does not support three non-overlapping channels, per KDB 941225 D05v02r05, when a device supports overlapping channel assignment in a channel bandwidth configuration, the middle channel of the group of overlapping channels should be selected for testing.

WLAN Note:

1. Per KDB 248227 D01v02r02, for 2.4GHz 802.11g/n SAR testing is not required when the highest reported SAR for DSSS is adjusted by the ratio of OFDM to DSSS specified maximum output power and the adjusted SAR is ≤ 1.2 W/kg.
2. Per KDB 248227 D01v02r02, U-NII-1 SAR testing is not required when the U-NII-2A band highest reported SAR for a test configuration is ≤ 1.2 W/kg, SAR is not required for U-NII-1 band.
3. When the reported SAR of the test position is > 0.4 W/kg, SAR is repeated for the 802.11 transmission mode configuration tested in the initial test position to measure the subsequent next closet/smallest test separation distance and maximum coupling test position on the highest maximum output power channel, until the report SAR is ≤ 0.8 W/kg or all required test position are tested.
4. For all positions / configurations, when the reported SAR is > 0.8 W/kg, SAR is measured for these test positions / configurations on the subsequent next highest measured output power channel(s) until the reported SAR is ≤ 1.2 W/kg or all required channels are tested.
5. During SAR testing the WLAN transmission was verified using a spectrum analyzer.



15.1 Head SAR

<GSM SAR>

Plot No.	Band	Mode	Test Position	Power Mode	Ch.	Freq. (MHz)	Average Power (dBm)	Tune-Up Limit (dBm)	Tune-up Scaling Factor	Power Drift (dB)	Measured 1g SAR (W/kg)	Reported 1g SAR (W/kg)
01	GSM850	GPRS 4 Tx slots	Right Cheek	Full	189	836.4	27.63	28.00	1.089	0.01	0.191	0.208
	GSM850	GPRS 4 Tx slots	Right Tilted	Full	189	836.4	27.63	28.00	1.089	0.09	0.107	0.117
	GSM850	GPRS 4 Tx slots	Left Cheek	Full	189	836.4	27.63	28.00	1.089	0.01	0.183	0.199
	GSM850	GPRS 4 Tx slots	Left Tilted	Full	189	836.4	27.63	28.00	1.089	0.02	0.111	0.121
02	GSM1900	GPRS 1 Tx slot	Right Cheek	Full	810	1909.8	29.43	30.00	1.140	0.13	0.142	0.162
	GSM1900	GPRS 1 Tx slot	Right Tilted	Full	810	1909.8	29.43	30.00	1.140	-0.04	0.083	0.095
	GSM1900	GPRS 1 Tx slot	Left Cheek	Full	810	1909.8	29.43	30.00	1.140	0.11	0.108	0.123
	GSM1900	GPRS 1 Tx slot	Left Tilted	Full	810	1909.8	29.43	30.00	1.140	0.11	0.084	0.096

<WCDMA SAR>

Plot No.	Band	Mode	Test Position	Power Mode	Ch.	Freq. (MHz)	Average Power (dBm)	Tune-Up Limit (dBm)	Tune-up Scaling Factor	Power Drift (dB)	Measured 1g SAR (W/kg)	Reported 1g SAR (W/kg)
	WCDMA Band V	RMC 12.2Kbps	Right Cheek	Full	4233	846.6	23.67	24.00	1.079	0.13	0.212	0.229
	WCDMA Band V	RMC 12.2Kbps	Right Tilted	Full	4233	846.6	23.67	24.00	1.079	-0.01	0.135	0.146
03	WCDMA Band V	RMC 12.2Kbps	Left Cheek	Full	4233	846.6	23.67	24.00	1.079	0.14	0.222	0.240
	WCDMA Band V	RMC 12.2Kbps	Left Tilted	Full	4233	846.6	23.67	24.00	1.079	0.13	0.135	0.146
04	WCDMA Band II	RMC 12.2Kbps	Right Cheek	Full	9262	1852.4	23.46	24.00	1.132	0.13	0.251	0.284
	WCDMA Band II	RMC 12.2Kbps	Right Tilted	Full	9262	1852.4	23.46	24.00	1.132	0.03	0.122	0.138
	WCDMA Band II	RMC 12.2Kbps	Left Cheek	Full	9262	1852.4	23.46	24.00	1.132	0.11	0.148	0.168
	WCDMA Band II	RMC 12.2Kbps	Left Tilted	Full	9262	1852.4	23.46	24.00	1.132	0.07	0.124	0.140



<FDD LTE SAR>

Plot No.	Band	BW (MHz)	Modulation	RB Size	RB Offset	Test Position	Power Mode	Ch.	Freq. (MHz)	Average Power (dBm)	Tune-Up Limit (dBm)	Tune-up Scaling Factor	Power Drift (dB)	Measured 1g SAR (W/kg)	Reported 1g SAR (W/kg)
	LTE Band 5	10M	QPSK	1	25	Right Cheek	Full	20525	836.5	23.25	24.00	1.189	-0.02	0.153	0.182
	LTE Band 5	10M	QPSK	25	0	Right Cheek	Full	20525	836.5	22.34	23.00	1.164	-0.06	0.113	0.132
	LTE Band 5	10M	QPSK	1	25	Right Tilted	Full	20525	836.5	23.25	24.00	1.189	0.05	0.089	0.106
	LTE Band 5	10M	QPSK	25	0	Right Tilted	Full	20525	836.5	22.34	23.00	1.164	0.16	0.068	0.079
05	LTE Band 5	10M	QPSK	1	25	Left Cheek	Full	20525	836.5	23.25	24.00	1.189	0.18	0.157	0.187
	LTE Band 5	10M	QPSK	25	0	Left Cheek	Full	20525	836.5	22.34	23.00	1.164	-0.03	0.119	0.139
	LTE Band 5	10M	QPSK	1	25	Left Tilted	Full	20525	836.5	23.25	24.00	1.189	0.04	0.098	0.116
	LTE Band 5	10M	QPSK	25	0	Left Tilted	Full	20525	836.5	22.34	23.00	1.164	0.1	0.072	0.084
06	LTE Band 4	20M	QPSK	1	49	Right Cheek	Full	20175	1732.5	23.48	24.00	1.127	-0.02	0.256	0.289
	LTE Band 4	20M	QPSK	50	0	Right Cheek	Full	20175	1732.5	22.42	23.00	1.143	0.16	0.204	0.233
	LTE Band 4	20M	QPSK	1	49	Right Tilted	Full	20175	1732.5	23.48	24.00	1.127	0.02	0.147	0.166
	LTE Band 4	20M	QPSK	50	0	Right Tilted	Full	20175	1732.5	22.42	23.00	1.143	0.11	0.118	0.135
	LTE Band 4	20M	QPSK	1	49	Left Cheek	Full	20175	1732.5	23.48	24.00	1.127	0.11	0.147	0.166
	LTE Band 4	20M	QPSK	50	0	Left Cheek	Full	20175	1732.5	22.42	23.00	1.143	0.08	0.110	0.126
	LTE Band 4	20M	QPSK	1	49	Left Tilted	Full	20175	1732.5	23.48	24.00	1.127	0.09	0.133	0.150
	LTE Band 4	20M	QPSK	50	0	Left Tilted	Full	20175	1732.5	22.42	23.00	1.143	0.13	0.104	0.119
07	LTE Band 7	20M	QPSK	1	49	Right Cheek	Full	21350	2560	23.86	24.00	1.033	0.06	0.110	0.114
	LTE Band 7	20M	QPSK	50	0	Right Cheek	Full	21350	2560	22.70	23.00	1.072	0.02	0.085	0.091
	LTE Band 7	20M	QPSK	1	49	Right Tilted	Full	21350	2560	23.86	24.00	1.033	0.17	0.022	0.023
	LTE Band 7	20M	QPSK	50	0	Right Tilted	Full	21350	2560	22.70	23.00	1.072	0.01	0.017	0.018
	LTE Band 7	20M	QPSK	1	49	Left Cheek	Full	21350	2560	23.86	24.00	1.033	0.04	0.068	0.070
	LTE Band 7	20M	QPSK	50	0	Left Cheek	Full	21350	2560	22.70	23.00	1.072	0.18	0.035	0.038
	LTE Band 7	20M	QPSK	1	49	Left Tilted	Full	21350	2560	23.86	24.00	1.033	-0.02	0.038	0.039
	LTE Band 7	20M	QPSK	50	0	Left Tilted	Full	21350	2560	22.70	23.00	1.072	0.07	0.034	0.036



<TDD LTE SAR>

Plot No.	Band	BW (MHz)	Modulation	RB Size	RB Offset	Test Position	Power Mode	Ch.	Freq. (MHz)	Average Power (dBm)	Tune-Up Limit (dBm)	Tune-up Scaling Factor	Duty Cycle %	Duty Cycle Scaling Factor	Power Drift (dB)	Measured 1g SAR (W/kg)	Reported 1g SAR (W/kg)
08	LTE Band 38	20M	QPSK	1	49	Right Cheek	Full	38000	2595	22.62	23.00	1.091	62.9	1.006	0.01	0.061	0.067
	LTE Band 38	20M	QPSK	50	0	Right Cheek	Full	38000	2595	21.54	22.00	1.112	62.9	1.006	0.07	0.049	0.055
	LTE Band 38	20M	QPSK	1	49	Right Tilted	Full	38000	2595	22.62	23.00	1.091	62.9	1.006	0.14	0.012	0.013
	LTE Band 38	20M	QPSK	50	0	Right Tilted	Full	38000	2595	21.54	22.00	1.112	62.9	1.006	0.03	0.010	0.011
	LTE Band 38	20M	QPSK	1	49	Left Cheek	Full	38000	2595	22.62	23.00	1.091	62.9	1.006	0.08	0.038	0.042
	LTE Band 38	20M	QPSK	50	0	Left Cheek	Full	38000	2595	21.54	22.00	1.112	62.9	1.006	0.08	0.025	0.028
	LTE Band 38	20M	QPSK	1	49	Left Tilted	Full	38000	2595	22.62	23.00	1.091	62.9	1.006	0.18	0.019	0.021
	LTE Band 38	20M	QPSK	50	0	Left Tilted	Full	38000	2595	21.54	22.00	1.112	62.9	1.006	0.19	0.013	0.015

<WLAN SAR>

Plot No.	Band	Mode	Test Position	Ch.	Freq. (MHz)	Average Power (dBm)	Tune-Up Limit (dBm)	Tune-up Scaling Factor	Duty Cycle %	Duty Cycle Scaling Factor	Power Drift (dB)	Max Area Scan SAR	Measured 1g SAR (W/kg)	Reported 1g SAR (W/kg)
	WLAN2.4GHz	802.11b 1Mbps	Right Cheek	6	2437	15.80	16.00	1.047	97.63	1.024		0.554		
	WLAN2.4GHz	802.11b 1Mbps	Right Tilted	6	2437	15.80	16.00	1.047	97.63	1.024		0.628		
09	WLAN2.4GHz	802.11b 1Mbps	Left Cheek	6	2437	15.80	16.00	1.047	97.63	1.024	-0.01	1.461	0.849	0.910
	WLAN2.4GHz	802.11b 1Mbps	Left Tilted	6	2437	15.80	16.00	1.047	97.63	1.024	-0.02	1.182	0.696	0.746
	WLAN2.4GHz	802.11b 1Mbps	Left Cheek	1	2412	15.45	16.00	1.135	97.63	1.024	0.12		0.637	0.740
	WLAN 5.3GHz	802.11a 6Mbps	Right Cheek	64	5320	10.86	11.50	1.159	87.26	1.146		0.848		
	WLAN 5.3GHz	802.11a 6Mbps	Right Tilted	64	5320	10.86	11.50	1.159	87.26	1.146	0.04	1.090	0.410	0.544
	WLAN 5.3GHz	802.11a 6Mbps	Left Cheek	64	5320	10.86	11.50	1.159	87.26	1.146	0.05	1.885	0.734	0.975
	WLAN 5.3GHz	802.11a 6Mbps	Left Cheek	52	5260	10.66	11.50	1.213	87.26	1.146	0.07		0.637	0.886
10	WLAN 5.3GHz	802.11a 6Mbps	Left Tilted	64	5320	10.86	11.50	1.159	87.26	1.146	-0.02	2.136	0.805	1.069
	WLAN 5.3GHz	802.11a 6Mbps	Left Tilted	52	5260	10.66	11.50	1.213	87.26	1.146	0.13		0.760	1.057
	WLAN 5.5GHz	802.11n-HT20 MCS0	Right Cheek	140	5700	10.71	11.50	1.199	86.49	1.156		1.129		
	WLAN 5.5GHz	802.11n-HT20 MCS0	Right Tilted	140	5700	10.71	11.50	1.199	86.49	1.156	0.09	1.183	0.437	0.606
	WLAN 5.5GHz	802.11n-HT20 MCS0	Left Cheek	140	5700	10.71	11.50	1.199	86.49	1.156	0.05	1.678	0.691	0.958
	WLAN 5.5GHz	802.11n-HT20 MCS0	Left Cheek	116	5580	10.58	11.50	1.236	86.49	1.156	0.12		0.632	0.903
11	WLAN 5.5GHz	802.11n-HT20 MCS0	Left Tilted	140	5700	10.71	11.50	1.199	86.49	1.156	-0.04	2.23	0.857	1.188
	WLAN 5.5GHz	802.11n-HT20 MCS0	Left Tilted	116	5580	10.58	11.50	1.236	86.49	1.156	0.09		0.769	1.099
	WLAN 5.8GHz	802.11n-HT20 MCS0	Right Cheek	157	5785	10.60	11.50	1.230	86.49	1.156		1.087		
	WLAN 5.8GHz	802.11n-HT20 MCS0	Right Tilted	157	5785	10.60	11.50	1.230	86.49	1.156	0.09	1.222	0.403	0.573
	WLAN 5.8GHz	802.11n-HT20 MCS0	Left Cheek	157	5785	10.60	11.50	1.230	86.49	1.156	-0.05	1.487	0.604	0.859
	WLAN 5.8GHz	802.11n-HT20 MCS0	Left Cheek	165	5825	10.59	11.50	1.233	86.49	1.156	0.16		0.587	0.837
12	WLAN 5.8GHz	802.11n-HT20 MCS0	Left Tilted	157	5785	10.60	11.50	1.230	86.49	1.156	-0.03	1.829	0.716	1.018
	WLAN 5.8GHz	802.11n-HT20 MCS0	Left Tilted	165	5825	10.59	11.50	1.233	86.49	1.156	0.12		0.689	0.982



15.2 Hotspot SAR

<GSM SAR>

Plot No.	Band	Mode	Test Position	Gap (mm)	Power Mode	Ch.	Freq. (MHz)	Average Power (dBm)	Tune-Up Limit (dBm)	Tune-up Scaling Factor	Power Drift (dB)	Measured 1g SAR (W/kg)	Reported 1g SAR (W/kg)
	GSM850	GPRS 4 Tx slots	Front	10	Full	189	836.4	27.63	28.00	1.089	0.01	0.192	0.209
13	GSM850	GPRS 4 Tx slots	Back	10	Full	189	836.4	27.63	28.00	1.089	0.08	0.286	0.311
	GSM850	GPRS 4 Tx slots	Left Side	10	Full	189	836.4	27.63	28.00	1.089	-0.07	0.177	0.193
	GSM850	GPRS 4 Tx slots	Right Side	10	Full	189	836.4	27.63	28.00	1.089	-0.16	0.160	0.174
	GSM850	GPRS 4 Tx slots	Bottom Side	10	Full	189	836.4	27.63	28.00	1.089	-0.04	0.048	0.052
	GSM1900	GPRS 1 Tx slot	Front	10	Full	810	1909.8	29.43	30.00	1.140	-0.1	0.246	0.281
	GSM1900	GPRS 1 Tx slot	Back	10	Full	810	1909.8	29.43	30.00	1.140	-0.17	0.332	0.379
	GSM1900	GPRS 1 Tx slot	Left Side	10	Full	810	1909.8	29.43	30.00	1.140	0.14	0.084	0.096
	GSM1900	GPRS 1 Tx slot	Right Side	10	Full	810	1909.8	29.43	30.00	1.140	-0.12	0.121	0.138
14	GSM1900	GPRS 1 Tx slot	Bottom Side	10	Full	810	1909.8	29.43	30.00	1.140	0.1	0.522	0.595

<WCDMA SAR>

Plot No.	Band	Mode	Test Position	Gap (mm)	Power Mode	Ch.	Freq. (MHz)	Average Power (dBm)	Tune-Up Limit (dBm)	Tune-up Scaling Factor	Power Drift (dB)	Measured 1g SAR (W/kg)	Reported 1g SAR (W/kg)
	WCDMA Band V	RMC 12.2Kbps	Front	10	Full	4233	846.6	23.67	24.00	1.079	-0.03	0.219	0.236
15	WCDMA Band V	RMC 12.2Kbps	Back	10	Full	4233	846.6	23.67	24.00	1.079	-0.04	0.321	0.346
	WCDMA Band V	RMC 12.2Kbps	Left Side	10	Full	4233	846.6	23.67	24.00	1.079	-0.06	0.219	0.236
	WCDMA Band V	RMC 12.2Kbps	Right Side	10	Full	4233	846.6	23.67	24.00	1.079	-0.14	0.208	0.224
	WCDMA Band V	RMC 12.2Kbps	Bottom Side	10	Full	4233	846.6	23.67	24.00	1.079	-0.16	0.054	0.058
	WCDMA Band II	RMC 12.2Kbps	Front	10	Reduced	9262	1852.4	20.62	21.00	1.091	-0.11	0.380	0.415
	WCDMA Band II	RMC 12.2Kbps	Back	10	Reduced	9262	1852.4	20.62	21.00	1.091	-0.1	0.611	0.667
	WCDMA Band II	RMC 12.2Kbps	Left Side	10	Reduced	9262	1852.4	20.62	21.00	1.091	-0.14	0.056	0.061
	WCDMA Band II	RMC 12.2Kbps	Right Side	10	Reduced	9262	1852.4	20.62	21.00	1.091	-0.06	0.146	0.159
16	WCDMA Band II	RMC 12.2Kbps	Bottom Side	10	Reduced	9262	1852.4	20.62	21.00	1.091	-0.19	0.969	1.058
	WCDMA Band II	RMC 12.2Kbps	Bottom Side	10	Reduced	9400	1880	20.45	21.00	1.135	-0.18	0.695	0.789
	WCDMA Band II	RMC 12.2Kbps	Bottom Side	10	Reduced	9538	1907.6	20.61	21.00	1.094	-0.18	0.538	0.589



<FDD LTE SAR>

Plot No.	Band	BW (MHz)	Modulation	RB Size	RB Offset	Test Position	Gap (mm)	Power Mode	Ch.	Freq. (MHz)	Average Power (dBm)	Tune-Up Limit (dBm)	Tune-up Scaling Factor	Power Drift (dB)	Measured 1g SAR (W/kg)	Reported 1g SAR (W/kg)
	LTE Band 5	10M	QPSK	1	25	Front	10	Full	20525	836.5	23.25	24.00	1.189	-0.11	0.162	0.193
	LTE Band 5	10M	QPSK	25	0	Front	10	Full	20525	836.5	22.34	23.00	1.164	-0.01	0.126	0.147
17	LTE Band 5	10M	QPSK	1	25	Back	10	Full	20525	836.5	23.25	24.00	1.189	0.02	0.236	0.280
	LTE Band 5	10M	QPSK	25	0	Back	10	Full	20525	836.5	22.34	23.00	1.164	-0.04	0.190	0.221
	LTE Band 5	10M	QPSK	1	25	Left Side	10	Full	20525	836.5	23.25	24.00	1.189	-0.12	0.150	0.178
	LTE Band 5	10M	QPSK	25	0	Left Side	10	Full	20525	836.5	22.34	23.00	1.164	-0.11	0.118	0.137
	LTE Band 5	10M	QPSK	1	25	Right Side	10	Full	20525	836.5	23.25	24.00	1.189	-0.06	0.144	0.171
	LTE Band 5	10M	QPSK	25	0	Right Side	10	Full	20525	836.5	22.34	23.00	1.164	0.07	0.110	0.128
	LTE Band 5	10M	QPSK	1	25	Bottom Side	10	Full	20525	836.5	23.25	24.00	1.189	-0.17	0.039	0.046
	LTE Band 5	10M	QPSK	25	0	Bottom Side	10	Full	20525	836.5	22.34	23.00	1.164	0.05	0.029	0.034
	LTE Band 4	20M	QPSK	1	49	Front	10	Reduced	20175	1732.5	20.38	21.00	1.153	-0.04	0.374	0.431
	LTE Band 4	20M	QPSK	50	0	Front	10	Reduced	20175	1732.5	20.13	21.00	1.222	-0.01	0.369	0.451
	LTE Band 4	20M	QPSK	1	49	Back	10	Reduced	20175	1732.5	20.38	21.00	1.153	0.09	0.512	0.591
	LTE Band 4	20M	QPSK	50	0	Back	10	Reduced	20175	1732.5	20.13	21.00	1.222	0.11	0.529	0.646
	LTE Band 4	20M	QPSK	1	49	Left Side	10	Reduced	20175	1732.5	20.38	21.00	1.153	-0.06	0.048	0.055
	LTE Band 4	20M	QPSK	50	0	Left Side	10	Reduced	20175	1732.5	20.13	21.00	1.222	0.14	0.043	0.053
	LTE Band 4	20M	QPSK	1	49	Right Side	10	Reduced	20175	1732.5	20.38	21.00	1.153	0.1	0.107	0.123
	LTE Band 4	20M	QPSK	50	0	Right Side	10	Reduced	20175	1732.5	20.13	21.00	1.222	0.04	0.107	0.131
	LTE Band 4	20M	QPSK	1	49	Bottom Side	10	Reduced	20175	1732.5	20.38	21.00	1.153	-0.09	0.745	0.859
	LTE Band 4	20M	QPSK	50	0	Bottom Side	10	Reduced	20175	1732.5	20.13	21.00	1.222	-0.16	0.750	0.916
18	LTE Band 4	20M	QPSK	100	0	Bottom Side	10	Reduced	20175	1732.5	20.08	21.00	1.236	-0.16	0.748	0.924
	LTE Band 7	20M	QPSK	1	49	Front	10	Reduced	21100	2535	21.99	22.50	1.125	-0.16	0.333	0.374
	LTE Band 7	20M	QPSK	50	0	Front	10	Reduced	21100	2535	21.74	22.50	1.191	-0.02	0.326	0.388
	LTE Band 7	20M	QPSK	1	49	Back	10	Reduced	21100	2535	21.99	22.50	1.125	-0.15	0.756	0.850
	LTE Band 7	20M	QPSK	1	49	Back	10	Reduced	20850	2510	21.57	22.50	1.239	-0.12	0.662	0.820
	LTE Band 7	20M	QPSK	1	49	Back	10	Reduced	21350	2560	21.81	22.50	1.172	0.02	0.855	1.002
	LTE Band 7	20M	QPSK	50	0	Back	10	Reduced	21100	2535	21.74	22.50	1.191	-0.08	0.758	0.903
	LTE Band 7	20M	QPSK	50	0	Back	10	Reduced	20850	2510	21.44	22.50	1.276	0.1	0.656	0.837
	LTE Band 7	20M	QPSK	50	0	Back	10	Reduced	21350	2560	21.68	22.50	1.208	0.09	0.850	1.027
	LTE Band 7	20M	QPSK	100	0	Back	10	Reduced	21100	2535	21.65	22.50	1.216	0.14	0.747	0.908
	LTE Band 7	20M	QPSK	1	49	Left Side	10	Reduced	21100	2535	21.99	22.50	1.125	0.06	0.041	0.046
	LTE Band 7	20M	QPSK	50	0	Left Side	10	Reduced	21100	2535	21.74	22.50	1.191	0.07	0.039	0.046
	LTE Band 7	20M	QPSK	1	49	Right Side	10	Reduced	21100	2535	21.99	22.50	1.125	-0.01	0.101	0.114
	LTE Band 7	20M	QPSK	50	0	Right Side	10	Reduced	21100	2535	21.74	22.50	1.191	-0.01	0.098	0.117
	LTE Band 7	20M	QPSK	1	49	Bottom Side	10	Reduced	21100	2535	21.99	22.50	1.125	0.18	0.746	0.839
	LTE Band 7	20M	QPSK	1	49	Bottom Side	10	Reduced	20850	2510	21.57	22.50	1.239	-0.13	0.630	0.780
	LTE Band 7	20M	QPSK	1	49	Bottom Side	10	Reduced	21350	2560	21.81	22.50	1.172	0.01	0.866	1.015
	LTE Band 7	20M	QPSK	50	0	Bottom Side	10	Reduced	21100	2535	21.74	22.50	1.191	0.09	0.731	0.871
	LTE Band 7	20M	QPSK	50	0	Bottom Side	10	Reduced	20850	2510	21.44	22.50	1.276	0.13	0.596	0.761
19	LTE Band 7	20M	QPSK	50	0	Bottom Side	10	Reduced	21350	2560	21.68	22.50	1.208	0.15	0.856	1.034
	LTE Band 7	20M	QPSK	100	0	Bottom Side	10	Reduced	21100	2535	21.65	22.50	1.216	0.1	0.721	0.877



<TDD LTE SAR>

Plot No.	Band	BW (MHz)	Modulation	RB Size	RB Offset	Test Position	Gap (mm)	Power Mode	Ch.	Freq. (MHz)	Average Power (dBm)	Tune-Up Limit (dBm)	Tune-up Scaling Factor	Duty Cycle %	Duty Cycle Scaling Factor	Power Drift (dB)	Measured 1g SAR (W/kg)	Reported 1g SAR (W/kg)
	LTE Band 38	20M	QPSK	1	49	Front	10	Full	38000	2595	22.62	23.00	1.091	62.9	1.006	-0.09	0.258	0.283
	LTE Band 38	20M	QPSK	50	0	Front	10	Full	38000	2595	21.54	22.00	1.112	62.9	1.006	-0.02	0.207	0.232
	LTE Band 38	20M	QPSK	1	49	Back	10	Full	38000	2595	22.62	23.00	1.091	62.9	1.006	-0.19	0.662	0.727
	LTE Band 38	20M	QPSK	50	0	Back	10	Full	38000	2595	21.54	22.00	1.112	62.9	1.006	0.1	0.516	0.577
	LTE Band 38	20M	QPSK	1	49	Left Side	10	Full	38000	2595	22.62	23.00	1.091	62.9	1.006	0.03	0.034	0.037
	LTE Band 38	20M	QPSK	50	0	Left Side	10	Full	38000	2595	21.54	22.00	1.112	62.9	1.006	-0.18	0.026	0.029
	LTE Band 38	20M	QPSK	1	49	Right Side	10	Full	38000	2595	22.62	23.00	1.091	62.9	1.006	0.08	0.087	0.096
	LTE Band 38	20M	QPSK	50	0	Right Side	10	Full	38000	2595	21.54	22.00	1.112	62.9	1.006	-0.04	0.061	0.068
20	LTE Band 38	20M	QPSK	1	49	Bottom Side	10	Full	38000	2595	22.62	23.00	1.091	62.9	1.006	0.18	0.689	0.757
	LTE Band 38	20M	QPSK	50	0	Bottom Side	10	Full	38000	2595	21.54	22.00	1.112	62.9	1.006	-0.18	0.515	0.576

<WLAN SAR>

Plot No.	Band	Mode	Test Position	Gap (mm)	Ch.	Freq. (MHz)	Average Power (dBm)	Tune-Up Limit (dBm)	Tune-up Scaling Factor	Duty Cycle %	Duty Cycle Scaling Factor	Power Drift (dB)	Max Area Scan SAR	Measured 1g SAR (W/kg)	Reported 1g SAR (W/kg)
	WLAN2.4GHz	802.11b 1Mbps	Front	10	6	2437	15.80	16.00	1.047	97.63	1.024		0.165		
21	WLAN2.4GHz	802.11b 1Mbps	Back	10	6	2437	15.80	16.00	1.047	97.63	1.024	-0.05	0.231	0.155	0.166
	WLAN2.4GHz	802.11b 1Mbps	Right Side	10	6	2437	15.80	16.00	1.047	97.63	1.024		0.146		
	WLAN2.4GHz	802.11b 1Mbps	Top Side	10	6	2437	15.80	16.00	1.047	97.63	1.024		0.147		
	WLAN 5.2GHz	802.11a 6Mbps	Front	10	36	5180	10.90	11.50	1.148	87.26	1.146		0.288		
	WLAN 5.2GHz	802.11a 6Mbps	Back	10	36	5180	10.90	11.50	1.148	87.26	1.146		0.438		
	WLAN 5.2GHz	802.11a 6Mbps	Right Side	10	36	5180	10.90	11.50	1.148	87.26	1.146		0.148		
22	WLAN 5.2GHz	802.11a 6Mbps	Top Side	10	36	5180	10.90	11.50	1.148	87.26	1.146	0.09	0.656	0.299	0.393
	WLAN 5.8GHz	802.11n-HT20 MCS0	Front	10	157	5785	10.60	11.50	1.230	86.49	1.156		0.302		
	WLAN 5.8GHz	802.11n-HT20 MCS0	Back	10	157	5785	10.60	11.50	1.230	86.49	1.156		0.420		
	WLAN 5.8GHz	802.11n-HT20 MCS0	Right Side	10	157	5785	10.60	11.50	1.230	86.49	1.156		0.214		
23	WLAN 5.8GHz	802.11n-HT20 MCS0	Top Side	10	157	5785	10.60	11.50	1.230	86.49	1.156	-0.02	0.658	0.251	0.357



15.3 Body Worn Accessory SAR

<GSM SAR>

Plot No.	Band	Mode	Test Position	Gap (mm)	Power Mode	Ch.	Freq. (MHz)	Average Power (dBm)	Tune-Up Limit (dBm)	Tune-up Scaling Factor	Power Drift (dB)	Measured 1g SAR (W/kg)	Reported 1g SAR (W/kg)
	GSM850	GPRS 4 Tx slots	Front	15	Full	189	836.4	27.63	28.00	1.089	0.16	0.187	0.204
24	GSM850	GPRS 4 Tx slots	Back	15	Full	189	836.4	27.63	28.00	1.089	-0.01	0.248	0.270
	GSM1900	GPRS 1 Tx slot	Front	15	Full	810	1909.8	29.43	30.00	1.140	-0.09	0.116	0.132
25	GSM1900	GPRS 1 Tx slot	Back	15	Full	810	1909.8	29.43	30.00	1.140	-0.15	0.155	0.177

<WCDMA SAR>

Plot No.	Band	Mode	Test Position	Gap (mm)	Power Mode	Ch.	Freq. (MHz)	Average Power (dBm)	Tune-Up Limit (dBm)	Tune-up Scaling Factor	Power Drift (dB)	Measured 1g SAR (W/kg)	Reported 1g SAR (W/kg)
	WCDMA Band V	RMC 12.2Kbps	Front	15	Full	4233	846.6	23.67	24.00	1.079	-0.03	0.211	0.228
26	WCDMA Band V	RMC 12.2Kbps	Back	15	Full	4233	846.6	23.67	24.00	1.079	-0.03	0.274	0.296
	WCDMA Band II	RMC 12.2Kbps	Front	15	Full	9262	1852.4	23.46	24.00	1.132	-0.13	0.282	0.319
27	WCDMA Band II	RMC 12.2Kbps	Back	15	Full	9262	1852.4	23.46	24.00	1.132	-0.05	0.403	0.456

<FDD LTE SAR>

Plot No.	Band	BW (MHz)	Modulation	RB Size	RB Offset	Test Position	Gap (mm)	Power Mode	Ch.	Freq. (MHz)	Average Power (dBm)	Tune-Up Limit (dBm)	Tune-up Scaling Factor	Power Drift (dB)	Measured 1g SAR (W/kg)	Reported 1g SAR (W/kg)
	LTE Band 5	10M	QPSK	1	25	Front	15	Full	20525	836.5	23.25	24.00	1.189	-0.03	0.151	0.179
	LTE Band 5	10M	QPSK	25	0	Front	15	Full	20525	836.5	22.34	23.00	1.164	-0.01	0.115	0.134
28	LTE Band 5	10M	QPSK	1	25	Back	15	Full	20525	836.5	23.25	24.00	1.189	-0.01	0.192	0.228
	LTE Band 5	10M	QPSK	25	0	Back	15	Full	20525	836.5	22.34	23.00	1.164	-0.02	0.153	0.178
	LTE Band 4	20M	QPSK	1	49	Front	15	Full	20175	1732.5	23.48	24.00	1.127	0.05	0.338	0.381
	LTE Band 4	20M	QPSK	50	0	Front	15	Full	20175	1732.5	22.42	23.00	1.143	0.08	0.267	0.305
29	LTE Band 4	20M	QPSK	1	49	Back	15	Full	20175	1732.5	23.48	24.00	1.127	0.11	0.460	0.519
	LTE Band 4	20M	QPSK	50	0	Back	15	Full	20175	1732.5	22.42	23.00	1.143	0.07	0.375	0.429
	LTE Band 7	20M	QPSK	1	49	Front	15	Full	21350	2560	23.86	24.00	1.033	-0.15	0.401	0.414
	LTE Band 7	20M	QPSK	50	0	Front	15	Full	21350	2560	22.70	23.00	1.072	-0.19	0.314	0.336
30	LTE Band 7	20M	QPSK	1	49	Back	15	Full	21350	2560	23.86	24.00	1.033	0.09	0.858	0.886
	LTE Band 7	20M	QPSK	1	49	Back	15	Full	20850	2510	23.72	24.00	1.067	-0.14	0.464	0.495
	LTE Band 7	20M	QPSK	1	49	Back	15	Full	21100	2535	23.56	24.00	1.107	0.03	0.791	0.875
	LTE Band 7	20M	QPSK	50	0	Back	15	Full	21350	2560	22.70	23.00	1.072	0.11	0.673	0.721
	LTE Band 7	20M	QPSK	100	0	Back	15	Full	21350	2560	22.64	23.00	1.086	0.04	0.680	0.739



<TDD LTE SAR>

Plot No.	Band	BW (MHz)	Modulation	RB Size	RB Offset	Test Position	Gap (mm)	Power Mode	Ch.	Freq. (MHz)	Average Power (dBm)	Tune-Up Limit (dBm)	Tune-up Scaling Factor	Duty Cycle %	Duty Cycle Scaling Factor	Power Drift (dB)	Measured 1g SAR (W/kg)	Reported 1g SAR (W/kg)
	LTE Band 38	20M	QPSK	1	49	Front	15	Full	38000	2595	22.62	23.00	1.091	62.9	1.006	0.02	0.203	0.223
	LTE Band 38	20M	QPSK	50	0	Front	15	Full	38000	2595	21.54	22.00	1.112	62.9	1.006	0.04	0.136	0.152
31	LTE Band 38	20M	QPSK	1	49	Back	15	Full	38000	2595	22.62	23.00	1.091	62.9	1.006	0.11	0.461	0.506
	LTE Band 38	20M	QPSK	50	0	Back	15	Full	38000	2595	21.54	22.00	1.112	62.9	1.006	0.05	0.311	0.348

<WLAN SAR>

Plot No.	Band	Mode	Test Position	Gap (mm)	Ch.	Freq. (MHz)	Average Power (dBm)	Tune-Up Limit (dBm)	Tune-up Scaling Factor	Duty Cycle %	Duty Cycle Scaling Factor	Power Drift (dB)	Max Area Scan SAR	Measured 1g SAR (W/kg)	Reported 1g SAR (W/kg)
	WLAN2.4GHz	802.11b 1Mbps	Front	15	6	2437	15.80	16.00	1.047	97.63	1.024	0.02	0.0871	0.0623	0.067
32	WLAN2.4GHz	802.11b 1Mbps	Back	15	6	2437	15.80	16.00	1.047	97.63	1.024	0.12	0.103	0.066	0.071
	WLAN 5.3GHz	802.11a 6Mbps	Front	15	64	5320	10.86	11.50	1.159	87.26	1.146		0.146		
33	WLAN 5.3GHz	802.11a 6Mbps	Back	15	64	5320	10.86	11.50	1.159	87.26	1.146	0.01	0.228	0.095	0.126
	WLAN 5.5GHz	802.11n-HT20 MCS0	Front	15	140	5700	10.71	11.50	1.199	86.49	1.156		0.199		
34	WLAN 5.5GHz	802.11n-HT20 MCS0	Back	15	140	5700	10.71	11.50	1.199	86.49	1.156	0.01	0.343	0.098	0.136
	WLAN 5.8GHz	802.11n-HT20 MCS0	Front	15	157	5785	10.60	11.50	1.230	86.49	1.156		0.167		
35	WLAN 5.8GHz	802.11n-HT20 MCS0	Back	15	157	5785	10.60	11.50	1.230	86.49	1.156	0.01	0.251	0.084	0.119



15.4 Product specific 10g SAR

<WCDMA SAR>

Plot No.	Band	Mode	Test Position	Gap (mm)	Power Mode	Ch.	Freq. (MHz)	Average Power (dBm)	Tune-Up Limit (dBm)	Tune-up Scaling Factor	Power Drift (dB)	Measured 10g SAR (W/kg)	Reported 10g SAR (W/kg)
	WCDMA Band II	RMC 12.2Kbps	Back	0	Full	9262	1852.4	23.46	24.00	1.132	-0.17	1.790	2.027
	WCDMA Band II	RMC 12.2Kbps	Back	0	Full	9400	1880	23.28	24.00	1.180	-0.06	1.770	2.089
	WCDMA Band II	RMC 12.2Kbps	Back	0	Full	9538	1907.6	23.31	24.00	1.172	0.07	1.990	2.333
36	WCDMA Band II	RMC 12.2Kbps	Bottom Side	0	Full	9262	1852.4	23.46	24.00	1.132	0.03	2.300	2.605
	WCDMA Band II	RMC 12.2Kbps	Bottom Side	0	Full	9400	1880	23.28	24.00	1.180	-0.01	1.950	2.302
	WCDMA Band II	RMC 12.2Kbps	Bottom Side	0	Full	9538	1907.6	23.31	24.00	1.172	-0.05	1.860	2.180

<FDD LTE SAR>

Plot No.	Band	BW (MHz)	Modulation	RB Size	RB Offset	Test Position	Gap (mm)	Power Mode	Ch.	Freq. (MHz)	Average Power (dBm)	Tune-Up Limit (dBm)	Tune-up Scaling Factor	Power Drift (dB)	Measured 10g SAR (W/kg)	Reported 10g SAR (W/kg)
37	LTE Band 4	20M	QPSK	1	49	Bottom Side	0	Full	20175	1732.5	23.48	24.00	1.127	-0.16	2.340	2.638
	LTE Band 4	20M	QPSK	50	0	Bottom Side	0	Full	20175	1732.5	22.42	23.00	1.143	0.01	1.910	2.183
	LTE Band 4	20M	QPSK	100	0	Bottom Side	0	Full	20175	1732.5	22.47	23.00	1.130	-0.06	1.910	2.158
	LTE Band 7	20M	QPSK	1	49	Back	0	Full	21350	2560	23.86	24.00	1.033	0.04	3.360	3.470
	LTE Band 7	20M	QPSK	1	49	Back	0	Full	20850	2510	23.72	24.00	1.067	-0.01	3.300	3.520
38	LTE Band 7	20M	QPSK	1	49	Back	0	Full	21100	2535	23.56	24.00	1.107	-0.19	3.270	3.619
	LTE Band 7	20M	QPSK	50	0	Back	0	Full	21350	2560	22.70	23.00	1.072	-0.03	2.700	2.893
	LTE Band 7	20M	QPSK	50	0	Back	0	Full	20850	2510	22.34	23.00	1.164	0.05	2.460	2.864
	LTE Band 7	20M	QPSK	50	0	Back	0	Full	21100	2535	22.66	23.00	1.081	-0.05	2.650	2.866
	LTE Band 7	20M	QPSK	100	0	Back	0	Full	21350	2560	22.64	23.00	1.086	-0.08	2.630	2.857
	LTE Band 7	20M	QPSK	1	49	Bottom Side	0	Full	21350	2560	23.86	24.00	1.033	0.06	2.940	3.036
	LTE Band 7	20M	QPSK	1	49	Bottom Side	0	Full	20850	2510	23.72	24.00	1.067	0.07	2.180	2.325
	LTE Band 7	20M	QPSK	1	49	Bottom Side	0	Full	21100	2535	23.56	24.00	1.107	0.18	2.640	2.921
	LTE Band 7	20M	QPSK	50	0	Bottom Side	0	Full	21350	2560	22.70	23.00	1.072	0.17	2.370	2.540
	LTE Band 7	20M	QPSK	50	0	Bottom Side	0	Full	20850	2510	22.34	23.00	1.164	0.09	1.730	2.014
	LTE Band 7	20M	QPSK	50	0	Bottom Side	0	Full	21100	2535	22.66	23.00	1.081	0.11	2.090	2.260
	LTE Band 7	20M	QPSK	100	0	Bottom Side	0	Full	21350	2560	22.64	23.00	1.086	0.19	2.340	2.542

<WLAN SAR>

Plot No.	Band	Mode	Test Position	Gap (mm)	Ch.	Freq. (MHz)	Average Power (dBm)	Tune-Up Limit (dBm)	Tune-up Scaling Factor	Duty Cycle %	Duty Cycle Scaling Factor	Power Drift (dB)	Max Area Scan SAR	Measured 10g SAR (W/kg)	Reported 10g SAR (W/kg)
	WLAN 5.3GHz	802.11a 6Mbps	Front	0	64	5320	10.86	11.50	1.159	87.26	1.146		3.07		
	WLAN 5.3GHz	802.11a 6Mbps	Back	0	64	5320	10.86	11.50	1.159	87.26	1.146	0.01	2.43	0.255	0.339
	WLAN 5.3GHz	802.11a 6Mbps	Right Side	0	64	5320	10.86	11.50	1.159	87.26	1.146		0.517		
39	WLAN 5.3GHz	802.11a 6Mbps	Top Side	0	64	5320	10.86	11.50	1.159	87.26	1.146	0.04	7.95	0.451	0.599
	WLAN 5.5GHz	802.11n-HT20 MCS0	Front	0	140	5700	10.71	11.50	1.199	86.49	1.156		3.59		
	WLAN 5.5GHz	802.11n-HT20 MCS0	Back	0	140	5700	10.71	11.50	1.199	86.49	1.156	0.03	3.28	0.259	0.359
	WLAN 5.5GHz	802.11n-HT20 MCS0	Right Side	0	140	5700	10.71	11.50	1.199	86.49	1.156		0.665		
40	WLAN 5.5GHz	802.11n-HT20 MCS0	Top Side	0	140	5700	10.71	11.50	1.199	86.49	1.156	0.01	6.96	0.479	0.664



15.5 Repeated SAR Measurement

<1g SAR>

No.	Band	Mode	BW (MHz)	Modulation	RB Size	RB Offset	Test Position	Gap (mm)	Ch.	Freq. (MHz)	Average Power (dBm)	Tune-Up Limit (dBm)	Tune-up Scaling Factor	Duty Cycle %	Duty Cycle Scaling Factor	Power Drift (dB)	Measured 1g SAR (W/kg)	Ratio	Reported 1g SAR (W/kg)
1st	WCDMA Band II	RMC 12.2Kbps					Bottom Side	10	9262	1852.4	20.62	21.00	1.091	-	-	-0.19	0.969	1	1.058
2nd	WCDMA Band II	RMC 12.2Kbps					Bottom Side	10	9262	1852.4	20.62	21.00	1.091	-	-	0.03	0.958	1.011	1.046
1st	LTE Band 7	-	20M	QPSK	1	49	Bottom Side	10	21350	2560	21.81	22.50	1.172	-	-	0.01	0.866	1	1.015
2nd	LTE Band 7	-	20M	QPSK	1	49	Bottom Side	10	21350	2560	21.81	22.50	1.172	-	-	0.03	0.862	1.005	1.010
1st	WLAN2.4GHz	802.11b 1Mbps	-	-	-	-	Left Cheek	-	6	2437	15.80	16.00	1.047	97.63	1.024	-0.01	0.849	1	0.910
2nd	WLAN2.4GHz	802.11b 1Mbps	-	-	-	-	Left Cheek	-	6	2437	15.80	16.00	1.047	97.63	1.024	0.05	0.837	1.014	0.897
1st	WLAN 5.3GHz	802.11a 6Mbps	-	-	-	-	Left Tilted	-	64	5320	10.86	11.50	1.159	87.26	1.146	-0.02	0.805	1	1.069
2nd	WLAN 5.3GHz	802.11a 6Mbps	-	-	-	-	Left Tilted	-	64	5320	10.86	11.50	1.159	87.26	1.146	0.02	0.798	1.009	1.060
1st	WLAN 5.5GHz	802.11n-HT20 MCS0	-	-	-	-	Left Tilted	-	140	5700	10.71	11.50	1.199	86.49	1.156	-0.04	0.857	1	1.188
2nd	WLAN 5.5GHz	802.11n-HT20 MCS0	-	-	-	-	Left Tilted	-	140	5700	10.71	11.50	1.199	86.49	1.156	0.06	0.845	1.014	1.172

<10g SAR>

No.	Band	Mode	BW (MHz)	Modulation	RB Size	RB Offset	Test Position	Gap (mm)	Ch.	Freq. (MHz)	Average Power (dBm)	Tune-Up Limit (dBm)	Tune-up Scaling Factor	Power Drift (dB)	Measured 10g SAR (W/kg)	Ratio	Reported 10g SAR (W/kg)
1st	WCDMA Band II	RMC 12.2Kbps	-	-	-	-	Bottom Side	0	9262	1852.4	23.46	24.00	1.132	0.03	2.300	1	2.605
2nd	WCDMA Band II	RMC 12.2Kbps	-	-	-	-	Bottom Side	0	9262	1852.4	23.46	24.00	1.132	0.03	2.290	1.004	2.593
1st	LTE Band 4	-	20M	QPSK	1	49	Bottom Side	0	20175	1732.5	23.48	24.00	1.127	-0.16	2.340	1	2.638
2nd	LTE Band 4	-	20M	QPSK	1	49	Bottom Side	0	20175	1732.5	23.48	24.00	1.127	-0.01	2.320	1.009	2.615
1st	LTE Band 7	-	20M	QPSK	1	49	Back	0	21350	2560	23.86	24.00	1.033	0.04	3.360	1	3.470
2nd	LTE Band 7	-	20M	QPSK	1	49	Back	0	21350	2560	23.86	24.00	1.033	0.04	3.360	1.000	3.470

General Note:

1. Per KDB 865664 D01v01r04, for each frequency band, repeated SAR measurement is required only when the measured SAR is $\geq 0.8W/kg$.
2. Per KDB 865664 D01v01r04, if the ratio among the repeated measurement is ≤ 1.2 and the measured SAR $< 1.45W/kg$, only one repeated measurement is required.
3. Per KDB 865664 D01v01r04, if the extremity repeated SAR is necessary, the same procedures should be adapted for measurements according to extremity and occupational exposure limits by applying a factor of 2.5 for extremity exposure and a factor of 5 for occupational exposure to the corresponding SAR thresholds.
4. The ratio is the difference in percentage between original and repeated *measured SAR*.
5. All measurement SAR result is scaled-up to account for tune-up tolerance and is compliant.



16. Simultaneous Transmission Analysis

No.	Simultaneous Transmission Configurations	Portable Handset			Note
		Head	Body-worn	Hotspot	
1.	GSM Voice + WLAN2.4GHz	Yes	Yes		
2.	GPRS/EDGE + WLAN2.4GHz	Yes	Yes	Yes	WWAN VoIP
3.	WCDMA + WLAN2.4GHz	Yes	Yes	Yes	WWAN VoIP
4.	LTE + WLAN2.4GHz	Yes	Yes	Yes	WWAN VoIP
5.	GSM Voice + WLAN5.3/5.5GHz	Yes	Yes		
6.	GPRS/EDGE + WLAN5.3/5.5GHz	Yes	Yes		WWAN VoIP
7.	WCDMA + WLAN5.3/5.5GHz	Yes	Yes		WWAN VoIP
8.	LTE + WLAN5.3/5.5GHz	Yes	Yes		WWAN VoIP
9.	GSM Voice + WLAN5.2/5.8GHz	Yes	Yes		
10.	GPRS/EDGE + WLAN5.2/5.8GHz	Yes	Yes	Yes	WWAN VoIP
11.	WCDMA + WLAN5.2/5.8GHz	Yes	Yes	Yes	WWAN VoIP
12.	LTE + WLAN5.2/5.8GHz	Yes	Yes	Yes	WWAN VoIP
13.	GSM Voice + Bluetooth		Yes		
14.	GPRS/EDGE + Bluetooth		Yes		WWAN VoIP
15.	WCDMA + Bluetooth		Yes		WWAN VoIP
16.	LTE + Bluetooth		Yes		WWAN VoIP

General Note:

- This device supports VoIP in GPRS, EGPRS, WCDMA and LTE (e.g. for 3rd-party VoIP), LTE supports VoLTE operation.
- EUT will choose each GSM, WCDMA, and LTE according to the network signal condition; therefore, they will not operate simultaneously at any moment.
- This device 2.4GHz WLAN/ 5.2GHz WLAN/5.8GHz WLAN support hotspot operation, and 5.2GHz WLAN/5.8GHz WLAN supports WiFi Direct (GC/GO), and 5.3GHz / 5.5GHz supports WiFi Direct (GC only).
- WLAN 2.4GHz and Bluetooth share the same antenna so can't transmit simultaneously.
- EUT will choose either WLAN 2.4GHz or WLAN 5GHz according to the network signal condition; therefore, 2.4GHz WLAN and 5GHz WLAN will not operate simultaneously at any moment though they have independent antenna.
- According to the EUT character, WLAN 5GHz and Bluetooth can't transmit simultaneously.
- Chose the worst zoom scan SAR of WLAN correspondingly for co-located with WWAN analysis.
- The reported SAR summation is calculated based on the same configuration and test position.
- Per KDB 447498 D01v06, simultaneous transmission SAR is compliant if,
 - Scalar SAR summation < 1.6W/kg.
 - $SPLSR = (SAR1 + SAR2)^{1.5} / (\text{min. separation distance, mm})$, and the peak separation distance is determined from the square root of $[(x1-x2)^2 + (y1-y2)^2 + (z1-z2)^2]$, where (x1, y1, z1) and (x2, y2, z2) are the coordinates of the extrapolated peak SAR locations in the zoom scan.
 - If $SPLSR \leq 0.04$, simultaneously transmission SAR measurement is not necessary.
 - Simultaneously transmission SAR measurement, and the reported multi-band SAR < 1.6W/kg.
 - The SPLSR calculated results please refer to section 16.2.
- For simultaneous transmission analysis, Bluetooth SAR is estimated per KDB 447498 D01v06 based on the formula below.
 - $(\text{max. power of channel, including tune-up tolerance, mW}) / (\text{min. test separation distance, mm}) \cdot [\sqrt{f(\text{GHz})} / x] \text{ W/kg}$ for test separation distances $\leq 50 \text{ mm}$; where $x = 7.5$ for 1-g SAR, and $x = 18.75$ for 10-g SAR.
 - When the minimum separation distance is < 5mm, the distance is used 5mm to determine SAR test exclusion.
 - 0.4 W/kg for 1-g SAR and 1.0 W/kg for 10-g SAR, when the test separation distances is > 50 mm.

<1g SAR>

Bluetooth Max Power (dBm)	Exposure Position	Body worn
	Test separation	15 mm
3.0	Estimated SAR (W/kg)	0.028

<10g SAR>

Bluetooth Max Power (dBm)	Exposure Position	Product specific 10g SAR
	Test separation	0 mm
3.0	Estimated SAR (W/kg)	0.034



16.1 Head Exposure Conditions

WWAN Band		Exposure Position	1	2	3	1+2 Summed 1g SAR (W/kg)	1+3 Summed 1g SAR (W/kg)
			WWAN	2.4GHz WLAN	5GHz WLAN		
			1g SAR (W/kg)	1g SAR (W/kg)	1g SAR (W/kg)		
GSM	GSM850	Right Cheek	0.208	0.910	1.188	1.12	1.40
		Right Tilted	0.117	0.910	1.188	1.03	1.31
		Left Cheek	0.199	0.910	1.188	1.11	1.39
		Left Tilted	0.121	0.910	1.188	1.03	1.31
	GSM1900	Right Cheek	0.162	0.910	1.188	1.07	1.35
		Right Tilted	0.095	0.910	1.188	1.01	1.28
		Left Cheek	0.123	0.910	1.188	1.03	1.31
		Left Tilted	0.096	0.910	1.188	1.01	1.28
WCDMA	Band V	Right Cheek	0.229	0.910	1.188	1.14	1.42
		Right Tilted	0.146	0.910	1.188	1.06	1.33
		Left Cheek	0.240	0.910	1.188	1.15	1.43
		Left Tilted	0.146	0.910	1.188	1.06	1.33
	Band II	Right Cheek	0.284	0.910	1.188	1.19	1.47
		Right Tilted	0.138	0.910	1.188	1.05	1.33
		Left Cheek	0.168	0.910	1.188	1.08	1.36
		Left Tilted	0.140	0.910	1.188	1.05	1.33
LTE	Band 5	Right Cheek	0.182	0.910	1.188	1.09	1.37
		Right Tilted	0.106	0.910	1.188	1.02	1.29
		Left Cheek	0.187	0.910	1.188	1.10	1.38
		Left Tilted	0.116	0.910	1.188	1.03	1.30
	Band 4	Right Cheek	0.289	0.910	1.188	1.20	1.48
		Right Tilted	0.166	0.910	1.188	1.08	1.35
		Left Cheek	0.166	0.910	1.188	1.08	1.35
		Left Tilted	0.150	0.910	1.188	1.06	1.34
	Band 7	Right Cheek	0.114	0.910	1.188	1.02	1.30
		Right Tilted	0.023	0.910	1.188	0.93	1.21
		Left Cheek	0.070	0.910	1.188	0.98	1.26
		Left Tilted	0.039	0.910	1.188	0.95	1.23
	Band 38	Right Cheek	0.067	0.910	1.188	0.98	1.26
		Right Tilted	0.013	0.910	1.188	0.92	1.20
		Left Cheek	0.042	0.910	1.188	0.95	1.23
		Left Tilted	0.021	0.910	1.188	0.93	1.21

16.2 Hotspot Exposure Conditions

WWAN Band		Exposure Position	1	2	3	1+2 Summed 1g SAR (W/kg)	1+3 Summed 1g SAR (W/kg)
			WWAN	2.4GHz WLAN	5GHz WLAN		
			1g SAR (W/kg)	1g SAR (W/kg)	1g SAR (W/kg)		
GSM	GSM850	Front	0.209	0.166	0.393	0.38	0.60
		Back	0.311	0.166	0.393	0.48	0.70
		Left side	0.193			0.19	0.19
		Right side	0.174	0.166	0.393	0.34	0.57
		Top side		0.166	0.393	0.17	0.39
		Bottom side	0.052			0.05	0.05
	GSM1900	Front	0.281	0.166	0.393	0.45	0.67
		Back	0.379	0.166	0.393	0.55	0.77
		Left side	0.096			0.10	0.10
		Right side	0.138	0.166	0.393	0.30	0.53
		Top side		0.166	0.393	0.17	0.39
		Bottom side	0.595			0.60	0.60
WCDMA	Band V	Front	0.236	0.166	0.393	0.40	0.63
		Back	0.346	0.166	0.393	0.51	0.74
		Left side	0.236			0.24	0.24
		Right side	0.224	0.166	0.393	0.39	0.62
		Top side		0.166	0.393	0.17	0.39
		Bottom side	0.058			0.06	0.06
	Band II	Front	0.415	0.166	0.393	0.58	0.81
		Back	0.667	0.166	0.393	0.83	1.06
		Left side	0.061			0.06	0.06
		Right side	0.159	0.166	0.393	0.33	0.55
		Top side		0.166	0.393	0.17	0.39
		Bottom side	1.058			1.06	1.06



WWAN Band		Exposure Position	1	2	3	1+2 Summed 1g SAR (W/kg)	1+3 Summed 1g SAR (W/kg)
			WWAN	2.4GHz WLAN	5GHz WLAN		
			1g SAR (W/kg)	1g SAR (W/kg)	1g SAR (W/kg)		
LTE	Band 5	Front	0.193	0.166	0.393	0.36	0.59
		Back	0.280	0.166	0.393	0.45	0.67
		Left side	0.178			0.18	0.18
		Right side	0.171	0.166	0.393	0.34	0.56
		Top side		0.166	0.393	0.17	0.39
		Bottom side	0.046			0.05	0.05
	Band 4	Front	0.451	0.166	0.393	0.62	0.84
		Back	0.646	0.166	0.393	0.81	1.04
		Left side	0.055			0.06	0.06
		Right side	0.131	0.166	0.393	0.30	0.52
		Top side		0.166	0.393	0.17	0.39
		Bottom side	0.924			0.92	0.92
	Band 7	Front	0.388	0.166	0.393	0.55	0.78
		Back	1.027	0.166	0.393	1.19	1.42
		Left side	0.046			0.05	0.05
		Right side	0.117	0.166	0.393	0.28	0.51
		Top side		0.166	0.393	0.17	0.39
		Bottom side	1.034			1.03	1.03
	Band 38	Front	0.283	0.166	0.393	0.45	0.68
		Back	0.727	0.166	0.393	0.89	1.12
		Left side	0.037			0.04	0.04
		Right side	0.096	0.166	0.393	0.26	0.49
		Top side		0.166	0.393	0.17	0.39
		Bottom side	0.757			0.76	0.76



16.3 Body-Worn Accessory Exposure Conditions

WWAN Band		Exposure Position	1	2	3	4	1+2 Summed 1g SAR (W/kg)	1+3 Summed 1g SAR (W/kg)	1+4 Summed 1g SAR (W/kg)
			WWAN	2.4GHz WLAN	5GHz WLAN	Bluetooth			
			1g SAR (W/kg)	1g SAR (W/kg)	1g SAR (W/kg)	Estimated 1g SAR (W/kg)			
GSM	GSM850	Front	0.204	0.071	0.136	0.028	0.28	0.34	0.23
		Back	0.270	0.071	0.136	0.028	0.34	0.41	0.30
	GSM1900	Front	0.132	0.071	0.136	0.028	0.20	0.27	0.16
		Back	0.177	0.071	0.136	0.028	0.25	0.31	0.21
WCDMA	Band V	Front	0.228	0.071	0.136	0.028	0.30	0.36	0.26
		Back	0.296	0.071	0.136	0.028	0.37	0.43	0.32
	Band II	Front	0.319	0.071	0.136	0.028	0.39	0.46	0.35
		Back	0.456	0.071	0.136	0.028	0.53	0.59	0.48
LTE	Band 5	Front	0.179	0.071	0.136	0.028	0.25	0.32	0.21
		Back	0.228	0.071	0.136	0.028	0.30	0.36	0.26
	Band 4	Front	0.381	0.071	0.136	0.028	0.45	0.52	0.41
		Back	0.519	0.071	0.136	0.028	0.59	0.66	0.55
	Band 7	Front	0.414	0.071	0.136	0.028	0.49	0.55	0.44
		Back	0.886	0.071	0.136	0.028	0.96	1.02	0.91
	Band 38	Front	0.223	0.071	0.136	0.028	0.29	0.36	0.25
		Back	0.506	0.071	0.136	0.028	0.58	0.64	0.53



16.4 Product Specific 10g SAR Exposure Conditions

WWAN Band		Exposure Position	1	2	3	1+2 Summed 10g SAR (W/kg)	1+3 Summed 10g SAR (W/kg)
			WWAN	5GHz WLAN	Bluetooth		
			10g SAR (W/kg)	10g SAR (W/kg)	Estimated 10g SAR (W/kg)		
WCDMA	Band II	Back	2.333	0.359	0.034	2.69	2.37
		Bottom Side	2.605			2.61	2.61
LTE	Band 4	Bottom Side	2.638			2.64	2.64
	Band 7	Back	3.619	0.359	0.034	3.98	3.65
		Bottom Side	3.036			3.04	3.04

Test Engineer: Nick Hu

17. Uncertainty Assessment

The component of uncertainty may generally be categorized according to the methods used to evaluate them. The evaluation of uncertainty by the statistical analysis of a series of observations is termed a Type A evaluation of uncertainty. The evaluation of uncertainty by means other than the statistical analysis of a series of observation is termed a Type B evaluation of uncertainty. Each component of uncertainty, however evaluated, is represented by an estimated standard deviation, termed standard uncertainty, which is determined by the positive square root of the estimated variance.

A Type A evaluation of standard uncertainty may be based on any valid statistical method for treating data. This includes calculating the standard deviation of the mean of a series of independent observations; using the method of least squares to fit a curve to the data in order to estimate the parameter of the curve and their standard deviations; or carrying out an analysis of variance in order to identify and quantify random effects in certain kinds of measurement.

A type B evaluation of standard uncertainty is typically based on scientific judgment using all of the relevant information available. These may include previous measurement data, experience, and knowledge of the behavior and properties of relevant materials and instruments, manufacture’s specification, data provided in calibration reports and uncertainties assigned to reference data taken from handbooks. Broadly speaking, the uncertainty is either obtained from an outdoor source or obtained from an assumed distribution, such as the normal distribution, rectangular or triangular distributions indicated in table below.

Uncertainty Distributions	Normal	Rectangular	Triangular	U-Shape
Multi-plying Factor ^(a)	1/k ^(b)	1/√3	1/√6	1/√2

(a) standard uncertainty is determined as the product of the multiplying factor and the estimated range of variations in the measured quantity

(b) κ is the coverage factor

Table 17.1. Standard Uncertainty for Assumed Distribution

The combined standard uncertainty of the measurement result represents the estimated standard deviation of the result. It is obtained by combining the individual standard uncertainties of both Type A and Type B evaluation using the usual “root-sum-squares” (RSS) methods of combining standard deviations by taking the positive square root of the estimated variances.

Expanded uncertainty is a measure of uncertainty that defines an interval about the measurement result within which the measured value is confidently believed to lie. It is obtained by multiplying the combined standard uncertainty by a coverage factor. Typically, the coverage factor ranges from 2 to 3. Using a coverage factor allows the true value of a measured quantity to be specified with a defined probability within the specified uncertainty range. For purpose of this document, a coverage factor two is used, which corresponds to confidence interval of about 95 %. The DASY uncertainty Budget is shown in the following tables.



Error Description	Uncertainty Value (±%)	Probability	Divisor	(Ci) 1g	(Ci) 10g	Standard Uncertainty (1g) (±%)	Standard Uncertainty (10g) (±%)
Measurement System							
Probe Calibration	6.0	N	1	1	1	6.0	6.0
Axial Isotropy	4.7	R	1.732	0.7	0.7	1.9	1.9
Hemispherical Isotropy	9.6	R	1.732	0.7	0.7	3.9	3.9
Boundary Effects	1.0	R	1.732	1	1	0.6	0.6
Linearity	4.7	R	1.732	1	1	2.7	2.7
System Detection Limits	1.0	R	1.732	1	1	0.6	0.6
Modulation Response	3.2	R	1.732	1	1	1.8	1.8
Readout Electronics	0.3	N	1	1	1	0.3	0.3
Response Time	0.0	R	1.732	1	1	0.0	0.0
Integration Time	2.6	R	1.732	1	1	1.5	1.5
RF Ambient Noise	3.0	R	1.732	1	1	1.7	1.7
RF Ambient Reflections	3.0	R	1.732	1	1	1.7	1.7
Probe Positioner	0.4	R	1.732	1	1	0.2	0.2
Probe Positioning	2.9	R	1.732	1	1	1.7	1.7
Max. SAR Eval.	2.0	R	1.732	1	1	1.2	1.2
Test Sample Related							
Device Positioning	3.0	N	1	1	1	3.0	3.0
Device Holder	3.6	N	1	1	1	3.6	3.6
Power Drift	5.0	R	1.732	1	1	2.9	2.9
Power Scaling	0.0	R	1.732	1	1	0.0	0.0
Phantom and Setup							
Phantom Uncertainty	6.1	R	1.732	1	1	3.5	3.5
SAR correction	0.0	R	1.732	1	0.84	0.0	0.0
Liquid Conductivity Repeatability	0.2	N	1	0.78	0.71	0.1	0.1
Liquid Conductivity (target)	5.0	R	1.732	0.78	0.71	2.3	2.0
Liquid Conductivity (mea.)	2.5	R	1.732	0.78	0.71	1.1	1.0
Temp. unc. - Conductivity	3.4	R	1.732	0.78	0.71	1.5	1.4
Liquid Permittivity Repeatability	0.15	N	1	0.23	0.26	0.0	0.0
Liquid Permittivity (target)	5.0	R	1.732	0.23	0.26	0.7	0.8
Liquid Permittivity (mea.)	2.5	R	1.732	0.23	0.26	0.3	0.4
Temp. unc. - Permittivity	0.83	R	1.732	0.23	0.26	0.1	0.1
Combined Std. Uncertainty						11.4%	11.4%
Coverage Factor for 95 %						K=2	K=2
Expanded STD Uncertainty						22.9%	22.7%

Table 17.2. Uncertainty Budget for frequency range 300 MHz to 3 GHz

Error Description	Uncertainty Value (±%)	Probability	Divisor	(Ci) 1g	(Ci) 10g	Standard Uncertainty (1g) (±%)	Standard Uncertainty (10g) (±%)
Measurement System							
Probe Calibration	6.55	N	1	1	1	6.6	6.6
Axial Isotropy	4.7	R	1.732	0.7	0.7	1.9	1.9
Hemispherical Isotropy	9.6	R	1.732	0.7	0.7	3.9	3.9
Boundary Effects	2.0	R	1.732	1	1	1.2	1.2
Linearity	4.7	R	1.732	1	1	2.7	2.7
System Detection Limits	1.0	R	1.732	1	1	0.6	0.6
Modulation Response	3.2	R	1.732	1	1	1.8	1.8
Readout Electronics	0.3	N	1	1	1	0.3	0.3
Response Time	0.0	R	1.732	1	1	0.0	0.0
Integration Time	2.6	R	1.732	1	1	1.5	1.5
RF Ambient Noise	3.0	R	1.732	1	1	1.7	1.7
RF Ambient Reflections	3.0	R	1.732	1	1	1.7	1.7
Probe Positioner	0.4	R	1.732	1	1	0.2	0.2
Probe Positioning	6.7	R	1.732	1	1	3.9	3.9
Max. SAR Eval.	4.0	R	1.732	1	1	2.3	2.3
Test Sample Related							
Device Positioning	3.0	N	1	1	1	3.0	3.0
Device Holder	3.6	N	1	1	1	3.6	3.6
Power Drift	5.0	R	1.732	1	1	2.9	2.9
Power Scaling	0.0	R	1.732	1	1	0.0	0.0
Phantom and Setup							
Phantom Uncertainty	6.6	R	1.732	1	1	3.8	3.8
SAR correction	0.0	R	1.732	1	0.84	0.0	0.0
Liquid Conductivity Repeatability	0.2	N	1	0.78	0.71	0.1	0.1
Liquid Conductivity (target)	5.0	R	1.732	0.78	0.71	2.3	2.0
Liquid Conductivity (mea.)	2.5	R	1.732	0.78	0.71	1.1	1.0
Temp. unc. - Conductivity	3.4	R	1.732	0.78	0.71	1.5	1.4
Liquid Permittivity Repeatability	0.15	N	1	0.23	0.26	0.0	0.0
Liquid Permittivity (target)	5.0	R	1.732	0.23	0.26	0.7	0.8
Liquid Permittivity (mea.)	2.5	R	1.732	0.23	0.26	0.3	0.4
Temp. unc. - Permittivity	0.83	R	1.732	0.23	0.26	0.1	0.1
Combined Std. Uncertainty						12.5%	12.5%
Coverage Factor for 95 %						K=2	K=2
Expanded STD Uncertainty						25.1%	25.0%

Table 17.3. Uncertainty Budget for frequency range 3 GHz to 6 GHz



18. References

- [1] FCC 47 CFR Part 2 "Frequency Allocations and Radio Treaty Matters; General Rules and Regulations"
- [2] ANSI/IEEE Std. C95.1-1992, "IEEE Standard for Safety Levels with Respect to Human Exposure to Radio Frequency Electromagnetic Fields, 3 kHz to 300 GHz", September 1992
- [3] IEEE Std. 1528-2013, "IEEE Recommended Practice for Determining the Peak Spatial-Average Specific Absorption Rate (SAR) in the Human Head from Wireless Communications Devices: Measurement Techniques", Sep 2013
- [4] SPEAG DASY System Handbook
- [5] FCC KDB 865664 D01 v01r04, "SAR Measurement Requirements for 100 MHz to 6 GHz", Aug 2015.
- [6] FCC KDB 865664 D02 v01r02, "RF Exposure Compliance Reporting and Documentation Considerations" Oct 2015.
- [7] FCC KDB 447498 D01 v06, "Mobile and Portable Device RF Exposure Procedures and Equipment Authorization Policies", Oct 2015
- [8] FCC KDB 648474 D04 v01r03, "SAR Evaluation Considerations for Wireless Handsets", Oct 2015
- [9] FCC KDB 248227 D01 v02r02, "SAR Guidance for IEEE 802.11 (WiFi) Transmitters", Oct 2015.
- [10] FCC KDB 941225 D01 v03r01, "3G SAR MEAUREMENT PROCEDURES", Oct 2015
- [11] FCC KDB 941225 D05 v02r05, "SAR Evaluation Considerations for LTE Devices", Dec 2015
- [12] FCC KDB 941225 D05A v01r02, "Rel. 10 LTE SAR Test Guidance and KDB Inquiries", Oct 2015
- [13] FCC KDB 941225 D06 v02r01, "SAR Evaluation Procedures for Portable Devices with Wireless Router Capabilities", Oct 2015.



Appendix A. Plots of System Performance Check

The plots are shown as follows.

System Check_Head_835MHz

DUT: D835V2 - SN:4d091

Communication System: UID 0, CW; Frequency: 835 MHz; Duty Cycle: 1:1

Medium: HSL_850 Medium parameters used: $f = 835 \text{ MHz}$; $\sigma = 0.909 \text{ S/m}$; $\epsilon_r = 42.38$; $\rho = 1000 \text{ kg/m}^3$

Ambient Temperature : $23.5 \text{ }^\circ\text{C}$; Liquid Temperature : $22.8 \text{ }^\circ\text{C}$

DASY5 Configuration:

- Probe: EX3DV4 - SN3857; ConvF(9.73, 9.73, 9.73); Calibrated: 2017.5.26;
- Sensor-Surface: 2mm (Mechanical Surface Detection)
- Electronics: DAE4 Sn1210; Calibrated: 2017.5.25
- Phantom: SAM2; Type: SAM; Serial: TP-1644
- Measurement SW: DASY52, Version 52.8 (8); SEMCAD X Version 14.6.10 (7331)

Pin=250mW/Area Scan (61x61x1): Interpolated grid: $dx=1.500 \text{ mm}$, $dy=1.500 \text{ mm}$

Maximum value of SAR (interpolated) = 3.09 W/kg

Pin=250mW/Zoom Scan (5x5x7)/Cube 0: Measurement grid: $dx=8\text{mm}$, $dy=8\text{mm}$, $dz=5\text{mm}$

Reference Value = 54.11 V/m ; Power Drift = -0.02 dB

Peak SAR (extrapolated) = 3.61 W/kg

SAR(1 g) = 2.44 W/kg ; SAR(10 g) = 1.6 W/kg

Maximum value of SAR (measured) = 3.09 W/kg

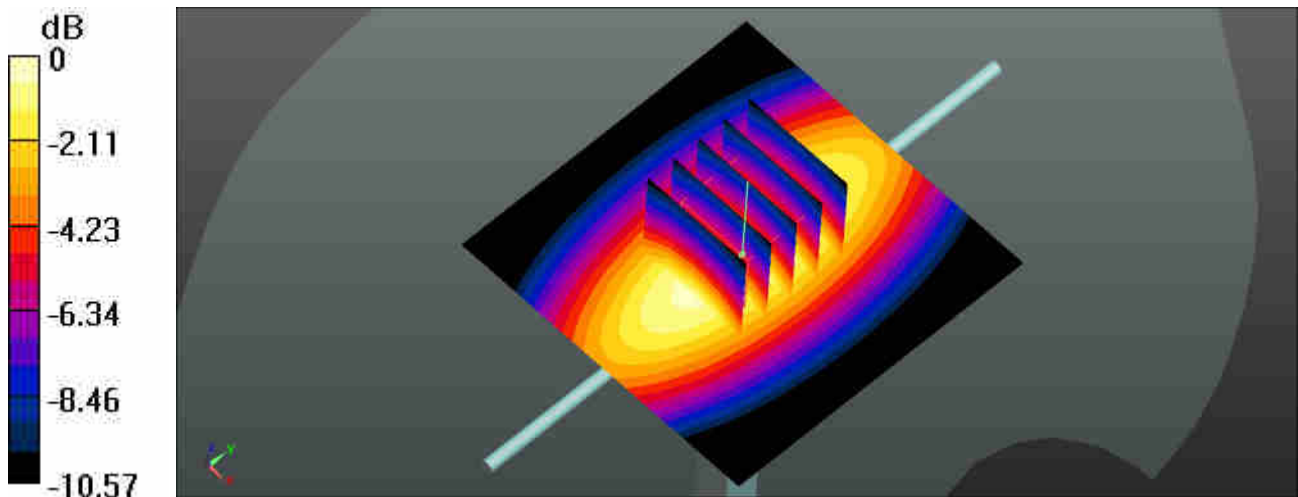

0 dB = 3.09 W/kg = 4.90 dBW/kg

System Check_Head_1750MHz

DUT: D1750V2 - SN:1069

Communication System: UID 0, CW; Frequency: 1750 MHz; Duty Cycle: 1:1

Medium: HSL_1750 Medium parameters used: $f = 1750$ MHz; $\sigma = 1.362$ S/m; $\epsilon_r = 39.639$; $\rho = 1000$ kg/m³

Ambient Temperature : 23.4 °C ; Liquid Temperature : 22.7 °C

DASY5 Configuration:

- Probe: EX3DV4 - SN3857; ConvF(8.47, 8.47, 8.47); Calibrated: 2017.5.26;
- Sensor-Surface: 2mm (Mechanical Surface Detection)
- Electronics: DAE4 Sn1210; Calibrated: 2017.5.25
- Phantom: SAM2; Type: SAM; Serial: TP-1644
- Measurement SW: DASY52, Version 52.8 (8); SEMCAD X Version 14.6.10 (7331)

Pin=250mW/Area Scan (61x61x1): Interpolated grid: dx=1.500 mm, dy=1.500 mm

Maximum value of SAR (interpolated) = 13.8 W/kg

Pin=250mW/Zoom Scan (5x5x7)/Cube 0: Measurement grid: dx=8mm, dy=8mm, dz=5mm

Reference Value = 88.95 V/m; Power Drift = -0.03 dB

Peak SAR (extrapolated) = 17.2 W/kg

SAR(1 g) = 9.55 W/kg; SAR(10 g) = 5.07 W/kg

Maximum value of SAR (measured) = 13.5 W/kg

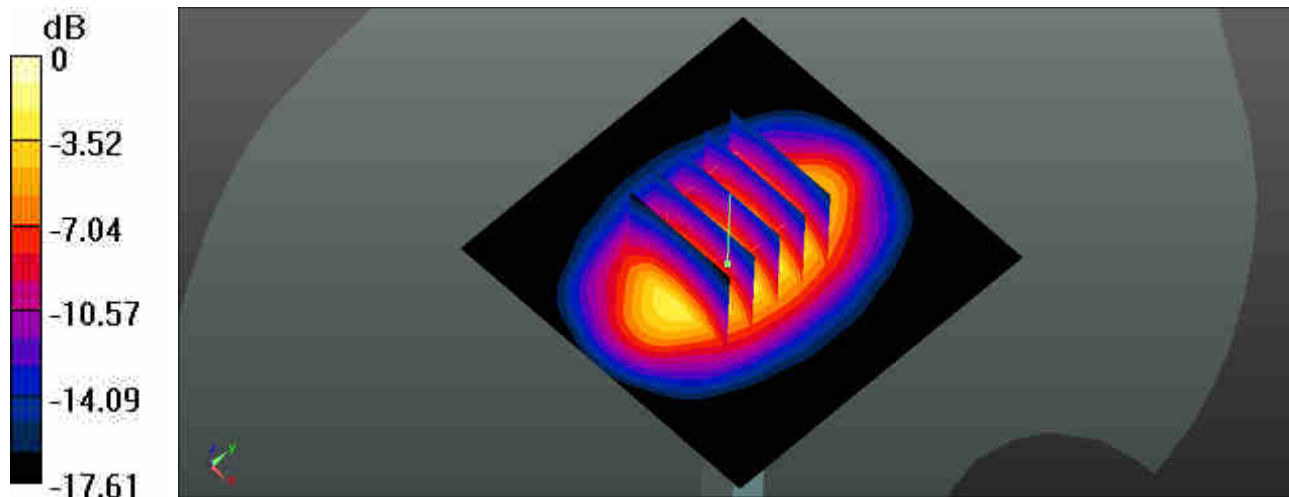

0 dB = 13.5 W/kg = 11.30 dBW/kg

System Check_Head_1900MHz

DUT: D1900V2 - SN:5d118

Communication System: UID 0, CW (0); Frequency: 1900 MHz; Duty Cycle: 1:1

Medium: HSL_1900 Medium parameters used: $f = 1900$ MHz; $\sigma = 1.385$ S/m; $\epsilon_r = 39.334$; $\rho = 1000$ kg/m³

Ambient Temperature : 23.4 °C ; Liquid Temperature : 22.7 °C

DASY5 Configuration:

- Probe: EX3DV4 - SN3857; ConvF(8.29, 8.29, 8.29); Calibrated: 2017.5.26;
- Sensor-Surface: 2mm (Mechanical Surface Detection)
- Electronics: DAE4 Sn1210; Calibrated: 2017.5.25
- Phantom: SAM2; Type: SAM; Serial: TP-1644
- Measurement SW: DASY52, Version 52.8 (8); SEMCAD X Version 14.6.10 (7331)

Pin=250mW/Area Scan (61x61x1): Interpolated grid: dx=1.500 mm, dy=1.500 mm

Maximum value of SAR (interpolated) = 13.4 W/kg

Pin=250mW/Zoom Scan (5x5x7)/Cube 0: Measurement grid: dx=8mm, dy=8mm, dz=5mm

Reference Value = 87.51 V/m; Power Drift = -0.02 dB

Peak SAR (extrapolated) = 16.9 W/kg

SAR(1 g) = 9.52 W/kg; SAR(10 g) = 5.02 W/kg

Maximum value of SAR (measured) = 13.5 W/kg

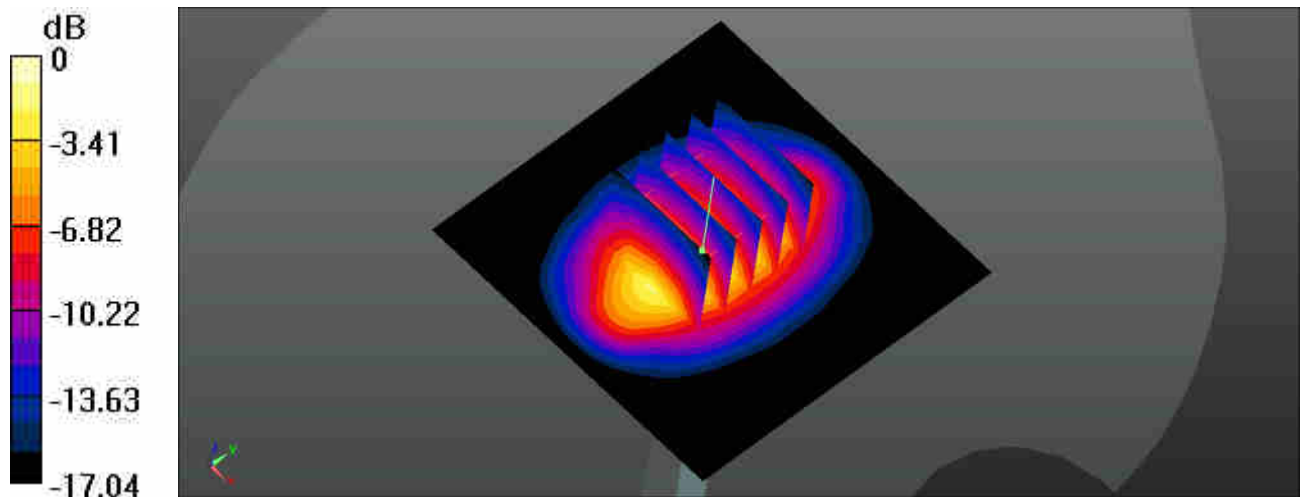

0 dB = 13.5 W/kg = 11.30 dBW/kg

System Check_Head_2450MHz

DUT: D2450V2 - SN:840

Communication System: UID 0, CW (0); Frequency: 2450 MHz; Duty Cycle: 1:1

Medium: HSL_2450 Medium parameters used: $f = 2450$ MHz; $\sigma = 1.877$ S/m; $\epsilon_r = 38.333$; $\rho = 1000$ kg/m³

Ambient Temperature : 23.5 °C ; Liquid Temperature : 22.5 °C

DASY5 Configuration:

- Probe: EX3DV4 - SN3857; ConvF(7.71, 7.71, 7.71); Calibrated: 2017.5.26;
- Sensor-Surface: 2mm (Mechanical Surface Detection)
- Electronics: DAE4 Sn1210; Calibrated: 2017.5.25
- Phantom: SAM3; Type: SAM; Serial: TP-1542
- Measurement SW: DASY52, Version 52.8 (8); SEMCAD X Version 14.6.10 (7331)

Pin=250mW/Area Scan (71x71x1): Interpolated grid: dx=1.200 mm, dy=1.200 mm

Maximum value of SAR (interpolated) = 20.7 W/kg

Pin=250mW/Zoom Scan (7x7x7)/Cube 0: Measurement grid: dx=5mm, dy=5mm, dz=5mm

Reference Value = 88.21 V/m; Power Drift = 0.07 dB

Peak SAR (extrapolated) = 28.1 W/kg

SAR(1 g) = 12.9 W/kg; SAR(10 g) = 5.82 W/kg

Maximum value of SAR (measured) = 20.2 W/kg

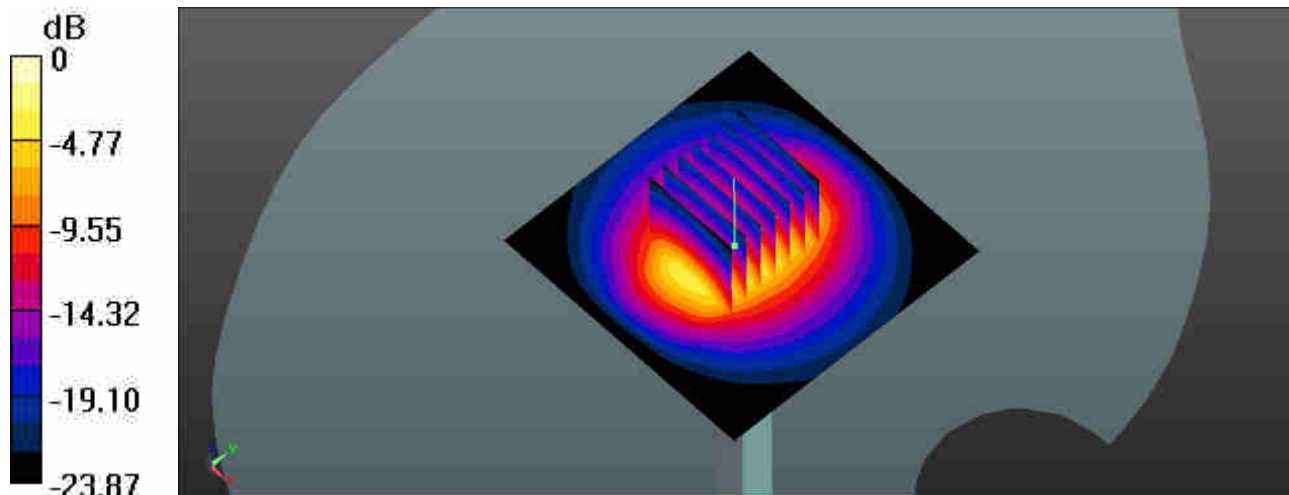

0 dB = 20.2 W/kg = 13.05 dBW/kg

System Check_Head_2600MHz

DUT: D2600V2 - SN:1061

Communication System: UID 0, CW; Frequency: 2600 MHz; Duty Cycle: 1:1

Medium: HSL_2600 Medium parameters used: $f = 2600$ MHz; $\sigma = 2.05$ S/m; $\epsilon_r = 37.758$; $\rho = 1000$ kg/m³

Ambient Temperature : 23.2 °C ; Liquid Temperature : 22.8 °C

DASY5 Configuration:

- Probe: EX3DV4 - SN3857; ConvF(7.62, 7.62, 7.62); Calibrated: 2017.5.26;
- Sensor-Surface: 2mm (Mechanical Surface Detection)
- Electronics: DAE4 Sn1210; Calibrated: 2017.5.25
- Phantom: SAM3; Type: SAM; Serial: TP-1542
- Measurement SW: DASY52, Version 52.8 (8); SEMCAD X Version 14.6.10 (7331)

Pin=250mW/Area Scan (61x61x1): Interpolated grid: dx=1.500 mm, dy=1.500 mm

Maximum value of SAR (interpolated) = 21.9 W/kg

Pin=250mW/Zoom Scan (5x5x7)/Cube 0: Measurement grid: dx=8mm, dy=8mm, dz=5mm

Reference Value = 84.98 V/m; Power Drift = 0.18 dB

Peak SAR (extrapolated) = 31.8 W/kg

SAR(1 g) = 14.3 W/kg; SAR(10 g) = 6.22 W/kg

Maximum value of SAR (measured) = 22.7 W/kg

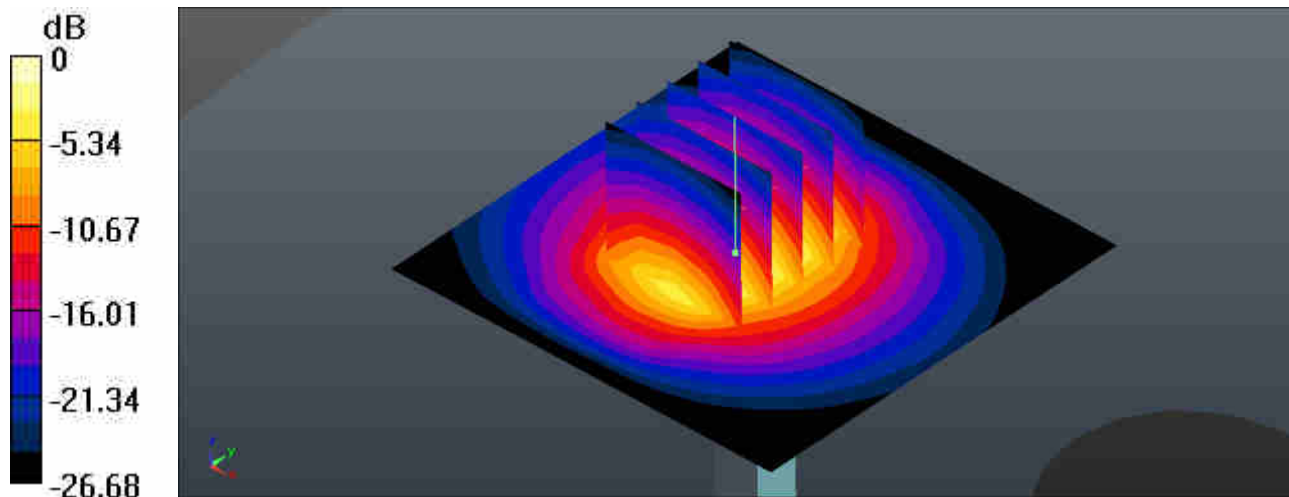

0 dB = 22.7 W/kg = 13.56 dBW/kg

System Check_Head_5250MHz

DUT: D5GHzV2-SN:1113

Communication System: UID 0, CW (0); Frequency: 5250 MHz; Duty Cycle: 1:1
Medium: HSL_5000 Medium parameters used: $f = 5250$ MHz; $\sigma = 4.631$ S/m; $\epsilon_r = 36.749$; $\rho = 1000$ kg/m³
Ambient Temperature : 23.4 °C ; Liquid Temperature : 22.6 °C

DASY5 Configuration:

- Probe: EX3DV4 - SN3857; ConvF(5.39, 5.39, 5.39); Calibrated: 2017.5.26;
- Sensor-Surface: 1.4mm (Mechanical Surface Detection)
- Electronics: DAE4 Sn1210; Calibrated: 2017.5.25
- Phantom: SAM2; Type: SAM; Serial: TP-1644
- Measurement SW: DASY52, Version 52.8 (8); SEMCAD X Version 14.6.10 (7331)

Pin=100mW/Area Scan (71x71x1): Interpolated grid: dx=1.000 mm, dy=1.000 mm
Maximum value of SAR (interpolated) = 18.7 W/kg

Pin=100mW/Zoom Scan (8x8x7)/Cube 0: Measurement grid: dx=4mm, dy=4mm, dz=1.4mm
Reference Value = 40.12 V/m; Power Drift = 0.19 dB
Peak SAR (extrapolated) = 31.7 W/kg
SAR(1 g) = 7.68 W/kg; SAR(10 g) = 2.18 W/kg
Maximum value of SAR (measured) = 18.1 W/kg

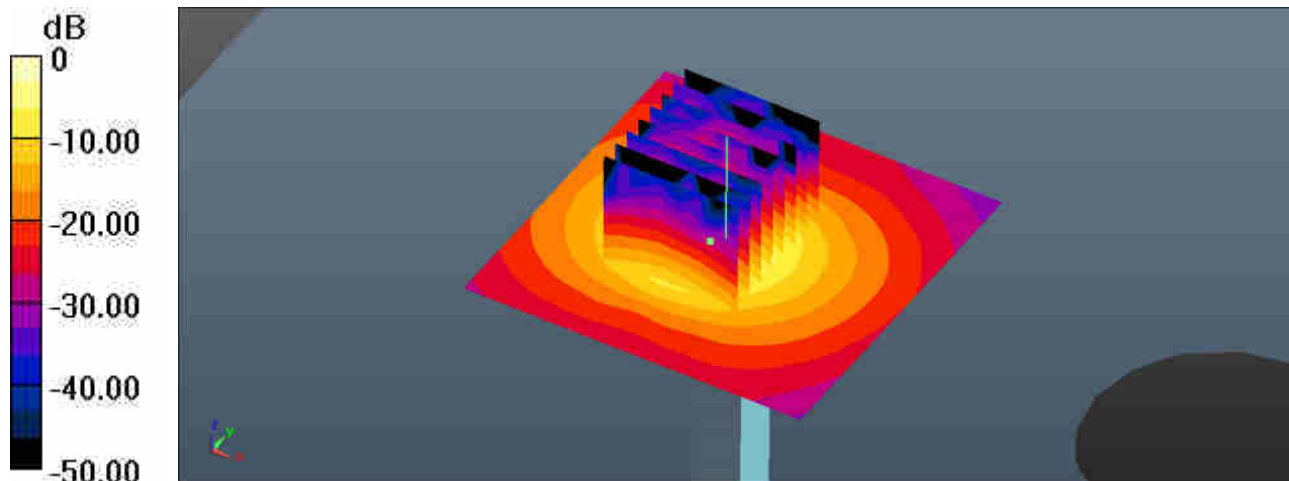

0 dB = 18.1 W/kg = 12.58 dBW/kg

System Check_Head_5600MHz

DUT: D5GHzV2-SN:1113

Communication System: UID 0, CW (0); Frequency: 5600 MHz; Duty Cycle: 1:1

Medium: HSL_5000 Medium parameters used: $f = 5600$ MHz; $\sigma = 5.039$ S/m; $\epsilon_r = 35.963$; $\rho = 1000$ kg/m³

Ambient Temperature : 23.4 °C ; Liquid Temperature : 22.9 °C

DASY5 Configuration:

- Probe: EX3DV4 - SN3857; ConvF(5.04, 5.04, 5.04); Calibrated: 2017.5.26;
- Sensor-Surface: 1.4mm (Mechanical Surface Detection)
- Electronics: DAE4 Sn1210; Calibrated: 2017.5.25
- Phantom: SAM2; Type: SAM; Serial: TP-1644
- Measurement SW: DASY52, Version 52.8 (8); SEMCAD X Version 14.6.10 (7331)

Pin=100mW/Area Scan (71x71x1): Interpolated grid: dx=1.000 mm, dy=1.000 mm

Maximum value of SAR (interpolated) = 19.3 W/kg

Pin=100mW/Zoom Scan (8x8x7)/Cube 0: Measurement grid: dx=4mm, dy=4mm, dz=1.4mm

Reference Value = 38.54 V/m; Power Drift = 0.11 dB

Peak SAR (extrapolated) = 33.6 W/kg

SAR(1 g) = 7.78 W/kg; SAR(10 g) = 2.2 W/kg

Maximum value of SAR (measured) = 18.8 W/kg

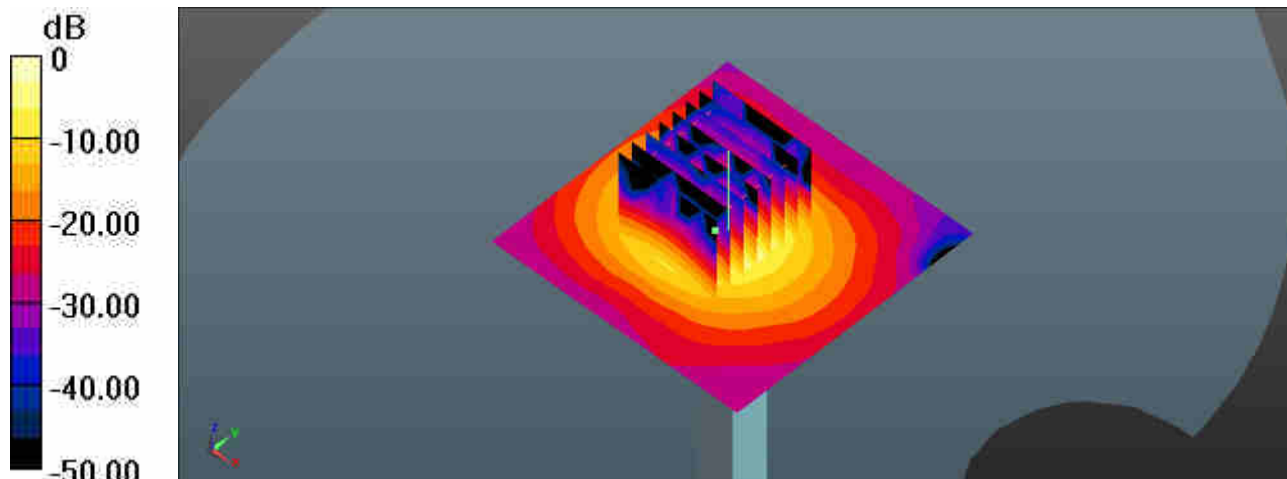

0 dB = 18.8 W/kg = 12.74 dBW/kg

System Check_Head_5750MHz

DUT: D5GHzV2-SN:1113

Communication System: UID 0, CW (0); Frequency: 5750 MHz; Duty Cycle: 1:1

Medium: HSL_5000 Medium parameters used: $f = 5750$ MHz; $\sigma = 5.221$ S/m; $\epsilon_r = 35.639$; $\rho = 1000$ kg/m³

Ambient Temperature : 23.4 °C ; Liquid Temperature : 22.9 °C

DASY5 Configuration:

- Probe: EX3DV4 - SN3857; ConvF(5.34, 5.34, 5.34); Calibrated: 2017.5.26;
- Sensor-Surface: 1.4mm (Mechanical Surface Detection)
- Electronics: DAE4 Sn1210; Calibrated: 2017.5.25
- Phantom: SAM2; Type: SAM; Serial: TP-1644
- Measurement SW: DASY52, Version 52.8 (8); SEMCAD X Version 14.6.10 (7331)

Pin=100mW/Area Scan (71x71x1): Interpolated grid: dx=1.000 mm, dy=1.000 mm

Maximum value of SAR (interpolated) = 17.8 W/kg

Pin=100mW/Zoom Scan (8x8x7)/Cube 0: Measurement grid: dx=4mm, dy=4mm, dz=1.4mm

Reference Value = 37.02 V/m; Power Drift = 0.18 dB

Peak SAR (extrapolated) = 32.8 W/kg

SAR(1 g) = 7.71 W/kg; SAR(10 g) = 2.19 W/kg

Maximum value of SAR (measured) = 17.8 W/kg

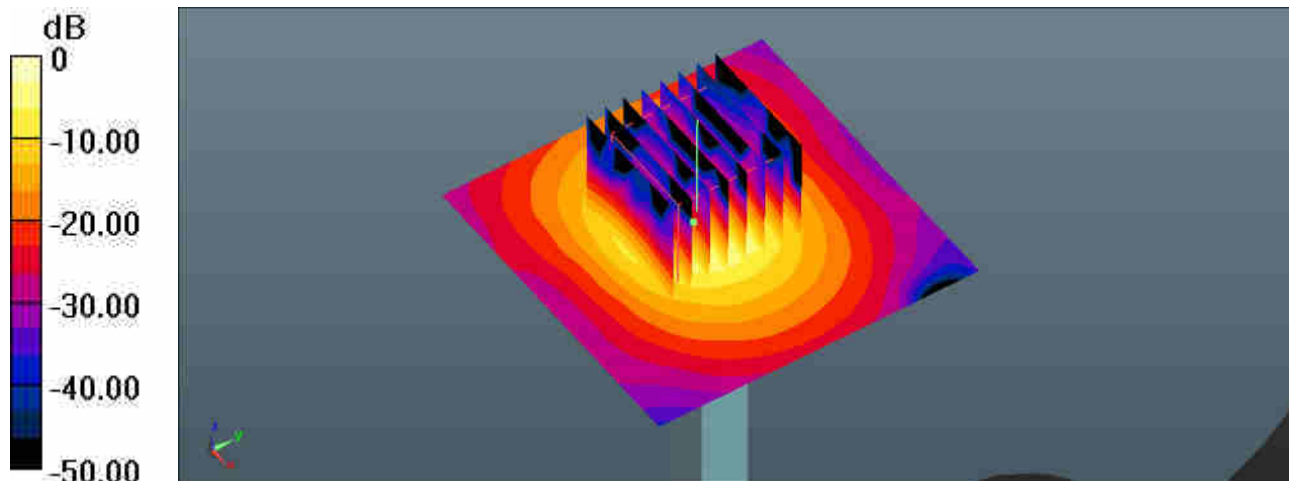

0 dB = 17.8 W/kg = 12.50 dBW/kg

System Check_Body_835MHz

DUT: D835V2 - SN:4d091

Communication System: UID 0, CW (0); Frequency: 835 MHz; Duty Cycle: 1:1

Medium: MSL_850 Medium parameters used: $f = 835$ MHz; $\sigma = 0.977$ S/m; $\epsilon_r = 55.111$; $\rho = 1000$ kg/m³

Ambient Temperature : 23.3 °C ; Liquid Temperature : 22.8 °C

DASY5 Configuration:

- Probe: EX3DV4 - SN3857; ConvF(9.72, 9.72, 9.72); Calibrated: 2017.5.26;
- Sensor-Surface: 2mm (Mechanical Surface Detection)
- Electronics: DAE4 Sn1210; Calibrated: 2017.5.25
- Phantom: SAM1; Type: SAM; Serial: TP-1164
- Measurement SW: DASY52, Version 52.8 (8); SEMCAD X Version 14.6.10 (7331)

Pin=250mW/Area Scan (61x61x1): Interpolated grid: dx=1.500 mm, dy=1.500 mm

Maximum value of SAR (interpolated) = 3.13 W/kg

Pin=250mW/Zoom Scan (5x5x7)/Cube 0: Measurement grid: dx=8mm, dy=8mm, dz=5mm

Reference Value = 52.23 V/m; Power Drift = -0.04 dB

Peak SAR (extrapolated) = 3.67 W/kg

SAR(1 g) = 2.49 W/kg; SAR(10 g) = 1.65 W/kg

Maximum value of SAR (measured) = 3.14 W/kg

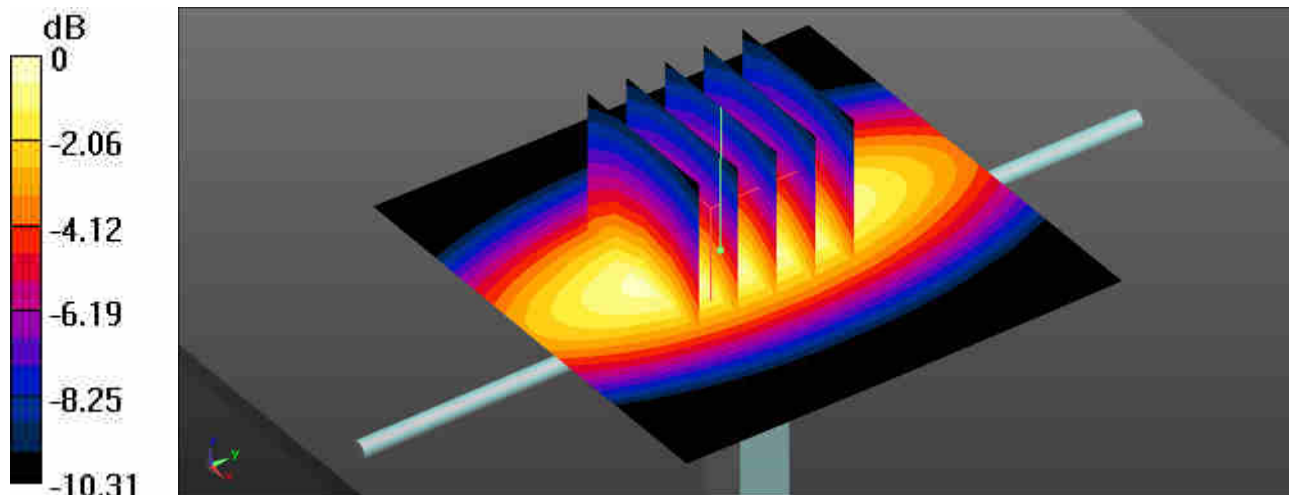

0 dB = 3.14 W/kg = 4.97 dBW/kg

System Check_Body_1750MHz

DUT: D1750V2 - SN:1069

Communication System: UID 0, CW (0); Frequency: 1750 MHz; Duty Cycle: 1:1
Medium: MSL_1750 Medium parameters used: $f = 1750$ MHz; $\sigma = 1.46$ S/m; $\epsilon_r = 53.9$; $\rho = 1000$ kg/m³
Ambient Temperature : 23.3 °C ; Liquid Temperature : 22.7 °C

DASY5 Configuration:

- Probe: EX3DV4 - SN3857; ConvF(8.29, 8.29, 8.29); Calibrated: 2017.5.26;
- Sensor-Surface: 2mm (Mechanical Surface Detection)
- Electronics: DAE4 Sn1210; Calibrated: 2017.5.25
- Phantom: SAM1; Type: SAM; Serial: TP-1164
- Measurement SW: DASY52, Version 52.8 (8); SEMCAD X Version 14.6.10 (7331)

Pin=250mW/Area Scan (61x61x1): Interpolated grid: dx=1.500 mm, dy=1.500 mm
Maximum value of SAR (interpolated) = 13.0 W/kg

Pin=250mW/Zoom Scan (5x5x7)/Cube 0: Measurement grid: dx=8mm, dy=8mm, dz=5mm
Reference Value = 82.22 V/m; Power Drift = 0.09 dB
Peak SAR (extrapolated) = 15.9 W/kg
SAR(1 g) = 9.14 W/kg; SAR(10 g) = 4.94 W/kg
Maximum value of SAR (measured) = 12.8 W/kg

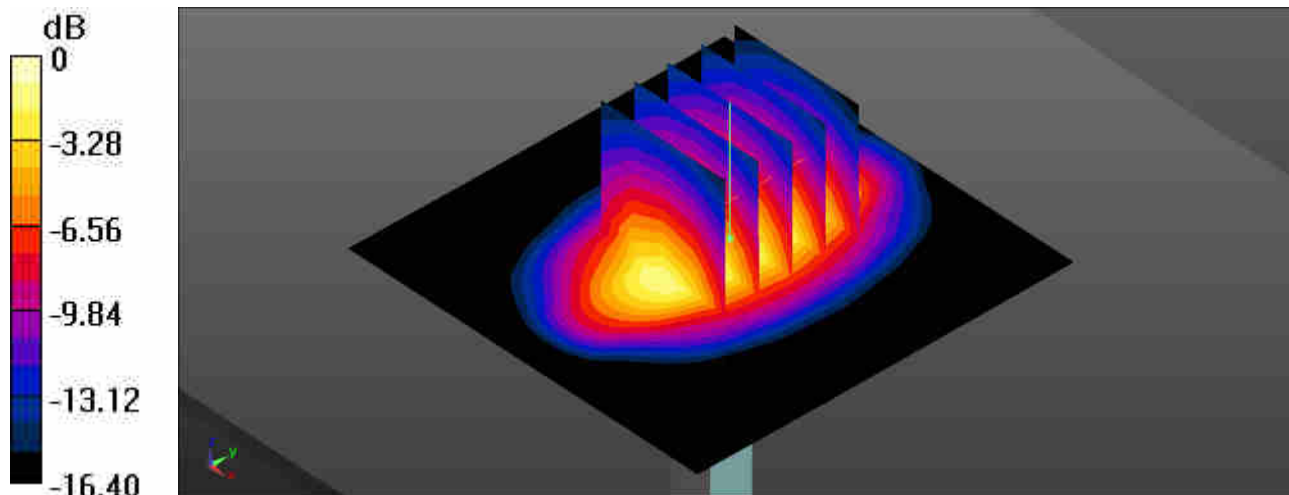

0 dB = 12.8 W/kg = 11.07 dBW/kg

System Check_Body_1900MHz

DUT: D1900V2 - SN:5d118

Communication System: UID 0, CW (0); Frequency: 1900 MHz; Duty Cycle: 1:1
Medium: MSL_1900 Medium parameters used: $f = 1900$ MHz; $\sigma = 1.556$ S/m; $\epsilon_r = 53.612$; $\rho = 1000$ kg/m³
Ambient Temperature : 23.3 °C ; Liquid Temperature : 22.7 °C

DASY5 Configuration:

- Probe: EX3DV4 - SN3857; ConvF(8.08, 8.08, 8.08); Calibrated: 2017.5.26;
- Sensor-Surface: 2mm (Mechanical Surface Detection)
- Electronics: DAE4 Sn1210; Calibrated: 2017.5.25
- Phantom: SAM1; Type: SAM; Serial: TP-1164
- Measurement SW: DASY52, Version 52.8 (8); SEMCAD X Version 14.6.10 (7331)

Pin=250mW/Area Scan (61x61x1): Interpolated grid: dx=1.500 mm, dy=1.500 mm
Maximum value of SAR (interpolated) = 13.9 W/kg

Pin=250mW/Zoom Scan (5x5x7)/Cube 0: Measurement grid: dx=8mm, dy=8mm, dz=5mm
Reference Value = 83.90 V/m; Power Drift = 0.07 dB
Peak SAR (extrapolated) = 17.6 W/kg
SAR(1 g) = 9.79 W/kg; SAR(10 g) = 5.09 W/kg
Maximum value of SAR (measured) = 14.0 W/kg

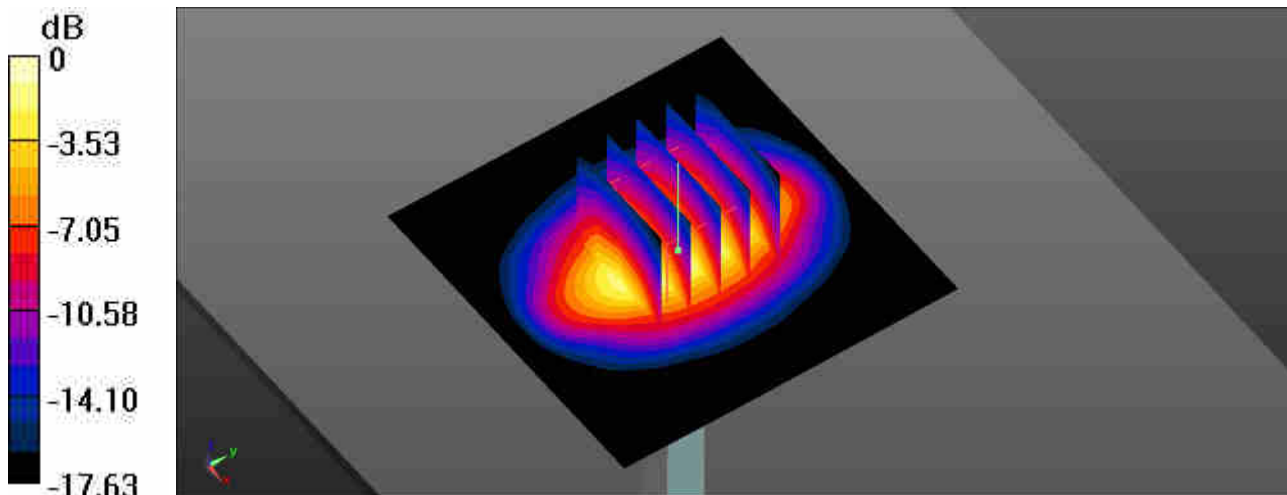

0 dB = 14.0 W/kg = 11.46 dBW/kg

System Check_Body_2450MHz

DUT: D2450V2 - SN:840

Communication System: UID 0, CW; Frequency: 2450 MHz; Duty Cycle: 1:1

Medium: MSL_2450 Medium parameters used: $f = 2450$ MHz; $\sigma = 1.961$ S/m; $\epsilon_r = 52.567$; $\rho = 1000$ kg/m³

Ambient Temperature : 23.5 °C ; Liquid Temperature : 22.5 °C

DASY5 Configuration:

- Probe: EX3DV4 - SN3857; ConvF(7.7, 7.7, 7.7); Calibrated: 2017.5.26;
- Sensor-Surface: 2mm (Mechanical Surface Detection)
- Electronics: DAE4 Sn1210; Calibrated: 2017.5.25
- Phantom: SAM1; Type: SAM; Serial: TP-1164
- Measurement SW: DASY52, Version 52.8 (8); SEMCAD X Version 14.6.10 (7331)

Pin=250mW/Area Scan (81x81x1): Interpolated grid: dx=1.200 mm, dy=1.200 mm

Maximum value of SAR (interpolated) = 18.7 W/kg

Pin=250mW/Zoom Scan (7x7x7)/Cube 0: Measurement grid: dx=5mm, dy=5mm, dz=5mm

Reference Value = 80.90 V/m; Power Drift = -0.16 dB

Peak SAR (extrapolated) = 25.5 W/kg

SAR(1 g) = 12.6 W/kg; SAR(10 g) = 5.9 W/kg

Maximum value of SAR (measured) = 19.2 W/kg

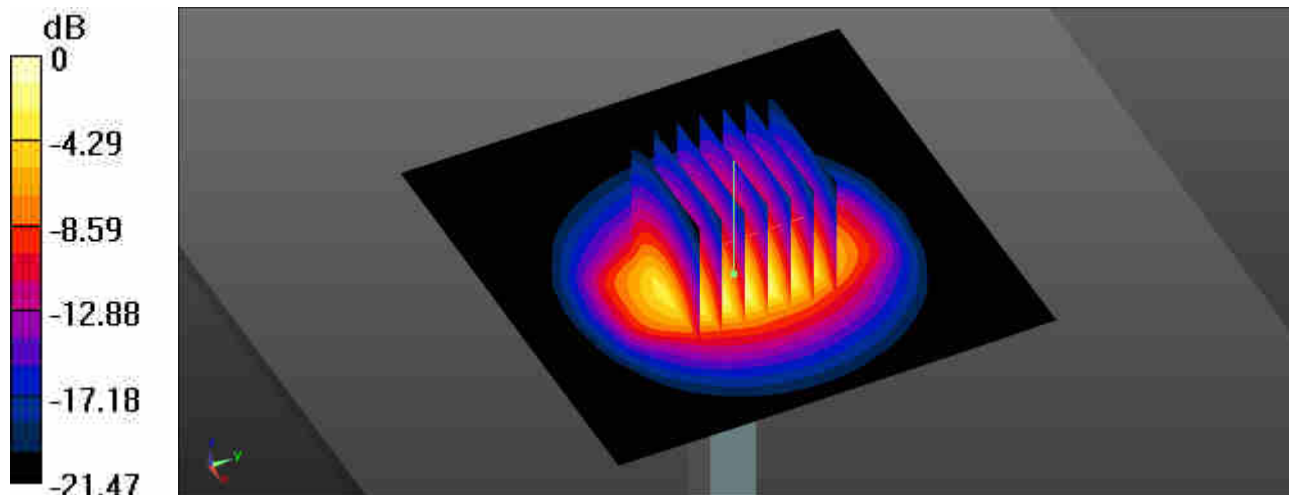

0 dB = 19.2 W/kg = 12.83 dBW/kg

System Check_Body_2600MHz

DUT: D2450V2 - SN:1061

Communication System: UID 0, CW (0); Frequency: 2600 MHz; Duty Cycle: 1:1

Medium: MSL_2600 Medium parameters used: $f = 2600$ MHz; $\sigma = 2.166$ S/m; $\epsilon_r = 52.048$; $\rho = 1000$ kg/m³

Ambient Temperature : 23.2 °C ; Liquid Temperature : 22.7 °C

DASY5 Configuration:

- Probe: EX3DV4 - SN3857; ConvF(7.59, 7.59, 7.59); Calibrated: 2017.5.26;
- Sensor-Surface: 2mm (Mechanical Surface Detection)
- Electronics: DAE4 Sn1210; Calibrated: 2017.5.25
- Phantom: SAM1; Type: SAM; Serial: TP-1164
- Measurement SW: DASY52, Version 52.8 (8); SEMCAD X Version 14.6.10 (7331)

Pin=250mW/Area Scan (81x81x1): Interpolated grid: dx=1.200 mm, dy=1.200 mm

Maximum value of SAR (interpolated) = 16.1 W/kg

Pin=250mW/Zoom Scan (7x7x7)/Cube 0: Measurement grid: dx=5mm, dy=5mm, dz=5mm

Reference Value = 78.38 V/m; Power Drift = -0.08 dB

Peak SAR (extrapolated) = 22.3 W/kg

SAR(1 g) = 13.3 W/kg; SAR(10 g) = 6.18 W/kg

Maximum value of SAR (measured) = 17.7 W/kg

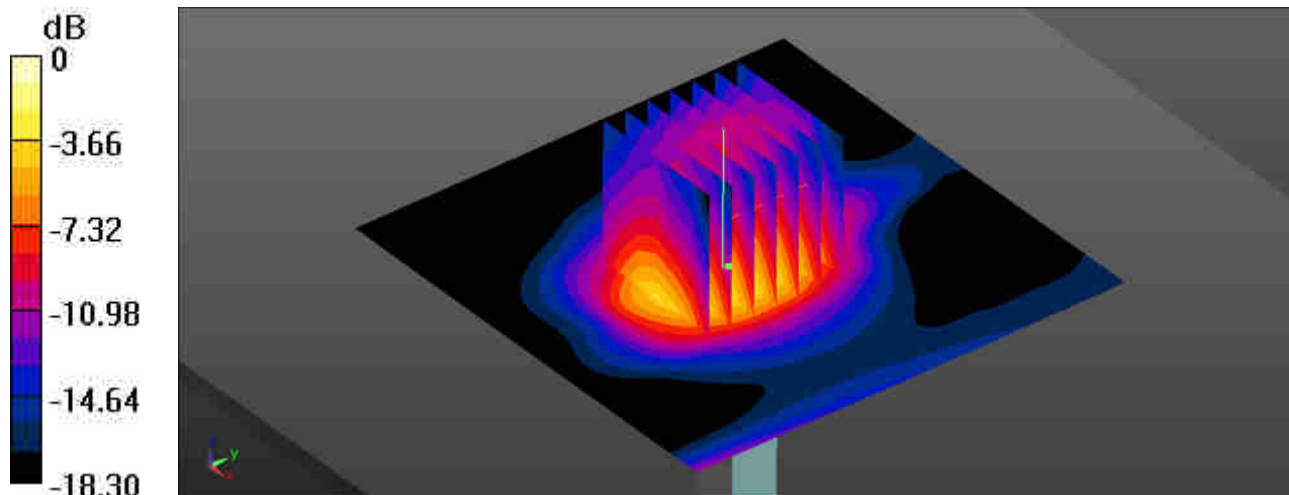

0 dB = 17.7 W/kg = 12.48 dBW/kg

System Check_Body_5250MHz

DUT: D5GHzV2-SN:1113

Communication System: UID 0, CW (0); Frequency: 5250 MHz; Duty Cycle: 1:1
Medium: MSL_5000 Medium parameters used: $f = 5250$ MHz; $\sigma = 5.382$ S/m; $\epsilon_r = 47.699$; $\rho = 1000$ kg/m³
Ambient Temperature : 23.6 °C ; Liquid Temperature : 22.7 °C

DASY5 Configuration:

- Probe: EX3DV4 - SN3857; ConvF(4.72, 4.72, 4.72); Calibrated: 2017.5.26;
- Sensor-Surface: 1.4mm (Mechanical Surface Detection)
- Electronics: DAE4 Sn1210; Calibrated: 2017.5.25
- Phantom: SAM1; Type: SAM; Serial: TP-1164
- Measurement SW: DASY52, Version 52.8 (8); SEMCAD X Version 14.6.10 (7331)

CW/Area Scan (71x71x1): Interpolated grid: dx=1.000 mm, dy=1.000 mm
Maximum value of SAR (interpolated) = 16.2 W/kg

CW/Zoom Scan (8x8x7)/Cube 0: Measurement grid: dx=4mm, dy=4mm, dz=1.4mm
Reference Value = 37.87 V/m; Power Drift = 0.03 dB
Peak SAR (extrapolated) = 26.9 W/kg
SAR(1 g) = 7.11 W/kg; SAR(10 g) = 2.11 W/kg
Maximum value of SAR (measured) = 15.9 W/kg

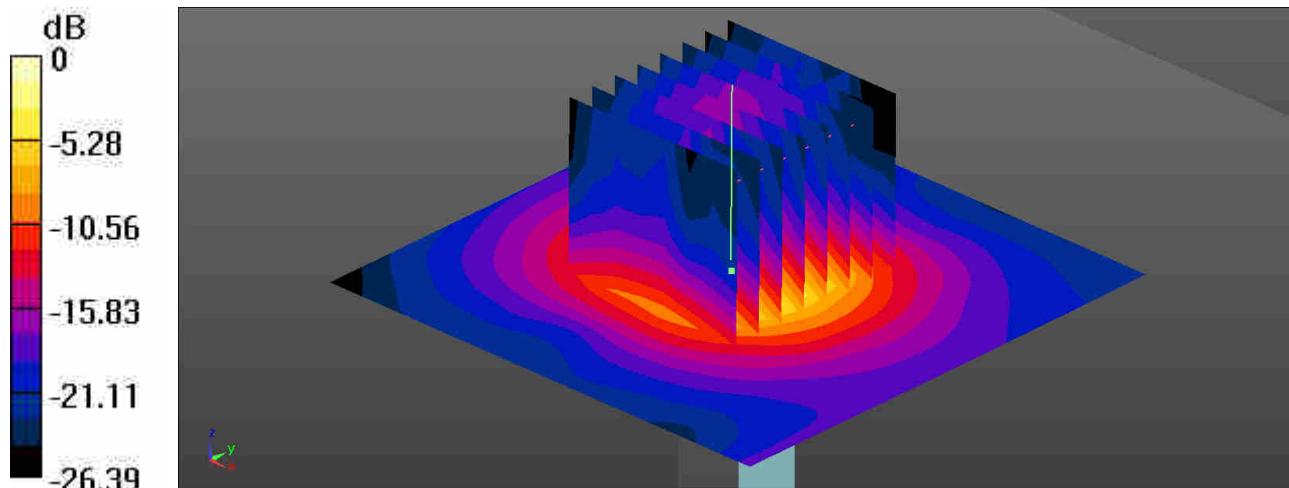

0 dB = 15.9 W/kg = 12.01 dBW/kg

System Check_Body_5600MHz

DUT: D5GHzV2-SN:1113

Communication System: UID 0, CW (0); Frequency: 5600 MHz; Duty Cycle: 1:1
Medium: MSL_5000 Medium parameters used: $f = 5600$ MHz; $\sigma = 5.888$ S/m; $\epsilon_r = 46.875$; $\rho = 1000$ kg/m³
Ambient Temperature : 23.5 °C ; Liquid Temperature : 22.6 °C

DASY5 Configuration:

- Probe: EX3DV4 - SN3857; ConvF(4.01, 4.01, 4.01); Calibrated: 2017.5.26;
- Sensor-Surface: 1.4mm (Mechanical Surface Detection)
- Electronics: DAE4 Sn1210; Calibrated: 2017.5.25
- Phantom: SAM1; Type: SAM; Serial: TP-1164
- Measurement SW: DASY52, Version 52.8 (8); SEMCAD X Version 14.6.10 (7331)

CW/Area Scan (71x71x1): Interpolated grid: dx=1.000 mm, dy=1.000 mm
Maximum value of SAR (interpolated) = 18.8 W/kg

CW/Zoom Scan (8x8x7)/Cube 0: Measurement grid: dx=4mm, dy=4mm, dz=1.4mm
Reference Value = 40.38 V/m; Power Drift = 0.03 dB
Peak SAR (extrapolated) = 31.8 W/kg
SAR(1 g) = 7.57 W/kg; SAR(10 g) = 2.21 W/kg
Maximum value of SAR (measured) = 19.2 W/kg

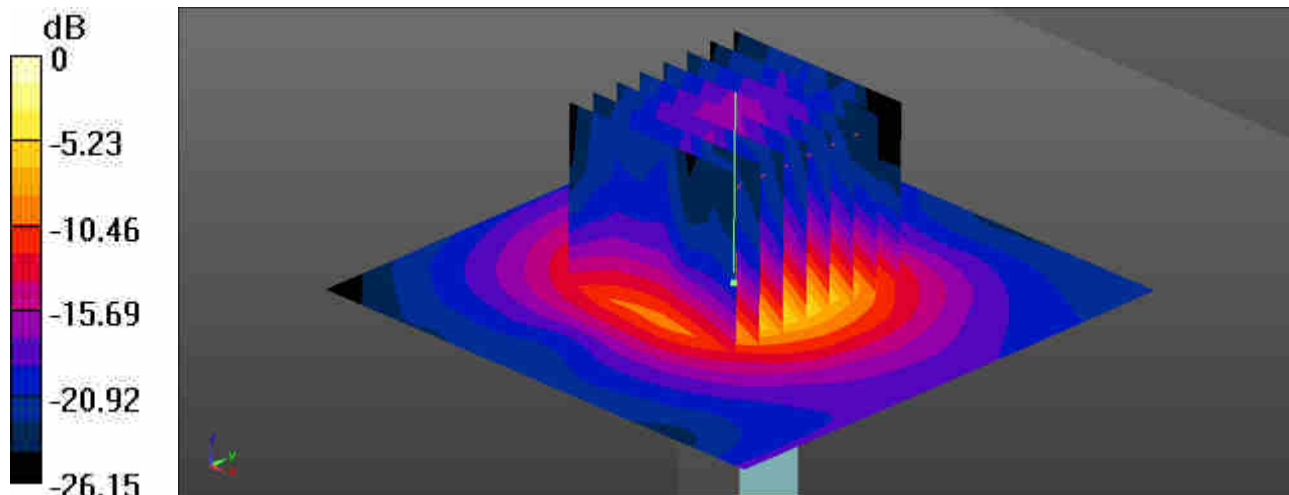

0 dB = 19.2 W/kg = 12.83 dBW/kg

System Check_Body_5750MHz

DUT: D5GHzV2-SN:1113

Communication System: UID 0, CW (0); Frequency: 5750 MHz; Duty Cycle: 1:1
Medium: MSL_5000 Medium parameters used: $f = 5750$ MHz; $\sigma = 5.901$ S/m; $\epsilon_r = 46.562$; $\rho = 1000$ kg/m³
Ambient Temperature : 23.6 °C ; Liquid Temperature : 22.7 °C

DASY5 Configuration:

- Probe: EX3DV4 - SN3857; ConvF(4.31, 4.31, 4.31); Calibrated: 2017.5.26;
- Sensor-Surface: 1.4mm (Mechanical Surface Detection)
- Electronics: DAE4 Sn1210; Calibrated: 2017.5.25
- Phantom: SAM1; Type: SAM; Serial: TP-1164
- Measurement SW: DASY52, Version 52.8 (8); SEMCAD X Version 14.6.10 (7331)

CW/Area Scan (71x71x1): Interpolated grid: dx=1.000 mm, dy=1.000 mm
Maximum value of SAR (interpolated) = 16.8 W/kg

CW/Zoom Scan (8x8x7)/Cube 0: Measurement grid: dx=4mm, dy=4mm, dz=1.4mm
Reference Value = 35.37 V/m; Power Drift = 0.03 dB
Peak SAR (extrapolated) = 27.9 W/kg
SAR(1 g) = 7.21 W/kg; SAR(10 g) = 2.06 W/kg
Maximum value of SAR (measured) = 16.6 W/kg

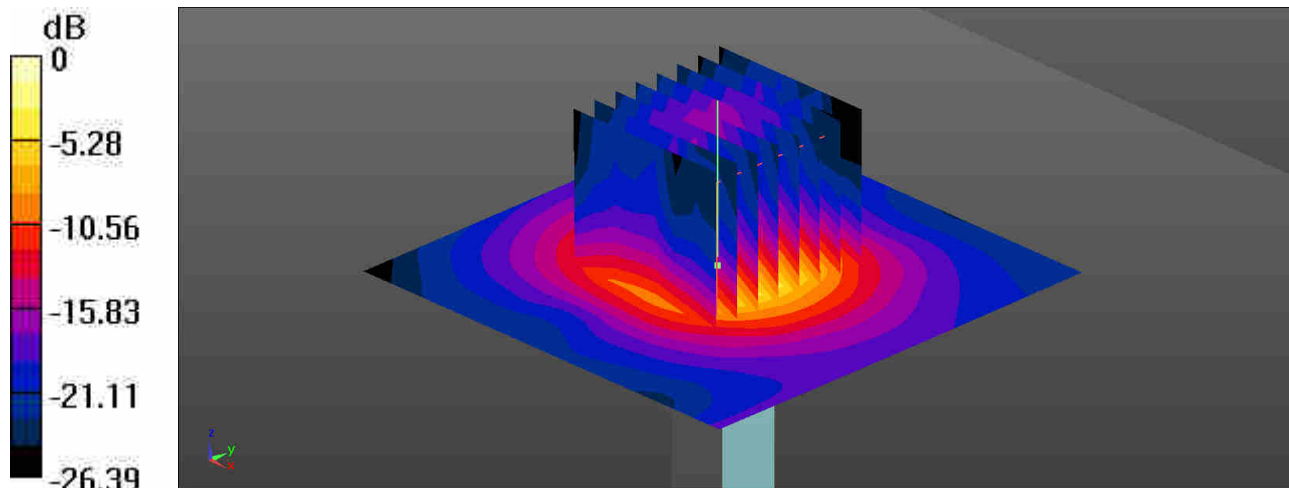

0 dB = 16.6 W/kg = 12.20 dBW/kg



Appendix B. Plots of High SAR Measurement

The plots are shown as follows.

01_GSM850_GPRS 4 Tx slots_Right Cheek_0mm_Ch189

Communication System: UID 0, GPRS/EDGE (4 Tx slots) (0); Frequency: 836.4 MHz; Duty Cycle: 1:2.08
Medium: HSL_850 Medium parameters used: $f = 836.4$ MHz; $\sigma = 0.91$ S/m; $\epsilon_r = 42.362$; $\rho = 1000$ kg/m³
Ambient Temperature : 23.5 °C ; Liquid Temperature : 22.8 °C

DASY5 Configuration:

- Probe: EX3DV4 - SN3857; ConvF(9.73, 9.73, 9.73); Calibrated: 2017.5.26;
- Sensor-Surface: 2mm (Mechanical Surface Detection)
- Electronics: DAE4 Sn1210; Calibrated: 2017.5.25
- Phantom: SAM2; Type: SAM; Serial: TP-1644
- Measurement SW: DASY52, Version 52.8 (8); SEMCAD X Version 14.6.10 (7331)

Ch189/Area Scan (71x121x1): Interpolated grid: dx=1.500 mm, dy=1.500 mm
Maximum value of SAR (interpolated) = 0.201 W/kg

Ch189/Zoom Scan (5x5x7)/Cube 0: Measurement grid: dx=8mm, dy=8mm, dz=5mm
Reference Value = 5.089 V/m; Power Drift = 0.01 dB
Peak SAR (extrapolated) = 0.236 W/kg
SAR(1 g) = 0.191 W/kg; SAR(10 g) = 0.146 W/kg
Maximum value of SAR (measured) = 0.216 W/kg

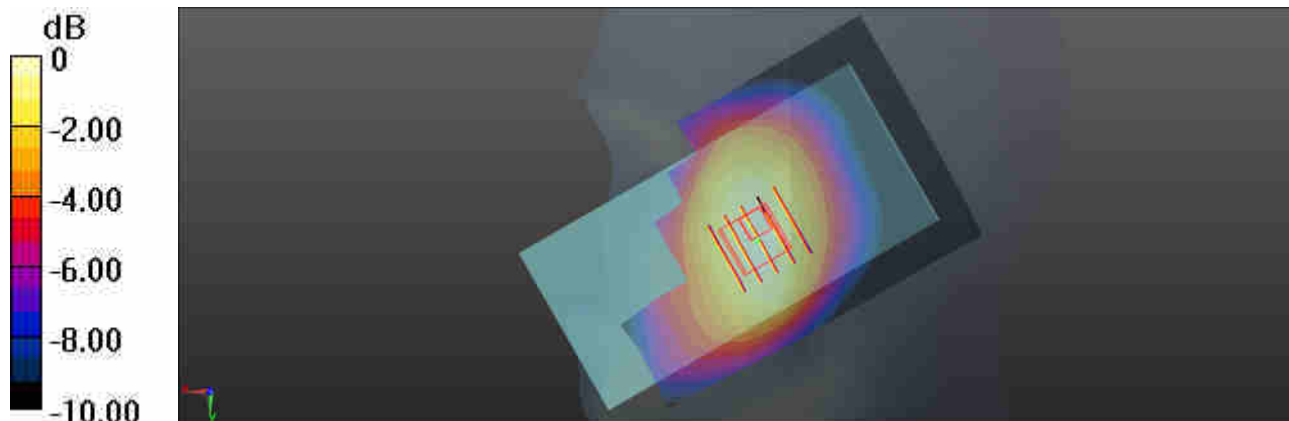

0 dB = 0.216 W/kg = -6.66 dBW/kg

02_GSM1900_GPRS 1 Tx slot_Right Cheek_0mm_Ch810

Communication System: UID 0, General GSM (0); Frequency: 1909.8 MHz; Duty Cycle: 1:8.3
Medium: HSL_1900 Medium parameters used: $f = 1909.8$ MHz; $\sigma = 1.395$ S/m; $\epsilon_r = 39.283$;

$\rho = 1000$ kg/m³

Ambient Temperature : 23.4 °C ; Liquid Temperature : 22.7 °C

DASY5 Configuration:

- Probe: EX3DV4 - SN3857; ConvF(8.29, 8.29, 8.29); Calibrated: 2017.5.26;
- Sensor-Surface: 2mm (Mechanical Surface Detection)
- Electronics: DAE4 Sn1210; Calibrated: 2017.5.25
- Phantom: SAM2; Type: SAM; Serial: TP-1644
- Measurement SW: DASY52, Version 52.8 (8); SEMCAD X Version 14.6.10 (7331)

Ch810/Area Scan (71x121x1): Interpolated grid: dx=1.500 mm, dy=1.500 mm

Maximum value of SAR (interpolated) = 0.191 W/kg

Ch810/Zoom Scan (5x5x7)/Cube 0: Measurement grid: dx=8mm, dy=8mm, dz=5mm

Reference Value = 3.373 V/m; Power Drift = 0.13 dB

Peak SAR (extrapolated) = 0.219 W/kg

SAR(1 g) = 0.142 W/kg; SAR(10 g) = 0.088 W/kg

Maximum value of SAR (measured) = 0.178 W/kg

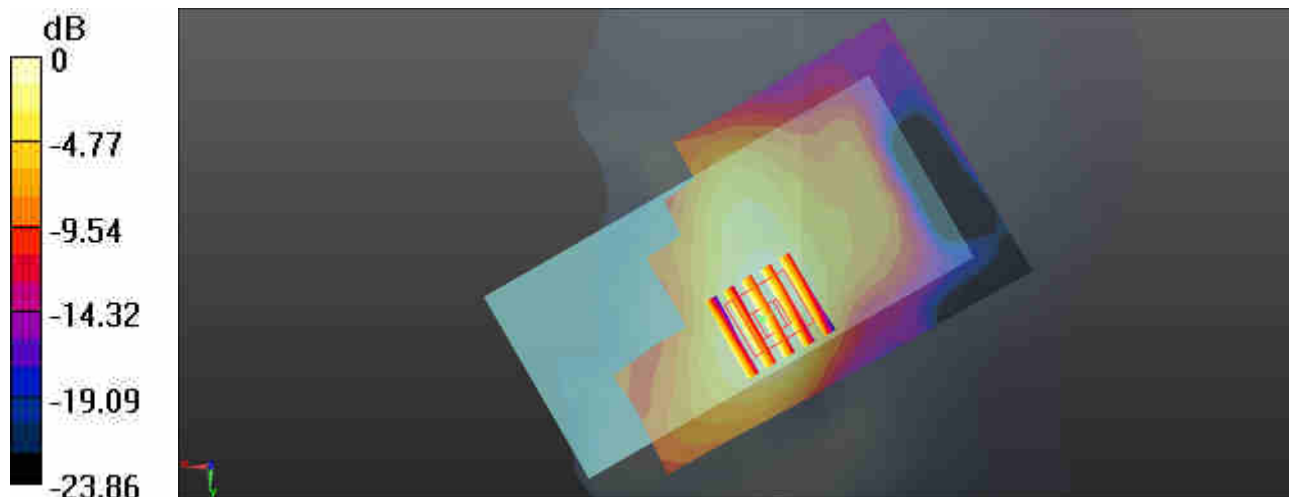

03_WCDMA Band V_RMC 12.2Kbps_Left Cheek_Ch4233

Communication System: UID 0, UMTS (0); Frequency: 846.6 MHz; Duty Cycle: 1:1
Medium: HSL_850 Medium parameters used: $f = 846.6$ MHz; $\sigma = 0.92$ S/m; $\epsilon_r = 42.234$;
 $\rho = 1000$ kg/m³
Ambient Temperature : 23.5 °C ; Liquid Temperature : 22.8 °C

DASY5 Configuration:

- Probe: EX3DV4 - SN3857; ConvF(9.73, 9.73, 9.73); Calibrated: 2017.5.26;
- Sensor-Surface: 2mm (Mechanical Surface Detection)
- Electronics: DAE4 Sn1210; Calibrated: 2017.5.25
- Phantom: SAM2; Type: SAM; Serial: TP-1644
- Measurement SW: DASY52, Version 52.8 (8); SEMCAD X Version 14.6.10 (7331)

Ch4233/Area Scan (71x121x1): Interpolated grid: dx=1.500 mm, dy=1.500 mm
Maximum value of SAR (interpolated) = 0.254 W/kg

Ch4233/Zoom Scan (5x5x7)/Cube 0: Measurement grid: dx=8mm, dy=8mm, dz=5mm
Reference Value = 5.680 V/m; Power Drift = 0.14 dB
Peak SAR (extrapolated) = 0.278 W/kg
SAR(1 g) = 0.222 W/kg; SAR(10 g) = 0.167 W/kg
Maximum value of SAR (measured) = 0.251 W/kg

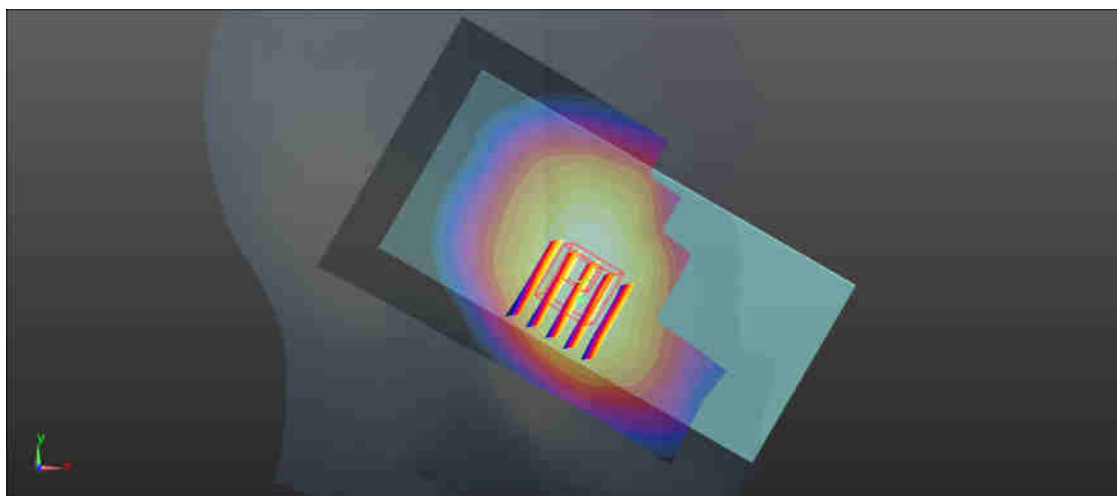
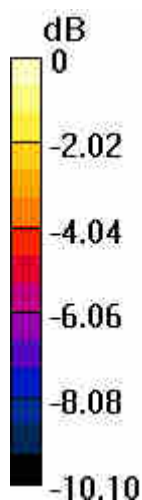

0 dB = 0.251 W/kg = -6.00 dBW/kg

04_WCDMA Band II_RMC 12.2Kbps_Right Cheek_0mm_Ch9262

Communication System: UID 0, UMTS (0); Frequency: 1852.4 MHz; Duty Cycle: 1:1
Medium: HSL_1900 Medium parameters used: $f = 1852.4$ MHz; $\sigma = 1.336$ S/m; $\epsilon_r = 39.556$;

$\rho = 1000$ kg/m³

Ambient Temperature : 23.4 °C ; Liquid Temperature : 22.7 °C

DASY5 Configuration:

- Probe: EX3DV4 - SN3857; ConvF(8.29, 8.29, 8.29); Calibrated: 2017.5.26;
- Sensor-Surface: 2mm (Mechanical Surface Detection)
- Electronics: DAE4 Sn1210; Calibrated: 2017.5.25
- Phantom: SAM2; Type: SAM; Serial: TP-1644
- Measurement SW: DASY52, Version 52.8 (8); SEMCAD X Version 14.6.10 (7331)

Ch9262/Area Scan (71x121x1): Interpolated grid: dx=1.500 mm, dy=1.500 mm

Maximum value of SAR (interpolated) = 0.336 W/kg

Ch9262/Zoom Scan (5x5x7)/Cube 0: Measurement grid: dx=8mm, dy=8mm, dz=5mm

Reference Value = 4.040 V/m; Power Drift = 0.13 dB

Peak SAR (extrapolated) = 0.378 W/kg

SAR(1 g) = 0.251 W/kg; SAR(10 g) = 0.157 W/kg

Maximum value of SAR (measured) = 0.315 W/kg

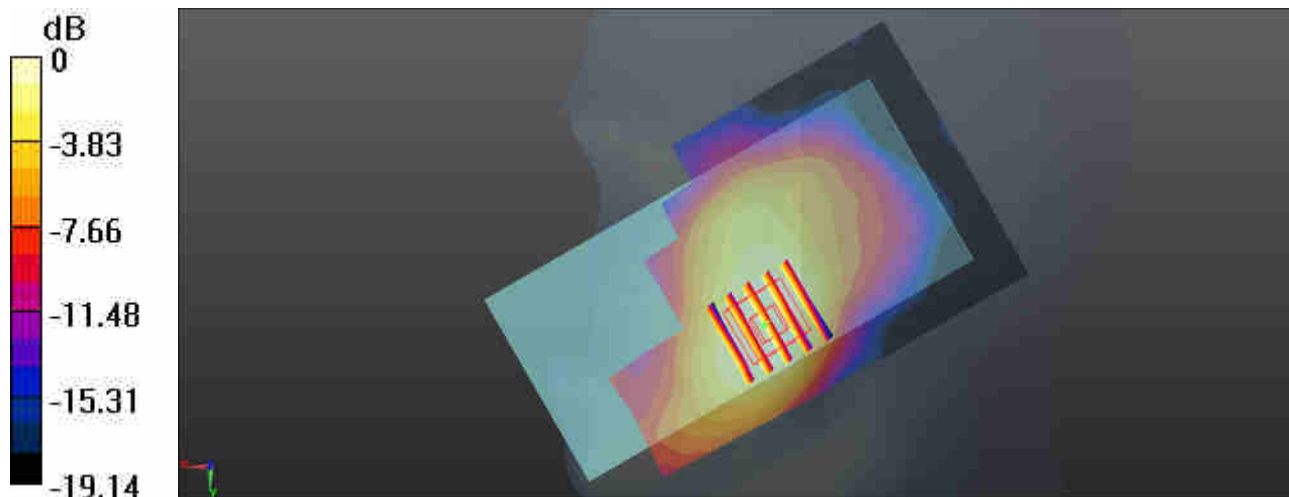

0 dB = 0.315 W/kg = -5.02 dBW/kg

05_LTE Band 5_10M_QPSK_1RB_25Offset_Left Cheek_Ch20525

Communication System: UID 0, FDD_LTE (0); Frequency: 836.5 MHz; Duty Cycle: 1:1
Medium: HSL_850 Medium parameters used: $f = 836.5$ MHz; $\sigma = 0.911$ S/m; $\epsilon_r = 42.361$;

$$\rho = 1000 \text{ kg/m}^3$$

Ambient Temperature : 23.5 °C ; Liquid Temperature : 22.8 °C

DASY5 Configuration:

- Probe: EX3DV4 - SN3857; ConvF(9.73, 9.73, 9.73); Calibrated: 2017.5.26;
- Sensor-Surface: 2mm (Mechanical Surface Detection)
- Electronics: DAE4 Sn1210; Calibrated: 2017.5.25
- Phantom: SAM2; Type: SAM; Serial: TP-1644
- Measurement SW: DASY52, Version 52.8 (8); SEMCAD X Version 14.6.10 (7331)

Ch20525/Area Scan (71x121x1): Interpolated grid: dx=1.500 mm, dy=1.500 mm

Maximum value of SAR (interpolated) = 0.183 W/kg

Ch20525/Zoom Scan (5x5x7)/Cube 0: Measurement grid: dx=8mm, dy=8mm, dz=5mm

Reference Value = 4.617 V/m; Power Drift = 0.18 dB

Peak SAR (extrapolated) = 0.193 W/kg

SAR(1 g) = 0.157 W/kg; SAR(10 g) = 0.119 W/kg

Maximum value of SAR (measured) = 0.179 W/kg

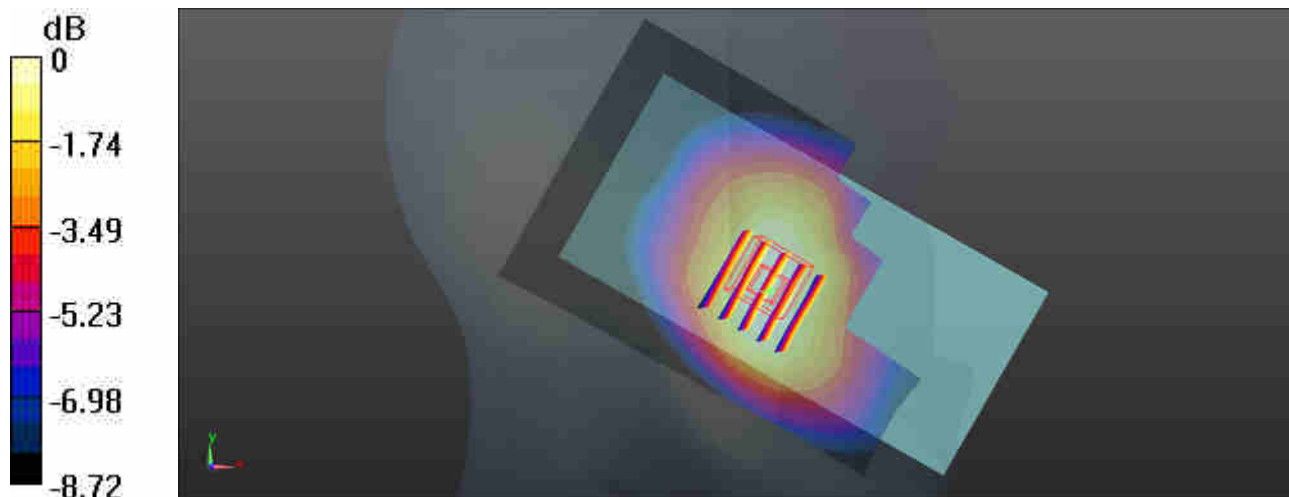

0 dB = 0.179 W/kg = -7.47 dBW/kg

06_LTE Band 4_20M_QPSK_1RB_49Offset_Right Cheek_0mm_Ch20175

Communication System: UID 0, FDD_LTE (0); Frequency: 1732.5 MHz; Duty Cycle: 1:1
Medium: HSL_1750 Medium parameters used: $f = 1732.5$ MHz; $\sigma = 1.344$ S/m; $\epsilon_r = 39.715$;

$\rho = 1000$ kg/m³

Ambient Temperature : 23.4 °C ; Liquid Temperature : 22.7 °C

DASY5 Configuration:

- Probe: EX3DV4 - SN3857; ConvF(8.47, 8.47, 8.47); Calibrated: 2017.5.26;
- Sensor-Surface: 2mm (Mechanical Surface Detection)
- Electronics: DAE4 Sn1210; Calibrated: 2017.5.25
- Phantom: SAM2; Type: SAM; Serial: TP-1644
- Measurement SW: DASY52, Version 52.8 (8); SEMCAD X Version 14.6.10 (7331)

Ch20175/Area Scan (71x121x1): Interpolated grid: dx=1.500 mm, dy=1.500 mm

Maximum value of SAR (interpolated) = 0.333 W/kg

Ch20175/Zoom Scan (5x5x7)/Cube 0: Measurement grid: dx=8mm, dy=8mm, dz=5mm

Reference Value = 4.131 V/m; Power Drift = -0.02 dB

Peak SAR (extrapolated) = 0.376 W/kg

SAR(1 g) = 0.256 W/kg; SAR(10 g) = 0.164 W/kg

Maximum value of SAR (measured) = 0.316 W/kg

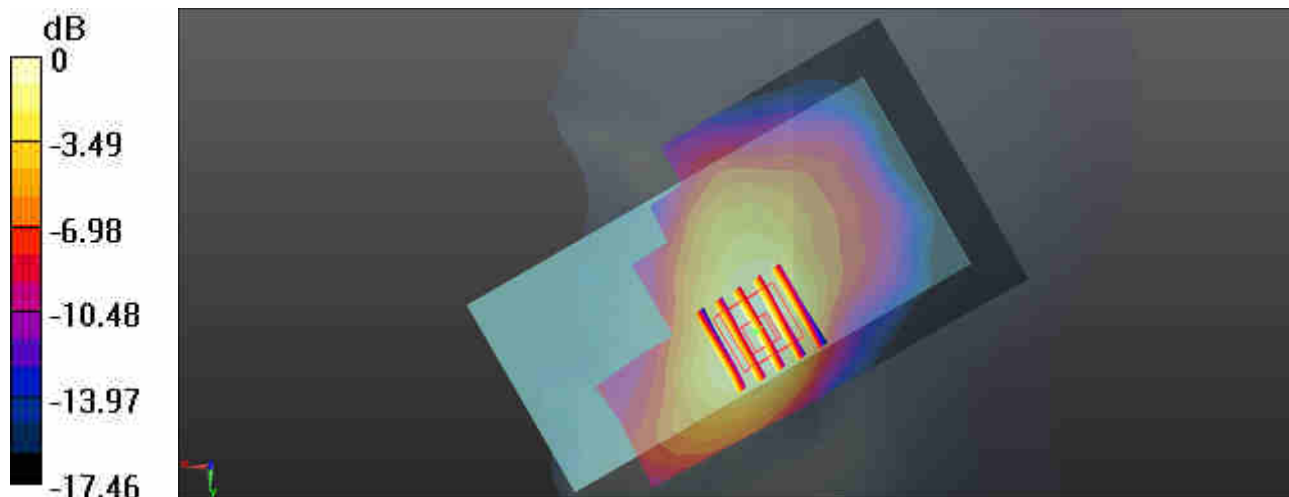

0 dB = 0.316 W/kg = -5.00 dBW/kg

07_LTE Band 7_20M_QPSK_1RB_49Offset_Right Cheek_0mm_Ch21350

Communication System: UID 0, FDD_LTE (0); Frequency: 2560 MHz; Duty Cycle: 1:1
Medium: HSL_2600 Medium parameters used: $f = 2560$ MHz; $\sigma = 2.001$ S/m; $\epsilon_r = 37.912$;

$$\rho = 1000 \text{ kg/m}^3$$

Ambient Temperature : 23.2 °C ; Liquid Temperature : 22.8 °C

DASY5 Configuration:

- Probe: EX3DV4 - SN3857; ConvF(7.62, 7.62, 7.62); Calibrated: 2017.5.26;
- Sensor-Surface: 2mm (Mechanical Surface Detection)
- Electronics: DAE4 Sn1210; Calibrated: 2017.5.25
- Phantom: SAM3; Type: SAM; Serial: TP-1542
- Measurement SW: DASY52, Version 52.8 (8); SEMCAD X Version 14.6.10 (7331)

Ch21350/Area Scan (81x151x1): Interpolated grid: dx=1.200 mm, dy=1.200 mm

Maximum value of SAR (interpolated) = 0.169 W/kg

Ch21350/Zoom Scan (7x7x7)/Cube 0: Measurement grid: dx=5mm, dy=5mm, dz=5mm

Reference Value = 1.165 V/m; Power Drift = 0.06 dB

Peak SAR (extrapolated) = 0.214 W/kg

SAR(1 g) = 0.110 W/kg; SAR(10 g) = 0.056 W/kg

Maximum value of SAR (measured) = 0.166 W/kg

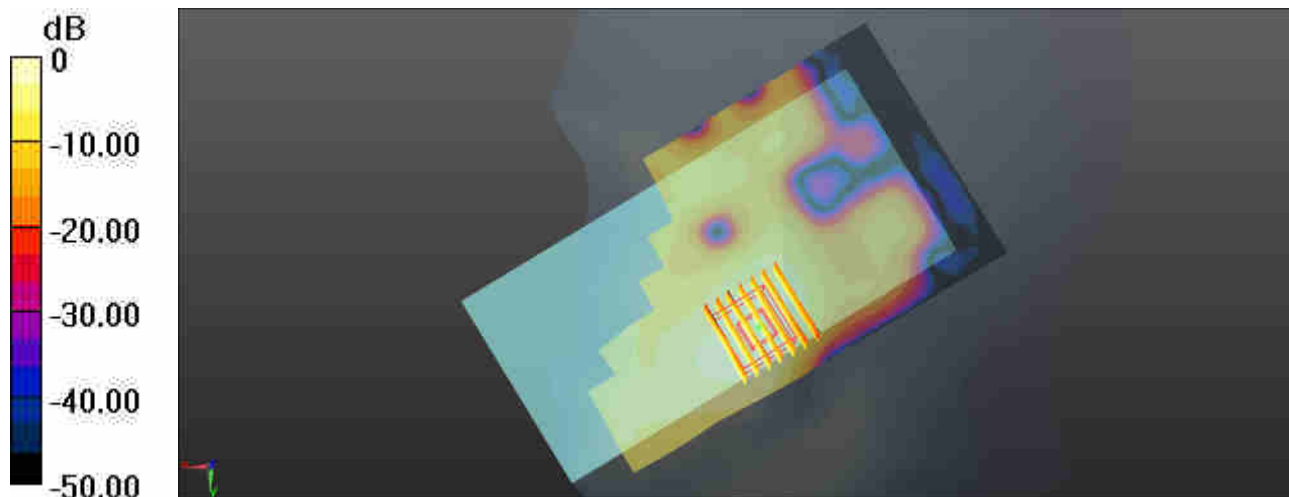

0 dB = 0.166 W/kg = -7.80 dBW/kg

08_LTE Band 38_20M_QPSK_1RB_49Offset_Right Cheek_0mm_Ch38000

Communication System: UID 0, TDD_LTE (0); Frequency: 2595 MHz; Duty Cycle: 1:1.59
Medium: HSL_2600 Medium parameters used: $f = 2595$ MHz; $\sigma = 2.044$ S/m; $\epsilon_r = 37.771$;

$\rho = 1000$ kg/m³

Ambient Temperature : 23.2 °C ; Liquid Temperature : 22.8 °C

DASY5 Configuration:

- Probe: EX3DV4 - SN3857; ConvF(7.62, 7.62, 7.62); Calibrated: 2017.5.26;
- Sensor-Surface: 2mm (Mechanical Surface Detection)
- Electronics: DAE4 Sn1210; Calibrated: 2017.5.25
- Phantom: SAM3; Type: SAM; Serial: TP-1542
- Measurement SW: DASY52, Version 52.8 (8); SEMCAD X Version 14.6.10 (7331)

Ch38000/Area Scan (81x151x1): Interpolated grid: dx=1.200 mm, dy=1.200 mm

Maximum value of SAR (interpolated) = 0.118 W/kg

Ch38000/Zoom Scan (7x7x7)/Cube 0: Measurement grid: dx=5mm, dy=5mm, dz=5mm

Reference Value = 0.6080 V/m; Power Drift = 0.01 dB

Peak SAR (extrapolated) = 0.127 W/kg

SAR(1 g) = 0.061 W/kg; SAR(10 g) = 0.029 W/kg

Maximum value of SAR (measured) = 0.0908 W/kg

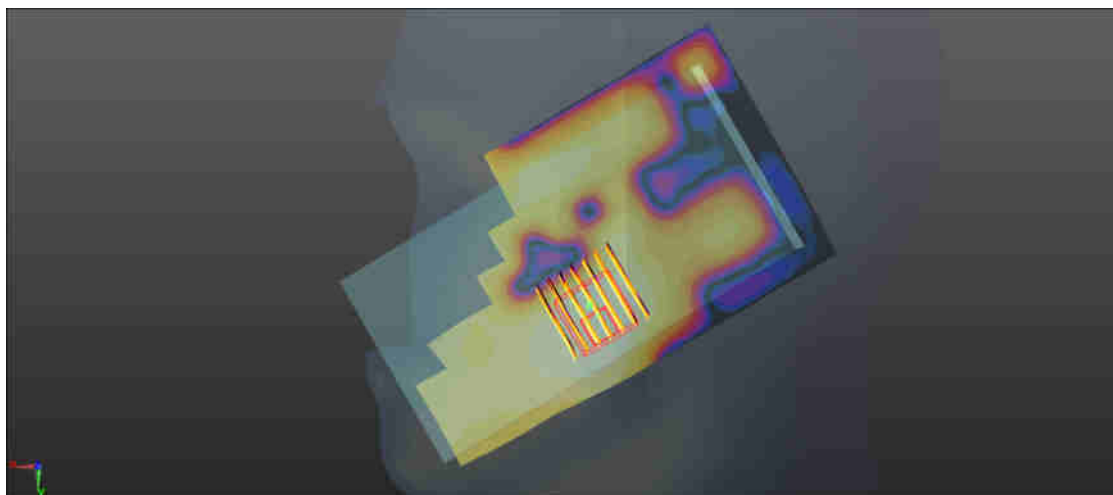
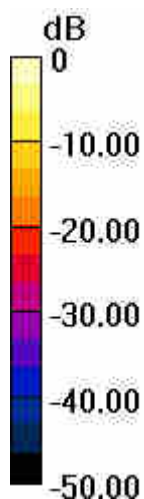

0 dB = 0.0908 W/kg = -10.42 dBW/kg

09_WLAN2.4GHz_802.11b 1Mbps_Left Cheek_0mm_Ch6

Communication System: UID 0, WIFI (0); Frequency: 2437 MHz; Duty Cycle: 1:1.024
Medium: HSL_2450 Medium parameters used: $f = 2437$ MHz; $\sigma = 1.862$ S/m; $\epsilon_r = 38.388$;
 $\rho = 1000$ kg/m³
Ambient Temperature : 23.5 °C ; Liquid Temperature : 22.5 °C

DASY5 Configuration:

- Probe: EX3DV4 - SN3857; ConvF(7.71, 7.71, 7.71); Calibrated: 2017.5.26;
- Sensor-Surface: 2mm (Mechanical Surface Detection)
- Electronics: DAE4 Sn1210; Calibrated: 2017.5.25
- Phantom: SAM3; Type: SAM; Serial: TP-1542
- Measurement SW: DASY52, Version 52.8 (8); SEMCAD X Version 14.6.10 (7331)

Ch6/Area Scan (81x151x1): Interpolated grid: dx=1.200 mm, dy=1.200 mm
Maximum value of SAR (interpolated) = 1.46 W/kg

Ch6/Zoom Scan (7x7x7)/Cube 0: Measurement grid: dx=5mm, dy=5mm, dz=5mm
Reference Value = 14.02 V/m; Power Drift = -0.01 dB
Peak SAR (extrapolated) = 2.00 W/kg
SAR(1 g) = 0.849 W/kg; SAR(10 g) = 0.394 W/kg
Maximum value of SAR (measured) = 1.33 W/kg

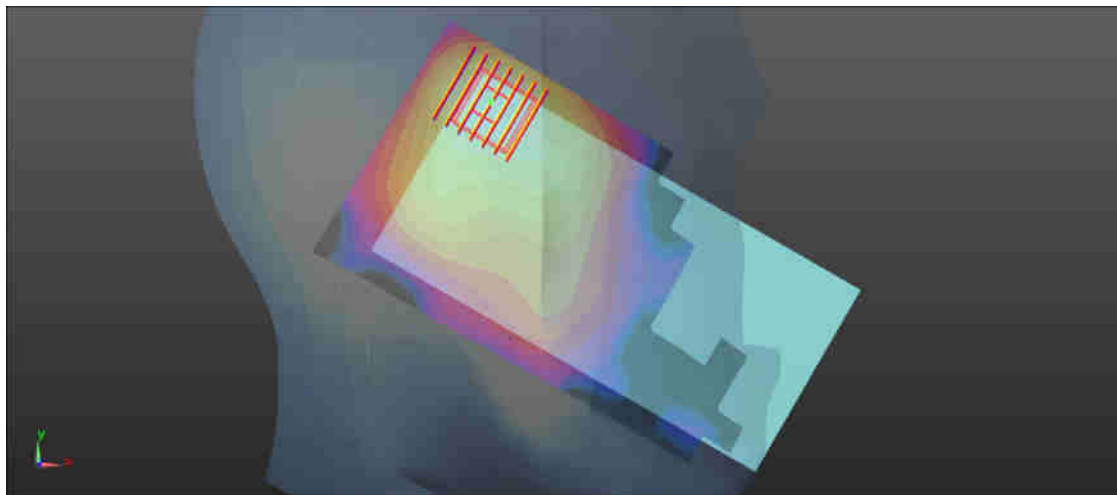
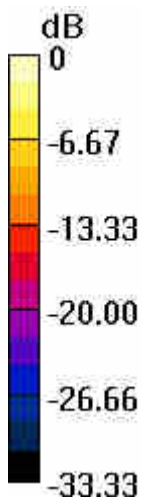

0 dB = 1.33 W/kg = 1.24 dBW/kg

10_WLAN 5.3GHz_802.11a 6Mbps_Left Tilted_0mm_Ch64

Communication System: UID 0, WIFI (0); Frequency: 5320 MHz; Duty Cycle: 1:1.146
Medium: HSL_5000 Medium parameters used: $f = 5320$ MHz; $\sigma = 4.711$ S/m; $\epsilon_r = 36.584$;
 $\rho = 1000$ kg/m³
Ambient Temperature : 23.4 °C ; Liquid Temperature : 22.6 °C

DASY5 Configuration:

- Probe: EX3DV4 - SN3857; ConvF(5.39, 5.39, 5.39); Calibrated: 2017.5.26;
- Sensor-Surface: 1.4mm (Mechanical Surface Detection)
- Electronics: DAE4 Sn1210; Calibrated: 2017.5.25
- Phantom: SAM2; Type: SAM; Serial: TP-1644
- Measurement SW: DASY52, Version 52.8 (8); SEMCAD X Version 14.6.10 (7331)

Ch64/Area Scan (101x181x1): Interpolated grid: dx=1.000 mm, dy=1.000 mm
Maximum value of SAR (interpolated) = 2.14 W/kg

Ch64/Zoom Scan (7x7x7)/Cube 0: Measurement grid: dx=4mm, dy=4mm, dz=1.4mm
Reference Value = 0.6420 V/m; Power Drift = -0.02 dB
Peak SAR (extrapolated) = 3.82 W/kg
SAR(1 g) = 0.805 W/kg; SAR(10 g) = 0.181 W/kg
Maximum value of SAR (measured) = 2.31 W/kg

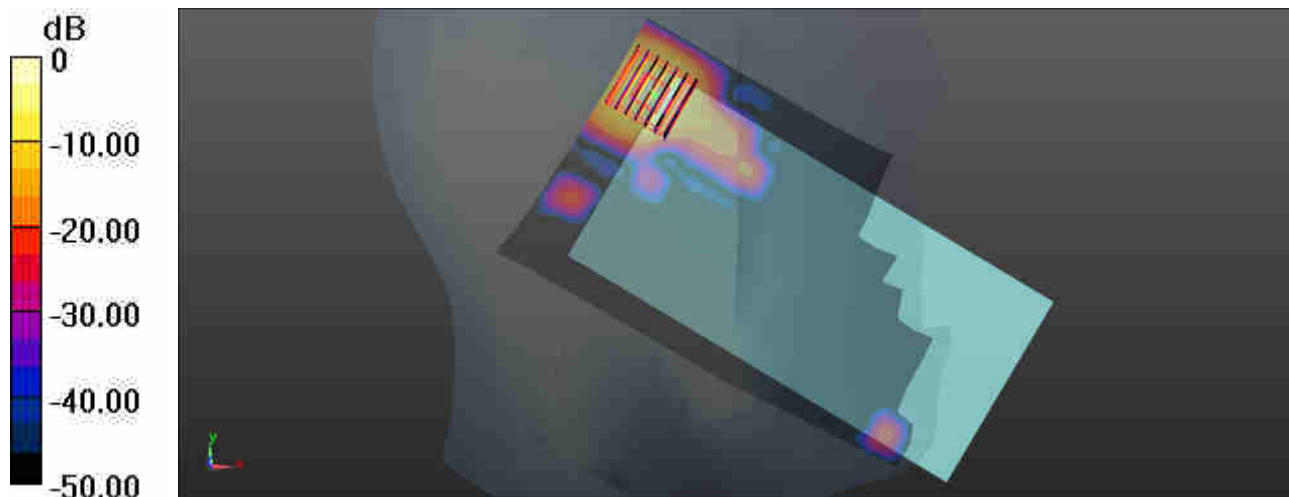

0 dB = 2.31 W/kg = 3.64 dBW/kg

11_WLAN 5.5GHz_802.11n-HT20 MCS0_Left Tilted_0mm_Ch140

Communication System: UID 0, WIFI (0); Frequency: 5700 MHz; Duty Cycle: 1:1.156
Medium: HSL_5000 Medium parameters used: $f = 5700$ MHz; $\sigma = 5.16$ S/m; $\epsilon_r = 35.748$;

$\rho = 1000$ kg/m³

Ambient Temperature : 23.4 °C ; Liquid Temperature : 22.9 °C

DASY5 Configuration:

- Probe: EX3DV4 - SN3857; ConvF(5.04, 5.04, 5.04); Calibrated: 2017.5.26;
- Sensor-Surface: 1.4mm (Mechanical Surface Detection)
- Electronics: DAE4 Sn1210; Calibrated: 2017.5.25
- Phantom: SAM2; Type: SAM; Serial: TP-1644
- Measurement SW: DASY52, Version 52.8 (8); SEMCAD X Version 14.6.10 (7331)

Ch140/Area Scan (101x181x1): Interpolated grid: dx=1.000 mm, dy=1.000 mm

Maximum value of SAR (interpolated) = 2.23 W/kg

Ch140/Zoom Scan (7x7x7)/Cube 0: Measurement grid: dx=4mm, dy=4mm, dz=1.4mm

Reference Value = 0.8610 V/m; Power Drift = -0.04 dB

Peak SAR (extrapolated) = 4.31 W/kg

SAR(1 g) = 0.857 W/kg; SAR(10 g) = 0.193 W/kg

Maximum value of SAR (measured) = 2.49 W/kg

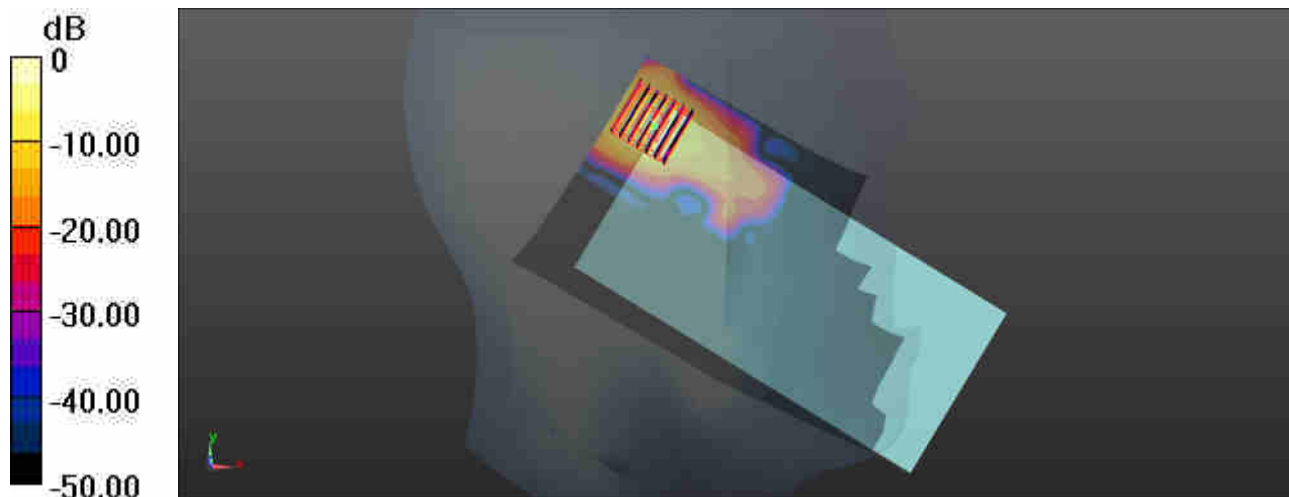

0 dB = 2.49 W/kg = 3.96 dBW/kg

12_WLAN5.8GHz_802.11n-HT20 MCS0_Left Tilted_0mm_Ch157

Communication System: UID 0, WIFI (0); Frequency: 5785 MHz; Duty Cycle: 1:1.156
Medium: HSL_5000 Medium parameters used: $f = 5785$ MHz; $\sigma = 5.261$ S/m; $\epsilon_r = 35.568$;
 $\rho = 1000$ kg/m³
Ambient Temperature : 23.4 °C ; Liquid Temperature : 22.9 °C

DASY5 Configuration:

- Probe: EX3DV4 - SN3857; ConvF(5.34, 5.34, 5.34); Calibrated: 2017.5.26;
- Sensor-Surface: 1.4mm (Mechanical Surface Detection)
- Electronics: DAE4 Sn1210; Calibrated: 2017.5.25
- Phantom: SAM2; Type: SAM; Serial: TP-1644
- Measurement SW: DASY52, Version 52.8 (8); SEMCAD X Version 14.6.10 (7331)

Ch157/Area Scan (101x181x1): Interpolated grid: dx=1.000 mm, dy=1.000 mm
Maximum value of SAR (interpolated) = 1.83 W/kg

Ch157/Zoom Scan (7x7x7)/Cube 0: Measurement grid: dx=4mm, dy=4mm, dz=1.4mm
Reference Value = 0.5920 V/m; Power Drift = -0.03 dB
Peak SAR (extrapolated) = 3.65 W/kg
SAR(1 g) = 0.716 W/kg; SAR(10 g) = 0.161 W/kg
Maximum value of SAR (measured) = 2.11 W/kg

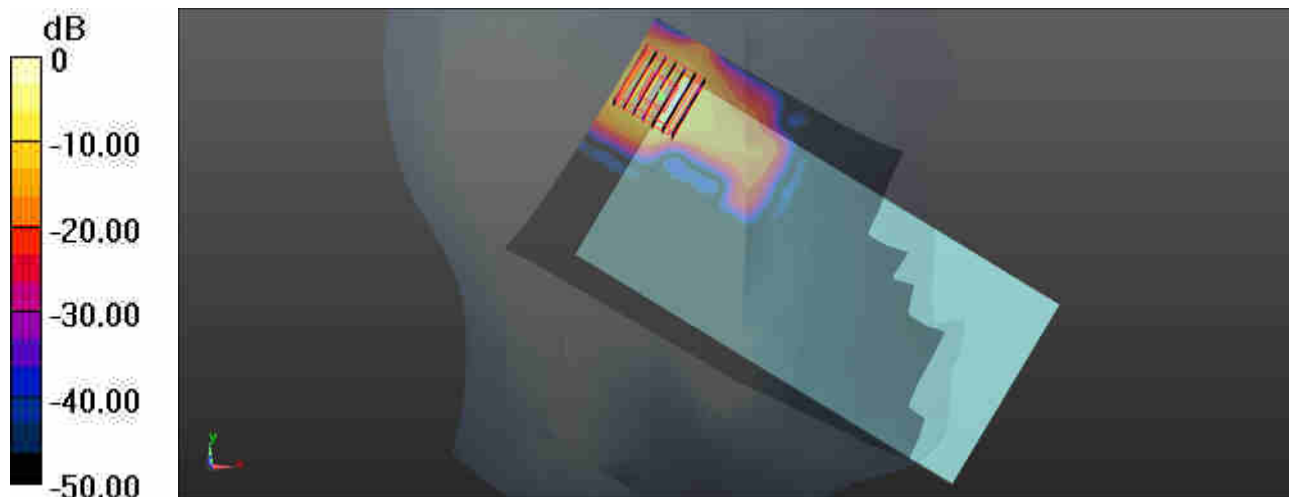

0 dB = 2.11 W/kg = 3.24 dBW/kg

13_GSM850_GPRS 4 Tx slots_Back_10mm_Ch189

Communication System: UID 0, GPRS/EDGE (4 Tx slots) (0); Frequency: 836.4 MHz; Duty Cycle: 1:2.08
Medium: MSL_850 Medium parameters used: $f = 836.4$ MHz; $\sigma = 0.978$ S/m; $\epsilon_r = 55.102$;

$$\rho = 1000 \text{ kg/m}^3$$

Ambient Temperature : 23.3 °C ; Liquid Temperature : 22.8 °C

DASY5 Configuration:

- Probe: EX3DV4 - SN3857; ConvF(9.72, 9.72, 9.72); Calibrated: 2017.5.26;
- Sensor-Surface: 2mm (Mechanical Surface Detection)
- Electronics: DAE4 Sn1210; Calibrated: 2017.5.25
- Phantom: SAM1; Type: SAM; Serial: TP-1164
- Measurement SW: DASY52, Version 52.8 (8); SEMCAD X Version 14.6.10 (7331)

Ch189/Area Scan (121x71x1): Interpolated grid: dx=1.500 mm, dy=1.500 mm

Maximum value of SAR (interpolated) = 0.328 W/kg

Ch189/Zoom Scan (5x5x7)/Cube 0: Measurement grid: dx=8mm, dy=8mm, dz=5mm

Reference Value = 18.43 V/m; Power Drift = 0.08 dB

Peak SAR (extrapolated) = 0.369 W/kg

SAR(1 g) = 0.286 W/kg; SAR(10 g) = 0.223 W/kg

Maximum value of SAR (measured) = 0.335 W/kg

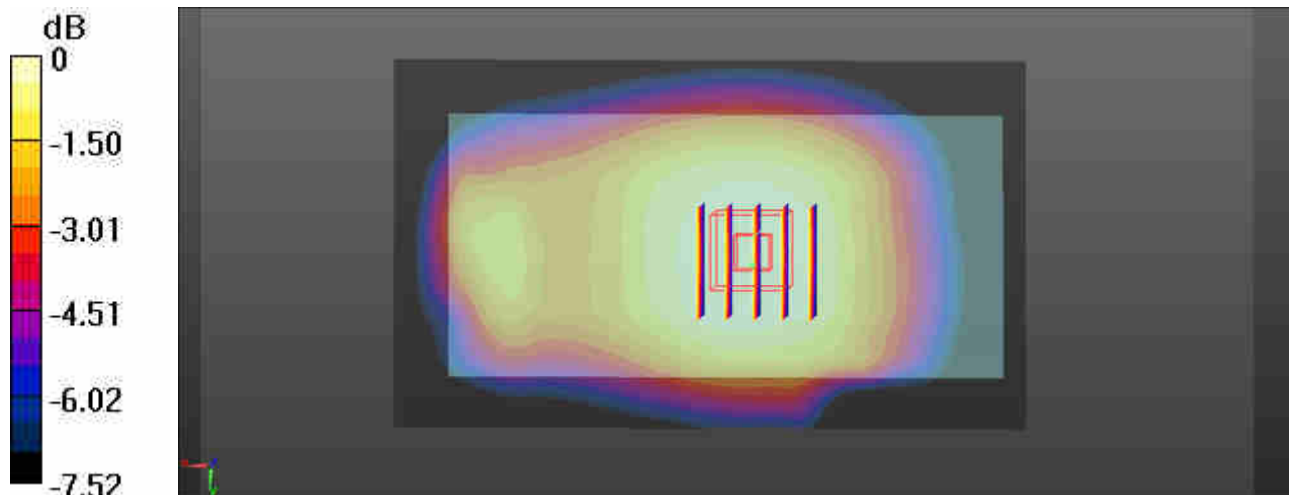

0 dB = 0.335 W/kg = -4.75 dBW/kg

14_GSM1900_GPRS 1 Tx slot_Bottom Side_10mm_Ch810

Communication System: UID 0, General GSM (0); Frequency: 1909.8 MHz; Duty Cycle: 1:8.3
 Medium: MSL_1900 Medium parameters used: $f = 1909.8 \text{ MHz}$; $\sigma = 1.568 \text{ S/m}$; $\epsilon_r = 53.567$;

$\rho = 1000 \text{ kg/m}^3$

Ambient Temperature : $23.3 \text{ }^\circ\text{C}$; Liquid Temperature : $22.7 \text{ }^\circ\text{C}$

DASY5 Configuration:

- Probe: EX3DV4 - SN3857; ConvF(8.08, 8.08, 8.08); Calibrated: 2017.5.26;
- Sensor-Surface: 2mm (Mechanical Surface Detection)
- Electronics: DAE4 Sn1210; Calibrated: 2017.5.25
- Phantom: SAM1; Type: SAM; Serial: TP-1164
- Measurement SW: DASY52, Version 52.8 (8); SEMCAD X Version 14.6.10 (7331)

Ch810/Area Scan (41x71x1): Interpolated grid: $dx=1.500 \text{ mm}$, $dy=1.500 \text{ mm}$

Maximum value of SAR (interpolated) = 0.769 W/kg

Ch810/Zoom Scan (5x5x7)/Cube 0: Measurement grid: $dx=8\text{mm}$, $dy=8\text{mm}$, $dz=5\text{mm}$

Reference Value = 20.97 V/m ; Power Drift = 0.10 dB

Peak SAR (extrapolated) = 0.916 W/kg

SAR(1 g) = 0.522 W/kg ; SAR(10 g) = 0.263 W/kg

Maximum value of SAR (measured) = 0.729 W/kg

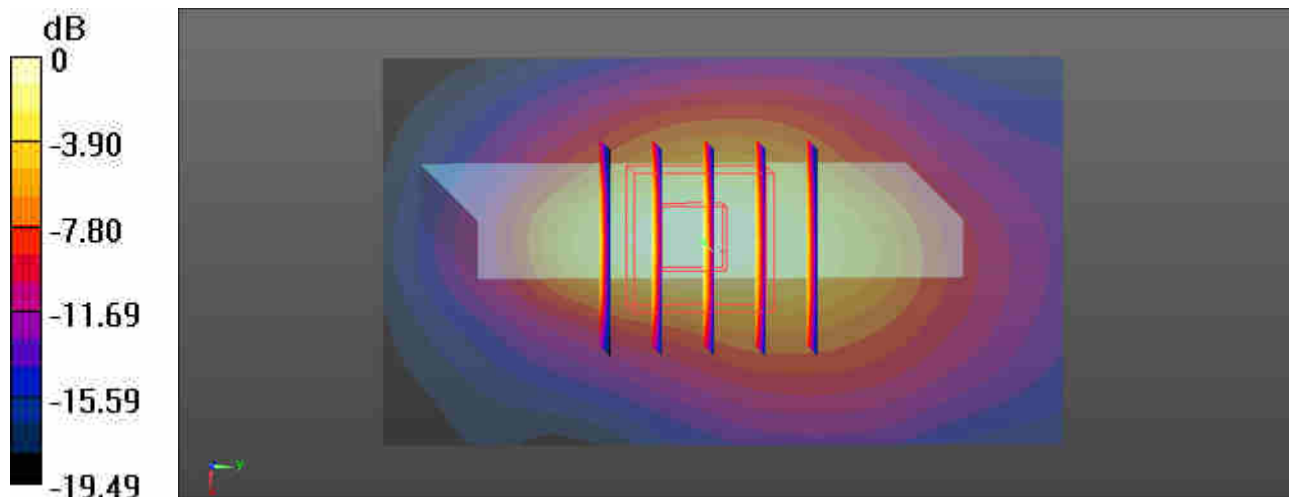

$0 \text{ dB} = 0.729 \text{ W/kg} = -1.37 \text{ dBW/kg}$

15_WCDMA Band V_RMC 12.2Kbps_Back_10mm_Ch4233

Communication System: UID 0, UMTS (0); Frequency: 846.6 MHz; Duty Cycle: 1:1
Medium: MSL_850 Medium parameters used: $f = 846.6$ MHz; $\sigma = 0.989$ S/m; $\epsilon_r = 54.969$;
 $\rho = 1000$ kg/m³
Ambient Temperature : 23.3 °C ; Liquid Temperature : 22.8 °C

DASY5 Configuration:

- Probe: EX3DV4 - SN3857; ConvF(9.72, 9.72, 9.72); Calibrated: 2017.5.26;
- Sensor-Surface: 2mm (Mechanical Surface Detection)
- Electronics: DAE4 Sn1210; Calibrated: 2017.5.25
- Phantom: SAM1; Type: SAM; Serial: TP-1164
- Measurement SW: DASY52, Version 52.8 (8); SEMCAD X Version 14.6.10 (7331)

Ch4233/Area Scan (121x71x1): Interpolated grid: dx=1.500 mm, dy=1.500 mm
Maximum value of SAR (interpolated) = 0.368 W/kg

Ch4233/Zoom Scan (5x5x7)/Cube 0: Measurement grid: dx=8mm, dy=8mm, dz=5mm
Reference Value = 19.49 V/m; Power Drift = -0.04 dB
Peak SAR (extrapolated) = 0.405 W/kg
SAR(1 g) = 0.321 W/kg; SAR(10 g) = 0.250 W/kg
Maximum value of SAR (measured) = 0.367 W/kg

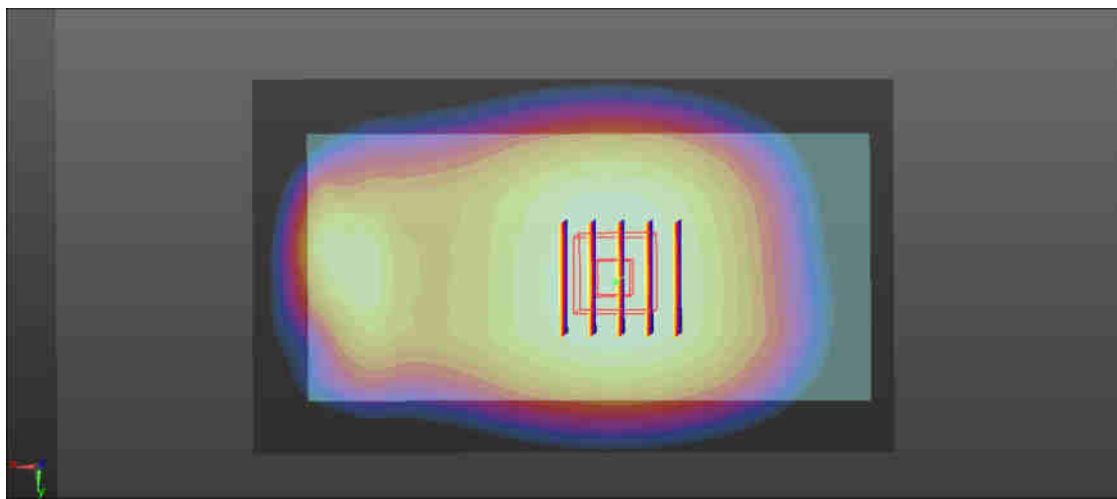
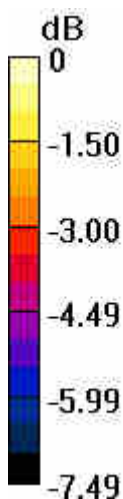

0 dB = 0.367 W/kg = -4.35 dBW/kg

16_WCDMA Band II_RMC 12.2Kbps_Bottom Side_10mm_Ch9262

Communication System: UID 0, UMTS (0); Frequency: 1852.4 MHz; Duty Cycle: 1:1
Medium: MSL_1900 Medium parameters used: $f = 1852.4$ MHz; $\sigma = 1.5$ S/m; $\epsilon_r = 53.809$;

$\rho = 1000$ kg/m³

Ambient Temperature : 23.3 °C ; Liquid Temperature : 22.7 °C

DASY5 Configuration:

- Probe: EX3DV4 - SN3857; ConvF(8.08, 8.08, 8.08); Calibrated: 2017.5.26;
- Sensor-Surface: 2mm (Mechanical Surface Detection)
- Electronics: DAE4 Sn1210; Calibrated: 2017.5.25
- Phantom: SAM1; Type: SAM; Serial: TP-1164
- Measurement SW: DASY52, Version 52.8 (8); SEMCAD X Version 14.6.10 (7331)

Ch9262/Area Scan (41x71x1): Interpolated grid: dx=1.500 mm, dy=1.500 mm

Maximum value of SAR (interpolated) = 1.50 W/kg

Ch9262/Zoom Scan (5x5x7)/Cube 0: Measurement grid: dx=8mm, dy=8mm, dz=5mm

Reference Value = 30.22 V/m; Power Drift = -0.19 dB

Peak SAR (extrapolated) = 1.72 W/kg

SAR(1 g) = 0.969 W/kg; SAR(10 g) = 0.499 W/kg

Maximum value of SAR (measured) = 1.34 W/kg

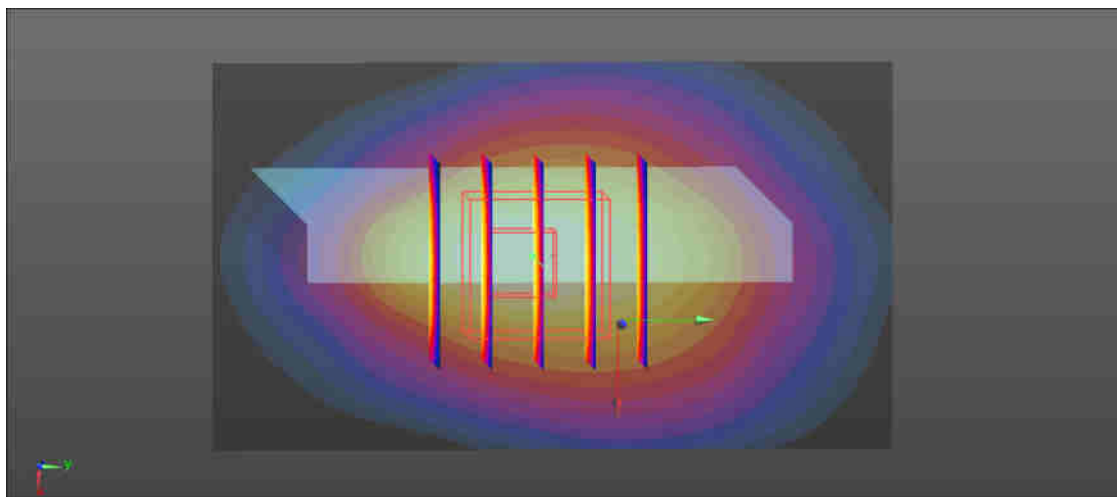
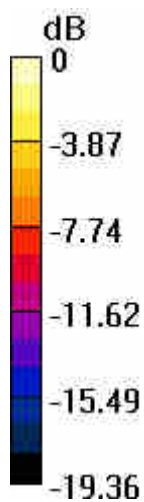

0 dB = 1.34 W/kg = 1.27 dBW/kg

17_LTE Band 5_10M_QPSK_1RB_25Offset_Back_10mm_Ch20525

Communication System: UID 0, FDD_LTE (0); Frequency: 836.5 MHz; Duty Cycle: 1:1
Medium: MSL_850 Medium parameters used: $f = 836.5$ MHz; $\sigma = 0.979$ S/m; $\epsilon_r = 55.1$;

$$\rho = 1000 \text{ kg/m}^3$$

Ambient Temperature : 23.3 °C ; Liquid Temperature : 22.8 °C

DASY5 Configuration:

- Probe: EX3DV4 - SN3857; ConvF(9.72, 9.72, 9.72); Calibrated: 2017.5.26;
- Sensor-Surface: 2mm (Mechanical Surface Detection)
- Electronics: DAE4 Sn1210; Calibrated: 2017.5.25
- Phantom: SAM1; Type: SAM; Serial: TP-1164
- Measurement SW: DASY52, Version 52.8 (8); SEMCAD X Version 14.6.10 (7331)

Ch20525/Area Scan (121x71x1): Interpolated grid: dx=1.500 mm, dy=1.500 mm

Maximum value of SAR (interpolated) = 0.269 W/kg

Ch20525/Zoom Scan (5x5x7)/Cube 0: Measurement grid: dx=8mm, dy=8mm, dz=5mm

Reference Value = 16.66 V/m; Power Drift = 0.02 dB

Peak SAR (extrapolated) = 0.306 W/kg

SAR(1 g) = 0.236 W/kg; SAR(10 g) = 0.182 W/kg

Maximum value of SAR (measured) = 0.274 W/kg

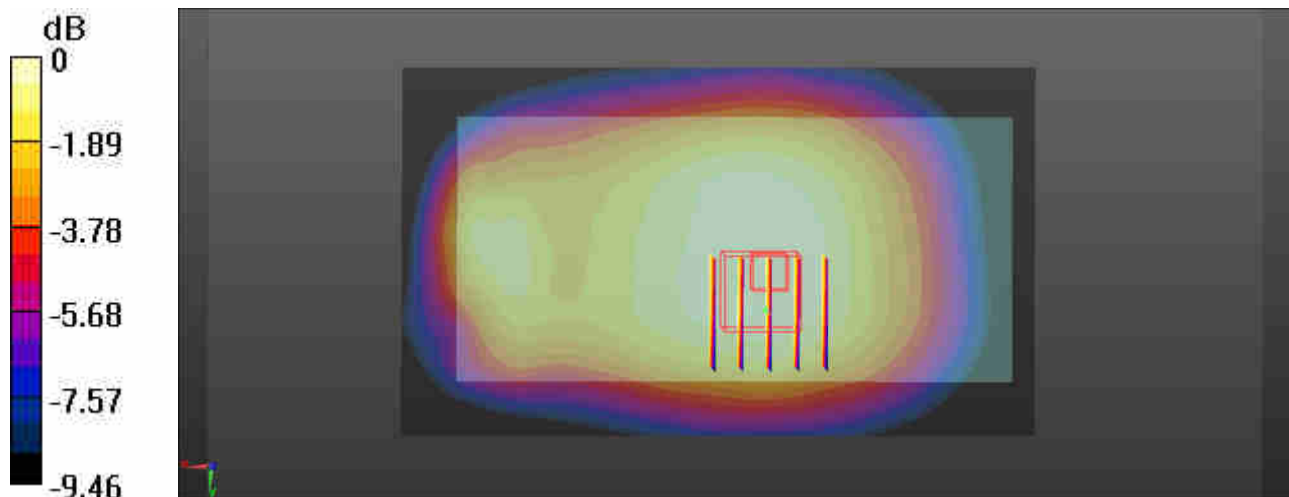

0 dB = 0.274 W/kg = -5.62 dBW/kg

18_LTE Band 4_20M_QPSK_100RB_0Offset_Bottom Side_10mm_Ch20175

Communication System: UID 0, FDD_LTE (0); Frequency: 1732.5 MHz; Duty Cycle: 1:1
Medium: MSL_1750 Medium parameters used: $f = 1732.5$ MHz; $\sigma = 1.441$ S/m; $\epsilon_r = 53.948$;

$\rho = 1000$ kg/m³

Ambient Temperature : 23.3 °C ; Liquid Temperature : 22.7 °C

DASY5 Configuration:

- Probe: EX3DV4 - SN3857; ConvF(8.29, 8.29, 8.29); Calibrated: 2017.5.26;
- Sensor-Surface: 2mm (Mechanical Surface Detection)
- Electronics: DAE4 Sn1210; Calibrated: 2017.5.25
- Phantom: SAM1; Type: SAM; Serial: TP-1164
- Measurement SW: DASY52, Version 52.8 (8); SEMCAD X Version 14.6.10 (7331)

Ch20175/Area Scan (41x81x1): Interpolated grid: dx=1.500 mm, dy=1.500 mm
Maximum value of SAR (interpolated) = 1.09 W/kg

Ch20175/Zoom Scan (5x5x7)/Cube 0: Measurement grid: dx=8mm, dy=8mm, dz=5mm
Reference Value = 26.40 V/m; Power Drift = -0.16 dB
Peak SAR (extrapolated) = 1.30 W/kg
SAR(1 g) = 0.748 W/kg; SAR(10 g) = 0.393 W/kg
Maximum value of SAR (measured) = 1.04 W/kg

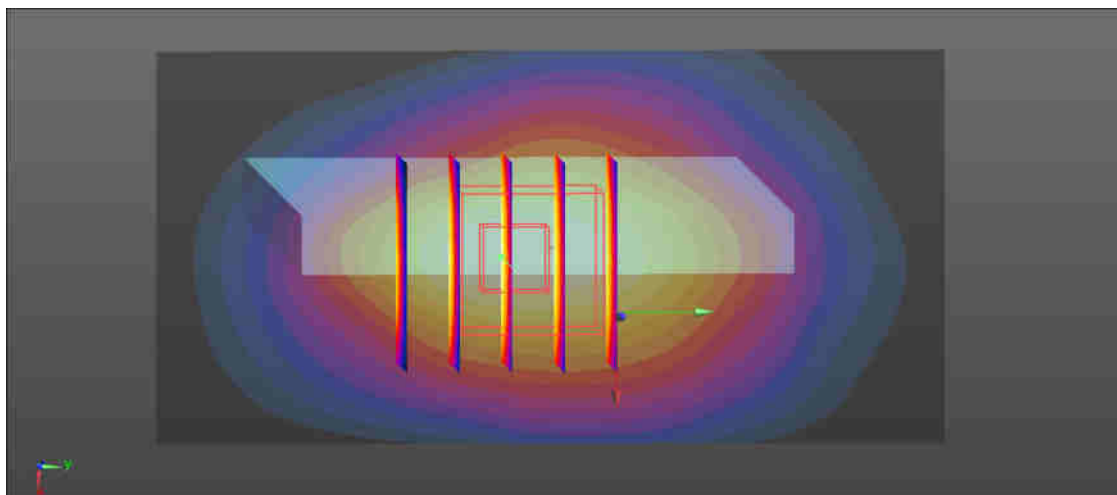
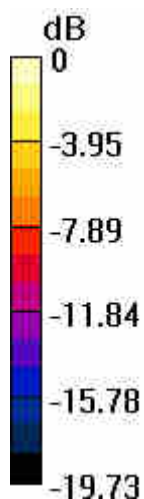

0 dB = 1.04 W/kg = 0.17 dBW/kg

19_LTE Band 7_20M_QPSK_50RB_0Offset_Bottom Side_10mm_Ch21350

Communication System: UID 0, FDD_LTE (0); Frequency: 2560 MHz; Duty Cycle: 1:1
Medium: MSL_2600 Medium parameters used: $f = 2560$ MHz; $\sigma = 2.11$ S/m; $\epsilon_r = 52.19$;

$$\rho = 1000 \text{ kg/m}^3$$

Ambient Temperature : 23.2 °C ; Liquid Temperature : 22.7 °C

DASY5 Configuration:

- Probe: EX3DV4 - SN3857; ConvF(7.59, 7.59, 7.59); Calibrated: 2017.5.26;
- Sensor-Surface: 2mm (Mechanical Surface Detection)
- Electronics: DAE4 Sn1210; Calibrated: 2017.5.25
- Phantom: SAM1; Type: SAM; Serial: TP-1164
- Measurement SW: DASY52, Version 52.8 (8); SEMCAD X Version 14.6.10 (7331)

Ch21350/Area Scan (41x81x1): Interpolated grid: $dx=1.200$ mm, $dy=1.200$ mm

Maximum value of SAR (interpolated) = 1.25 W/kg

Ch21350/Zoom Scan (7x7x7)/Cube 0: Measurement grid: $dx=5$ mm, $dy=5$ mm, $dz=5$ mm

Reference Value = 22.54 V/m; Power Drift = 0.15 dB

Peak SAR (extrapolated) = 1.60 W/kg

SAR(1 g) = 0.856 W/kg; SAR(10 g) = 0.431 W/kg

Maximum value of SAR (measured) = 1.24 W/kg

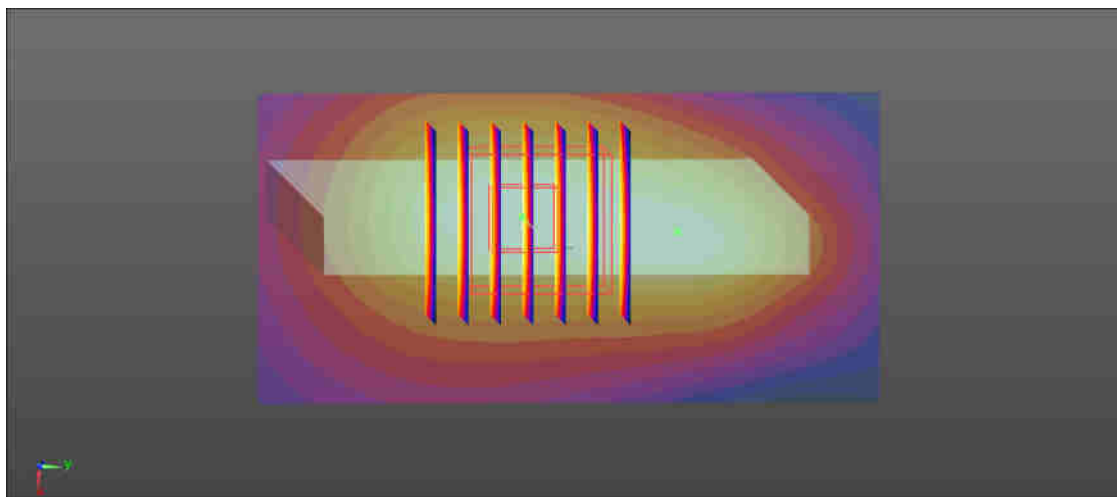
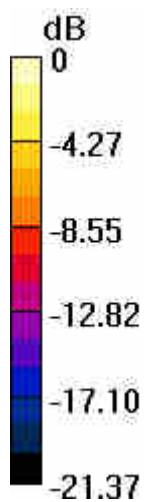

0 dB = 1.24 W/kg = 0.93 dBW/kg

20_LTE Band 38_20M_QPSK_1RB_49Offset_Bottom Side_10mm_Ch38000

Communication System: UID 0, TDD_LTE (0); Frequency: 2595 MHz; Duty Cycle: 1:1.59
Medium: MSL_2600 Medium parameters used: $f = 2595$ MHz; $\sigma = 2.16$ S/m; $\epsilon_r = 52.065$;

$$\rho = 1000 \text{ kg/m}^3$$

Ambient Temperature : 23.2 °C ; Liquid Temperature : 22.7 °C

DASY5 Configuration:

- Probe: EX3DV4 - SN3857; ConvF(7.59, 7.59, 7.59); Calibrated: 2017.5.26;
- Sensor-Surface: 2mm (Mechanical Surface Detection)
- Electronics: DAE4 Sn1210; Calibrated: 2017.5.25
- Phantom: SAM1; Type: SAM; Serial: TP-1164
- Measurement SW: DASY52, Version 52.8 (8); SEMCAD X Version 14.6.10 (7331)

Ch38000/Area Scan (41x81x1): Interpolated grid: dx=1.200 mm, dy=1.200 mm

Maximum value of SAR (interpolated) = 0.926 W/kg

Ch38000/Zoom Scan (7x7x7)/Cube 0: Measurement grid: dx=5mm, dy=5mm, dz=5mm

Reference Value = 16.36 V/m; Power Drift = 0.18 dB

Peak SAR (extrapolated) = 1.31 W/kg

SAR(1 g) = 0.689 W/kg; SAR(10 g) = 0.339 W/kg

Maximum value of SAR (measured) = 1.00 W/kg

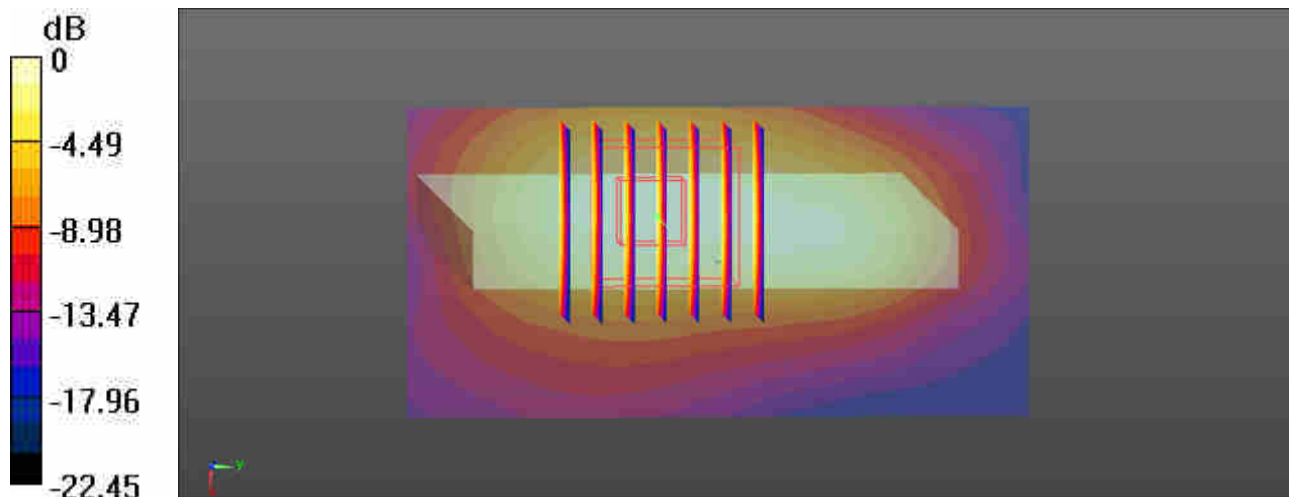

0 dB = 1.00 W/kg = 0.00 dBW/kg

21_WLAN2.4GHz_802.11b 1Mbps_Back_10mm_Ch6

Communication System: UID 0, WIFI (0); Frequency: 2437 MHz; Duty Cycle: 1:1.024
Medium: MSL_2450 Medium parameters used: $f = 2437$ MHz; $\sigma = 1.944$ S/m; $\epsilon_r = 52.615$;
 $\rho = 1000$ kg/m³
Ambient Temperature : 23.5 °C ; Liquid Temperature : 22.5 °C

DASY5 Configuration:

- Probe: EX3DV4 - SN3857; ConvF(7.7, 7.7, 7.7); Calibrated: 2017.5.26;
- Sensor-Surface: 2mm (Mechanical Surface Detection)
- Electronics: DAE4 Sn1210; Calibrated: 2017.5.25
- Phantom: SAM1; Type: SAM; Serial: TP-1164
- Measurement SW: DASY52, Version 52.8 (8); SEMCAD X Version 14.6.10 (7331)

Ch6/Area Scan (151x81x1): Interpolated grid: dx=1.200 mm, dy=1.200 mm

Maximum value of SAR (interpolated) = 0.231 W/kg

Ch6/Zoom Scan (7x7x7)/Cube 0: Measurement grid: dx=5mm, dy=5mm, dz=5mm

Reference Value = 4.470 V/m; Power Drift = -0.05 dB

Peak SAR (extrapolated) = 0.313 W/kg

SAR(1 g) = 0.155 W/kg; SAR(10 g) = 0.076 W/kg

Maximum value of SAR (measured) = 0.224 W/kg

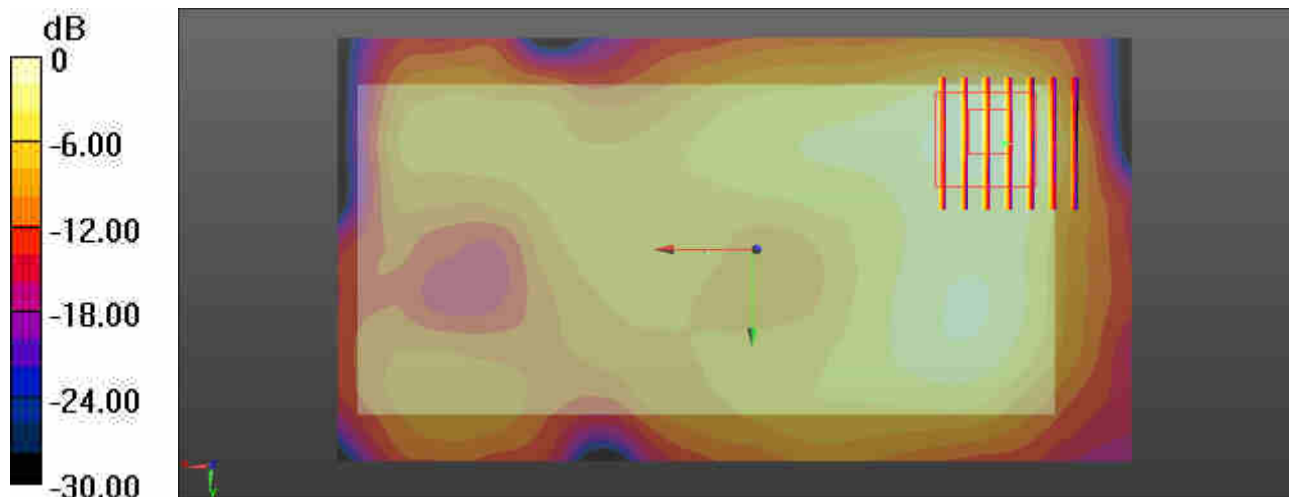

0 dB = 0.224 W/kg = -6.50 dBW/kg

22_WLAN 5.2GHz_802.11a 6Mbps_Top Side_10mm_Ch36

Communication System: UID 0, WIFI (0); Frequency: 5180 MHz; Duty Cycle: 1:1.146
Medium: MSL_5000 Medium parameters used: $f = 5180$ MHz; $\sigma = 5.282$ S/m; $\epsilon_r = 47.849$;
 $\rho = 1000$ kg/m³
Ambient Temperature : 23.6 °C ; Liquid Temperature : 22.7 °C

DASY5 Configuration:

- Probe: EX3DV4 - SN3857; ConvF(4.72, 4.72, 4.72); Calibrated: 2017.5.26;
- Sensor-Surface: 1.4mm (Mechanical Surface Detection)
- Electronics: DAE4 Sn1210; Calibrated: 2017.5.25
- Phantom: SAM1; Type: SAM; Serial: TP-1164
- Measurement SW: DASY52, Version 52.8 (8); SEMCAD X Version 14.6.10 (7331)

Ch36/Area Scan (41x91x1): Interpolated grid: dx=1.000 mm, dy=1.000 mm
Maximum value of SAR (interpolated) = 0.656 W/kg

Ch36/Zoom Scan (7x7x7)/Cube 0: Measurement grid: dx=4mm, dy=4mm, dz=1.4mm
Reference Value = 3.048 V/m; Power Drift = 0.09 dB
Peak SAR (extrapolated) = 1.13 W/kg
SAR(1 g) = 0.299 W/kg; SAR(10 g) = 0.097 W/kg
Maximum value of SAR (measured) = 0.685 W/kg

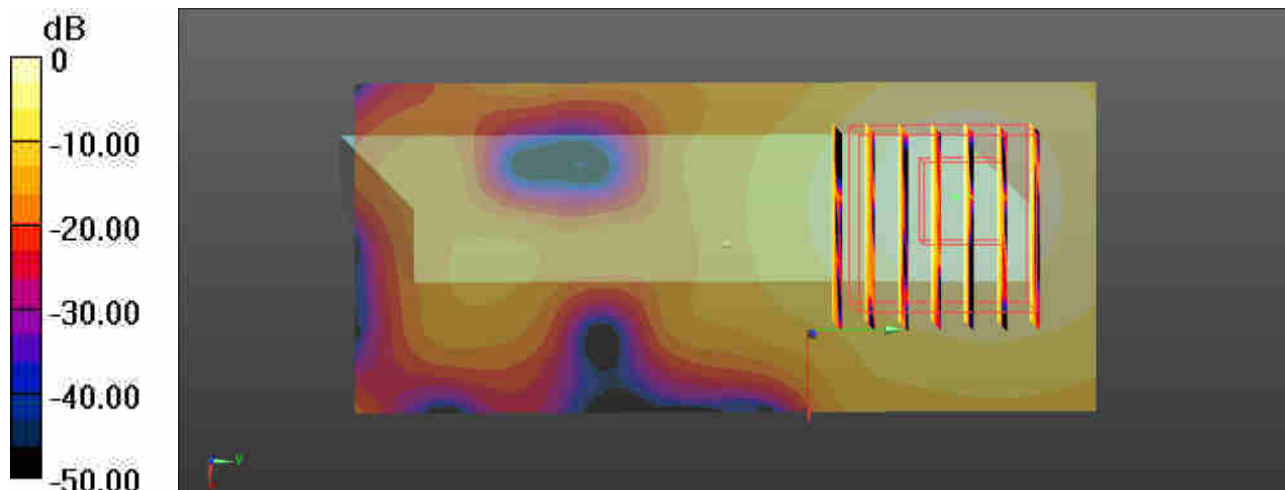

0 dB = 0.685 W/kg = -1.64 dBW/kg