



FCC RF Test Report

APPLICANT : Ignition Design Lab (US) LLC
EQUIPMENT : Advanced Wireless Router
BRAND NAME : Ignition Design Labs
MODEL NAME : Portal SAP001
MARKETING NAME : IgnitionHub
FCC ID : 2AFZUSAP001
STANDARD : FCC Part 15 Subpart E §15.407
CLASSIFICATION : (NII) Unlicensed National Information Infrastructure

The product was received on Oct. 06, 2015 and testing was completed on Nov. 19, 2015. We, SPORTON INTERNATIONAL INC., would like to declare that the tested sample has been evaluated in accordance with the test procedures and has been in compliance with the applicable technical standards.

The test results in this report apply exclusively to the tested model / sample. Without written approval of SPORTON INTERNATIONAL INC., the test report shall not be reproduced except in full.

Reviewed by: Joseph Lin / Supervisor

Approved by: Jones Tsai / Manager



SPORTON INTERNATIONAL INC.

No. 52, Hwa Ya 1st Rd., Hwa Ya Technology Park, Kwei-Shan District, Tao Yuan City, Taiwan, R.O.C.

SPORTON INTERNATIONAL INC.

TEL : 886-3-327-3456

FAX : 886-3-328-4978

FCC ID : 2AFZUSAP001

Page Number : 1 of 45

Report Issued Date : Jan. 05, 2016

Report Version : Rev. 01

Report Template No.: BU5-FR15EWL AC MA Version 1.0



TABLE OF CONTENTS

REVISION HISTORY..... 3

SUMMARY OF TEST RESULT 4

1 GENERAL DESCRIPTION 5

 1.1 Applicant 5

 1.2 Manufacturer..... 5

 1.3 Feature of Equipment Under Test 5

 1.4 Product Specification of Equipment Under Test..... 6

 1.5 Modification of EUT 7

 1.6 Testing Location 7

 1.7 Applicable Standards..... 7

2 TEST CONFIGURATION OF EQUIPMENT UNDER TEST 8

 2.1 Carrier Frequency and Channel 8

 2.2 Pre-Scanned RF Power..... 9

 2.3 Test Mode..... 21

 2.4 Connection Diagram of Test System..... 23

 2.5 Support Unit used in test configuration and system..... 24

 2.6 EUT Operation Test Setup 24

 2.7 Measurement Results Explanation Example..... 25

3 TEST RESULT..... 26

 3.1 26dB & 99% Bandwidth Measurement..... 26

 3.2 Maximum Conducted Output Power Measurement 28

 3.3 Power Spectral Density Measurement 30

 3.4 Unwanted Emissions Measurement..... 32

 3.5 AC Conducted Emission Measurement..... 37

 3.6 Frequency Stability Measurement..... 41

 3.7 Automatically Discontinue Transmission 42

 3.8 Antenna Requirements..... 43

4 LIST OF MEASURING EQUIPMENT 44

5 UNCERTAINTY OF EVALUATION 45

APPENDIX A. CONDUCTED TEST RESULTS

APPENDIX B. RADIATED TEST RESULTS

APPENDIX C. SETUP PHOTOGRAPHS



REVISION HISTORY

REPORT NO.	VERSION	DESCRIPTION	ISSUED DATE
FR5O0602-01	Rev. 01	Initial issue of report	Jan. 05, 2016



SUMMARY OF TEST RESULT

Report Section	FCC Rule	Description	Limit	Result	Remark
3.1	2.1049 15.403(i)	26dB & 99% Bandwidth	-	Pass	-
3.2	15.407(a)	Maximum Conducted Output Power	≤ 30 dBm (depend on band)	Pass	-
3.3	15.407(a)	Power Spectral Density	≤ 17 dBm (depend on band)	Pass	-
3.4	15.407(b)	Unwanted Emissions	≤ -17, -27 dBm (depend on band)&15.209(a)	Pass	Under limit 0.23 dB at 5725.000 MHz
3.5	15.207	AC Conducted Emission	15.207(a)	Pass	Under limit 9.60 dB at 0.166 MHz
3.6	15.407(g)	Frequency Stability	Within Operation Band	Pass	-
3.7	15.407(c)	Automatically Discontinue Transmission	Discontinue Transmission	Pass	-
3.8	15.203 & 15.407(a)	Antenna Requirement	N/A	Pass	-



1 General Description

1.1 Applicant

Ignition Design Lab (US) LLC

5F-2., No.158, Sec.2, Gongdao 5th Rd., Hsinchu City 30070, Taiwan

1.2 Manufacturer

Ignition Design Lab (US) LLC

5F-2., No.158, Sec.2, Gongdao 5th Rd., Hsinchu City 30070, Taiwan

1.3 Feature of Equipment Under Test

Product Feature	
Equipment	Advanced Wireless Router
Brand Name	Ignition Design Labs
Model Name	Portal SAP001
Marketing Name	IgnitionHub
FCC ID	2AFZUSAP001
EUT supports Radios application	WLAN 11a/b/g/n HT20/HT40 WLAN 11ac VHT20/VHT40/VHT80
HW Version	v0.1
SW Version	1.0.003
EUT Stage	Production Unit

Remark: The above EUT's information was declared by manufacturer. Please refer to the specifications or user's manual for more detailed description.



1.4 Product Specification of Equipment Under Test

Product Specification subjective to this standard																			
Tx/Rx Channel Frequency Range	5260 MHz ~ 5320 MHz 5500 MHz ~ 5700 MHz																		
Maximum Output Power	<p><5260 MHz ~ 5320 MHz> MIMO<Ant. 1 + 2 + 3 + 4 + 5> 802.11a : 19.04 dBm / 0.0802 W 802.11n HT20 : 19.24 dBm / 0.0839 W 802.11n HT40 : 20.36 dBm / 0.1086 W 802.11ac VHT20 : 19.32 dBm / 0.0855 W 802.11ac VHT40 : 20.38 dBm / 0.1091 W 802.11ac VHT80 : 15.40 dBm / 0.0347 W</p> <p><5500 MHz ~ 5700 MHz> MIMO<Ant. 1 + 2 + 3 + 4 + 5> 802.11a : 19.05 dBm / 0.0804 W 802.11n HT20 : 19.36 dBm / 0.0863 W 802.11n HT40 : 20.03 dBm / 0.1007 W 802.11ac VHT20 : 19.45 dBm / 0.0881 W 802.11ac VHT40 : 20.09 dBm / 0.1021 W 802.11ac VHT80 : 19.47 dBm / 0.0885 W</p>																		
99% Occupied Bandwidth	802.11a : 18.10 MHz 802.11ac VHT20 19.05 MHz 802.11ac VHT40 37.50 MHz 802.11ac VHT80: 76.44 MHz																		
Antenna Type	<p><Ant 1> 802.11a/n/ac : Dipole Antenna type with gain 2.00 dBi</p> <p><Ant 2> 802.11a/n/ac : Dipole Antenna type with gain 2.00 dBi</p> <p><Ant 3> 802.11a/n/ac : Dipole Antenna type with gain 2.00 dBi</p> <p><Ant 4> 802.11a/n/ac : Dipole Antenna type with gain 2.00 dBi</p> <p><Ant 5> 802.11a/n/ac : FPC Antenna type with gain 1.00 dBi</p>																		
Type of Modulation	802.11a/n : OFDM (BPSK / QPSK / 16QAM / 64QAM) 802.11ac : OFDM (BPSK / QPSK / 16QAM / 64QAM / 256QAM)																		
Antenna Function Description	<table border="1"> <thead> <tr> <th></th> <th>Ant. 1</th> <th>Ant. 2</th> <th>Ant. 3</th> <th>Ant. 4</th> <th>Ant. 5</th> </tr> </thead> <tbody> <tr> <td>802.11 a/n/ac SISO</td> <td>V</td> <td>V</td> <td>V</td> <td>V</td> <td>V</td> </tr> <tr> <td>802.11 a/n/ac MIMO</td> <td>V</td> <td>V</td> <td>V</td> <td>V</td> <td>V</td> </tr> </tbody> </table>		Ant. 1	Ant. 2	Ant. 3	Ant. 4	Ant. 5	802.11 a/n/ac SISO	V	V	V	V	V	802.11 a/n/ac MIMO	V	V	V	V	V
	Ant. 1	Ant. 2	Ant. 3	Ant. 4	Ant. 5														
802.11 a/n/ac SISO	V	V	V	V	V														
802.11 a/n/ac MIMO	V	V	V	V	V														



1.5 Modification of EUT

No modifications are made to the EUT during all test items.

1.6 Testing Location

Sporton Lab is accredited to ISO 17025 by Taiwan Accreditation Foundation (TAF code : 1190) and the FCC designation No. TW1022 under the FCC 2.948(e) by Mutual Recognition Agreement (MRA) in FCC Test.

Test Site	SPORTON INTERNATIONAL INC.		
Test Site Location	No. 52, Hwa Ya 1 st Rd., Hwa Ya Technology Park, Kwei-Shan District, Tao Yuan City, Taiwan, R.O.C. TEL: +886-3-327-3456 FAX: +886-3-328-4978		
Test Site No.	Sporton Site No.		
	TH05-HY	CO05-HY	03CH07-HY

Note: The test site complies with ANSI C63.4 2009 requirement.

1.7 Applicable Standards

According to the specifications of the manufacturer, the EUT must comply with the requirements of the following standards:

- FCC Part 15 Subpart E
- FCC KDB 789033 D02 General UNII Test Procedures New Rules v01
- FCC KDB 662911 D01 Multiple Transmitter Output v02r01.
- FCC KDB 644545 D03 Guidance for IEEE 802 11ac New Rules v01
- ANSI C63.10-2009

Remark:

1. All test items were verified and recorded according to the standards and without any deviation during the test.
2. FCC permits the use of the 1.5 meter table as an alternative in C63.10-2013 through inquiry tracking number 961829.
3. This EUT has also been tested and complied with the requirements of FCC Part 15, Subpart B, recorded in a separate test report.



2 Test Configuration of Equipment Under Test

The EUT has been associated with peripherals and configuration operated in a manner tended to maximize its emission characteristics in a typical application. Frequency range investigated: conducted emission (150 kHz to 30 MHz) and radiated emission (9 kHz to the 10th harmonic of the highest fundamental frequency or to 40 GHz, whichever is lower).

The final configuration from all the combinations and the worst-case data rates were investigated by measuring the maximum power across all the data rates and modulation modes under section 2.2.

Based on the worst configuration found above, the RF power setting is set individually to meet FCC compliance limit for the final conducted and radiated tests shown in section 2.3.

2.1 Carrier Frequency and Channel

Frequency Band	Channel	Freq. (MHz)	Channel	Freq. (MHz)
5250-5350 MHz Band 2 (U-NII-2A)	52	5260	60	5300
	54	5270	62	5310
	56	5280	64	5320
	58	5290		

Frequency Band	Channel	Freq. (MHz)	Channel	Freq. (MHz)
5470-5725MHz Band 3 (U-NII-2C)	100	5500	120	5600
	102	5510	122	5610
	104	5520	124	5620
	106	5530	126	5630
	108	5540	128	5640
	110	5550	132	5660
	112	5560	134	5670
	116	5580	136	5680
	118	5590	140	5700

Note: The above Frequency and Channel in boldface were 802.11n HT40.



2.2 Pre-Scanned RF Power

Preliminary tests were performed in different data rate and data rate associated with the highest power were chosen for full test in the following tables.

<Ant. 1>

5GHz 802.11a mode			
Data Rate (MHz)	6M bps		
Channel	52	60	64
Average Power (dBm)	11.87	11.72	11.69

5GHz 802.11a mode			
Data Rate (MHz)	6M bps		
Channel	100	116	140
Average Power (dBm)	11.69	11.47	11.23

5GHz 802.11n HT20 mode			
Data Rate (MHz)	MCS0		
Channel	52	60	64
Average Power (dBm)	11.59	11.80	11.96

5GHz 802.11n HT20 mode			
Data Rate (MHz)	MCS0		
Channel	100	116	140
Average Power (dBm)	11.95	11.57	11.36

5GHz 802.11n HT40 mode		
Data Rate (MHz)	MCS0	
Channel	54	62
Average Power (dBm)	13.60	13.52

5GHz 802.11n HT40 mode			
Data Rate (MHz)	MCS0		
Channel	102	110	134
Average Power (dBm)	13.37	13.17	12.40



5GHz 802.11ac VHT20 mode			
Data Rate (MHz)	MCS0		
Channel	52	60	64
Average Power (dBm)	11.70	11.97	12.00

5GHz 802.11ac VHT20 mode			
Data Rate (MHz)	MCS0		
Channel	100	116	140
Average Power (dBm)	11.99	11.72	11.44

5GHz 802.11ac VHT40 mode		
Data Rate (MHz)	MCS0	
Channel	54	62
Average Power (dBm)	13.66	11.87

5GHz 802.11ac VHT40 mode			
Data Rate (MHz)	MCS0		
Channel	102	110	134
Average Power (dBm)	13.40	13.23	12.47

5GHz 802.11ac VHT80 mode	
Data Rate (MHz)	MCS0
Channel	58
Average Power (dBm)	8.96

5GHz 802.11ac VHT80 mode		
Data Rate (MHz)	MCS0	
Channel	106	122
Average Power (dBm)	9.46	12.40



<Ant. 2>

5GHz 802.11a mode			
Data Rate (MHz)	6M bps		
Channel	52	60	64
Average Power (dBm)	11.81	11.85	11.67

5GHz 802.11a mode			
Data Rate (MHz)	6M bps		
Channel	100	116	140
Average Power (dBm)	11.83	11.38	11.21

5GHz 802.11n HT20 mode			
Data Rate (MHz)	MCS0		
Channel	52	60	64
Average Power (dBm)	11.49	11.57	11.84

5GHz 802.11n HT20 mode			
Data Rate (MHz)	MCS0		
Channel	100	116	140
Average Power (dBm)	12.03	11.40	11.95

5GHz 802.11n HT40 mode			
Data Rate (MHz)	MCS0		
Channel	54	62	
Average Power (dBm)	13.46	13.50	

5GHz 802.11n HT40 mode			
Data Rate (MHz)	MCS0		
Channel	102	110	134
Average Power (dBm)	12.76	12.98	12.10



5GHz 802.11ac VHT20 mode			
Data Rate (MHz)	MCS0		
Channel	52	60	64
Average Power (dBm)	11.66	11.60	11.92

5GHz 802.11ac VHT20 mode			
Data Rate (MHz)	MCS0		
Channel	100	116	140
Average Power (dBm)	12.10	11.54	12.00

5GHz 802.11ac VHT40 mode		
Data Rate (MHz)	MCS0	
Channel	54	62
Average Power (dBm)	13.39	11.69

5GHz 802.11ac VHT40 mode			
Data Rate (MHz)	MCS0		
Channel	102	110	134
Average Power (dBm)	12.78	13.01	12.16

5GHz 802.11ac VHT80 mode	
Data Rate (MHz)	MCS0
Channel	58
Average Power (dBm)	8.68

5GHz 802.11ac VHT80 mode		
Data Rate (MHz)	MCS0	
Channel	106	122
Average Power (dBm)	9.21	12.01



<Ant. 3>

5GHz 802.11a mode			
Data Rate (MHz)	6M bps		
Channel	52	60	64
Average Power (dBm)	11.39	11.34	11.85

5GHz 802.11a mode			
Data Rate (MHz)	6M bps		
Channel	100	116	140
Average Power (dBm)	11.79	11.77	11.44

5GHz 802.11n HT20 mode			
Data Rate (MHz)	MCS0		
Channel	52	60	64
Average Power (dBm)	11.42	11.50	11.95

5GHz 802.11n HT20 mode			
Data Rate (MHz)	MCS0		
Channel	100	116	140
Average Power (dBm)	12.06	11.96	11.69

5GHz 802.11n HT40 mode			
Data Rate (MHz)	MCS0		
Channel	54	62	
Average Power (dBm)	13.83	13.63	

5GHz 802.11n HT40 mode			
Data Rate (MHz)	MCS0		
Channel	102	110	134
Average Power (dBm)	13.35	13.36	12.76



5GHz 802.11ac VHT20 mode			
Data Rate (MHz)	MCS0		
Channel	52	60	64
Average Power (dBm)	11.64	11.59	12.09

5GHz 802.11ac VHT20 mode			
Data Rate (MHz)	MCS0		
Channel	100	116	140
Average Power (dBm)	12.13	12.10	11.73

5GHz 802.11ac VHT40 mode		
Data Rate (MHz)	MCS0	
Channel	54	62
Average Power (dBm)	13.88	11.99

5GHz 802.11ac VHT40 mode			
Data Rate (MHz)	MCS0		
Channel	102	110	134
Average Power (dBm)	13.42	13.41	12.82

5GHz 802.11ac VHT80 mode	
Data Rate (MHz)	MCS0
Channel	58
Average Power (dBm)	8.71

5GHz 802.11ac VHT80 mode		
Data Rate (MHz)	MCS0	
Channel	106	122
Average Power (dBm)	9.83	12.61



<Ant. 4>

5GHz 802.11a mode			
Data Rate (MHz)	6M bps		
Channel	52	60	64
Average Power (dBm)	11.75	11.53	11.73

5GHz 802.11a mode			
Data Rate (MHz)	6M bps		
Channel	100	116	140
Average Power (dBm)	11.57	11.00	11.10

5GHz 802.11n HT20 mode			
Data Rate (MHz)	MCS0		
Channel	52	60	64
Average Power (dBm)	11.50	11.71	11.58

5GHz 802.11n HT20 mode			
Data Rate (MHz)	MCS0		
Channel	100	116	140
Average Power (dBm)	11.67	11.75	11.40

5GHz 802.11n HT40 mode			
Data Rate (MHz)	MCS0		
Channel	54	62	
Average Power (dBm)	13.46	13.07	

5GHz 802.11n HT40 mode			
Data Rate (MHz)	MCS0		
Channel	102	110	134
Average Power (dBm)	12.66	12.58	11.97



5GHz 802.11ac VHT20 mode			
Data Rate (MHz)	MCS0		
Channel	52	60	64
Average Power (dBm)	11.65	11.82	11.65

5GHz 802.11ac VHT20 mode			
Data Rate (MHz)	MCS0		
Channel	100	116	140
Average Power (dBm)	11.80	11.89	11.44

5GHz 802.11ac VHT40 mode		
Data Rate (MHz)	MCS0	
Channel	54	62
Average Power (dBm)	13.44	11.54

5GHz 802.11ac VHT40 mode			
Data Rate (MHz)	MCS0		
Channel	102	110	134
Average Power (dBm)	12.72	12.70	12.06

5GHz 802.11ac VHT80 mode	
Data Rate (MHz)	MCS0
Channel	58
Average Power (dBm)	8.60

5GHz 802.11ac VHT80 mode		
Data Rate (MHz)	MCS0	
Channel	106	122
Average Power (dBm)	9.14	11.80



<Ant. 5>

5GHz 802.11a mode			
Data Rate (MHz)	6M bps		
Channel	52	60	64
Average Power (dBm)	12.60	12.42	13.13

5GHz 802.11a mode			
Data Rate (MHz)	6M bps		
Channel	100	116	140
Average Power (dBm)	13.19	12.90	12.58

5GHz 802.11n HT20 mode			
Data Rate (MHz)	MCS0		
Channel	52	60	64
Average Power (dBm)	13.47	13.32	13.60

5GHz 802.11n HT20 mode			
Data Rate (MHz)	MCS0		
Channel	100	116	140
Average Power (dBm)	13.80	13.03	12.98

5GHz 802.11n HT40 mode			
Data Rate (MHz)	MCS0		
Channel	54	62	
Average Power (dBm)	12.38	12.46	

5GHz 802.11n HT40 mode			
Data Rate (MHz)	MCS0		
Channel	102	110	134
Average Power (dBm)	12.77	13.08	12.60



5GHz 802.11ac VHT20 mode			
Data Rate (MHz)	MCS0		
Channel	52	60	64
Average Power (dBm)	13.50	13.39	13.66

5GHz 802.11ac VHT20 mode			
Data Rate (MHz)	MCS0		
Channel	100	116	140
Average Power (dBm)	13.90	13.10	13.03

5GHz 802.11ac VHT40 mode		
Data Rate (MHz)	MCS0	
Channel	54	62
Average Power (dBm)	12.43	12.58

5GHz 802.11ac VHT40 mode			
Data Rate (MHz)	MCS0		
Channel	102	110	134
Average Power (dBm)	12.80	13.11	12.73

5GHz 802.11ac VHT80 mode	
Data Rate (MHz)	MCS0
Channel	58
Average Power (dBm)	6.74

5GHz 802.11ac VHT80 mode		
Data Rate (MHz)	MCS0	
Channel	106	122
Average Power (dBm)	9.21	13.38



<Ant. 1 + 2 + 3 + 4 + 5>

5GHz 802.11a mode			
Data Rate (MHz)	6M bps		
Channel	52	60	64
Average Power (dBm)	18.89	18.78	19.04

5GHz 802.11a mode			
Data Rate (MHz)	6M bps		
Channel	100	116	140
Average Power (dBm)	19.05	18.74	18.54

5GHz 802.11n HT20 mode			
Data Rate (MHz)	MCS0		
Channel	52	60	64
Average Power (dBm)	18.96	19.03	19.24

5GHz 802.11n HT20 mode			
Data Rate (MHz)	MCS0		
Channel	100	116	140
Average Power (dBm)	19.36	18.97	18.91

5GHz 802.11n HT40 mode		
Data Rate (MHz)	MCS0	
Channel	54	62
Average Power (dBm)	20.36	20.25

5GHz 802.11n HT40 mode			
Data Rate (MHz)	MCS0		
Channel	102	110	134
Average Power (dBm)	19.98	20.03	19.37



5GHz 802.11ac VHT20 mode			
Data Rate (MHz)	MCS0		
Channel	52	60	64
Average Power (dBm)	19.09	19.12	19.32

5GHz 802.11ac VHT20 mode			
Data Rate (MHz)	MCS0		
Channel	100	116	140
Average Power (dBm)	19.45	19.10	18.96

5GHz 802.11ac VHT40 mode		
Data Rate (MHz)	MCS0	
Channel	54	62
Average Power (dBm)	20.38	18.94

5GHz 802.11ac VHT40 mode			
Data Rate (MHz)	MCS0		
Channel	102	110	134
Average Power (dBm)	20.03	20.09	19.45

5GHz 802.11ac VHT80 mode	
Data Rate (MHz)	MCS0
Channel	58
Average Power (dBm)	15.40

5GHz 802.11ac VHT80 mode		
Data Rate (MHz)	MCS0	
Channel	106	122
Average Power (dBm)	16.37	19.47

Note: MIMO Ant. 1 + 2 + 3 + 4 + 5 is a calculated result from sum of the power MIMO Ant. 1, MIMO Ant. 2, MIMO Ant. 3, MIMO Ant. 4, and MIMO Ant. 5.



2.3 Test Mode

Final test mode of conducted test items and radiated spurious emissions are considering the modulation and worse data rates from the power table described in section 2.2.

MIMO Antenna

Modulation	Data Rate
802.11a	6 Mbps
802.11n HT20	MCS0
802.11n HT40	MCS0
802.11ac VHT20	MCS0
802.11ac VHT40	MCS0
802.11ac VHT80	MCS0

AC Conducted Emission	Mode 1 : WLAN (2.4GHz) Link + WLAN (5GHz) Link + WAN Link + LAN Link + Adapter
-----------------------	--

Ch. #		Band II : 5250-5350 MHz	Band III : 5470- 5725MHz
		802.11a	802.11a
L	Low	52	100
M	Middle	60	116
H	High	64	140

Ch. #		Band II : 5250-5350 MHz	Band III : 5470- 5725MHz
		802.11n HT20	802.11n HT20
L	Low	52	100
M	Middle	60	116
H	High	64	140

Ch. #		Band II : 5250-5350 MHz	Band III : 5470- 5725MHz
		802.11n HT40	802.11n HT40
L	Low	54	102
M	Middle	-	110
H	High	62	134



Ch. #		Band II : 5250-5350 MHz	Band III : 5470-5725MHz
		802.11ac VHT20	802.11ac VHT20
L	Low	52	100
M	Middle	60	116
H	High	64	140

Ch. #		Band II : 5250-5350 MHz	Band III : 5470-5725MHz
		802.11ac VHT40	802.11ac VHT40
L	Low	54	102
M	Middle	-	110
H	High	62	134

Ch. #		Band II : 5250-5350 MHz	Band III : 5470-5725MHz
		802.11ac VHT80	802.11ac VHT80
L	Low	-	106
M	Middle	58	-
H	High	-	122

2.4 Connection Diagram of Test System

<WLAN Tx Mode>

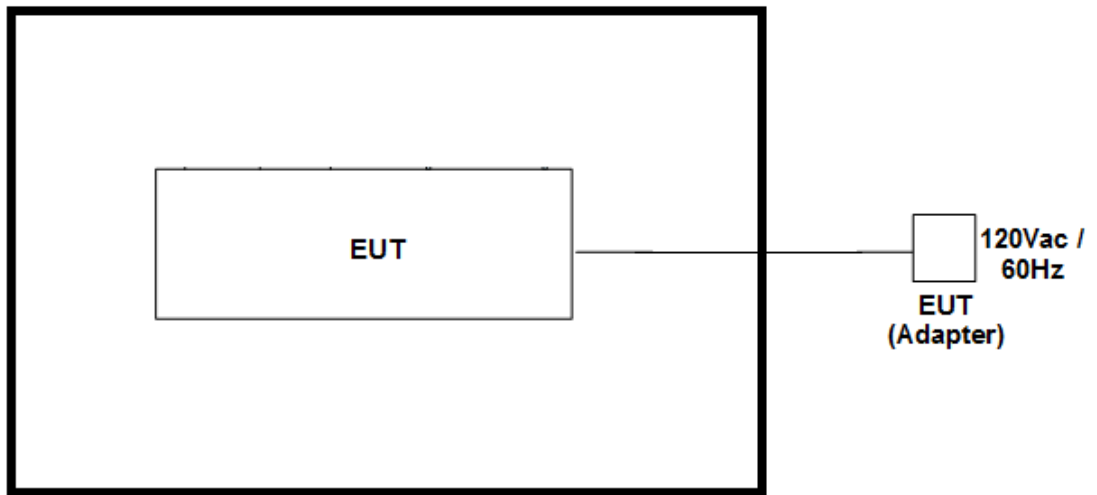

<AC Conducted Emission Mode>

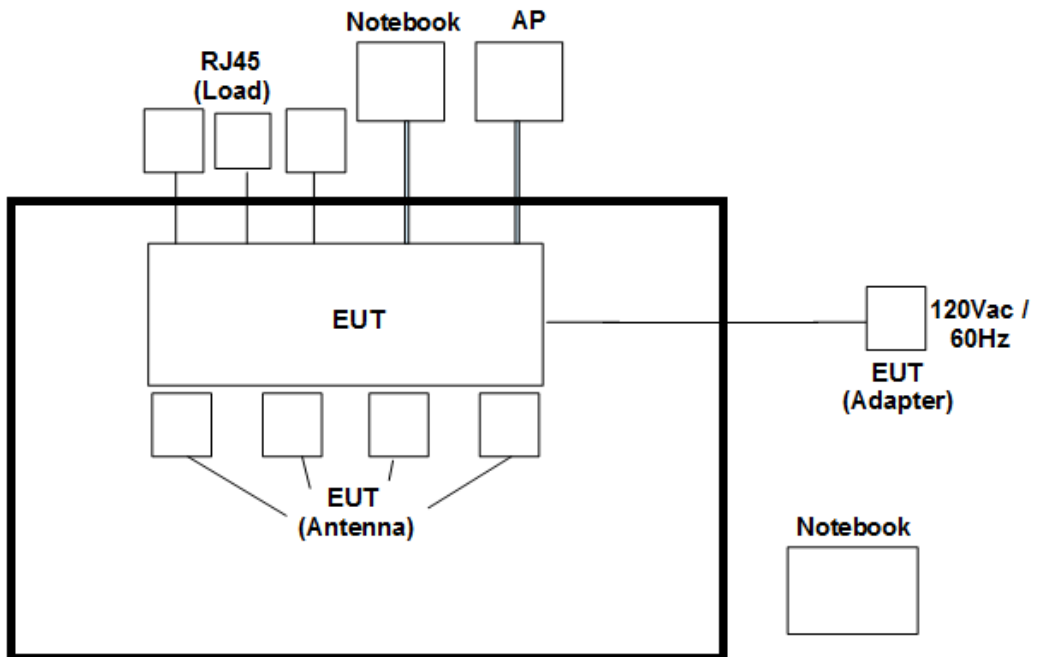



2.5 Support Unit used in test configuration and system

Item	Equipment	Trade Name	Model Name	FCC ID	Data Cable	Power Cord
1.	WLAN AP	D-Link	DIR-865L	KA2IR865LA1	N/A	Unshielded, 1.8 m
2.	Notebook	DELL	P20G	FCC DoC/ Contains FCC ID: QDS-BRCM1051	N/A	AC I/P: Unshielded, 1.2 m DC O/P: Shielded, 1.8 m
3.	Notebook	DELL	Latitude E6320	FCC DoC/ Contains FCC ID: QDS-BRCM1054	N/A	AC I/P: Unshielded, 1.2 m DC O/P: Shielded, 1.8 m

2.6 EUT Operation Test Setup

The programmed RF utility “CMD”, is installed in EUT to provide channel selection, power level, data rate and the application type. RF Utility can send transmitting signal for all testing. The RF output power selection is for the setting of RF output power expected by the customer and is going to be fixed on the firmware of the final end product.



2.7 Measurement Results Explanation Example

For all conducted test items:

The offset level is set in the spectrum analyzer to compensate the RF cable loss and attenuator factor between EUT conducted output port and spectrum analyzer. With the offset compensation, the spectrum analyzer reading level is exactly the EUT RF output level.

Example :

The spectrum analyzer offset is derived from RF cable loss and attenuator factor.

Offset = RF cable loss + attenuator factor.

Following shows an offset computation example with cable loss 4.2 dB and 10dB attenuator.

$$\begin{aligned} \text{Offset(dB)} &= \text{RF cable loss(dB)} + \text{attenuator factor(dB)}. \\ &= 4.2 + 10 = 14.2 \text{ (dB)} \end{aligned}$$

3 Test Result

3.1 26dB & 99% Bandwidth Measurement

3.1.1 Description of 26dB & 99% Occupied Bandwidth

This section is for reporting purpose only.

There is no restriction limits for bandwidth.

3.1.2 Measuring Instruments

The measuring equipment is listed in the section 4 of this test report.

3.1.3 Test Procedures

1. The testing follows FCC KDB 789033 D02 General UNII Test Procedures New Rules v01.
Section C) Emission bandwidth
2. Set RBW = approximately 1% of the emission bandwidth.
3. Set the VBW > RBW.
4. Detector = Peak.
5. Trace mode = max hold
6. Measure the maximum width of the emission that is 26 dB down from the peak of the emission.
Compare this with the RBW setting of the analyzer. Readjust RBW and repeat measurement as needed until the RBW/EBW ratio is approximately 1%.
7. For 99% Bandwidth Measurement, the spectrum analyzer's resolution bandwidth (RBW) is set 1MHz and set the Video bandwidth (VBW) $\geq 3 * RBW$.
8. Measure and record the results in the test report.

3.1.4 Test Setup

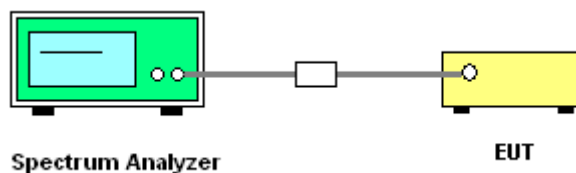



3.1.5 Test Result of 26dB & 99% Occupied Bandwidth

Please refer to Appendix A.

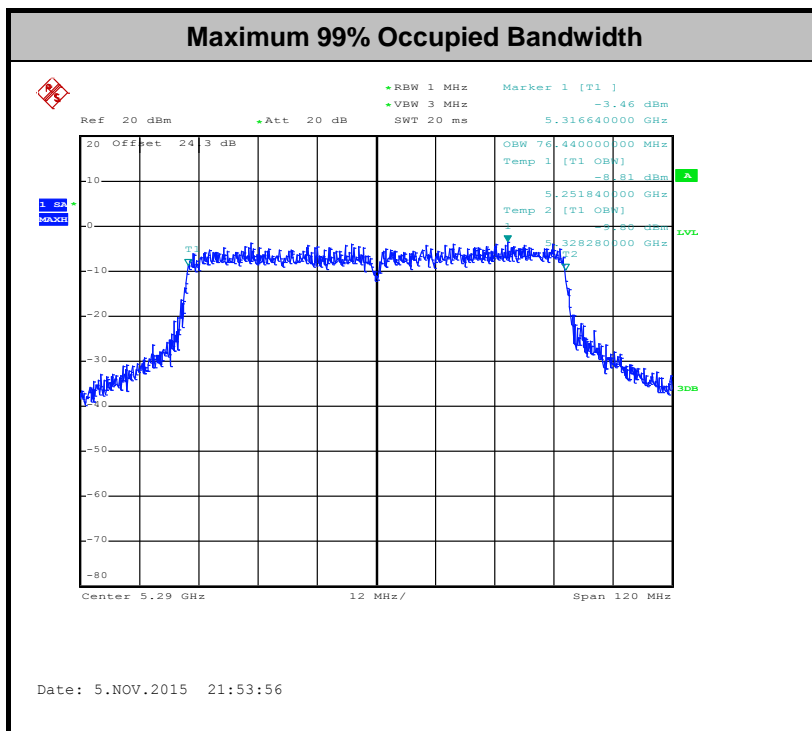
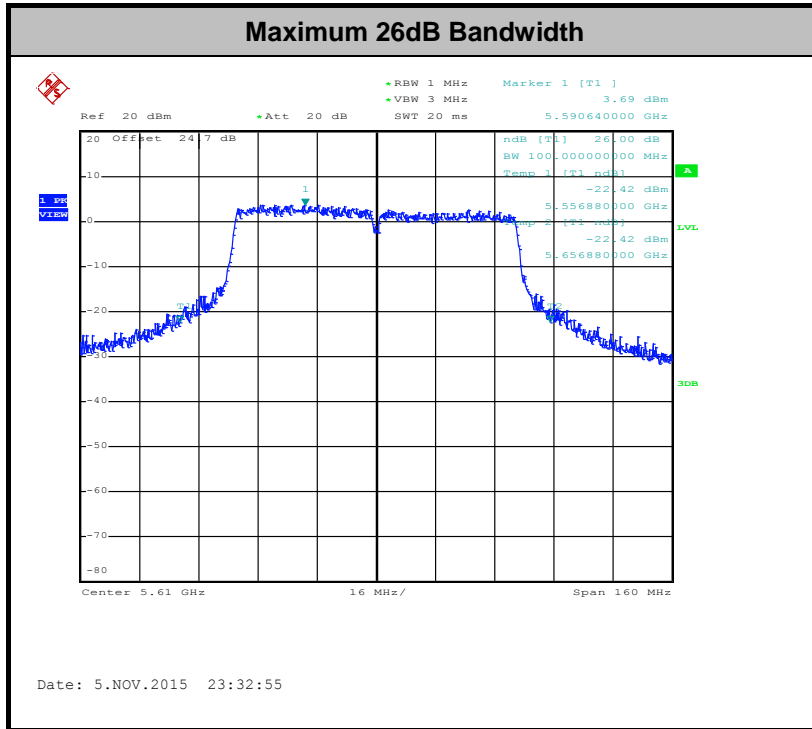



3.2 Maximum Conducted Output Power Measurement

3.2.1 Limit of Maximum Conducted Output Power

<FCC 14-30 CFR 15.407>

For the 5.25–5.35 GHz and 5.47–5.725 GHz bands, the maximum conducted output power over the frequency bands of operation shall not exceed the lesser of 250 mW or 11 dBm 10 log B, where B is the 26 dB emission bandwidth in megahertz.

If transmitting antennas of directional gain greater than 6 dBi are used, the peak output power shall be reduced by the amount in dB that the directional gain of the antenna exceeds 6 dBi.

Note that U-NII-2 band, devices with a maximum e.i.r.p. greater than 500 mW shall implement TPC in order to have the capability to operate at least 6 dB below the maximum permitted e.i.r.p. of 1 W.

3.2.2 Measuring Instruments

The measuring equipment is listed in the section 4 of this test report.

3.2.3 Test Procedures

The testing follows Method PM of FCC KDB 789033 D02 General UNII Test Procedures New Rules v01.

Method PM (Measurement using an RF average power meter):

1. Measurement is performed using a wideband RF power meter.
2. The EUT is configured to transmit continuously with a consistent duty cycle at its maximum power control level.
3. Measure the average power of the transmitter, and the average power is corrected with duty factor, $10 \log(1/x)$, where x is the duty cycle.

3.2.4 Test Setup

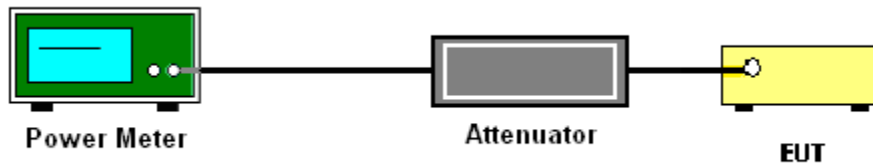

3.2.5 Test Result of Maximum Conducted Output Power

Please refer to Appendix A.



3.3 Power Spectral Density Measurement

3.3.1 Limit of Power Spectral Density

<FCC 14-30 CFR 15.407>

For the 5.25–5.35 GHz and 5.47–5.725 GHz bands, the maximum power spectral density shall not exceed 11 dBm in any 1 megahertz band.

If transmitting antennas of directional gain greater than 6 dBi are used, the peak output power shall be reduced by the amount in dB that the directional gain of the antenna exceeds 6 dBi.

3.3.2 Measuring Instruments

The measuring equipment is listed in the section 4 of this test report.

3.3.3 Test Procedures

The testing follows FCC KDB 789033 D02 General UNII Test Procedures New Rules v01.
Section F) Maximum power spectral density.

Method SA-2

(trace averaging across on and off times of the EUT transmissions, followed by duty cycle correction).

1. The testing follows Method SA-2 of FCC KDB 789033 D02 General UNII Test Procedures New Rules v01.
 - Measure the duty cycle.
 - Set span to encompass the entire emission bandwidth (EBW) of the signal.
 - Set RBW = 1 MHz.
 - Set VBW \geq 3 MHz.
 - Number of points in sweep \geq 2 Span / RBW.
 - Sweep time = auto.
 - Detector = RMS
 - Trace average at least 100 traces in power averaging mode.
 - Add $10 \log(1/x)$, where x is the duty cycle, to the measured power in order to compute the average power during the actual transmission times. For example, add $10 \log(1/0.25) = 6$ dB if the duty cycle is 25 percent.
2. The RF output of EUT was connected to the spectrum analyzer by a low loss cable.
3. Each plot has already offset with cable loss, and attenuator loss. Measure the PPSD and record it.
4. For MIMO mode, calculation method follows FCC KDB 662911 D01 Multiple Transmitter Output v02r01.

Method (1): Measure and sum the spectra across the outputs.

The total final Power Spectral Density is from a device with 2 transmitter outputs. The spectrum measurements of the individual outputs are all performed with the same span and number of points, the spectrum value in the first spectral bin of output 1 is summed with that in the first spectral bin of output 2 to obtain the value for the first frequency bin of the summed spectrum.

3.3.4 Test Setup

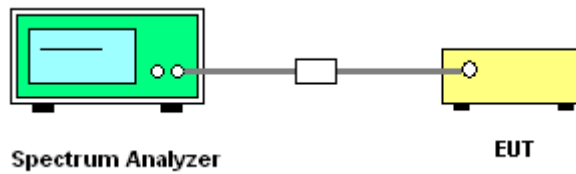

3.3.5 Test Result of Power Spectral Density

Please refer to Appendix A.

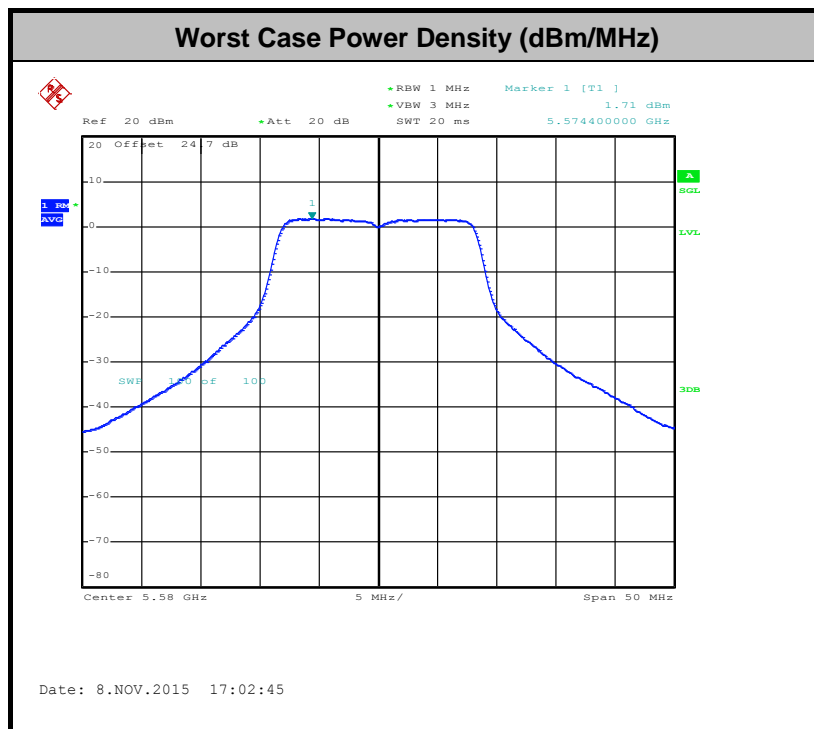



3.4 Unwanted Emissions Measurement

This section as specified in FCC Part 15.407(b) is to measure unwanted emissions through radiated measurement for band edge spurious emissions and out of band emissions measurement. The unwanted emissions shall comply with 15.407(b)(1) to (6), and restricted bands per FCC Part15.205.

3.4.1 Limit of Unwanted Emissions

(1) For transmitters operating in the 5250-5350 MHz band: all emissions outside of the 5150-5350 MHz band shall not exceed an EIRP of -27 dBm/MHz. Devices operating in the 5250-5350 MHz band that generate emissions in the 5150-5250 MHz band must meet all applicable technical requirements for operation in the 5150-5250 MHz band (including indoor use) or alternatively meet an out-of-band emission EIRP limit of -27 dBm/MHz in the 5150-5250 MHz band.

For transmitters operating in the 5470-5725 MHz band: all emissions outside of the 5470-5725 MHz band shall not exceed an EIRP of -27 dBm/MHz.

(2) Unwanted spurious emissions fallen in restricted bands per FCC Part15.205 shall comply with the general field strength limits set forth in § 15.209 as below table,

Frequency (MHz)	Field Strength (microvolts/meter)	Measurement Distance (meters)
0.009 – 0.490	2400/F(kHz)	300
0.490 – 1.705	24000/F(kHz)	30
1.705 – 30.0	30	30
30 – 88	100	3
88 – 216	150	3
216 - 960	200	3
Above 960	500	3

Note: The following formula is used to convert the EIRP to field strength.

$$E = \frac{1000000\sqrt{30P}}{3} \mu\text{V/m, where P is the eirp (Watts)}$$

EIRP (dBm)	Field Strength at 3m (dBµV/m)
-17	78.3
- 27	68.3

(3) KDB789033 v01 G)2)c) As specified in 15.407(b), emissions above 1000 MHz that are outside of the restricted bands are subject to a peak emission limit of -27 dBm/MHz (or -17 dBm/MHz as specified in 15.407(b)(4)). However, an out-of-band emission that complies with both the average and peak limits of 15.209 is not required to satisfy the -27 dBm/MHz or -17 dBm/MHz peak



emission limit.

3.4.2 Measuring Instruments

The measuring equipment is listed in the section 4 of this test report.



3.4.3 Test Procedures

1. The testing follows FCC KDB 789033 D02 General UNII Test Procedures New Rules v01. Section G) Unwanted emissions measurement.

(1) Procedure for Unwanted Emissions Measurements Below 1000MHz

- RBW = 120 kHz
• VBW = 300 kHz
• Detector = Peak
• Trace mode = max hold

(2) Procedure for Peak Unwanted Emissions Measurements Above 1000 MHz

- RBW = 1 MHz
• VBW ≥ 3 MHz
• Detector = Peak
• Sweep time = auto
• Trace mode = max hold

(3) Procedures for Average Unwanted Emissions Measurements Above 1000MHz

- RBW = 1 MHz
• VBW = 10 Hz, when duty cycle is no less than 98 percent.
• VBW ≥ 1/T, when duty cycle is less than 98 percent where T is the minimum transmission duration over which the transmitter is on and is transmitting at its maximum power control level for the tested mode of operation.

Table with 6 columns: Antenna, Band, Duty Cycle(%), T(us), 1/T(kHz), VBW Setting. Rows include configurations for 5TX antennas across various bands (802.11a, 802.11ac VHT20, VHT40, VHT80) with specific duty cycle, T, and VBW settings.

- 2. The EUT was placed on a turntable with 0.8 meter for frequency below 1GHz and 1.5 meter for frequency above 1GHz respectively above ground.
3. The EUT was set 3 meters from the interference receiving antenna which was mounted on the top of a variable height antenna tower.
4. The antenna is a broadband antenna and its height is adjusted between one meter and four meters above ground to find the maximum value of the field strength for both horizontal polarization and vertical polarization of the antenna.
5. For each suspected emission, the EUT was arranged to its worst case and then adjust the antenna tower (from 1 m to 4 m) and turntable (from 0 degree to 360 degrees) to find the maximum reading.

6. For testing below 1GHz, if the emission level of the EUT in peak mode was 3 dB lower than the limit specified, then peak values of EUT will be reported, otherwise, the emissions will be repeated one by one using the CISPR quasi-peak method and reported.
7. For testing above 1GHz, the emission level of the EUT in peak mode was 20dB lower than average limit (that means the emission level in average mode also complies with the limit in average mode), then peak values of EUT will be reported, otherwise, the emissions will be measured in average mode again and reported.

3.4.4 Test Setup

For radiated emissions below 30MHz

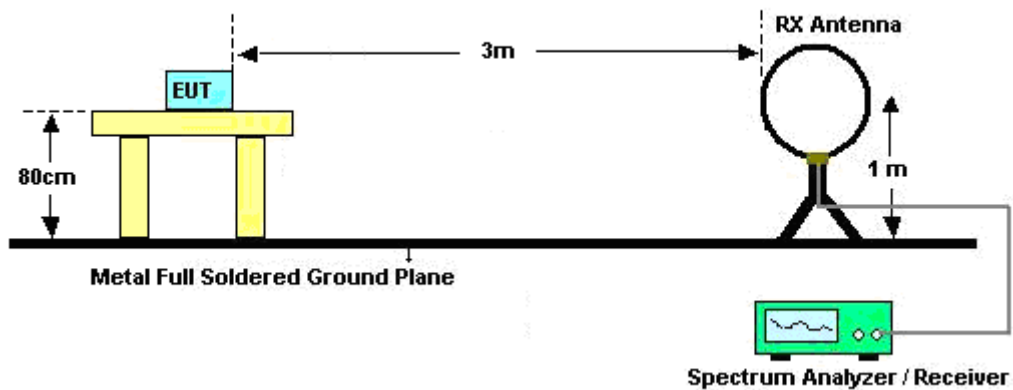

For radiated emissions from 30MHz to 1GHz

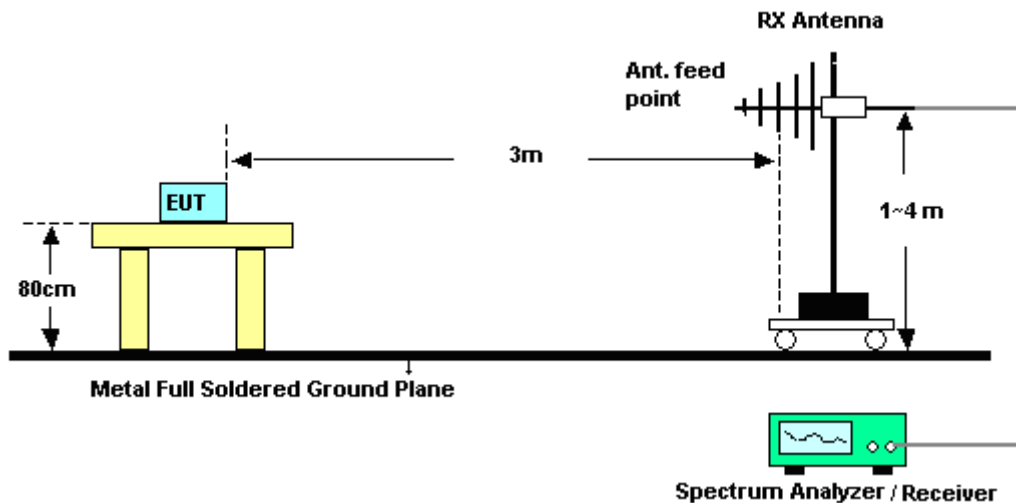

For radiated emissions above 1GHz

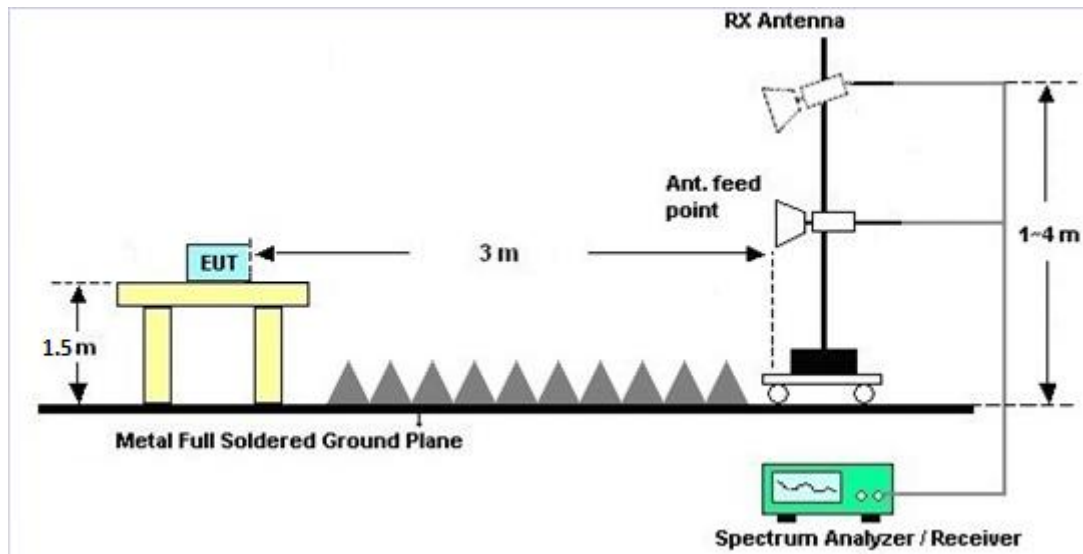

3.4.5 Test Results of Radiated Emissions (9 kHz ~ 30 MHz)

The low frequency, which started from 9 kHz to 30MHz, was pre-scanned and the result which was 20dB lower than the limit line per 15.31(o) was not reported.

3.4.6 Test Result of Radiated Band Edges

Please refer to Appendix A and B.

3.4.7 Test Result of Unwanted Radiated Emission (30MHz ~ 10th Harmonic)

Please refer to Appendix A and B.



3.5 AC Conducted Emission Measurement

3.5.1 Limit of AC Conducted Emission

For equipment that is designed to be connected to the public utility (AC) power line, the radio frequency voltage that is conducted back onto the AC power line on any frequency or frequencies within the band 150 kHz to 30 MHz shall not exceed the limits in the following table.

Frequency of emission (MHz)	Conducted limit (dB μ V)	
	Quasi-peak	Average
0.15-0.5	66 to 56*	56 to 46*
0.5-5	56	46
5-30	60	50

*Decreases with the logarithm of the frequency.

3.5.2 Measuring Instruments

The measuring equipment is listed in the section 4 of this test report.

3.5.3 Test Procedures

1. The EUT was placed 0.4 meter from the conducting wall of the shielding room was kept at least 80 centimeters from any other grounded conducting surface.
2. Connect EUT to the power mains through a line impedance stabilization network (LISN).
3. All the support units are connecting to the other LISN.
4. The LISN provides 50 ohm coupling impedance for the measuring instrument.
5. The FCC states that a 50 ohm, 50 microhenry LISN should be used.
6. Both sides of AC line were checked for maximum conducted interference.
7. The frequency range from 150 kHz to 30 MHz was searched.
8. Set the test-receiver system to Peak Detect Function and specified bandwidth with Maximum Hold Mode.

3.5.4 Test Setup

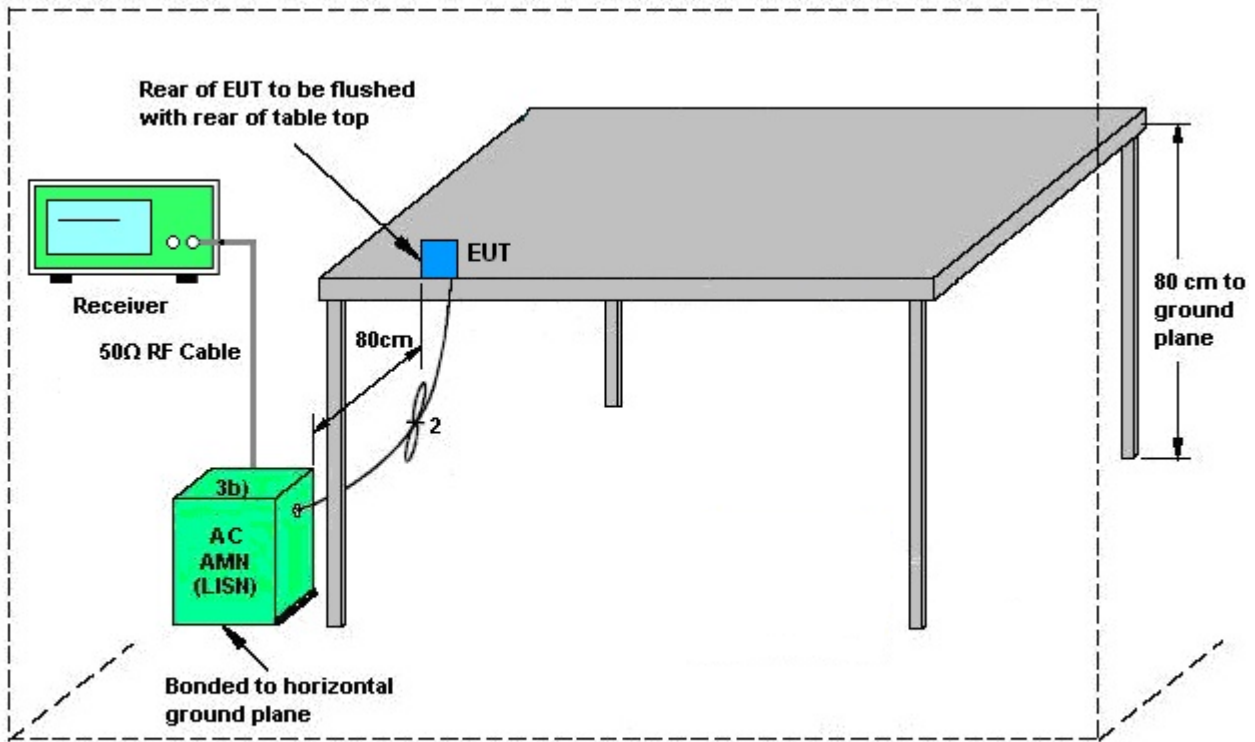

AMN = Artificial mains network (LISH)
 AE = Associated equipment
 EUT = Equipment under test
 ISN = Impedance stabilization network

3.5.5 Test Result of AC Conducted Emission

Test Mode :	Mode 1	Temperature :	25~26°C
Test Engineer :	Derreck Chen	Relative Humidity :	61~62%
Test Voltage :	120Vac / 60Hz	Phase :	Line
Function Type :	WLAN (2.4GHz) Link + WLAN (5GHz) Link + WAN Link + LAN Link + Adapter		

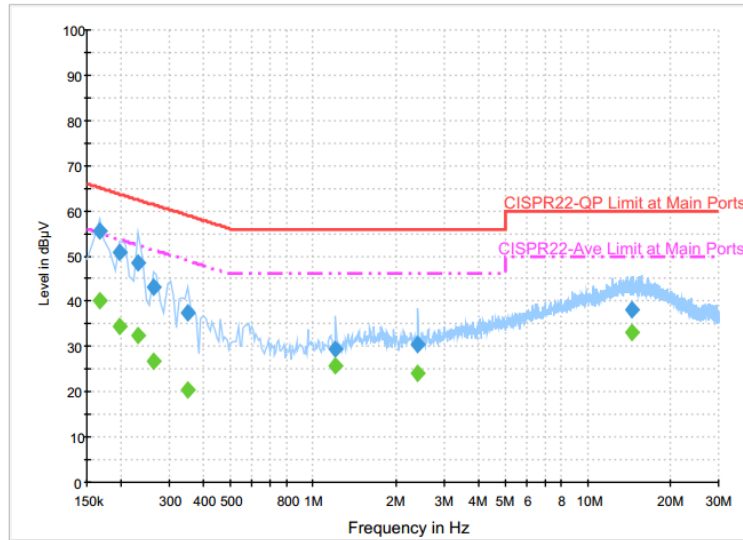

Final Result : QuasiPeak

Frequency (MHz)	QuasiPeak (dBµV)	Filter	Line	Corr. (dB)	Margin (dB)	Limit (dBµV)
0.166000	55.6	Off	L1	19.5	9.6	65.2
0.198000	50.7	Off	L1	19.5	13.0	63.7
0.230000	48.6	Off	L1	19.6	13.8	62.4
0.262000	43.2	Off	L1	19.5	18.2	61.4
0.350000	37.3	Off	L1	19.5	21.7	59.0
1.206000	29.4	Off	L1	19.6	26.6	56.0
2.414000	30.5	Off	L1	19.6	25.5	56.0
14.582000	38.1	Off	L1	19.9	21.9	60.0

Final Result : Average

Frequency (MHz)	Average (dBµV)	Filter	Line	Corr. (dB)	Margin (dB)	Limit (dBµV)
0.166000	40.3	Off	L1	19.5	14.9	55.2
0.198000	34.3	Off	L1	19.5	19.4	53.7
0.230000	32.6	Off	L1	19.6	19.8	52.4
0.262000	26.7	Off	L1	19.5	24.7	51.4
0.350000	20.5	Off	L1	19.5	28.5	49.0
1.206000	25.9	Off	L1	19.6	20.1	46.0
2.414000	24.0	Off	L1	19.6	22.0	46.0
14.582000	33.2	Off	L1	19.9	16.8	50.0



Test Mode :	Mode 1	Temperature :	25~26°C
Test Engineer :	Derreck Chen	Relative Humidity :	61~62%
Test Voltage :	120Vac / 60Hz	Phase :	Neutral
Function Type :	WLAN (2.4GHz) Link + WLAN (5GHz) Link + WAN Link + LAN Link + Adapter		

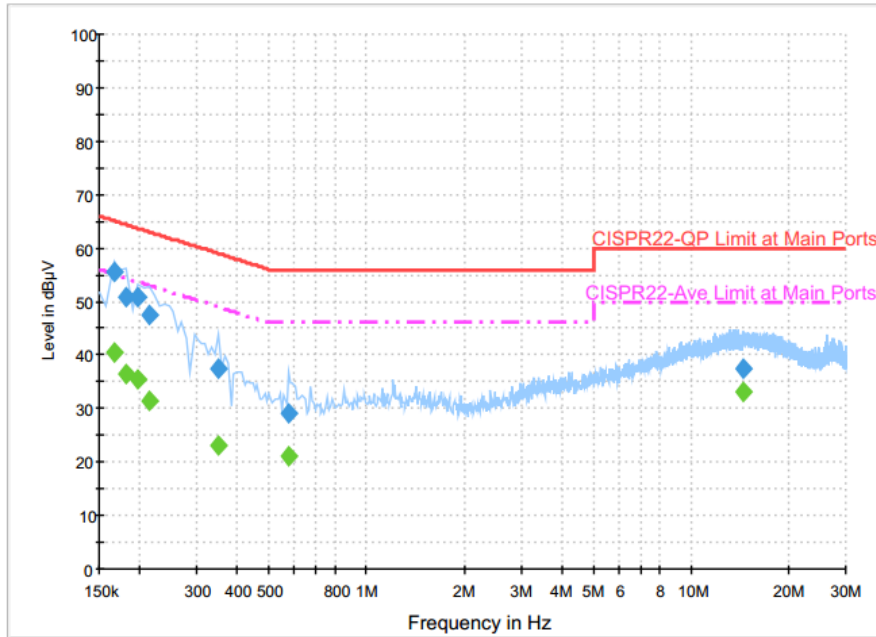

Final Result : QuasiPeak

Frequency (MHz)	QuasiPeak (dBµV)	Filter	Line	Corr. (dB)	Margin (dB)	Limit (dBµV)
0.166000	55.4	Off	N	19.5	9.8	65.2
0.182000	51.0	Off	N	19.6	13.4	64.4
0.198000	50.9	Off	N	19.5	12.8	63.7
0.214000	47.6	Off	N	19.6	15.4	63.0
0.350000	37.6	Off	N	19.5	21.4	59.0
0.574000	29.0	Off	N	19.5	27.0	56.0
14.510000	37.6	Off	N	19.9	22.4	60.0

Final Result : Average

Frequency (MHz)	Average (dBµV)	Filter	Line	Corr. (dB)	Margin (dB)	Limit (dBµV)
0.166000	40.4	Off	N	19.5	14.8	55.2
0.182000	36.6	Off	N	19.6	17.8	54.4
0.198000	35.4	Off	N	19.5	18.3	53.7
0.214000	31.4	Off	N	19.6	21.6	53.0
0.350000	23.2	Off	N	19.5	25.8	49.0
0.574000	20.9	Off	N	19.5	25.1	46.0
14.510000	33.1	Off	N	19.9	16.9	50.0

3.6 Frequency Stability Measurement

3.6.1 Limit of Frequency Stability

Manufacturers of U-NII devices are responsible for ensuring frequency stability such that an emission is maintained within the band of operation under all conditions of normal operation as specified in the user's manual.

3.6.2 Measuring Instruments

The measuring equipment is listed in the section 4 of this test report.

3.6.3 Test Procedures

1. To ensure emission at the band edge is maintained within the authorized band, those values shall be measured by radiation emissions at upper and lower frequency points, and finally compensated by frequency deviation as procedures below.
2. The EUT was operated at the maximum output power, and connected to the spectrum analyzer, which is set to maximum hold function and peak detector. The peak value of the power envelope was measured and noted. The upper and lower frequency points were respectively measured relatively 10dB lower than the measured peak value.
3. The frequency deviation was calculated by adding the upper frequency point and the lower frequency point divided by two. Those detailed values of frequency deviation are provided in table below.

3.6.4 Test Setup

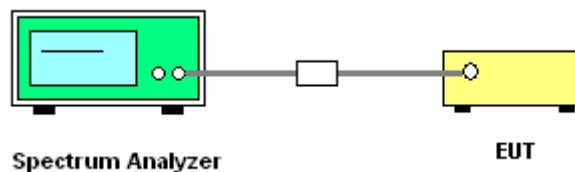

3.6.5 Test Result of Frequency Stability

Please refer to Appendix A.



3.7 Automatically Discontinue Transmission

3.7.1 Limit of Automatically Discontinue Transmission

The device shall automatically discontinue transmission in case of either absence of information to transmit or operational failure. These provisions are not intended to preclude the transmission of control or signaling information or the use of repetitive codes used by certain digital technologies to complete frame or burst intervals. Applicants shall include in their application for equipment authorization to describe how this requirement is met.

3.7.2 Measuring Instruments

The measuring equipment is listed in the section 4 of this test report.

3.7.3 Test Result of Automatically Discontinue Transmission

While the EUT is not transmitting any information, the EUT can automatically discontinue transmission and become standby mode for power saving. The EUT can detect the controlling signal of ACK message transmitting from remote device and verify whether it shall resend or discontinue transmission.



3.8 Antenna Requirements

3.8.1 Standard Applicable

According to FCC 47 CFR Section 15.407(a)(1)(2) ,if transmitting antenna directional gain is greater than 6 dBi, both the peak transmit power and the peak power spectral density shall be reduced by the amount in dB that the directional gain of the antenna exceeds 6 dBi.

3.8.2 Antenna Anti-Replacement Construction

An embedded-in antenna design is used for the FPC antenna.

Non-standard antenna connector (RP-SMA) is used for the external dipole antenna.

3.8.3 Antenna Gain

FCC KDB 662911 D01 Multiple Transmitter Output v02r01

For CDD transmissions, directional gain is calculated as

Directional gain = $G_{ANT} + \text{Array Gain}$, where Array Gain is as follows.

For power spectral density (PSD) measurements on all devices,

Array Gain = $10 \log(N_{ANT}/N_{SS}=1)$ dB.

For power measurements on IEEE 802.11 devices,

Array Gain = 0 dB (i.e., no array gain) for $N_{ANT} \leq 4$.

Array Gain = $5 \log(N_{ANT}/N_{SS})$ dB or **3 dB**, whichever is less

The EUT supports CDD mode.

The power and PSD limit should be modified if the directional gain of EUT is over 6 dBi,

The directional gain "DG" is calculated as following table.

						DG for Power (dBi)	DG for PSD (dBi)	Power Limit Reduction (dB)	PSD Limit Reduction (dB)
	Ant 1 (dBi)	Ant 2 (dBi)	Ant 3 (dBi)	Ant 4 (dBi)	Ant 5 (dBi)				
Band II	2.00	2.00	2.00	2.00	1.00	5.00	8.99	0.00	2.99
Band III	2.00	2.00	2.00	2.00	1.00	5.00	8.99	0.00	2.99

Each antenna gain does not exceed 2dBi, hence the table takes $G_{ANT} = 2\text{dBi}$.

Power limit reduction = Composite gain – 6dBi, (min = 0)

PSD limit reduction = Composite gain + PSD Array gain – 6dBi, (min = 0)



4 List of Measuring Equipment

Instrument	Manufacturer	Model No.	Serial No.	Characteristics	Calibration Date	Test Date	Due Date	Remark
Power Meter	Anritsu	ML2495A	1218006	300MHz~40GHz	Oct. 07, 2015	Nov. 01, 2015~ Nov. 08, 2015	Oct. 06, 2016	Conducted (TH05-HY)
Power Sensor	Anritsu	MA2411B	1207363	300MHz~40GHz	Oct. 07, 2015	Nov. 01, 2015~ Nov. 08, 2015	Oct. 06, 2016	Conducted (TH05-HY)
Spectrum Analyzer	Rohde & Schwarz	FSP40	100055	9kHz-40GHz	Jun. 18, 2015	Nov. 01, 2015~ Nov. 08, 2015	Jun. 17, 2016	Conducted (TH05-HY)
Programmable Power Supply	GW Instek	PSS-2005	EL890089	1V~20V 0.5A~5A	Jan.14, 2015	Nov. 01, 2015~ Nov. 08, 2015	Jan.13, 2016	Conducted (TH05-HY)
Temperature Chamber	ESPEC	SH-641	92013720	-40°~90°	Sep. 08, 2015	Nov. 01, 2015~ Nov. 08, 2015	Sep. 07, 2016	Conducted (TH05-HY)
Bilog Antenna	Teseq GmbH	CBL6112D	35379	30MHz~2GHz	Oct. 15, 2015	Oct. 15, 2015~ Nov. 19, 2015	Oct. 14, 2016	Radiation (03CH07-HY)
Double Ridge Horn Antenna	ESCO	3117	00075962	1GHz ~ 18GHz	Aug. 21, 2015	Oct. 15, 2015~ Nov. 19, 2015	Aug. 20, 2016	Radiation (03CH07-HY)
EMI Test Receiver	Rohde & Schwarz	ESCI 7	100724	9kHz~7GHz	Aug. 26, 2015	Oct. 15, 2015~ Nov. 19, 2015	Aug. 25, 2016	Radiation (03CH07-HY)
Horn Antenna	SCHWARZBECK	BBHA 9170	BBHA917058 4	18GHz- 40GHz	Nov. 01, 2014	Oct. 15, 2015~ Oct. 27, 2015	Nov. 02, 2015	Radiation (03CH07-HY)
Horn Antenna	SCHWARZBECK	BBHA 9170	BBHA917058 4	18GHz- 40GHz	Nov. 02, 2015	Nov. 02, 2015~ Nov. 19, 2015	Nov. 01, 2016	Radiation (03CH07-HY)
Loop Antenna	Rohde & Schwarz	HFH2-Z2	100315	9 kHz~30 MHz	Sep. 02, 2015	Oct. 15, 2015~ Nov. 19, 2015	Sep. 01, 2016	Radiation (03CH07-HY)
Preamplifier	MITEQ	AMF-7D-0010 1800-30-10P	1590075	1GHz ~ 18GHz	Apr. 20, 2015	Oct. 15, 2015~ Nov. 19, 2015	Apr. 19, 2016	Radiation (03CH07-HY)
Preamplifier	COM-POWER	PA-103A	161241	10MHz-1000MHz	Mar. 12, 2015	Oct. 15, 2015~ Nov. 19, 2015	Mar. 11, 2016	Radiation (03CH07-HY)
Preamplifier	Agilent	8449B	3008A02362	1GHz~ 26.5GHz	Oct. 21, 2014	Oct. 15, 2015~ Oct. 13, 2015	Oct. 20, 2015	Radiation (03CH07-HY)
Preamplifier	Agilent	8449B	3008A02362	1GHz~ 26.5GHz	Oct. 19, 2015	Oct. 19, 2015~ Nov. 19, 2015	Oct. 18, 2016	Radiation (03CH07-HY)
Signal Analyzer	Rohde & Schwarz	FSV 30	101749	10Hz~30GHz	Mar. 10, 2015	Oct. 15, 2015~ Nov. 19, 2015	Mar. 09, 2016	Radiation (03CH07-HY)
Antenna Mast	Max-Full	MFA520BS	N/A	1m~4m	N/A	Oct. 15, 2015~ Nov. 19, 2015	N/A	Radiation (03CH07-HY)
Turn Table	ChainTek	Chaintek 3000	N/A	0~360 degree	N/A	Oct. 15, 2015~ Nov. 19, 2015	N/A	Radiation (03CH07-HY)
Preamplifier	MITEQ	JS44-1800400 0-33-8P	1840917	18GHz ~ 40GHz	Jun. 02, 2015	Oct. 15, 2015~ Nov. 19, 2015	Jun. 01, 2016	Radiation (03CH07-HY)
AC Power Source	ChainTek	APC-1000W	N/A	N/A	N/A	Nov. 18, 2015	N/A	Conduction (CO05-HY)
EMI Test Receiver	Rohde & Schwarz	ESCS 30	100356	9kHz – 2.75GHz	Dec. 01, 2014	Nov. 18, 2015	Nov. 30, 2015	Conduction (CO05-HY)
LISN	Rohde & Schwarz	ENV216	100080	9kHz~30MHz	Dec. 02, 2014	Nov. 18, 2015	Dec. 01, 2015	Conduction (CO05-HY)
LISN	Rohde & Schwarz	ENV216	100081	9kHz~30MHz	Dec. 08, 2014	Nov. 18, 2015	Dec. 07, 2015	Conduction (CO05-HY)



5 Uncertainty of Evaluation

Uncertainty of Conducted Emission Measurement (150kHz ~ 30MHz)

Measuring Uncertainty for a Level of Confidence of 95% ($U = 2Uc(y)$)	2.26
---	------

Uncertainty of Radiated Emission Measurement (30 MHz ~ 1000 MHz)

Measuring Uncertainty for a Level of Confidence of 95% ($U = 2Uc(y)$)	5.20
---	------



Appendix A. Conducted Test Results