

Leica Universal Hardware Platform (UHP)

User Reference Manual



UHP User Reference Manual v4.2

This document and any information or descriptive matter contained therein is communicated in confidence and is the copyright property of Leica Geosystems. Neither the whole, nor any extract may be disclosed, loaned, copied, or used in manufacturing or tendering purposes without their written consent.

© Copyright [2013-2016] Leica Geosystems Pty Ltd. All rights reserved. Leica Geosystems Pty Ltd is part of **Hexagon**. Leica Geosystems and the Leica Geosystems logo are the registered trademarks of Leica Geosystems. All trademarks or service marks used herein are property of their respective owners. Leica Geosystems makes no representation or warranty regarding the accuracy of the information in this publication. This document gives only a general description of the product(s) or service(s) offered by Leica Geosystems and, except where expressly provided otherwise, shall not form part of any contract. Such information, the products and conditions of supply is subject to change without notice.

Disclaimer: Illustrations, descriptions, and technical specifications in this document are not binding and are subject to change without notice.

This document is optimized for printing on A4 paper.

Revision History

Date	Document Version	Software Version	Author	Revision
23 Sept 2014	2		Dwayne Martine	Manual Consolidation
19 Jan 2015	3		Dwayne Martine	Rev. B information added
23 Jun 2016	4		M.A.Martin	Updated Wi-Fi Radio Information in sections 7.1.5 and 7.2.5 as follows: <ul style="list-style-type: none"> • Americas: Avg. TX Power 24dBm, +/- 2dB • Australia and EMEA: Avg. TX Power 23dBm +/- 2dB
9 Aug 2016	4.1		G Tooms	Added following for FCC compliance. 2.5 UHP Compliance Label 4.2.2 Antenna Installations: Added Installation Warning. 4.2.2.3 Wi-Fi Antenna Installation: Updated antenna distance from human statement. 6.4.3 Persons in Charge of the Product: Added antenna safety information Added Chapter 11: Appendix C UHP FCC Maximum Personal Exposure (MPE) Calculations
27 Sept 2016	4.2		G. Tooms	Added compliance label location information to section: 2.5 Labels on page 6

Table Of Contents

1	Document Introduction	1
1.1	Contacting Support	1
1.2	Document Conventions	1
2	Universal Hardware Platform (UHP) Overview	2
2.1	System Information	2
2.2	Sales Region	2
2.3	Universal Hardware Platform Low Precision With GNSS and Wi-Fi Radio (UHP-LPG)	2
2.3.1	Components of UHP-LPG	2
2.3.2	Features and Specifications	3
2.3.2.1	UHP-LPG Hardware	3
2.3.2.2	LEDs	3
2.3.2.3	UHP-LPG Software	3
2.4	Universal Hardware Platform High Precision With Wi-Fi Radio (UHP-HP)	4
2.4.1	Components of the UHP-HP	4
2.4.2	Features and Specifications	4
2.4.2.1	UHP-HP Hardware	4
2.4.2.2	LEDs	5
2.4.2.3	UHP-HP Software	5
2.5	Labels	6
2.5.1	Compliance Label Locations	6
2.5.1.1	UHP Compliance Labels by Region	6
2.5.2	UHP Part Number Label Location	7
2.5.2.1	UHP Part Number Labels by Region	7
3	LED Overview.....	8
3.1	Light Emitting Diodes (LEDs)	8
3.2	Basic Operation	8
3.2.1	Status Codes	8
3.2.2	Error Codes	8
3.3	Status Sources	9
3.4	Error Sources.....	9
3.5	Status Codes	9
3.6	UHP Status Code Chart	9
4	Hardware Installation.....	10
4.1	Before Installation	10
4.1.1	Requirements	10
4.2	General UHP Installation	10
4.2.1	Power Cable Installation.....	10
4.2.2	Antenna Installation	11
4.2.2.1	Antenna Application.....	11
4.2.2.2	GNSS Antenna Installation.....	11
4.2.2.3	Wi-Fi Antenna Installation.....	11
4.2.2.4	External RTK Correction Antenna	12
4.2.3	Connection to Additional Sensors	12
4.2.4	Upgrade Software via USB Flash Drive	12
5	Care and Transport.....	13
5.1	Transport	13
5.2	Storage	13
5.3	Cleaning and Drying	13
5.3.1	Product and Accessories.....	13

	5.3.2	Damp Products	13
	5.3.3	Connectors and Plugs	13
6		Safety Directions	14
6.1		General Introduction.....	14
6.2		Intended Use.....	14
	6.2.1	Permitted Use	14
	6.2.2	Adverse Use	14
6.3		Limits of Use	14
	6.3.1	Environment.....	14
6.4		Responsibilities	14
	6.4.1	Manufacturer of the Product	14
	6.4.2	Manufacturers of Non-Leica Geosystems Mining Accessories.....	15
	6.4.3	Persons in Charge of the Product	15
6.5		Hazards of Use	15
	6.5.1	General Hazards.....	15
	6.5.2	Mechanical Hazards	15
	6.5.3	Lightning Hazards	16
	6.5.3.1	Lightning Conductors	16
	6.5.4	Disposal	17
6.6		Electromagnetic Compatibility (EMC)	17
7		Technical Data	18
7.1		UHP-LPG Technical Data	18
	7.1.1	Design.....	18
	7.1.1.1	User Interface.....	18
	7.1.1.2	Dimensions	18
	7.1.1.3	Weight	18
	7.1.1.4	Power	18
	7.1.2	Environmental Specifications.....	18
	7.1.2.1	Temperature.....	18
	7.1.2.2	Protection Against Water, Dust, and Sand	18
	7.1.2.3	Humidity	18
	7.1.3	Interfaces	18
	7.1.4	GNSS Technical Data.....	19
	7.1.4.1	GNSS Receiver	19
	7.1.4.2	GNSS Antenna.....	19
	7.1.5	Wi-Fi.....	19
	7.1.6	FCC Statement (Applicable for U.S.).....	20
7.2		UHP-HP Technical Data	20
	7.2.1	Design.....	20
	7.2.1.1	User Interface.....	20
	7.2.1.2	Dimensions	20
	7.2.1.3	Weight	20
	7.2.1.4	Power	20
	7.2.2	Environmental Specifications.....	21
	7.2.2.1	Temperature.....	21
	7.2.2.2	Protection Against Water, Dust, and Sand	21
	7.2.2.3	Humidity	21
	7.2.3	Interfaces	21
	7.2.4	GNSS Technical Data.....	22
	7.2.4.1	GNSS Receiver	22
	7.2.4.2	GNSS Antennas.....	22
	7.2.5	Wi-Fi.....	22
	7.2.6	FCC Statement (Applicable for U.S.).....	23

8	Appendix A: Copyright	24
9	Appendix B: UHP Connector Pin Out	25
10	Appendix C: LED Fault Codes	26
11	Appendix D: UHP FCC Maximum Personal Exposure (MPE)	
	Calculations	28
	11.1 UHP Intentional Radiators	28
	11.1.1 Wi-Fi	28
	11.2 MPE Calculations	28
	11.2.1 MPE Formula	28
	11.2.2 Wi-Fi MPE Calculations.....	28
12	Glossary	29

1 Document Introduction

The Leica Universal Hardware Platform (UHP) User Reference Manual is part of Leica's Fleet Management System (FMS) Documentation Suite.

This manual is intended to serve as a guide to the UHP. This manual provides all instructions required in order to operate and troubleshoot the UHP product to a basic level. This manual provides an overview of the system together with the care and transport, technical data and safety directions.

It is assumed an operator using this manual is familiar with:

- Site-specific safety procedures, Safe Work Procedures (SWPs) and Standard Operating Procedures (SOPs).
- Hardware Installation Processes.

Note:

The document uses generic images to show general layout and generic information for various procedures. The site-specific screen layout, menu, and procedure information may vary from what is displayed in the manual.

1.1 Contacting Support

For all Leica Jigsaw product support:

Contact Method	Details
Web portal	http://www.hexagonmining.com/customer-portal.htm and select OPERATIONS SUPPORT .

1.2 Document Conventions

This document uses basic conventions to indicate actions:

Convention Example	Description
Select FILE > PRINT	Menu selections, buttons, and icons appear in bold text. In this case, select the FILE menu and the PRINT option. Location and capitalization of menu items may vary by mine site.
Ctrl+P	Keyboard shortcut keys. The example indicates to select and hold down the Ctrl key and select the P key.
See xxx Refer to	"See" indicates a reference to another section of this document. "Refer to" indicates reference to another document.
WARNING	Warnings alert the user to dangerous procedures which could cause injury or death.
CAUTION	Cautions alert the user to dangerous procedures which could cause damage to equipment.
Note	Notes supply important information about a procedure which is not covered in the procedure text.

2 Universal Hardware Platform (UHP) Overview

Note:

The images used in this manual are for reference purposes only; individual screens and icons may differ from the actual items.

This product is intended for **Professional Use** only.

2.1 System Information

The Leica Universal Hardware Platform (UHP) is configured to the following four specifications:

- UHP Low Precision with GNSS and Wi-Fi Radio (UHP-LPG)
- UHP High Precision with GNSS and Wi-Fi Radio (UHP-HP)

2.2 Sales Region

Leica UHP is available in select regions according to the specification:

Sales Region Table

Module	Sales Region
UHP Low Precision (UHP-LPG)	Australia (RCM), U.S. (FCC), Europe (CE), Brazil (Anatel). Additional regions will be added on an as needed basis.
UHP High Precision (UHP-HP)	Australia (RCM), U.S. (FCC), Europe (CE), Brazil (Anatel). Additional regions will be added on an as needed basis.

2.3 Universal Hardware Platform Low Precision With GNSS and Wi-Fi Radio (UHP-LPG)

The UHP-LPG is an industrial Single GNSS receiver and communications module intended as a part of the Leica Jigsaw Mining Solution.

2.3.1 Components of UHP-LPG



2.3.2 Features and Specifications

2.3.2.1 UHP-LPG Hardware

Hardware

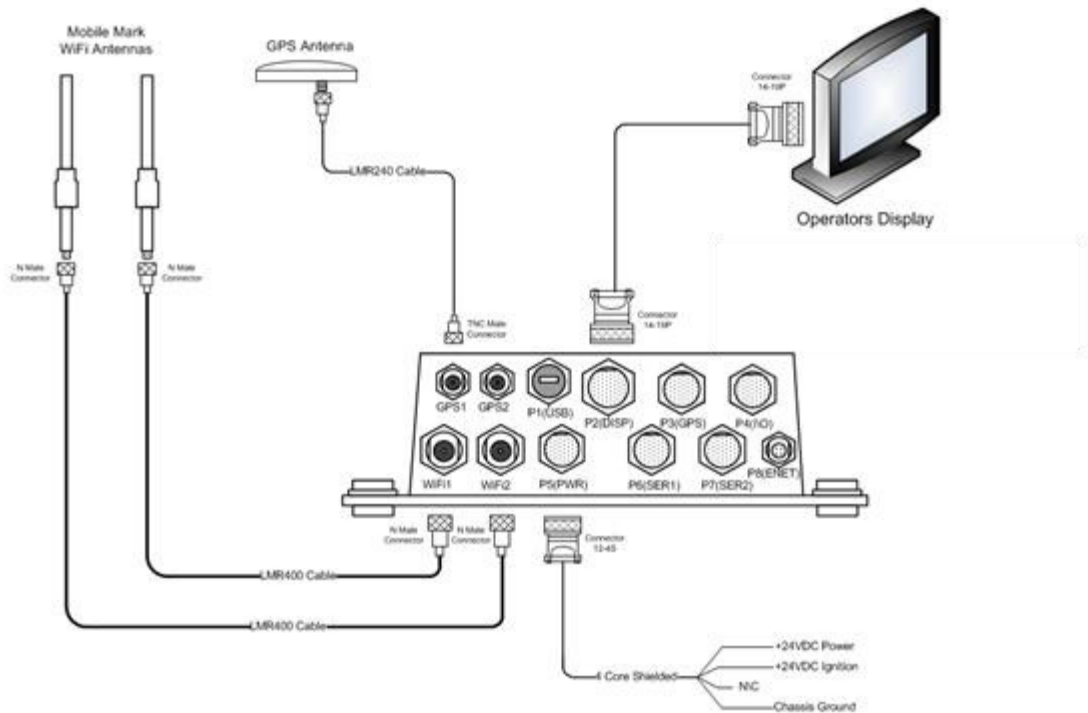

2.3.2.2 LEDs

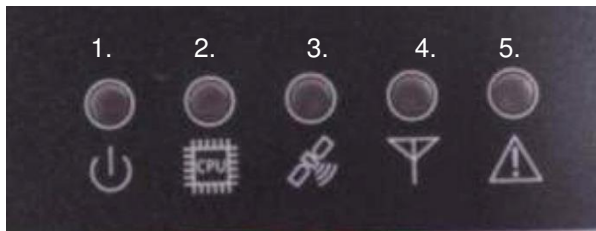

#	Module	Function
1	Power LED	Lights when the Leica Jigsaw UHP-LPG has power.
2	CPU LED	Lights when the Leica Jigsaw Operating System is being used
3	GNSS LED	Lights when the Leica Jigsaw UHP-LPG has GNSS signals.
4	Radio LED	Lights when a wireless network connection is established.
5	Warning LED	Used to indicate critical warnings.

2.3.2.3 UHP-LPG Software

- Command line configuration.
- Upgrade of software through USB.

Commercial in Confidence

© Leica Geosystems

2.4 Universal Hardware Platform High Precision With Wi-Fi Radio (UHP-HP)

The Leica Jigsaw UHP-HP is an industrial Dual Real Time Kinematic (RTK) GNSS receiver and communications module intended as a part of the Leica Jigsaw Mining Solution.

2.4.1 Components of the UHP-HP



2.4.2 Features and Specifications

2.4.2.1 UHP-HP Hardware

Hardware

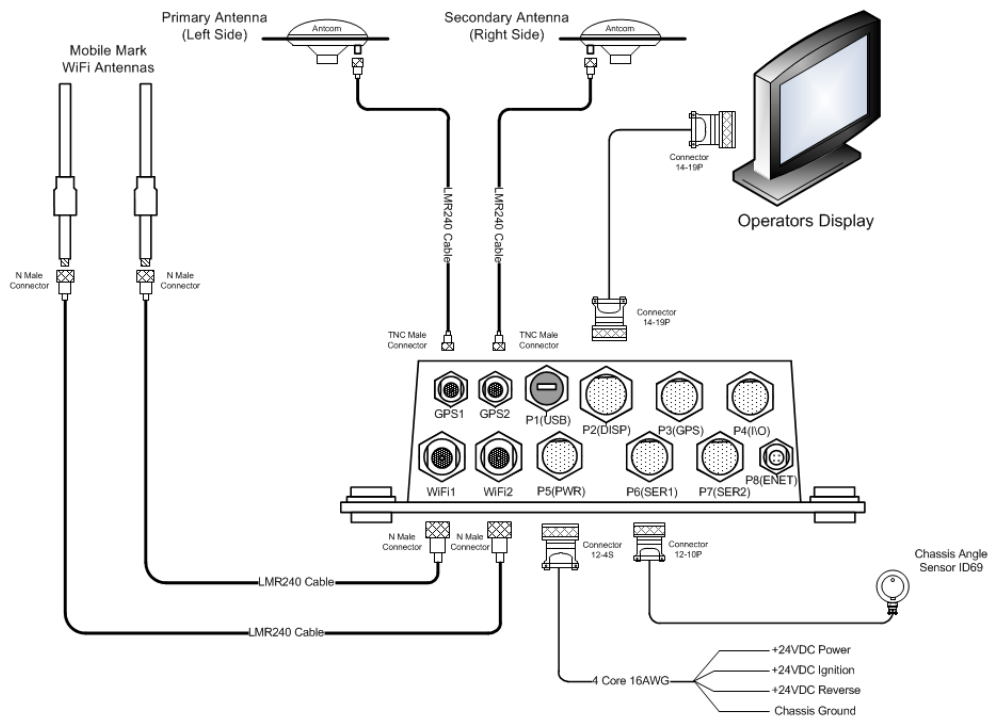

2.4.2.2 LEDs

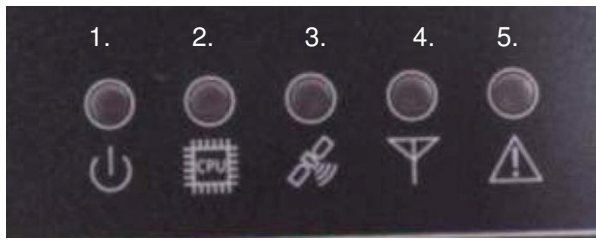

#	Module	Function
1.	Power LED	Lights when the Leica Jigsaw UHP-HP has power.
2.	CPU LED	Lights when the Leica Jigsaw Operating System is being used.
3.	GNSS LED	Lights when the Leica Jigsaw UHP-HP has GNSS signals.
4.	Radio LED	Lights when a wireless network connection is established.
5.	Warning LED	Used to indicate critical warnings.

2.4.2.3 UHP-HP Software

- Command line configuration.
- Upgrade of software through USB.

2.5 Labels





2.5.1 Compliance Label Locations

Compliance labels are located on all UHP modules in the following location.

Typical Certification Label Location for all UHP



2.5.1.1 UHP Compliance Labels by Region

UHP Compliance Label - High Precision	UHP Compliance Label - Low Precision
Compliance Label – Europe/Australia	Compliance Label – Europe/Australia
 <p>Made in USA</p> <p>Product: UHP HP Leica Geosystems AG Power: 9-36V DC, 6.5A (max) CH-9435 Heerbrugg</p> <hr/> <p style="text-align: right;">Manufacture date: 2016</p>	 <p>Made in USA</p> <p>Product: UHP LP-G Leica Geosystems AG Power: 9-36V DC, 6.5A (max) CH-9435 Heerbrugg</p> <hr/> <p style="text-align: right;">Manufacture date: 2016</p>
FCC Compliance Label – U.S.A.	FCC Compliance Label – U.S.A.
 <p>Made in USA</p> <p>Product: UHP HP Leica Geosystems AG Power: 9-36V DC, 6.5A (max) CH-9435 Heerbrugg</p> <p><u>FCC ID: 2AFYJ-UHPHP</u></p> <p><i>This device complies with part 15 of the FCC Rules. Operation is subject to the following two conditions: (1) This device may not cause harmful interference, and (2) this device must accept any interference received, including interference that may cause undesired operation.</i></p> <p style="text-align: right;">Manufacture date: 2016</p>	 <p>Made in USA</p> <p>Product: UHP LP-G Leica Geosystems AG Power: 9-36V DC, 6.5A (max) CH-9435 Heerbrugg</p> <p><u>FCC ID: 2AFYJ-UHPLP</u></p> <p><i>This device complies with part 15 of the FCC Rules. Operation is subject to the following two conditions: (1) This device may not cause harmful interference, and (2) this device must accept any interference received, including interference that may cause undesired operation.</i></p> <p style="text-align: right;">Manufacture date: 2016</p>

2.5.2 UHP Part Number Label Location



2.5.2.1 UHP Part Number Labels by Region

UHP Part Number Label - High Precision	UHP Part Number Label - Low Precision
Part Number Label – APAC Region	Part Number Label – APAC Region
<p>Leica Geosystems UHP HP P/N: 843147 123456 US Patents 7941158, 8190173, 8374783</p>	<p>Leica Geosystems UHP LP P/N: 843155 123456 US Patents 7941158, 8190173, 8374783</p>
Part Number Label – NAFTA Region	Part Number Label – NAFTA Region
<p>Leica Geosystems UHP HP P/N: 828045 123456 US Patents 7941158, 8190173, 8374783</p>	<p>Leica Geosystems UHP LP P/N: 828043 828043 US Patents 7941158, 8190173, 8374783</p>

3 LED Overview

This section describes the statuses of the LEDs on the UHP modules. The information contained in this guide is intended for high-end users and engineering staff.

The UHP is not designed to be opened in the field and it is impossible to debug faults if the single board computer (SBC)/Display is not working. To overcome this issue LED status codes indicate the status of the module by different LED flashing patterns for different error conditions

3.1 Light Emitting Diodes (LEDs)

The UHP has single color Red LED for Error and Green for all other LEDs. There are five external LEDs on the UHP module:

- Power (Green)
- CPU (Green)
- GPS (Green)
- Radio (Green)
- Error (Red)

The Power and the Error LEDs display the status of the RTK corrections:

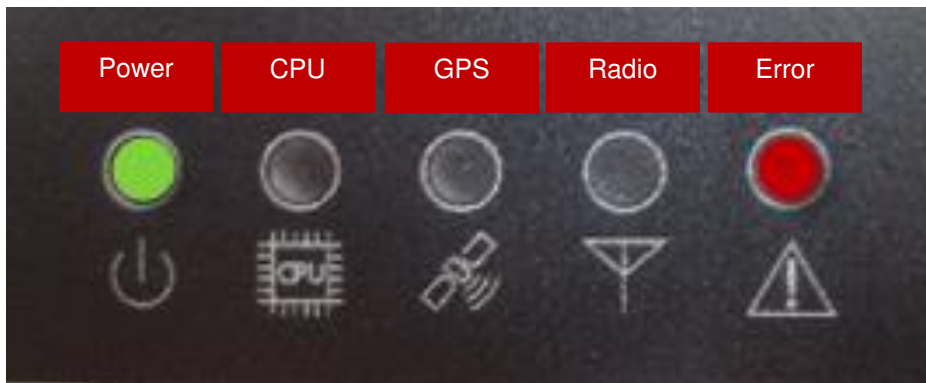

3.2 Basic Operation

The LED codes are broken up into Status and Error codes, while a Status code is being displayed, Error codes are inhibited.

3.2.1 Status Codes

Status codes are used to indicate where the module is functioning correctly but is not in the normal operating mode. For example, in low power mode due to the battery voltage being low.

3.2.2 Error Codes

Error codes are stored in a list, and the module cycles through the list displaying the codes one at a time. See [Appendix C: LED Fault Codes](#) for UHP error codes.

- The LEDs in an error state flash a code to indicate the error.
- When a code is displayed there is a pause, then the next error code displays until it loops back to the start of the list.
- The start of the error list is indicated by the Power LED turning red for two seconds on the UHP.

3.3 Status Sources

The following are the reasons for the Status codes:

- Ignition OFF
- Critical Low Voltage
- No Error

3.4 Error Sources

Various internal power supplies indicate reason for errors:

- Input power supply (9-36V)
- Critical low Voltage Detected
- Internal power Rails (12V, 5V, 3.3V)

3.5 Status Codes

The status codes are displayed on the Power LED; if there is an active status condition the Error Codes are inhibited.

3.6 UHP Status Code Chart

Status type	LED				
	Error (Red)	Power (Green)	CPU (Green)	GPS (Green)	Radio (Green)
All OK	OFF	ON			
Ignition OFF		Alternates between On Green and Off, with ½ second delay			
Network connected on at least one interface					On Green
Connecting to network on at least one interface					Flashing Green
(Valid high-precision GNSS solution for multiple antennas; or valid low-precision solution for single antenna.)				On Green	
GNSS service active, acquiring position				Flashing Green	
Main CPU ON (Application launched)			On Green		
Operating system is installing or has started.			Flashing Green		

4 Hardware Installation

4.1 Before Installation

Installation requires specialized knowledge and must be installed by a Leica Geosystems Mining Authorized Installer. Leica Geosystems Mining recommends that installation of the UHP equipment be performed by a qualified technician, as installation requires making electrical connections.

CAUTION:

During any welding on the machine, the Leica Jigsaw UHP should be completely isolated from the machine by disconnecting all of its cables including power, I/O, and RF cables. Welding can cause large ground currents, which may damage internal electronic components of the Leica Jigsaw UHP or its antenna. The Leica Jigsaw UHP is not warranted for damage when connected during welding activities.

4.1.1 Requirements

- Install the system in a clean and dry workshop environment. Failure to do so may cause the system to short or promote product malfunction.
- Route and secure all cables and wiring to ensure that they do not rub, causing premature failure.
- The average installation time varies, but it should take approximately two to four hours per vehicle to install the UHP. The time of installation may be more or less, based on vehicle type and options purchased.

4.2 General UHP Installation

WARNINGS:

Do not mount the UHP where it may obscure the driver's view of the road or field.

Do not mount the UHP where it may be struck by a deploying airbag.

1. Select an appropriate place to mount the UHP.
2. Four mount holes are provided in the metal housing, these should be used to firmly mount the UHP to the machine using the supplied vibration mounts.

4.2.1 Power Cable Installation

CAUTION:

The UHP is a 12-volt or 24-volt DC (negative-to-earth) system only. Connecting to a positive-to-earth system will cause damage, which is not covered by warranty.

1. Connect the supplied power cable to a reliable power source, for example, the vehicle's main power system:
 - a. Connect the red wire to a 12-volt or 24-volt positive source, capable of delivering a constant 5 A.
 - b. Connect the black wire to the vehicle's earth.
 - c. Optional: Connect the orange wire to the vehicles switched ignition power source to automatically power the UHP on and off with the vehicle's key.
2. Route and secure all cables and wiring to ensure that there is no rubbing, which can cause premature failure.
3. Connect the power cable to the power connector on the front of the UHP.

4.2.2 Antenna Installation

4.2.2.1 Antenna Application

To ensure correct antenna application for mobile or fixed assets, refer to the Antenna Application table.

Warning

- Only antenna listed in the Antenna Application table are permitted to be used.
- The UHP Wi-Fi antennas must be mounted more than 30cm away from the operator.
- Only antenna cables provided with the UHP equipment for installation as identified in UHP installation diagrams in section 2 for the appropriate UHP variant are to be used in UHP antenna installations.

Antenna Application

UHP Type	Required Antenna : Leica Part Number
<ul style="list-style-type: none">• UHP LP and UHP HP	<ul style="list-style-type: none">• GNSS: 828463• Wi-Fi: 809870

4.2.2.2 GNSS Antenna Installation

Note:

Read all instructions prior to assembly and installation.

The UHP GNSS Antenna should be mounted with a clear view of the sky and free from any obstruction from machine components, and must meet the following criteria.

1. The UHP GNSS Antenna must be on the flat level part of the machine or mast.
2. Route the cables through the existing grommets if possible; if not, modification may be required to route the cables to the desired location. If creating a new entry point, use a grommet to protect the cables.
3. The cables must not be cut, kinked, or bent tightly, as performance degrades and a system failure may result.
4. Cables should be routed neatly back to the UHP.

4.2.2.3 Wi-Fi Antenna Installation

Warning:

Antennas must be mounted more than 30 cm away from the human body.

Caution:

Antennas must be mounted more than 20 cm away from any other antenna.

Note:

Wi-Fi connectivity is dependent on network infrastructure which is outside the scope of this UHP manual.

For UHP-LPG and UHP-HP communication is transmitted via Wi-Fi. The Wi-Fi antennas and cabling for mounting the Wi-Fi communication antenna for UHP-LPG and UHP-HP variants with two 2.4GHz antennas.

1. Route the cables through the existing grommets if possible; if not, modification may be required to route the cables to the desired location. If creating a new entry point, use a grommet to protect the cables.
2. The cables must not be cut, kinked, or bent tightly, as performance degrades and a system failure may result.

Commercial in Confidence

© Leica Geosystems

3. Cables should be routed neatly back to the UHP.
4. Wi-Fi Antennas can be mounted on either side of the vehicle to increase coverage and visibility to local access points
5. Wi-Fi Antennas can be installed at a fixed offset of multiple 2.4GHz wavelengths for reasons of diversity. This is recommended for vehicles such as Dozers where the antennas are mounted on top of the vehicle with clear visibility to the sky.

4.2.2.4 External RTK Correction Antenna

For UHP-HP, RTK corrections are required. These can be delivered via Wi-Fi or alternatively via an external RTK radio.

- One RTK radio can be connected via an external communications port for example serial or Ethernet.
- An RTK radio should be mounted with good visibility to the RTK network infrastructure

4.2.3 Connection to Additional Sensors

For connection to all additional sensors and interfaces refer to machine specific installation manuals.

4.2.4 Upgrade Software via USB Flash Drive

A new version of software may be installed from a USB Flash Drive.

CAUTION:

Do not turn off the UHP, or remove the USB Flash Drive while the software upgrade is under way.

To upgrade the UHP software via USB Flash Drive, carry out the following steps:

1. Insert the compatible USB Flash Drive into the USB slot. The UHP restarts automatically when the installation is complete.
2. Follow the prompts on the panel for panel calibration.
3. Remove the USB Flash Drive only when the unit is powered down.

5 Care and Transport

5.1 Transport

When transporting the product by rail, air, or sea, always use the complete original Leica Geosystems Mining packaging, cardboard box, or an equivalent, in order to protect the product against shock and vibration.

5.2 Storage

Ensure the temperature limits are followed when storing the equipment, particularly in summer if the equipment is inside a vehicle. Please reference the Technical Data section for information about temperature limits.

5.3 Cleaning and Drying

5.3.1 Product and Accessories

Use only clean, soft, lint-free cloth for cleaning. If necessary, moisten the cloth with water or pure alcohol. Do not use other liquids; these may attack the polymer components.

5.3.2 Damp Products

Dry the product and the accessories at a temperature no greater than 40°C/104°F and clean them. Do not repack until everything is completely dry.

5.3.3 Connectors and Plugs

Keep plugs clean and dry. Blow away any dirt lodged in the plugs of the connecting cables.

6 Safety Directions

6.1 General Introduction

- The following directions should enable the person responsible for the product, and the person who actually uses the equipment, to anticipate and avoid operational hazards.
- The person responsible for the product must ensure that all users understand these directions and adhere to them.

6.2 Intended Use

6.2.1 Permitted Use

- The UHP is intended for Mining use only.
- Data communication with external appliances as part of a Leica Jigsaw Mining Solution.

6.2.2 Adverse Use

Adverse use can lead to injury, malfunction, and damage. It is the task of the person responsible for the equipment to inform the user about hazards and how to counteract them. The product is not to be operated until the user has been instructed how to work with it.

WARNING:

Unauthorized modification of Mining machinery by mounting or installing the product may alter the function and safety of that mining machinery.

WARNING:

Follow the instructions of the machinery manufacturer. If no appropriate instruction is available, ask the machinery manufacturer for instructions prior to mounting or installing the product.

The following items result in adverse use:

- Use of the product without instruction.
- Use outside of the intended limits.
- Disabling safety systems.
- Removal of hazard notices.
- Opening the product using tools, for example a screwdriver, unless this is specifically permitted for certain functions.
- Modification or conversion of the product.
- Use after misappropriation.
- Use of products with obviously recognizable damages or defects.
- Use with accessories from other manufacturers without the prior explicit approval of Leica Geosystems Mining.
- Inadequate safeguards at the working site, for example when using on the intended site.

6.3 Limits of Use

6.3.1 Environment

Warning:

Not to be used on planes or any aircraft.

Warning:

Local safety authorities and safety experts must be contacted before working in hazardous areas, or in close proximity to electrical installations or similar situations by the person in charge of the product.

This product is suitable for use in an atmosphere appropriate for permanent human habitation.

6.4 Responsibilities

6.4.1 Manufacturer of the Product

Leica Geosystems Mining is responsible for supplying the product, including the User Manual and original accessories, in a completely safe condition.

6.4.2 Manufacturers of Non-Leica Geosystems Mining Accessories

The manufacturers of non-Leica Geosystems Mining accessories for the product are responsible for developing, implementing, and communicating safety concepts for their products, and are also responsible for the effectiveness of those safety concepts in combination with the Leica Geosystems Mining product.

6.4.3 Persons in Charge of the Product

WARNING:

The person responsible for the product must ensure that it is used in accordance with the instructions. This person is also accountable for the training and the deployment of personnel who use the product and for the safety of the equipment in use.

The person in charge of the product has the following duties:

- Understand the safety instructions on the product and the instruction in the User Manual.
- Be familiar with local regulations relating to safety and accident prevention.
- To ensure operators do not work within 30 cm of the Cellular or Wi-Fi antennas.
- Inform Leica Geosystems Mining immediately if the product or the application becomes unsafe.

6.5 Hazards of Use

6.5.1 General Hazards

- The absence of instruction, or the inadequate imparting of instruction, can lead to incorrect or adverse use, and can give rise to accidents with far-reaching human, material, financial, and environmental consequences.
- All users must follow the safety directions given by the manufacturer and the directions of the person responsible for the product.
- Only Leica Geosystems Mining authorized service workshops are entitled to repair these products.
- Inadequate securing of the working site can lead to dangerous situations, for example in traffic, on building sites, and at industrial installations.
- Always ensure that the working site is adequately secured. Adhere to the regulations governing safety and accident prevention and road traffic.
- The operator assures that the machine is operated, guided and monitored by a qualified user (e.g., a licensed driver). The user has been able to take emergency measures, for example an emergency stop.
- While providing information to the operator of the machine, accidents may occur due to:
 - The operator not paying attention to the surroundings (persons, ditches, traffic, etc.).
 - Malfunctions (of a system component interface, etc.).

6.5.2 Mechanical Hazards

- Incorrect fastening of the equipment to vehicles or transporters poses the risk of the equipment being broken by mechanical influence, vibration, or airstream. This may result in accident and injury.
- Periodically carry out test measurements and perform the field adjustments, particularly after the product has been subjected to abnormal use and before and after important measurements.
- When setting up the product, ensure that the accessories are correctly adapted, fitted, secured, and locked in position. Avoid subjecting the product to mechanical stress.

- Attach the external antenna professionally. The external antenna must be secured additionally, for example by use of a safety cord. Ensure that the mounting device is correctly attached and able to carry the weight of the external antenna (> 1kg) safely.
- Deflect the mechanically moving machine components as far as possible and define a safe installation zone.
- If the accessories used with the product are not properly secured and the product is subjected to mechanical shock, for example, by blows or falling objects, the product may be damaged or people may sustain injury.

6.5.3 Lightning Hazards

WARNING:

If the product is used with accessories, for example, masts, staffs, or poles, you may increase the risk of being struck by lightning. Danger from high voltages also exists near power lines. Lightning, voltage peaks, or the touching of power lines can cause damage, injury and death.

- Be sure to remain at a safe distance from electrical installations. Do not use the product directly under or in close proximity to power lines. If it is essential to work in such an environment contact the safety authorities responsible for electrical installations and follow their instructions.
- To prevent damages due to indirect lightning strikes (voltage spikes) cables, for example for antenna, power source or modem should be protected with appropriate protection elements, like a lightning arrester. These instructions must be carried out by an authorized specialist.
- If there is a risk of a thunderstorm, or if the equipment is to remain unused and unattended for a long period, protect your product additionally by unplugging all systems components and disconnecting all connecting cable and supply cables.
- If the product is permanently mounted in an exposed location, it is advisable to provide a lightning conductor for the product as detailed below. Always follow the regulations in force by your country regarding grounding antennas and mast. These installations must be carried out by an authorized specialist.

6.5.3.1 Lightning Conductors

Suggestion for design of a lightning conductor for a GNSS system:

6.5.3.1.1 On Non-Metallic Structures

On Non-Metallic Structures, protection by air terminals is recommended.

1. An air terminal is a pointed solid or tubular rod of conducting material with mounting and connection to a conductor.
2. The position of four air terminals should be uniformly distributed around the antenna at a distance equal to the height of the air terminal. The air terminal diameter should be 12mm for copper or 15mm for aluminum. The height of the air terminals should be 25cm to 50cm.
3. All air terminals should be connected to the down conductors. The diameter of the air terminal should be kept to a minimum to reduce GNSS signal shading.

6.5.3.1.2 On Metallic Structures

On Metallic Structures protection is as described for non-metallic structures, but the air terminals can be connected directly to the conducting structure without the need for down conductors.

6.5.4 Disposal

If the product is improperly disposed of, the following can happen:

- If polymer parts are burnt, poisonous gases are produced, which may impair health.
- By disposing of the product irresponsibly, unauthorized persons may use it in contravention of the regulations, exposing themselves and third parties to the risk of severe injury and rendering the environment liable to contamination.

Caution:



The product must not be disposed of with household waste. Dispose of the product appropriately in accordance with the national regulations in force in your country.

Always prevent access to the product by unauthorized personnel. Product Specific treatment and waste management information can be downloaded from the Leica Geosystems home page at <http://www.leica-geosystems.com/treatment> or obtained from your Leica Geosystems Mining dealer.

6.6 Electromagnetic Compatibility (EMC)

The term Electromagnetic Compatibility is taken to mean the capability of the product to function smoothly in an environment where electromagnetic radiation and electrostatic discharges are present, and without causing electromagnetic disturbances to other equipment.

- Electromagnetic radiation can cause disturbances in other equipment. Although the product meets the strict regulations and standards that are enforced in this respect, Leica Geosystems Mining cannot completely exclude the possibility that other equipment may be disturbed.
- There is risk that disturbances may be caused in other equipment if the product is used in conjunction with accessories from other manufacturers, for example field computers, personal computers, two-way radios, non-standard cables, or external batteries.
- Use only the equipment and accessories recommended by Leica Geosystems Mining. When combined with the product, they meet the strict requirements stipulated by the guidelines and standards. When using computers and two-way radios, pay attention to the information about electromagnetic compatibility provided by the manufacturer.
- Disturbances caused by electromagnetic radiation can result in erroneous measurements. Although the product meets the strict regulations and standards which are enforced in this respect, Leica Geosystems Mining cannot completely exclude the possibility that the product may be disturbed by very intense electromagnetic radiation produced by, for example, nearby transmitters, two-way radios, or diesel generators.
- Check the plausibility of results obtained under these conditions.
- If the product is operated with connecting cables attached at only one of their two ends, the permitted level of electromagnetic radiation may be exceeded and the correct functioning of other products may be impaired.
- While the product is in use, connecting cables must be connected at both ends.

7 Technical Data

7.1 UHP-LPG Technical Data

7.1.1 Design

Aluminum enclosure with a polymer top decal.

7.1.1.1 User Interface

- Five LEDs.
- VGA Screen interface with USB Touch Screen

7.1.1.2 Dimensions

Length (cm)	Width (cm)	Height (cm)
32.3	22.8	9.9

7.1.1.3 Weight

Weight (kg)
3.811

7.1.1.4 Power

Consumption (W)	External Supply Voltage
60 max	Normal Voltage 24V DC (-) Voltage Range 9V – 36V

7.1.2 Environmental Specifications

7.1.2.1 Temperature

Operating Temperature (°C)	Storage Temperature (°C)
-40 to +60	-40 to +85

7.1.2.2 Protection Against Water, Dust, and Sand

Protection
IP67

7.1.2.3 Humidity

Protection
Up to 95% The effects of condensation are effectively counteracted by periodically drying out the UHP-LPG.

7.1.3 Interfaces

- RS232 Serial: 5x
- CAN: 2x
- Ethernet: 3x
- USB: 3x (1 Type A)
- VGA: 1x

- Power Out 12V: 6x
- Digital Inputs: 5x
- Digital Outputs: 2x
- Frequency Input: 1x
- Ignition Input 1x
- Audio Output: 1x
- GNSS RF Input 1x
- Wi-Fi Input/Output 1x

7.1.4 GNSS Technical Data

7.1.4.1 GNSS Receiver

Field	Description
Manufacturer	NovAtel
Model	OEMStar®
Signal Tracking	L1 GPS, L1 GLONASS
Channel Count	14
Channel Configuration	Any combination of GPS L1 & GLONASS L1
Horizontal Position Accuracy ¹ (See below)	Single Point L1: 1.5m RMS

- ¹ Accuracy is dependent upon various factors including:
 - Number of satellites tracked
 - Constellation geometry
 - Observation time
 - Ephemeris accuracy
 - Ionospheric disturbance
 - Multipath and resolved ambiguities

7.1.4.2 GNSS Antenna

Field	Description
Manufacturer	Antcom
Model	G3
Frequency	L1, 1528.5 – 1616 MHz

7.1.5 Wi-Fi

The UHP-LPG variant has the following Wi-Fi component.

- 2.4GHz radio b/g/n compliant
- Americas: Avg. TX Power 24dBm, +/- 2dB
- Australia and EMEA: Avg. TX Power 23dBm +/- 2dB

Commercial in Confidence

© Leica Geosystems

7.1.6 FCC Statement (Applicable for U.S.)

This equipment has been tested and found to comply with the limits for a Class A digital device, pursuant to Part 15 of the FCC Rules. These limits are designed to provide reasonable protection against harmful interference when the equipment is operated in a commercial environment. This equipment generates, uses, and can radiate radio frequency energy and, if not installed and used in accordance with the instruction manual, may cause harmful interference to radio communications. Operation of this equipment in a residential area is likely to cause harmful interference, in which case the user will be required to correct the interference at their own expense.

This equipment generates, uses and can radiate frequency energy and, if not installed and used in accordance with the instructions, may cause harmful interference to radio communication. However, there is no guarantee that interference will not occur in a particular installation. If this equipment does cause harmful interference to radio or television reception, which can be determined by turning the equipment off and on, the user is encouraged to try to correct the interference by one or more of the following measures:

- Reorient or relocate the receiving antenna.
- Increase the separation between the equipment and the receiver.
- Connect the equipment into an outlet on a circuit different from that to which the receiver is connected.
- Consult the dealer or an experienced radio/TV technician for help.

Changes or modifications not expressly approved by Leica Geosystems for compliance could void the user's authority to operate the equipment.

7.2 UHP-HP Technical Data

7.2.1 Design

Aluminum enclosure with a polymer top decal.

7.2.1.1 User Interface

- Five LEDs.
- VGA Screen interface with USB Touch Screen

7.2.1.2 Dimensions

Length (cm)	Width (cm)	Height (cm)
32.3	22.8	9.9

7.2.1.3 Weight

Weight (kg)
3.811

7.2.1.4 Power

Consumption (W)	External Supply Voltage
60 max	Normal Voltage 24V DC (-) Voltage Range 9V – 36V

7.2.2 Environmental Specifications

7.2.2.1 Temperature

Operating Temperature (°C)	Storage Temperature (°C)
-40 to +60	-40 to +85

7.2.2.2 Protection Against Water, Dust, and Sand

Protection
IP67

7.2.2.3 Humidity

Protection
Up to 95% The effects of condensation are effectively counteracted by periodically drying out the UHP-HP.

7.2.3 Interfaces

- RS232 Serial: 5x
- CAN: 2x
- Ethernet: 3x
- USB: 3x (1 Type A)
- VGA: 1x
- Power Out 12V: 6x
- Digital Inputs: 6x
- Digital Outputs: 2x
- Frequency Input: 1x
- Ignition Input: 1x
- Audio Output: 1x
- GNSS RF Input: 2x
- Wi-Fi Input/Output 1x

7.2.4 GNSS Technical Data

7.2.4.1 GNSS Receiver

Field	Description
Manufacturer	NovAtel
Model	OEM628™
Signal Tracking	GPS: L1, L2, L2C, L5 GLONASS: L1, L2 ² BeiDou: B1, B2 Galileo: E1, E5a, E5b, AltBOC
Channel Count	120
Position Accuracy ¹ (See below)	Single Point L1/L2: 1.2m RMS RT-2@: 10mm + 1ppm Horizontal, 20mm + 1ppm Vertical

- ¹ Accuracy is dependent upon various factors including:
 - Number of satellites tracked
 - Constellation geometry
 - Observation time
 - Ephemeris accuracy
 - Ionospheric disturbance
 - Multipath and resolved ambiguities
- ² The hardware is designed to support the BeiDou satellite system. However a future software upgrade is required.

7.2.4.2 GNSS Antennas

Field	Description
Manufacturer	Antcom
Model	G5
Frequency	L1/L2/L2C/L5 GPS, L1/L2 GLONASS, B1/B2 BeiDou, E1/E5a/E5b/AltBOC Galileo 1528.5 – 1616 MHz

7.2.5 Wi-Fi

The UHP-HP variant has the following Wi-Fi component.

- 2.4GHz radio b/g/n compliant
- Americas: Avg. TX Power 24dBm, +/- 2dB
- Australia and EMEA: Avg. TX Power 23dBm +/- 2dB

7.2.6 FCC Statement (Applicable for U.S.)

This equipment has been tested and found to comply with the limits for a Class A digital device, pursuant to Part 15 of the FCC Rules. These limits are designed to provide reasonable protection against harmful interference when the equipment is operated in a commercial environment. This equipment generates, uses, and can radiate radio frequency energy and, if not installed and used in accordance with the instruction manual, may cause harmful interference to radio communications. Operation of this equipment in a residential area is likely to cause harmful interference, in which case the user will be required to correct the interference at their own expense.

This equipment generates, uses, and can radiate frequency energy and, if not installed and used in accordance with the instructions, may cause harmful interference to radio communication. However, there is no guarantee that interference will not occur in a particular installation. If this equipment does cause harmful interference to radio or television reception, which can be determined by turning the equipment off and on, the user is encouraged to try to correct the interference by one or more of the following measures:

- Reorient or relocate the receiving antenna.
- Increase the separation between the equipment and the receiver.
- Connect the equipment into an outlet on a circuit different from that to which the receiver is connected.
- Consult the dealer or an experienced radio/TV technician for help.

Changes or modifications not expressly approved by Leica Geosystems for compliance could void the user's authority to operate the equipment.

8 Appendix A: Copyright

This software contains copyrighted software, which is licensed under various open source licenses. Contact opensource@leica-geosystems.com.

For some of the open source modules, corresponding source code can be obtained from Leica Geosystems Mining's open source center located at opensource.leica-geosystems.com/

9 Appendix B: UHP Connector Pin Out

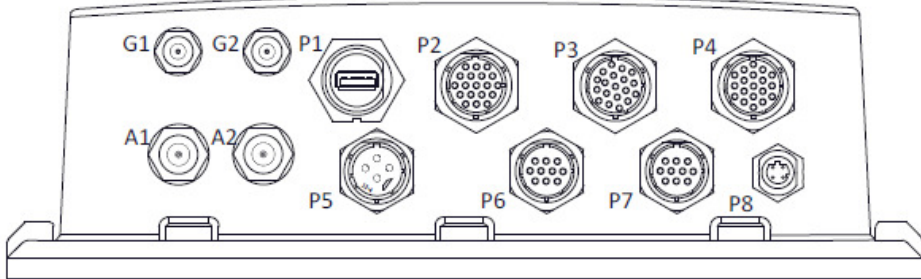

	Power Input	I/O	I/O	I/O	I/O	Display
	P5	P6	P7	P3	P4	P2
	12-4P	12-10S	12-10S	14-19SX	14-19SW	14-19SEX
Pin	P5	P6	P7	P3	P4	P2
A	BATTERY +	COM1(RS232)RX	COM2(RS232)RX	POWER 12VDC**	POWER 12VDC**	SUPPLY GND
B	DIGITAL INPUT 5	COM1(RS232)TX	COM2(RS232)TX	(USB)GND	SUPPLY GND	DISPLAY POWER***
C	IGNITION	CANH	CANH	(ENET)RX-	FREQUENCY INPUT	(ENET)ITX+
D	BATTERY -	COM1(RS232)GND	COM2(RS232)GND	(ENET)RX+	SERIAL GND	AUDIO+
E		CANL	CANL	(ENET)RX-	SPARE	AUDIO-
F		COM1(RS232)RTS	COM2(RS232)RTS	(ENET)RX+	SPARE	VGA RED
G		COM1(RS232)CTS	COM2(RS232)CTS	(I2C)CLK	SPARE	VGA RED GND
H		CAN POWER 12VDC*	CAN POWER 12VDC*	(I2C)DATA	DIGITAL 1	VGA GRN
J		POWER 12VDC**	POWER 12VDC**	COM5(RS232)RX	DIGITAL 2	VGA GRN GND
K		SUPPLY GND	SUPPLY GND	COM(RS232)GND	DIGITAL 3	VGA BLU
L				(USB)D+	DIGITAL 4	VGA BLU GND
M				SUPPLY GND	DIGITAL GND	VGA HSYNC
N				(USB)VBUS	DIGITAL GND	(ENET)3)RX+
P				(USB)D-	DIGITAL OUTPUT 1	VGA VSYNC
R				COM3 SERIAL#	DIGITAL OUTPUT 2	CHASSIS GND
S				COM3 SERIAL#	COM Serial # #	(ENET)3)TX-
T				COM3 SERIAL#	COM Serial # #	(USB)D-
U				COM(RS232)TX	COM Serial # #	(USB)D+
V				COM3 SERIAL#	COM Serial # #	(ENET)3)RX-

# COM Selectable Pinout and Mode of Operation:			
Pin	RS232	RS422	RS485/1708
T	CTS	RX-	
S	RX	RX+	
R	RTS	TX-	DATA-
V	TX	TX+	DATA+

# COM4 Selectable Serial Pinout and Mode of Operation:			
Pin	RS232	RS422	RS485/1708
S	CTS	RX-	
T	RX	RX+	
U	RTS	TX-	DATA-
V	TX	TX+	DATA+

	USB	Ethernet
Pin	P1	P8
	TYPE A	M12 D-coded
Pin	P1	P8
1	GND	RX+
2	DATA+	TX+
3	DATA-	RX-
4	VBUS	TX-
	SHIELD	

*6W max. output: 12VDC@500mA
 **12W max. output: 12VDC@1A
 ***Protected, Switchable (SW-controlled), Voltage clamped to 32V max output, Current limited to 3A max output, unregulated pass through.
 (Note will have some internal voltage drop depending on load).
 Any 12V system supply should be boosted to 24V before being connected to the UHP if display cannot run below 10.5V
 Remember to allow for cable voltage drops which also vary on load.

REV	DATE	DESCRIPTION	DRAWN	CHECK	APPROV	DATE	TITLE
A	11 Nov 2014	Initial Release	D.H.	S.G.	D.H.		UHP Rev B Connector Pinout

00016 Security Mark Ref
 TUCSON, AZ 85716
 UNITED STATES
 Leica Geosystems
 when it has to be right

LEICA GEOSYSTEMS PTY LTD
 This document and any information or descriptive matter contained therein is communicated in confidence and is the copyright property of LEICA GEOSYSTEMS PTY LTD, part of Hexagon. Neither the whole nor any extract may be disclosed, loaned, copied, or used in manufacturing or tendering purposes without their written consent.

Sheet 1 of 1
 Do Not Scale

REF A3
 REF D

Commercial in Confidence

© Leica Geosystems

10 Appendix C: LED Fault Codes

Faults detected are logged in the system log as well as flashed on the UHP LEDs.

The UHP indicates fault codes by flashing or blinking two of the UHP status LEDs. The fault code, red and green, is indicated by two blinking LEDs. The power LED for green and the error LED for red. To indicate the start of the fault code, the red error LED is blinked on one long duration (two seconds), followed by the remainder of the error code as follows: the red error LED blinked a number of times (Red) short duration, followed by green power LED blinked a number of times (Green) a number of times short duration. Please see the Fault Code table for error codes.

Power (Green) and Error (Red) UHP Lights used for Error Codes

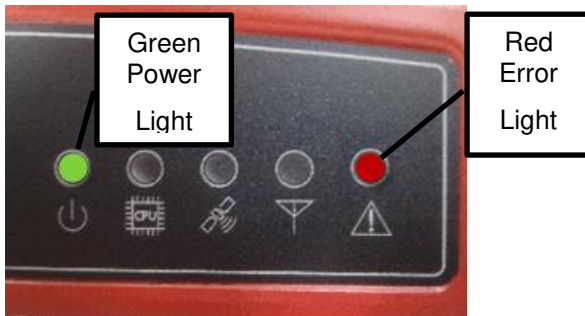

Sample Error Code Display Time

Example of Error Flash Code 2, 3

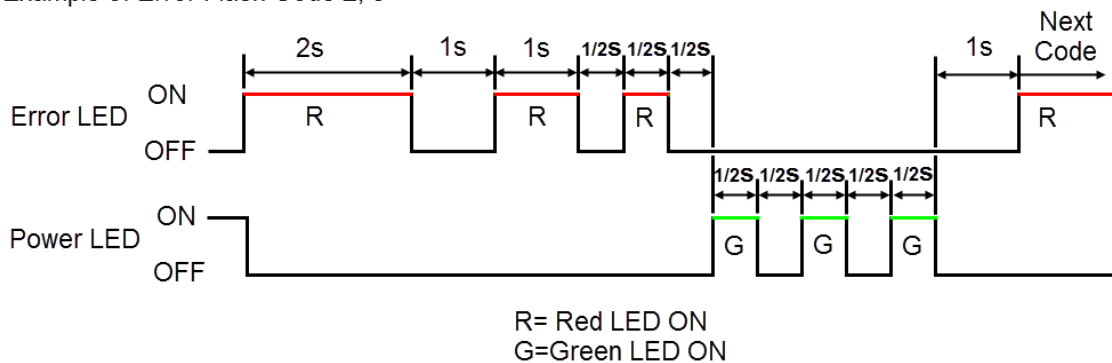

Fault Code Error Table

Error type		LED Error (Red)	Power (Green)
Fast Current Trip	Port 2 12V	2 Red	2 Green
	Port 3 12V	2 Red	3 Green
	Port 4 12V	2 Red	4 Green
	Port 6 CAN	2 Red	5 Green
	Port 6 12V	2 Red	6 Green
	Port 7 CAN	2 Red	7 Green
	Port 7 12V	2 Red	8 Green
Input Voltage	Battery Voltage Critically Low <9V	4 Red	1 Green

Error type		LED Error (Red)	Power (Green)
	(only Rev B and above)		
	Battery Voltage Low <11V (only Rev B and above)	4 Red	2 Green
	Battery Voltage High >32V (only Rev B and above)	4 Red	3 Green
	Power Fault (override low voltage)	4 Red	4 Green
	Power not ok (override low voltage)	4 Red	5 Green
	Power current high	4 Red	6 Green
	Power consumption high	4 Red	7 Green
	Power consumption critical	4 Red	8 Green
Internal Voltage Regulation	12V fail	5 Red	3 Green
	5V fail	5 Red	4 Green
	3.3V fail	5 Red	5 Green
SBC (no coms for 30sec)	Not talking to backplane	6 Red	1 Green
Internal Error	Over or Under Temp	6 Red	5 Green

11 Appendix D: UHP FCC Maximum Personal Exposure (MPE) Calculations

Reference: FCC document 'Evaluating Compliance with FCC Guidelines for Human Exposure to Radiofrequency Electromagnetic Fields'

From herein this document will be referred to as the 'FCC Guideline to MPE' document.

11.1 UHP Intentional Radiators

The UHP comprises the following RF interfaces

11.1.1 Wi-Fi

- Radio : Ubiquiti Networks SR71 802.11n MIMO mini-PCI Module
- Antenna: MobileMark OD6-2400MOD2-BLK-SP-35.

Refer documents 'SR71a_datasheet.pdf', 'antenna-spec-140-od-2400.pdf' and 'OD6-2400-pat.pdf' for further information.

11.2 MPE Calculations

11.2.1 MPE Formula

The FCC Guide to MPE document section 3 'Methods of Predicting Human Exposure' page 17, advises to use the following formula

$$S = P \cdot G / 4 \cdot \pi \cdot R^2$$

$$\Rightarrow R = (P \cdot G / 4 \cdot \pi \cdot S)^{0.5}$$

Where

S = Power Density (MPE) mW/cm²

P = Power input to antenna (power output from radio) (mW)

G = Power gain of antenna relative to isotropic radiator (dBi)

R = Distance from antenna (cm)

11.2.2 Wi-Fi MPE Calculations

Referring to The FCC Guide to MPE document, Appendix A, Table 1 (B) Limits for General Population/Uncontrolled exposure (1.5GHz to 100GHz).

$$S = 1.0 \text{ mW/cm}^2$$

$$P = 24\text{dB} = 251.2\text{mW (ref SR71 data sheet)}$$

$$G = 6\text{dBi (ref RFI CD2405 data sheet)}$$

$$\Rightarrow R = (P \cdot G / 4 \cdot \pi \cdot S)^{0.5}$$

$$\Rightarrow R = (251.2 \times 6 / 4 \cdot \pi \cdot 1)^{0.5}$$

$$\Rightarrow R = 11 \text{ cm}$$

12 Glossary

Term	Definition
Ephemeris	A list of positions or locations of a celestial object as a function of time.
GNSS	Global Navigation Satellite Systems
GPS	GPS is the shortened term for NAVSTAR GPS, which stands for Navigation System with Time And Ranging Global Positioning System.
Ionospheric	Upper part of earth's atmosphere at 53 to 370 miles.
LED	Light-emitting Diode
RTK	RTK (Real Time Kinematic) A term used to describe the procedure of resolving the phase ambiguity at the GPS receiver, so that the need for post-processing is removed.
SBAS	SBAS (Satellite Based Augmentation System) SBAS comprises of a number of ground stations at surveyed points. The ground stations take measurements of GPS satellites, their signals, and environmental factors, which may affect the signals received by users, and create adjustment messages to send to one or more satellites for broadcast to users.
SBC	Single Board Computer
UHP	Universal Hardware Platform



Hexagon Mining is the only company to solve surface and underground challenges with proven technologies for planning, operations, and safety. We bring surveying, design, fleet management, production optimization, and collision avoidance together in a life-of-mine solution that connects people and processes. Our customers are safer, more productive, and can make sense of their data.

Headquartered in Tucson, Arizona, with offices worldwide, Hexagon Mining is shaping smart change by helping to connect all parts of a mine with technologies that make sense of data in real time. We deliver technology, service, and support. Learn more at hexagonmining.com and follow us @HexagonMining.

Mining is part of Hexagon (Nasdaq Stockholm: HEXA B; hexagon.com), a leading global provider of information technologies that drive quality and productivity across geospatial and industrial enterprise applications.

Our Locations

*Additional regional support centers are listed on the website

United States, Canada & Mexico

Leica Geosystems
Mining
Tucson, USA
Ph: +1 520 529 8729

Latin America

Leica Geosystems
Santiago, Chile
Ph: +56 22 224 8421

Australia & South-East

Asia
Leica Geosystems
Brisbane, Australia
Ph: +61 7 3117 8900

Africa

Leica Geosystems
Johannesburg,
South Africa
Ph: +27 11 594 3900

China

Leica Geosystems
Beijing, China
Ph: +86 10 8569 1819

India

Leica Geosystems
Gurgaon, India
Ph: +91 124 412 2222

Indonesia

PT Leica Geosystems
Balikpapan, Indonesia
Ph: +62 811 544 1258