



SGS-CSTC Standards Technical Services (Shanghai) Co., Ltd.

588 West Jindu Road, Songjiang District, Shanghai, China
Telephone: +86 (0) 21 6191 5666
Fax: +86 (0) 21 6191 5678
ee.shanghai@sgs.com

Report No.: SHEM150300086301
Page: 1 of 20

1 Cover Page

FCC REPORT

Application No.:	SHEM1503000863CR
Applicant:	Zhejiang Lianda Science and Technology Co., Ltd
FCC ID:	2AFYH-R5
Equipment Under Test (EUT): NOTE: The following sample(s) submitted was/were identified on behalf of the client as	
Product Name:	Radio Remote Controller
Model No.:	RTA SCE – R5 Green
Added Model:	RTA SCE – R5 Gunmetal, RTA SCE – R5 Chestnut, RTA SCE – R5 Khaki, RTA SCE – R5 Apricot, RTA SCE – R5 Turquoise
Standards:	FCC PART 15 Subpart C: 2014
Date of Receipt:	March 31, 2015
Date of Test:	April 08, 2015 to April 09, 2015
Date of Issue:	April 13, 2015
Test Result:	PASS *

*In the configuration tested, the EUT detailed in this report complied with the standards specified above.



The manufacturer should ensure that all products in series production are in conformity with the product sample detailed in this report. If the product in this report is used in any configuration other than that detailed in the report, the manufacturer must ensure the new system complies with all relevant standards.



The report must not be used by the client to claim product certification, approval, or endorsement by NVLAP, NIST, or any agency of the federal government. All test results in this report can be traceable to National or International Standards.

This document is issued by the Company subject to its General Conditions of Service printed overleaf, available on request or accessible at www.sgs.com/terms_and_conditions.htm and, for electronic format documents, subject to Terms and Conditions for Electronic Documents at www.sgs.com/terms_e-document.htm. Attention is drawn to the limitation of liability, indemnification and jurisdiction issues defined therein. Any holder of this document is advised that information contained hereon reflects the Company's findings at the time of its intervention only and within the limits of Client's instructions, if any. The Company's sole responsibility is to its Client and this document does not exonerate parties to a transaction from exercising all their rights and obligations under the transaction documents. This document cannot be reproduced except in full, without prior written approval of the Company. Any unauthorized alteration, forgery or falsification of the content or appearance of this document is unlawful and offenders may be prosecuted to the fullest extent of the law. Unless otherwise stated the results shown in this test report refer only to the sample(s) tested and such sample(s) are retained for 90 days only



2 Version

Revision Record				
Version	Chapter	Date	Modifier	Remark
00	/	April 13, 2015	/	Original

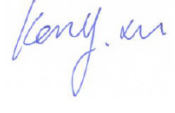
Authorized for issue by:			
Engineer		Eddy Zong _____ Print Name	 _____
Clerk		Susie Liu _____ Print Name	 _____
Reviewer		Keny Xu _____ Print Name	 _____

3 Test Summary

Test Item	Test Requirement	Test method	Result
Antenna Requirement	47 CFR Part 15, Subpart C Section 15.203	ANSI C63.10(2013)	PASS
AC Power Line Conducted Emission	47 CFR Part 15, Subpart C Section 15.207	ANSI C63.10(2013)	N/A
Field Strength of the Fundamental Signal	47 CFR Part 15, Subpart C Section 15.231 (e)	ANSI C63.10(2013)	PASS
Spurious Emissions	47 CFR Part 15, Subpart C Section 15.231 (e)/15.209	ANSI C63.10(2013)	PASS
20dB Bandwidth	47 CFR Part 15, Subpart C Section 15.231 (c)	ANSI C63.10(2013)	PASS
Dwell Time	47 CFR Part 15, Subpart C Section 15.231 (a)(1)	ANSI C63.10(2013)	PASS

Remark: 1. This EUT is powered by battery only; therefore the AC Conducted Emission test is not applicable.
2. There are 6 models mentioned in this report, and they are the similar in electrical and electronic characters. Only the model RTA SCE – R1 Green was tested since their differences were the model number and appearance.



4 Contents

	Page
1 COVER PAGE.....	1
2 VERSION.....	2
3 TEST SUMMARY.....	3
4 CONTENTS.....	4
5 GENERAL INFORMATION.....	5
5.1 CLIENT INFORMATION.....	5
5.2 GENERAL DESCRIPTION OF E.U.T.....	5
5.3 TECHNICAL SPECIFICATIONS:.....	5
5.4 DESCRIPTION OF SUPPORT UNITS.....	5
5.5 DETAILS OF TEST MODE.....	5
5.6 TEST LOCATION.....	5
5.7 TEST FACILITY.....	6
6 EQUIPMENTS USED DURING TEST.....	7
7 TEST RESULTS AND MEASUREMENT DATA.....	8
7.1 ANTENNA REQUIREMENT.....	8
7.2 CONDUCTED EMISSIONS.....	9
7.3 SPURIOUS EMISSIONS.....	10
7.3.1 <i>Field Strength of the Fundamental Signal</i>	12
7.3.2 <i>Spurious Emissions</i>	13
7.4 20DB BANDWIDTH.....	16
7.5 DWELL TIME.....	18
8 TEST SETUP PHOTOGRAPHS.....	20
8.1 RADIATED EMISSION TEST SETUP.....	ERROR! BOOKMARK NOT DEFINED.
9 EUT CONSTRUCTIONAL DETAILS.....	ERROR! BOOKMARK NOT DEFINED.
9.1 EXTERNAL PHOTOS.....	ERROR! BOOKMARK NOT DEFINED.
9.2 INTERNAL PHOTOS.....	ERROR! BOOKMARK NOT DEFINED.

5 General Information

5.1 Client Information

Applicant:	Zhejiang Lianda Science and Technology Co., Ltd
Address of Applicant:	2# Road Technological and industrial Distrial, Nanxun, Huzhou, Zhejiang, China
Manufacturer:	Zhejiang Lianda Science and Technology Co., Ltd
Address of Manufacturer:	2# Road Technological and industrial Distrial, Nanxun, Huzhou, Zhejiang, China
Factory:	Zhejiang Lianda Science and Technology Co., Ltd
Address of Factory:	2# Road Technological and industrial Distrial, Nanxun, Huzhou, Zhejiang, China

5.2 General Description of E.U.T.

Product Description:	Portable product
Brand Name:	TUBE

5.3 Technical Specifications:

Operation Frequency:	433.92MHz
Modulation Technique:	OOK
Number of Channel:	1
Antenna Type	Integral Antenna
Power Supply:	DC 3V by Button Battery (Supply the EUT with new battery during the testing.)

5.4 Description of Support Units

The EUT has been tested independently

5.5 Details of Test Mode

Test Mode	Detail description of the test mode
Engineering mode	Keeps EUT working in continuous transmitting mode.

5.6 Test Location

All tests were performed at:

SGS-CSTC Standards Technical Services (Shanghai) Co., Ltd. E&E Lab
No.588 West Jindu Road, Songjiang District, Shanghai, China. 201612.

Tel: +86 21 6191 5666

Fax: +86 21 6191 5678

No tests were sub-contracted.

5.7 Test Facility

- **CNAS (No. CNAS L0599)**

CNAS has accredited SGS-CSTC Standards Technical Services (Shanghai) Co., Ltd. to ISO/IEC 17025:2005 General Requirements for the Competence of Testing and Calibration Laboratories (CNAS-CL01 Accreditation Criteria for the Competence of Testing and Calibration Laboratories) for the competence in the field of testing. Date of expiry: 2017-07-14.

- **FCC – Registration No.: 402683**

SGS-CSTC Standards Technical Services (Shanghai) Co., Ltd. has been registered and fully described in a report filed with the Federal Communications Commission (FCC). The acceptance letter from the FCC is maintained in our files. Registration No.: 402683, Expiry Date: 2017-09-16.

- **Industry Canada (IC) – IC Assigned Code: 8617A**

The 3m Semi-anechoic chamber of SGS-CSTC Standards Technical Services (Shanghai) Co., Ltd. has been registered by Certification and Engineering Bureau of Industry Canada for radio equipment testing with Registration No.: 8617A-1. Expiry Date: 2017-06-18.

- **VCCI (Member No.: 3061)**

The 3m Semi-anechoic chamber and Shielded Room of SGS-CSTC Standards Technical Services (Shanghai) Co., Ltd. has been registered in accordance with the Regulations for Voluntary Control Measures with Registration No.: R-3868 and C-4336 respectively. Date of Registration: 2012-05-29. Date of Expiry: 2015-05-28.

6 Equipments Used during Test

Item	Test Equipment	Manufacturer	Model No.	Serial No.	Cal. Date	Cal. Due date
1	EMI test receiver	Rohde & Schwarz	ESCS30	100086	2015-01-22	2016-01-21
2	Line impedance stabilization network	SCHWARZBECK	NSLK8127	8127490	2015-01-22	2016-01-21
3	Line impedance stabilization network	ETS	3816/2	00034161	2015-01-22	2016-01-21
4	Spectrum Analyzer	Rohde & Schwarz	FSP-30	2705121009	2015-01-22	2016-01-21
5	EMI test receiver	Rohde & Schwarz	ESU40	100109	2015-02-13	2016-02-12
6	Active Loop Antenna (9kHz to 30MHz)	Schwarzbeck - Mess-Elektronik	FMZB 1519	1519-034	2015-02-07	2016-02-06
7	Broadband UHF-VHF ANTENNA (25MHz to 2GHz)	SCHWARZBECK	VULB9168	9168-313	2015-02-07	2016-02-06
8	Ultra broadband antenna (25MHz to 3GHz)	Rohde & Schwarz	HL562	100227	2014-08-30	2015-08-29
9	Horn Antenna (1GHz to 18GHz)	Rohde & Schwarz	HF906	100284	2015-02-07	2016-02-06
10	Horn Antenna (1GHz to 18GHz)	SCHWARZBECK	BBHA9120D	9120D-679	2015-02-07	2016-02-06
11	Horn Antenna (14GHz to 40GHz)	SCHWARZBECK	BBHA 9170	BBHA9170373	2015-02-13	2016-02-12
12	Pre-amplifier (9KHz – 2GHz)	LNA6900	TESEQ	71033	2014-12-27	2015-12-27
13	Pre-amplifier (1GHz – 26.5GHz)	Rohde & Schwarz	SCU-F0118-G40-BZ4-CSS(F)	10001	2015-01-22	2016-01-21
14	Pre-amplifier (14GHz – 40GHz)	Rohde & Schwarz	SCU-F1840-G35-BZ3-CSS(F)	10001	2015-01-22	2016-01-21
15	Tunable Notch Filter	Wainwright instruments GmbH	WRCT800.0/880.0-0.2/40-5SSK	9170397	/	/
16	High pass Filter	FSCW	HP 12/2800-5AA2	19A45-02	/	/
17	High-low temperature cabinet	Suzhou Zhihe	TL-40	50110050	2014-09-11	2015-09-10
18	AC power stabilizer	WOCEN	6100	51122	2015-01-02	2016-01-01
19	DC power	QJE	QJ30003SII	611145	2015-01-02	2016-01-01
20	Signal Generator (Interferer)	Agilent	SMR40	100555	2014-08-10	2015-08-09
21	Signal Generator (Blocker)	Rohde & Schwarz	SMJ100A	02.20.360.142	2015-01-22	2016-01-21
22	Splitter	Anritsu	MA1612A	M12265	/	/
23	Coupler	e-meca	803-S-1	900-M01	/	/

7 Test results and Measurement Data

7.1 Antenna Requirement

15.203 Requirement:

An intentional radiator shall be designed to ensure that no antenna other than that furnished by the responsible party shall be used with the device. The use of a permanently attached antenna or of an antenna that uses a unique coupling to the intentional radiator, the manufacturer may design the unit so that a broken antenna can be replaced by the user, but the use of a standard antenna jack or electrical connector is prohibited.

The antenna is integrated and no consideration of replacement.

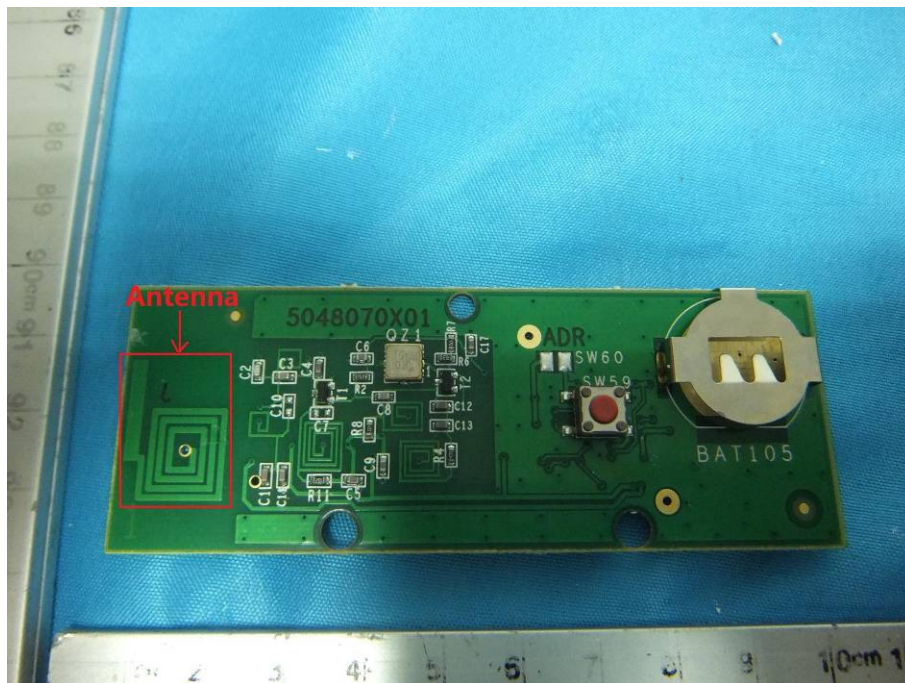

7.2 Conducted Emissions

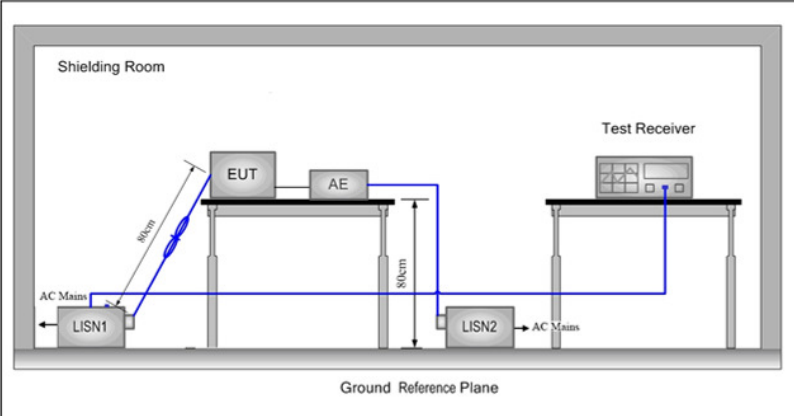
Frequency Range:	150 KHz to 30 MHz		
Limit:	Frequency range MHz	Class B Limits: dB (µV)	
		Quasi-peak	Average
	0.15 to 0.50	66 to 56	56 to 46
	0.50 to 5	56	46
	5 to 30	60	50
	Note1: The limit decreases linearly with the logarithm of the frequency in the range 0.15 MHz to 0.50MHz. Note2: The lower limit is applicable at the transition frequency.		
Test Setup:			
Test Procedure:	<ol style="list-style-type: none"> 1. The mains terminal disturbance voltage was measured with the EUT in a shielded room. 2. The EUT was connected to AC power source through a LISN 1 (Line Impedance Stabilization Network) which provides 50Ω/50µH + 5Ω linear impedance. The power cables of all other units of the EUT were connected to a second LISN, which was bonded to the ground reference plane in the same way as the LISN for the unit being measured. A multiple socket outlet strip was used to connect multiple power cables to a single LISN provided the rating of the LISN was not exceeded. 3. The tabletop EUT was placed upon a non-metallic table 0.8m above the ground reference plane. And for floor-standing arrangement, the EUT was placed on the horizontal ground reference plane, but separated from metallic contact with the ground reference plane by 0.1m of insulation. 4. The test was performed with a vertical ground reference plane. The rear of the EUT shall be 0.4 m from the vertical ground reference plane. The vertical ground reference plane was bonded to the horizontal ground reference plane. The LISN was placed 0.8 m from the boundary of the unit under test and bonded to a ground reference plane for LISN mounted on top of the ground reference plane. This distance was between the closest points of the LISN and the EUT. The mains lead of EUT excess 0.8m was folded back and forth parallel to the lead so as to form a horizontal bundle with a length between 0.3m and 0.4m. All other units of the EUT and associated equipment were at least 0.8 m from the LISN. 		
Test Results:	N/A		

Measurement Data:

This EUT is powered by battery only; therefore the AC Conducted Emission test is not applicable.

7.3 Spurious Emissions

Test frequency range:	9KHz – 6GHz				
Test Site:	Measurement Distance: 3m (Semi-Anechoic Chamber)				
Receiver Setup:	Frequency	Detector	RBW	VBW	Remark
	0.009MHz-0.015MHz	Quasi-peak	200Hz	1KHz	Quasi-peak
	0.015MHz-30MHz	Quasi-peak	9kHz	30KHz	Quasi-peak
	30MHz-1GHz	Quasi-peak	120 kHz	300KHz	Quasi-peak
	Above 1GHz	Peak	1MHz	3MHz	Peak
Peak		1MHz	10Hz	Average	
Limit: (Spurious Emissions)	Frequency	Field strength (microvolt/meter)	Limit (dBuV/m)	Remark	Measurement distance (m)
	0.009MHz-0.490MHz	2400/F(kHz)	-	Quasi-peak	300
	0.490MHz-1.705MHz	24000/F(kHz)	-	Quasi-peak	30
	1.705MHz-30MHz	30	-	Quasi-peak	30
	30MHz-88MHz	100	40.0	Quasi-peak	3
	88MHz-216MHz	150	43.5	Quasi-peak	3
	216MHz-960MHz	200	46.0	Quasi-peak	3
	960MHz-1GHz	500	54.0	Quasi-peak	3
			54.0	Average	3
Above 1GHz	500	74.0	Peak	3	
Limit: (Field strength of the fundamental signal)	Frequency	Limit (dBuV/m @3m)		Remark	
	433.09 - 434.61MHz	80.83		Average Value	
		100.83		Peak Value	
Test Procedure:	<p>a. The EUT was placed on the top of a rotating table 0.8 meters above the ground at a 3 meter semi-anechoic chamber. The table was rotated 360 degrees to determine the position of the highest radiation.</p> <p>b. The EUT was set 3 meters away from the interference-receiving antenna, which was mounted on the top of a variable-height antenna tower.</p> <p>c. The antenna height is varied from one meter to four meters above the ground to determine the maximum value of the field strength. Both horizontal and vertical polarizations of the antenna are set to make the measurement.</p> <p>d. For each suspected emission, the EUT was arranged to its worst case and then the antenna was tuned to heights from 1 meter to 4 meters (for the test frequency of below 30MHz, the antenna was tuned to heights 1 meter) and the rotatable table was turned from 0 degrees to 360 degrees to find the maximum reading.</p> <p>e. The test-receiver system was set to Peak Detect Function and Specified Bandwidth with Maximum Hold Mode.</p> <p>f. If the emission level of the EUT in peak mode was 10dB lower than the limit specified, then testing could be stopped and the peak values of the EUT would be reported. Otherwise the emissions that did not have 10dB margin would be re-tested one by one using peak, quasi-peak or average method as specified and then reported in a data sheet.</p> <p>g. The radiation measurements are performed in X, Y, Z axis positioning. And found the Z axis positioning which it is worse case, only the test worst case mode is recorded in the report.</p>				

Test Setup:

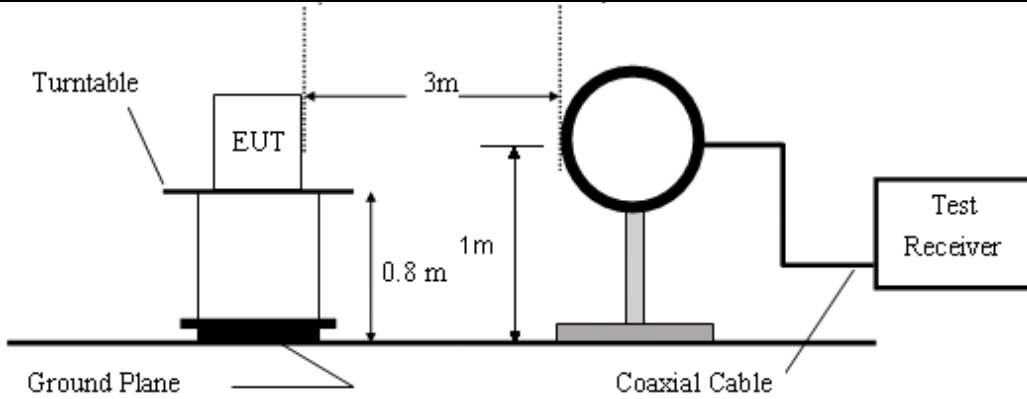

Figure1. 30MHz to 1GHz radiated emissions test configuration

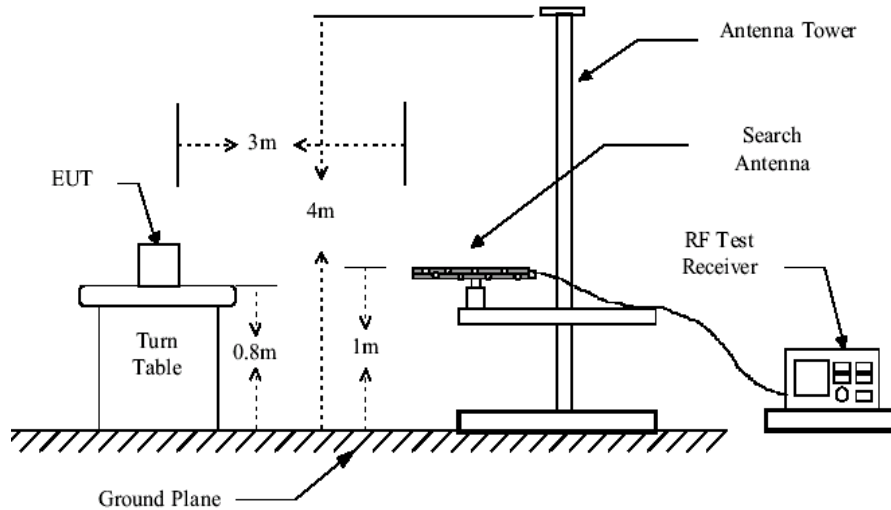

Figure2. 30MHz to 1GHz radiated emissions test configuration

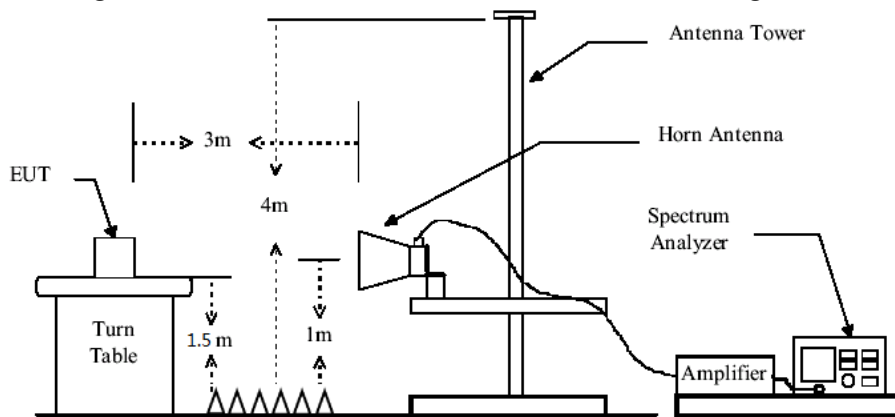

Figure3. Above 1GHz radiated emissions test configuration

Test Results: Pass

7.3.1 Field Strength of the Fundamental Signal

Test channel	Freq. (MHz)	Result Level (dB μ V/m)	Limit Line (dB μ V/m)	Over Limit (dB)	Detector	Polarization
Channel 1	433.92	93.34	100.83	-7.49	Peak	VERTICAL
		76.23	80.83	-4.60	AV	HORIZONTAL
		95.80	100.83	-5.03	Peak	VERTICAL
		78.65	80.83	-2.18	AV	HORIZONTAL

Remark: If the Peak value below the AV Limit, the AV test doesn't perform for this submission.

7.3.2 Spurious Emissions

Below 1GHz

Vertical:

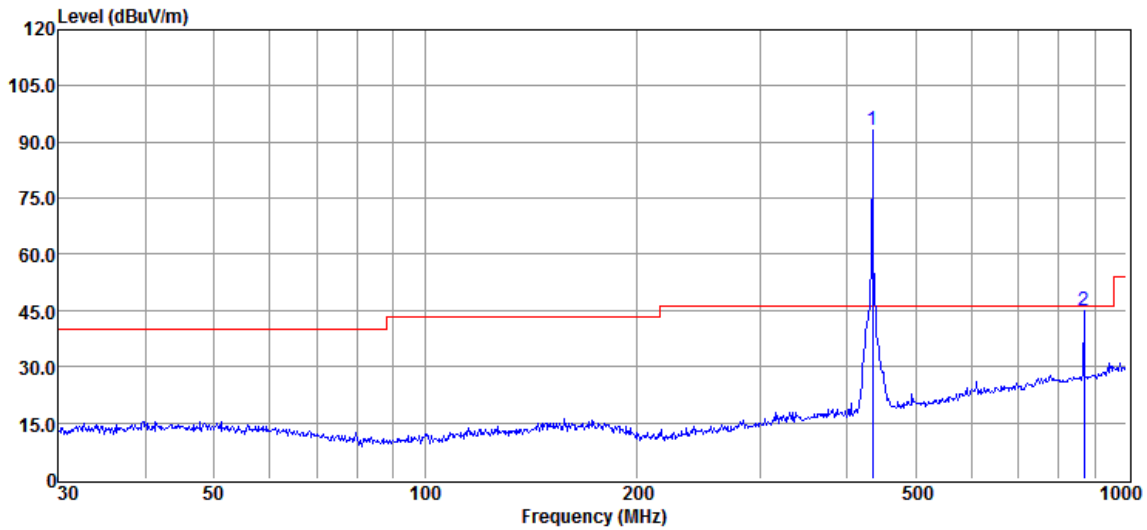

Item	Freq.	Read Level	Antenna Factor	Preamp Factor	Cable Loss	Result Level	Limit Line	Over Limit	Detector	Polarization
(Mark)	(MHz)	(dBμV)	(dB/m)	(dB)	(dB)	(dBμV/m)	(dBμV/m)	(dB)		
1	433.92	99.25	15.52	23.71	2.28	Fundamental signal			Peak	Horizontal
2	869.130	43.29	22.29	23.93	3.37	45.02	61.94	-16.92	QP	Vertical

Horizontal:

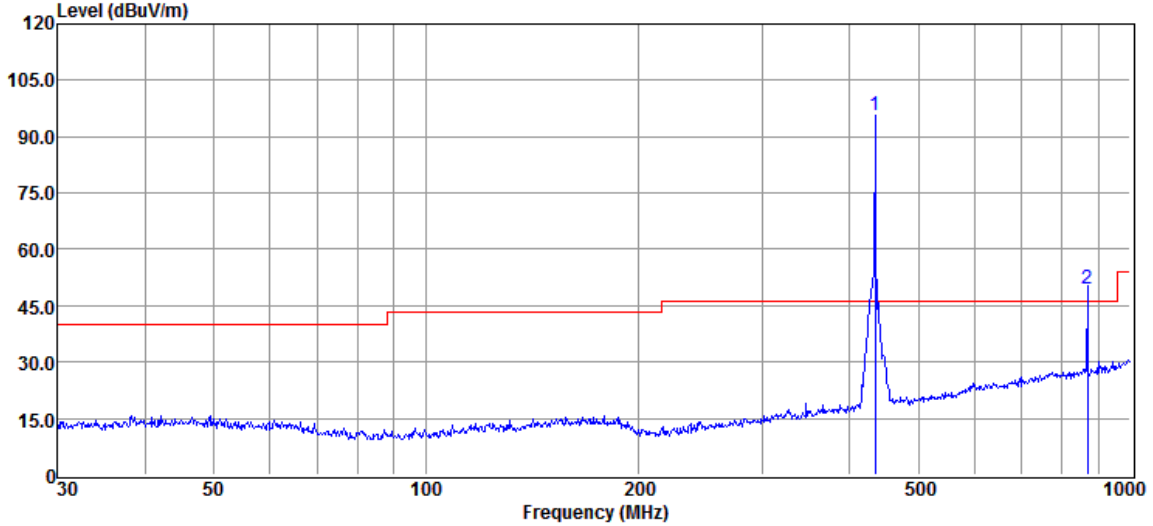

Item	Freq.	Read Level	Antenna Factor	Preamp Factor	Cable Loss	Result Level	Limit Line	Over Limit	Detector	Polarization
(Mark)	(MHz)	(dB μ V)	(dB/m)	(dB)	(dB)	(dB μ V/m)	(dB μ V/m)	(dB)		
1	433.92	101.71	15.52	23.71	2.28	Fundamental signal			Peak	Horizontal
2	869.130	47.68	22.29	23.93	3.37	49.41	60.83	-11.41	QP	Vertical

1GHz – 6GHz

Peak Value:

Freq (MHz)	Read Level (dB μ V)	Antenna Factor (dB/m)	Result Level (dB μ V/m)	Limit Line (dB μ V/m)	Over Limit (dB)	Polarization
1293.75	57.09	-7.41	49.68	54	-4.32	Vertical
1728.5	58.72	-5.05	53.67	54	-0.33	Vertical
2163.25	51.49	-2.93	48.56	54	-5.44	Vertical
1293.75	50.53	-7.41	43.12	54	-10.88	Horizontal
1728.5	58.65	-5.05	53.60	54	-0.40	Horizontal
2163.25	52.88	-2.93	49.95	54	-4.05	Horizontal

Remark:

- 1) The field strength is calculated by adding the Antenna Factor, Cable Factor & Preamplifier. The basic equation with a sample calculation is as follows:
Final Test Level = Receiver Reading Level + Antenna Factor + Cable Factor – Preamplifier Factor
- 2) If Peak Result comply with AV limit, AV Result is deemed to comply with QP limit
- 3) No any other emissions level which are attenuated less than 20dB below the limit. According to 15.31(o), the amplitude of spurious emissions from intentional radiators and emissions from unintentional radiators which are attenuated more than 20 dB below the permissible value need not be reported unless specifically required elsewhere in this Part. Hence there no other emissions have been reported.

7.4 20dB Bandwidth

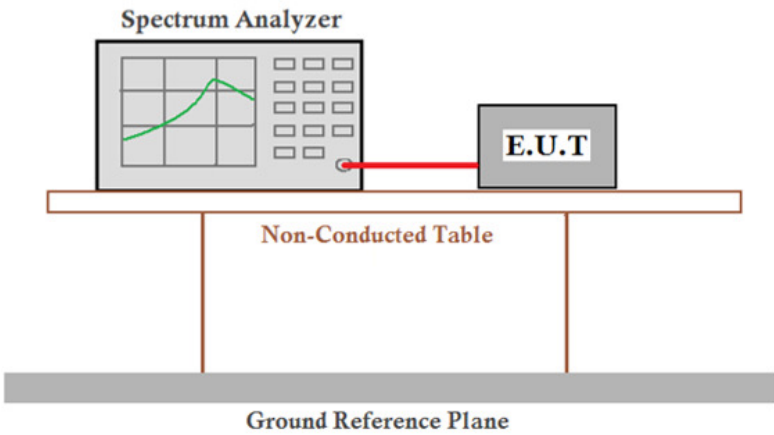
<p>Test Setup:</p>	
<p>Limit:</p>	<p>The bandwidth of the emission shall be no wider than 0.25% of the center frequency for devices operating above 70 MHz and below 900 MHz. For devices operating above 900 MHz, the emission shall be no wider than 0.5% of the center frequency. Bandwidth is determined at the points 20 dB down from the modulated carrier.</p>
<p>Test Mode:</p>	<p>Transmitting mode</p>
<p>Test Results:</p>	<p>Pass</p>

Measurement Data:

Channel	Frequency(MHz)	20dB bandwidth (kHz)	Limit (kHz)	Results
1	433.92	3.386	1084.8	Pass

Test plot as follows:

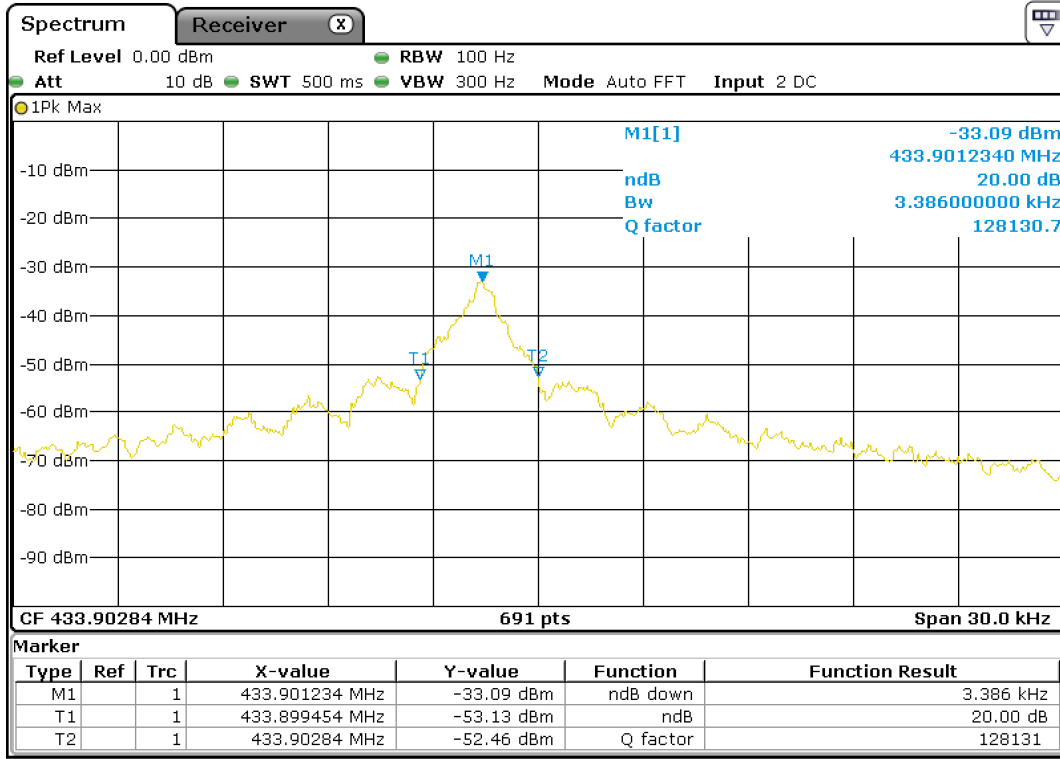

7.5 Dwell Time

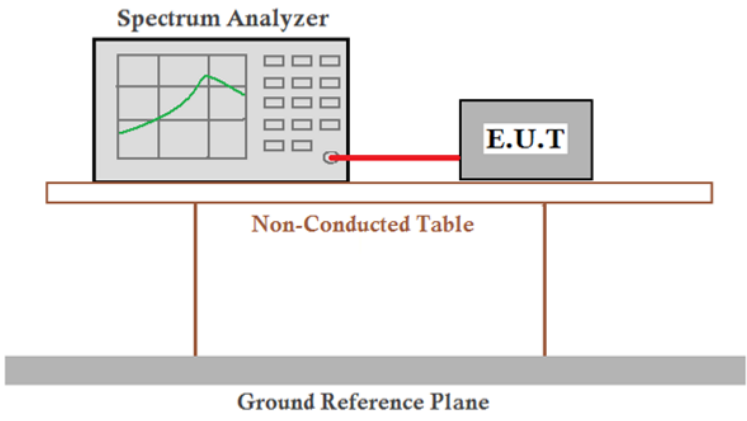
Test Setup:	
Limit:	15.231 (a): Not more than 5 seconds
Test Results:	Pass

Measurement Data:

The device is a manually operated transmitter which is employed for common radio control purposes.

Test item	Limit (s)	Results
Transmission Duration	≤5s	Pass

Test plot as follows:

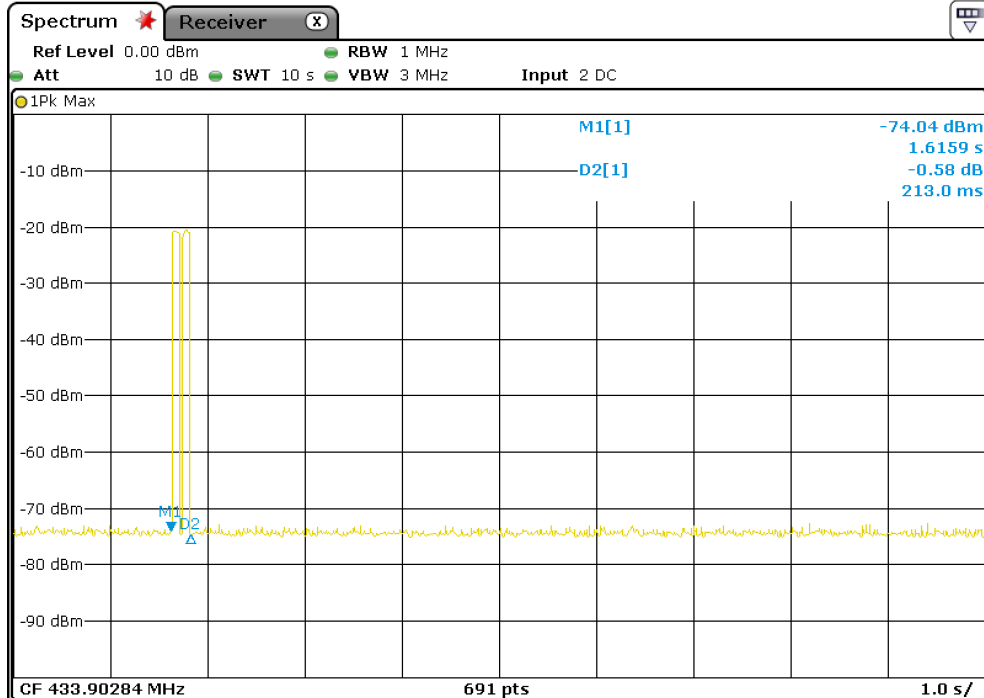
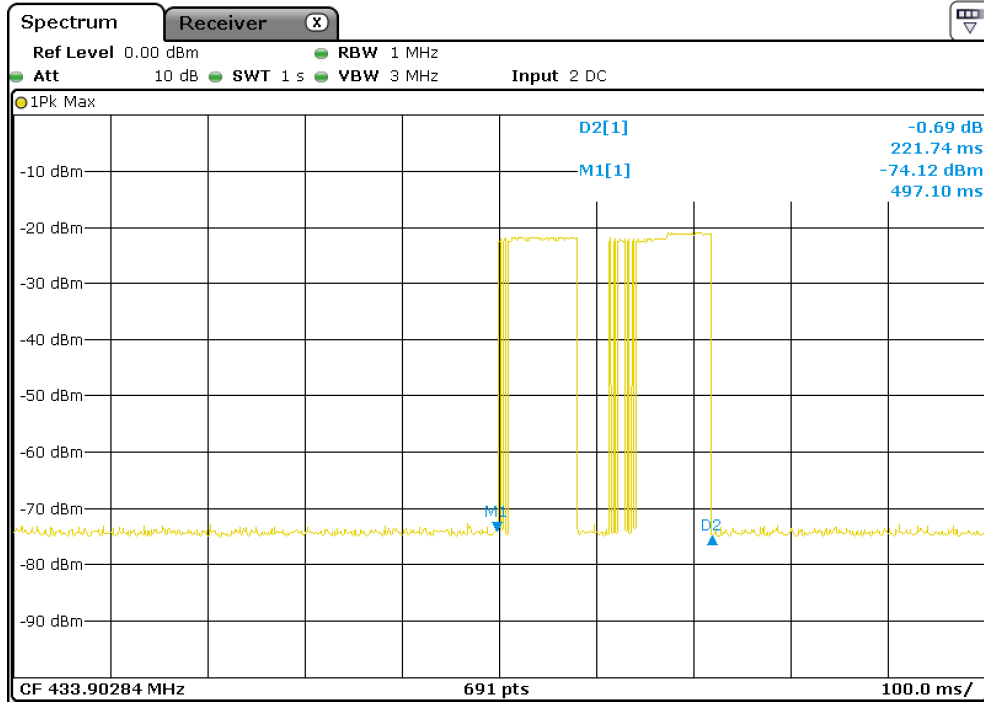

8 Test Setup Photographs

Refer to the < RTA SCE – R5 Green _Test Setup photos-FCC>.

9 EUT Constructional Details

Refer to the < RTA SCE – R5 Green _External Photos-FCC> & < RTA SCE – R5 Green _Internal Photos-FCC>.

--End of the Report--