

FCC TEST REPORT

FOR

Dongguan Jinhongmei Electronics Co., Ltd

Shutter Camera

Model No.: JHM-821

Additional Model No.: Please refer to page 5.

Prepared for : Dongguan Jinhongmei Electronics Co., Ltd
Address : 4~5/F., Block A, No.9 Hebeiling Road 2, Guanjintou Village,
Fenggang Town, Dongguan City, G.D., China

Prepared by : Shenzhen LCS Compliance Testing Laboratory Ltd.
Address : 1/F., Xingyuan Industrial Park, Tongda Road, Bao'an Avenue, Bao'an
District, Shenzhen, Guangdong, China

Tel : (+86)755-82591330
Fax : (+86)755-82591332
Web : www.LCS-cert.com
Mail : webmaster@LCS-cert.com

Date of receipt of test sample : August 27, 2015
Number of tested samples : 1
Serial number : Prototype
Date of Test : August 27, 2015 – September 10, 2015
Date of Report : September 10, 2015

FCC TEST REPORT

FCC CFR 47 PART 15 C(15.247): 2014

Report Reference No. : LCS1508271582E

Date of Issue : September 10, 2015

Testing Laboratory Name..... : Shenzhen LCS Compliance Testing Laboratory Ltd.

Address : 1/F., Xingyuan Industrial Park, Tongda Road, Bao'an Avenue, Bao'an District, Shenzhen, Guangdong, China

Testing Location/ Procedure..... : Full application of Harmonised standards ■
Partial application of Harmonised standards □
Other standard testing method □

Applicant's Name : Dongguan Jinhongmei Electronics Co., Ltd

Address : 4~5/F., Block A, No.9 Hebeiling Road 2, Guanjintou Village, Fenggang Town, Dongguan City, G.D., China

Test Specification

Standard : FCC CFR 47 PART 15 C(15.247): 2014

Test Report Form No..... : LCSEMC-1.0

TRF Originator : Shenzhen LCS Compliance Testing Laboratory Ltd.

Master TRF..... : Dated 2011-03

Shenzhen LCS Compliance Testing Laboratory Ltd. All rights reserved.

This publication may be reproduced in whole or in part for non-commercial purposes as long as the Shenzhen LCS Compliance Testing Laboratory Ltd. is acknowledged as copyright owner and source of the material. Shenzhen LCS Compliance Testing Laboratory Ltd. takes no responsibility for and will not assume liability for damages resulting from the reader's interpretation of the reproduced material due to its placement and context.

Test Item Description. : Shutter Camera

Trade Mark : OEM

Model/ Type reference..... : JHM-821

Ratings : DC 3V by battery (160mAh)

Result : Positive

Compiled by:

Kyle Yin

Supervised by:

Glin Lu

Approved by:

Gavin Liang

Kyle Yin/ File administrators

Glin Lu/ Technique principal

Gavin Liang/ Manager

FCC -- TEST REPORT

Test Report No. : LCS1508271582E	<u>September 10, 2015</u> Date of issue
---	--

Type / Model..... : JHM-821 EUT..... : Shutter Camera
Applicant..... : Dongguan Jinhongmei Electronics Co., Ltd Address..... : 4~5/F., Block A, No.9 Hebeiling Road 2, Guanjintou Village, Fenggang Town, Dongguan City, G.D., China Telephone..... : / Fax..... : /
Manufacturer..... : Dongguan Jinhongmei Electronics Co., Ltd Address..... : 4~5/F., Block A, No.9 Hebeiling Road 2, Guanjintou Village, Fenggang Town, Dongguan City, G.D., China Telephone..... : / Fax..... : /
Factory..... : Dongguan Jinhongmei Electronics Co., Ltd Address..... : 4~5/F., Block A, No.9 Hebeiling Road 2, Guanjintou Village, Fenggang Town, Dongguan City, G.D., China Telephone..... : / Fax..... : /

Test Result	Positive
--------------------	-----------------

The test report merely corresponds to the test sample.
 It is not permitted to copy extracts of these test result without the written permission of the test laboratory.

TABLE OF CONTENTS

Description	Page
1. GENERAL INFORMATION	5
1.1 Description of Device (EUT)	5
1.2 Support equipment List	5
1.3 External I/O Cable	5
1.4 Description of Test Facility	6
1.5 Statement of The Measurement Uncertainty	6
1.6 Measurement Uncertainty	7
1.7 Description Of Test Modes	7
2. TEST METHODOLOGY	8
2.1 EUT Configuration	8
2.2 EUT Exercise	8
2.3 General Test Procedures	8
3. SYSTEM TEST CONFIGURATION	9
3.1 Justification	9
3.2 EUT Exercise Software	9
3.3 Special Accessories	9
3.4 Block Diagram/Schematics	9
3.5 Equipment Modifications	9
3.6 Test Setup	9
4. SUMMARY OF TEST RESULTS	10
5. SUMMARY OF TEST EQUIPMENT	11
6. ANTENNA PORT MEASUREMENT	12
6.1 Peak Power	12
6.2 Frequency Separation And 20 dB Bandwidth	13
6.3 Number Of Hopping Frequency	22
6.4 Time Of Occupancy (Dwell Time)	24
6.5 Conducted Spurious Emissions and Band Edges Test	27
7. RADIATED MEASUREMENT	34
7.1 Block Diagram of Test Setup	34
7.2 Radiated Emission Limit	35
7.3 Instruments Setting	36
7.4 Test Procedures	37
7.5 Results for Radiated Emissions	40
7.6 Results for Band edge Testing (Radiated)	43
7.7. Power line conducted emissions	44
8. ANTENNA REQUIREMENT	45
8.1 Standard Applicable	45
8.2 Antenna Connected Construction	45

1. GENERAL INFORMATION

1.1 Description of Device (EUT)

EUT : Shutter Camera

Model No. : JHM-821

Frequency Range : 2.402-2.480GHz

Channel Number : 79 channels

Channel frequency : 2402.00-2480.00MHz (Channel Frequency=2402+1(K-1), K=1, 2, 379);

Channel Spacing : 1MHz

Modulation Type : GFSK, π /4-DQPSK, 8-DPSK

Bluetooth Version : V3.0

Antenna Gain : Internal antenna, 2.0dBi(Max.)

Input Voltage : DC 3V by battery (160mAh)

Additional models No.			
JHM-822	--	--	--
<i>Remark: PCB board, structure and internal of these model(s) are the same, So no additional models were tested.</i>			

1.2 Support equipment List

Manufacturer	Description	Model	Serial Number	Certificate
--	--	--	--	--

1.3 External I/O Cable

I/O Port Description	Quantity	Cable
--	--	--

1.4 Description of Test Facility

Site Description

EMC Lab. : CNAS Registration Number. is L4595.
FCC Registration Number. is 899208.
Industry Canada Registration Number. is 9642A-1.
VCCI Registration Number. is C-4260 and R-3804.
ESMD Registration Number. is ARCB0108.
UL Registration Number. is 100571-492.
TUV SUD Registration Number. is SCN1081.
TUV RH Registration Number. is UA 50296516-001

1.5 Statement of The Measurement Uncertainty

The data and results referenced in this document are true and accurate. The reader is cautioned that there may be errors within the calibration limits of the equipment and facilities. The measurement uncertainty was calculated for all measurements listed in this test report acc. To CISPR 16 – 4 “Specification for radio disturbance and immunity measuring apparatus and methods – Part 4: Uncertainty in EMC Measurements” and is documented in the LCS quality system acc. To DIN EN ISO/IEC 17025. Furthermore, component and process variability of devices similar to that tested may result in additional deviation. The manufacturer has the sole responsibility of continued compliance of the device.

1.6 Measurement Uncertainty

Test Item	Frequency Range	Uncertainty	Note
Radiation Uncertainty :	9KHz~30MHz	3.10dB	(1)
	30MHz~200MHz	2.96dB	(1)
	200MHz~1000MHz	3.10dB	(1)
	1GHz~26.5GHz	3.80dB	(1)
	26.5GHz~40GHz	3.90dB	(1)
Conduction Uncertainty :	150kHz~30MHz	1.63dB	(1)
Power disturbance :	30MHz~300MHz	1.60dB	(1)

(1). This uncertainty represents an expanded uncertainty expressed at approximately the 95% confidence level using a coverage factor of k=2.

1.7 Description Of Test Modes

Bluetooth operates in the unlicensed ISM Band at 2.4GHz. With the introduction of the enhanced data rate (EDR) feature, the data rates can be up to 3 Mb/s. An increase in the peak data rate beyond the basic rate of 1 Mb/s is achieved by modulating the RF carrier using GFSK techniques, resulting in an increase of two to three times the number of bits per symbol. The 2 Mb/s EDR packets use $\pi/4$ -DQPSK modulation and the 3 Mb/s EDR packets use 8DPSK modulation. X, Y, Z position have been tested. The following operating modes were applied for the related test items. All test modes were tested, only the result of the worst case was recorded in the report.

Mode of Operations	Frequency Range (MHz)	Data Rate (Mbps)
GFSK	2402	1
	2441	1
	2480	1
$\pi/4$ DQPSK	2402	2
	2441	2
	2480	2
8-DPSK	2402	3
	2441	3
	2480	3
For Conducted Emission		
Test Mode	TX Mode	
For Radiated Emission		
Test Mode	TX Mode	

Worst-case mode and channel used for 150kHz-30 MHz power line conducted emissions was the mode and channel with the highest output power, that was determined to be TX(1Mbps- Low Channel).

Worst-case mode and channel used for 9kHz-1000 MHz radiated emissions was the mode and channel with the highest output power, that was determined to be TX(1Mbps---Low Channel).

2. TEST METHODOLOGY

The tests documented in this report were performed in accordance with ANSI C63.10-2013, RSS-210, FCC CFR PART 15C 15.207, 15.209, 15.247 and DA 00-705.

2.1 EUT Configuration

The EUT configuration for testing is installed on RF field strength measurement to meet the Commissions requirement and operating in a manner that intends to maximize its emission characteristics in a continuous normal application.

2.2 EUT Exercise

The EUT was operated in the engineering mode to fix the TX frequency that was for the purpose of the measurements.

According to its specifications, the EUT must comply with the requirements of the Section 15.207, 15.209, 15.247 under the FCC Rules Part 15 Subpart C and RSS-210.

2.3 General Test Procedures

2.3.1 Conducted Emissions

The EUT is placed on the turntable, which is 0.8 m above ground plane. According to the requirements in Section 6.2.1 of ANSI C63.10-2013 Conducted emissions from the EUT measured in the frequency range between 0.15 MHz and 30MHz using Quasi-peak and average detector modes.

2.3.2 Radiated Emissions

The EUT is placed on a turn table 0.8 meter above ground for below 1GHz and 1.5m for above 1GHz. The turntable shall rotate 360 degrees to determine the position of maximum emission level. EUT is set 3m away from the receiving antenna, which varied from 1m to 4m to find out the highest emission. And also, each emission was to be maximized by changing the polarization of receiving antenna both horizontal and vertical. In order to find out the maximum emissions, exploratory radiated emission measurements were made according to the requirements in Section 6.3 of ANSI C63.10-2013

3. SYSTEM TEST CONFIGURATION

3.1 Justification

The system was configured for testing in a continuous transmit condition.

3.2 EUT Exercise Software

N/A.

3.3 Special Accessories

N/A.

3.4 Block Diagram/Schematics

Please refer to the related document.

3.5 Equipment Modifications

Shenzhen LCS Compliance Testing Laboratory Ltd. has not done any modification on the EUT.

3.6 Test Setup

Please refer to the test setup photo.

4. SUMMARY OF TEST RESULTS

Applied Standard: FCC Part 15 Subpart C		
FCC Rules	Description of Test	Result
§15.247(a)	Maximum Conducted Output Power	Compliant
§15.247(c)	Frequency Separation And 20 dB Bandwidth	Compliant
§15.247(a)(1)(ii)	Number Of Hopping Frequency	Compliant
§15.247(a)(1)(iii)	Time Of Occupancy (Dwell Time)	Compliant
§15.209, §15.205	Conducted Spurious Emissions and Band Edges Test	Compliant
§15.209, §15.247(d)	Radiated and Conducted Spurious Emissions	Compliant
§15.205	Emissions at Restricted Band	Compliant
§15.207(a)	Conducted Emissions	N/A
§15.203	Antenna Requirements	Compliant
§15.247(i) §2.1093	RF Exposure	Compliant

Note:

1. "N/A" means this test item is not applicable.

5. SUMMARY OF TEST EQUIPMENT

Item	Equipment	Manufacturer	Model No.	Serial No.	Last Cal.	Next Cal.
1	Power Sensor	R&S	NRV-Z51	100458	2015-06-18	2016-06-17
2	Power Sensor	R&S	NRV-Z32	10057	2015-06-18	2016-06-17
3	Power Meter	R&S	NRVS	100444	2015-06-18	2016-06-17
4	DC Filter	MPE	23872C	N/A	2015-06-18	2016-06-17
5	RF Cable	Harbour Industries	1452	N/A	2015-06-18	2016-06-17
6	SMA Connector	Harbour Industries	9625	N/A	2015-06-18	2016-06-17
7	Spectrum Analyzer	Agilent	N9020A	MY50510140	2014-10-27	2015-10-26
8	Signal analyzer	Agilent	E4448A(External mixers to 40GHz)	US44300469	2015-06-16	2016-06-15
9	RF Cable	Hubersuhne	Sucoflex104	FP2RX2	2015-06-18	2016-06-17
10	3m Semi Anechoic Chamber	SIDT FRANKONIA	SAC-3M	03CH03-HY	2015-06-18	2016-06-17
11	Amplifier	SCHAFFNER	COA9231A	18667	2015-06-18	2016-06-17
12	Amplifier	Agilent	8449B	3008A02120	2015-06-16	2016-06-15
13	Amplifier	MITEQ	AMF-6F-260400	9121372	2015-06-16	2016-06-15
14	Loop Antenna	R&S	HFH2-Z2	860004/001	2015-06-18	2016-06-17
15	By-log Antenna	SCHWARZBECK	VULB9163	9163-470	2015-06-10	2016-06-09
16	Horn Antenna	EMCO	3115	6741	2015-06-10	2016-06-09
17	Horn Antenna	SCHWARZBECK	BBHA9170	BBHA9170154	2015-06-10	2016-06-09
18	RF Cable-R03m	Jye Bao	RG142	CB021	2015-06-18	2016-06-17
19	RF Cable-HIGH	SUHNER	SUCOFLEX 106	03CH03-HY	2015-06-18	2016-06-17
20	EMI Test Receiver	ROHDE & SCHWARZ	ESCI	101142	2015-06-18	2016-06-17
21	EMI Test Receiver	ROHDE & SCHWARZ	ESPI	101840	2015-06-18	2016-06-17
22	Artificial Mains	ROHDE & SCHWARZ	ENV216	101288	2015-06-18	2016-06-17
23	EMI Test Software	AUDIX	E3	N/A	2015-06-18	2016-06-17

6. ANTENNA PORT MEASUREMENT

6.1 Peak Power

6.1.1 Block Diagram of Test Setup

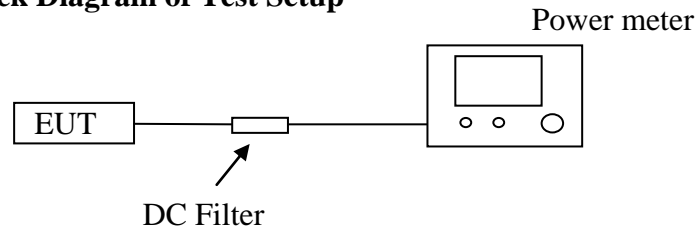

6.1.2 Limit

For frequency hopping systems operating in the 2400–2483.5MHz band employing at least 75 non-overlapping hopping channels, and all frequency hopping systems in the 5725–5850 MHz band: 1 watt. for all other frequency hopping systems in the 2400–2483.5 MHz band: 0.125 watts.

6.1.3 Test Procedure

The transmitter output is connected to the Power Meter.

6.1.4 Test Results

Channel	Frequency (MHz)	Peak Output Power (dBm)	Peak Output Power (mW)	Limit (mW)	Result
GFSK	2402	0.85	1.22	1000	Pass
	2441	0.37	1.09	1000	Pass
	2480	0.56	1.14	1000	Pass
π / 4-DQPSK	2402	-1.15	0.77	125	Pass
	2441	-0.44	0.90	125	Pass
	2480	-0.31	0.93	125	Pass
8-DPSK	2402	-1.25	0.75	125	Pass
	2441	-0.67	0.86	125	Pass
	2480	-1.85	0.65	125	Pass

6.2 Frequency Separation And 20 dB Bandwidth

6.2.1 Limit

According to §15.247(c), in any 100 kHz bandwidth outside the frequency bands in which the spread spectrum intentional radiator is operating, the radio frequency power that is produced by the intentional radiator shall be at least 20dB below that in the 100kHz bandwidth within the band that contains the highest level of the desired power. In addition, radiated emissions which fall in the restricted bands, as defined in §15.205(a), must also comply with the radiated emission limits specified in 15.209(a).

6.2.2 Block Diagram of Test Setup

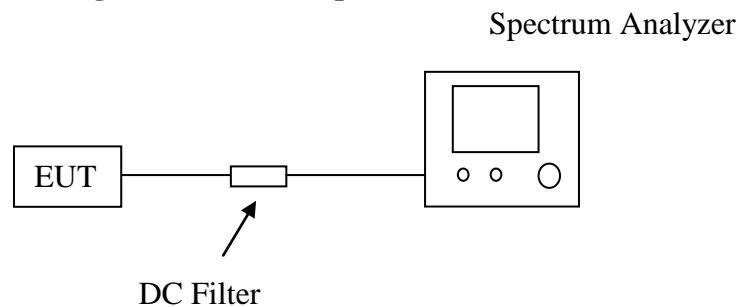

6.2.3 Test Procedure

Frequency separation test procedure:

- A. Place the EUT on the table and set it in transmitting mode.
- B. Remove the antenna from the EUT and then connect a low loss RF cable from the antenna port to the Spectrum Analyzer.
- C. Set center frequency of Spectrum Analyzer = middle of hopping channel.
- D. Set the Spectrum Analyzer as RBW = 100kHz, VBW = 300kHz, Span = wide enough to capture the peaks of two adjacent channels, Sweep = auto.
- E. Max hold, mark 2 peaks of hopping channel and record the 2 peaks frequency.

20dB bandwidth test procedure:

- A. Span = approximately 2 to 3 times the 20 dB bandwidth, centered on a hopping channel.
- B. $RBW \geq 1\%$ of the 20 dB bandwidth, $VBW \geq RBW$.
- C. Detector function = peak.
- D. Trace = max hold.

6.2.4 Test Results

The Measurement Result With 1Mbps For GFSK Modulation				
Channel	20dB Bandwidth (KHz)	Channel Separation (MHz)	Limit (MHz)	Result
Low	856.251	1.000	≥ 25 KHz or 20 dB BW	Pass
Middle	853.918		≥ 25 KHz or 20 dB BW	Pass
High	858.068		≥ 25 KHz or 20 dB BW	Pass

The Measurement Result With 2Mbps For $\pi/4$ DQPSK Modulation				
Channel	20dB Bandwidth (MHz)	Channel Separation (MHz)	Limit (MHz)	Result
Low	1.227	1.000	≥ 25 KHz or 2/3 20 dB BW	Pass
Middle	1.219		≥ 25 KHz or 2/3 20 dB BW	Pass
High	1.246		≥ 25 KHz or 2/3 20 dB BW	Pass

The Measurement Result With 3Mbps For 8-DPSK Modulation				
Channel	20dB Bandwidth (MHz)	Channel Separation (MHz)	Limit (MHz)	Result
Low	1.220	1.000	≥ 25 KHz or 2/3 20 dB BW	Pass
Middle	1.219		≥ 25 KHz or 2/3 20 dB BW	Pass
High	1.213		≥ 25 KHz or 2/3 20 dB BW	Pass

The test data refer to the following page.

Test Plot Of Frequency Separation (1Mbps)

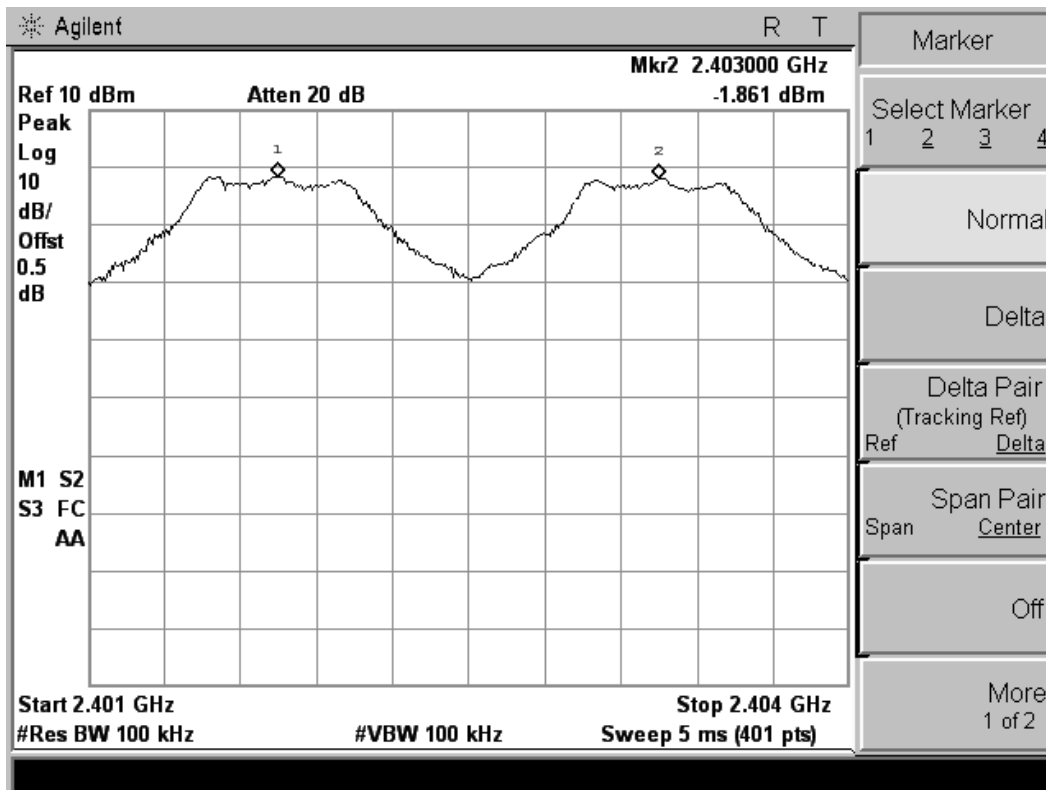

Test Plot Of Frequency Separation (2Mbps)

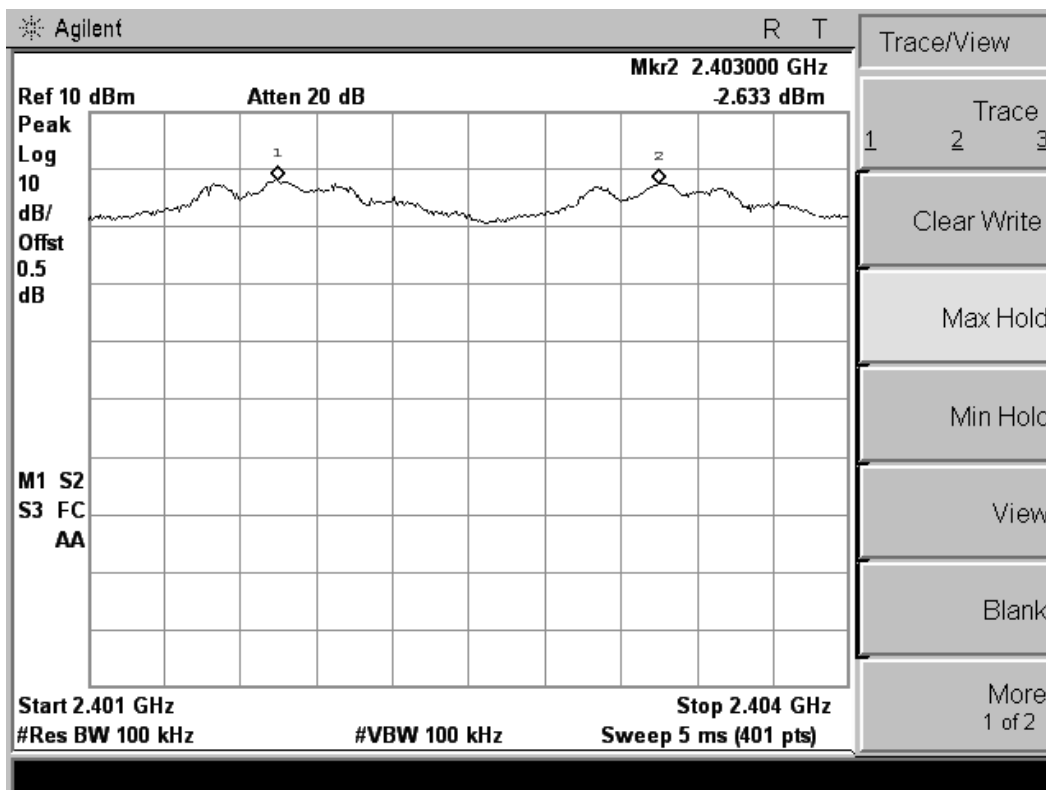

Test Plot Of Frequency Separation (3Mbps)

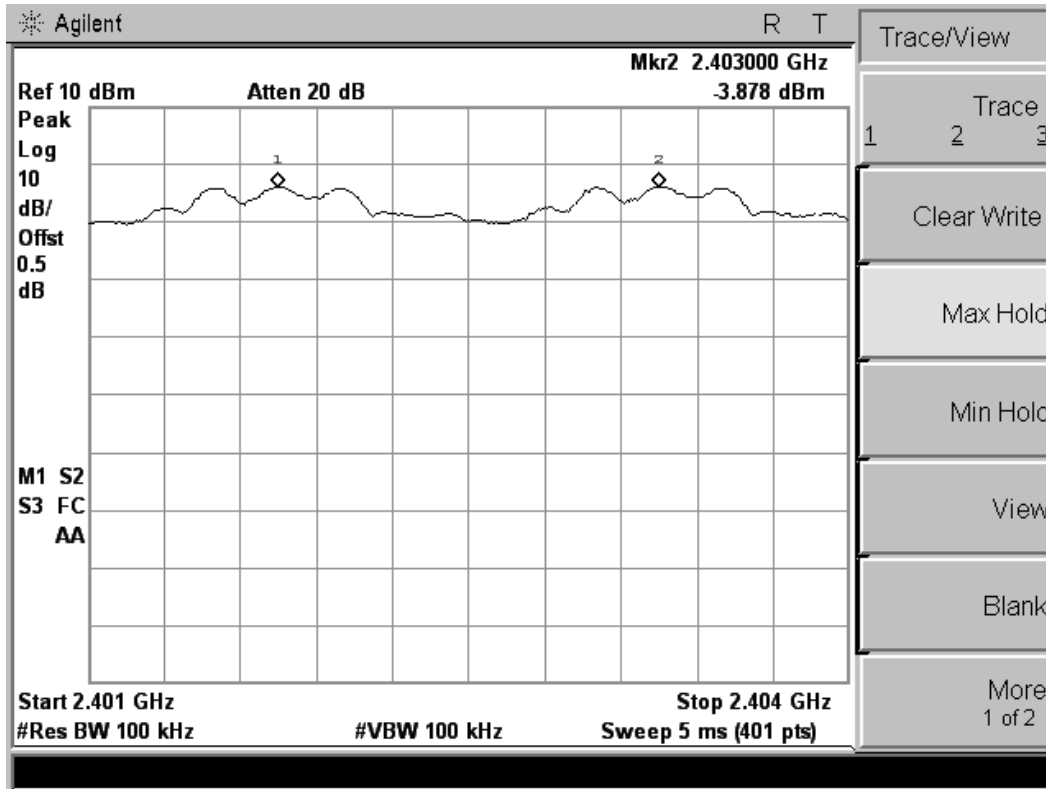

Measurement of 20dB Bandwidth

Test frequency: 2402MHz(1Mbps)

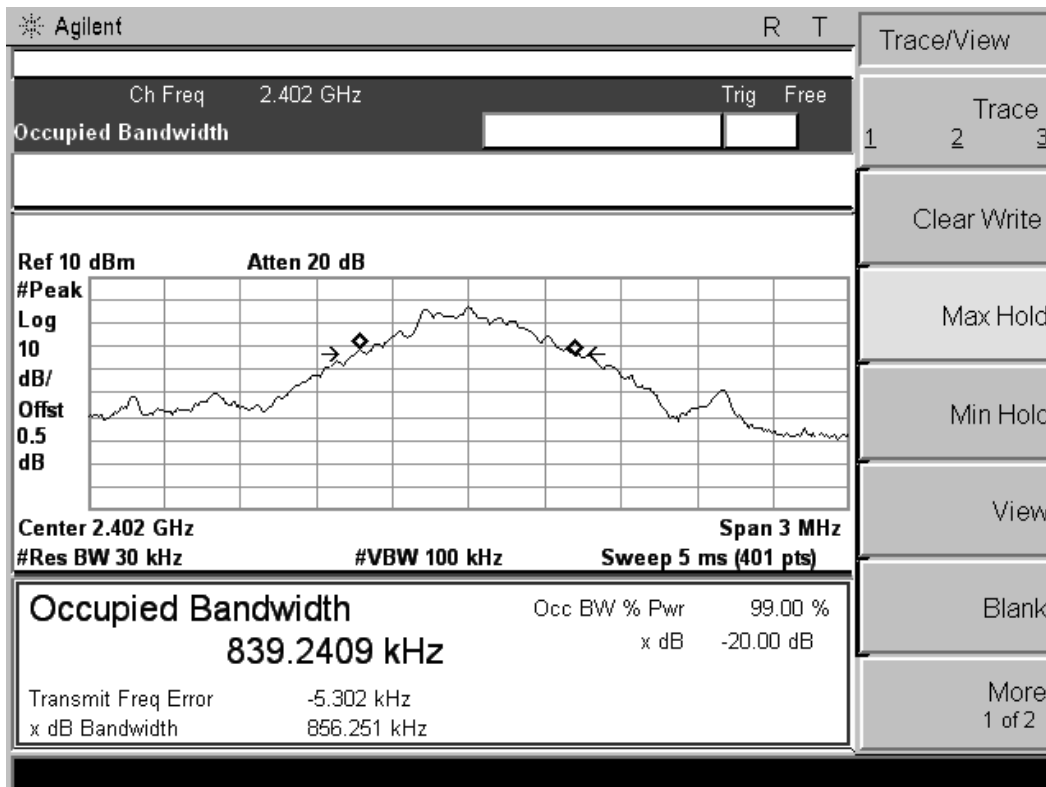

Test frequency: 2441MHz(1Mbps)

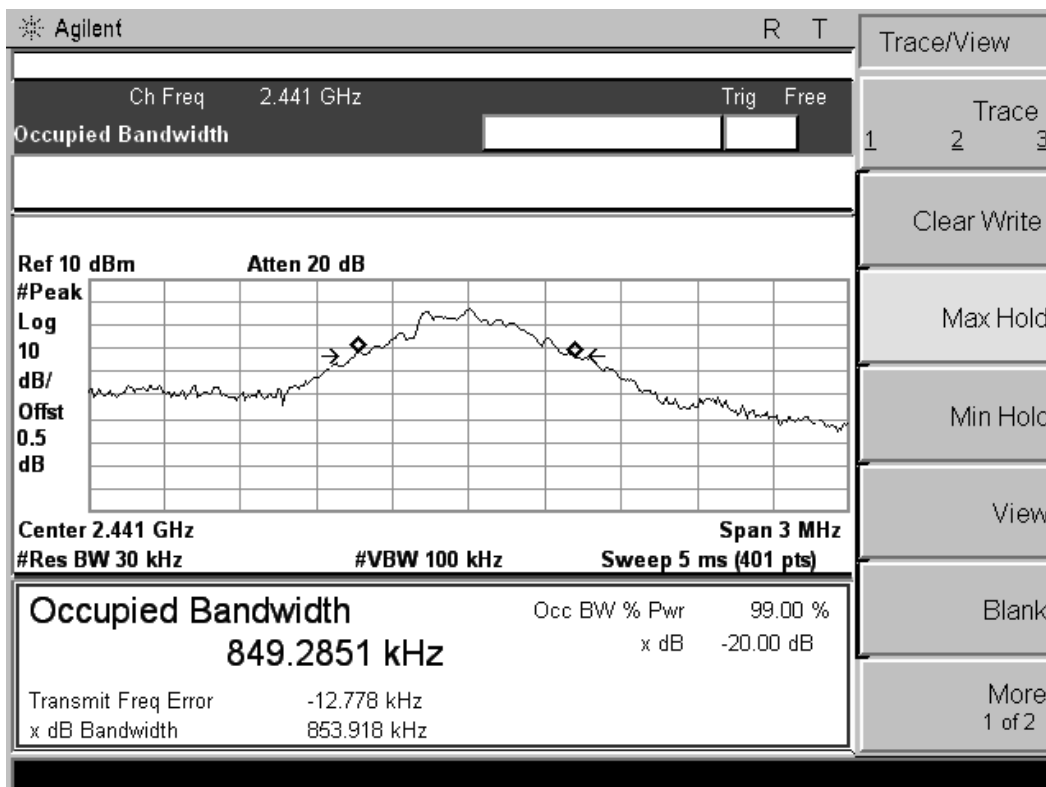

Test frequency: 2480MHz(1Mbps)

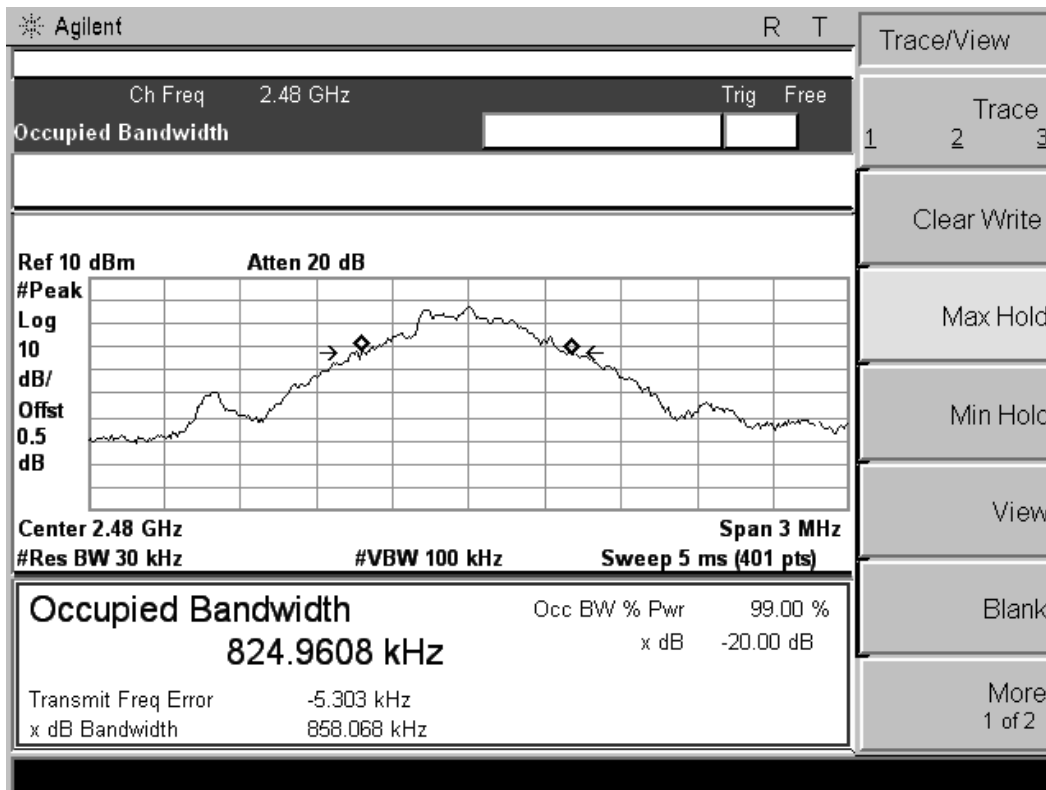

Test frequency: 2402MHz(2Mbps)

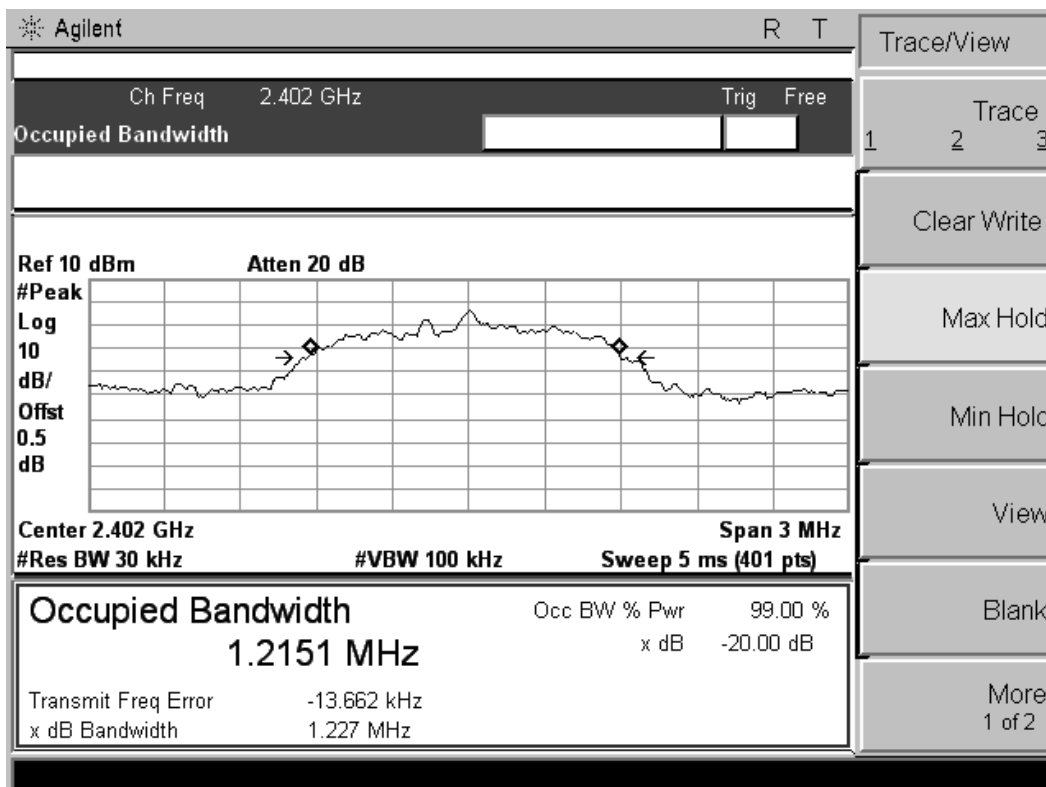

Test frequency: 2441MHz(2Mbps)

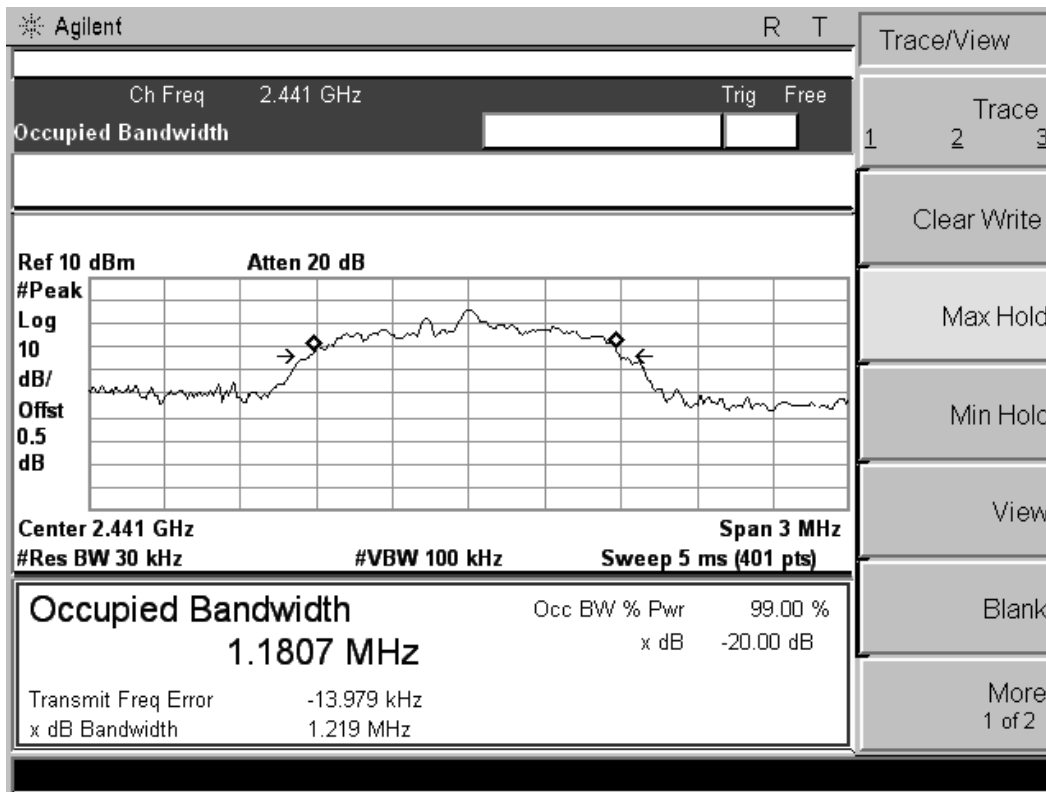

Test frequency: 2480MHz(2Mbps)

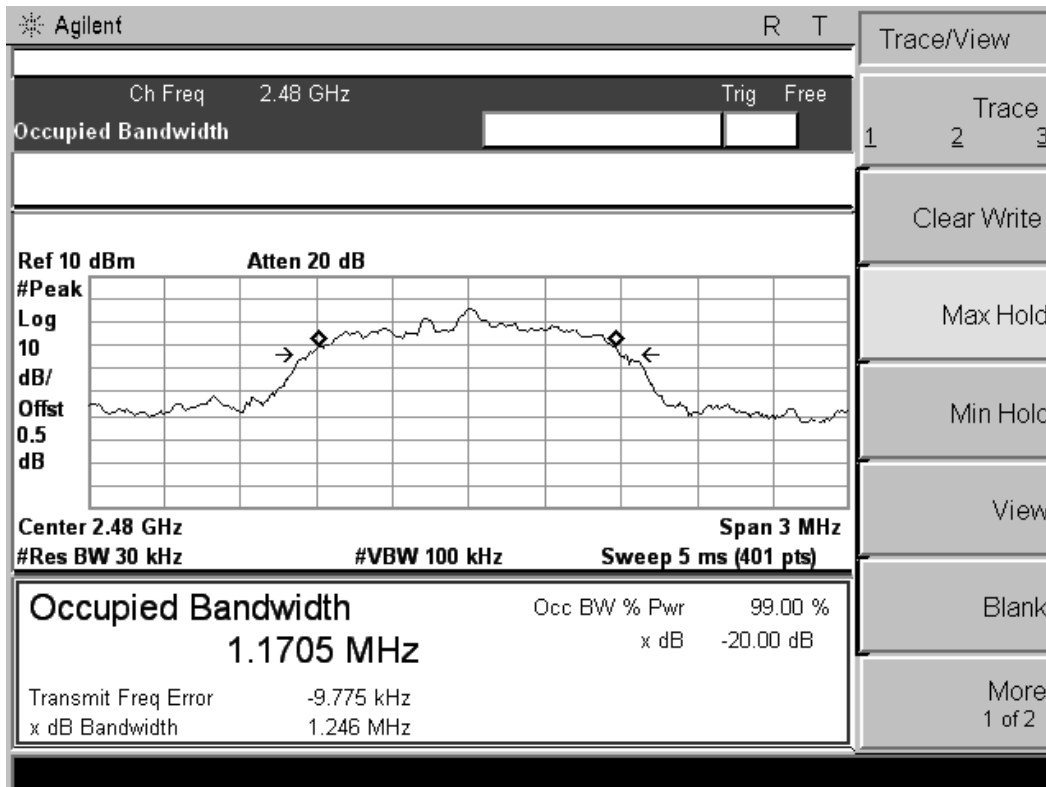

Test frequency: 2402MHz(3Mbps)

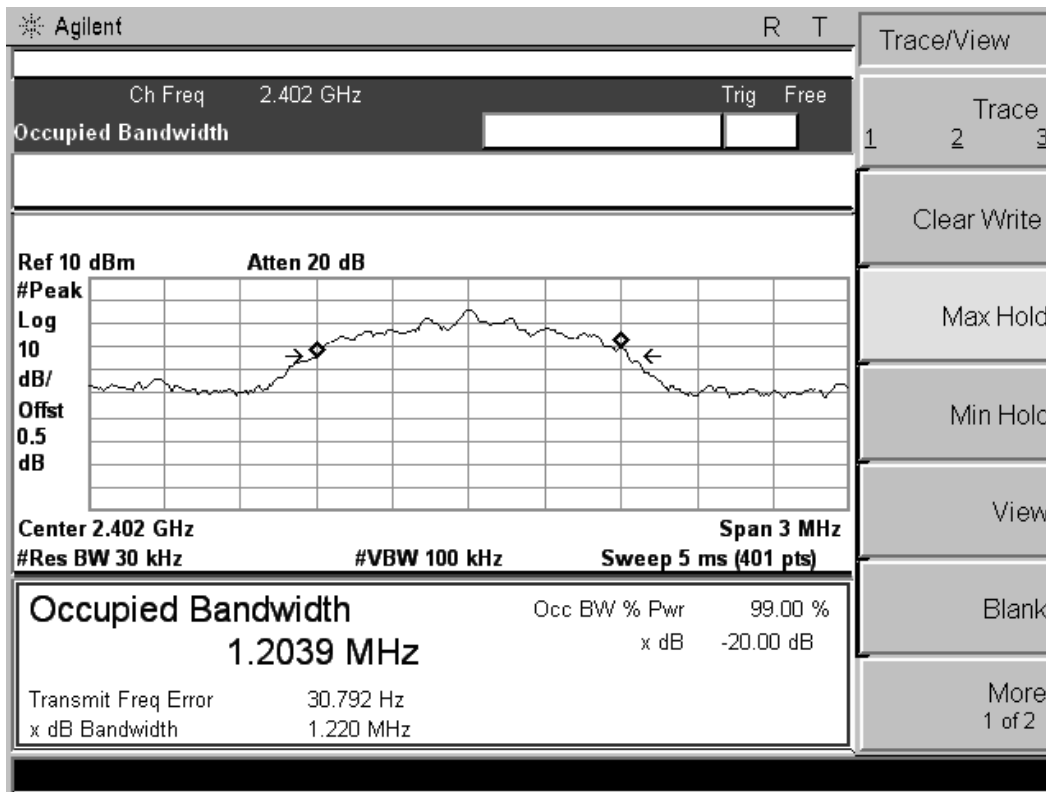

Test frequency: 2441MHz(3Mbps)

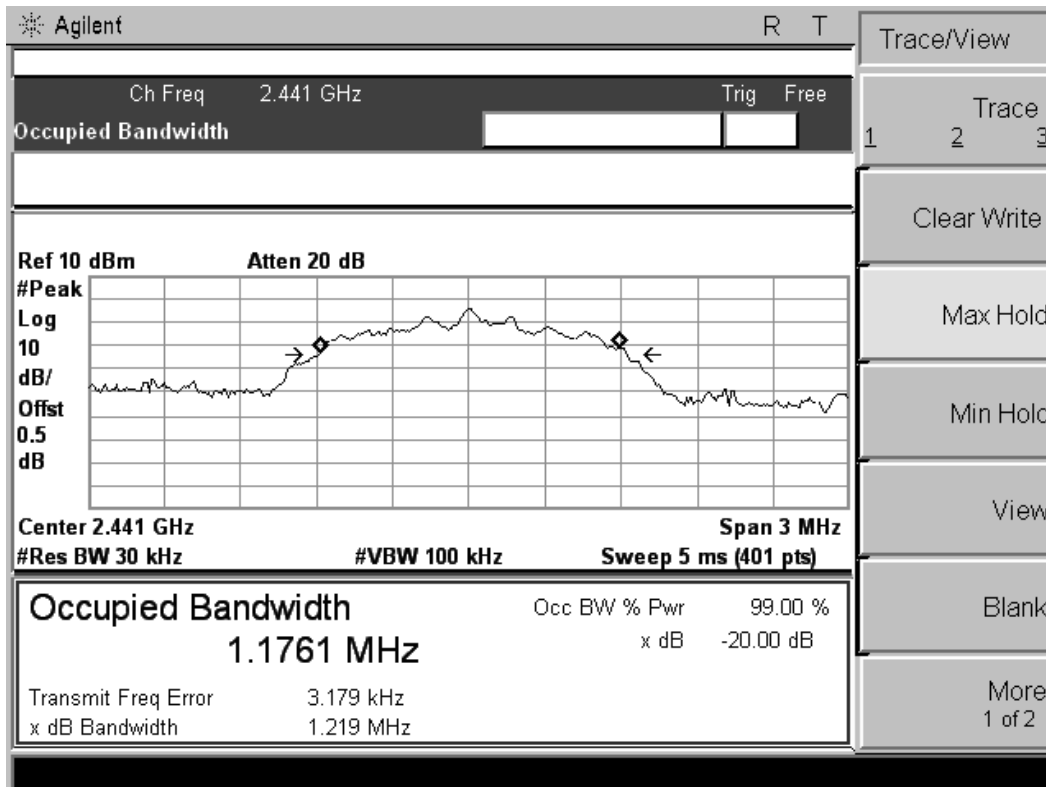

Test frequency: 2480MHz(3Mbps)

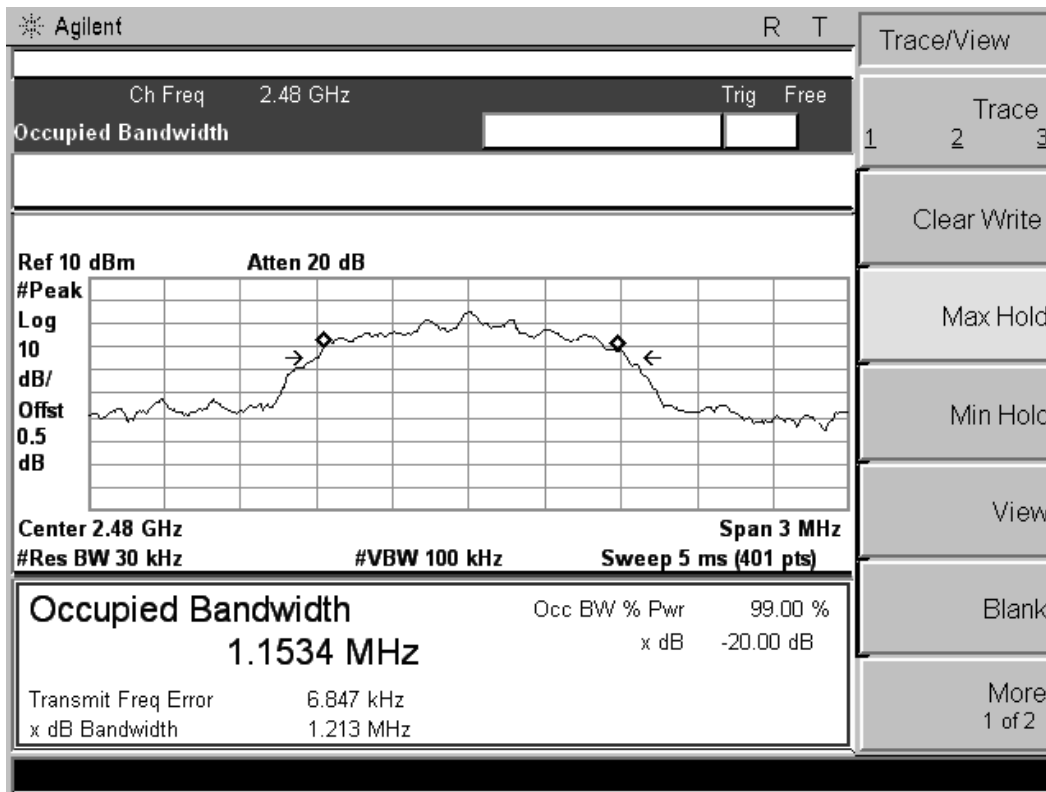

6.3 Number Of Hopping Frequency

6.3.1 Limit

According to § 15.247(a)(1)(ii), Frequency hopping systems operating in the band 2400-2483.5 MHz shall use at least 15 hopping channels.

6.3.2 Block Diagram of Test Setup

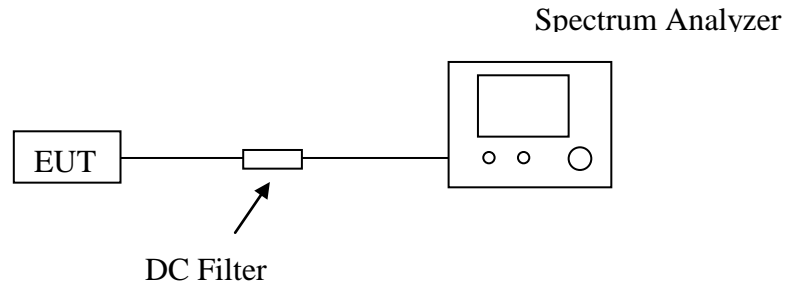

6.3.3 Test Procedure

- A. Place the EUT on the table and set it in transmitting mode.
- B. Remove the antenna from the EUT and then connect a low loss RF cable from the antenna port to the Spectrum Analyzer.
- C. Set Spectrum Analyzer Start=2400MHz, Stop = 2483.5MHz, Sweep = auto.
- D. Set the Spectrum Analyzer as RBW, VBW=1MHz.
- E. Max hold, view and count how many channel in the band.

6.3.4 Test Results

The Measurement Result With The Worst Case of 1Mbps For GFSK Modulation			
Total No. of Hopping Channel	Measurement Result (No. of Ch)	Limit (MHz)	Result
	79	≥15	Pass

The test data refer to the following page.

Test Plot- Number of Hopping Channel

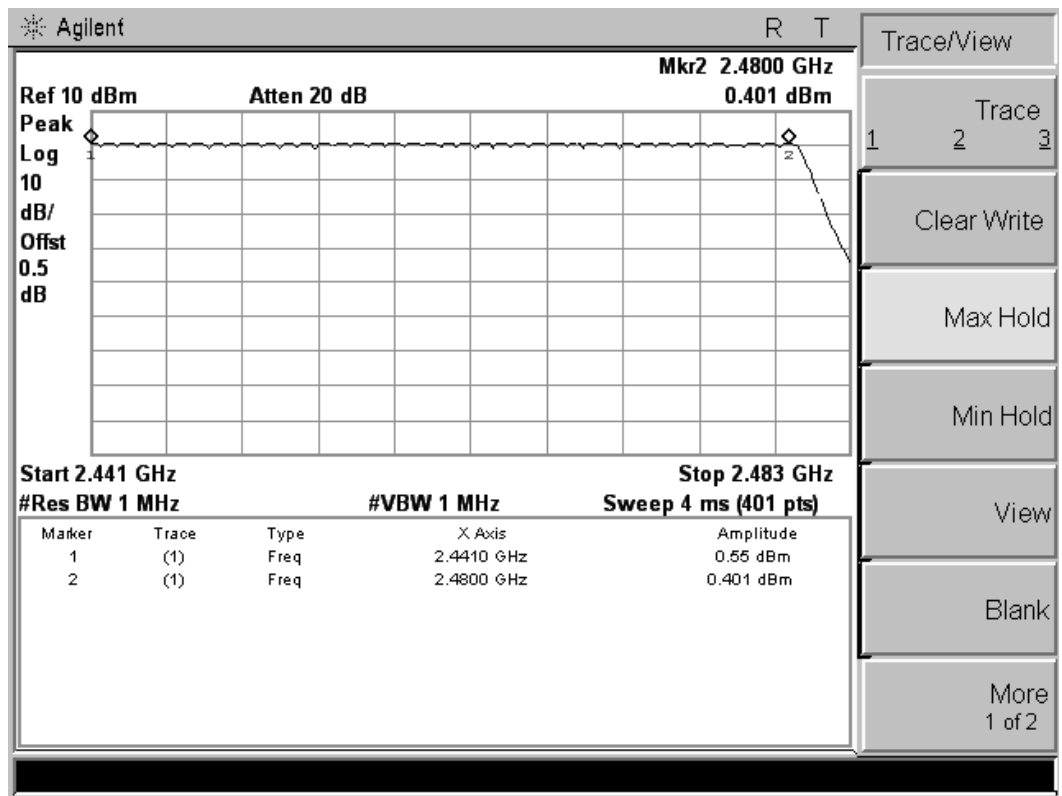
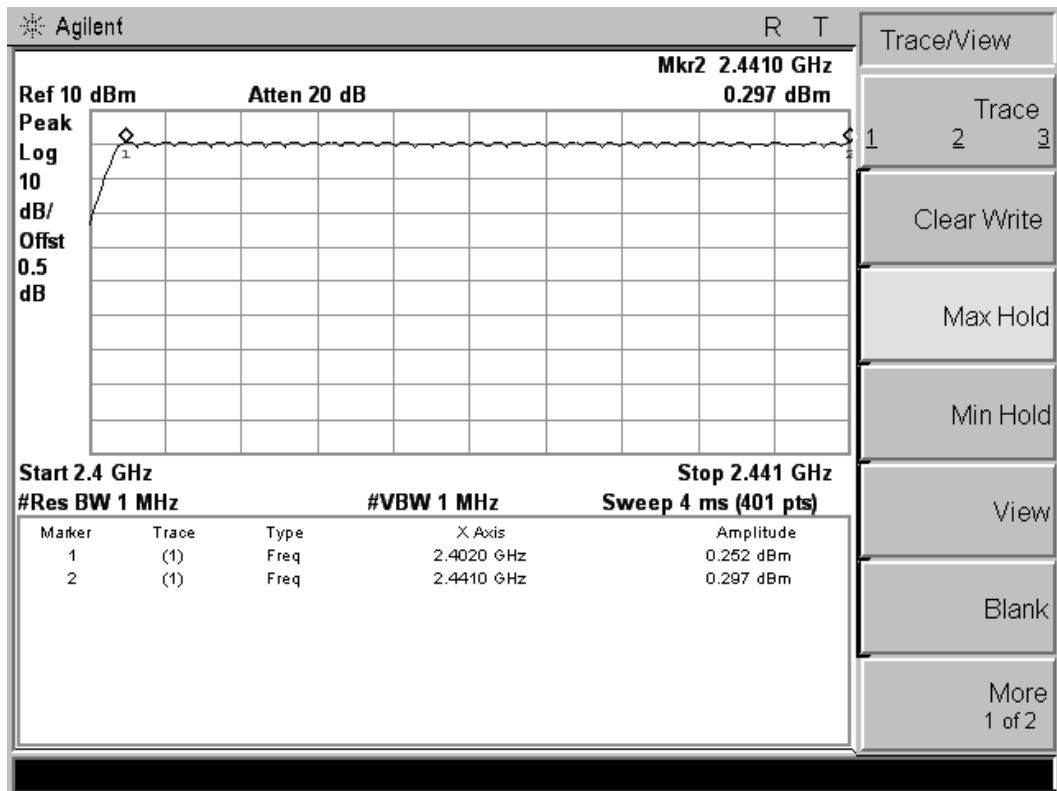

6.4 Time Of Occupancy (Dwell Time)

6.4.1 Limit

According to §15.247(a)(1)(iii), Frequency hopping systems operating in the 2400MHz-2483.5 MHz bands. The average time of occupancy on any channels shall not greater than 0.4 s within a period 0.4 s multiplied by the number of hopping channels employed.

6.4.2 Block Diagram of Test Setup

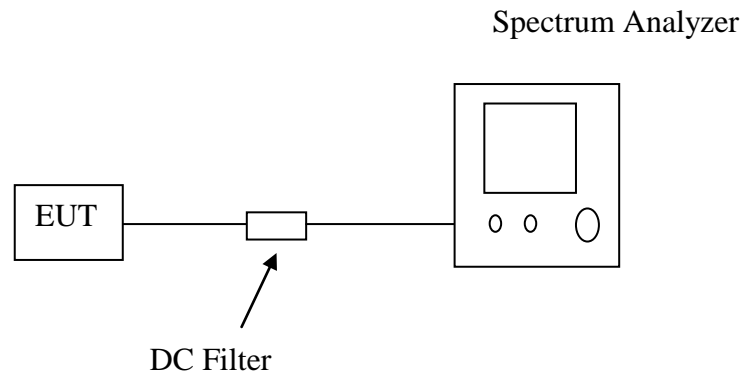

6.4.3 Test Procedure

- A. Place the EUT on the table and set it in transmitting mode.
- B. Remove the antenna from the EUT and then connect a low loss RF cable from the antenna port to the Spectrum Analyzer.
- C. Set center frequency of Spectrum Analyzer = operating frequency.
- D. Set the Spectrum Analyzer as RBW, VBW=1MHz, Span = 0Hz, Sweep = auto.
- E. Repeat above procedures until all frequency measured were complete.

6.4.4 Test Results

The Measurement Result With The Worst Case of 3Mbps For 8-DPSK Modulation				
Channel	Time of Pulse for 3DH5 (ms)	Period Time (s)	Sweep Time (ms)	Limit (ms)
Low	2.860	31.6	305.1	400
Middle	2.890	31.6	308.3	400
High	2.890	31.6	308.3	400

Low Channel

$$2.860 * (1600/6) / 79 * 31.6 = 305.1 \text{ms}$$

Middle Channel

$$2.890 * (1600/6) / 79 * 31.6 = 308.3 \text{ms}$$

High Channel

$$2.890 * (1600/6) / 79 * 31.6 = 308.3 \text{ms}$$

The test data refer to the following:

Low Channel

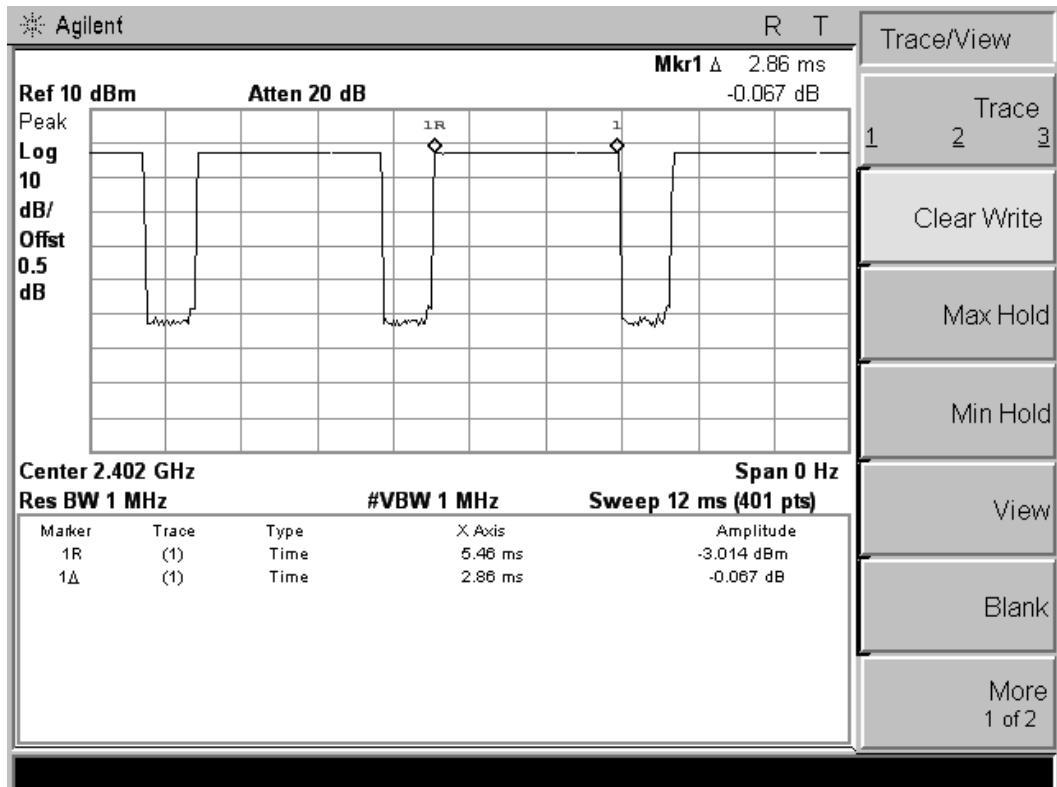

Middle Channel

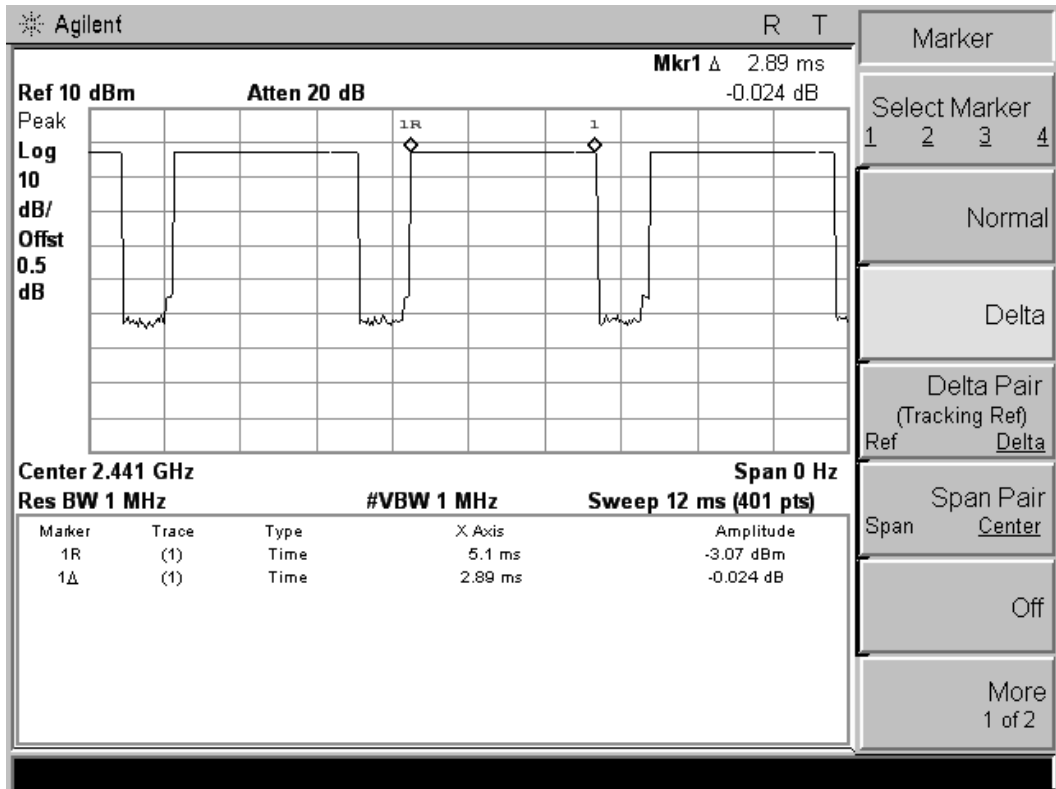

High Channel

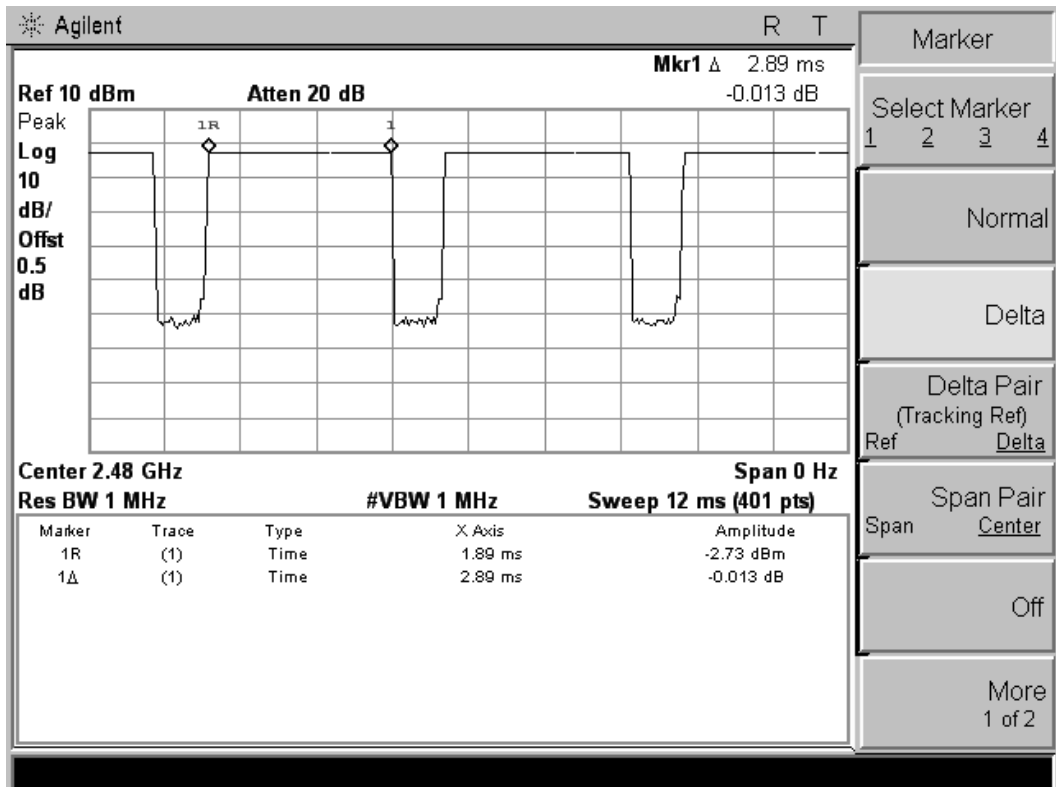

6.5 Conducted Spurious Emissions and Band Edges Test

6.5.1 Limit

In any 100 kHz bandwidth outside the frequency band in which the spread spectrum or digitally modulated intentional radiator is operating, the radio frequency power that is produced by the intentional radiator shall be at least 20 dB below that in the 100 kHz bandwidth within the band that contains the highest level of the desired power, based on either an RF conducted or a radiated measurement. Attenuation below the general limits specified in Section 15.209(a) is not required. In addition, radiated emissions which fall in the restricted bands, as defined in Section 15.205(a), must also comply with the radiated emission limits specified in Section 15.209(a) (see Section 15.205(c)).

6.5.2 Block Diagram of Test Setup

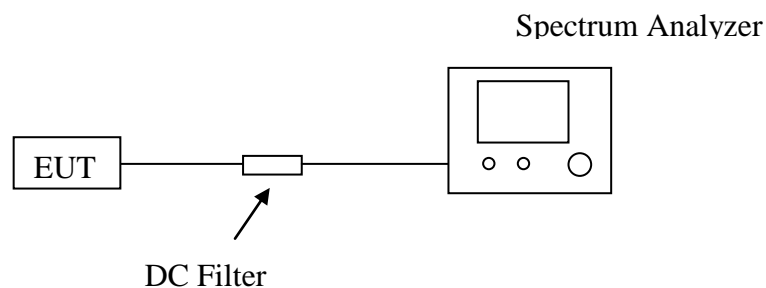

6.5.3 Test Procedure

Conducted RF measurements of the transmitter output were made to confirm that the EUT antenna port conducted emissions meet the specified limit and to identify any spurious signals that require further investigation or measurements on the radiated emissions site.

The transmitter output is connected to the spectrum analyzer. The resolution bandwidth is set to 100 KHz. The video bandwidth is set to 300 KHz.

Measurements are made over the 9kHz to 25GHz range with the transmitter set to the lowest, middle, and highest channels

6.5.4 Test Results of Conducted Spurious Emissions

No non-compliance noted. Only record the worst test result (TX-GFSK) in this report. The test data refer to the following page.

Test Plot

9KHz-25GHz Low Channel(GFSK)

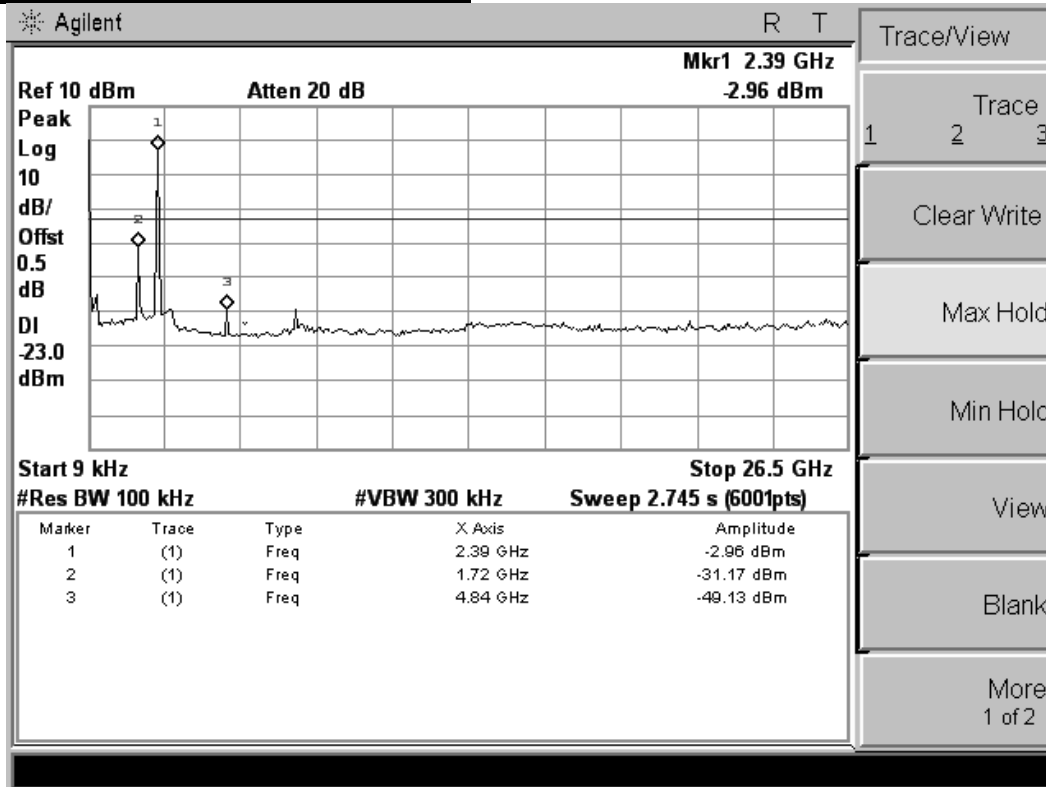

9KHz-25GHz Middle Channel(GFSK)

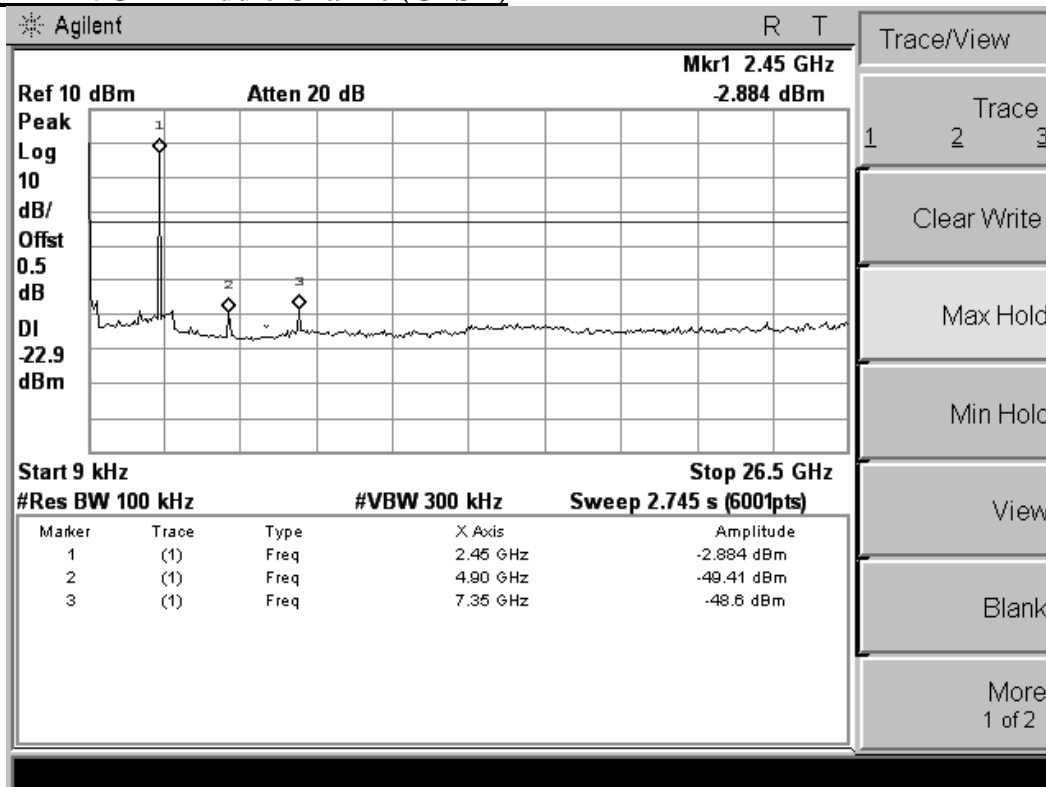

9KHz-25GHz High Channel(GFSK)

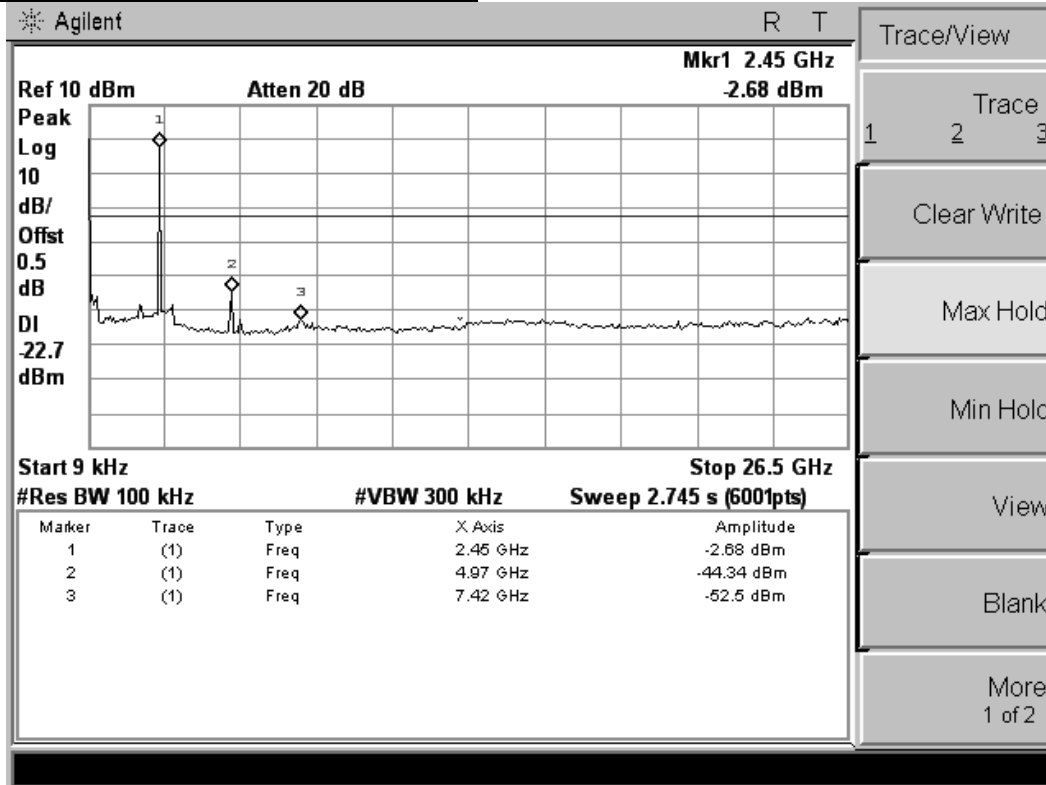

6.5.5 Test Results of Band Edges Test

No non-compliance noted. Only record the worst test result in this report. The test data refer to the following page.

Test Plot

Hopping On - (GFSK)

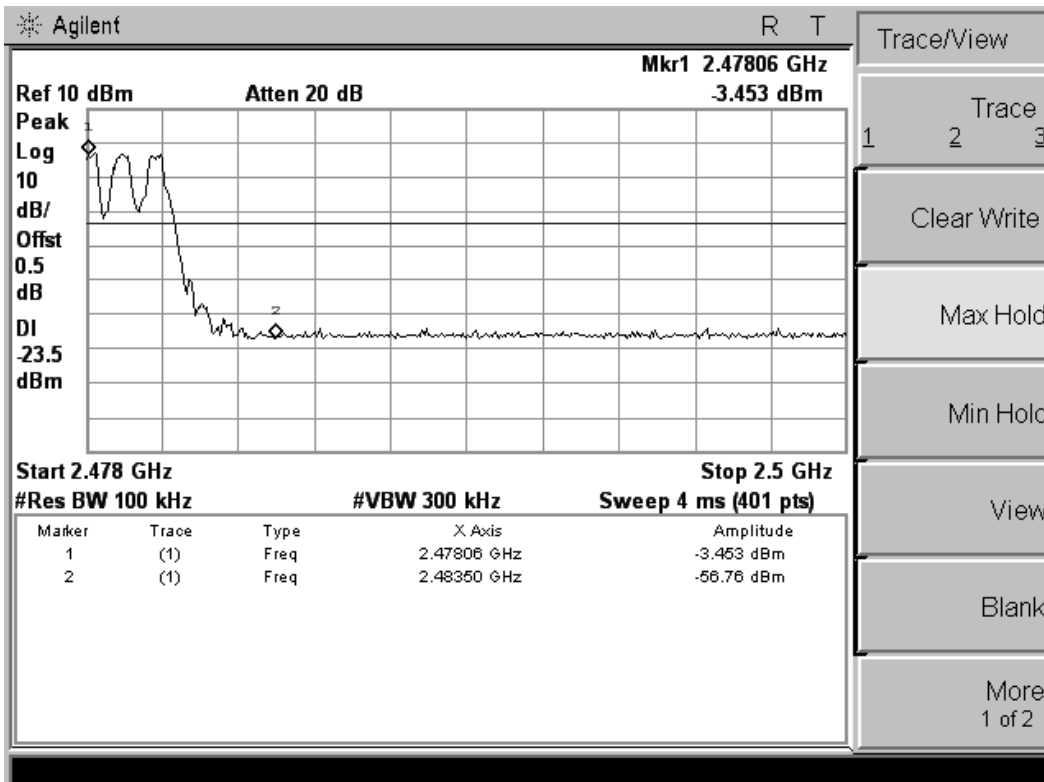
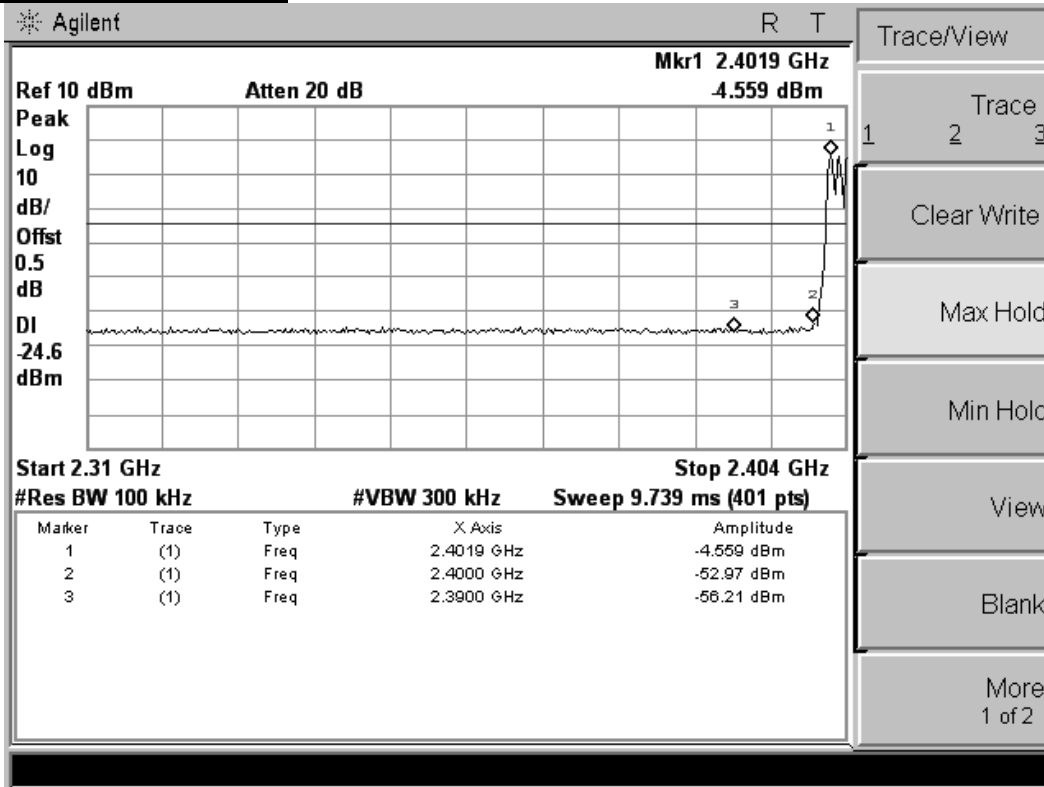

Hopping Off - (GFSK)

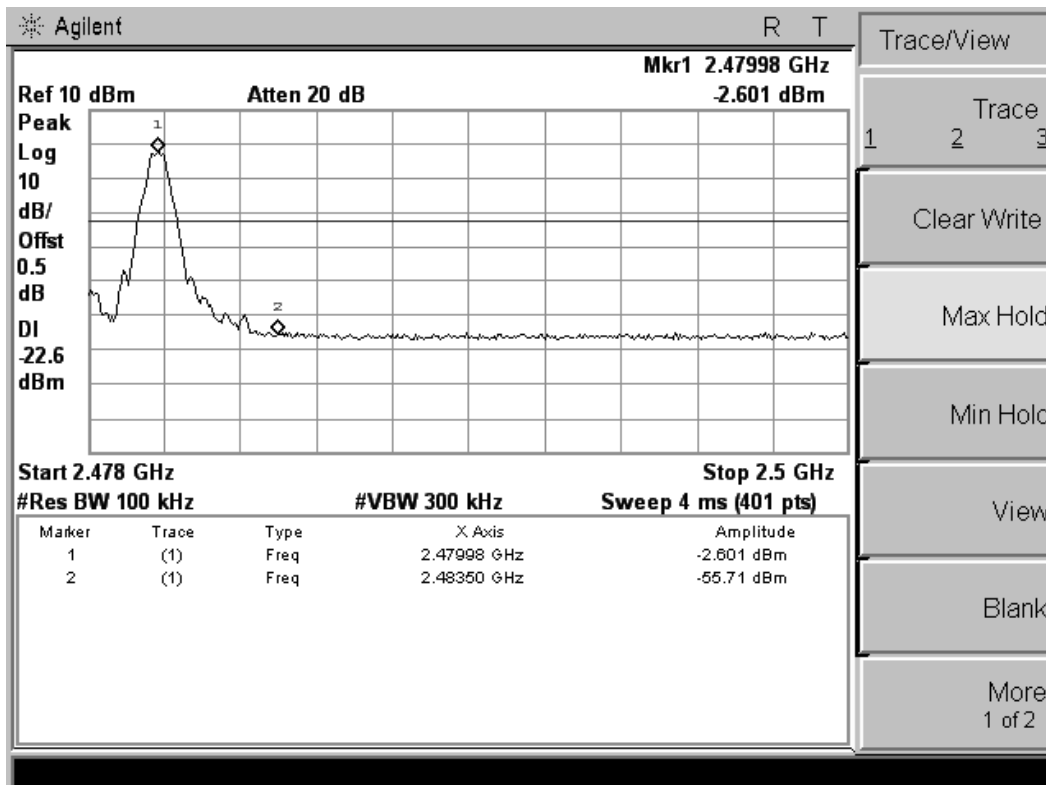
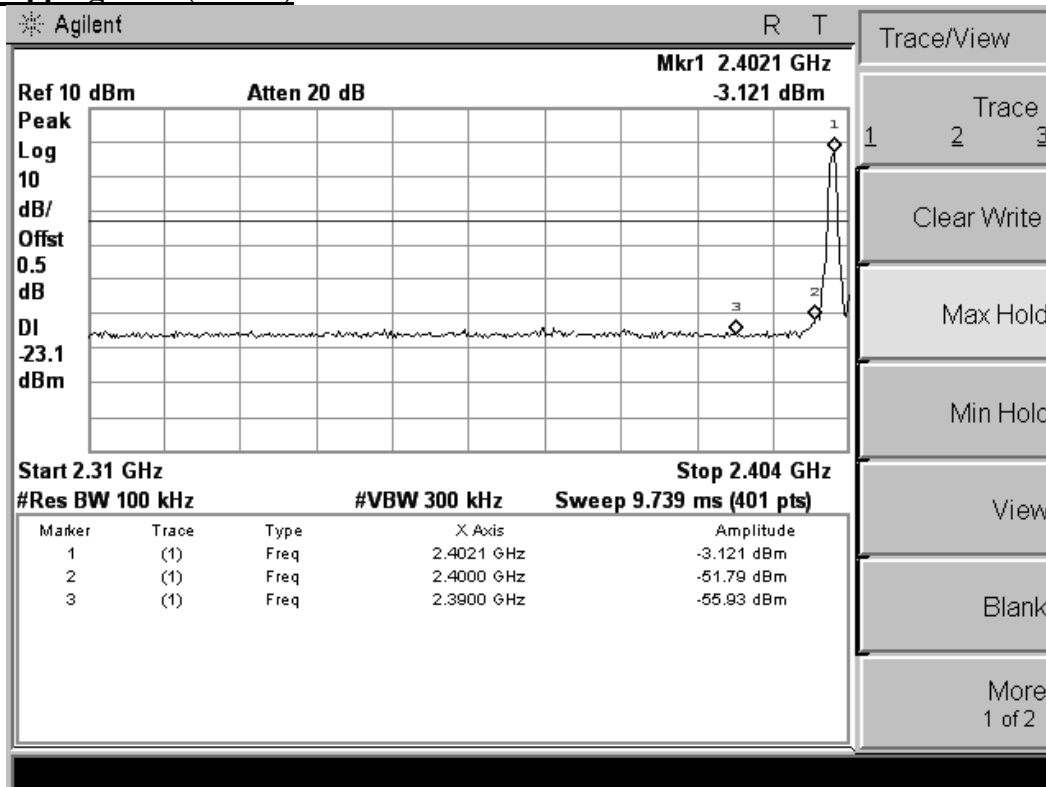

Hopping On - (8-DPSK)

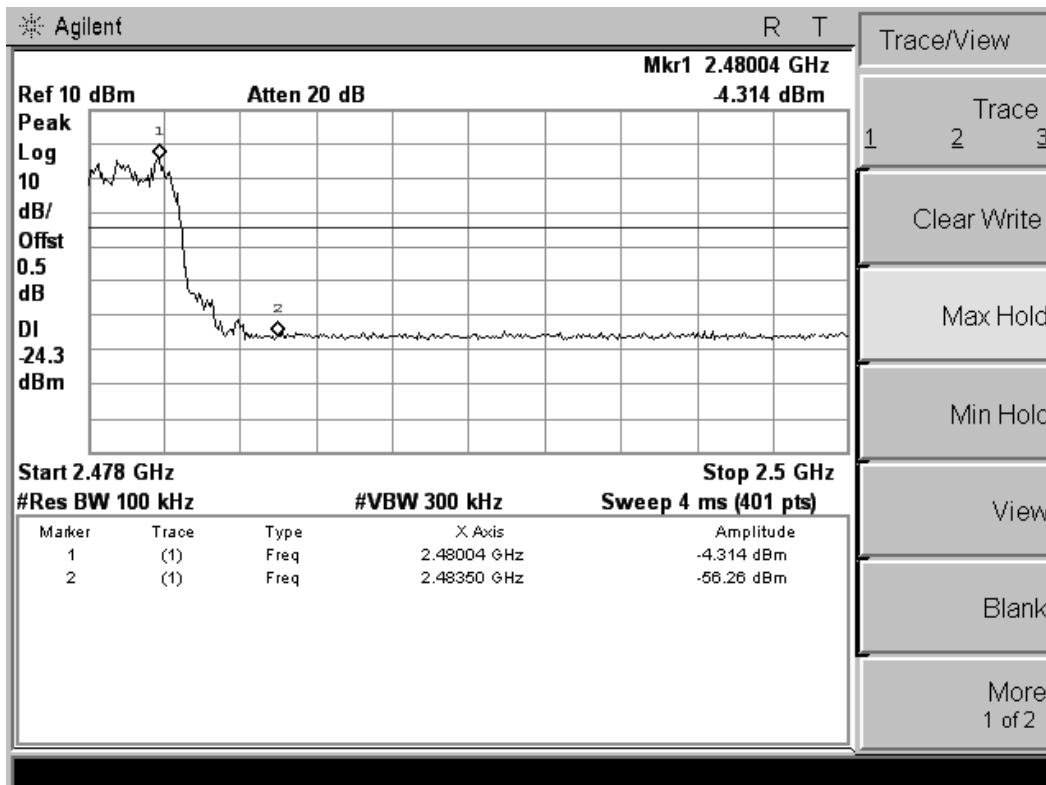
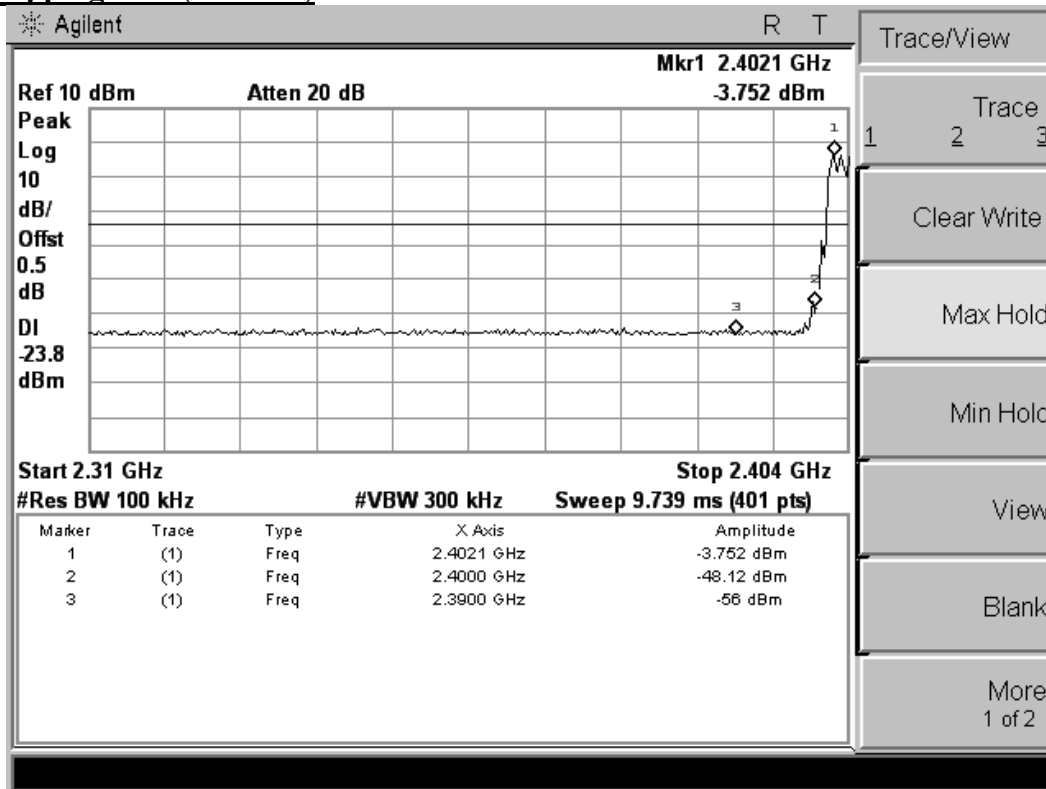

Hopping Off - (8-DPSK)

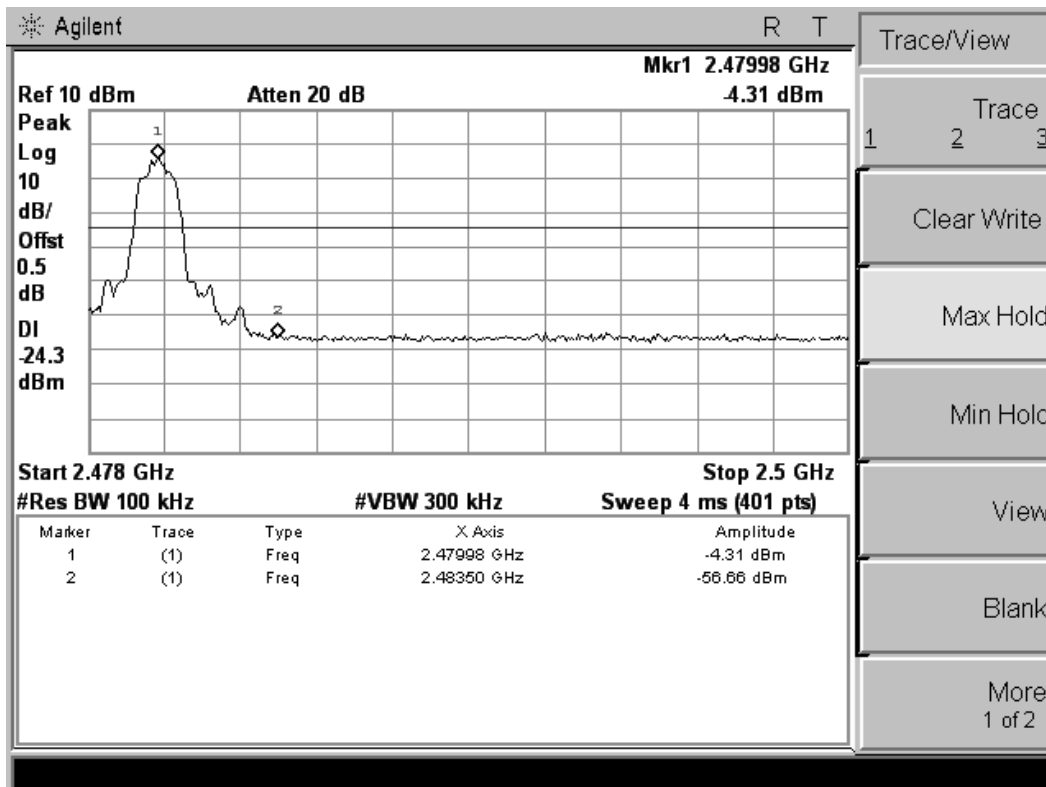
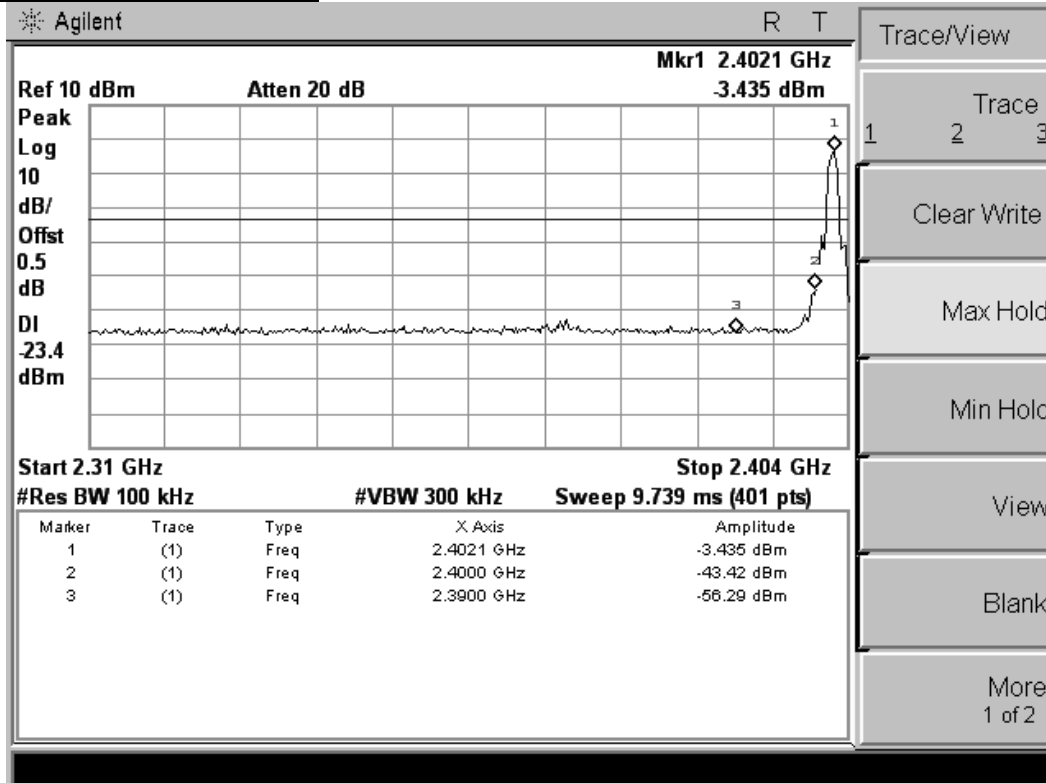

7. RADIATED MEASUREMENT

7.1 Block Diagram of Test Setup

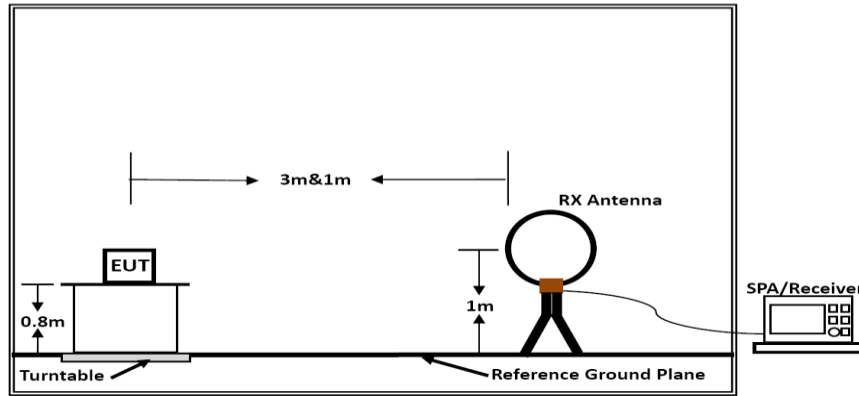

Below 30MHz

Below 30MHz

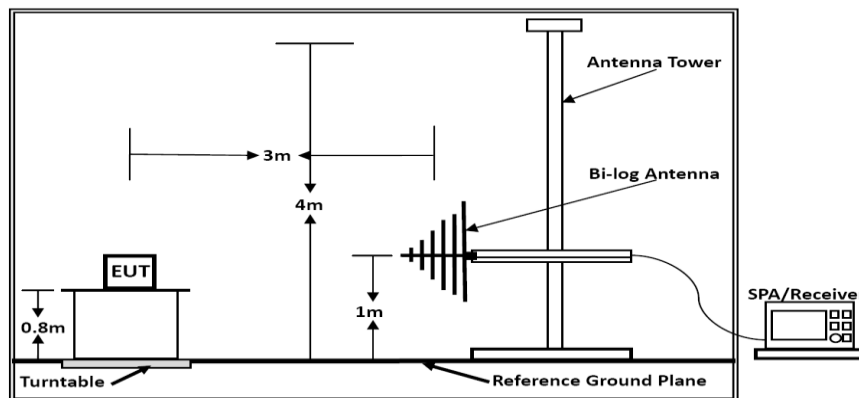

Below 1GHz

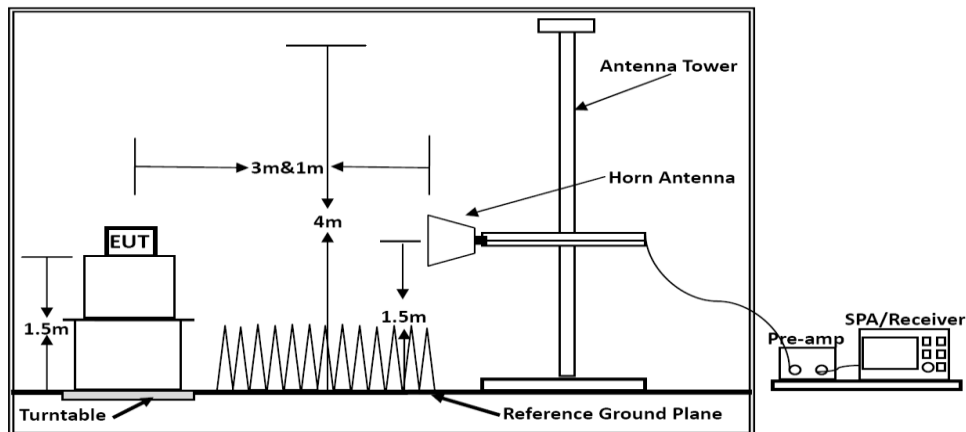

Above 1GHz

Above 1 GHz

7.2 Radiated Emission Limit

15.205 (a) Except as shown in paragraph (d) of this section, only spurious emissions are permitted in any of the frequency bands listed below:

MHz	MHz	MHz	GHz
0.090-0.110	16.42-16.423	399.9-410	4.5-5.15
\1\ 0.495-0.505	16.69475-16.69525	608-614	5.35-5.46
2.1735-2.1905	16.80425-16.80475	960-1240	7.25-7.75
4.125-4.128	25.5-25.67	1300-1427	8.025-8.5
4.17725-4.17775	37.5-38.25	1435-1626.5	9.0-9.2
4.20725-4.20775	73-74.6	1645.5-1646.5	9.3-9.5
6.215-6.218	74.8-75.2	1660-1710	10.6-12.7
6.26775-6.26825	108-121.94	1718.8-1722.2	13.25-13.4
6.31175-6.31225	123-138	2200-2300	14.47-14.5
8.291-8.294	149.9-150.05	2310-2390	15.35-16.2
8.362-8.366	156.52475-156.52525	2483.5-2500	17.7-21.4
8.37625-8.38675	156.7-156.9	2690-2900	22.01-23.12
8.41425-8.41475	162.0125-167.17	3260-3267	23.6-24.0
12.29-12.293.	167.72-173.2	3332-3339	31.2-31.8
12.51975-12.52025	240-285	3345.8-3358	36.43-36.5
12.57675-12.57725	322-335.4	3600-4400	(\2\)
13.36-13.41			

\1\ Until February 1, 1999, this restricted band shall be 0.490-0.510 MHz.

\2\ Above 38.6

Part 15.205 (b) Except as provided in paragraphs (d) and (e), the field strength of emissions appearing within these frequency bands shall not exceed the limits shown in Section 15.209. At frequencies equal to or less than 1000 MHz, compliance with the limits in Section 15.209 shall be demonstrated using measurement instrumentation employing a CISPR quasi-peak detector.

Above 1000 MHz, compliance with the emission limits in Section 15.209 shall be demonstrated based on the average value of the measured emissions. The provisions in Section 15.35 apply to these measurements.

Part 15.209 (a) Except as provided elsewhere in this Subpart, the emissions from an intentional radiator shall not exceed the field strength levels specified in the following table:

Frequency (MHz)	Field strength (microvolts/meter)	Measurement distance (meters)
0.009-0.490	2400/F(kHz)	300
0.490-1.705	24000/F(kHz)	30
1.705-30.0	30	30
30-88	100**	3
88-216	150**	3
216-960	200**	3
Above 960	500	3

7.3 Instruments Setting

The following table is the setting of spectrum analyzer and receiver.

Spectrum Parameter	Setting
Attenuation	Auto
Start Frequency	1000 MHz
Stop Frequency	10th carrier harmonic
RB / VB (Emission in restricted band)	1MHz / 1MHz for Peak, 1 MHz / 10Hz for Average
RB / VB (Emission in non-restricted band)	1MHz / 1MHz for Peak, 1 MHz / 10Hz for Average

Receiver Parameter	Setting
Attenuation	Auto
Start ~ Stop Frequency	9kHz~150kHz / RB 200Hz for QP
Start ~ Stop Frequency	150kHz~30MHz / RB 9kHz for QP
Start ~ Stop Frequency	30MHz~1000MHz / RB 100kHz for QP

7.4 Test Procedures

1) Sequence of testing 9 kHz to 30 MHz

Setup:

- The equipment was set up to simulate a typical usage like described in the user manual or described by manufacturer.
- If the EUT is a tabletop system, a rotatable table with 0.8 m height is used.
- If the EUT is a floor standing device, it is placed on the ground.
- Auxiliary equipment and cables were positioned to simulate normal operation conditions.
- The AC power port of the EUT (if available) is connected to a power outlet below the turntable.
- The measurement distance is 3 meter.
- The EUT was set into operation.

Premeasurement:

- The turntable rotates from 0 ° to 315 ° using 45 ° steps.
- The antenna height is 0.8 meter.
- At each turntable position the analyzer sweeps with peak detection to find the maximum of all emissions

Final measurement:

- Identified emissions during the premeasurement the software maximizes by rotating the turntable position (0 ° to 360 °) and by rotating the elevation axes (0 ° to 360 °).
- The final measurement will be done in the position (turntable and elevation) causing the highest emissions with QPK detector.
- The final levels, frequency, measuring time, bandwidth, turntable position, correction factor, margin to the limit and limit will be recorded. Also a plot with the graph of the premeasurement and the limit will be stored.

2) Sequence of testing 30 MHz to 1 GHz

Setup:

- The equipment was set up to simulate a typical usage like described in the user manual or described by manufacturer.
- If the EUT is a tabletop system, a table with 0.8 m height is used, which is placed on the ground plane.
- If the EUT is a floor standing device, it is placed on the ground plane with insulation between both.
- Auxiliary equipment and cables were positioned to simulate normal operation conditions
- The AC power port of the EUT (if available) is connected to a power outlet below the turntable.
- The measurement distance is 3 meter.
- The EUT was set into operation.

Premeasurement:

- The turntable rotates from 0 ° to 315 ° using 45 ° steps.
- The antenna is polarized vertical and horizontal.
- The antenna height changes from 1 to 3 meter.
- At each turntable position, antenna polarization and height the analyzer sweeps three times in peak to find the maximum of all emissions.

Final measurement:

- The final measurement will be performed with minimum the six highest peaks.
- According to the maximum antenna and turntable positions of premeasurement the software maximize the peaks by changing turntable position ($\pm 45^\circ$) and antenna movement between 1 and 4 meter.
- The final measurement will be done with QP detector with an EMI receiver.
- The final levels, frequency, measuring time, bandwidth, antenna height, antenna polarization, turntable angle, correction factor, margin to the limit and limit will be recorded. Also a plot with the graph of the premeasurement with marked maximum final measurements and the limit will be stored.

3) Sequence of testing 1 GHz to 12.75 GHz

Setup:

- The equipment was set up to simulate a typical usage like described in the user manual or described by manufacturer.
- If the EUT is a tabletop system, a rotatable table with 1.5 m height is used.
- If the EUT is a floor standing device, it is placed on the ground plane with insulation between both.
- Auxiliary equipment and cables were positioned to simulate normal operation conditions
- The AC power port of the EUT (if available) is connected to a power outlet below the turntable.
- The measurement distance is 3 meter.
- The EUT was set into operation.

Premeasurement:

- The turntable rotates from 0 ° to 315 ° using 45 ° steps.
- The antenna is polarized vertical and horizontal.
- The antenna height is 1.5 meter.
- At each turntable position and antenna polarization the analyzer sweeps with peak detection to find the maximum of all emissions.

Final measurement:

- The final measurement will be performed with minimum the six highest peaks.
- According to the maximum found antenna polarisation and turntable position of the premeasurement the software maximizes the peaks by rotating the turntable position (0 ° to 360 °). This measurement is repeated for different EUT-table positions (0 ° to 150 ° in 30 °-steps). This procedure is repeated for both antenna polarisations.
- The final measurement will be done in the position (turntable, EUT-table and antenna polarization) causing the highest emissions with Peak and RMS detector.
- The final levels, frequency, measuring time, bandwidth, turntable position, EUT-table position, antenna polarization, correction factor, margin to the limit and limit will be recorded. Also a plot with the graph of the premeasurement with marked maximum final measurements and the limit will be stored.

4) Sequence of testing above 12.75 GHz

Setup:

- The equipment was set up to simulate a typical usage like described in the user manual or described by manufacturer.
- If the EUT is a tabletop system, a rotatable table with 1.5 m height is used.
- If the EUT is a floor standing device, it is placed on the ground plane with insulation between both.
- Auxiliary equipment and cables were positioned to simulate normal operation conditions
- The AC power port of the EUT (if available) is connected to a power outlet below the turntable.
- The measurement distance is 1 meter.
- The EUT was set into operation.

Premeasurement:

- The antenna is moved spherical over the EUT in different polarisations of the antenna.

Final measurement:

- The final measurement will be performed at the position and antenna orientation for all detected emissions that were found during the premeasurements with Peak and RMS detector.
- The final levels, frequency, measuring time, bandwidth, correction factor, margin to the limit and limit will be recorded. Also a plot with the graph of the premeasurement and the limit will be stored.

7.5 Results for Radiated Emissions

PASS.

Only record the worst test result in this report.

The test data please refer to following page:

Below 1GHz (Low Channel)

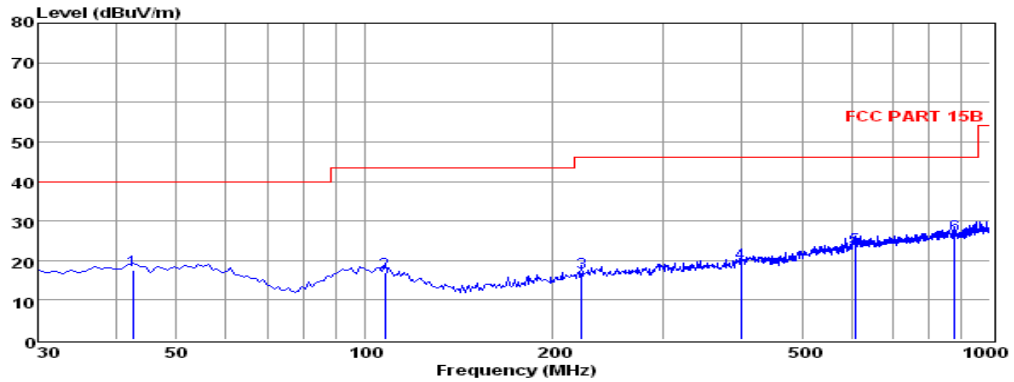

Env./Ins: 24°C/56%
 EUT: Shutter Camera
 M/N: JHM-821/822
 Power Rating: DC 3V
 Test Mode: TX-2402
 Operator: KYLE YIN
 Memo:
 pol: HORIZONTAL

	Freq MHz	Reading dBuV	CabLos dB	Antfac dB/m	Measured dBuV/m	Limit dBuV/m	Over dB	Remark
1	42.61	3.39	0.50	13.56	17.45	40.00	-22.55	QP
2	107.60	3.80	0.68	12.47	16.95	43.50	-26.55	QP
3	222.06	4.58	0.95	11.29	16.82	46.00	-29.18	QP
4	399.57	3.20	1.22	15.05	19.47	46.00	-26.53	QP
5	609.09	3.30	1.45	18.48	23.23	46.00	-22.77	QP
6	877.78	3.73	1.87	20.86	26.46	46.00	-19.54	QP

Note: 1. All readings are Quasi-peak values.
 2. Measured= Reading + Antenna Factor + Cable Loss
 3. The emission that ate 20db blow the official limit are not reported

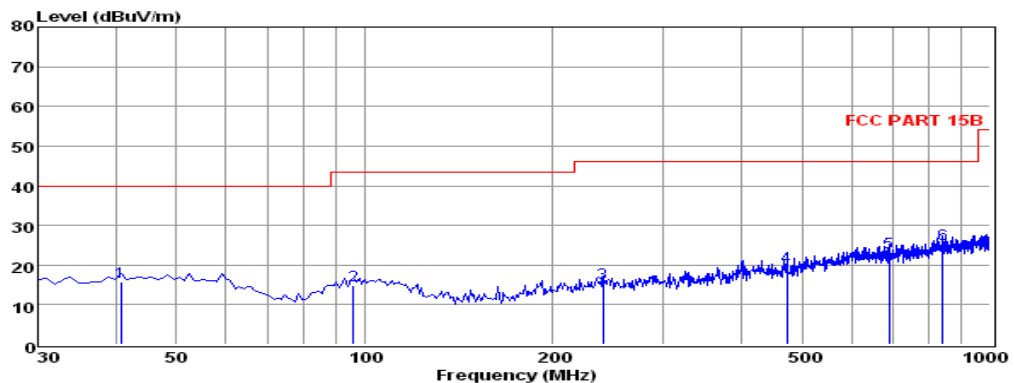

Env./Ins: 24°C/56%
 EUT: Shutter Camera
 M/N: JHM-821/822
 Power Rating: DC 3V
 Test Mode: TX-2402
 Operator: KYLE YIN
 Memo:
 pol: VERTICAL

	Freq MHz	Reading dBuV	CabLos dB	Antfac dB/m	Measured dBuV/m	Limit dBuV/m	Over dB	Remark
1	40.67	1.75	0.50	13.58	15.83	40.00	-24.17	QP
2	95.96	1.32	0.58	12.90	14.80	43.50	-28.70	QP
3	240.49	2.28	1.01	12.09	15.38	46.00	-30.62	QP
4	473.29	2.35	1.38	15.91	19.64	46.00	-26.36	QP
5	688.63	2.89	1.60	18.77	23.26	46.00	-22.74	QP
6	839.95	3.03	1.88	20.47	25.38	46.00	-20.62	QP

Note: 1. All readings are Quasi-peak values.
 2. Measured= Reading + Antenna Factor + Cable Loss
 3. The emission that ate 20db blow the official limit are not reported

Above 1GHz

The worst test result for GFSK, Tx-Low Channel:

Freq. MHz	Reading dBuv	Ant. Fac dB/m	Pre. Fac. dB	Cab. Loss dB	Measured dBuv/m	Limit dBuv/m	Margin dB	Remark	Pol.
4804.00	52.64	33.06	35.04	3.94	54.60	74	-19.40	Peak	Horizontal
4804.00	36.33	33.06	35.04	3.94	38.29	54	-15.71	Average	Horizontal
4804.00	52.76	33.06	35.04	3.94	54.72	74	-19.28	Peak	Vertical
4804.00	39.14	33.06	35.04	3.94	41.10	54	-12.90	Average	Vertical

The worst test result for GFSK, Tx-Middle Channel:

Freq. MHz	Reading DBuv	Ant. Fac dB/m	Pre. Fac. dB	Cab. Loss dB	Measured dBuv/m	Limit dBuv/m	Margin dB	Remark	Pol.
4882.00	54.83	33.16	35.15	3.96	56.80	74	-17.20	Peak	Horizontal
4882.00	36.01	33.16	35.15	3.96	37.98	54	-16.02	Average	Horizontal
4882.00	51.75	33.16	35.15	3.96	53.72	74	-20.28	Peak	Vertical
4882.00	38.51	33.16	35.15	3.96	40.48	54	-13.52	Average	Vertical

The worst test result for GFSK, Tx-High Channel:

Freq. MHz	Reading DBuv	Ant. Fac dB/m	Pre. Fac. dB	Cab. Los dB	Measured dBuv/m	Limit dBuv/m	Margin dB	Remark	Pol.
4960.00	54.73	33.26	35.14	3.98	56.83	74	-17.17	Peak	Horizontal
4960.00	36.75	33.26	35.14	3.98	38.85	54	-15.15	Average	Horizontal
4960.00	52.19	33.26	35.14	3.98	54.29	74	-19.71	Peak	Vertical
4960.00	34.06	33.26	35.14	3.98	36.16	54	-17.84	Average	Vertical

Notes:

1. Measuring frequencies from 9k~10th harmonic (ex. 26GHz), No emission found between lowest internal used/generated frequency to 30 MHz.
2. Radiated emissions measured in frequency range from 9k~10th harmonic (ex. 26GHz) were made with an instrument using Peak detector mode.
3. 18~25GHz at least have 20dB margin. No recording in the test report.

7.6 Results for Band edge Testing (Radiated)

Only record the worst test case (Tx, GFSK, Non-hopping) as following:

Tx-2402, GFSK, Non-hopping

Freq. MHz	Reading Level dBuV	Ant. Fac. dB/m	Pre. Fac. dB	Cab. Loss dB	Measured dBuV/m	Limit dBuV/m	Margin dB	Remark	Pol.
2385.00	51.28	32.89	35.16	3.51	52.52	74	-21.48	Peak	Horizontal
2385.00	38.81	32.89	35.16	3.51	40.05	54	-13.95	Average	Horizontal
2400.00	52.22	32.92	35.16	3.54	53.52	74	-20.48	Peak	Horizontal
2400.00	38.16	32.92	35.16	3.54	39.46	54	-14.54	Average	Horizontal
2385.00	50.18	32.89	35.16	3.51	51.42	74	-22.58	Peak	Vertical
2385.00	36.80	32.89	35.16	3.51	38.04	54	-15.96	Average	Vertical
2400.00	48.28	32.92	35.16	3.54	49.58	74	-24.42	Peak	Vertical
2400.00	35.14	32.92	35.16	3.54	36.44	54	-17.56	Average	Vertical

Tx-2480, GFSK, Non-hopping

Freq. MHz	Reading Level dBuV	Ant. Fac. dB/m	Pre. Fac. dB	Cab. Loss dB	Measured dBuV/m	Limit dBuV/m	Margin dB	Remark	Pol.
2483.50	51.01	33.06	35.18	3.60	52.49	74	-21.51	Peak	Horizontal
2483.50	37.37	33.06	35.18	3.60	38.85	54	-15.15	Average	Horizontal
2483.50	50.46	33.06	35.18	3.60	51.94	74	-22.06	Peak	Vertical
2483.50	37.17	33.06	35.18	3.60	38.65	54	-15.35	Average	Vertical

7.7. Power line conducted emissions

7.7.1 Standard Applicable

According to §15.207 (a): For an intentional radiator which is designed to be connected to the public utility (AC) power line, the radio frequency voltage that is conducted back onto the AC power line on any frequency or frequencies within the band 150 kHz to 30 MHz shall not exceed 250 microvolts (The limit decreases linearly with the logarithm of the frequency in the range 0.15 MHz to 0.50 MHz). The limits at specific frequency range is listed as follows:

Frequency Range (MHz)	Limits (dBμV)	
	Quasi-peak	Average
0.15 to 0.50	66 to 56	56 to 46
0.50 to 5	56	46
5 to 30	60	50

7.7.2 Block Diagram of Test Setup

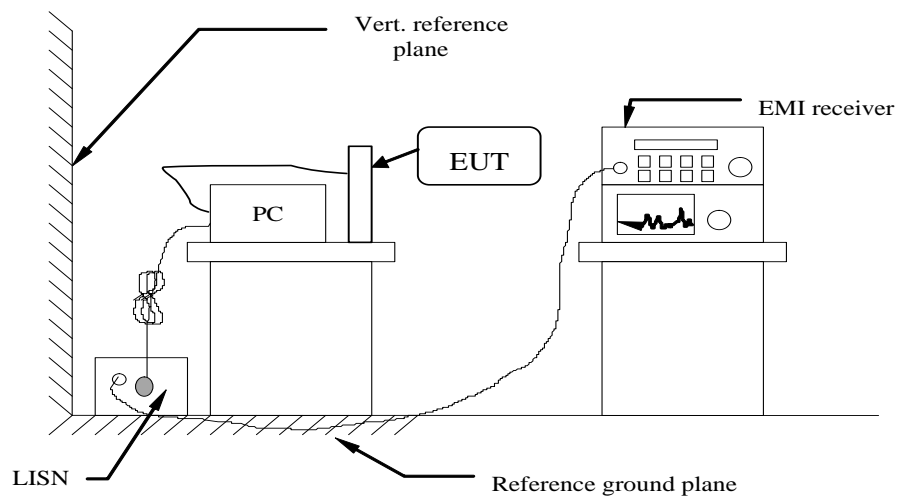

7.7.3 Test Results

The EUT only work by using battery and don't have power port.

No applicable.

8. ANTENNA REQUIREMENT

8.1 Standard Applicable

According to antenna requirement of §15.203.

An intentional radiator shall be designed to ensure that no antenna other than that furnished by the responsible party shall be used with the device. The use of a permanently attached antenna or of an antenna that uses a unique coupling to the intentional radiator shall be considered sufficient to comply with the provisions of this Section. The manufacturer may design the unit so that a broken antenna can be re-placed by the user, but the use of a standard antenna jack or electrical connector is prohibited. This requirement does not apply to carrier current devices or to devices operated under the provisions of Sections 15.211, 15.213, 15.217, 15.219, or 15.221. Further, this requirement does not apply to intentional radiators that must be professionally installed, such as perimeter protection systems and some field disturbance sensors, or to other intentional radiators which, in accordance with Section 15.31(d), must be measured at the installation site. However, the installer shall be responsible for ensuring that the proper antenna is employed so that the limits in this Part are not exceeded.

And according to §15.247(4)(1), system operating in the 2400-2483.5MHz bands that are used exclusively for fixed, point-to-point operations may employ transmitting antennas with directional gain greater than 6dBi provided the maximum peak output power of the intentional radiator is reduced by 1 dB for every 3 dB that the directional gain of the antenna exceeds 6dBi.

8.2 Antenna Connected Construction

8.2.1. Standard Applicable

According to § 15.203 & RSS-Gen, an intentional radiator shall be designed to ensure that no antenna other than that furnished by the responsible party shall be used with the device.

8.2.2. Antenna Connector Construction

The directional gains of antenna used for transmitting is 2.0dBi, and the antenna is connect to PCB board and no consideration of replacement. Please see EUT photo for details.

8.2.3. Results: Compliance.

Measurement parameters:

Measurement parameter	
Detector:	Peak
Sweep time:	Auto
Resolution bandwidth:	3 MHz
Video bandwidth:	3 MHz
Trace-Mode:	Max hold

Note: The antenna gain of the complete system is calculated by the difference of radiated power in EIRP and the conducted power of the module. For normal Bluetooth devices, the GFSK mode is used.

Limits:

FCC	IC
Antenna Gain	
6.0dBi	

Tnom	Vnom	lowest channel 2402 MHz	middle channel 2440 MHz	highest channel 2480 MHz
Conducted power [dBm] Measured with GFSK modulation		0.85	0.37	0.56
Radiated power [dBm] Measured with GFSK modulation		2.71	2.27	2.47
Gain [dBi] Calculated		1.86	1.90	1.91
Measurement uncertainty			± 1.5 dB (cond.) / ± 3.0 dB (rad.)	

Result: -/-

-----THE END OF REPORT-----