



OCTANE
POWER AMPLIFIER
XDA91RB, 92RB, 94RB

INSTALLATION / OWNER'S MANUAL



JENSEN®

Preparation

Please read entire manual before installation. Due to the technical nature of amplifiers, it is highly recommended that your amplifier is installed by a professional installer or an authorized dealer.

Before You Start

- Disconnect negative battery terminal. (consult a qualified technician for instructions)
- Avoid installing the amplifier where it would be subject to high temperatures, such as from direct sunlight, or where it would be subject to dust, dirt or excessive vibration.
- Use extreme caution when drilling holes to avoid damaging fuel lines or existing vehicle wiring.
- All amplifier installations require power, signal and speaker wires (not included).
- An amplifier installation kit (sold separately) is highly recommended to facilitate the installation. Consult your dealer for recommendations.

Mounting Location

- Choose a mounting location for the amplifier. Suggested locations include under a seat or in the trunk.
- The amplifier can be mounted horizontal (recommended) or vertical. For optimum performance, make sure to provide at least 1" of space around all sides. Do not mount the amplifier under carpets or where airflow is restricted.
- Do not install the amplifier where it may be exposed to moisture.
- The optimum mounting location varies between vehicles. Remember to test all amplifier functions before completing the final mounting procedure.

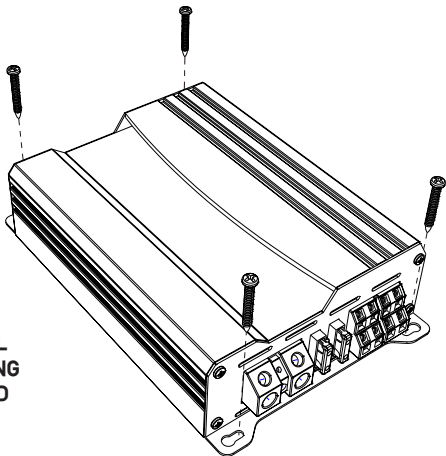

**TYPICAL
MOUNTING
METHOD**

Connection Descriptions

NOTE:

Be sure to follow specific instructions included with your amplifier installation kit (not included with this amplifier). The information below should be used as a general guideline only.

Power Wire (+12V)

- Disconnect negative battery terminal before proceeding. Consult a qualified technician for instructions if you are unsure.
- Plan wire routing before cutting any wires to length. Begin by routing the power +12V wire from the battery to the amplifier location. Use a grommet when running wires through the firewall or metal openings. Avoid running the power wire near existing vehicle wiring to prevent induced noise from entering the audio system.
- Use extreme caution when drilling holes to avoid damaging fuel lines or existing vehicle wiring.
- The +12V wire **MUST** be fused within 18" of the battery for protection of the vehicle's electrical system.

Ground Wire (GND)

- The amplifier ground wire should be as short as possible (no more than 36" or 1 meter). Choose a clean unpainted section of metal or the vehicle chassis when attaching the ground connection. Be sure to clean the area of any dirt or grease.

Remote Turn-on Wire (REM)

- The remote turn-on wire connects to the head unit's amplifier turn-on lead or power antenna output.

Speaker Wires

- Choose adequate gauge speaker wire depending on your exact amplifier/speaker combination. Be sure to observe polarity when connecting.
- Do not ground any speaker wires or connect any speaker wires together.

Input Signal

- The amplifier's input signal connects to the head unit's low level (RCA) or high level (speaker wire) outputs.
- Low level input signals deliver the best performance. If unavailable, use the high level inputs - when interfacing with factory head unit for instance.

Power / Protect Indicators

- Colored LED indicators illuminate from the plastic power terminal.
- The blue LED illuminates during normal operation (**POWER**) and the red LED indicator is visible when the amplifier detects a fault (**PROTECT**).

CAUTION

- Do not use both low and high level inputs at the same time. Connect only one or the other.
- Keep low level inputs away from any power wires to avoid engine noise.
- Never run any wires underneath or outside the vehicle.

Audio Inputs and Controls

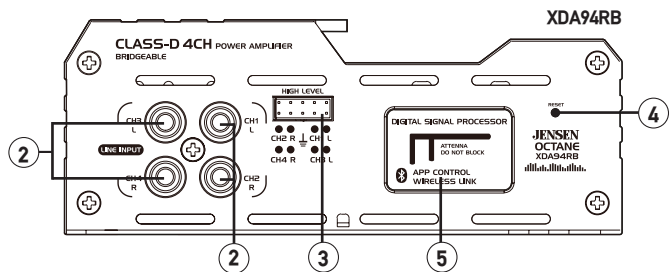
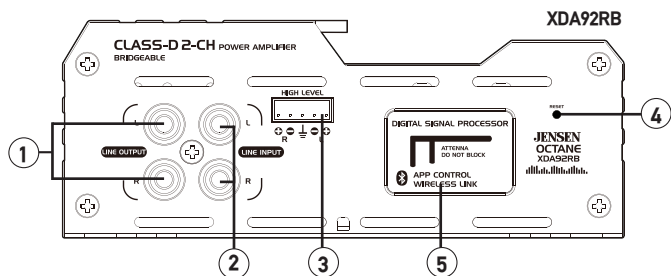
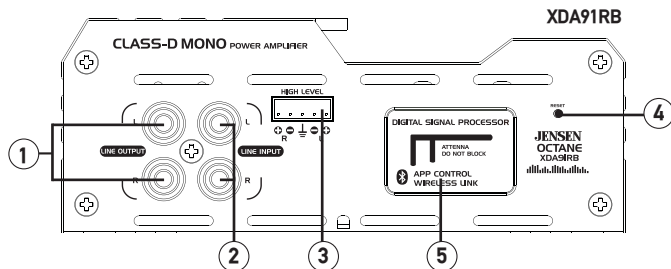

- ① Line Output
- ② Line Input
- ③ High Level Input
- ④ Reset

- ⑤ Do not place anything in this area that could block the radio waves, as this may be a problem with your Bluetooth connection.

Power and Speaker Connections

XDA91RB

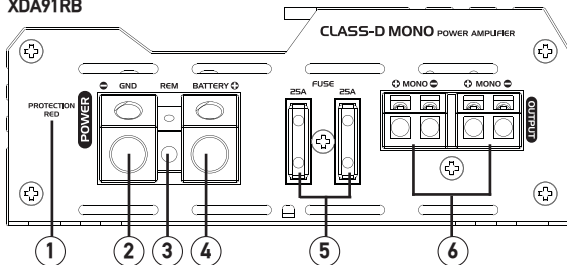

XDA92RB

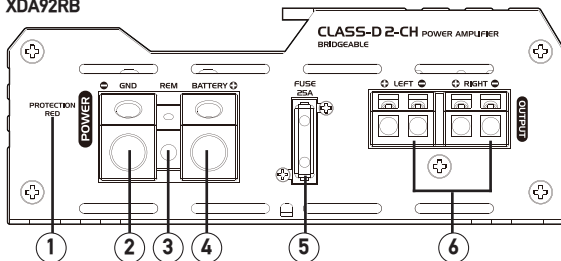

XDA94RB

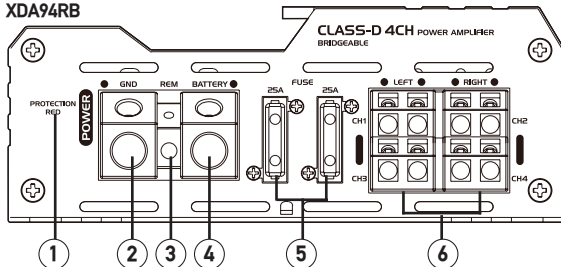

- | | |
|---------------------|------------------------------|
| ① Power/Protect LED | ④ +12V DC Battery Connection |
| ② Ground Connection | ⑤ Fuse(s) |
| ③ Remote Turn On | ⑥ Speaker Connections |

Typical Wire Routing XDA91RB



Speakers, head unit, wiring kit, and speaker wire sold separately.

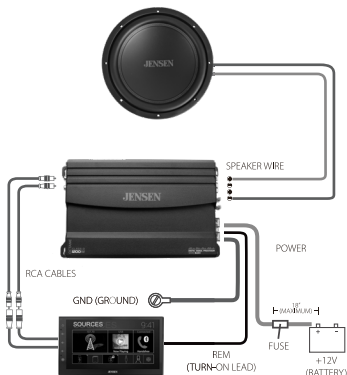

Subwoofer, head unit, wiring kit, and speaker wire sold separately.



Speakers, subwoofer, head unit, wiring kit, and speaker wire sold separately.

Typical Wire Routing

XDA92RB

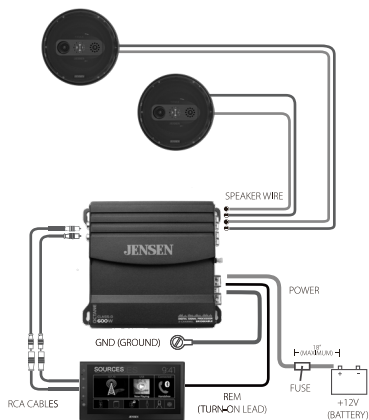

Speakers, head unit, wiring kit, and speaker wire sold separately.

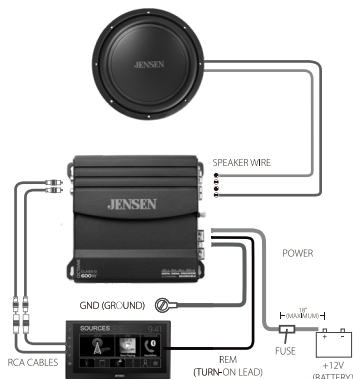

Subwoofer, head unit, wiring kit, and speaker wire sold separately.

Typical Wire Routing XDA94RB

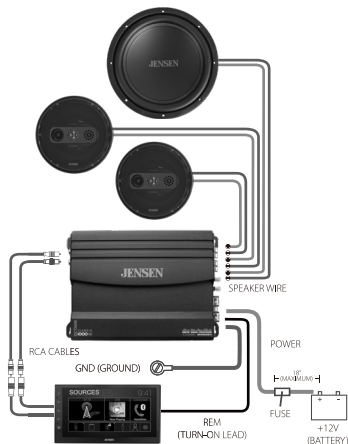

Speakers, head unit, wiring kit, and speaker wire sold separately

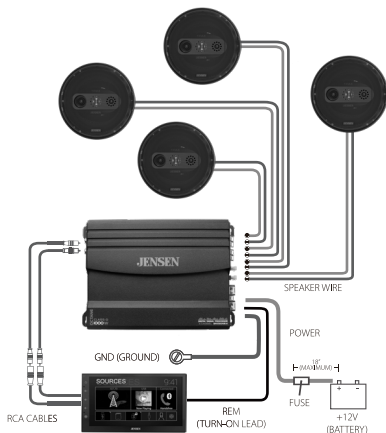

Speakers, head unit, wiring kit, and speaker wire sold separately



Speakers, head unit, wiring kit, and speaker wire sold separately.

Amplifier Connections

Speaker Connections

Connect speaker wires observing polarity. The minimum impedance load for the amplifiers is 2 ohms stereo and 4 ohms bridged. Use of loads lower than these is not recommended and may cause amplifier damage. The amplifiers can be wired for stereo, bridged or stereo/bridged simultaneous operation.

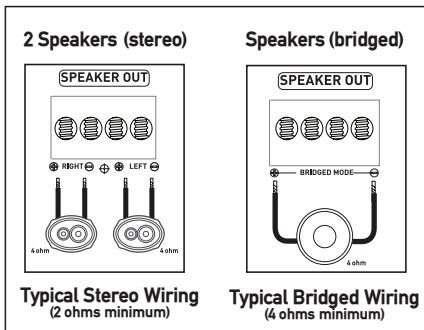

Typical speaker connections shown

Input Signal Connections

Low Level Input (RCA)

Low level (RCA) input signal is preferred for best performance. Typical trunk-mount amplifier installations require a 17-20 foot RCA cable. Most trucks and under-seat applications require a 6-9 foot RCA cable. Using twisted pair construction RCA cables will minimize noise.

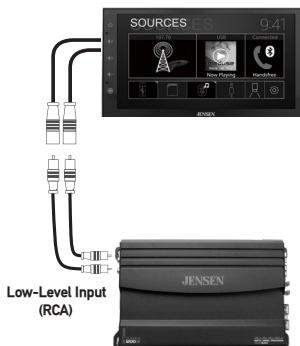

High Level Input

(Speaker Wire)

High level inputs should only be used when RCA outputs are not available from the head unit. Connect the head unit speaker outputs to the high level input connector as shown below. The black wire (signal reference ground) may or may not require a connection to chassis ground - depending on your particular installation.

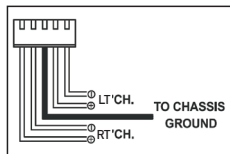

Note: Do not use both low and high level inputs at the same time - connect only one or the other.

Controller App Download/Installation



Scan the above QR Code to download the Jensen Octane DSP Amplifier Controller app from the Apple App Store or Google Play Store onto your smartphone or tablet.

Use the app to control features including: X-Over, EQ, RGB Light Customization, Volume and other amp settings directly from your smartphone or tablet via Bluetooth.

Note:

XDA amp series do not support audio streaming and hands free calls via Bluetooth.

Bluetooth Pairing with App and AMP

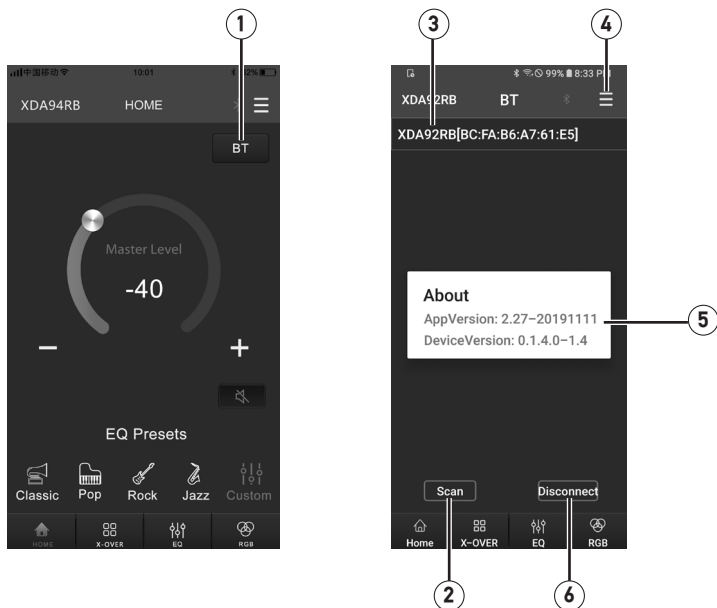

- Step 1 : Touch the BT icon ①
- Step 2 : Touch the Scan icon ② to search the Bluetooth amp.
- Step 3 : Bluetooth amp list ③ to show what amp is paired. (If only one amp is installed, one amp model number is displayed.)
- Step 4 : Select the amp model number you want to install from the device list ③
- Step 5 : Touch the drop down Icon ④ to show the version number of App and amp and to see if the Bluetooth pairing is completed successfully ⑤
- Step 6 : Touch Disconnect ⑥ to disconnect the amp from the App.

JENSEN DSP AMP App Operation

Input level Control (Master Level at HOME Mode)	The input level control (gain) is used to obtain the best possible match between the head unit audio output and the amplifier input. Begin by turning the input level control fully counterclockwise. Next, turn up the head unit volume control around 3/4 of the way up. Adjust the input level control clockwise until audible distortion is heard, then slightly counterclockwise to provide the best match. Repeat for all input level controls.
X-OVER Mode	The crossover is used to filter out frequencies above or below a certain point. Choose LPF when using the amplifier with subwoofers, HPF when using with midrange/tweeter combinations and FULL when using with coaxial-type speakers. Note: Choose FULL when using the amplifier in stereo/bridged simultaneous mode. In this mode, passive crossovers are required. Failure to use the correct passive components may damage the amplifier and/or speakers. Consult a qualified professional for recommendations.
X-OVER Control	This control allows precise adjustment of the crossover frequency.
Bass Boost	This control provides additional boost @ 45Hz when used with subwoofers. Adjust this control with caution - as improper use can damage speakers!
EQ Presets	Select between the following EQ presets : Classic, Pop, Rock, Jazz, Custom (allows user to enter custom EQ settings).
Custom EQ	Custom EQ from EQ Presets is selected to make the customized audio settings and each gain per frequency can be adjusted at EQ Mode of the App.
RGB Color	It allows the amp illumination to be turned off or on at RGB mode of the App. One color or multiple colors can be controlled.

Specifications

XDA91RB

Power Output

- 240 Watts RMS x 1 channels @ 4 Ohms
- 400 Watts RMS x 1 channels @ 2 Ohms
- 600 Watts RMS x 1 channels @ 1 Ohm

Peak Music Power Output: 1200 Watts

Signal to noise ratio: 68dBA (reference : 1 Watt into 4 Ohms)

Frequency response: 20Hz– 250Hz

Amplifier dimensions: 2.16" x 9.56" x 5.59" (H x W x D)

XDA92RB

Power Output

- 80 Watts RMS x 2 channels @ 4 Ohms
- 120 Watts RMS x 2 channels @ 2 Ohms
- 240 Watts RMS x 1 channels @ 4 Ohms(bridged)

Peak Music Power Output: 600 Watts

Signal to noise ratio: 68dBA (reference : 1 Watt into 4 Ohms)

Frequency response: 20Hz -20kHz

Amplifier dimensions: 2.16" x 6.57" x 5.59" (H x W x D)

XDA94RB

Power Output

- 80 Watts RMS x 4 channels @ 4 Ohms
- 120 Watts RMS x 4 channels @ 2 Ohms
- 240 Watts RMS x 2 channels @ 4 Ohms(bridged)

Peak Music Power Output: 1000 Watts

Signal to noise ratio: 68dBA (reference : 1 Watt into 4 Ohms)

Frequency response: 20Hz– 20kHz

Amplifier dimensions: 2.16" x 8.38" x 5.59" (H x W x D)

Troubleshooting

Problem	Cause	Action
Unit will not turn on (no power LED indicator)	+12V wire not connected or incorrect voltage. REM wire not connected or incorrect voltage	Check connections for proper voltage (11–16VDC)
	GND wire not connected	Check connection to ground
	Fuse(s) blown	Replace fuse(s)
Unit has power - LED is green (but no sound)	Speaker wires not connected	Check connections at speakers
	Volume turned all the way down	Increase volume level at head unit
	One or more speaker wires touching each other or touching chassis ground	Insulate all bare speaker wires from each other and chassis ground
	Speaker(s) defective or damaged	Check/replace speaker(s)
	Input signal not connected	Check high or low level inputs for proper connection
Unit blows fuse(s)	Incorrect fuse rating	Use fuse(s) with correct rating
	+12V wire touching chassis ground	Check for pinched wire
	Speaker(s) defective or damaged	Check/replace speaker(s)
Engine noise	Bad ground connection	Make sure amplifier is grounded to clean bare metal
	Signal ground loop or RFI (radio frequency interference)	Re-route RCA cables from existing high current wiring
LED illuminates red (protect mode)	One or more speaker wires touching each other or touching chassis ground	Insulate all bare speaker wires from each other and chassis ground
	Speaker(s) defective or damaged internally (shorted)	Check/replace speaker(s)
	Speaker load less than 2 ohms (stereo). Speaker load less than 4 ohms (bridged)	Adjust speaker load - amplifier will not operate at less than 4 ohms when bridged
Distorted audio output	Incorrect input signal type or input level too high	Check connections and reduce/adjust input level
Low audio output	Incorrect input signal type or input level too low	Check connections and increase/adjust input level
App and the amp are not connected via Bluetooth	Amp is not connected on Bluetooth with the App	Touch the drop down icon of the App to check the Bluetooth connection is completed. Refer to the page 11
		Turn Bluetooth off and back on from the smartphone/tablet
	Incorrect temporary Bluetooth operation from smartphone/tablet	Remove all Apps activated on the background of the smartphone/tablet

One-Year Limited Warranty

Limited One Year Warranty

This warranty gives you specific legal rights. You may also have other rights which vary from state to state.

Namsung America Inc. warrants this product to the original purchaser to be free from defects in material and workmanship for a period of one year from the date of the original purchase.

Namsung America Inc. agrees, at our option, during the warranty period, to repair any defect in material or workmanship or to furnish an equal new, renewed or comparable product (whichever is deemed necessary) in exchange without charges, subject to verification of the defect or malfunction and proof of the date of purchase. Subsequent replacement products are warranted for the balance of the original warranty period.

Who is covered?

This warranty is extended to the original retail purchaser for products purchased from an authorized Jensen dealer and used in the U.S.A.

What is covered?

This warranty covers all defects in material and workmanship in this product. The following are not covered: software, installation/removal costs, damage resulting from accident, misuse, abuse, neglect, product modification, improper installation, incorrect line voltage, unauthorized repair or failure to follow instructions supplied with the product, or damage occurring during return shipment of the product. Specific license conditions and copyright notices for the software can be found via www.jensenmobile.com

What to do?

1. Before you call for service, check the troubleshooting guide in your owner's manual. A slight adjustment of any custom controls may save you a service call.
2. If you require service during the warranty period, you must carefully pack the product (preferably in the original package) and ship it by prepaid transportation with a copy of the original receipt from the retailer to an authorized service center.
3. Please describe your problem in writing and include your name, a return UPS shipping address (P.O. Box not acceptable), and a daytime phone number with your shipment.
4. For more information and for the location of the nearest authorized service center please contact us by one of the following methods:
 - Call us toll-free at 1-888-921-4088
 - E-mail us at cs@dualav.com

Exclusion of Certain Damages: This warranty is exclusive and in lieu of any and all other warranties, expressed or implied, including without limitation the implied warranties of merchantability and fitness for a particular purpose and any obligation, liability, right, claim or remedy in contract or tort, whether or not arising from the company's negligence, actual or imputed. No person or representative is authorized to assume for the company any other liability in connection with the sale of this product. In no event shall the company be liable for indirect, incidental or consequential damages.

FCC Compliance

This device complies with Part 15 of the FCC Rules. Operation is subject to the following two conditions:

- (1) this device may not cause harmful interference, and
- (2) this device must accept any interference received, including interference that may cause undesired operation.

Warning: Changes or modifications to this unit not expressly approved by the party responsible for compliance could void the user's authority to operate the equipment.

Note: This equipment has been tested and found to comply with the limits for a Class B digital device, pursuant to Part 15 of the FCC Rules. These limits are designed to provide reasonable protection against harmful interference in a residential installation. This equipment generates, uses and can radiate radio frequency energy and, if not installed and used in accordance with the instructions, may cause harmful interference to radio communications. However, there is no guarantee that interference will not occur in a particular installation. If this equipment does cause harmful interference to radio or television reception, which can be determined by turning the equipment off and on, the user is encouraged to try to correct the interference by one or more of the following measures:

- Reorient or relocate the receiving antenna.
- Increase the separation between the equipment and receiver.
- Connect the equipment into an outlet on a circuit different from that to which the receiver is connected.
- Consult the dealer or an experienced radio/amp technician for help.

Note

XDA SERIES

OWNER'S MANUAL

if its too
LOUD
you're too

The Bluetooth® word mark and logos are owned by the Bluetooth® SIG, Inc.
Other trademarks and trade names are those of their respective owners.



Customer Support

1-888-921-4088

(Monday-Friday, 9AM-5PM EST)

Visit <https://www.jensenmobile.com>

Designed and Engineered in USA

JENSEN®

Namsung America Inc.
©2020 Namsung America Inc.
All rights reserved.

All rights reserved. No part of this publication may be reproduced, distributed, or transmitted in any form or by any means, including photocopying, recording, or other electronic or mechanical methods, without the prior written permission of NAMSUNG AMERICA INC.

NSA0120-v01