

# VB803

## WIRELESS BABY MONITORING SYSTEM

SMART | SECURE | PRIVATE



## User Manual

Version 1.1

*Smart parenting partner, Make life better*

## Quick Start

**NOTE:** Use only the power adapters included in the package.

### Step 1

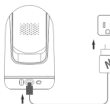

Check power  
blue LED ON



### Step 2

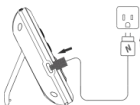

Check charging  
blue LED ON

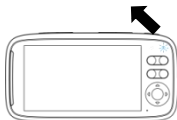

### Step 3

 Press and hold for 3s

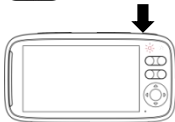

Check power  
red LED ON

## Status Bar

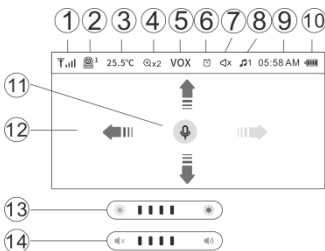

1. Signal Strength Indicator
2. Channel Selected
3. Temperature Of The Baby's Room
4. Zoom Level
5. VOX Function Active
6. Alarm Timer Active
7. Mute State
8. Lullaby Plays
9. Current Time
10. Battery Power
11. PTT Function Active
12. Pan & Tilt Function Active
13. Backlight Brightness Bar
14. Volume Level Bar

## Baby Unit

1. Light Sensor
2. Camera Lens
3. Power LED Indicator
4. Microphone
5. ON / OFF Switch
6. Infrared LEDs
7. Speaker
8. DC Jack IN
9. Temperature Sensor
10. PAIR Button

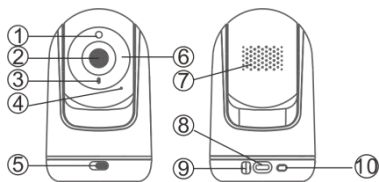

## Parent Unit

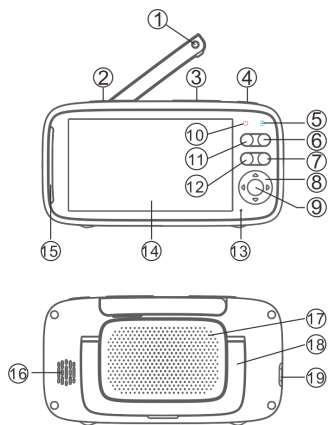

1. Antenna
2. Brightness Buttons
3. Volume Buttons
4. Power ON / OFF / Sleep Button
5. Charging LED Indicator
6. Lullaby Control Button
7. Return Button / Switch Channels
8. Navigation Buttons
9. Menu / OK Button
10. Signal LED Indicator
11. PTT Button
12. ZOOM Button
13. Microphone
14. LCD Screen
15. Volume Level LED
16. Speaker
17. Battery Compartment
18. Kickstand
19. Power Adapter Port

**View Electronic Label:** Press Menu / OK to select MENU > SETTINGS > SYSTEM INFO, which includes software version, hardware version and certification information etc.

## Pairing

The Baby Unit is pre-registered and connected to your Parent Unit. If you need to pair Baby Unit and Parent Unit again, do the following:

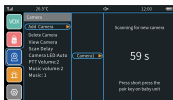

Select MENU > Camera  
> Add Camera > OK.



Please Short-Press PAIR  
button on Baby Unit.

## Multiple-Camera Operation

### 1. Add/ Delete Camera:

- Press Menu/OK to enter the registration interface. Select [Camera-> Add Camera-> Camera 2], then press Menu/OK to confirm registration.
- Press the Pair button on the back of the camera within 60 seconds to complete the registration.
- Same process applies to registering more cameras.
- To disconnect a camera, select [Delete Camera], choose the associated camera then press Menu/OK button to cancel the registration.
- Note: one monitor can pair with up to four cameras simultaneously.

### 2. Change Camera Channels:

- Select [View Camera] then press Menu/OK button on the Camera channel (Camera 1/Camera 2/Camera 3/Camera 4) that you would like to see on the screen.
- To change channels automatically, select [Scan] and press the Menu/OK button. Then select [Scan Delay] to set the scan intervals for view changing (10/15/20/30 seconds).

### 3. To change settings on different cameras:

- By changing the setting of one camera on the monitor, all the other connected camera's settings, including VOX mode on/off; camera speaker's volume; camera LED Auto/On/Off will be updated as well. The only function that cannot be changed simultaneously is the zoom-in function

## Safety Instructions

- An adult is required to install. Keep small parts away from the children when assembling.
- This product is not a toy. Do not allow children to play with it.
- This baby monitor is not a substitute for responsible adult supervision.
- Do not place the baby unit or cables in the cot or within arm's reach of the baby (at least 1 meter away). Keep the cords out of the reach of children.
- Do not use the baby monitor near water or a heat source.
- Only use the power adapters provided.
- Do not touch the plug contacts with sharp or metal objects.
- This equipment should be installed and operated with a minimum distance of 20cm between the radiator & your body.

## Specification

<b>General:</b>	
RF Frequency:	2408MHz – 2468MHz
Modulation Mode:	GFSK
Spread Spectrum:	FHSS
Operating Temperature:	-10 to +45°C
Operating Humidity:	<85%
Transmission Range:	Up to 1000feet in open field
<b>Monitor:</b>	
LCD Display:	5" IPS LCD
Resolution:	1280X720 pixel
Battery:	3050mAh Li-ion 3.8V rechargeable
Duration(Screen ON):	8 Hours (3 Level Lcd backlight)
Duration(Audio-only mode):	16 Hours (3 Level volume)
Time To Full Charge:	5 Hours
Power Adapter:	Input: 100-240VAC,50-60Hz; Output: 5V/1.2A ,Type C
<b>Camera:</b>	
Sensor:	CMOS 1280X720 pixel
Vertical Turning Angle:	90° up, 45° down
Horizontal Turning Angle:	165° left, 165° right
Night Vision:	10 IR LEDs
Power Adapter:	Input: 100-240VAC,50-60Hz; Output: 5V/1.2A,Type C

## FCC Warning

This device complies with part 15 of the FCC Rules. Operation is subject to the following two conditions: (1) This device may not cause harmful interference, and (2) this device must accept any interference received, including interference that may cause undesired operation.

Any Changes or modifications not expressly approved by the party responsible for compliance could void the user's authority to operate the equipment.

**Note:** This equipment has been tested and found to comply with the limits for a Class B digital device, pursuant to part 15 of the FCC Rules. These limits are designed to provide reasonable protection against harmful interference in a residential installation. This equipment generates uses and can radiate radio frequency energy and, if not installed and used in accordance with the instructions, may cause harmful interference to radio communications. However, there is no guarantee that interference will not occur in a particular installation. If this equipment does cause harmful interference to radio or television reception, which can be determined by turning the equipment off and on, the user is encouraged to try to correct the interference by one or more of the following measures:

- Reorient or relocate the receiving antenna.
- Increase the separation between the equipment and receiver.
- Connect the equipment into an outlet on a circuit different from that to which the receiver is connected.
- Consult the dealer or an experienced radio/TV technician for help.

Radiation Exposure Statement:

The baby unit complies with FCC/ISED radiation exposure limits set forth for an uncontrolled environment. The baby unit should be installed and operated with minimum distance 20cm between the radiator& your body.

The parent unit has been tested and comply with FCC and ISED SAR limits.