

CUSTOMER APPROVAL SHEET

Company Name	-
MODEL	EL026GFWRE
CUSTOMER APPROVAL	

- **APPROVAL FOR SPECIFICATIONS ONLY (Spec. Ver. 1.0)**
- **CUSTOMER REMARK :**

Issued By	Checked By	Approved By
YJ Kim	YB Lee	BJ Jun

Solu-M

A-Tower 6th Floor, 357 Guseong-ro, Giheung-gu, Yongin-si, Gyeonggi-do, Republic of Korea (Zip 16914)

Tel : 82-31-210-5114

S-TAG Datasheet

S-Label (Electronic Label System)

REV 1.0

SoluM

2018-08-31

Summary

This datasheet presents the general performance and specifications of S-Tag for S-Label ESL (Electronic Shelf Label) system, which is based on IEEE 802.15.4.

© 2018 Solu-M. All rights reserved

The names of actual companies and products mentioned herein may be the trademarks of their respective owners.

No part of this document may be reproduced, stored in a retrieval system, or transmitted in any form or by any means without the express written consent of Samsung Electro-Mechanics.

This document is subject to change without notice.

Table of Contents

1	GENERAL DESCRIPTION	5
1.1	FEATURES	6
1.2	TYPICAL APPLICATIONS	6
1.3	APPEARANCE	7
2	SPECIFICATION	8
2.1	PRODUCT SPECIFICATION.....	8
2.2	RADIO (RF) SPECIFICATION	8
2.3	MECHANICAL DRAWING	9
2.4	LABELS.....	11
2.5	BARCODE SCANNING.....	13
3	OPERATION TEST.....	14
4	ESL OPERATION BY DISPLAY	16
5	PACKAGE.....	19
6	CAUTIONS FOR TREATMENT.....	20
6.1	USAGE ENVIRONMENT.....	20
6.2	STORAGE AND USE.....	20
6.3	BATTERY REPLACEMENT.....	21
6.4	HOW TO CLEANING	22

Document History

Rev.	Date	Revision history	Page
1.0	31 AUG 2018	Initial release	-

1 General Description

This S-Tag product is a part of Samsung S-Label (Electronic Shelf Label) system as well as S-Label Gateway (S-Gate), Remote controller (S-RC). S-Label system make up a system that electronically displays price and other product information on S-Tags, which has been traditionally printed or written on paper in places like retail markets.

S-Tag receives product price/information updates from S-Gate and updates or changes its display of price and other information.

S-Tag is the product based on IEEE standard 802.15.4 for low power wireless communication applications. S-Tag consists of RF transceiver, RF circuitry and ARM Cortex M3 MCU offering IEEE 802.15.4 based network protocol and MAC protocol and other peripheral devices.

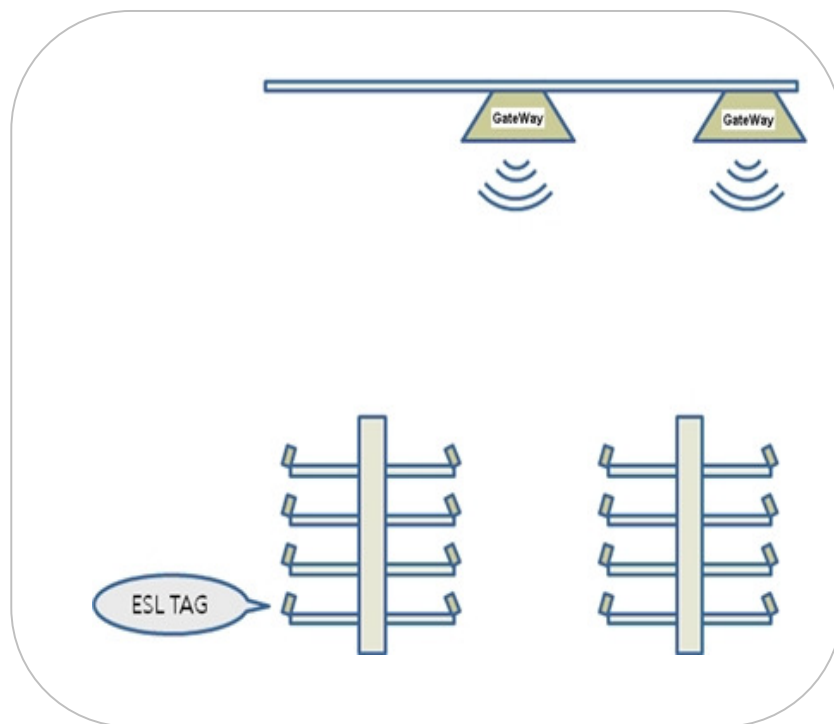

Figure 1 ESL System

1.1 Features

- Display : E-Paper Display (EPD) (active type)
- Display Color : Black, White, Red
- Display Resolution : 152 x 296 pixel (125dp)
- Communication : Wireless communication based on IEEE 802.15.4
- Operating on 2.4GHz Unlicensed ISM band for ZigBee
- Low Power Consumption
- External Wakeup : RF Wakeup (using ISM Band[2.4GHz])
- Outline Dimension : 45 mm x 120.33 mm x 18.05 mm
- Case Color : White
- Working condition: Indoor where wireless communication is available.

1.2 Typical Applications

- Retail industry with electronic displays, platforms, solutions and services.
- Intelligently communicating, managing, and optimizing price and product informations.

1.3 Appearance



Figure 2 Appearance

2 Specification

2.1 Product Specification

Item	Description
Size	69.4 mm x 36.2 mm x 11.65 mm
Battery (Life Time)	CR2450 Lithium Battery (3V) 2.4 ~ 3.3Vdc (condition : In active status) 5 years available for 1 updates in a day at room temperature (The Battery Life time is dependent on the operating conditions for ESL [temperature, etc...])
Display	Electrical paper display (active type) Display Resolution : 152 x 296 pixel (125dp)
Housing Color	White
Information display	Price, Unit, Symbol, Product Information etc.
Communication	Wireless communication based on IEEE 802.15.4
Communication Distance	Radius 20m (Line of Sight)
Operation Temp.	0 ~ 40 °C
Storage Temp.	-25 ~ 60 °C
Humidity	35 ~ 70% RH

2.2 Radio (RF)¹ Specification

Item	Parameter	SPEC			Unit	Condition
		Min	Typ	Max		
TX	Transmit Power	-5	0	8	dBm	
	Error Vector Magnitude	-	10	30	%	When measured for 100 chips
	Tx Current		-	35	mA	Total current at max Tx Power
RX	Receiver Sensitivity	-90	-	-	dBm	PER < 1%

¹ Test Channel : 2480MHz

2.3 Mechanical Drawing

2.3.1 Case Dimension

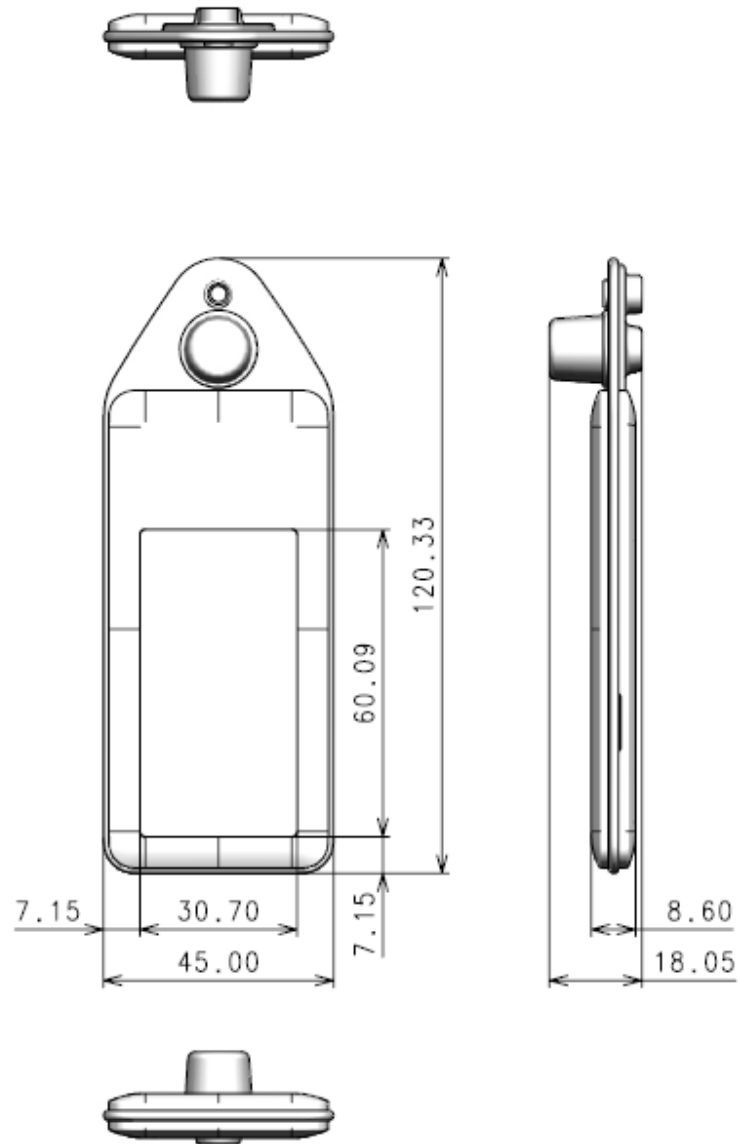

Figure 3 Mechanical Dimension

2.3.2 Exploded View

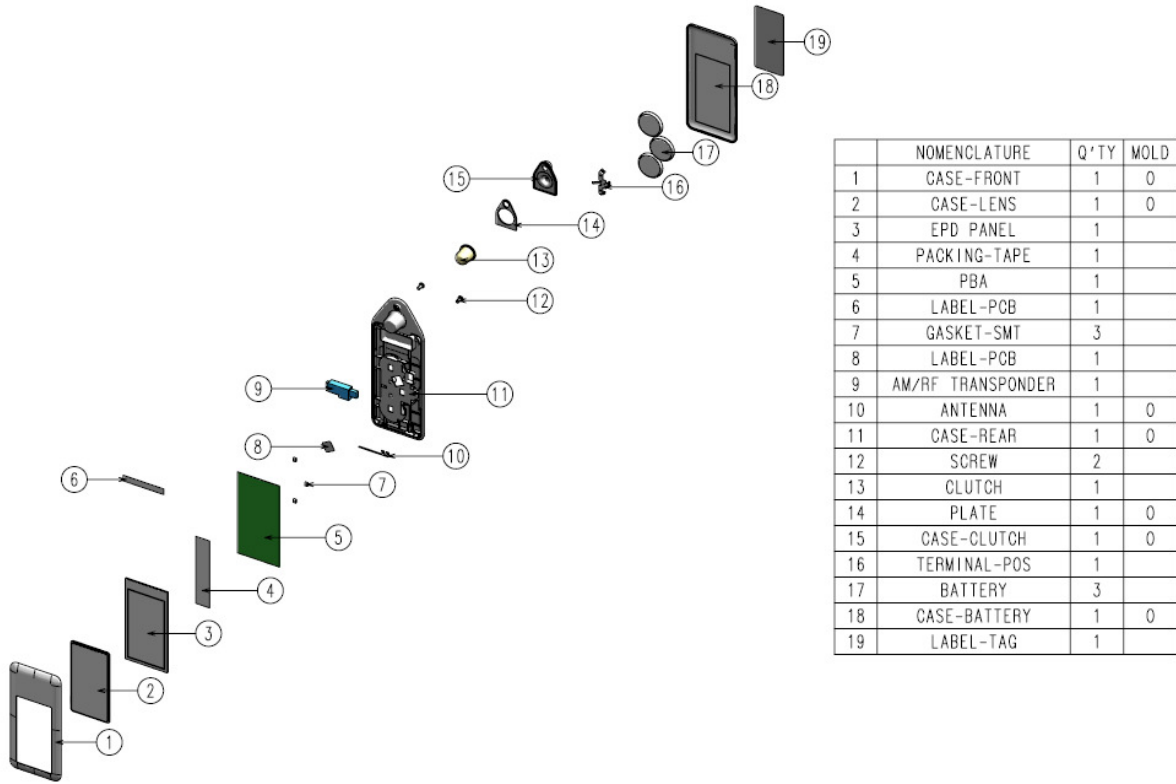

Figure 4 Exploded View

2.4 Labels

2.4.1 Serial Number Information

* Serial 1, 2 Code Value

13 3 G S A A 2JW

① ② ③ ④ ⑤ ⑥ ⑦

- ① Year : Last two digits of manufacturing year.
(00 ~ 99, example : 2013 is '13')
- ② Month : Manufacturing month
(1 ~ 9, X(10), Y(11), Z(12))
- ③ Date : Manufacturing date
(1 ~ 9, A(10) ~ V(31))
- ④ Vendor : One character of manufacturing vendor
((D : Dongguan Solu-M, V : Solu-M Vina., T : TSEM,etc))
- ⑤ Line number : One character of Manufacturing Line number
('A', 'B', 'C', etc)
- ⑥ Revision : Product revision number
(A : First, B : Second, C : Third, etc)
- ⑦ ZigBee IC Lot Number : Last 3 characters
(032 : SEM9110 1532(15 : Year, 32 : Week))

①		②		③	
년	CODE	월	CODE	일	CODE
2009	09	1	1	1	1
2010	10	2	2	2	2
2011	11	3	3	3	3
2012	12	4	4	4	4
2013	13	5	5	5	5
2014	14	6	6	6	6
2015	15	7	7	7	7
2016	16	8	8	8	8
2017	17	9	9	9	9
2018	18	10	X	10	A
2019	19	11	Y	11	B
2020	20	12	Z	12	C
2021	21			13	D
2022	22			14	E
				15	F
				16	G
				17	H
				18	I
				19	J
				20	K
				21	L
				22	M
				23	N
				24	O
				25	P
				26	Q
				27	R
				28	S
				29	T
				30	U
				31	V

2.4.2 Product and Mac Label Drawings

Product Label (Back, 55 x 25 mm)



Figure 5 Product and Mac Labels

Product information is indicated in a printed sticker label. The information consists of MODEL (model name), MFD (manufacturing date), S/N (serial number), MAC (MAC address), CE certification mark, FCC ID and Manufacture (SoluM).

- 1) FCC ID : 2AFWN-EL026GFWRE
Model Name : EL026GFWRE
- 2) MFD : (month).(date).(year) ex MAY.16.2016
- 3) S/N : Daily Production Quantity (6 digits) & Serial Number Information
(hexadecimal 10 digits)

2.5 Barcode Scanning

2.5.1 Barcode Scanning Condition

Typically Scan distance is 8 ~ 9cm and angle is horizontality

Example)

Item	MODEL	Distance	Angle
Scanner	SYMBOL (DS6708-SR20007ZZR)	8~9cm	Horizontality
	DATALOGIC (QUICKSCAN QD2430)	8~9cm	Horizontality
	Motorola (MC3190-SI2H04E0A)	8~9cm	Horizontality
PDA	Motorola (MC17T-00)	6cm	30°
	Motorola (MC4597-BAPBA0000)	8~9cm	Horizontality
	M3 (NA8NWCNMH40078)	8~9cm	Horizontality

<Horizontality>



<30°>



3 Operation Test

- Equipments : ESL Tag, Gateway, R/C



Figure 6 Operation Test

- **Test Scenario**

- ① Ready to Gateway and R/C
- ② Wake up Tag with R/C
- ③ Tag start to communicate with Gateway
- ④ Tag display the numeric information received from Gateway
- ⑤ Check Tag(EPD display status & MAC address value)
- ⑥ Wake up Tag with R/C
- ⑦ Check Tag(EPD display(blank display))

- **Criterion** (Below both two conditions should be all satisfied)

- ① Good : You can see 'Black' → 'White' display
- ② Compare MAC address with that of label attached to Front or Back plane.

- **Wake up area**

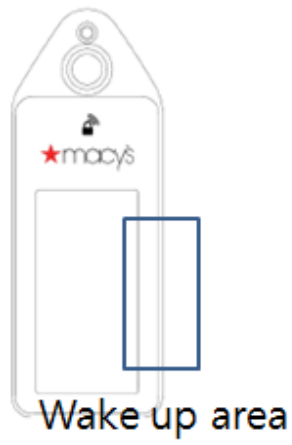

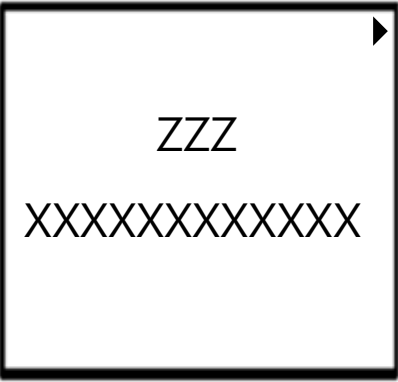



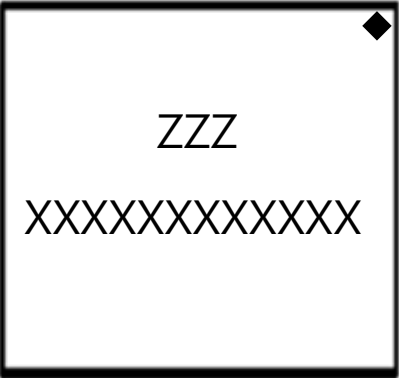

Figure 7 Wake up Area

4 ESL Operation by display

It will be updated before 2nd release. Below is just a sample.

Display	State	User Action
	<p>STATE: 0</p> <p>Initial display when shipped from the manufacturer (All white).</p>	<p>None</p>
	<p>STATE: 1</p> <p>No change.</p>	<p>To assign a tag using a PDA</p>
	<p>STATE 1 → 2</p> <p>Searching for GWs (Tag version, MAC address and triangle).</p>	<p>Assign Process</p> <p>→ Remove tape on the tag and then Tag can start to search the gateway automatically w/o beeper</p>

S-TAG Datasheet(EL026GFWRE)

	<p>STATE 2 → 4</p> <p>A tag is connected to a GW and received price (Price)</p>	<p>None</p>
	<p>STATE 2 → 3</p> <p>A tag failed to locate a GW (Tag version, MAC address).</p>	<p>Lost Status</p>
	<p>STATE 4 → 5</p> <p>Connection to a GW is lost (price and Rectangle on upper right corner)</p>	<p>Lost Status</p> <p>→ Even Tag lost GW, price and other information keep to be displayed with lost symbol '◆'</p>
	<p>STATE 5 → 6</p> <p>When connection is lost and woken up by an RC (blinks with the price and Rectangle) Starts to search GWs.</p>	<p>Woken up by a beeper</p>

S-TAG Datasheet(EL026GFWRE)

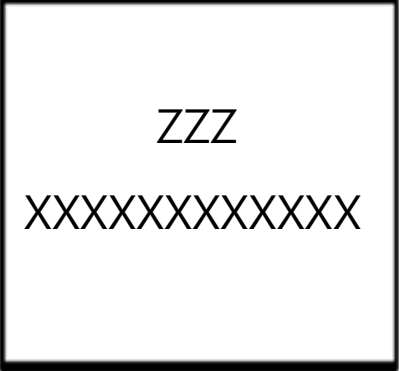
 A square frame representing a display screen. Inside the frame, the text 'ZZZ' is centered in the upper half, and 'XXXXXXXXXXXXX' is centered in the lower half.	<p>STATE 4 → 1 Initial display (Tag version, MAC address).</p>	<p>To clear an assigned tag using a PDA</p>
--	--	---

5 Package

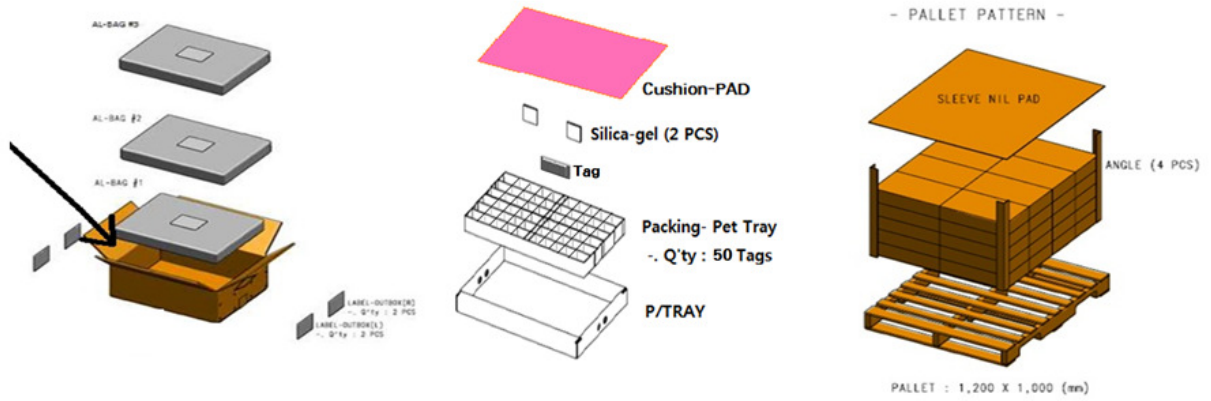

LABEL - BAG

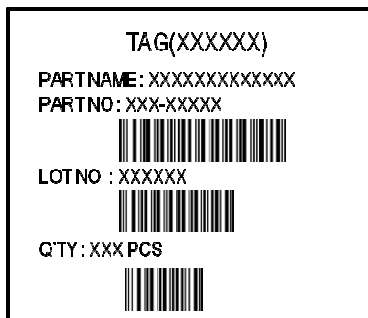

LABEL - OUTBOX(L)



LABEL - OUTBOX(R)



6 Cautions for Treatment

Provisions should be made to protect against any damage to the product caused by improper handling.

It is highly recommended that the product should be installed within 3 months from the date of arrival in the logistics hub. Recommended storage condition is in 0-40 Celsius degree, 35-70% RH environment.

This RF device operates on the 2.4GHz frequency band and can produce radio interference. The device, therefore, may not be used for applications where safety of human lives is concerned.

6.1 Usage Environment

Take extra cautions when using this RF device in the vicinity of other electronic devices and appliances. Most electronic devices and appliances use electromagnetic waves. Electromagnetic waves emitted by this RF device can affect other electronic devices and appliances.

If using the device in an explosion hazard area, follow all safety regulations, instructions, and signals.

6.2 Storage and Use

- Moisture and liquids can damage internal parts and circuit boards if allowed to enter into the device itself.
- Do not place or store the product on a sloped surface. The product may slide and fall off the surface and damaged.
- Use the product in temperatures ranging from 0°C to +40°C. Parts and circuits may be damaged if used or stored under temperature extremes.
- The display panel needs extra care when handling.
 - Do not apply any impacts on outside since e-Paper display is fragile.
 - Continuous exposure to excessive moisture (over 60% RH) or UV makes display lifetime shortened.
 - Ghosting image may be appeared in temperature conditions of less than 15 Celsius degree.
- Avoid areas with strong magnetism or subject to magnetism.
Contact between the device and a magnetic object can lead to malfunctions.
- Do not place the product near heat-producing kitchen appliances like a stove or a microwave or in the vicinity of highly pressurized containers.

- External impact to the product, such as from being dropped, can damage the product or battery casing can be separated.
- Twisting and bending the product can damage the exterior casing and the internal components.
- If this product operates abnormally in eliminating battery vinyl or replacing battery, you should discharge it by contacting battery terminal (+) and (-).
- This product uses 2.4GHz frequency band for wireless communication network. Radio communications can be limited or affected by other applications which share same frequency band, such as WiFi, Bluetooth, Zigbee, etc.
- Frequent communications, updates and screen renewals may reduce battery life time.

6.3 Battery Replacement

Audience

Authorized persons with the following knowledge are allowed to replace the battery.

- . Battery / -. Electronic assemblies like circuit board / -. Compliance of the instruction

※ Note : If not authorized person, it will not give any warranty.

(When need to replace the battery. Please contact authorized person and get instructions.)

Instructions

- Risk of short circuit if battery is incorrectly installed/stored.
 - Keep attention that your hands are dry before you start with replacement
 - Keep away batteries from children and infants.
 - Don't heat, charge, bend, drop, short-circuit and disassemble battery.
 - Don't mix the used battery together with the new battery or different type of batteries.
- ※ Note : Battery rarely has a little stain or leak.

■ Battery directional

Steps

- ① Open the battery cover.
- ② Take out the batteries.
- ③ Put in the new batteries.
- ④ Check the batteries direction.
- ⑤ Put the battery cover.

[View] Top : (+) Positive

Bottom : (-) Negative



6.4 How to cleaning

For Spray Cleaning:

Stand Tags not to lay down tags

Lightly spray surfaces and wait few second

Wipe dry using cloth or tissues.

Dry out tags

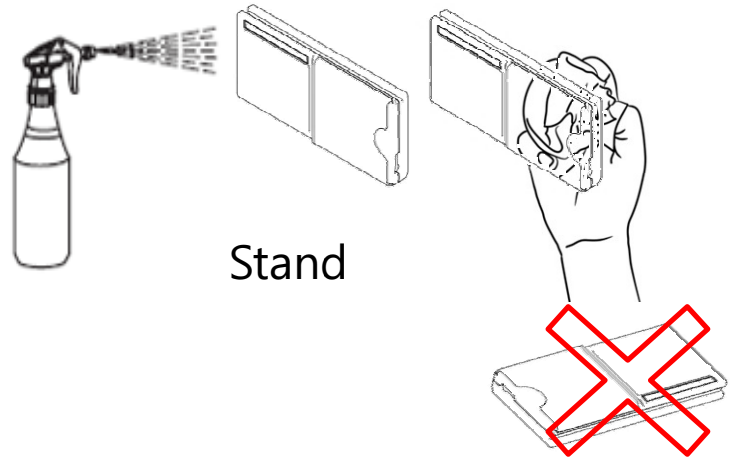

Note:

- **When spray the tags, make sure not to flow any liquid into inside tags**
- **It may damage tags directly, circuit and battery.**
- **You can use mild, non-alcoholic detergents or glass cleaner.**
- **Recommend non-abrasive cloths: Microfiber ,Cotton T-shirt ,Cotton handkerchief, Cotton tea towel**

For Wet Tissue Cleaning:

Lay down tags or stand tags

Wipe using wet tissues

Dry out tags



We do not guarantee any water damaged tags



WARNING : This equipment may generate or use radio frequency energy. Changes or modifications to this equipment may cause harmful interference unless the modifications are expressly approved in the instruction manual. The user could lose the authority to operate this equipment if an unauthorized change or modification is made.

This device complies with part 15 of the FCC Rules. Operation is subject to the following two conditions:
(1)

This device may not cause harmful interference, and (2) this device must accept any interference received, including interference that may cause undesired operation.

NOTE : This equipment has been tested and found to comply with the limits for a Class B digital device, pursuant to part 15 of the FCC Rules. These limits are designed to provide reasonable protection against harmful interference in a residential installation. This equipment generates, uses and can radiate radio frequency energy and, if not installed and used in accordance with the instructions, may cause harmful interference to radio communications. However, there is no guarantee that interference will not occur in a particular installation. If this equipment does cause harmful interference to radio or television reception, which can be determined by turning the equipment off and on, the user is encouraged to try to correct the

interference by one or more of the following measures:

- Reorient or relocate the receiving antenna.
- Increase the separation between the equipment and receiver.
- Connect the equipment into an outlet on a circuit different from that to which the receiver is connected.
- Consult the dealer or an experienced radio/TV technician for help.

Caution

This device complies with FCC radiation exposure limits for an uncontrolled environment. Avoid operating this device at a distance less than 20cm from the user

Caution

THE GRANTEE IS NOT RESPONSIBLE FOR ANY CHANGES OR MODIFICATIONS NOT EXPRESSLY APPROVED BY THE PARTY RESPONSIBLE FOR COMPLIANCE.

SUCH MODIFICATIONS COULD VOID THE USER'S AUTHORITY TO OPERATE THE EQUIPMENT.