

Antenna Specification

Specifications

Summary

ITEM	SPEC.	
Model Name	ISM 2.4 GHz	
Center Frequency	2403 MHz 2441 MHz 2480 MHz	2.03dBi 1.58 dBi 0.49 dBi
MAX. GAIN	2.03 dBi	
Polarization	Horizontal	
Azimuth Beam Pattern	Omni-directional	
Impedance	50 Ω	
Antenna Length	14.5MM	

Antenna Photo & Length

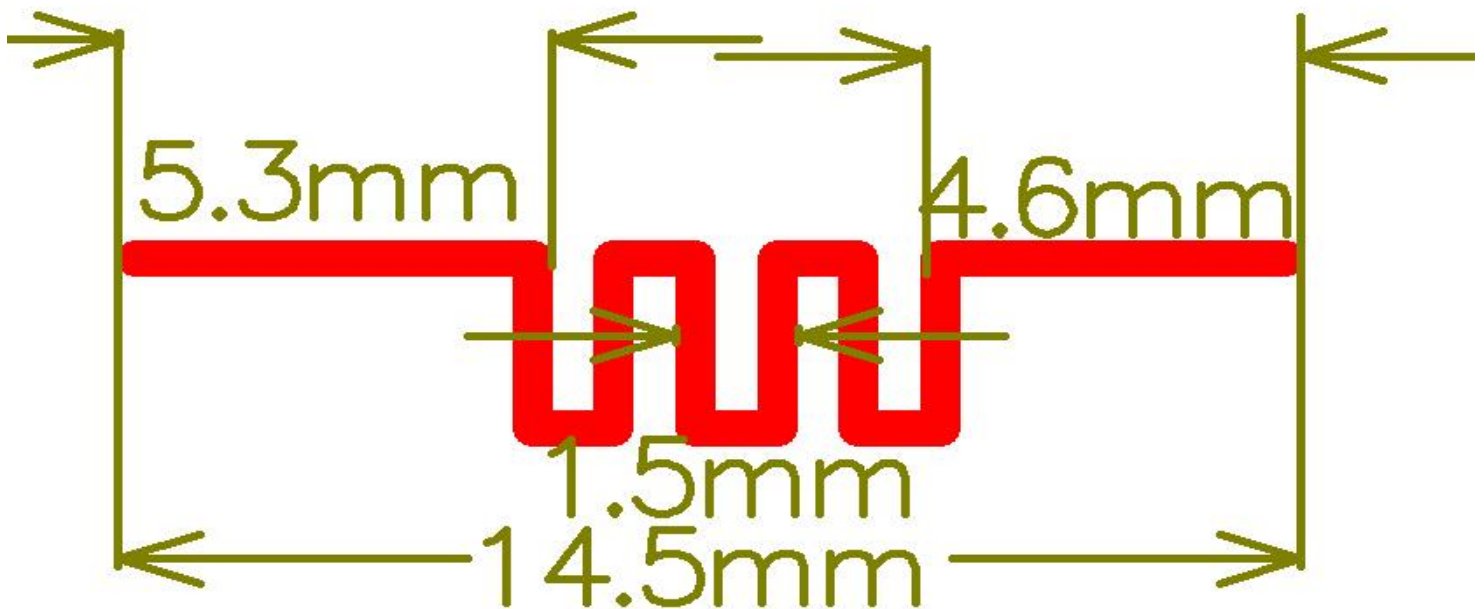

1.Main antenna : 2403 MHz

1.1 Horizontal



Advance Data Technology Corporation 誠信科技股份有限公司

Hsiao Yia Lab : No.10, Hsiao Yia 2nd RD, Hsinchu, Taiwan, R.O.C.
Tayuan Lab : 13-1 Lane 15, Wukang 2nd St, Hsinchu, Taiwan, R.O.C.
Hsinchu Lab: 21-1 Linkweg, 2F, Linkway Tech, Chungli, Hsinchu, Taiwan, R.O.C.

http://www.adt.com.tw Email: as@adt.com.tw
Tel: (886) 345-0233 Fax: (886) 345-0232
Tel: (886) 327-0210 Fax: (886) 327-0202
Tel: (886) 300-0242 Fax: (886) 300-0242

Brand / Model : IBM 2.4GHz
Remark : E1
Tested by : SHELLY
EUT description :

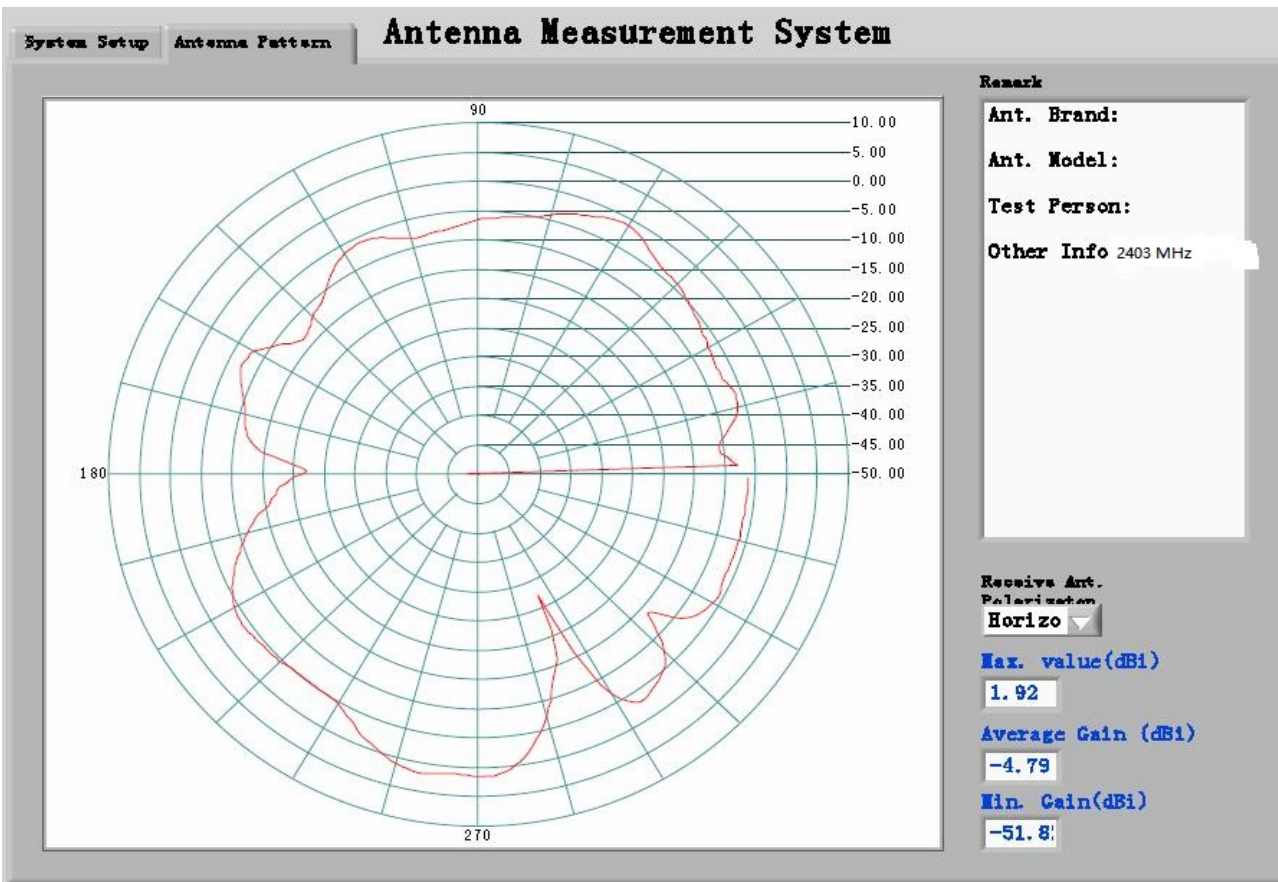

1.2 Vertical

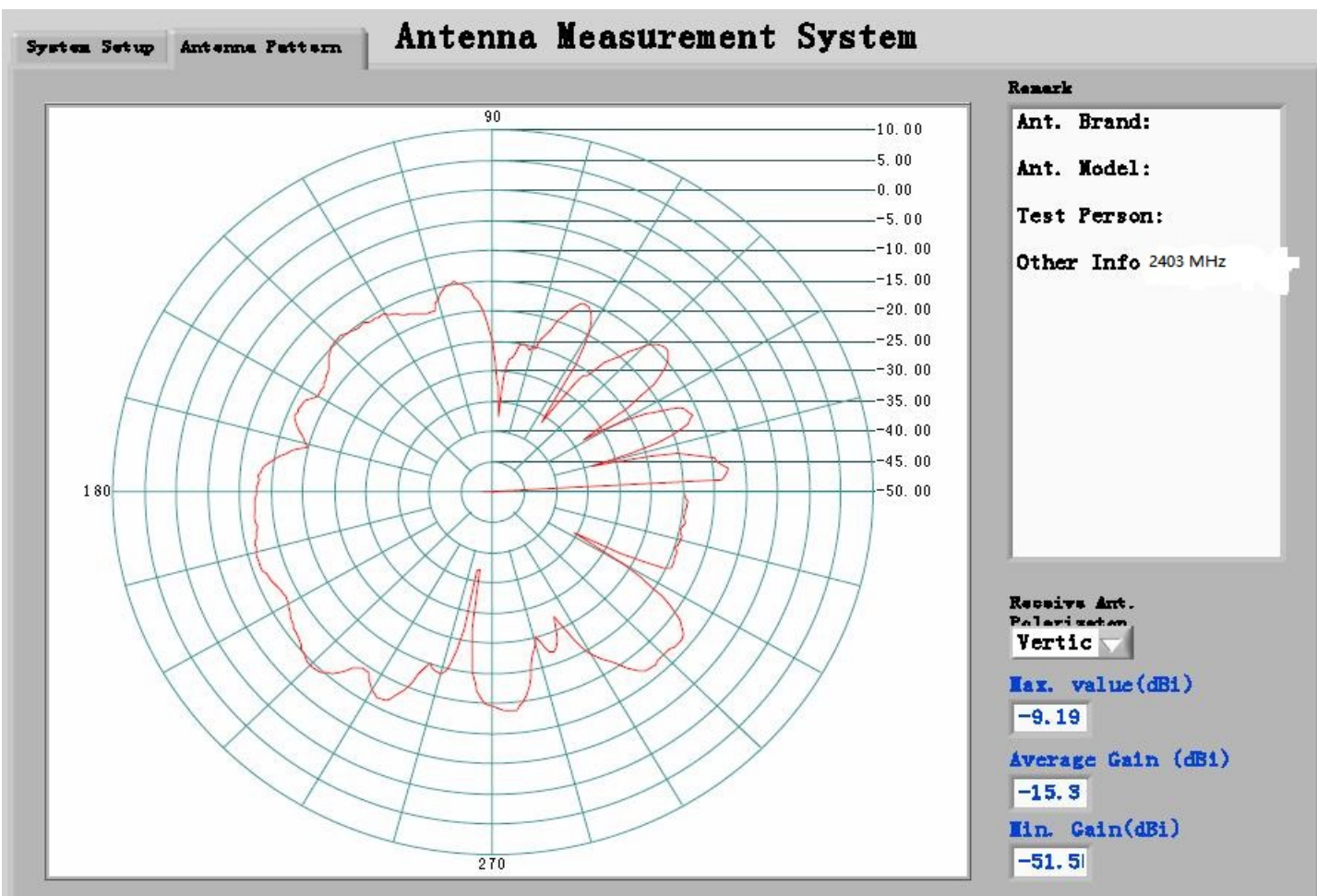

2.Main antenna : 2441 MHz

2.1 Horizontal

Advance Data Technology Corporation 誠信科技股份有限公司
Hsin Ya Lab : No.10, Hsin Ya 2nd Rd, Hsinchu, Taiwan, R.O.C.
TAYATEH LAB : 13-1 Lane 13, Hsin Ya 2nd Rd, Hsinchu, Taiwan, R.O.C.
Hsinchu Lab: 51-1 LHDongq. 3B Ln, Wungh Tzeng, Chunglin, Hsinchu, Taiwan, R.O.C.
http://www.adt.com.tw E-mail: adt@adtc.com.tw
Tel (33) 318-3232 Fax (33) 318-3233
Tel (33) 327-0910 Fax (33) 327-0992
Tel (33) 393-0343 Fax (33) 393-0342

Brand / Model : IBM 2.4GHz
Remark : B1
Tested by : SHELLY
EUT description :

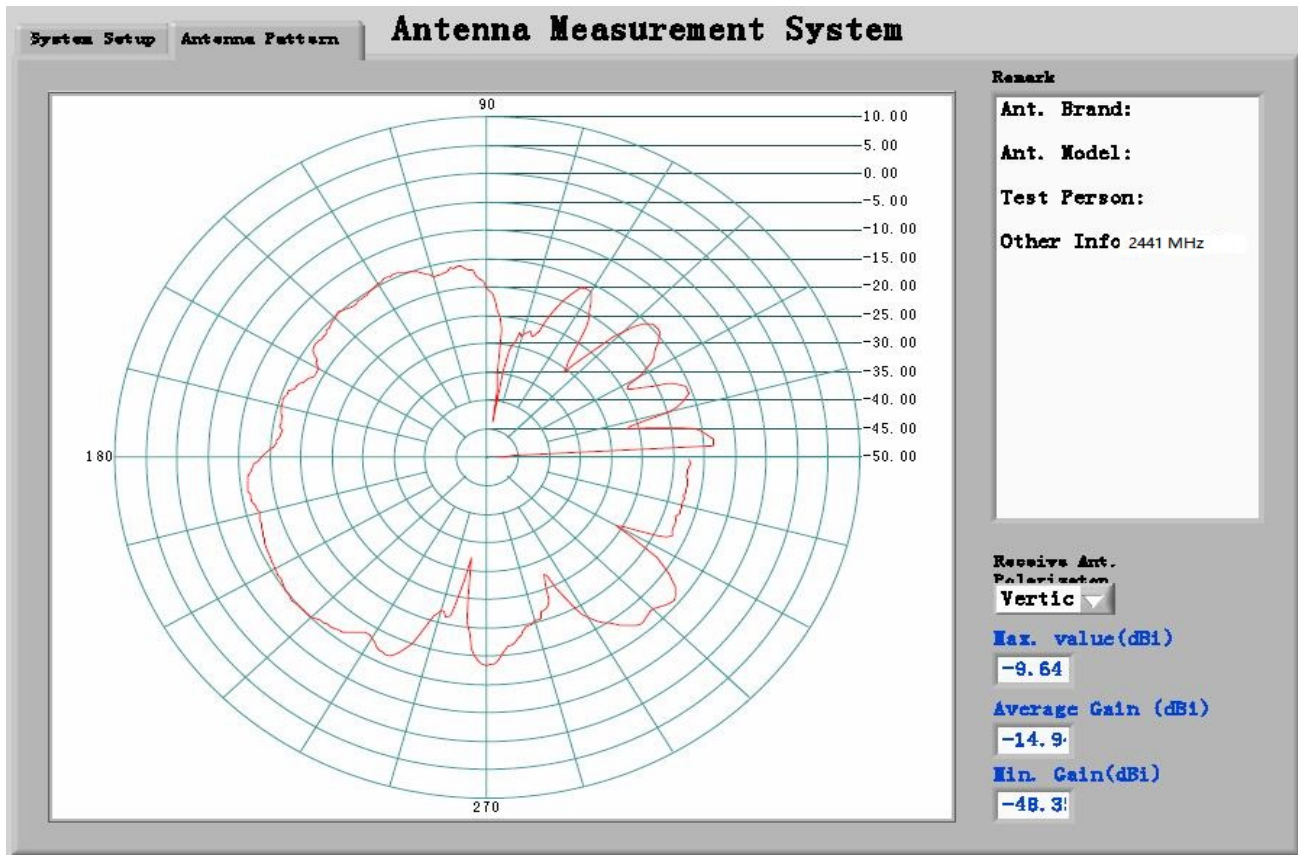

2.2 Vertical

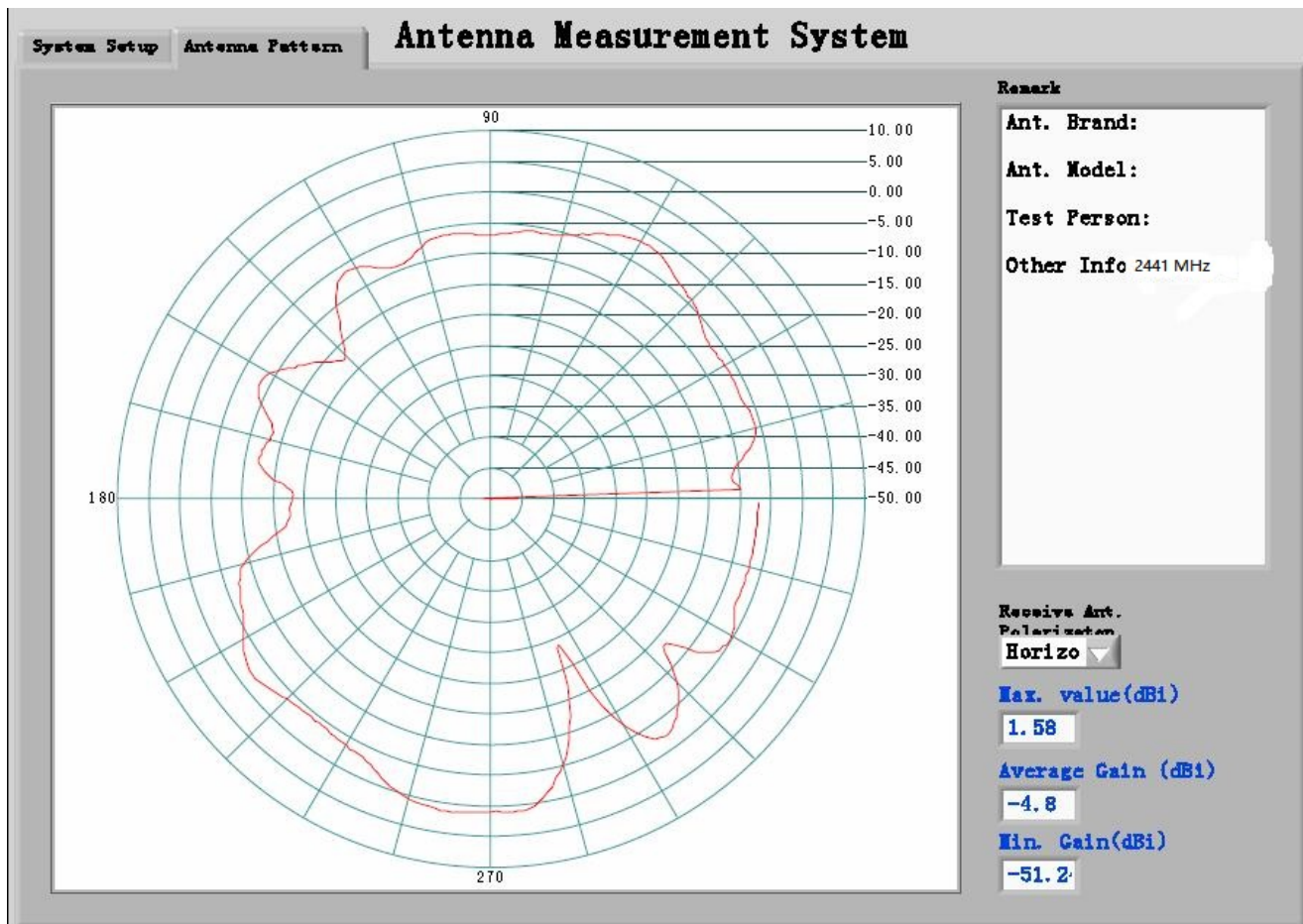

3. Main antenna : 2480 MHz

3.1 Horizontal

Advance Data Technology Corporation 廣信科技股份有限公司
Hsin-Ya Lab : No.19, Hsin-Ya 2nd Rd., Hsin-Ya, Taoyuan, Taiwan, R.O.C.
Taylor Lab : 13-1 Lane 19, Wk 5, Sec 2, Hsin-Ya, Taoyuan, Taiwan, R.O.C.
Hsin-Ya Lab : 13-1 Lane 19, Wk 5, Sec 2, Hsin-Ya, Taoyuan, Taiwan, R.O.C.
Tel: (886) 345-3232 Fax: (886) 345-3233
Tel: (886) 327-0510 Fax: (886) 327-0502
Tel: (886) 327-0510 Fax: (886) 327-0502

Brand / Model : IBM 2.4GHz
Remark : E1
Tested by : SHELLY
EUT description :

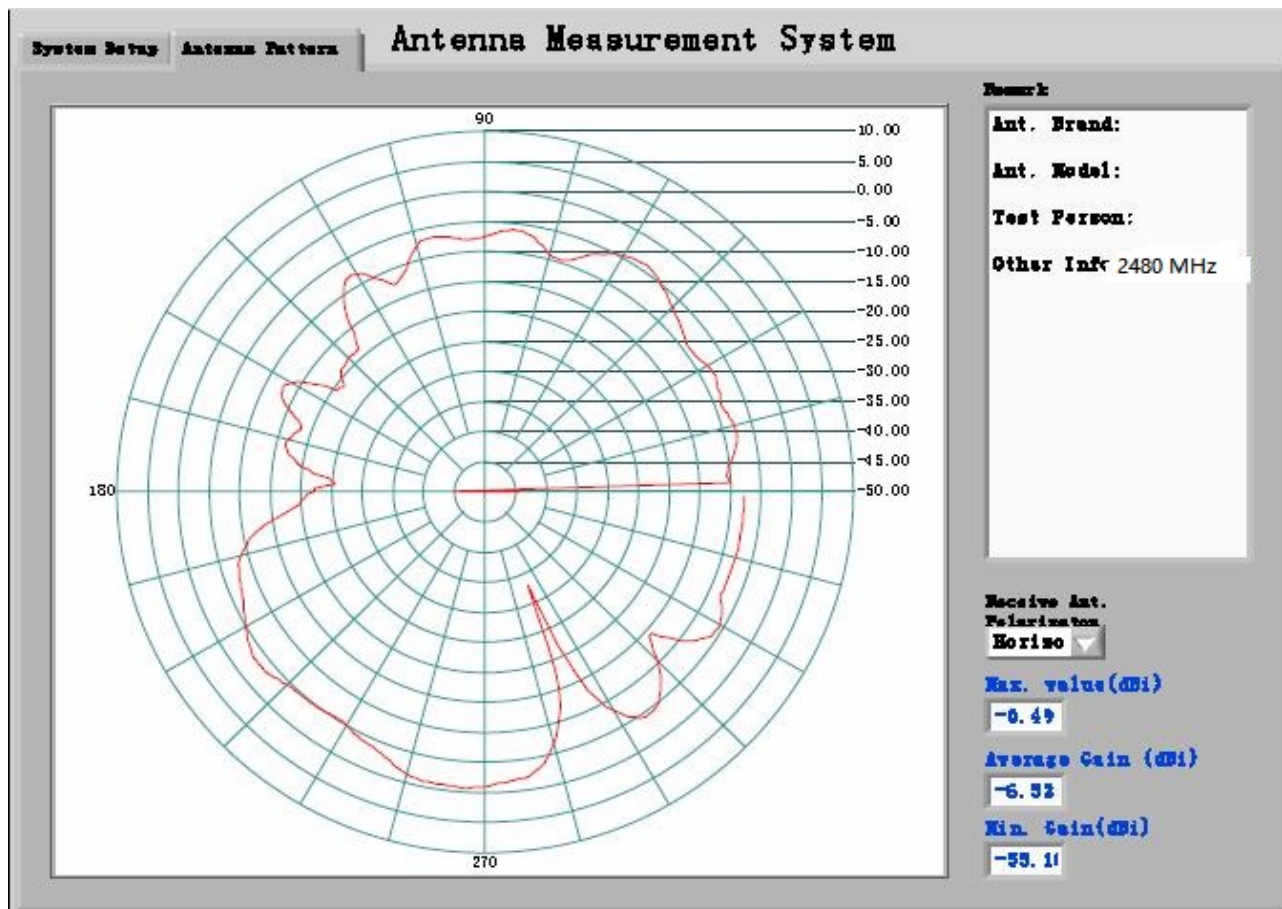

3.2 Vertical

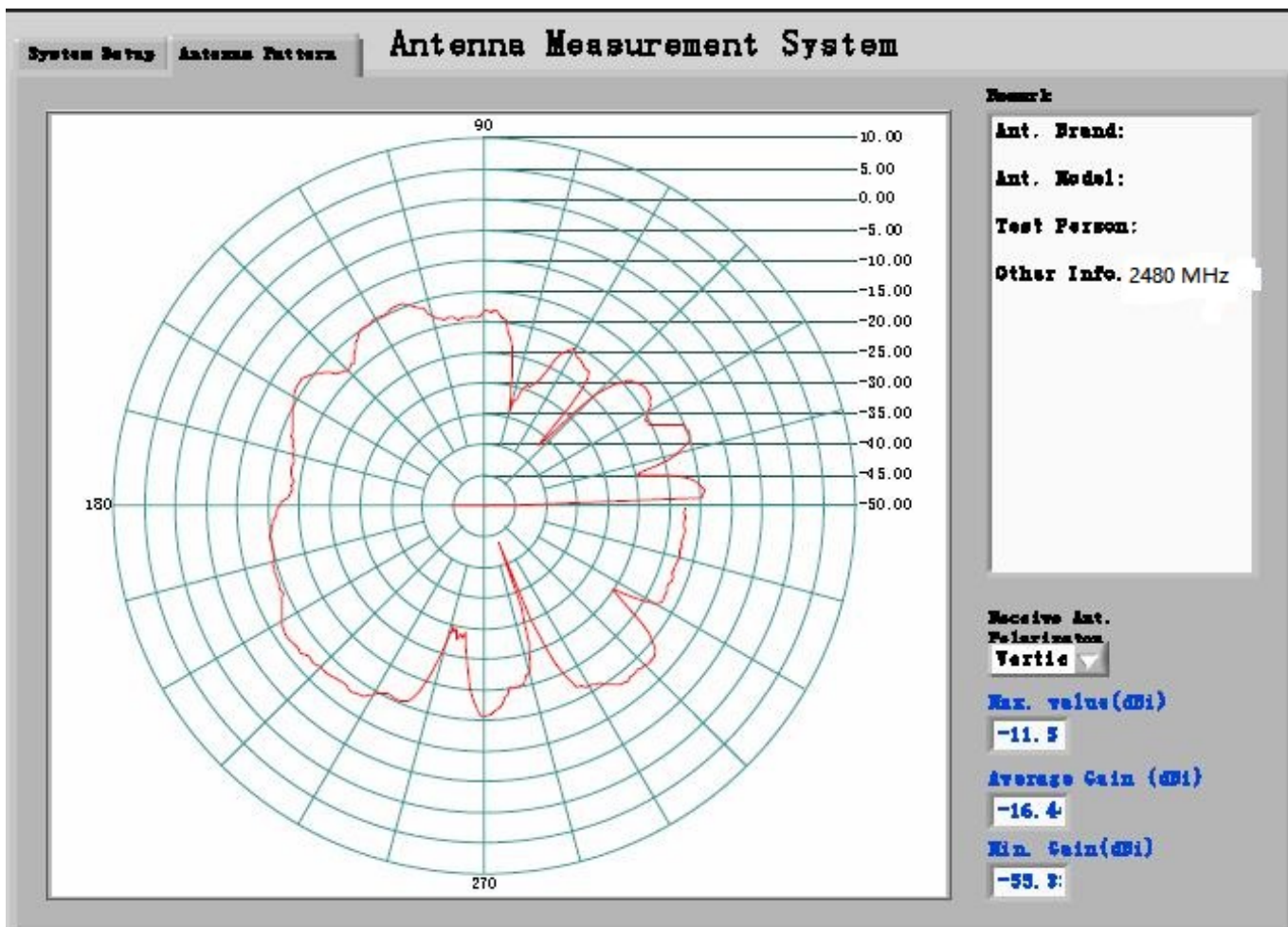

4. Result



Advance Data Technology Corporation 誠信科技股份有限公司

Hsin Ya Lab : No.19, Hsin Ya 2nd RD., Hsin Ya, Taipei, TAIWAN, R.O.C.

Taiwan Lab : 13-1 U2nd 15, Wn's 5th St 3rd St., Wn's 5th St., Taipei, TAIWAN, R.O.C.

Hsin Ya Lab : No.19, Hsin Ya 2nd RD., Hsin Ya, Taipei, TAIWAN, R.O.C.

Tel: (886) 2-27-0200 Fax: (886) 2-27-0201

Tel: (886) 2-27-0210 Fax: (886) 2-27-0202

Tel: (886) 2-27-0243 Fax: (886) 2-27-0242

Brand / Model : IBM 2.4GHz

Remark : E1

Tested by : SHELLY

EUT description :

Center Frequency		Maximum Ant Gain
2403 MHz	H	2.03 dBi
	V	-9.24 dBi
2441 MHz	H	1.61 dBi
	V	-9.65 dBi
2480 MHz	H	0.49 dBi
	V	-11.45 dBi