



# FCC RADIO TEST REPORT-WIFI

## FCC ID: 2AFSS-WIFISPK

**Product :** Bluetooth Speaker

**Trade Name :** cowin

**Model Name :** iChocolate PRO

**Serial Model :** N/A

**Report No. :** NTEK-2015NT09122654F1

### Prepared for

Shenzhen MeiDong Acoustics Co., Ltd.

Cell B, 3th Floor, Tower B, Hongzhuyongqi Technology Park, Lezhujiao,  
Xixiang, Baoan, Shenzhen, Guangdong, China

### Prepared by

Shenzhen NTEK Testing Technology Co., Ltd.

1/F, Building E, Fenda Science Park, Sanwei Community, Xixiang Street  
Bao'an District, Shenzhen P.R. China

Tel.: +86-0755-61156588 Fax.: +86-0755-61156599

Website: [www.ntek.org.cn](http://www.ntek.org.cn)

## TEST RESULT CERTIFICATION

**Applicant's name** ..... Shenzhen MeiDong Acoustics Co., Ltd.  
**Address**..... Cell B, 3th Floor, Tower B, Hongzhuyongqi Technology Park, Lezhujiao,  
Xixiang, Baoan, Shenzhen, Guangdong, China

**Manufacturer's Name** ... Shenzhen MeiDong Acoustics Co., Ltd.  
**Address**..... Cell B, 3th Floor, Tower B, Hongzhuyongqi Technology Park, Lezhujiao,  
Xixiang, Baoan, Shenzhen, Guangdong, China

### Product description

**Product name** ..... Bluetooth Speaker

**Model and/or type** ..... iChocolate PRO  
**reference** .....

**Serial Model** ..... N/A

**Standards** ..... FCC Part15.247 01 Oct. 2015

**Test procedure** ..... ANSI C63.10-2013 and KDB 558074: June 5, 2014

This device described above has been tested by NTEK, and the test results show that the equipment under test (EUT) is in compliance with the FCC requirements. And it is applicable only to the tested sample identified in the report.

This report shall not be reproduced except in full, without the written approval of NTEK, this document may be altered or revised by NTEK, personnel only, and shall be noted in the revision of the document.

**Date of Test** .....

**Date (s) of performance of tests**..... 12 Sep. 2015 ~15 Oct. 2015

**Date of Issue** ..... 15 Oct. 2015

**Test Result**..... **Pass**

**Testing Engineer** :   
\_\_\_\_\_  
(Allen Liu)

**Technical Manager** :   
\_\_\_\_\_  
(Brown Lu)

**Authorized Signatory** :   
\_\_\_\_\_  
(Sam Chen)

**Table of Contents**

	<b>Page</b>
<b>1 . SUMMARY OF TEST RESULTS</b>	<b>5</b>
1.1 TEST FACILITY	6
1.2 MEASUREMENT UNCERTAINTY	6
<b>2 . GENERAL INFORMATION</b>	<b>7</b>
2.1 GENERAL DESCRIPTION OF EUT	7
2.2 DESCRIPTION OF TEST MODES	9
2.3 BLOCK DIGRAM SHOWING THE CONFIGURATION OF SYSTEM TESTED	10
2.4 DESCRIPTION OF SUPPORT UNITS(CONDUCTED MODE)	11
2.5 EQUIPMENTS LIST FOR ALL TEST ITEMS	12
<b>3 . EMC EMISSION TEST</b>	<b>13</b>
3.1 CONDUCTED EMISSION MEASUREMENT	13
3.1.1 POWER LINE CONDUCTED EMISSION LIMITS	13
3.1.2 TEST PROCEDURE	14
3.1.3 DEVIATION FROM TEST STANDARD	14
3.1.4 TEST SETUP	14
3.1.5 EUT OPERATING CONDITIONS	14
3.1.6 TEST RESULTS	15
3.2 RADIATED EMISSION MEASUREMENT	19
3.2.1 RADIATED EMISSION LIMITS	19
3.2.2 TEST PROCEDURE	20
3.2.3 DEVIATION FROM TEST STANDARD	20
3.2.4 TEST SETUP	21
3.2.5 EUT OPERATING CONDITIONS	22
3.2.6 TEST RESULTS (BETWEEN 9KHZ – 30 MHZ)	23
3.2.7 TEST RESULTS (BETWEEN 30MHZ – 1GHZ)	24
3.2.8 TEST RESULTS (ABOVE 1000 MHZ)	26
<b>4 . POWER SPECTRAL DENSITY TEST</b>	<b>27</b>
4.1 APPLIED PROCEDURES / LIMIT	27
4.1.1 TEST PROCEDURE	27
4.1.2 DEVIATION FROM STANDARD	27
4.1.3 TEST SETUP	27
4.1.4 EUT OPERATION CONDITIONS	27
4.1.5 TEST RESULTS	28
<b>5 . BANDWIDTH TEST</b>	<b>36</b>
5.1 APPLIED PROCEDURES / LIMIT	36
5.1.1 TEST PROCEDURE	36

**Table of Contents**

	<b>Page</b>
<b>TEST SETUP</b>	<b>36</b>
<b>5.1.2 EUT OPERATION CONDITIONS</b>	<b>36</b>
<b>5.1.3 TEST RESULTS</b>	<b>37</b>
<b>6 . PEAK OUTPUT POWER TEST</b>	<b>45</b>
<b>6.1 APPLIED PROCEDURES / LIMIT</b>	<b>45</b>
<b>6.1.1 TEST PROCEDURE</b>	<b>45</b>
<b>6.1.2 DEVIATION FROM STANDARD</b>	<b>45</b>
<b>6.1.3 TEST SETUP</b>	<b>45</b>
<b>6.1.4 EUT OPERATION CONDITIONS</b>	<b>45</b>
<b>6.1.5 TEST RESULTS</b>	<b>46</b>
<b>7 . 100 KHZ BANDWIDTH OF FREQUENCY BAND EDGE</b>	<b>47</b>
<b>7.1 DEVIATION FROM STANDARD</b>	<b>47</b>
<b>7.2 TEST SETUP</b>	<b>47</b>
<b>7.3 EUT OPERATION CONDITIONS</b>	<b>47</b>
<b>7.4 TEST RESULTS</b>	<b>48</b>
<b>8 . ANTENNA REQUIREMENT</b>	<b>54</b>
<b>8.1 STANDARD REQUIREMENT</b>	<b>54</b>
<b>8.2 EUT ANTENNA</b>	<b>54</b>
<b>9 . EUT TEST PHOTO</b>	<b>55</b>
<b>APPENDIX-PHOTOGRAPHS OF EUT CONSTRUCTIONAL DETAILS</b>	

### 1. SUMMARY OF TEST RESULTS

Test procedures according to the technical standards:

FCC Part15 (15.247) , Subpart C			
Standard Section	Test Item	Judgment	Remark
15.207	Conducted Emission	PASS	
15.247 (a)(2)	6dB Bandwidth	PASS	
15.247 (b)	Peak Output Power	PASS	
15.247 (c)	Radiated Spurious Emission	PASS	
15.247 (d)	Power Spectral Density	PASS	
15.205	Band Edge Emission	PASS	
15.203	Antenna Requirement	PASS	

**NOTE:**

(1) "N/A" denotes test is not applicable in this Test Report

**1.1 TEST FACILITY**

NTEK Testing Technology Co., Ltd  
 Add.:1/F, Building E, Fenda Science Park, Sanwei Community, Xixiang Street, Bao'an District, Shenzhen P.R. China.  
 FCC Registration No.:238937; IC Registration No.:9270A-1  
 CNAS Registration No.:L5516

**1.2 MEASUREMENT UNCERTAINTY**

The reported uncertainty of measurement  $y \pm U$ , where expanded uncertainty  $U$  is based on a standard uncertainty multiplied by a coverage factor of  $k=2$ , providing a level of confidence of approximately 95 %.

No.	Item	Uncertainty
1	Conducted Emission Test	$\pm 1.38\text{dB}$
2	RF power,conducted	$\pm 0.16\text{dB}$
3	Spurious emissions,conducted	$\pm 0.21\text{dB}$
4	All emissions,radiated(<1G)	$\pm 4.68\text{dB}$
5	All emissions,radiated(>1G)	$\pm 4.89\text{dB}$
6	Temperature	$\pm 0.5^\circ\text{C}$
7	Humidity	$\pm 2\%$

## 2. GENERAL INFORMATION

### 2.1 GENERAL DESCRIPTION OF EUT

Equipment	Bluetooth Speaker	
Trade Name	cowin	
Model Name	iChocolate PRO	
Serial Model	N/A	
Model Difference	N/A	
Product Description	Operation Frequency:	802.11b/g/n(20MHz): 2412~2462MHz 802.11n(40MHz):2422~2452MHz
	Modulation Type:	IEEE 802.11b : DSSS (CCK, QPSK, DBPSK) IEEE 802.11g/n (HT20/HT40) : OFDM (64QAM, 16QAM, QPSK, BPSK)
	Bit Rate of Transmitter	802.11b:11/5.5/2/1 Mbps 802.11g:54/48/36/24/18/12/9/6Mbps 802.11n(20MHz/40MHz):150/144.44/130/117/115.56/104/86.67/78/52/6.5Mbps
	Number Of Channel	802.11b/g/n20MHz:11CH 802.11n40MHz:7CH
	Antenna Designation:	Please see Note 3.
	Antenna Gain (dBi)	1.0 dbi
	Channel List	Please refer to the Note 2.
Ratings	DC 3.7V	
Adapter	N/A	
Battery	DC 3.7V, 2000mAh	
Connecting I/O Port(s)	Please refer to the User's Manual	

Note:

1. For a more detailed features description, please refer to the manufacturer's specifications or the User's Manual.

2.

Channel List for 802.11b/g/n(20 MHz)							
Channel	Frequency (MHz)	Channel	Frequency (MHz)	Channel	Frequency (MHz)	Channel	Frequency (MHz)
01	2412	04	2427	07	2442	10	2457
02	2417	05	2432	08	2447	11	2462
03	2422	06	2437	09	2452		

Channel List for 802.11n(40MHz)							
Channel	Frequency (MHz)	Channel	Frequency (MHz)	Channel	Frequency (MHz)	Channel	Frequency (MHz)
03	2422	06	2437	09	2452		
04	2427	07	2442				
05	2432	08	2447				

3.

Table for Filed Antenna

Ant	Brand	Model Name	Antenna Type	Connector	Gain (dBi)	NOTE
A	N/A	N/A	FPCB Antenna	N/A	1.0	Wifi Antenna



## 2.2 DESCRIPTION OF TEST MODES

To investigate the maximum EMI emission characteristics generates from EUT, the test system was pre-scanning tested base on the consideration of following EUT operation mode or test configuration mode which possible have effect on EMI emission level. Each of these EUT operation mode(s) or test configuration mode(s) mentioned above was evaluated respectively.

Pretest Mode	Description
Mode 1	802.11b CH1/ CH6/ CH11
Mode 2	802.11g CH1/ CH6/ CH11
Mode 3	802.11n20 CH1/ CH6/ CH11
Mode 4	802.11n40 CH3/ CH6/ CH9
Mode 5	Link Mode

For Conducted Emission	
Final Test Mode	Description
Mode 5	Link Mode

Pretest Mode	Description
Mode 1	802.11b CH1/ CH6/ CH11
Mode 2	802.11g CH1/ CH6/ CH11
Mode 3	802.11n20 CH1/ CH6/ CH11
Mode 4	802.11n40 CH3/ CH6/ CH9
Mode 5	Link Mode

Note:

- (1) The measurements are performed at the highest, middle, lowest available channels.
- (2) The measurements are performed at all Bit Rate of Transmitter, the worst data was reported
- (3) EUT configured to transmit continuously:

Operated Mode for Worst Duty Cycle	
Test Signal Duty Cycle (x)	Average correction factor (dB)
100% - IEEE 802.11b	0
100% - IEEE 802.11g	0
100% - IEEE 802.11n (HT20)	0
100% - IEEE 802.11n (HT40)	0

### 2.3 BLOCK DIGRAM SHOWING THE CONFIGURATION OF SYSTEM TESTED

#### Conducted Emission Test

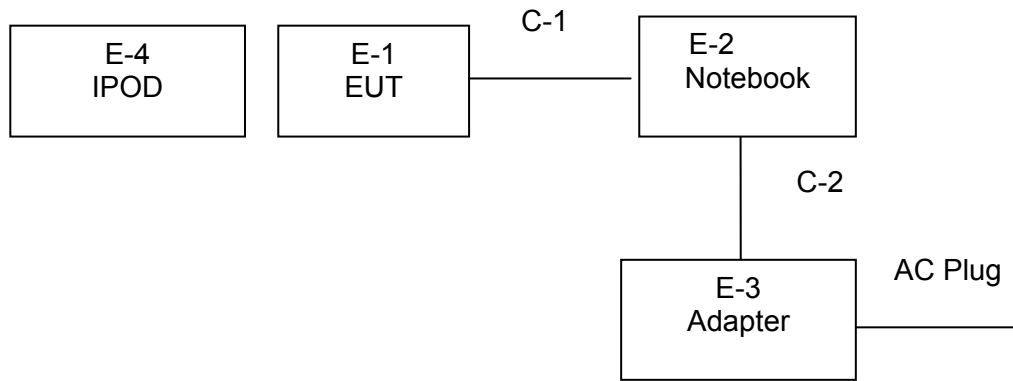

#### Radiated Spurious Emission Test

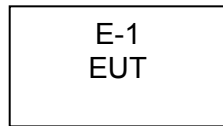

**2.4 DESCRIPTION OF SUPPORT UNITS(CONDUCTED MODE)**

The EUT has been tested as an independent unit together with other necessary accessories or support units. The following support units or accessories were used to form a representative test configuration during the tests.

Item	Equipment	Brand	Model/Type No.	Series No.	Note
E-1	Bluetooth Speaker	cowin	iChocolate PRO	N/A	EUT
E-2	Notebook	Lenove	Thinkpad Edge E430	N/A	
E-3	Adapter	Lenove	ADLX90NCT3A	N/A	
E-4	IPOD	Apple	A1367	N/A	

Item	Shielded Type	Ferrite Core	Length	Note
C-1	NO	NO	0.8m	
C-2	NO	NO	1.2m	

Note:

- (1) The support equipment was authorized by Declaration of Confirmation.
- (2) For detachable type I/O cable should be specified the length in cm in 『Length』 column.

## 2.5 EQUIPMENTS LIST FOR ALL TEST ITEMS

### Radiation Test equipment

Item	Kind of Equipment	Manufacturer	Type No.	Serial No.	Last calibration	Calibrated until	Calibration period
1	Spectrum Analyzer	Agilent	E4407B	MY45108040	2015.07.06	2016.07.05	1 year
2	Test Receiver	R&S	ESPI	101318	2015.06.06	2016.06.05	1 year
3	Bilog Antenna	TESEQ	CBL6111D	31216	2015.07.06	2016.07.05	1 year
4	50Ω Coaxial Switch	Anritsu	MP59B	6200264416	2015.06.06	2016.06.05	1 year
5	Spectrum Analyzer	ADVANTEST	R3132	150900201	2015.06.06	2016.06.05	1 year
6	Horn Antenna	EM	EM-AH-10180	2011071402	2015.07.06	2016.07.05	1 year
7	Horn Ant	Schwarzbeck	BBHA 9170	9170-181	2015.07.06	2016.07.05	1 year
8	Amplifier	EM	EM-30180	060538	2014.12.22	2015.12.21	1 year
9	Loop Antenna	ARA	PLA-1030/B	1029	2015.06.06	2016.06.05	1 year
10	Power Meter	R&S	NRVS	100696	2015.07.06	2016.07.05	1 year
11	Power Sensor	R&S	URV5-Z4	0395.1619.05	2015.07.06	2016.07.05	1 year

### Conduction Test equipment

Item	Kind of Equipment	Manufacturer	Type No.	Serial No.	Last calibration	Calibrated until	Calibration period
1	Test Receiver	R&S	ESCI	101160	2015.06.06	2016.06.05	1 year
2	LISN	R&S	ENV216	101313	2015.08.24	2016.08.23	1 year
3	LISN	EMCO	3816/2	00042990	2015.06.06	2016.06.05	1 year
4	50Ω Coaxial Switch	Anritsu	MP59B	6200264417	2015.06.06	2016.06.05	1 year
5	Passive Voltage Probe	R&S	ESH2-Z3	100196	2015.06.06	2016.06.05	1 year
6	Absorbing clamp	R&S	MOS-21	100423	2015.06.06	2016.06.05	1 year

1	Attenuation	MCE	24-10-34	BN9258	2015.07.06	2016.07.05	1 year
---	-------------	-----	----------	--------	------------	------------	--------

### 3. EMC EMISSION TEST

#### 3.1 CONDUCTED EMISSION MEASUREMENT

##### 3.1.1 POWER LINE CONDUCTED EMISSION Limits (Frequency Range 150KHz-30MHz)

FREQUENCY (MHz)	Class A (dBuV)		Class B (dBuV)		Standard
	Quasi-peak	Average	Quasi-peak	Average	
0.15 -0.5	79.00	66.00	66 - 56 *	56 - 46 *	CISPR
0.50 -5.0	73.00	60.00	56.00	46.00	CISPR
5.0 -30.0	73.00	60.00	60.00	50.00	CISPR

0.15 -0.5	79.00	66.00	66 - 56 *	56 - 46 *	FCC
0.50 -5.0	73.00	60.00	56.00	46.00	FCC
5.0 -30.0	73.00	60.00	60.00	50.00	FCC

Note:

- (1) The tighter limit applies at the band edges.
- (2) The limit of " \* " marked band means the limitation decreases linearly with the logarithm of the frequency in the range.

The following table is the setting of the receiver

Receiver Parameters	Setting
Attenuation	10 dB
Start Frequency	0.15 MHz
Stop Frequency	30 MHz
IF Bandwidth	9 kHz

**3.1.2 TEST PROCEDURE**

- a. The EUT was placed 0.8 meters from the horizontal ground plane with EUT being connected to the power mains through a line impedance stabilization network (LISN). All other support equipments powered from additional LISN(s). The LISN provide 50 Ohm/ 50uH of coupling impedance for the measuring instrument.
- b. Interconnecting cables that hang closer than 40 cm to the ground plane shall be folded back and forth in the center forming a bundle 30 to 40 cm long.
- c. I/O cables that are not connected to a peripheral shall be bundled in the center. The end of the cable may be terminated, if required, using the correct terminating impedance. The overall length shall not exceed 1 m.
- d. LISN at least 80 cm from nearest part of EUT chassis.
- e. For the actual test configuration, please refer to the related Item –EUT Test Photos.

**3.1.3 DEVIATION FROM TEST STANDARD**

No deviation

**3.1.4 TEST SETUP**

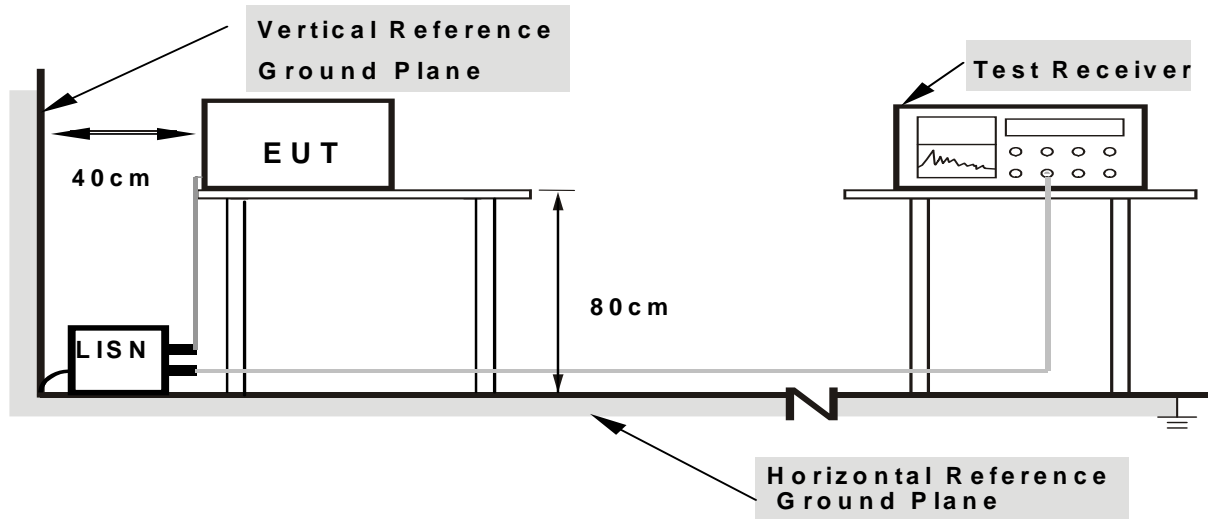

- Note:**
- 1. Support units were connected to second LISN.
  - 2. Both of LISNs (AMN) are 80 cm from EUT and at least 80 from other units and other metal planes

**3.1.5 EUT OPERATING CONDITIONS**

The EUT was configured for testing in a typical fashion (as a customer would normally use it). The EUT has been programmed to continuously transmit during test. This operating condition was tested and used to collect the included data.

### 3.1.6 TEST RESULTS

EUT :	Bluetooth Speaker	Model Name :	iChocolate PRO
Temperature :	26 °C	Relative Humidity :	54%
Pressure :	1010hPa	Phase :	L
Test Voltage :	DC 5.0V form PC AC 120V/60Hz	Test Mode :	Mode 5

Frequency (MHz)	Reading Level (dBμV)	Correct Factor (dB)	Measure-ment (dBμV)	Limits (dBμV)	Margin (dB)	Remark
0.5658	31.88	9.78	41.66	56.00	-14.34	QP
0.5658	22.58	9.78	32.36	46.00	-13.64	AVG
1.0380	31.17	9.73	40.90	56.00	-15.10	QP
1.0380	21.86	9.73	31.59	46.00	-14.41	AVG
1.9899	34.39	9.65	44.04	56.00	-11.96	QP
1.9899	21.09	9.65	30.74	46.00	-15.26	AVG
2.7860	33.51	9.67	43.18	56.00	-12.82	QP
2.7860	24.35	9.67	34.02	46.00	-11.98	AVG
3.5779	34.01	9.69	43.70	56.00	-12.30	QP
3.5779	24.00	9.69	33.69	46.00	-12.31	AVG
4.3738	31.61	9.70	41.31	56.00	-14.69	QP
4.3738	20.97	9.70	30.67	46.00	-15.33	AVG

Remark:

1. All readings are Quasi-Peak and Average values.
2. Factor = Insertion Loss + Cable Loss.

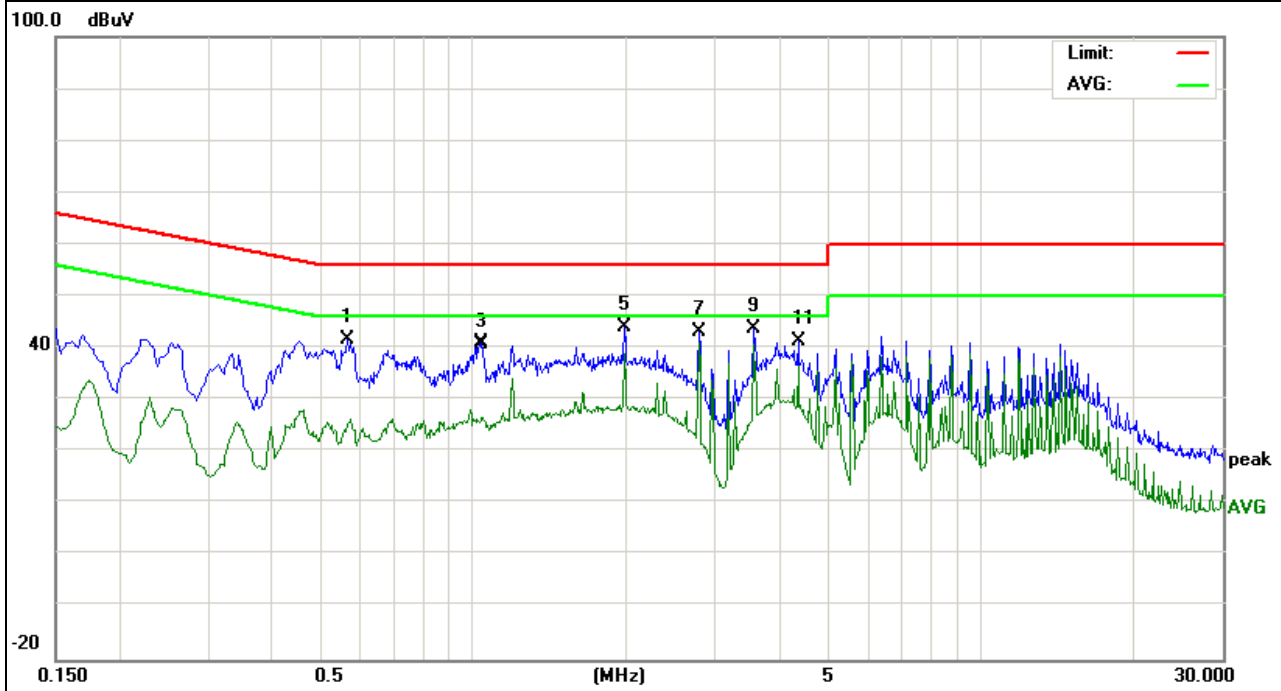

EUT :	Bluetooth Speaker	Model Name :	iChocolate PRO
Temperature :	26 °C	Relative Humidity :	54%
Pressure :	1010hPa	Phase :	N
Test Voltage :	DC 5.0V form PC AC 120V/60Hz	Test Mode :	Mode 5

Frequency (MHz)	Reading Level (dBμV)	Correct Factor (dB)	Measure-ment (dBμV)	Limits (dBμV)	Margin (dB)	Remark
0.4500	33.68	9.66	43.34	56.87	-13.53	QP
0.4500	22.59	9.66	32.25	46.87	-14.62	AVG
0.5658	33.05	9.67	42.72	56.00	-13.28	QP
0.5658	21.79	9.67	31.46	46.00	-14.54	AVG
1.9899	31.52	9.54	41.06	56.00	-14.94	QP
1.9899	21.04	9.54	30.58	46.00	-15.42	AVG
3.9780	32.14	9.51	41.65	56.00	-14.35	QP
3.9780	16.74	9.51	26.25	46.00	-19.75	AVG
6.3658	32.16	9.51	41.67	60.00	-18.33	QP
6.3658	20.96	9.51	30.47	50.00	-19.53	AVG
14.3217	31.25	9.75	41.00	60.00	-19.00	QP
14.3217	21.61	9.75	31.36	50.00	-18.64	AVG

Remark:

1. All readings are Quasi-Peak and Average values.
2. Factor = Insertion Loss + Cable Loss.

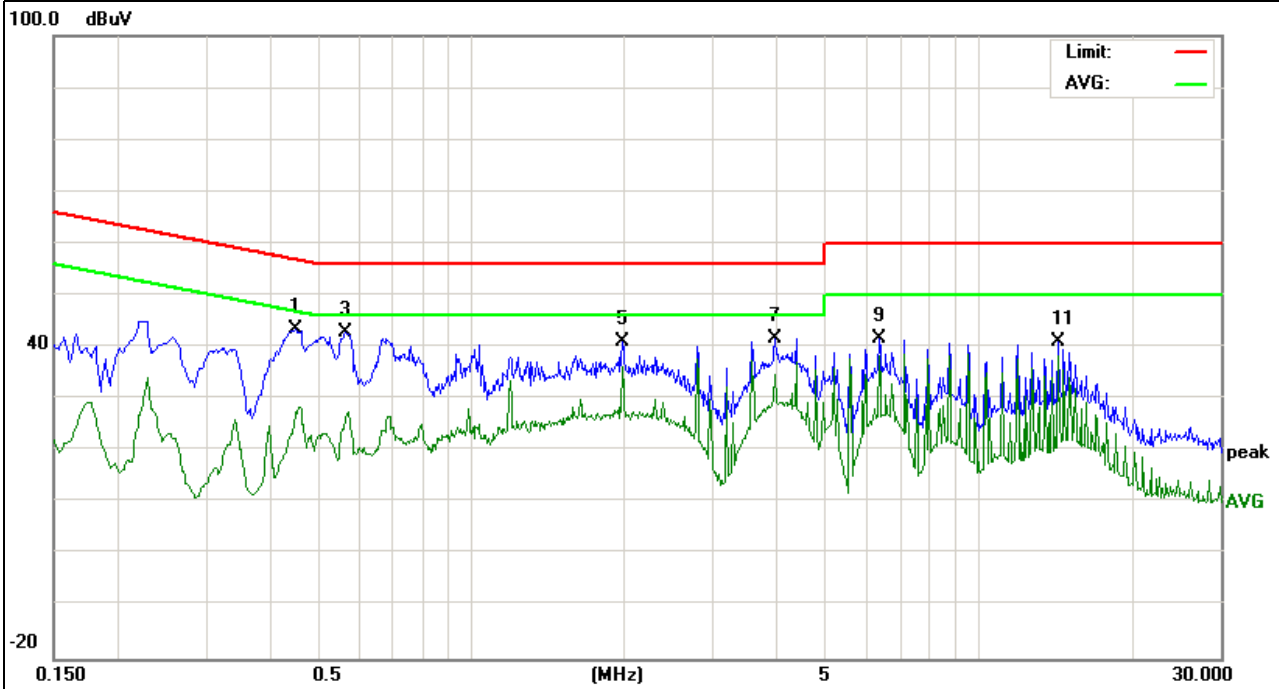



EUT :	Bluetooth Speaker	Model Name :	iChocolate PRO
Temperature :	26 °C	Relative Humidity :	54%
Pressure :	1010hPa	Phase :	L
Test Voltage :	DC 5.0V form PC AC 230V/50Hz	Test Mode :	Mode 5

Frequency (MHz)	Reading Level (dBμV)	Correct Factor (dB)	Measure-ment (dBμV)	Limits (dBμV)	Margin (dB)	Remark
0.5220	37.07	9.77	46.84	56.00	-9.16	QP
0.5220	26.55	9.77	36.32	46.00	-9.68	AVG
0.7099	35.50	9.78	45.28	56.00	-10.72	QP
0.7099	23.47	9.78	33.25	46.00	-12.75	AVG
1.0060	33.31	9.73	43.04	56.00	-12.96	QP
1.0060	23.96	9.73	33.69	46.00	-12.31	AVG
2.7900	32.16	9.67	41.83	56.00	-14.17	QP
2.7900	21.78	9.67	31.45	46.00	-14.55	AVG
4.3818	32.16	9.70	41.86	56.00	-14.14	QP
4.3818	22.88	9.70	32.58	46.00	-13.42	AVG
6.3738	32.08	9.70	41.78	60.00	-18.22	QP
6.3738	20.55	9.70	30.25	50.00	-19.75	AVG

Remark:

1. All readings are Quasi-Peak and Average values.
2. Factor = Insertion Loss + Cable Loss.

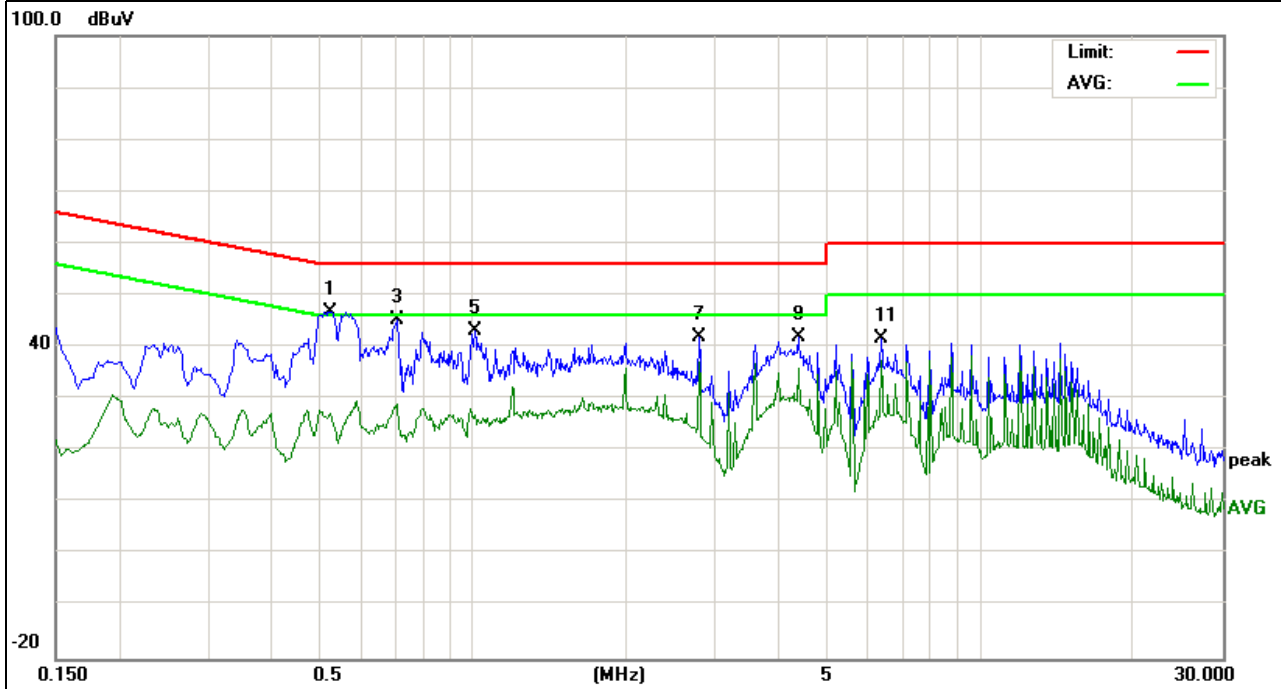

EUT :	Bluetooth Speaker	Model Name :	iChocolate PRO
Temperature :	26 °C	Relative Humidity :	54%
Pressure :	1010hPa	Phase :	N
Test Voltage :	DC 5.0V form PC AC 240V/60Hz	Test Mode :	Mode 5

Frequency (MHz)	Reading Level (dBμV)	Correct Factor (dB)	Measure-ment (dBμV)	Limits (dBμV)	Margin (dB)	Remark
0.5260	39.40	9.68	49.08	56.00	-6.92	QP
0.5260	23.94	9.68	33.62	46.00	-12.38	AVG
0.5540	39.23	9.67	48.90	56.00	-7.10	QP
0.5540	22.91	9.67	32.58	46.00	-13.42	AVG
0.7099	37.08	9.64	46.72	56.00	-9.28	QP
0.7099	21.92	9.64	31.56	46.00	-14.44	AVG
1.9899	32.77	9.54	42.31	56.00	-13.69	QP
1.9899	24.48	9.54	34.02	46.00	-11.98	AVG
3.9820	33.07	9.51	42.58	56.00	-13.42	QP
3.9820	20.61	9.51	30.12	46.00	-15.88	AVG
6.3699	32.45	9.51	41.96	60.00	-18.04	QP
6.3699	20.37	9.51	29.88	50.00	-20.12	AVG

Remark:

1. All readings are Quasi-Peak and Average values.
2. Factor = Insertion Loss + Cable Loss.

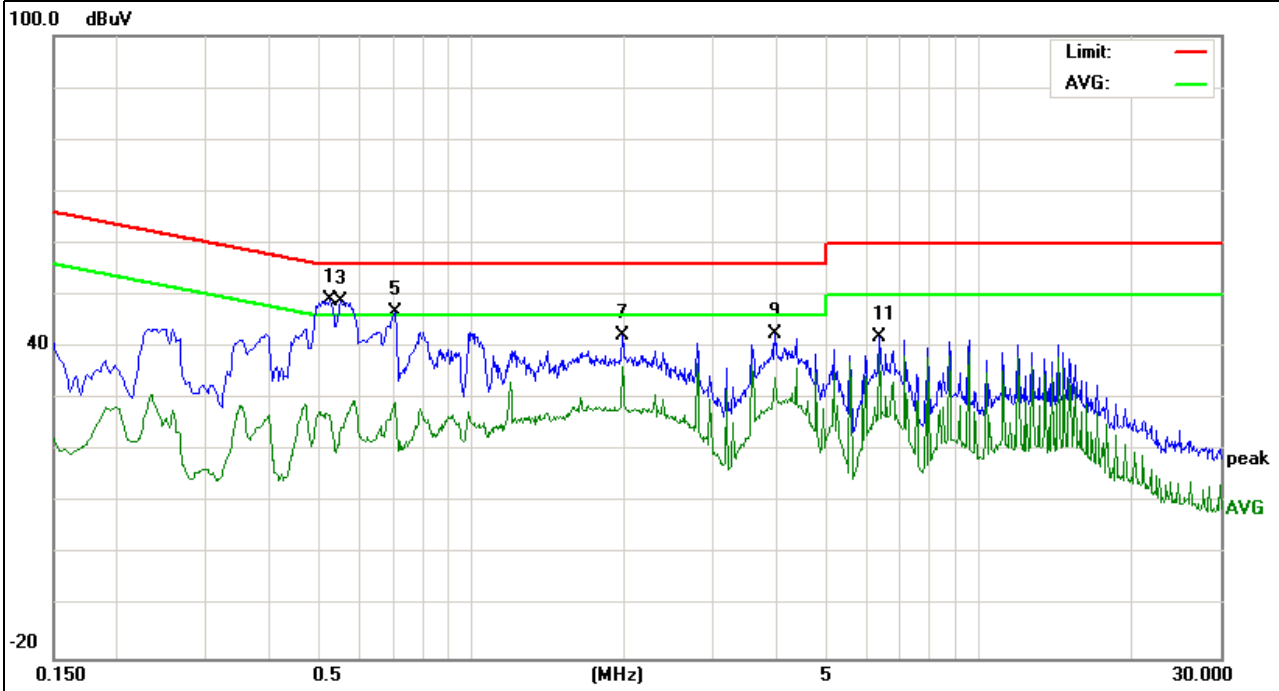

### 3.2 RADIATED EMISSION MEASUREMENT

#### 3.2.1 RADIATED EMISSION LIMITS (Frequency Range 9kHz-1000MHz)

20dBc in any 100 kHz bandwidth outside the operating frequency band. In case the emission fall within the restricted band specified on 15.205(a), then the 15.209(a) limit in the table below has to be followed.

Frequencies (MHz)	Field Strength (micorvolts/meter)	Measurement Distance (meters)
0.009~0.490	2400/F(KHz)	300
0.490~1.705	24000/F(KHz)	30
1.705~30.0	30	30
30~88	100	3
88~216	150	3
216~960	200	3
Above 960	500	3

#### LIMITS OF RADIATED EMISSION MEASUREMENT (Above 1000MHz)

FREQUENCY (MHz)	dBuV/m@at 3M	
	PEAK	AVERAGE
Above 1000	74	54

Notes:

- (1) The limit for radiated test was performed according to FCC PART 15C.
- (2) The tighter limit applies at the band edges.
- (3) Emission level (dBuV/m)=20log Emission level (uV/m).

Spectrum Parameter	Setting
Attenuation	Auto
Start Frequency	1000 MHz
Stop Frequency	10th carrier harmonic
RB / VB (emission in restricted band)	1 MHz / 1 MHz for Peak, 1 MHz / 10Hz for Average

Receiver Parameter	Setting
Attenuation	Auto
Start ~ Stop Frequency	9kHz~150kHz / RB 200Hz for QP
Start ~ Stop Frequency	150kHz~30MHz / RB 9kHz for QP
Start ~ Stop Frequency	30MHz~1000MHz / RB 120kHz for QP

**3.2.2 TEST PROCEDURE**

- a. The measuring distance of at 3 m shall be used for measurements at frequency up to 1GHz. For frequencies above 1GHz, any suitable measuring distance may be used.
- b. The EUT was placed on the top of a rotating table 0.8 m for below 1GHz and 1.5m for above 1GHz the ground at a 3 meter open area test site. The table was rotated 360 degrees to determine the position of the highest radiation.
- c. The height of the equipment or of the substitution antenna shall be 0.8 m for below 1GHz and 1.5m for above 1GHz; the height of the test antenna shall vary between 1 m to 4 m. Both horizontal and vertical polarizations of the antenna are set to make the measurement.
- d. The initial step in collecting conducted emission data is a spectrum analyzer peak detector mode pre-scanning the measurement frequency range. Significant peaks are then marked and then Quasi Peak detector mode re-measured.
- e. If the Peak Mode measured value compliance with and lower than Quasi Peak Mode Limit, the EUT shall be deemed to meet QP Limits and then no additional QP Mode measurement performed.
- f. For the actual test configuration, please refer to the related Item –EUT Test Photos.

Note:

Both horizontal and vertical antenna polarities were tested and performed pretest to three orthogonal axis. The worst case emissions were reported

During the radiated emission test, the Spectrum Analyzer was set with the following configurations:

Frequency Band (MHz)	Function	Resolution bandwidth	Video Bandwidth
30 to 1000	Peak	100 kHz	100 kHz
Above 1000	Peak	1 MHz	1 MHz
	Average	1 MHz	10 Hz

**3.2.3 DEVIATION FROM TEST STANDARD**

No deviation

### 3.2.4 TEST SETUP

#### (A) Radiated Emission Test-Up Frequency Below 30MHz

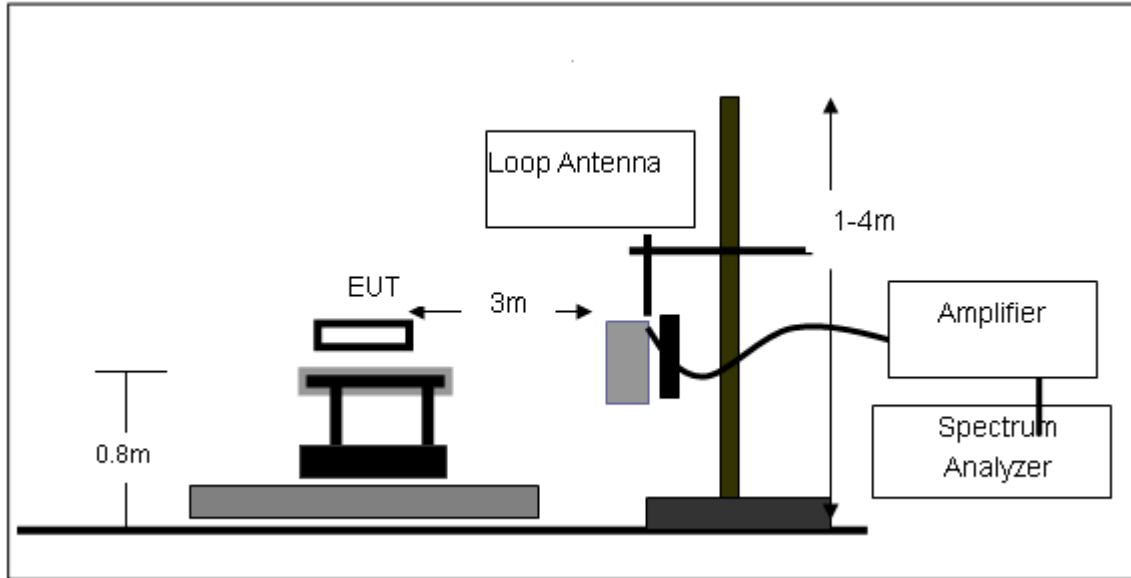

#### (B) Radiated Emission Test-Up Frequency 30MHz~1GHz

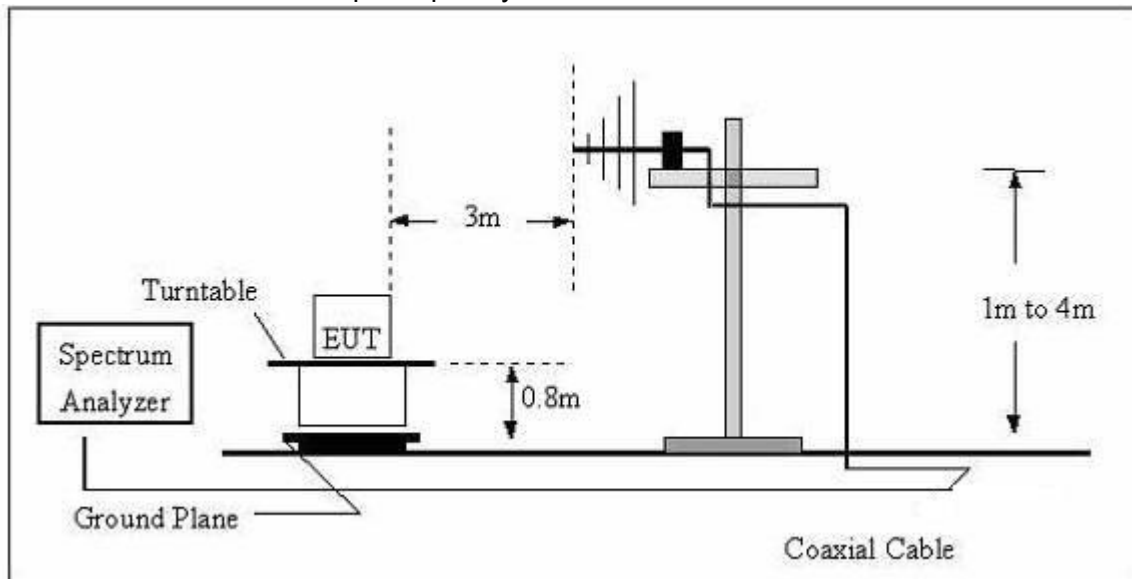

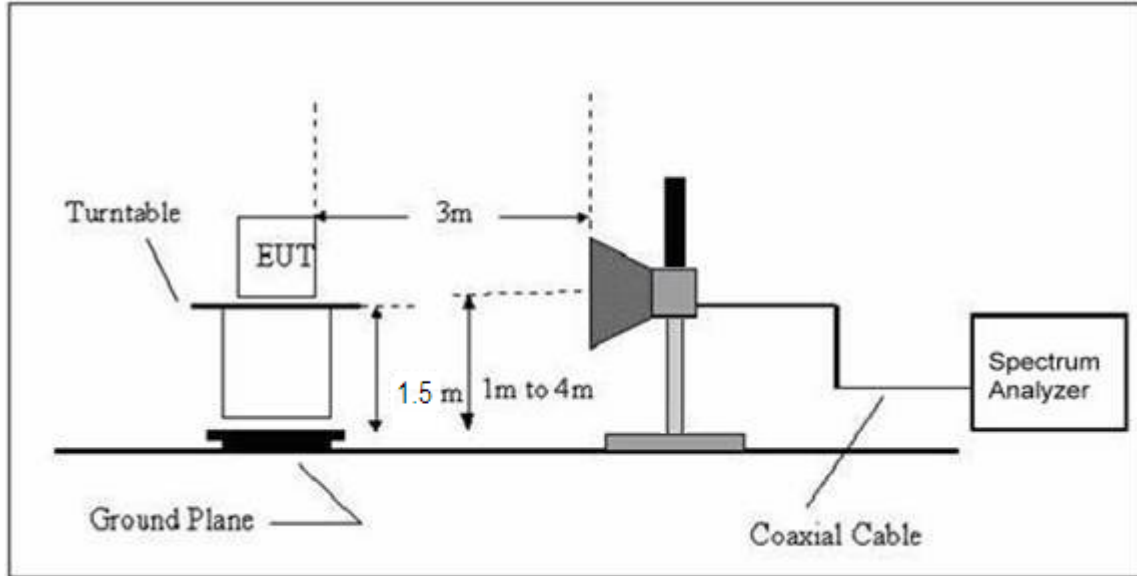
**(C) Radiated Emission Test-Up Frequency Above 1GHz****3.2.5 EUT OPERATING CONDITIONS**

The EUT tested system was configured as the statements of 2.4 Unless otherwise a special operating condition is specified in the follows during the testing.

**3.2.6 TEST RESULTS (BETWEEN 9KHZ – 30 MHZ)**

EUT:	Bluetooth Speaker	Model Name. :	iChocolate PRO
Temperature:	20 °C	Relative Humidity:	48%
Pressure:	1010 hPa	Test Voltage :	DC 3.7V
Test Mode :	TX	Polarization :	--

Freq. (MHz)	Reading (dBuV/m)	Limit (dBuV/m)	Margin (dB)	State P/F
--	--	--	--	N/A
--	--	--	--	N/A

**NOTE:**

The amplitude of spurious emissions which are attenuated by more than 20dB below the permissible value has no need to be reported.

Distance extrapolation factor =  $40 \log (\text{specific distance}/\text{test distance})(\text{dB})$ ;

Limit line = specific limits(dBuv) + distance extrapolation factor.

### 3.2.7 TEST RESULTS (BETWEEN 30MHZ – 1GHZ)

EUT :	Bluetooth Speaker	Model Name :	iChocolate PRO
Temperature :	20 °C	Relative Humidity :	48%
Pressure :	1010 hPa	Test Voltage :	DC 3.7V
Test Mode :	TX		

Polar (H/V)	Frequency	Meter Reading	Factor	Emission Level	Limits	Margin	Remark
	(MHz)	(dBuV)	(dB)	(dBuV/m)	(dBuV/m)	(dB)	
V	125.0066	13.03	10.66	23.69	43.50	-19.81	QP
V	147.9214	10.12	11.53	21.65	43.50	-21.85	QP
V	195.1365	15.11	11.43	26.54	43.50	-16.96	QP
V	210.786	17.59	11.02	28.61	43.50	-14.89	QP
V	239.9874	20.34	10.73	31.07	46.00	-14.93	QP
V	601.4265	21.45	19.49	40.94	46.00	-5.06	QP

**Remark:**

Absolute Level= ReadingLevel+ Factor, Margin= Absolute Level - Limit

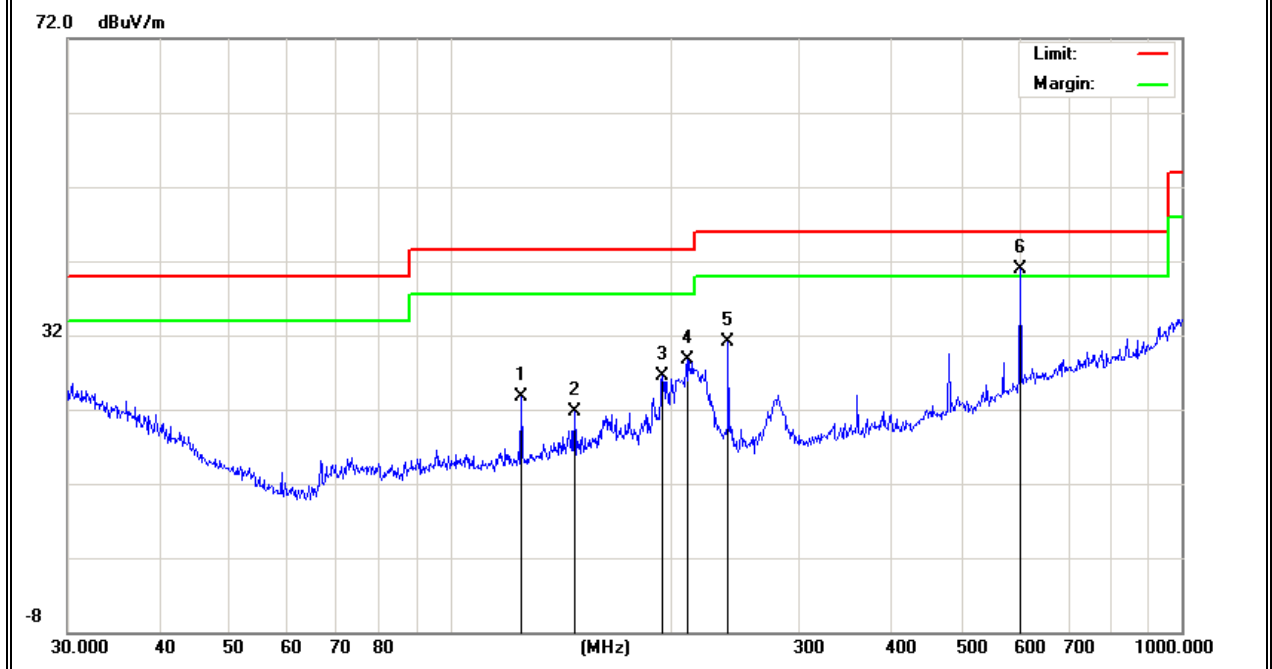



Polar (H/V)	Frequency	Meter Reading	Factor	Emission Level	Limits	Margin	Remark
	(MHz)	(dBuV)	(dB)	(dBuV/m)	(dBuV/m)	(dB)	
H	160.9089	25.33	11.49	36.82	43.50	-6.68	QP
H	178.1326	17.92	12.06	29.98	43.50	-13.52	QP
H	239.9874	15.81	10.73	26.54	46.00	-19.46	QP
H	360.4476	15.33	14.35	29.68	46.00	-16.32	QP
H	480.5276	14.93	16.56	31.49	46.00	-14.51	QP
H	601.4265	15.66	19.49	35.15	46.00	-10.85	QP

**Remark:**

Absolute Level= ReadingLevel+ Factor, Margin= Absolute Level - Limit

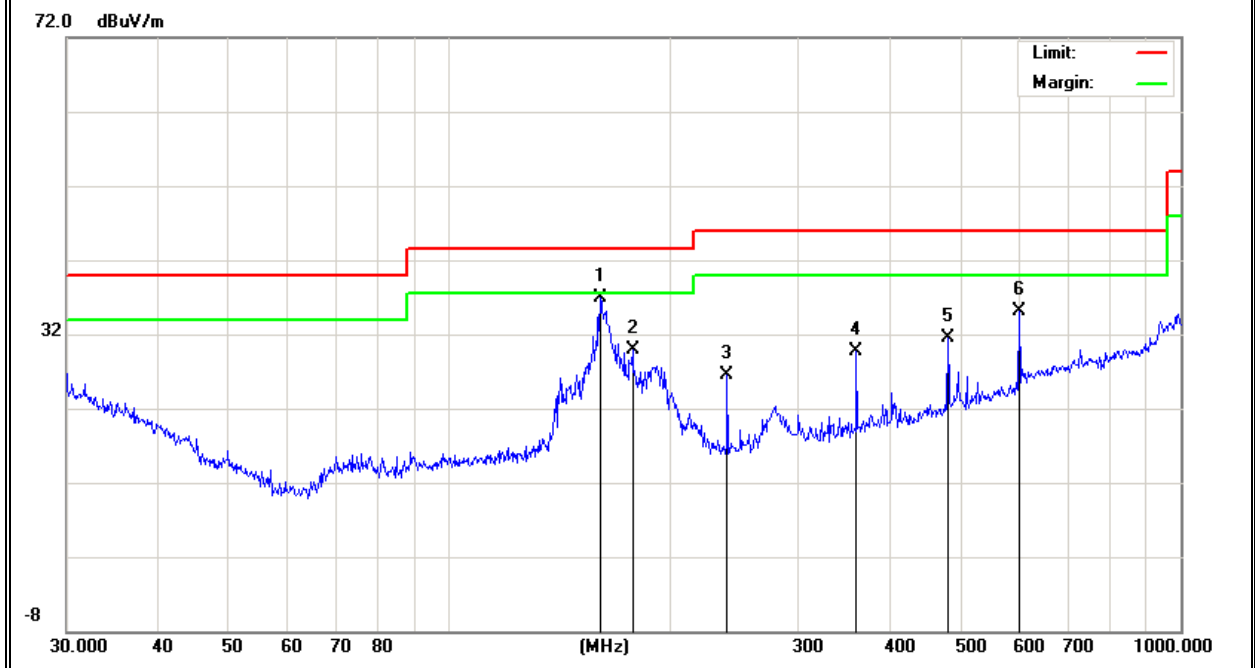

### 3.2.8 TEST RESULTS (ABOVE 1000 MHZ)

EUT :	Bluetooth Speaker	Model Name :	iChocolate PRO
Temperature :	20 °C	Relative Humidity :	48%
Pressure :	1010 hPa	Test Voltage :	DC 3.7V
Test Mode :	TX		

Polar (H/V)	Frequency	Meter Reading	Factor	Emission Level	Limits	Margin	Detector Type
	(MHz)	(dBuV)	(dB)	(dBuV/m)	(dBuV/m)	(dB)	
<b>Low Channel (2412 MHz)-Above 1G</b>							
Vertical	4824.025	51.6	10.44	62.04	74.00	-11.96	Pk
Vertical	4824.025	33.16	10.44	43.60	54.00	-10.40	Av
Vertical	7236.118	44.81	12.39	57.20	74.00	-16.80	Pk
Vertical	7236.118	29.09	12.39	41.48	54.00	-12.52	Av
Horizontal	4824.044	53.35	10.44	63.79	74.00	-10.21	Pk
Horizontal	4824.044	32.07	10.44	42.51	54.00	-11.49	Av
Horizontal	7236.336	45.51	12.39	57.90	74.00	-16.10	Pk
Horizontal	7236.336	30.65	12.39	43.04	54.00	-10.96	Av
<b>Mid Channel (2437 MHz)-Above 1G</b>							
Vertical	4874.336	51.01	10.40	61.41	74.00	-12.59	Pk
Vertical	4874.336	31.93	10.40	42.33	54.00	-11.67	Av
Vertical	7311.205	44.67	12.75	57.42	74.00	-16.58	Pk
Vertical	7311.205	27.66	12.75	40.41	54.00	-13.59	Av
Horizontal	4874.256	51.78	10.40	62.18	74.00	-11.82	Pk
Horizontal	7874.256	33.01	10.40	43.41	54.00	-10.59	Av
Horizontal	7311.025	47.89	12.75	60.64	74.00	-13.36	Pk
Horizontal	7311.025	28.58	12.75	41.33	54.00	-12.67	Av
<b>High Channel (2462 MHz)- Above 1G</b>							
Vertical	4924.156	50.95	10.39	61.34	74.00	-12.66	Pk
Vertical	4924.156	32.58	10.39	42.97	54.00	-11.03	Av
Vertical	7386.225	44.35	12.68	57.03	74.00	-16.97	Pk
Vertical	7386.225	27.99	12.68	40.67	54.00	-13.33	Av
Horizontal	4924.336	50.98	10.39	61.37	74.00	-12.63	Pk
Horizontal	4924.336	33.08	10.39	43.47	54.00	-10.53	Av
Horizontal	7386.025	47.37	12.68	60.05	74.00	-13.95	Pk
Horizontal	7386.025	28.67	12.68	41.35	54.00	-12.65	Av

Note: "802.11b" mode is the worst mode.

#### 4. POWER SPECTRAL DENSITY TEST

##### 4.1 APPLIED PROCEDURES / LIMIT

FCC Part15 (15.247) , Subpart C				
Section	Test Item	Limit	Frequency Range (MHz)	Result
15.247	Power Spectral Density	8 dBm (in any 3KHz)	2400-2483.5	PASS

##### 4.1.1 TEST PROCEDURE

1. Set analyzer center frequency to DTS channel center frequency.
2. Set the span to 1.5 times the DTS channel bandwidth.
3. 3 kHz ≤ Set the RBW ≤ 100 kHz.
4. Set the VBW ≥ 3 x RBW.
5. Detector = peak.
6. Sweep time = auto couple.
7. Trace mode = max hold.
8. Allow trace to fully stabilize.
9. Use the peak marker function to determine the maximum amplitude level within the RBW.
10. If measured value exceeds limit, reduce RBW (no less than 3 kHz) and repeat.

##### 4.1.2 DEVIATION FROM STANDARD

No deviation.

##### 4.1.3 TEST SETUP



##### 4.1.4 EUT OPERATION CONDITIONS

The EUT tested system was configured as the statements of 2.1 Unless otherwise a special operating condition is specified in the follows during the testing.

### 4.1.5 TEST RESULTS

EUT :	Bluetooth Speaker	Model Name :	iChocolate PRO
Temperature :	25 °C	Relative Humidity :	56%
Pressure :	1015 hPa	Test Voltage :	DC 3.7V
Test Mode :	TX b Mode /CH01, CH06, CH11		

Frequency	Power Density (dBm)	Limit (dBm)	Result
2412 MHz	-10.87	8	PASS
2437 MHz	-11.38	8	PASS
2462 MHz	-12.00	8	PASS

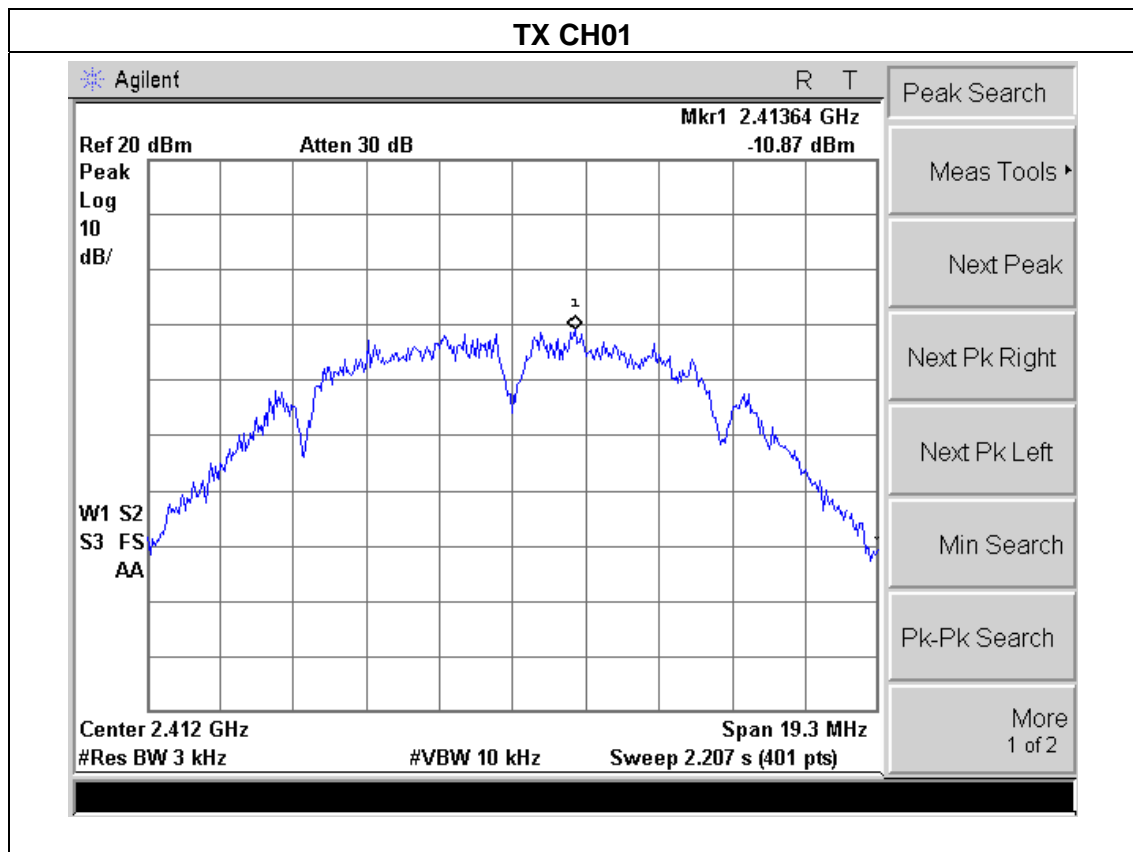

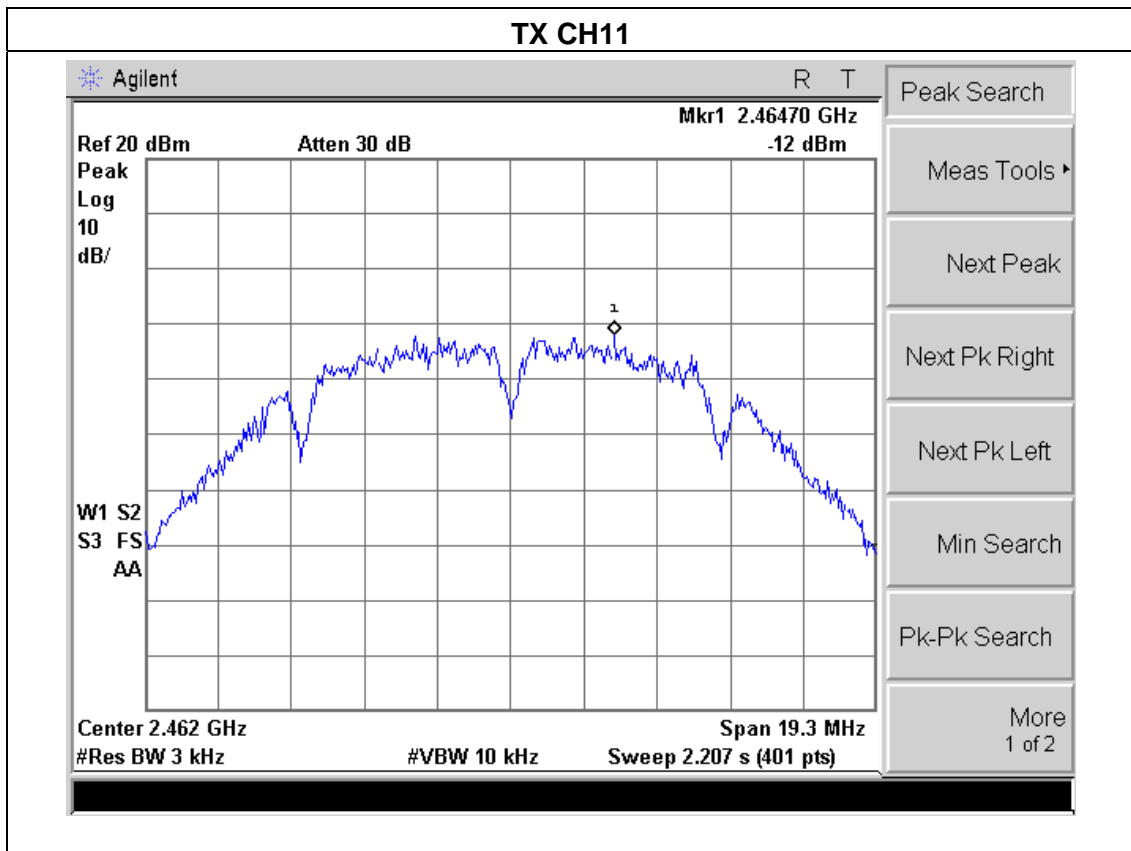
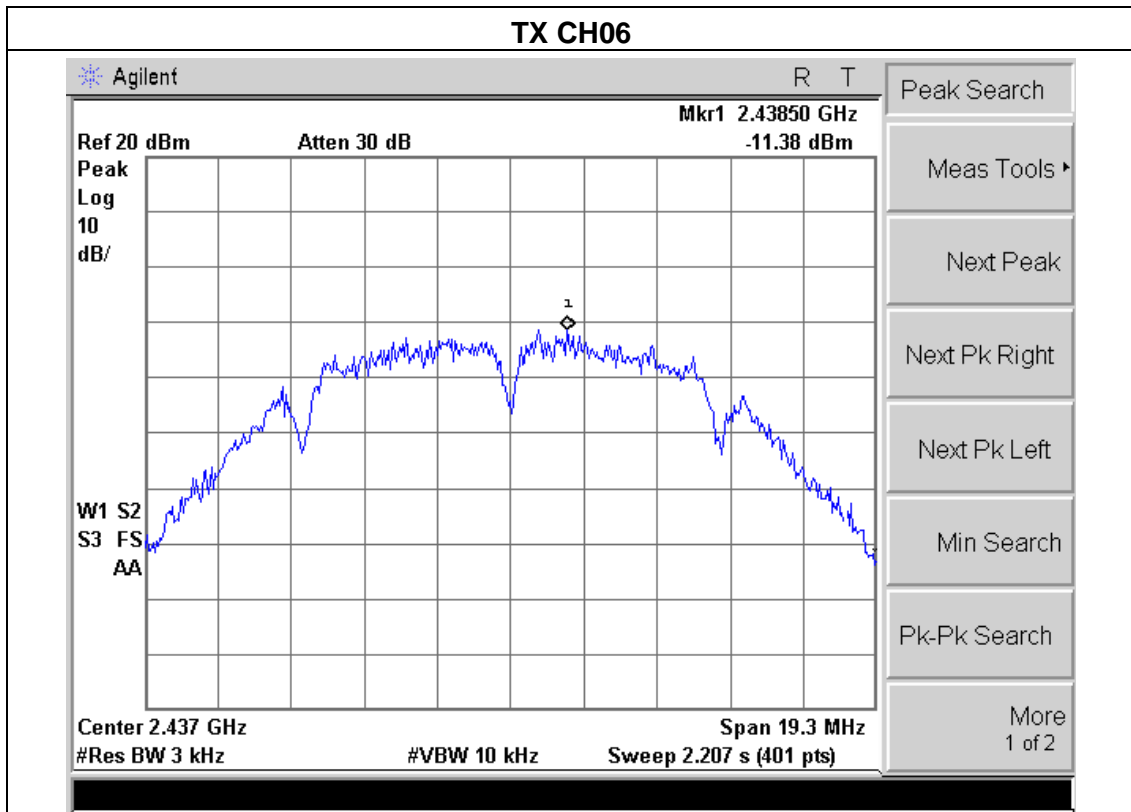

EUT :	Bluetooth Speaker	Model Name :	iChocolate PRO
Temperature :	25 °C	Relative Humidity :	56%
Pressure :	1015 hPa	Test Voltage :	DC 3.7V
Test Mode :	TX g Mode /CH01, CH06, CH11		

Frequency	Power Density (dBm)	Limit (dBm)	Result
2412 MHz	-16.54	8	PASS
2437 MHz	-15.06	8	PASS
2462 MHz	-16.24	8	PASS

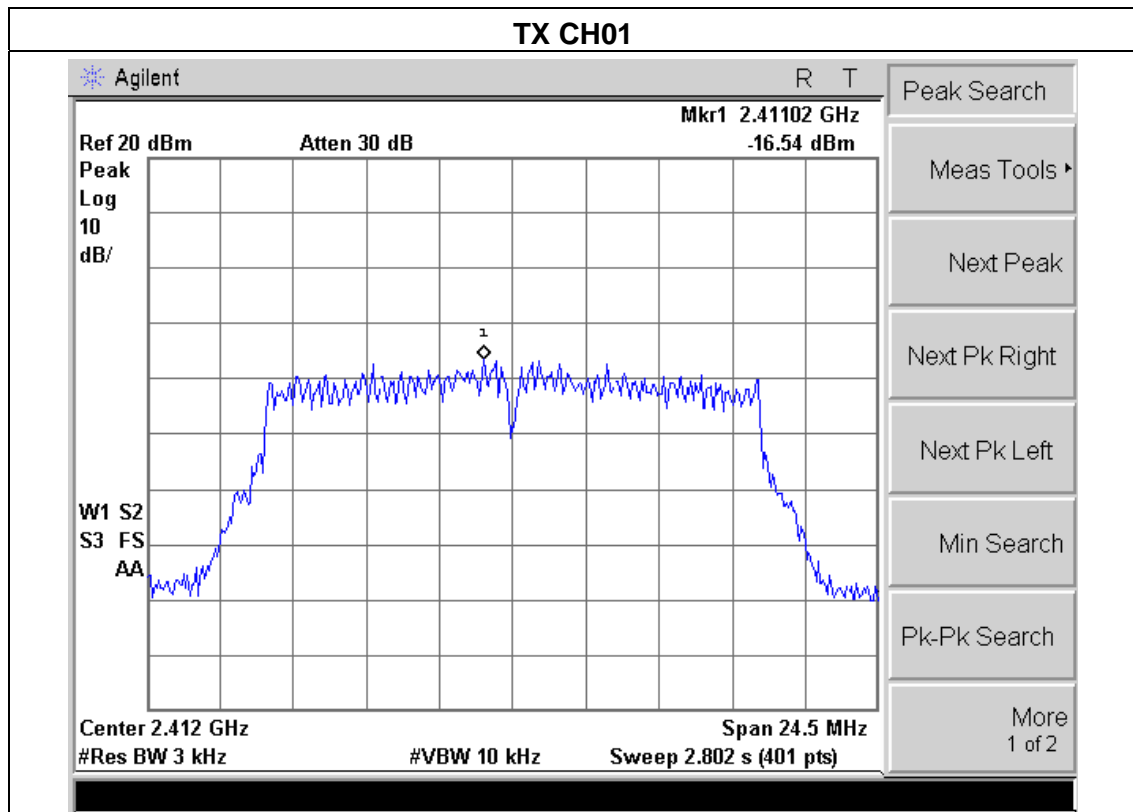

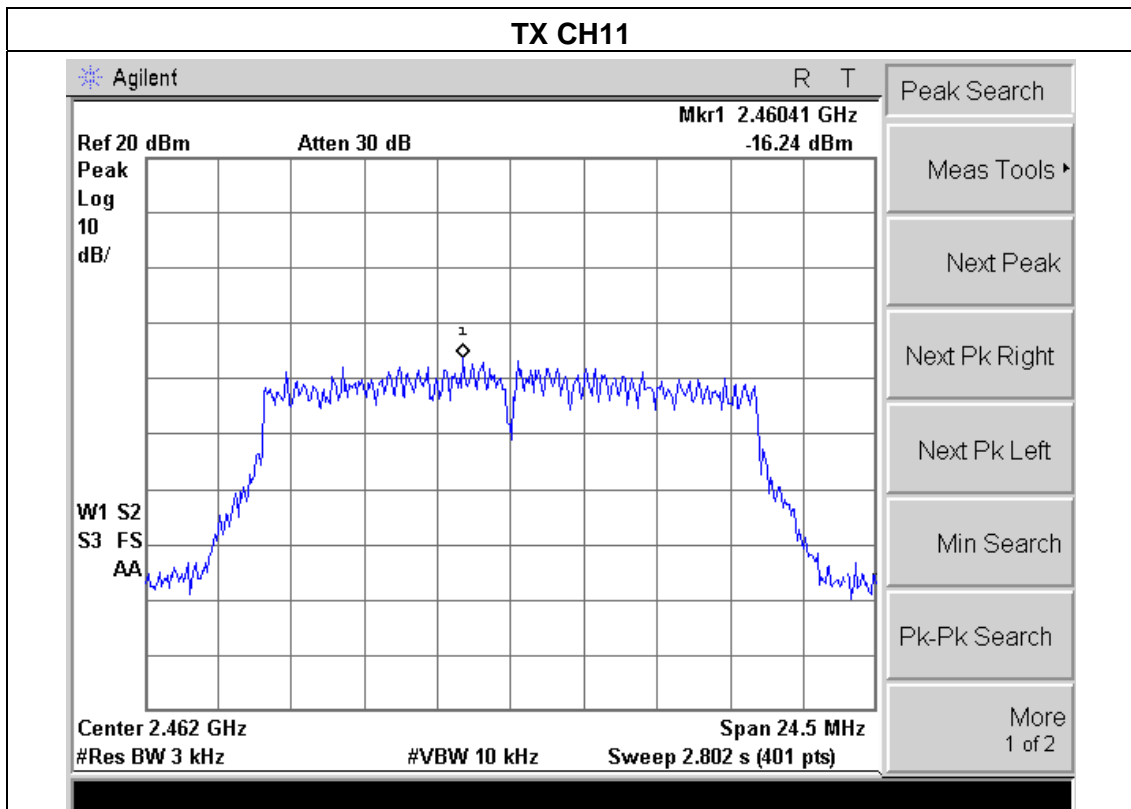
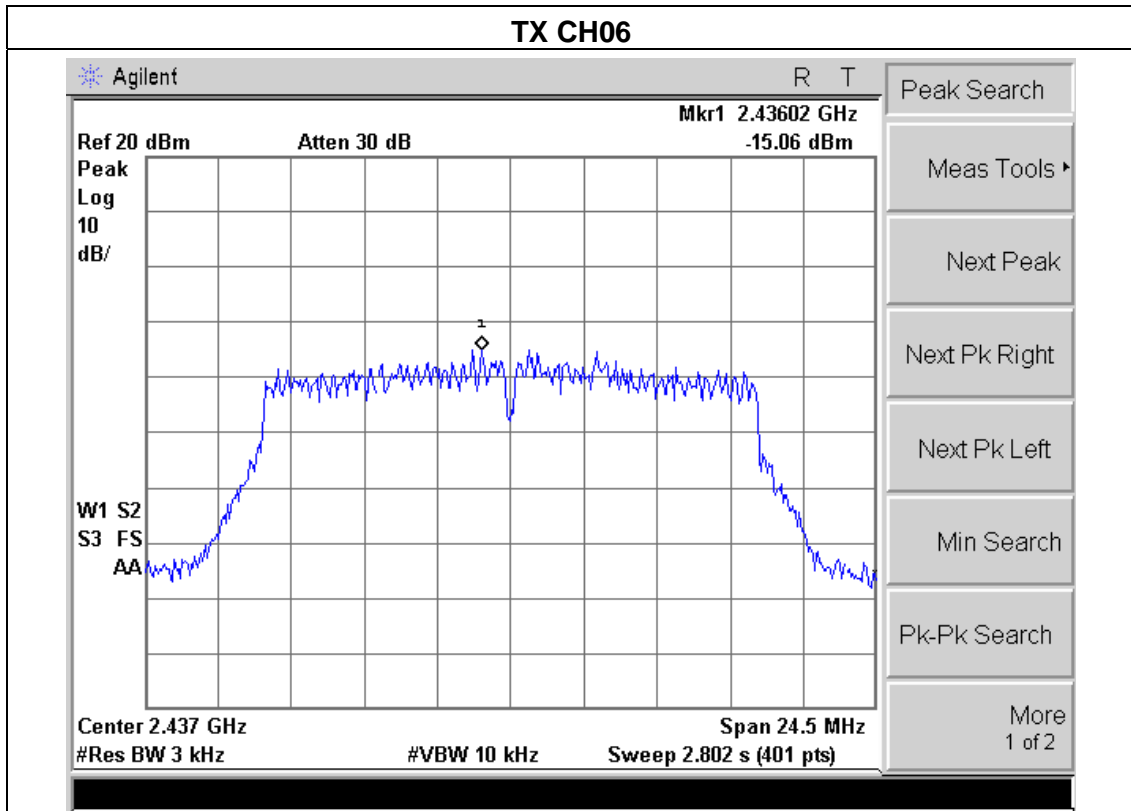

EUT :	Bluetooth Speaker	Model Name :	iChocolate PRO
Temperature :	25 °C	Relative Humidity :	56%
Pressure :	1015 hPa	Test Voltage :	DC 3.7V
Test Mode :	TX n Mode (20MHz)/CH01, CH06, CH11		

Frequency	Power Density (dBm)	Limit (dBm)	Result
2412 MHz	-16.63	8	PASS
2437 MHz	-16.19	8	PASS
2462 MHz	-17.25	8	PASS

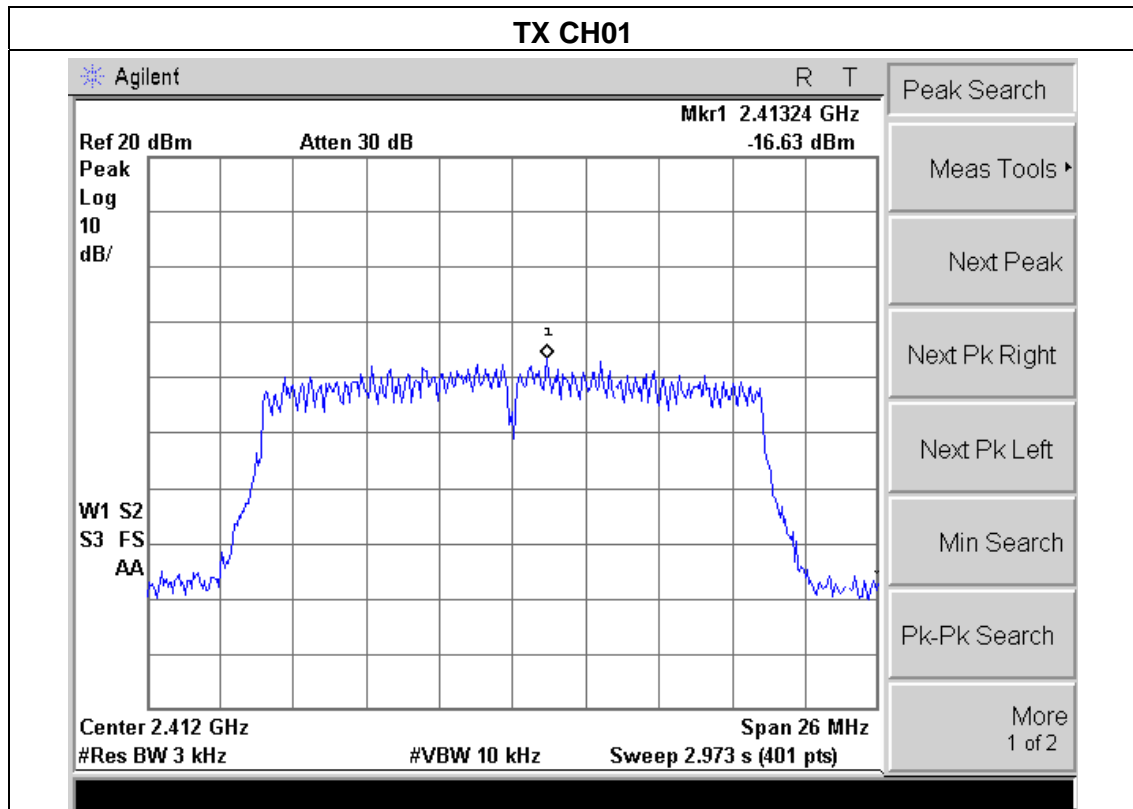



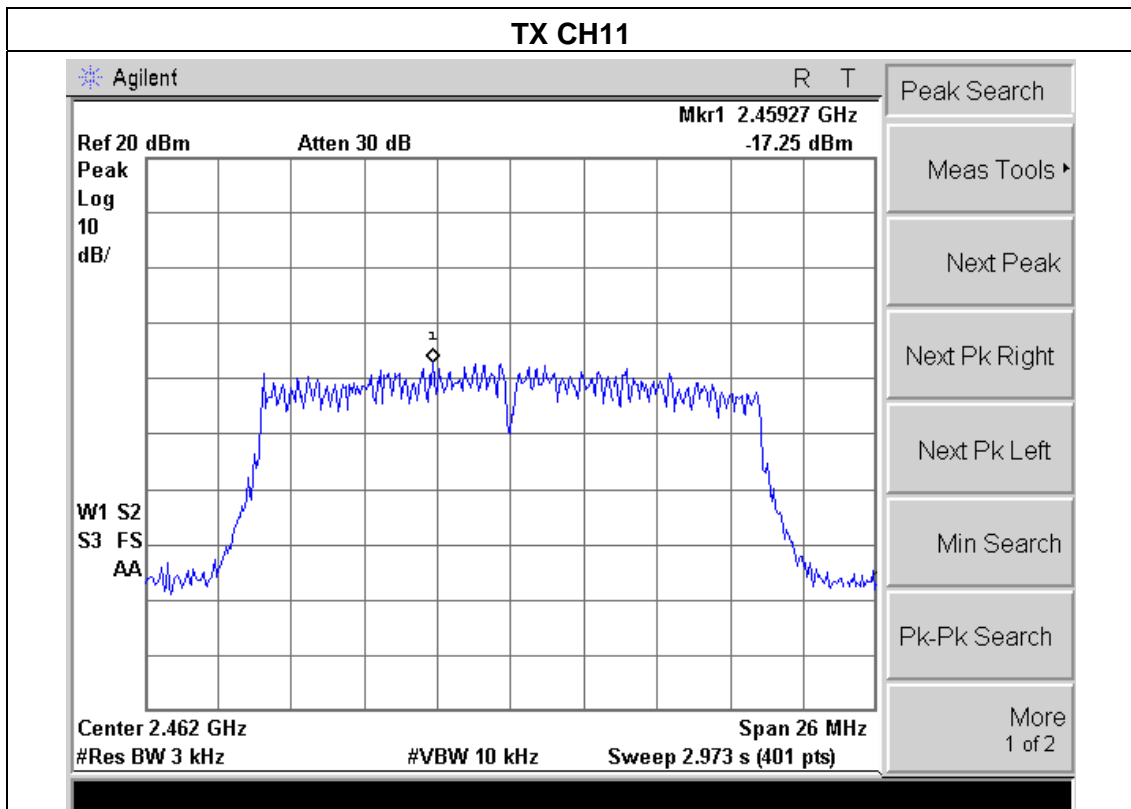
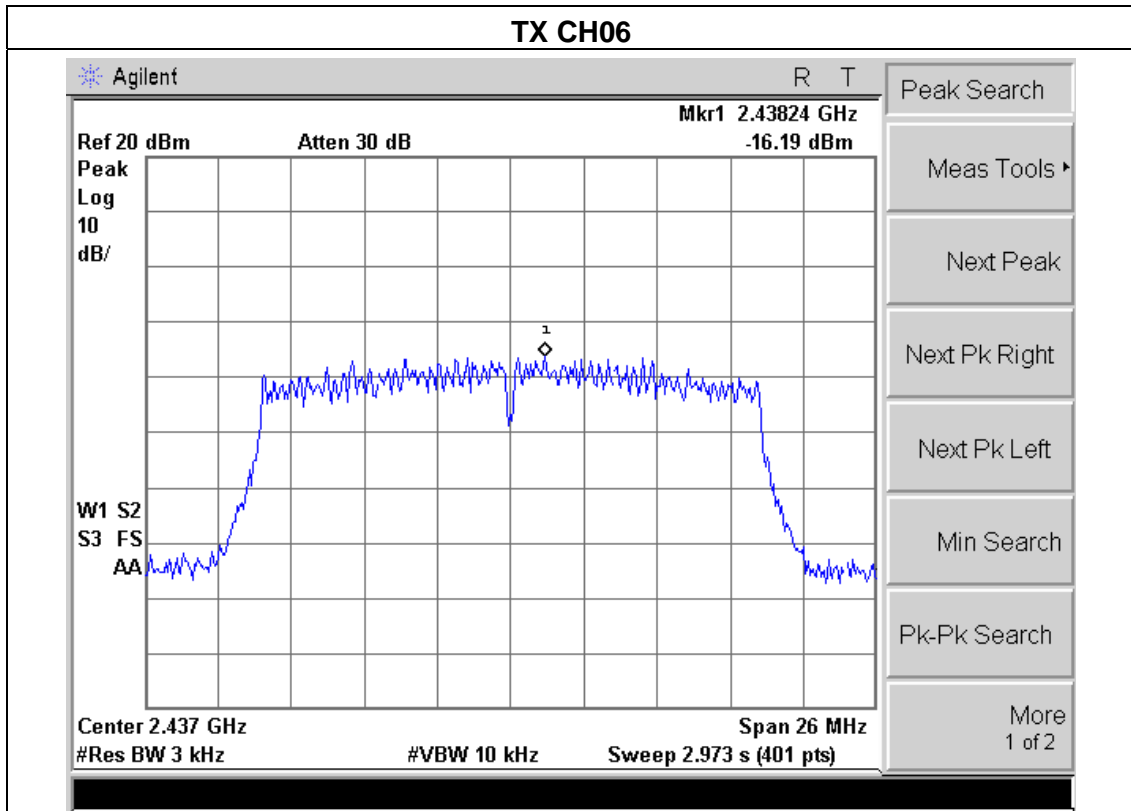

EUT :	Bluetooth Speaker	Model Name :	iChocolate PRO
Temperature :	25 °C	Relative Humidity :	56%
Pressure :	1015 hPa	Test Voltage :	DC 3.7V
Test Mode :	TX n Mode (40MHz)/CH03, CH06, CH09		

Frequency	Power Density (dBm)	Limit (dBm)	Result
2422 MHz	-20.90	8	PASS
2437 MHz	-19.67	8	PASS
2452 MHz	-20.93	8	PASS

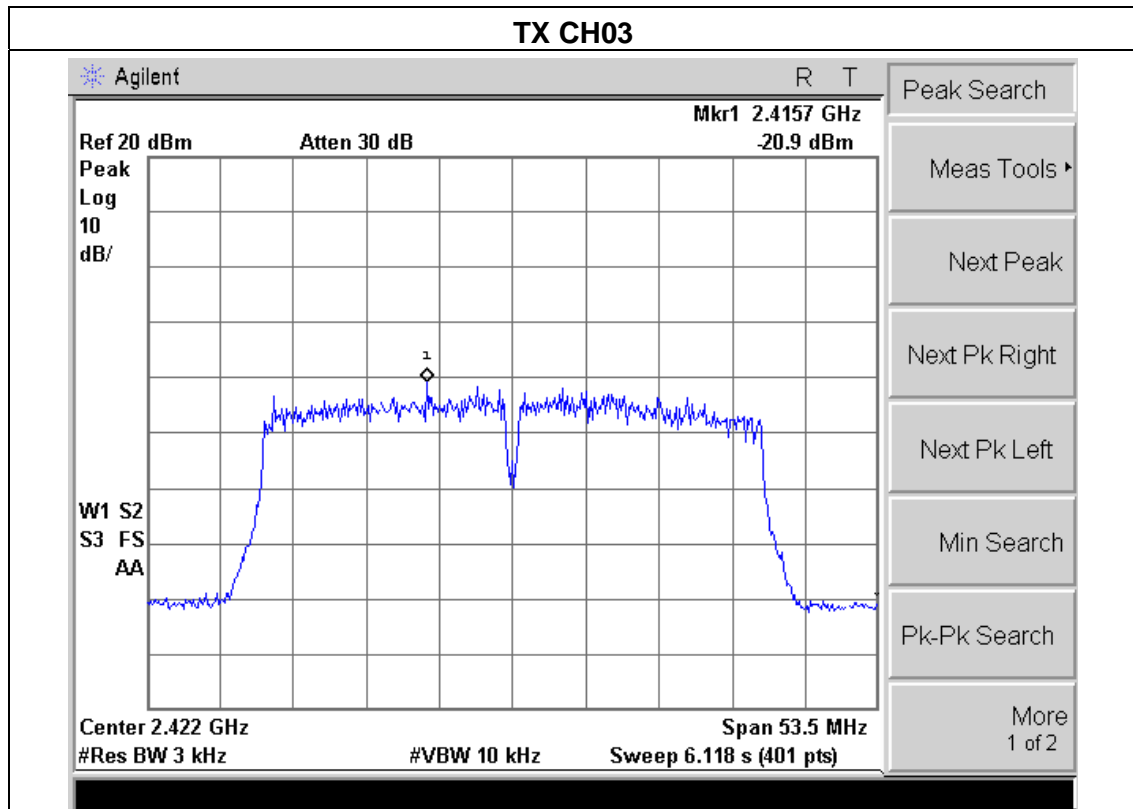

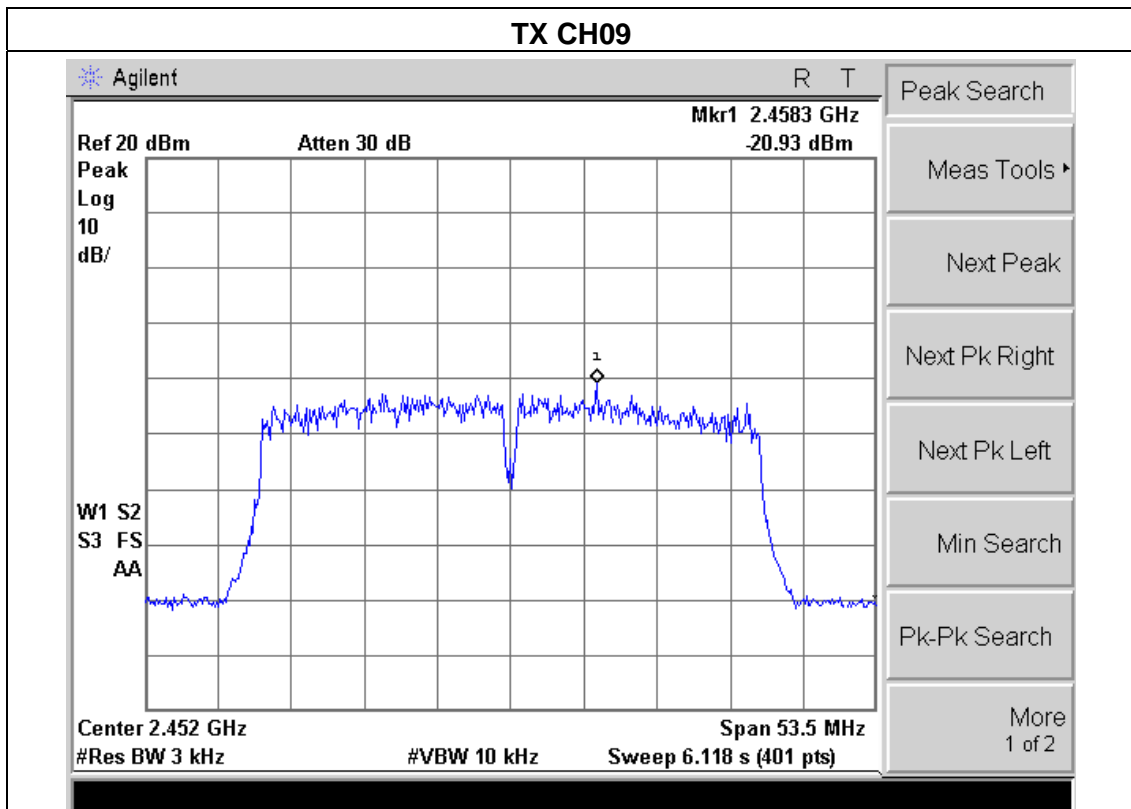
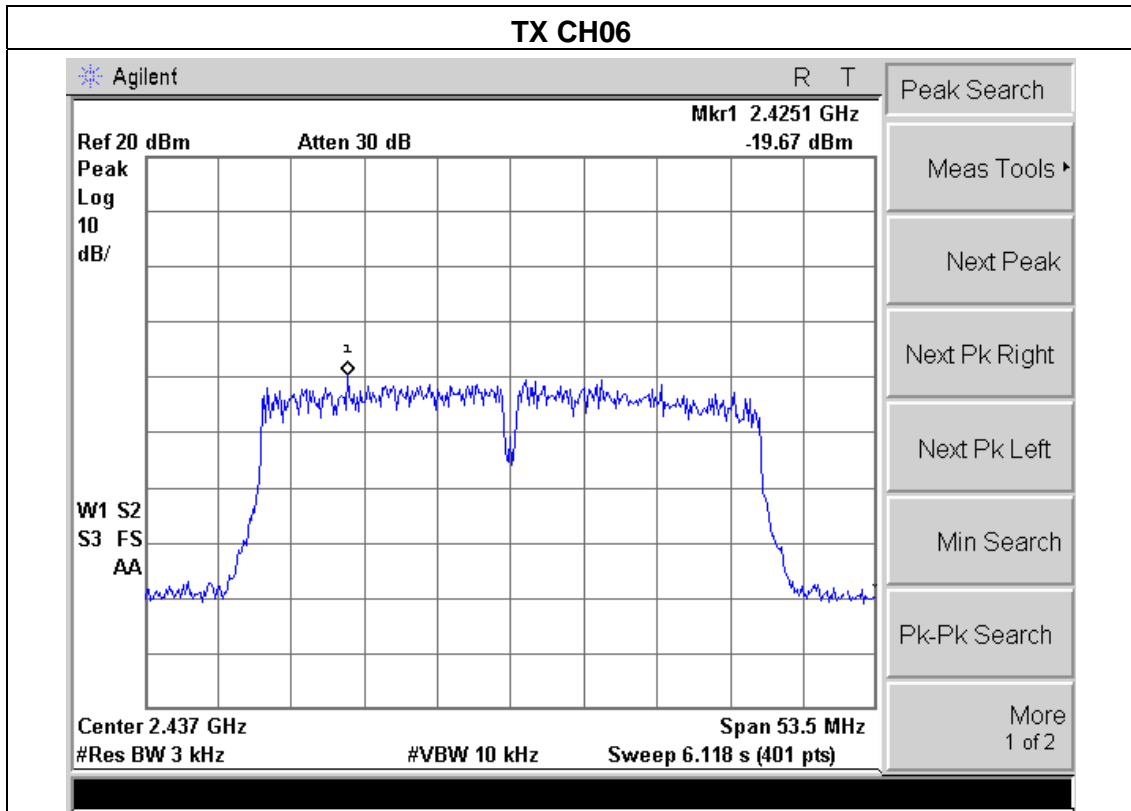

## 5. BANDWIDTH TEST

### 5.1 APPLIED PROCEDURES / LIMIT

FCC Part15 (15.247) , Subpart C				
Section	Test Item	Limit	Frequency Range (MHz)	Result
15.247(a)(2)	Bandwidth	$\geq 500\text{KHz}$ (6dB bandwidth)	2400-2483.5	PASS

#### 5.1.1 TEST PROCEDURE

1. Set RBW = 100 kHz.
2. Set the video bandwidth (VBW)  $\geq 3 \times$  RBW.
3. Detector = Peak.
4. Trace mode = max hold.
5. Sweep = auto couple.
6. Allow the trace to stabilize.
7. Measure the maximum width of the emission that is constrained by the frequencies associated with the two outermost amplitude points (upper and lower) that are attenuated by 6 dB relative to the maximum level measured in the fundamental emission.

#### TEST SETUP

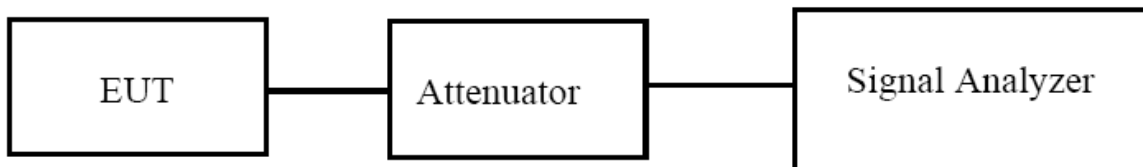

#### 5.1.2 EUT OPERATION CONDITIONS

The EUT tested system was configured as the statements of 2.4 Unless otherwise a special operating condition is specified in the follows during the testing.

### 5.1.3 TEST RESULTS

EUT :	Bluetooth Speaker	Model Name :	iChocolate PRO
Temperature :	25 °C	Relative Humidity :	56%
Pressure :	1012 hPa	Test Voltage :	DC 3.7V
Test Mode :	TX b Mode /CH01, CH06, CH11		

Channel	Frequency (MHz)	6dB bandwidth (MHz)	Limit (kHz)	Result
Low	2412	9.636	500	Pass
Middle	2437	9.598	500	Pass
High	2462	9.146	500	Pass

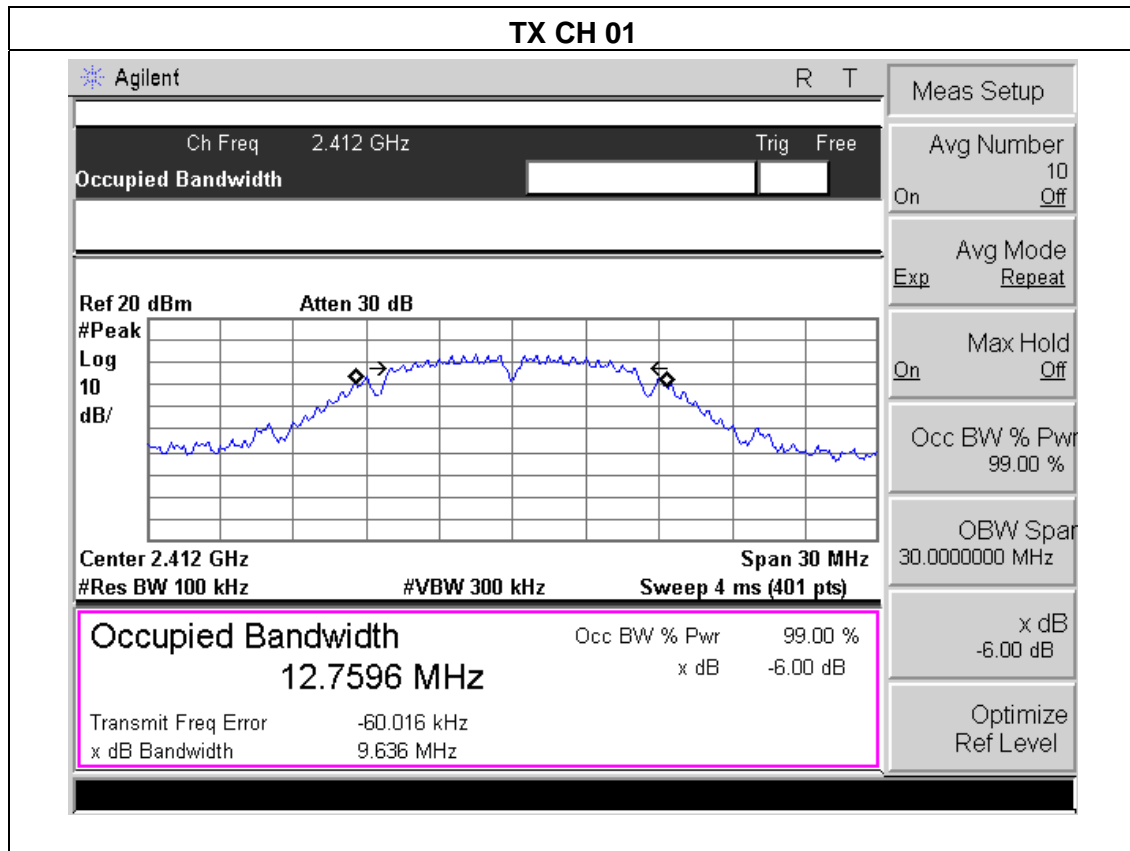

### TX CH 06

Agilent
R T

---

Ch Freq 2.437 GHz
Trig Free

**Occupied Bandwidth**

---

Ref 20 dBm
Atten 30 dB

#Peak  
Log  
10  
dB/

Freq/Channel

Center Freq  
2.43700000 GHz

Start Freq  
2.42200000 GHz

Stop Freq  
2.45200000 GHz

CF Step  
3.00000000 MHz  
Auto Man

Freq Offset  
0.00000000 Hz

Signal Track  
On Off

Scale Type  
Log Lin

---

Center 2.437 GHz
Span 30 MHz

#Res BW 100 kHz
#VBW 300 kHz
Sweep 4 ms (401 pts)

<b>Occupied Bandwidth</b>	Occ BW % Pwr	99.00 %
12.7462 MHz	x dB	-6.00 dB
Transmit Freq Error	-34.792 kHz	
x dB Bandwidth	9.598 MHz	

### TX CH 11

Agilent
R T

---

Ch Freq 2.462 GHz
Trig Free

**Occupied Bandwidth**

---

Ref 20 dBm
Atten 30 dB

#Peak  
Log  
10  
dB/

Freq/Channel

Center Freq  
2.46200000 GHz

Start Freq  
2.44700000 GHz

Stop Freq  
2.47700000 GHz

CF Step  
3.00000000 MHz  
Auto Man

Freq Offset  
0.00000000 Hz

Signal Track  
On Off

Scale Type  
Log Lin

---

Center 2.462 GHz
Span 30 MHz

#Res BW 100 kHz
#VBW 300 kHz
Sweep 4 ms (401 pts)

<b>Occupied Bandwidth</b>	Occ BW % Pwr	99.00 %
12.9010 MHz	x dB	-6.00 dB
Transmit Freq Error	-33.895 kHz	
x dB Bandwidth	9.146 MHz	

EUT :	Bluetooth Speaker	Model Name :	iChocolate PRO
Temperature :	25 °C	Relative Humidity :	60%
Pressure :	1012 hPa	Test Voltage :	DC 3.7V
Test Mode :	TX g Mode /CH01, CH06, CH11		

Channel	Frequency (MHz)	6dB bandwidth (MHz)	Limit (kHz)	Result
Low	2412	15.984	500	Pass
Middle	2437	16.140	500	Pass
High	2462	15.640	500	Pass

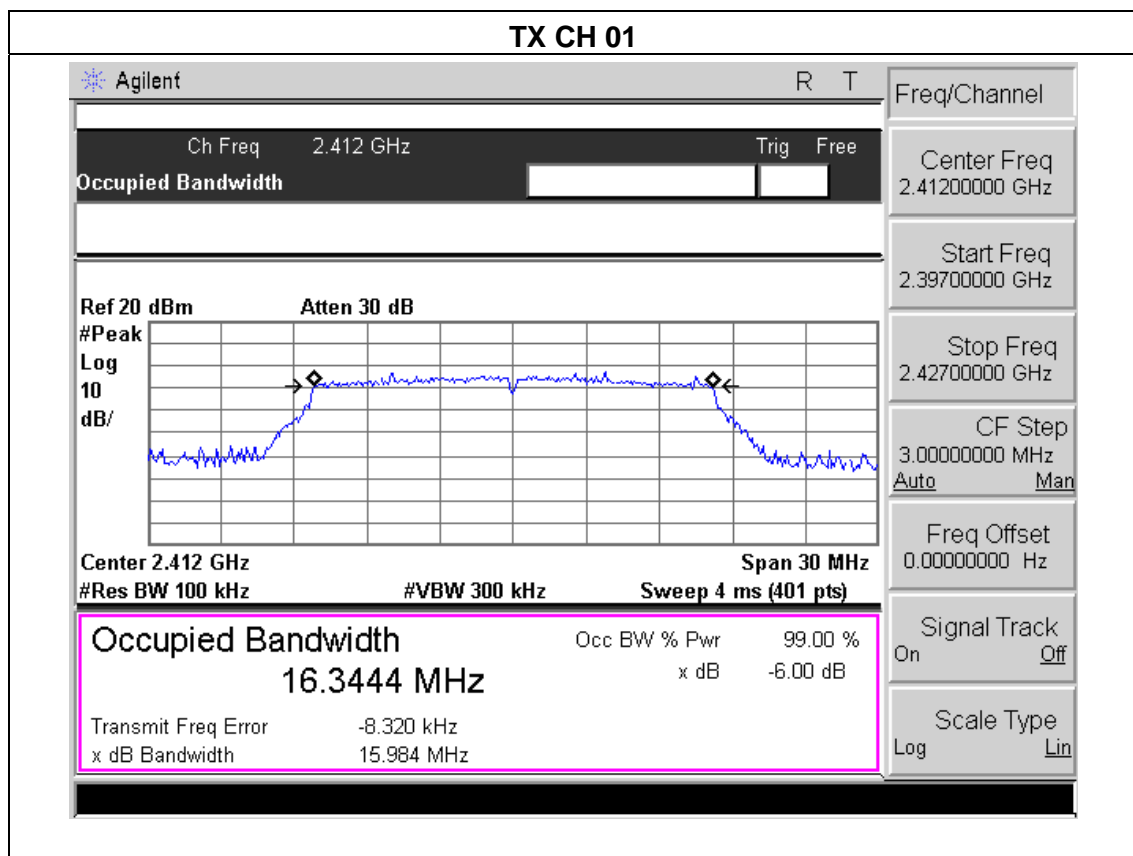

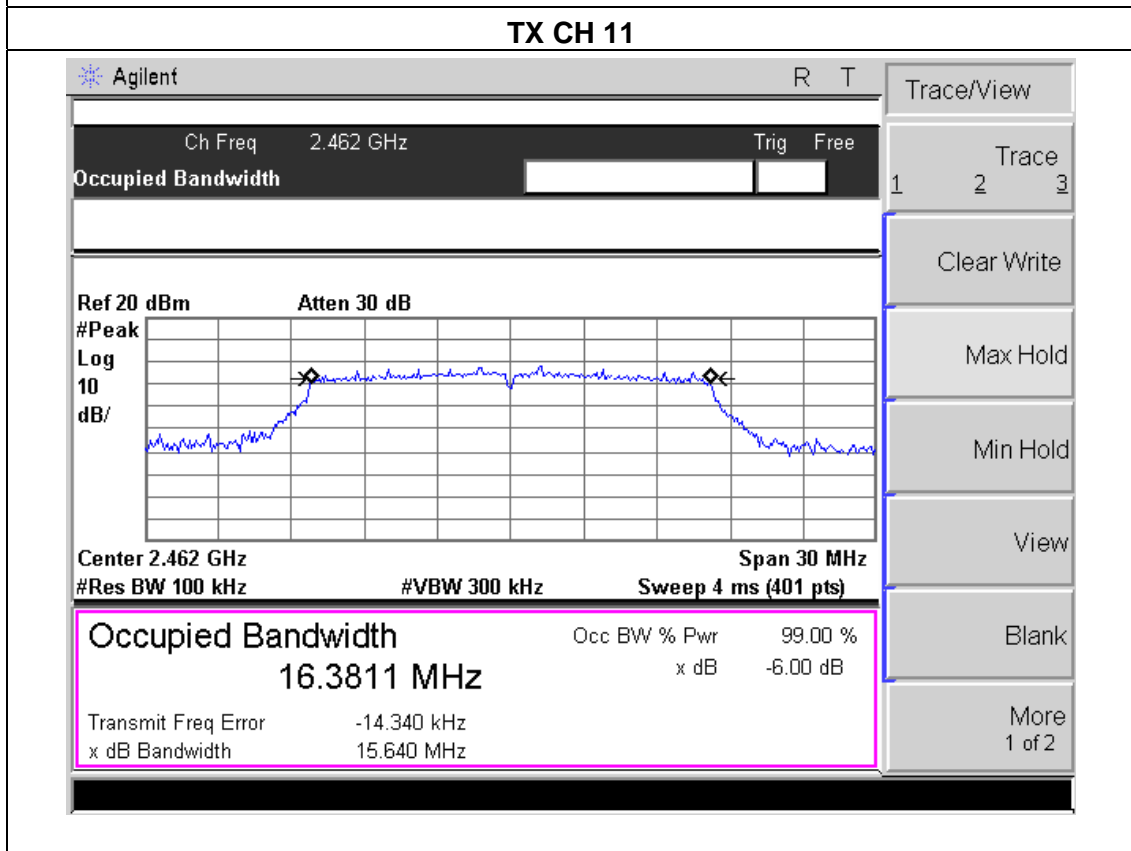
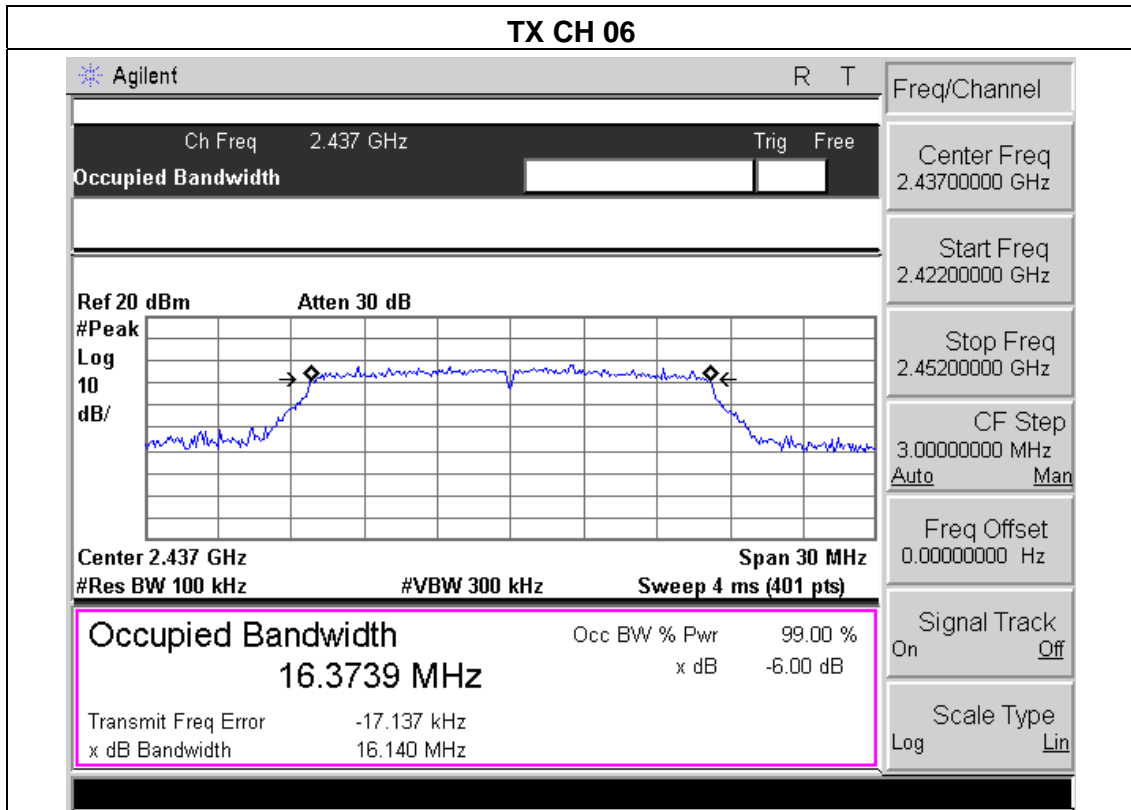



EUT :	Bluetooth Speaker	Model Name :	iChocolate PRO
Temperature :	25 °C	Relative Humidity :	56%
Pressure :	1012 hPa	Test Voltage :	DC 3.7V
Test Mode :	TX n Mode(20M) /CH01, CH06, CH11		

Channel	Frequency (MHz)	6dB bandwidth (MHz)	Limit (kHz)	Result
Low	2412	15.173	500	Pass
Middle	2437	15.541	500	Pass
High	2462	14.844	500	Pass

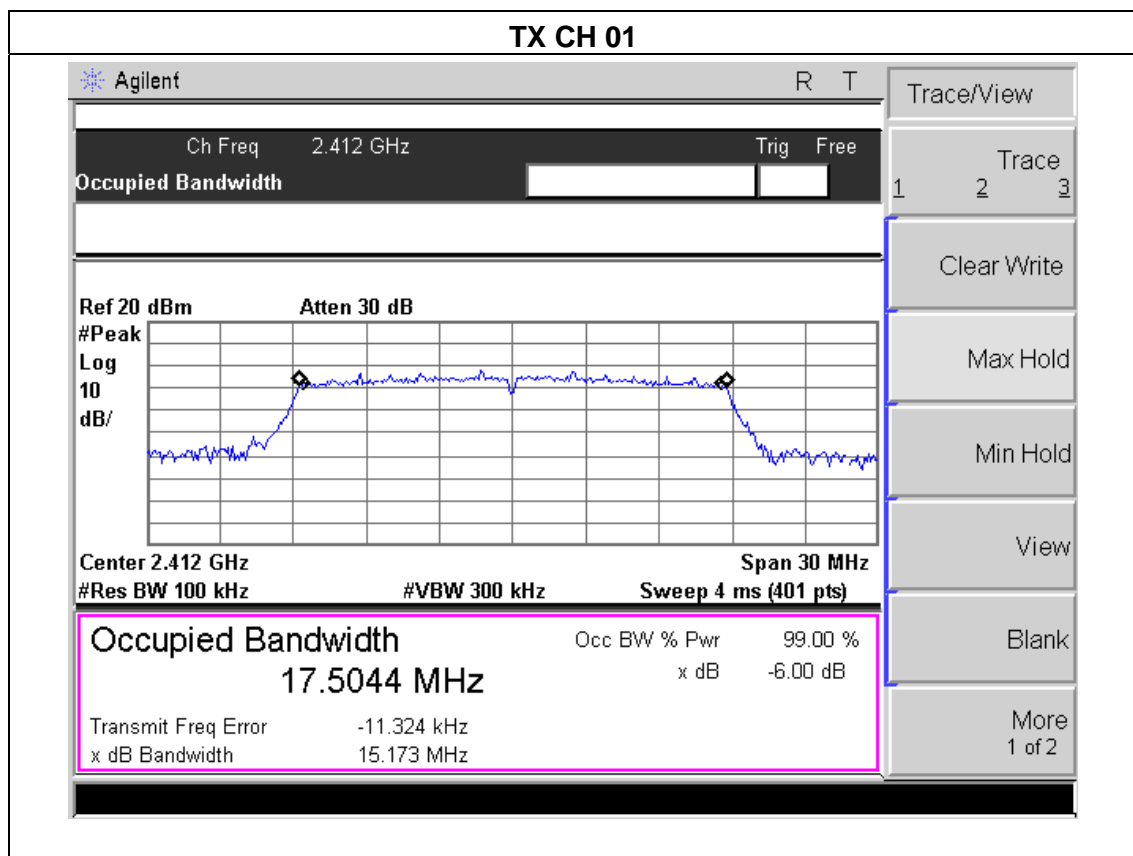

### TX CH 06

Agilent R T

Ch Freq 2.437 GHz Trig Free

Occupied Bandwidth

---

Ref 20 dBm Atten 30 dB

#Peak  
Log  
10  
dB/

Center 2.437 GHz Span 30 MHz

#Res BW 100 kHz #VBW 300 kHz Sweep 4 ms (401 pts)

**Occupied Bandwidth** Occ BW % Pwr 99.00 %

17.5138 MHz x dB -6.00 dB

Transmit Freq Error -3.693 kHz

x dB Bandwidth 15.541 MHz

Freq/Channel

Center Freq 2.43700000 GHz

Start Freq 2.42200000 GHz

Stop Freq 2.45200000 GHz

CF Step 3.00000000 MHz  
Auto Man

Freq Offset 0.00000000 Hz

Signal Track On Off

Scale Type Log Lin

### TX CH 11

Agilent R T

Ch Freq 2.462 GHz Trig Free

Occupied Bandwidth

---

Ref 20 dBm Atten 30 dB

#Peak  
Log  
10  
dB/

Center 2.462 GHz Span 30 MHz

#Res BW 100 kHz #VBW 300 kHz Sweep 4 ms (401 pts)

**Occupied Bandwidth** Occ BW % Pwr 99.00 %

17.5134 MHz x dB -6.00 dB

Transmit Freq Error -24.518 kHz

x dB Bandwidth 14.844 MHz

Span

Span 30.00000000 MHz

Span Zoom

Full Span

Zero Span

Last Span

Zone ▶

EUT :	Bluetooth Speaker	Model Name :	iChocolate PRO
Temperature :	25 °C	Relative Humidity :	56%
Pressure :	1012 hPa	Test Voltage :	DC 3.7V
Test Mode :	TX n Mode(40M) /CH03, CH06, CH09		

Channel	Frequency (MHz)	6dB bandwidth (MHz)	Limit (kHz)	Result
Low	2422	35.381	500	Pass
Middle	2437	35.435	500	Pass
High	2452	35.321	500	Pass

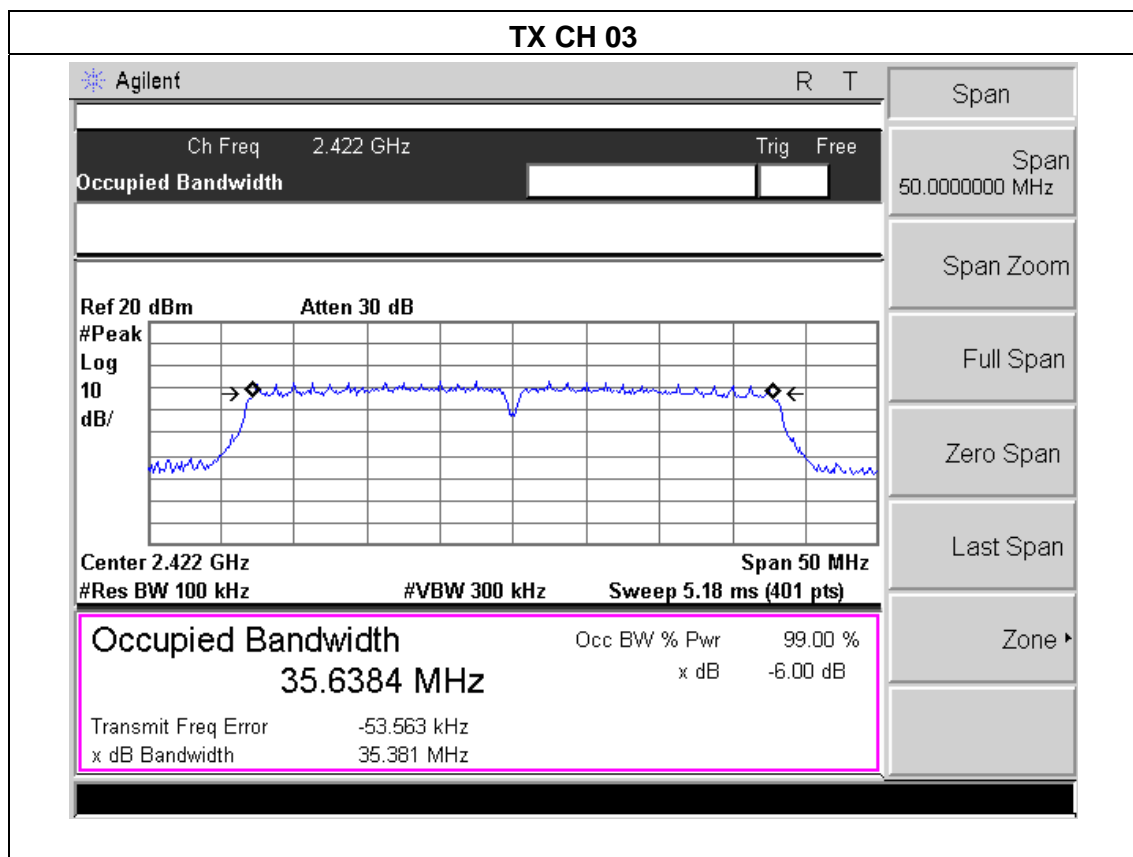

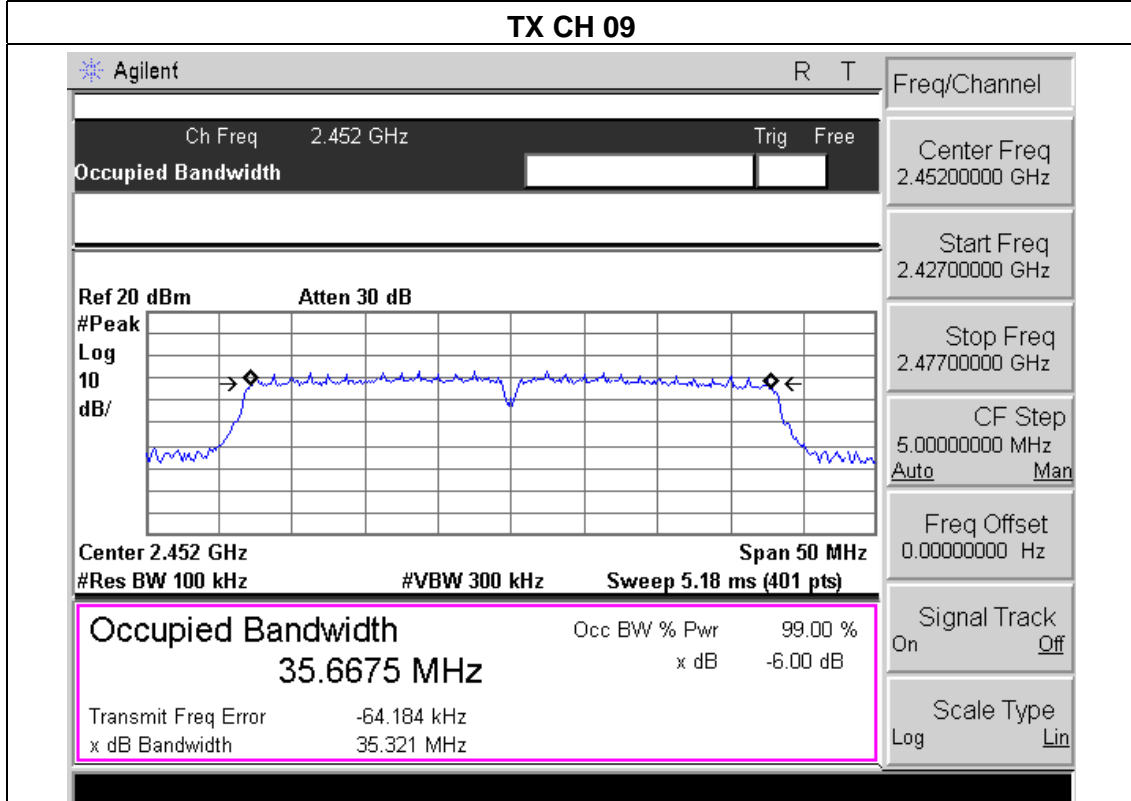
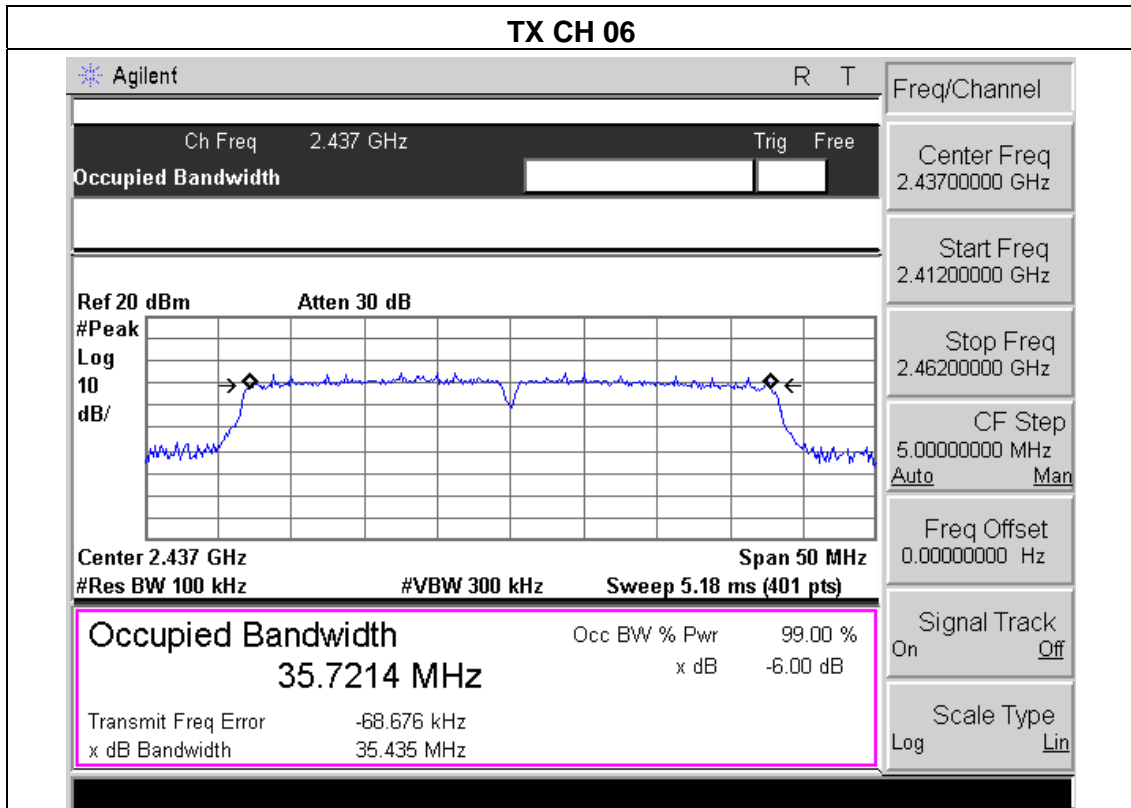

**6. PEAK OUTPUT POWER TEST**

**6.1 APPLIED PROCEDURES / LIMIT**

FCC Part15 (15.247) , Subpart C				
Section	Test Item	Limit	Frequency Range (MHz)	Result
15.247(b)(3)	Peak Output Power	1 watt or 30dBm	2400-2483.5	PASS

**6.1.1 TEST PROCEDURE**

- a. The EUT was directly connected to the Power meter

**6.1.2 DEVIATION FROM STANDARD**

No deviation.

**6.1.3 TEST SETUP**

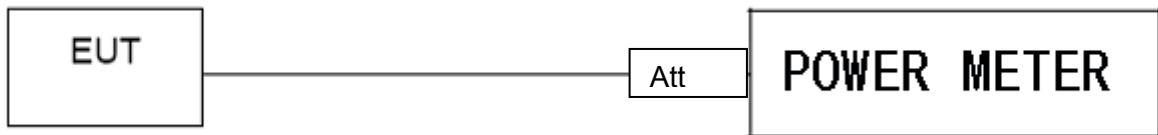

**6.1.4 EUT OPERATION CONDITIONS**

The EUT tested system was configured as the statements of 2.4 Unless otherwise a special operating condition is specified in the follows during the testing.

**6.1.5 TEST RESULTS**

EUT :	Bluetooth Speaker	Model Name :	iChocolate PRO
Temperature :	25 °C	Relative Humidity :	60%
Pressure :	1012 hPa	Test Voltage :	DC 3.7V
Test Mode :	TX b/g/n(20M/40M) Mode		

<b>TX 802.11b Mode</b>				
Test Channel	Frequency	Maximum Peak Conducted Output Power (PK)	Maximum Peak Conducted Output Power (AV)	LIMIT
	(MHz)	(dBm)	(dBm)	dBm
CH01	2412	12.21	9.36	30
CH06	2437	12.31	9.49	30
CH11	2462	12.02	9.2	30
<b>TX 802.11g Mode</b>				
CH01	2412	11.88	8.75	30
CH06	2437	11.69	8.56	30
CH11	2462	11.56	8.43	30
<b>TX 802.11n(20) Mode</b>				
CH01	2412	10.77	8.54	30
CH06	2437	10.89	8.66	30
CH11	2462	10.74	8.51	30
<b>TX 802.11n(40) Mode</b>				
CH03	2422	9.83	7.41	30
CH06	2437	9.54	7.12	30
CH09	2452	9.33	6.91	30

## 7. 100 KHZ BANDWIDTH OF FREQUENCY BAND EDGE

### APPLICABLE STANDARD

In any 100 kHz bandwidth outside the frequency band in which the spread spectrum or digitally modulated intentional radiator is operating, the radio frequency power that is produced by the intentional radiator shall be at least 20 dB below that in the 100 kHz bandwidth within the band that contains the highest level of the desired power, based on either an RF conducted or a radiated measurement, provided the transmitter demonstrates compliance with the peak conducted power limits. If the transmitter complies with the conducted power limits based on the use of RMS averaging over a time interval, as permitted under paragraph (b)(3) of this section, the attenuation required under this paragraph shall be 30 dB instead of 20 dB. Attenuation below the general limits specified in §15.209(a) is not required. In addition, radiated emissions which fall in the restricted bands, as defined in §15.205(a), must also comply with the radiated emission limits specified in §15.209(a) (see §15.205(c)).

### TEST PROCEDURE

- a) Check the calibration of the measuring instrument using either an internal calibrator or a known signal from an external generator.
- b) Position the EUT without connection to measurement instrument. Turn on the EUT and connect its antenna terminal to measurement instrument via a low loss cable. Then set it to any one measured frequency within its operating range, and make sure the instrument is operated in its linear range.
- c) Set RBW to 100 kHz and VBW of spectrum analyzer to 300 kHz with a convenient frequency span including 100 kHz bandwidth from band edge.
- d) Measure the highest amplitude appearing on spectral display and set it as a reference level. Plot the graph with marking the highest point and edge frequency.
- e) Repeat above procedures until all measured frequencies were complete.

### 7.1 DEVIATION FROM STANDARD

No deviation.

### 7.2 TEST SETUP

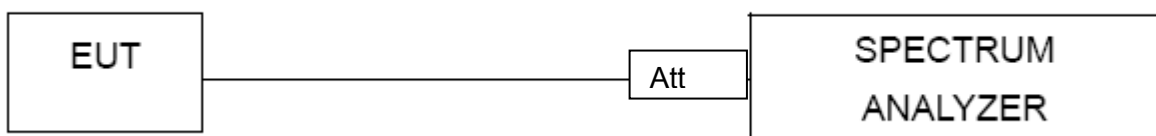

### 7.3 EUT OPERATION CONDITIONS

The EUT tested system was configured as the statements of 2.4 Unless otherwise a special operating condition is specified in the follows during the testing.

### 7.4 TEST RESULTS

EUT :	Bluetooth Speaker	Model Name :	iChocolate PRO
Temperature :	25 °C	Relative Humidity :	56%
Pressure :	1012 hPa	Test Voltage :	DC 3.7V

Frequency Band MHz	Delta Peak to band emission (dBc)	> Limit (dBc)	Result
802.11b mode			
2400	41.26	20	Pass
2483.5	51.55	20	Pass
802.11g mode			
2400	35.96	20	Pass
2483.5	41.59	20	Pass
802.11n-HT20 mode			
2400	33.18	20	Pass
2483.5	40.22	20	Pass
802.11n-HT40 mode			
2400	36.96	20	Pass
2483.5	38.55	20	Pass



Radiated band edge:

Frequency (MHz)	Meter Reading (dBμV)	Factor (dB)	Emission Level (dBμV/m)	Limits (dBμV/m)	Margin (dB)	Detector Type	Comment
<b>802.11b</b>							
2390	60.36	-13.06	47.3	74	-26.70	peak	Vertical
2390	59.66	-13.06	46.6	74	-27.40	peak	Horizontal
2483.5	60.14	-12.78	47.36	74	-26.64	peak	Vertical
2483.5	60.85	-12.78	48.07	74	-25.93	peak	Horizontal
<b>802.11g</b>							
2390	58.67	-13.06	45.61	74	-28.39	peak	Vertical
2390	58.47	-13.06	45.41	74	-28.59	peak	Horizontal
2483.5	60.22	-12.78	47.44	74	-26.56	peak	Vertical
2483.5	60.15	-12.78	47.37	74	-26.63	peak	Horizontal
<b>802.11n (20)</b>							
2390	61.23	-13.06	48.17	74	-25.83	peak	Vertical
2390	62.33	-13.06	49.27	74	-24.73	peak	Horizontal
2483.5	61.47	-12.78	48.69	74	-25.31	peak	Vertical
2483.5	61.93	-12.78	49.15	74	-24.85	peak	Horizontal
<b>802.11n (40)</b>							
2390	61.94	-13.06	48.88	74	-25.12	peak	Vertical
2390	63.09	-13.06	50.03	74	-23.97	peak	Horizontal
2483.5	61.59	-12.78	48.81	74	-25.19	peak	Vertical
2483.5	61.56	-12.78	48.78	74	-25.22	peak	Horizontal

Note: Test method to see chapter 3.2 . When PK value is lower than the Average value limit, average not record.

### 802.11b: Band Edge, Right Side

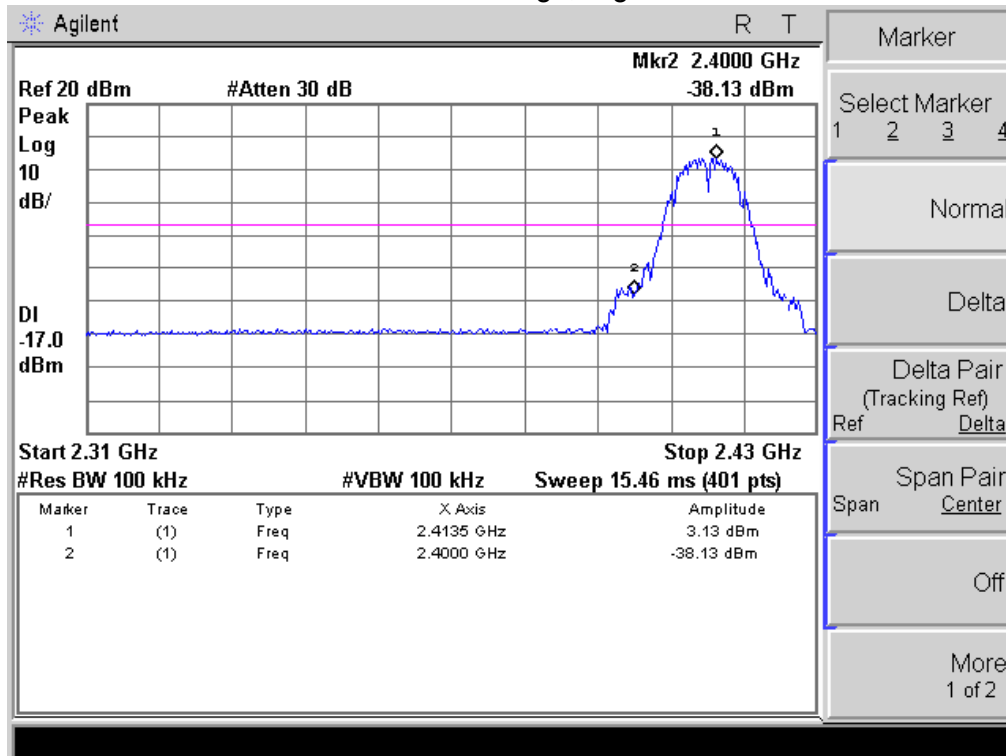

### 802.11b: Band Edge, Left Side

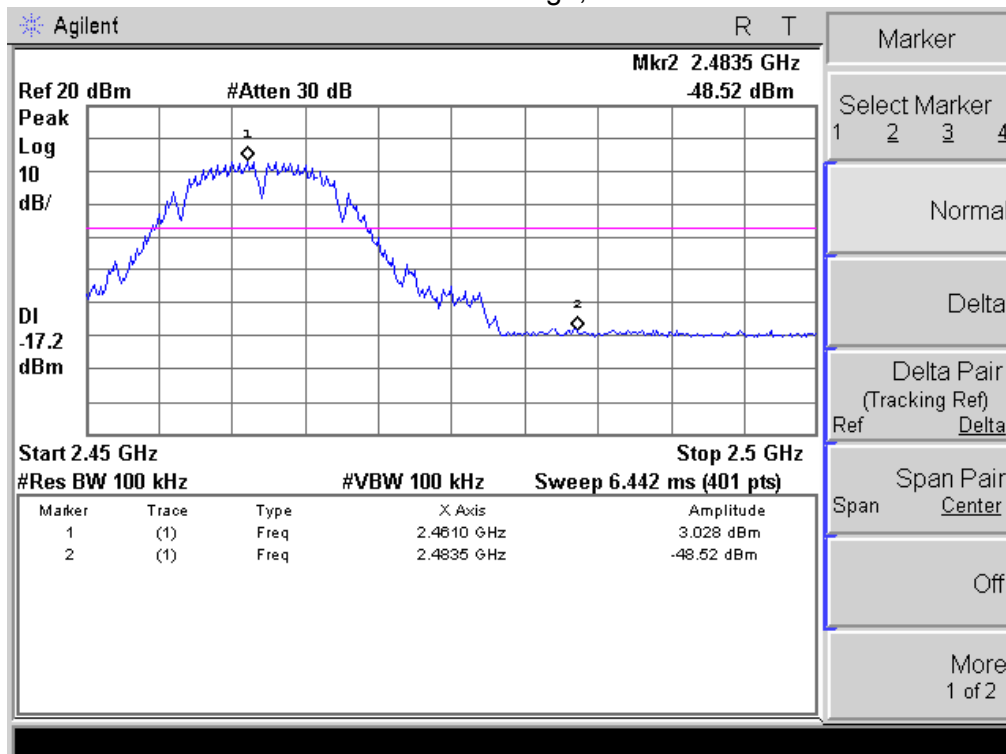

### 802.11g: Band Edge, Right Side

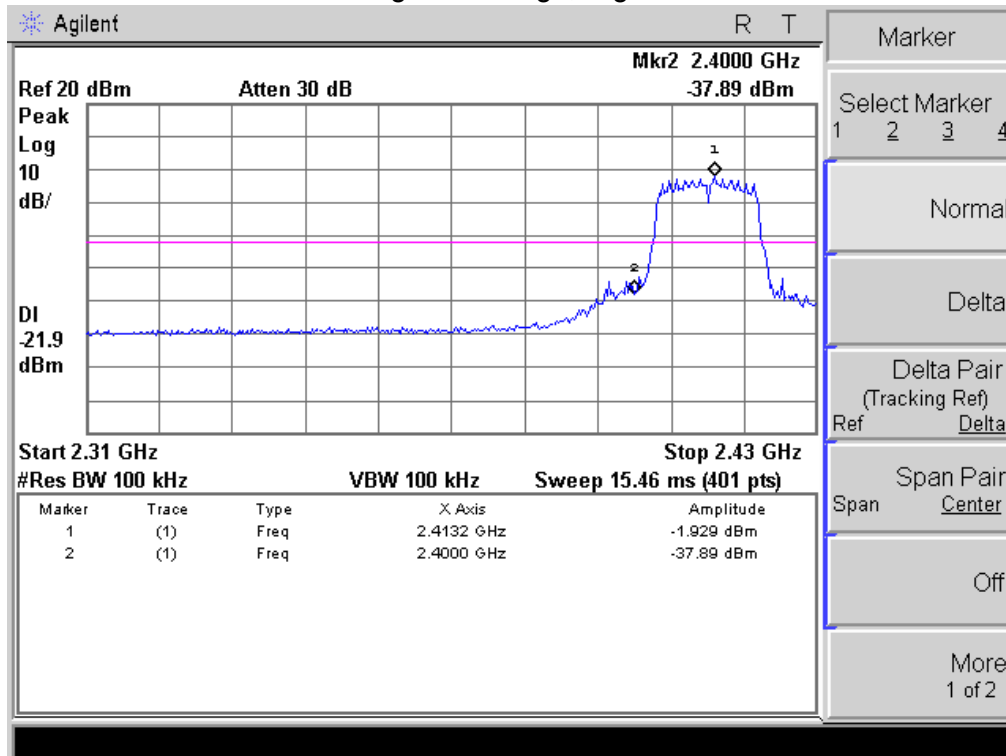

### 802.11g: Band Edge, Left Side

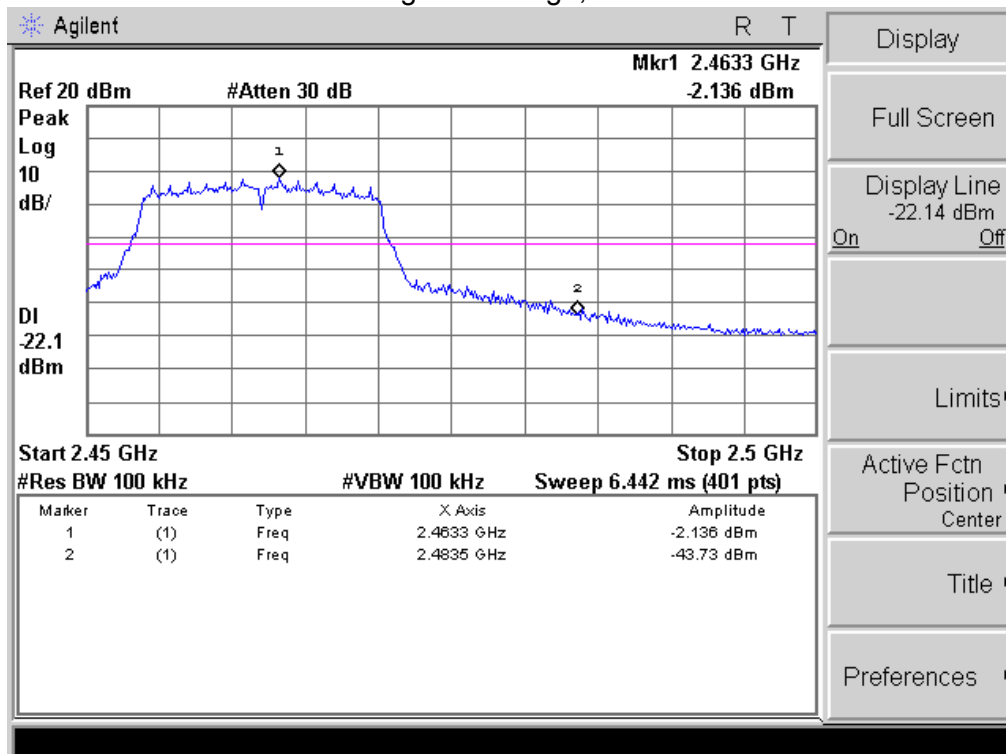

### 802.11n-HT20: Band Edge, Right Side

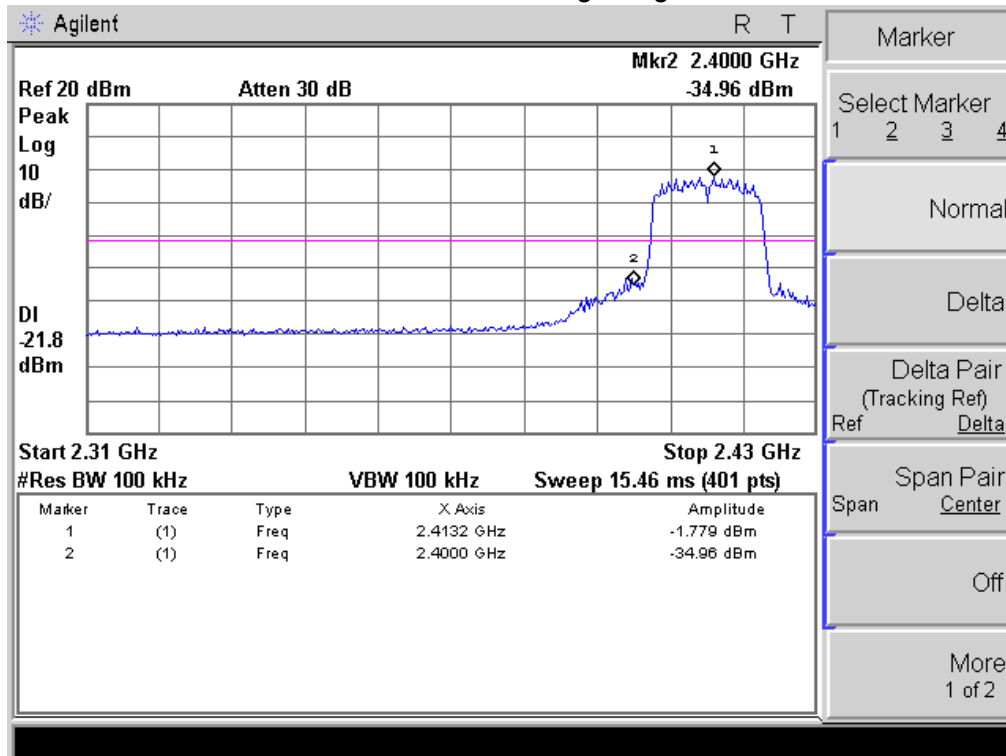

### 802.11n-HT20: Band Edge, Left Side

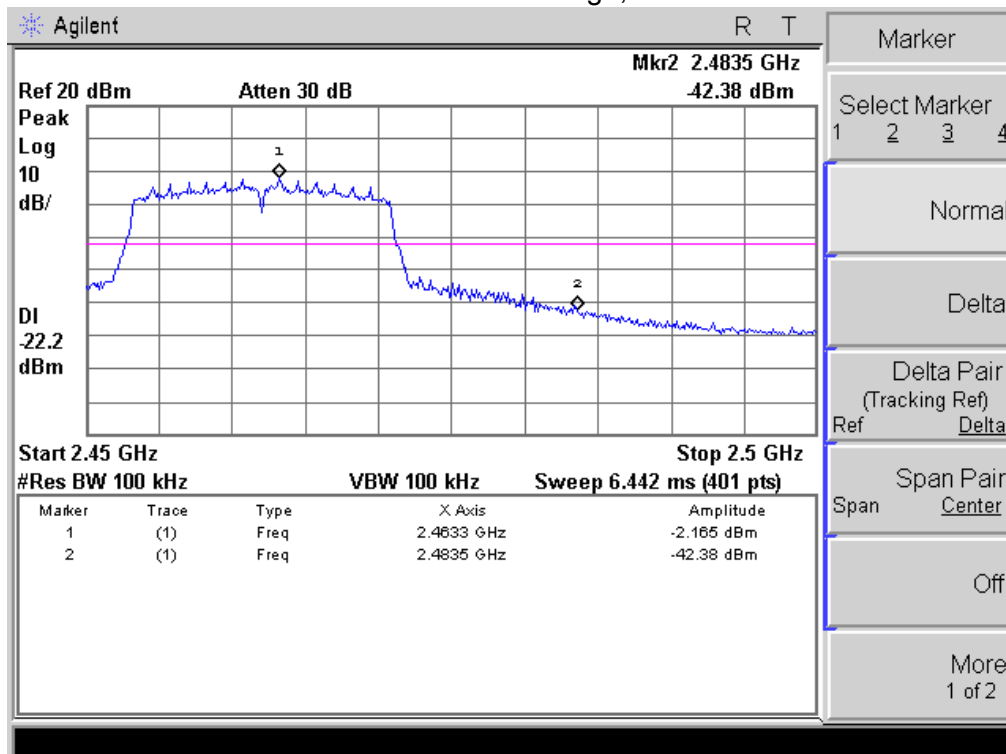

### 802.11n-HT40: Band Edge, Right Side

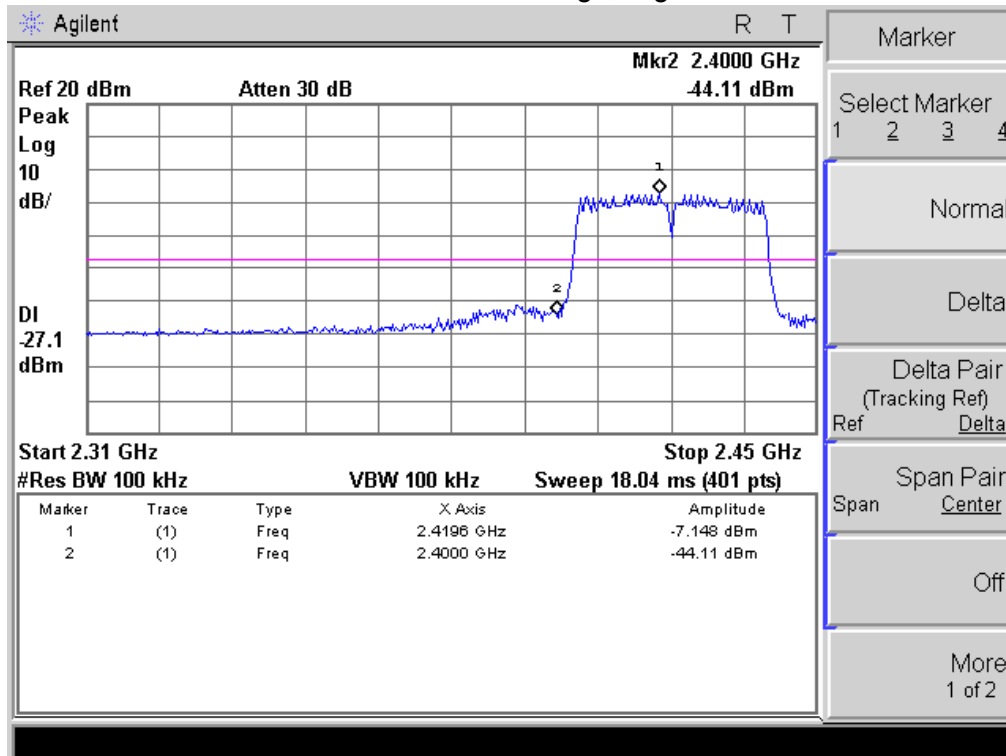

### 802.11n-HT40: Band Edge, Left Side

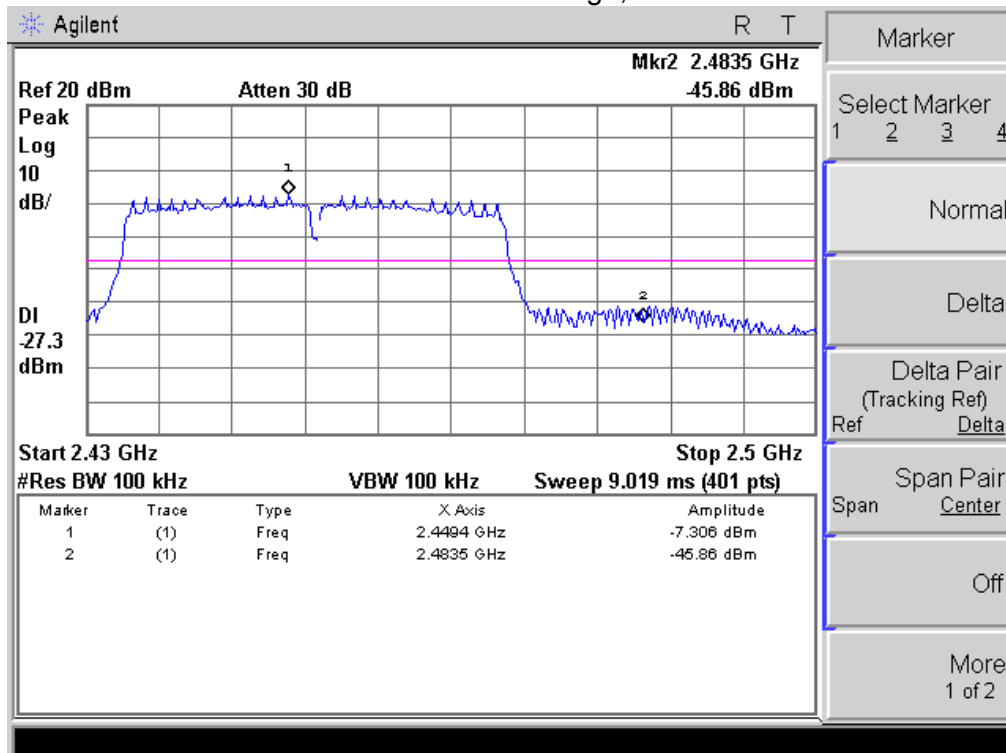

## **8. ANTENNA REQUIREMENT**

### **8.1 STANDARD REQUIREMENT**

15.203 requirement: For intentional device, according to 15.203: an intentional radiator shall be designed to ensure that no antenna other than that furnished by the responsible party shall be used with the device.

### **8.2 EUT ANTENNA**

The EUT antenna is permanent attached antenna. It comply with the standard requirement.

**9. EUT TEST PHOTO**

**Radiated Measurement Photos**

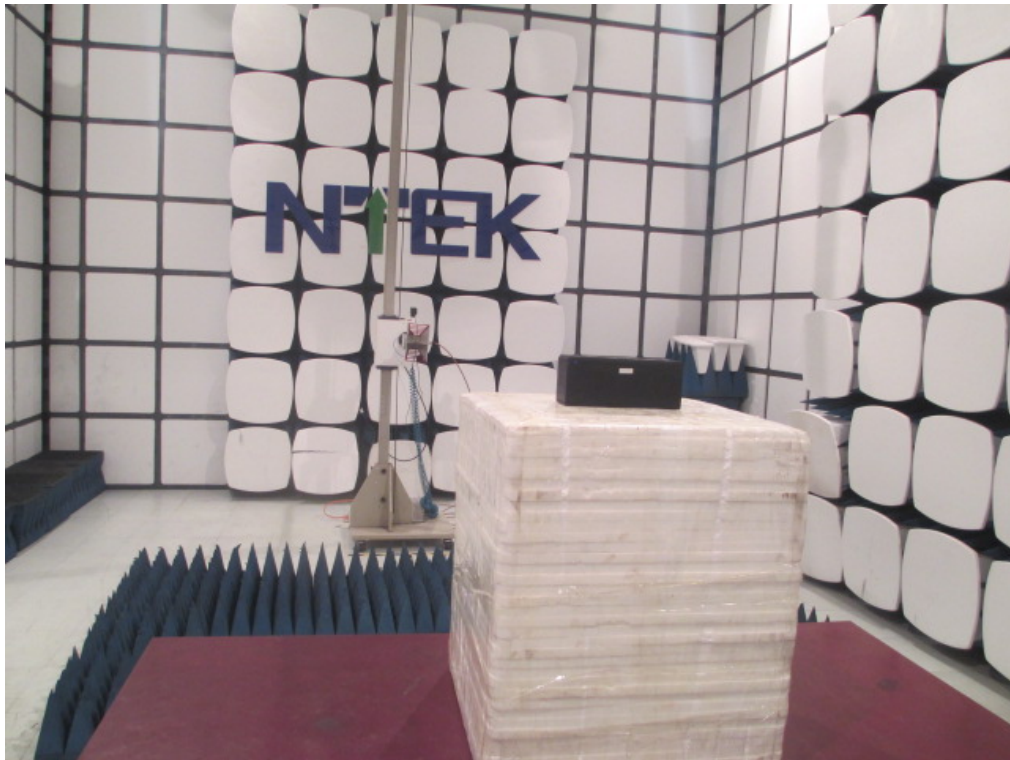
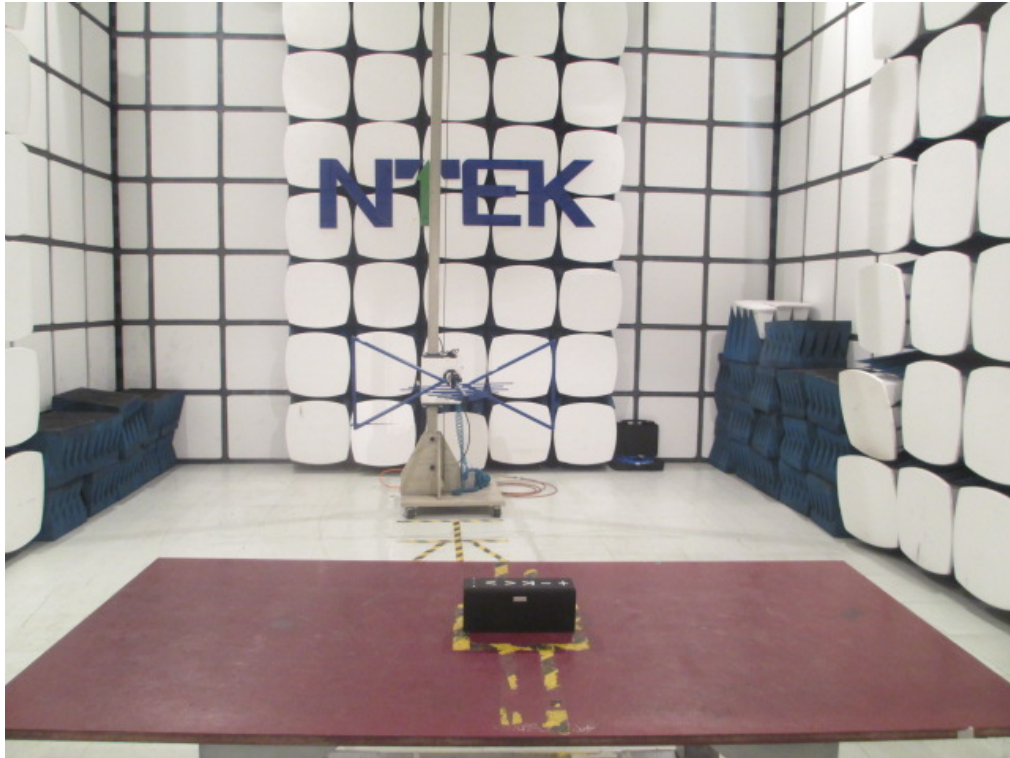

**CONDUCTED EMISSION Photos**

