



FCC RADIO TEST REPORT

FCC ID:2AFSS-MAGIC

Product : Bluetooth Speaker

Trade Name : cowin

Model Name : Magic

Serial Model : Magic II, SBT5006BK

Report No. : NTEK-2015NT08202530F1

Prepared for

Shenzhen MeiDong Acoustics Co., Ltd.

Cell B, 3th Floor, Tower B, Hongzhuyongqi Technology Park, Lezhujiao,
Xixiang, Baoan, Shenzhen, Guangdong, China

Prepared by

Shenzhen NTEK Testing Technology Co., Ltd.

1/F, Building E, Fenda Science Park, Sanwei Community, Xixiang Street
Bao'an District, Shenzhen P.R. China

Tel.: +86-0755-61156588 Fax.: +86-0755-61156599

Website: www.ntek.org.cn

TEST RESULT CERTIFICATION

Applicant's name : Shenzhen MeiDong Acoustics Co., Ltd.
Address : Cell B, 3th Floor, Tower B, Hongzhuyongqi Technology Park,
 Lezhujiao, Xixiang, Baoan, Shenzhen, Guangdong, China
Manufacture's Name..... : Shenzhen MeiDong Acoustics Co., Ltd.
Address : Cell B, 3th Floor, Tower B, Hongzhuyongqi Technology Park,
 Lezhujiao, Xixiang, Baoan, Shenzhen, Guangdong, China

Product description

Product name : Bluetooth Speaker
Model and/or type reference : Magic
Serial Model : Magic II, SBT5006BK
Rating(s)..... : DC 3.7V

Standards : FCC Part15.249 01 Oct. 2014

Test procedure..... ANSI C63.10-2013

This device described above has been tested by NTEK, and the test results show that the equipment under test (EUT) is in compliance with the FCC requirements. And it is applicable only to the tested sample identified in the report.

This report shall not be reproduced except in full, without the written approval of NTEK, this document may be altered or revised by NTEK, personnel only, and shall be noted in the revision of the document.

Date of Test..... :

Date (s) of performance of tests : 20 Aug. 2015 ~22 Sep. 2015

Date of Issue..... : 22 Sep. 2015

Test Result..... : **Pass**

Testing Engineer : Jason Chen
 (Jason Chen)

Technical Manager : Brown Lu
 (Brown Lu)

Authorized Signatory : Sam. Chen
 (Sam Chen)

| Table of Contents | Page |
|---|-------------|
| 1 . SUMMARY OF TEST RESULTS | 4 |
| 1.1 TEST FACILITY | 5 |
| 1.2 MEASUREMENT UNCERTAINTY | 5 |
| 2 . GENERAL INFORMATION | 6 |
| 2.1 GENERAL DESCRIPTION OF EUT | 6 |
| 2.2 DESCRIPTION OF TEST MODES | 8 |
| 2.3 BLOCK DIGRAM SHOWING THE CONFIGURATION OF SYSTEM TESTED | 9 |
| 2.4 DESCRIPTION OF SUPPORT UNITS(CONDUCTED MODE) | 10 |
| 2.5 EQUIPMENTS LIST FOR ALL TEST ITEMS | 11 |
| 3 . ANTENNA REQUIREMENT | 12 |
| 3.1 STANDARD REQUIREMENT | 12 |
| 3.2 EUT ANTENNA | 12 |
| 3.3 CONDUCTED EMISSION MEASUREMENT | 13 |
| 3.3.1 POWER LINE CONDUCTED EMISSION LIMITS | 13 |
| 3.3.2 TEST PROCEDURE | 14 |
| 3.3.3 DEVIATION FROM TEST STANDARD | 14 |
| 3.3.4 TEST SETUP | 14 |
| 3.2.5 TEST RESULT | 15 |
| 3.4 RADIATED EMISSION MEASUREMENT | 19 |
| 3.4.1 RADIATED EMISSION LIMITS | 19 |
| 3.4.2 TEST PROCEDURE | 20 |
| 3.4.3 DEVIATION FROM TEST STANDARD | 20 |
| 3.4.4 TEST SETUP | 21 |
| 3.4.5 TEST RESULTS (BLOW 30MHZ) | 23 |
| 3.4.6 TEST RESULTS (BETWEEN 30 – 1000 MHZ) | 24 |
| 3.4.7 TEST RESULTS (ABOVE 1000 MHZ) | 26 |
| 3.4.8 TEST RESULTS (RESTRICTED BANDS REQUIREMENTS) | 28 |
| 4 . BANDWIDTH TEST | 30 |
| 4.1 TEST PROCEDURE | 30 |
| 4.2 DEVIATION FROM STANDARD | 30 |
| 4.3 TEST SETUP | 30 |
| 4.4 TEST RESULTS | 31 |
| 5 . EUT TEST PHOTO | 32 |
| APPENDIX-PHOTOGRAPHS OF EUT CONSTRUCTIONAL DETAILS | |

1. SUMMARY OF TEST RESULTS

Test procedures according to the technical standards:

| FCC Part15, Subpart C (15.249) | | | |
|---------------------------------------|----------------------------|----------|--------|
| Standard Section | Test Item | Judgment | Remark |
| 15.207 | Conducted Emission | Pass | |
| 15.203 | Antenna Requirement | Pass | |
| 15.249 | Radiated Spurious Emission | Pass | |
| 15.205 | Band Edge Emission | Pass | |
| 15.249 | Occupied Bandwidth | Pass | |

1.1 TEST FACILITY

NTEK Testing Technology Co., Ltd

Add. : 1/F, Building E, Fenda Science Park, Sanwei Community, Xixiang Street, Bao'an District, Shenzhen P.R. China.

FCC FRN Registration No.:238937; IC Registration No.:9270A-1

CNAS Registration No.:L5516

1.2 MEASUREMENT UNCERTAINTY

The reported uncertainty of measurement $y \pm U$, where expanded uncertainty U is based on a standard uncertainty multiplied by a coverage factor of $k=2$, providing a level of confidence of approximately 95 %.

| No. | Item | Uncertainty |
|-----|------------------------------|-------------------------|
| 1 | Conducted Emission Test | $\pm 1.38\text{dB}$ |
| 2 | RF power,conducted | $\pm 0.16\text{dB}$ |
| 3 | Spurious emissions,conducted | $\pm 0.21\text{dB}$ |
| 4 | All emissions,radiated(<1G) | $\pm 4.68\text{dB}$ |
| 5 | All emissions,radiated(>1G) | $\pm 4.89\text{dB}$ |
| 6 | Temperature | $\pm 0.5^\circ\text{C}$ |
| 7 | Humidity | $\pm 2\%$ |

2. GENERAL INFORMATION

2.1 GENERAL DESCRIPTION OF EUT

| | |
|---------------------|--|
| Equipment | Bluetooth Speaker |
| Trade Name | cowin |
| Model Name | Magic |
| Serial Model | Magic II, SBT5006BK |
| Model Difference | All the model are the same circuit and RF module, except the model name and colour. |
| Product Description | The EUT is a Bluetooth Speaker |
| | Operation Frequency: 915MHz |
| | Modulation Type: FSK |
| | Antenna Designation: PCB Antenna |
| | Antenna Gain(Peak) 1.0 dBi |
| | Based on the application, features, or specification exhibited in User's Manual, the EUT is considered as an ITE/Computing Device. More details of EUT technical specification, please refer to the User's Manual. |
| Channel List | Please refer to the Note 2. |
| Adapter | Model: DYS624-150200W-1 Input: 100-240V~, 50/60 Hz, 0.8A Max Output: 15.0V---, 2A |
| Battery | DC 3.7V , 800mAh |

Note:

1. For a more detailed features description, please refer to the manufacturer's specifications or the User's Manual.

2.

| Channel | Frequency (MHz) |
|---------|-----------------|
| 01 | 916.0MHz |

3.

Table for Filed Antenna

| Ant | Brand | Model Name | Antenna Type | Connector | Gain (dBi) | NOTE |
|-----|-------|------------|--------------|-----------|------------|---------|
| 1 | N/A | N/A | PCB Antenna | N/A | 1.0 | Antenna |

2.2 DESCRIPTION OF TEST MODES

To investigate the maximum EMI emission characteristics generates from EUT, the test system was pre-scanning tested base on the consideration of following EUT operation mode or test configuration mode which possible have effect on EMI emission level. Each of these EUT operation mode(s) or test configuration mode(s) mentioned above was evaluated respectively.

| Pretest Mode | Description |
|--------------|-------------|
| Mode 1 | CH1 |

| For Conducted Emission | |
|------------------------|-------------|
| Final Test Mode | Description |
| Mode 1 | CH1 |

| For Radiated Emission | |
|-----------------------|-------------|
| Final Test Mode | Description |
| Mode 1 | CH1 |

Note:

- (1) The measurements are performed at the highest, middle, lowest available channels.
- (2) The EUT use new battery.

2.3 BLOCK DIGRAM SHOWING THE CONFIGURATION OF SYSTEM TESTED

Radiated Spurious Emission Test

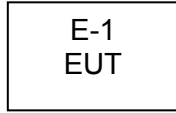

Conducted Emission Test

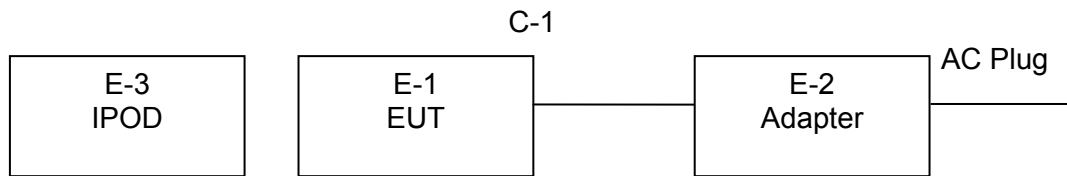

2.4 DESCRIPTION OF SUPPORT UNITS(CONDUCTED MODE)

The EUT has been tested as an independent unit together with other necessary accessories or support units. The following support units or accessories were used to form a representative test configuration during the tests.

| Item | Equipment | Mfr/Brand | Model/Type No. | Series No. | Note |
|------|-------------------|-----------|------------------|------------|------|
| E-1 | Bluetooth Speaker | cowin | Magic | N/A | EUT |
| E-2 | ADAPTER | N/A | DYS624-150200W-1 | N/A | |
| E-3 | IPOD | Apple | A1367 | N/A | |
| | | | | | |
| | | | | | |

| Item | Shielded Type | Ferrite Core | Length | Note |
|------|---------------|--------------|--------|------|
| C-1 | NO | NO | 1.2m | |
| | | | | |
| | | | | |
| | | | | |
| | | | | |

Note:

- (1) The support equipment was authorized by Declaration of Confirmation.
- (2) For detachable type I/O cable should be specified the length in cm in 『Length』 column.

2.5 EQUIPMENTS LIST FOR ALL TEST ITEMS

Radiation Test equipment

| Item | Kind of Equipment | Manufacturer | Type No. | Serial No. | Calibrated until |
|------|--------------------|--------------|-------------|------------|------------------|
| 1 | Spectrum Analyzer | Agilent | E4407B | 160400005 | Jul. 06. 2016 |
| 2 | Test Receiver | R&S | ESPI | 101318 | Jul. 06. 2016 |
| 3 | Bilog Antenna | TESEQ | CBL6111D | 31216 | Jul. 06. 2016 |
| 4 | 50Ω Coaxial Switch | Anritsu | MP59B | 6200264416 | Jul. 06. 2016 |
| 5 | Spectrum Analyzer | ADVANTEST | R3132 | 150900201 | Jul. 06. 2016 |
| 6 | Horn Antenna | EM | EM-AH-10180 | 2011071402 | Jul. 06. 2016 |
| 7 | Horn Ant | Schwarzbeck | BBHA 9170 | 9170-181 | Jul. 06. 2016 |
| 8 | Amplifier | EM | EM-30180 | 060538 | Jul. 06. 2016 |
| 9 | Loop Antenna | ARA | PLA-1030/B | 1029 | Jul. 06. 2016 |
| 10 | Power Meter | R&S | NRVS | 100696 | Jul. 06. 2016 |

Conduction Test equipment

| Item | Kind of Equipment | Manufacturer | Type No. | Serial No. | Calibrated until |
|------|-----------------------|--------------|----------|------------|------------------|
| 1 | Test Receiver | R&S | ESCI | 101160 | Jul. 06. 2016 |
| 2 | LISN | R&S | ENV216 | 101313 | Jul. 06. 2016 |
| 3 | LISN | EMCO | 3816/2 | 00042990 | Jul. 06. 2016 |
| 4 | 50Ω Coaxial Switch | Anritsu | MP59B | 6200264417 | Jul. 06. 2016 |
| 5 | Passive Voltage Probe | R&S | ESH2-Z3 | 100196 | Jul. 06. 2016 |
| 6 | Absorbing clamp | R&S | MOS-21 | 100423 | Jul. 06. 2016 |

3. ANTENNA REQUIREMENT

3.1 STANDARD REQUIREMENT

15.203 requirement: For intentional device, according to 15.203: an intentional radiator shall be designed to ensure that no antenna other than that furnished by the responsible party shall be used with the device.

3.2 EUT ANTENNA

The EUT antenna is permanent attached antenna. It comply with the standard requirement.

3.3 CONDUCTED EMISSION MEASUREMENT

3.3.1 POWER LINE CONDUCTED EMISSION Limits (Frequency Range 150KHz-30MHz)

| FREQUENCY (MHz) | Class A (dBuV) | | Class B (dBuV) | | Standard |
|-----------------|----------------|---------|----------------|-----------|----------|
| | Quasi-peak | Average | Quasi-peak | Average | |
| 0.15 -0.5 | | | 66 - 56 * | 56 - 46 * | CISPR |
| 0.50 -5.0 | | | 56.00 | 46.00 | CISPR |
| 5.0 -30.0 | | | 60.00 | 50.00 | CISPR |

| | | | | | |
|-----------|--|--|-----------|-----------|--------|
| 0.15 -0.5 | | | 66 - 56 * | 56 - 46 * | LP002. |
| 0.50 -5.0 | | | 56.00 | 46.00 | LP002. |
| 5.0 -30.0 | | | 60.00 | 50.00 | LP002. |

Note:

- (1) The tighter limit applies at the band edges.
- (2) The limit of " * " marked band means the limitation decreases linearly with the logarithm of the frequency in the range.

The following table is the setting of the receiver

| Receiver Parameters | Setting |
|---------------------|----------|
| Attenuation | 10 dB |
| Start Frequency | 0.15 MHz |
| Stop Frequency | 30 MHz |
| IF Bandwidth | 9 kHz |

3.3.2 TEST PROCEDURE

- a. The EUT was placed 0.4 meters from the horizontal ground plane with EUT being connected to the power mains through a line impedance stabilization network (LISN). All other support equipments powered from additional LISN(s). The LISN provide 50 Ohm/ 50uH of coupling impedance for the measuring instrument.
- b. Interconnecting cables that hang closer than 40 cm to the ground plane shall be folded back and forth in the center forming a bundle 30 to 40 cm long.
- c. I/O cables that are not connected to a peripheral shall be bundled in the center. The end of the cable may be terminated, if required, using the correct terminating impedance. The overall length shall not exceed 1 m.
- d. LISN at least 80 cm from nearest part of EUT chassis.
- e. For the actual test configuration, please refer to the related Item –EUT Test Photos.

3.3.3 DEVIATION FROM TEST STANDARD

No deviation

3.3.4 TEST SETUP

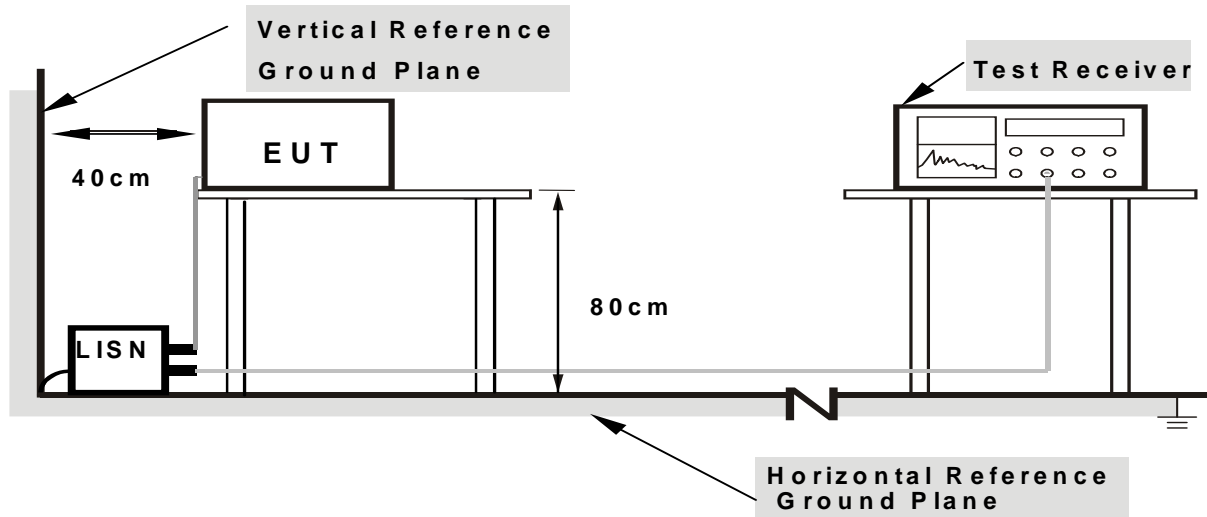

Note: 1. Support units were connected to second LISN.

2. Both of LISNs (AMN) are 80 cm from EUT and at least 80 cm from other units and other metal planes

3.2.5 TEST RESULT

| | | | |
|----------------|------------------------------------|---------------------|--------|
| EUT : | Bluetooth Speaker | Model Name : | Magic |
| Temperature : | 26 °C | Relative Humidity : | 54% |
| Pressure : | 1010hPa | Phase : | L |
| Test Voltage : | DC 15.0V from adapter AC 120V/60Hz | Test Mode : | Mode 1 |

| Frequency (MHz) | Reading Level (dBμV) | Correct Factor (dB) | Measure-ment (dBμV) | Limits (dBμV) | Margin (dB) | Remark |
|-----------------|----------------------|---------------------|---------------------|---------------|-------------|--------|
| 0.1620 | 45.29 | 9.62 | 54.91 | 65.36 | -10.45 | QP |
| 0.1620 | 28.48 | 9.62 | 38.10 | 55.36 | -17.26 | AVG |
| 0.5180 | 20.83 | 9.77 | 30.60 | 56.00 | -25.40 | QP |
| 0.5220 | 14.91 | 9.77 | 24.68 | 46.00 | -21.32 | AVG |
| 1.5620 | 27.66 | 9.68 | 37.34 | 56.00 | -18.66 | QP |
| 1.5620 | 26.72 | 9.68 | 36.40 | 46.00 | -9.60 | AVG |
| 4.8539 | 25.39 | 9.70 | 35.09 | 56.00 | -20.91 | QP |
| 4.8539 | 23.27 | 9.70 | 32.97 | 46.00 | -13.03 | AVG |
| 11.9059 | 29.97 | 9.75 | 39.72 | 60.00 | -20.28 | QP |
| 11.9059 | 25.37 | 9.75 | 35.12 | 50.00 | -14.88 | AVG |
| 18.0819 | 24.11 | 9.90 | 34.01 | 60.00 | -25.99 | QP |
| 18.0819 | 21.70 | 9.90 | 31.60 | 50.00 | -18.40 | AVG |

Remark:

1. All readings are Quasi-Peak and Average values.
2. Factor = Insertion Loss + Cable Loss.

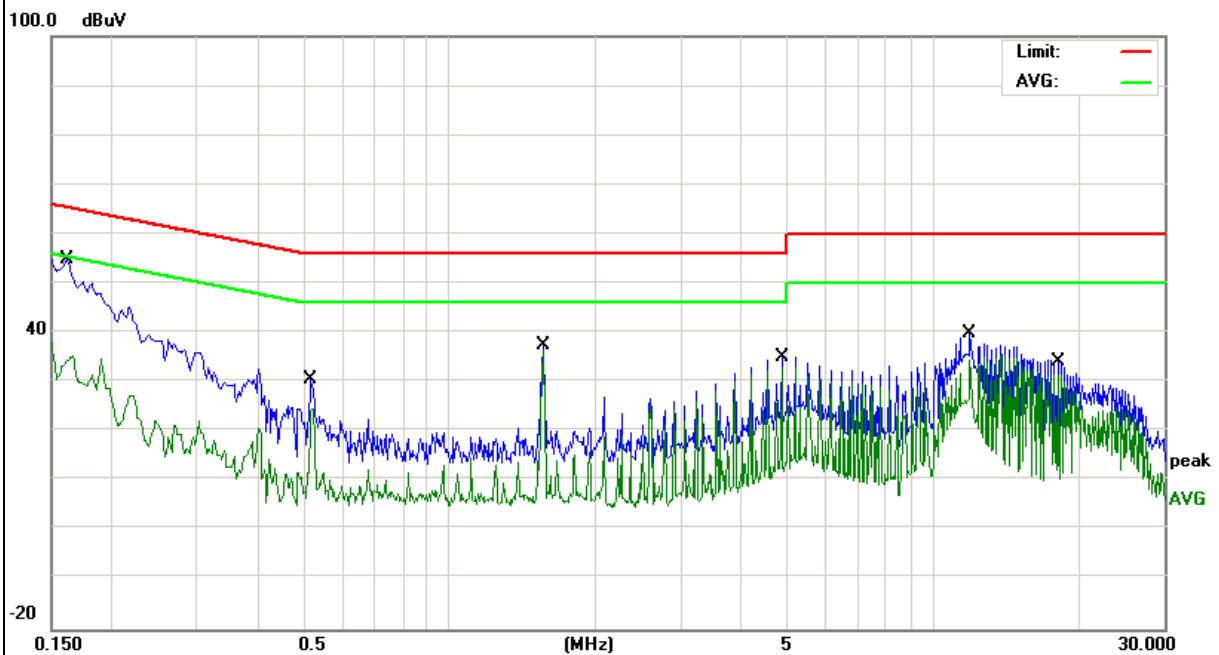

| | | | |
|----------------|------------------------------------|---------------------|--------|
| EUT : | Bluetooth Speaker | Model Name : | Magic |
| Temperature : | 26 °C | Relative Humidity : | 54% |
| Pressure : | 1010hPa | Phase : | N |
| Test Voltage : | DC 15.0V from adapter AC 120V/60Hz | Test Mode : | Mode 1 |

| Frequency (MHz) | Reading Level (dBμV) | Correct Factor (dB) | Measure-ment (dBμV) | Limits (dBμV) | Margin (dB) | Remark |
|-----------------|----------------------|---------------------|---------------------|---------------|-------------|--------|
| 0.1620 | 42.70 | 9.60 | 52.30 | 65.36 | -13.06 | QP |
| 0.1620 | 30.85 | 9.60 | 40.45 | 55.36 | -14.91 | AVG |
| 0.4020 | 30.92 | 9.64 | 40.56 | 57.81 | -17.25 | QP |
| 0.4020 | 25.18 | 9.64 | 34.82 | 47.81 | -12.99 | AVG |
| 0.5220 | 24.12 | 9.68 | 33.80 | 56.00 | -22.20 | QP |
| 0.5220 | 16.20 | 9.68 | 25.88 | 46.00 | -20.12 | AVG |
| 1.5740 | 27.84 | 9.57 | 37.41 | 56.00 | -18.59 | QP |
| 1.5740 | 27.13 | 9.57 | 36.70 | 46.00 | -9.30 | AVG |
| 4.8498 | 25.50 | 9.51 | 35.01 | 56.00 | -20.99 | QP |
| 4.8498 | 23.17 | 9.51 | 32.68 | 46.00 | -13.32 | AVG |
| 11.2139 | 29.21 | 9.68 | 38.89 | 60.00 | -21.11 | QP |
| 11.2139 | 23.43 | 9.68 | 33.11 | 50.00 | -16.89 | AVG |

Remark:

1. All readings are Quasi-Peak and Average values.
2. Factor = Insertion Loss + Cable Loss.

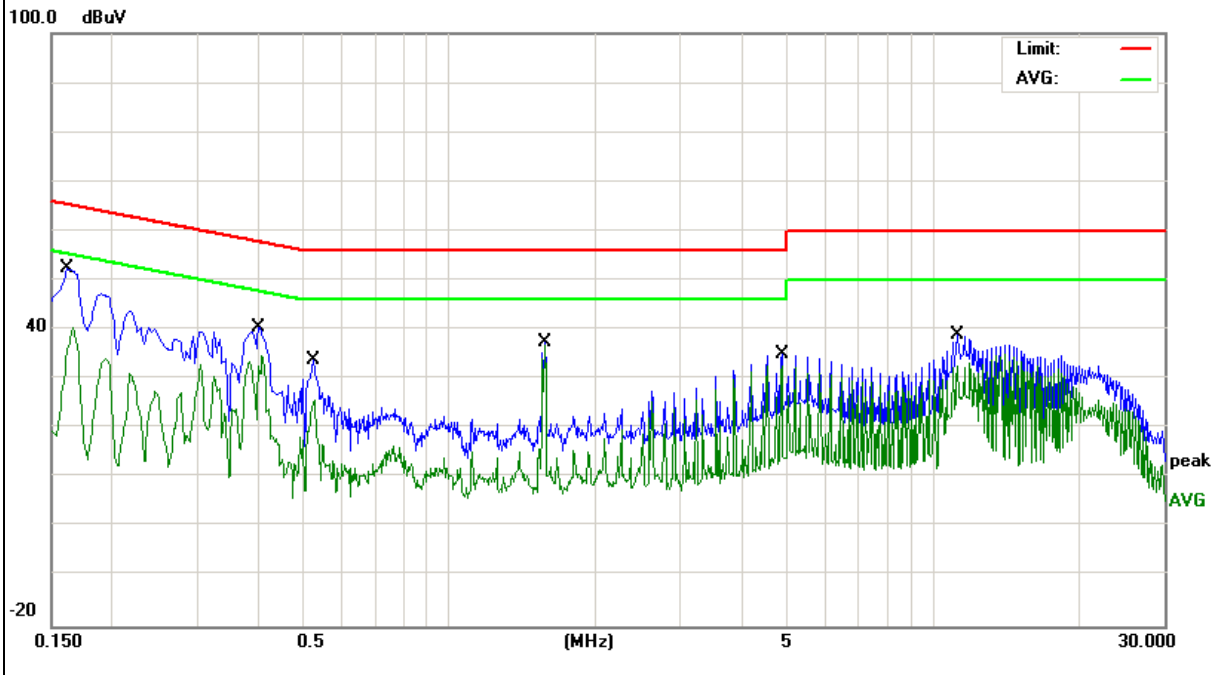

| | | | |
|----------------|------------------------------------|---------------------|--------|
| EUT : | Bluetooth Speaker | Model Name : | Magic |
| Temperature : | 26 °C | Relative Humidity : | 54% |
| Pressure : | 1010hPa | Phase : | L |
| Test Voltage : | DC 15.0V from adapter AC 240V/60Hz | Test Mode : | Mode 1 |

| Frequency (MHz) | Reading Level (dBμV) | Correct Factor (dB) | Measure-ment (dBμV) | Limits (dBμV) | Margin (dB) | Remark |
|-----------------|----------------------|---------------------|---------------------|---------------|-------------|--------|
| 0.1620 | 44.57 | 9.62 | 54.19 | 65.36 | -11.17 | QP |
| 0.1620 | 29.00 | 9.62 | 38.62 | 55.36 | -16.74 | AVG |
| 0.2139 | 19.53 | 9.63 | 29.16 | 53.05 | -23.89 | AVG |
| 0.2179 | 36.26 | 9.63 | 45.89 | 62.89 | -17.00 | QP |
| 0.5299 | 24.88 | 9.77 | 34.65 | 56.00 | -21.35 | QP |
| 0.5299 | 21.21 | 9.77 | 30.98 | 46.00 | -15.02 | AVG |
| 1.5780 | 31.99 | 9.68 | 41.67 | 56.00 | -14.33 | QP |
| 1.5780 | 31.17 | 9.68 | 40.85 | 46.00 | -5.15 | AVG |
| 5.1578 | 27.73 | 9.70 | 37.43 | 60.00 | -22.57 | QP |
| 5.1578 | 24.86 | 9.70 | 34.56 | 50.00 | -15.44 | AVG |
| 12.3018 | 34.27 | 9.76 | 44.03 | 60.00 | -15.97 | QP |
| 12.3018 | 30.72 | 9.76 | 40.48 | 50.00 | -9.52 | AVG |

Remark:

1. All readings are Quasi-Peak and Average values.
2. Factor = Insertion Loss + Cable Loss.

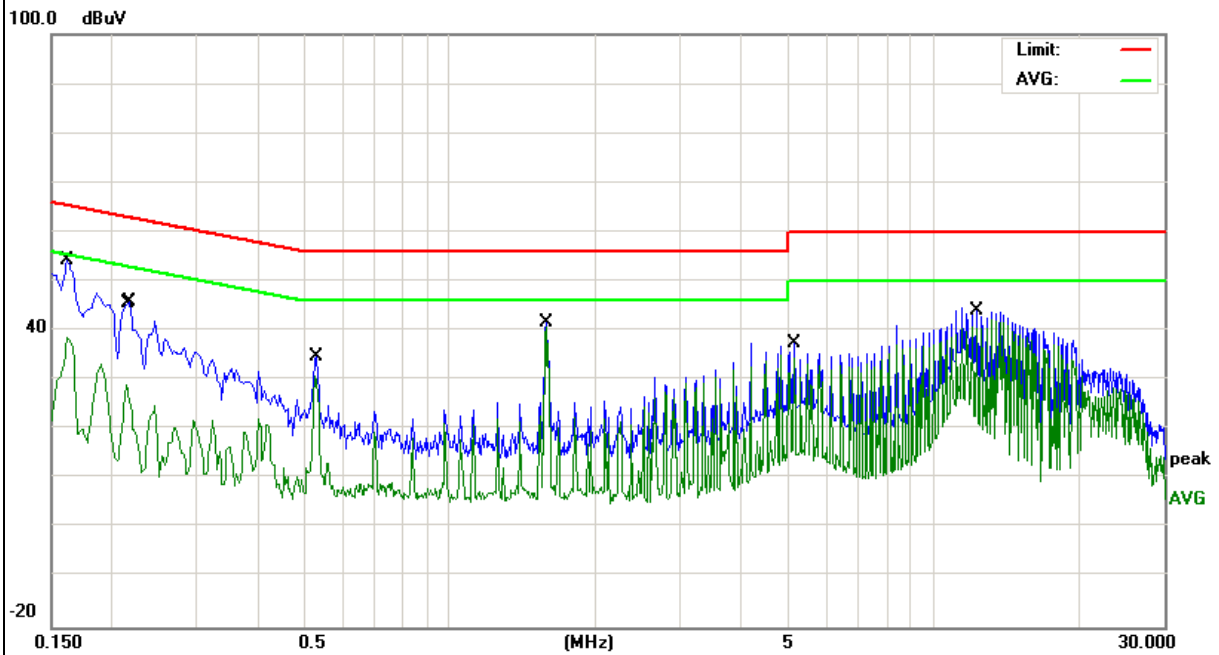

| | | | |
|----------------|------------------------------------|---------------------|--------|
| EUT : | Bluetooth Speaker | Model Name : | Magic |
| Temperature : | 26 °C | Relative Humidity : | 54% |
| Pressure : | 1010hPa | Phase : | N |
| Test Voltage : | DC 15.0V from adapter AC 240V/60Hz | Test Mode : | Mode 1 |

| Frequency (MHz) | Reading Level (dBμV) | Correct Factor (dB) | Measure-ment (dBμV) | Limits (dBμV) | Margin (dB) | Remark |
|-----------------|----------------------|---------------------|---------------------|---------------|-------------|--------|
| 0.1620 | 44.73 | 9.60 | 54.33 | 65.36 | -11.03 | QP |
| 0.1620 | 29.21 | 9.60 | 38.81 | 55.36 | -16.55 | AVG |
| 0.5299 | 26.29 | 9.68 | 35.97 | 56.00 | -20.03 | QP |
| 0.5299 | 26.77 | 9.68 | 36.45 | 46.00 | -9.55 | AVG |
| 1.5820 | 31.81 | 9.57 | 41.38 | 56.00 | -14.62 | QP |
| 1.5820 | 31.04 | 9.57 | 40.61 | 46.00 | -5.39 | AVG |
| 4.1898 | 26.96 | 9.51 | 36.47 | 56.00 | -19.53 | QP |
| 4.1898 | 23.30 | 9.51 | 32.81 | 46.00 | -13.19 | AVG |
| 11.1819 | 33.35 | 9.68 | 43.03 | 60.00 | -16.97 | QP |
| 11.1819 | 28.63 | 9.68 | 38.31 | 50.00 | -11.69 | AVG |
| 13.6980 | 33.33 | 9.73 | 43.06 | 60.00 | -16.94 | QP |
| 13.6980 | 31.80 | 9.73 | 41.53 | 50.00 | -8.47 | AVG |

Remark:

1. All readings are Quasi-Peak and Average values.
2. Factor = Insertion Loss + Cable Loss.

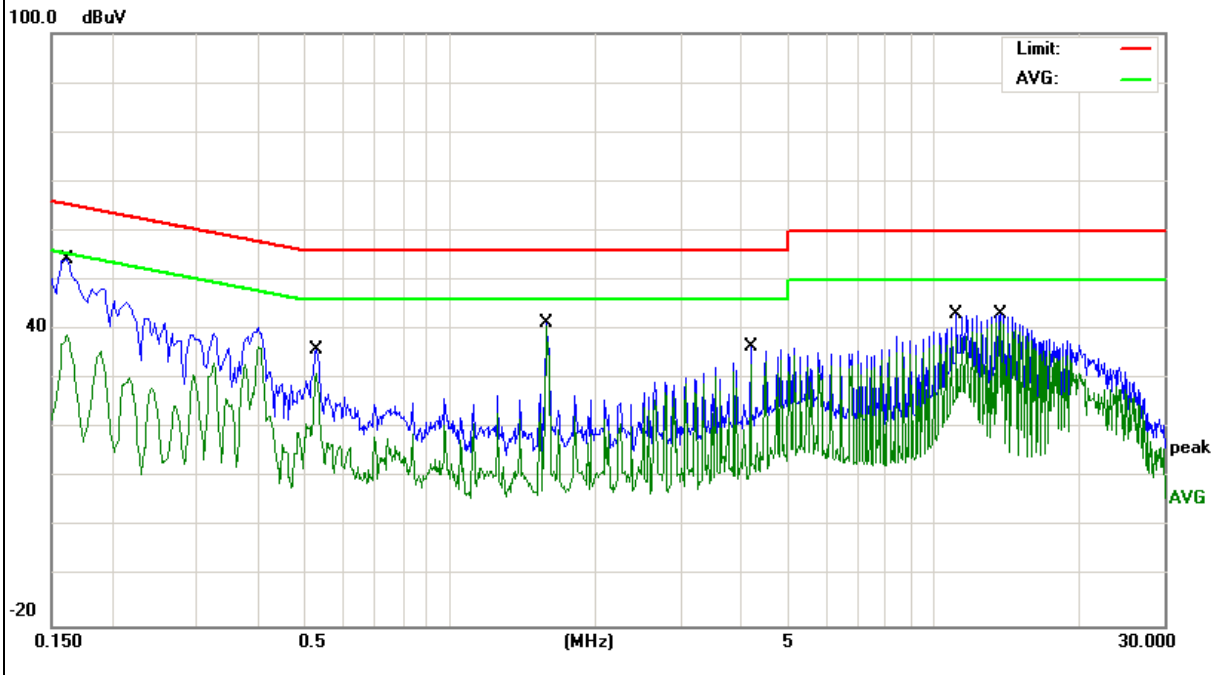

3.4 RADIATED EMISSION MEASUREMENT

3.4.1 Radiated Emission Limits (FCC 15.209)

| Frequencies (MHz) | Field Strength (micorvolts/meter) | Measurement Distance (meters) |
|-------------------|-----------------------------------|-------------------------------|
| 0.009~0.490 | 2400/F(KHz) | 300 |
| 0.490~1.705 | 24000/F(KHz) | 30 |
| 1.705~30.0 | 30 | 30 |
| Frequency (MHz) | Limit (dBuV) | |
| 30~88 | 40 | 3 |
| 88~216 | 43.5 | 3 |
| 216~960 | 46 | 3 |
| 960 -10000 | 54.00 | 3 |
| *902 - 928 | 94.00 | 3 |

Note:

- (1) The tighter limit applies at the band edges.
- (2) Emission level (dBuV/m)=20log Emission level (uV/m).
- (3) *Note: This is the limit for the fundamental frequency.

LIMITS OF RADIATED EMISSION MEASUREMENT (FCC 15.249)

| Frequency of Emission (MHz) | Field Strength of fundamental ((millivolts /meter) | Field Strength of Harmonics (microvolts/meter) |
|-----------------------------|--|--|
| 902-928 | 50 | 500 |

Notes:

- (1) Emissions radiated outside of the specified frequency bands, except for harmonics, shall be attenuated by at least 50 dB below the level of the fundamental or to the general radiated emission limits in Section 15.209, whichever is the lesser attenuation.

| Spectrum Parameter | Setting |
|---------------------------------------|-----------------------|
| Attenuation | Auto |
| Start Frequency | 1000 MHz |
| Stop Frequency | 10th carrier harmonic |
| RB / VB (emission in restricted band) | 1MHz / 1MHz for Peak |

| Receiver Parameter | Setting |
|------------------------|----------------------------------|
| Attenuation | Auto |
| Start ~ Stop Frequency | 9kHz~150kHz / RB 200Hz for QP |
| Start ~ Stop Frequency | 150kHz~30MHz / RB 9kHz for QP |
| Start ~ Stop Frequency | 30MHz~1000MHz / RB 120kHz for QP |

3.4.2 TEST PROCEDURE

- a. The measuring distance of at 3 m shall be used for measurements at frequency up to 1GHz. For frequencies above 1GHz, any suitable measuring distance may be used.
- b. The EUT was placed on the top of a rotating table 0.8 m for below 1GHz and 1.5m for above 1GHz the ground at a 3 meter open area test site. The table was rotated 360 degrees to determine the position of the highest radiation.
- c. The height of the equipment or of the substitution antenna shall be 0.8 m for below 1GHz and 1.5m for above 1GHz; the height of the test antenna shall vary between 1 m to 4 m. Both horizontal and vertical polarizations of the antenna are set to make the measurement.
- d. The initial step in collecting conducted emission data is a spectrum analyzer peak detector mode pre-scanning the measurement frequency range. Significant peaks are then marked and then Quasi Peak detector mode re-measured.
- e. If the Peak Mode measured value compliance with and lower than Quasi Peak Mode Limit, the EUT shall be deemed to meet QP Limits and then no additional QP Mode measurement performed.
- f. For the actual test configuration, please refer to the related Item –EUT Test Photos.

Note:

Both horizontal and vertical antenna polarities were tested and performed pretest to three orthogonal axis. The worst case emissions were reported

3.4.3 DEVIATION FROM TEST STANDARD

No deviation

3.4.4 TEST SETUP

(A) Radiated Emission Test-Up Frequency Below 30MHz

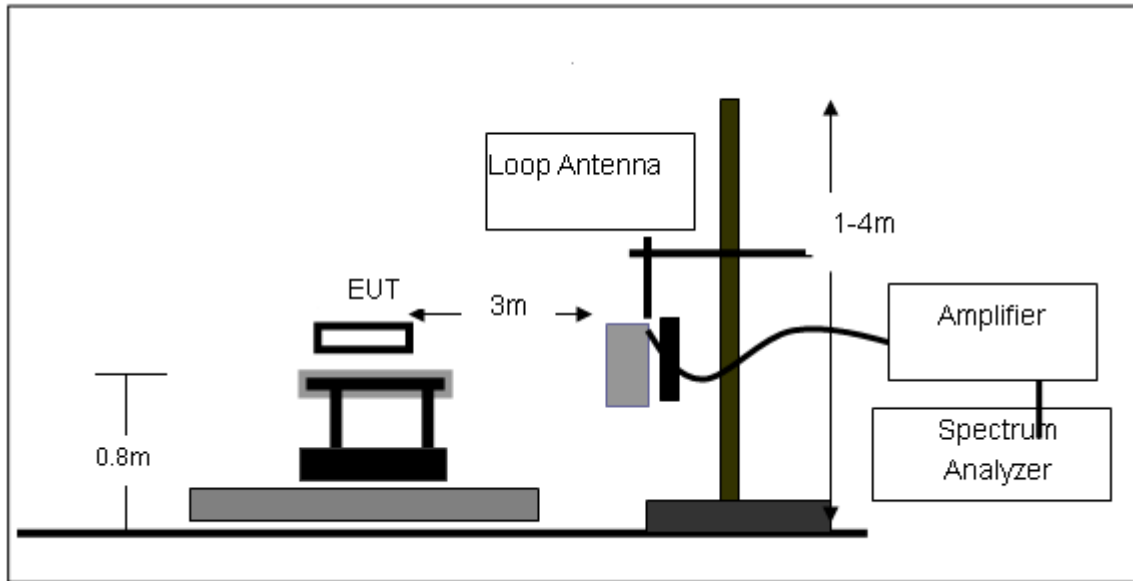

(B) Radiated Emission Test-Up Frequency 30MHz~1GHz

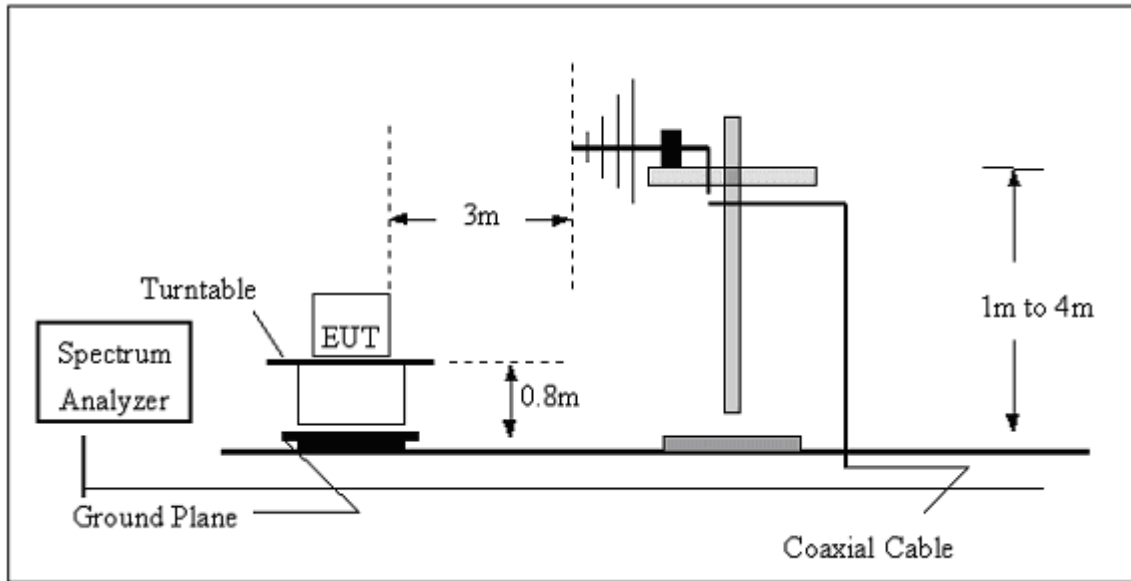

(C) Radiated Emission Test-Setup Frequency Above 1GHz

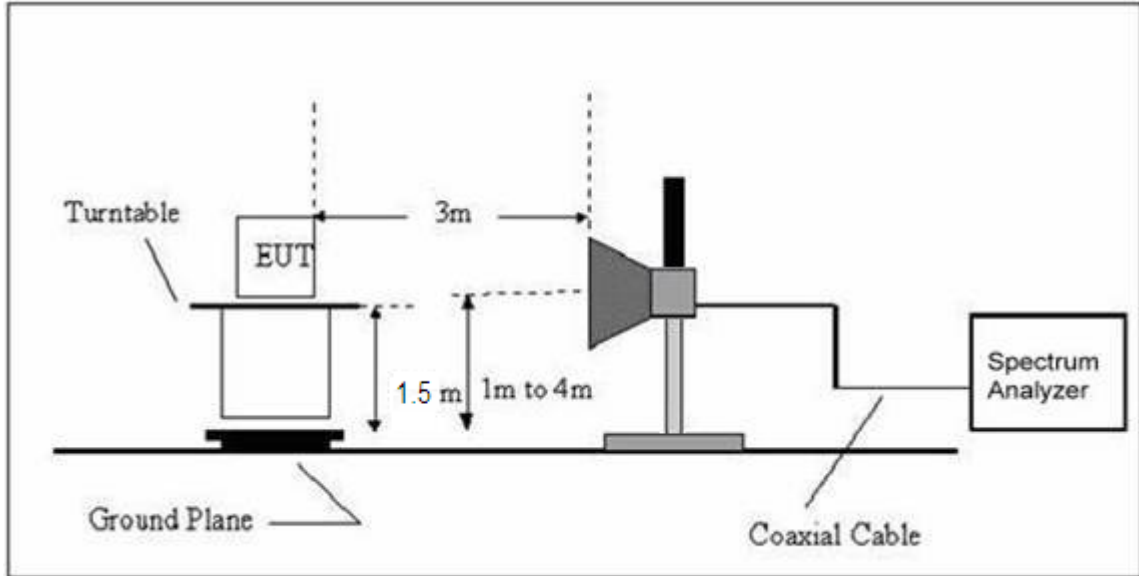

3.4.5 TEST RESULTS (BLOW 30MHz)

| | | | |
|---------------|-------------------|---------------------|---------|
| EUT : | Bluetooth Speaker | Model Name. : | Magic |
| Temperature : | 20 °C | Relative Humidity : | 48% |
| Pressure : | 1010 hPa | Test Voltage : | DC 3.7V |
| Test Mode : | TX | Polarization : | -- |

| Freq. | Reading | Limit | Margin | State |
|-------|----------|----------|--------|-------|
| (MHz) | (dBuV/m) | (dBuV/m) | (dB) | P/F |
| -- | -- | -- | -- | PASS |
| -- | -- | -- | -- | PASS |

NOTE:

The amplitude of spurious emissions which are attenuated by more than 20dB below the permissible value has no need to be reported.

Distance extrapolation factor = $20 \log (\text{specific distance}/\text{test distance})(\text{dB})$;

Limit line = specific limits(dBuv) + distance extrapolation factor.

3.4.6 TEST RESULTS (BETWEEN 30 – 1000 MHZ)

| | | | |
|---------------|-------------------|---------------------|----------|
| EUT : | Bluetooth Speaker | Model Name : | Magic |
| Temperature : | 20 °C | Relative Humidity : | 48% |
| Pressure : | 1010 hPa | Test Voltage : | DC 3.7V |
| Test Mode : | TX 915MHz | Polarization : | Vertical |

| Frequency (MHz) | Meter Reading (dBμV) | Factor (dB) | Emission Level (dBμV/m) | Limits (dBμV/m) | Margin (dB) | Detector Type |
|-----------------|----------------------|-------------|-------------------------|-----------------|-------------|---------------|
| 204.9550 | 10.14 | 11.57 | 21.71 | 43.50 | -21.79 | QP |
| 239.1473 | 10.46 | 10.73 | 21.19 | 46.00 | -24.81 | QP |
| 281.9945 | 13.04 | 11.90 | 24.94 | 46.00 | -21.06 | QP |
| 818.8341 | 15.27 | 23.07 | 38.34 | 46.00 | -7.66 | QP |
| 866.0878 | 17.25 | 23.60 | 40.85 | 46.00 | -5.15 | QP |

Remark:

1. Factor = Antenna Factor + Cable Loss – Pre-amplifier.

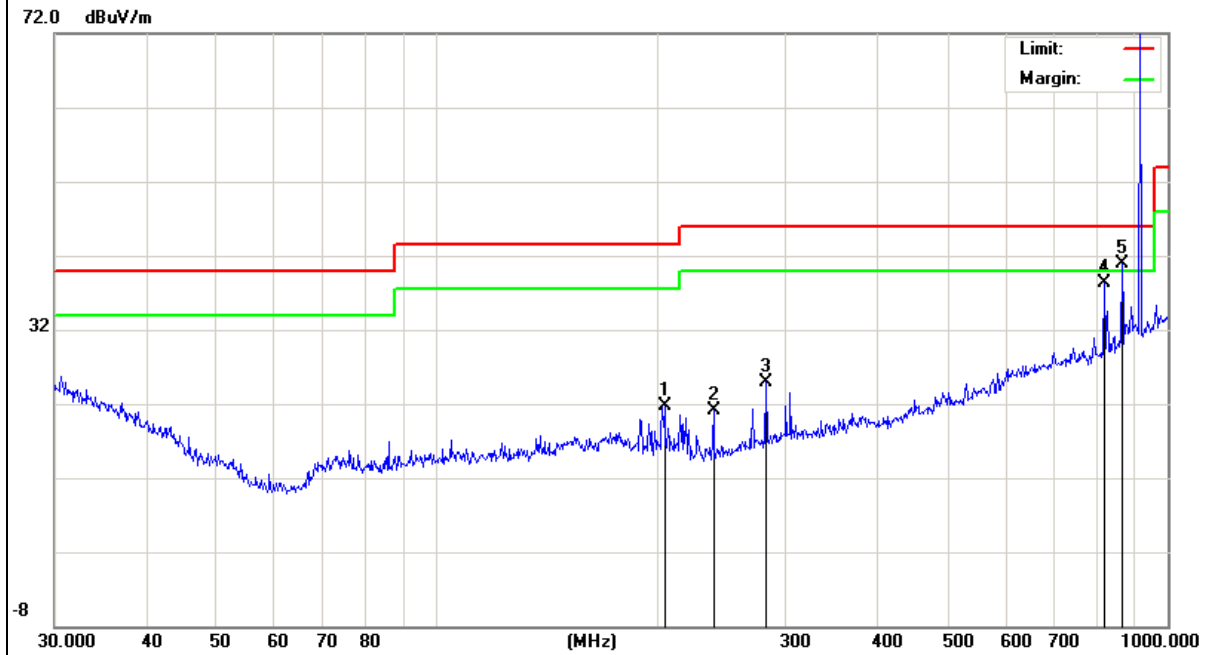

| | | | |
|---------------|-------------------|---------------------|------------|
| EUT : | Bluetooth Speaker | Model Name : | Magic |
| Temperature : | 20 °C | Relative Humidity : | 48% |
| Pressure : | 1010 hPa | Test Voltage : | DC 3.7V |
| Test Mode : | TX 915MHz | Polarization : | Horizontal |

| Frequency (MHz) | Meter Reading (dBµV) | Factor (dB) | Emission Level (dBµV/m) | Limits (dBµV/m) | Margin (dB) | Detector Type |
|-----------------|----------------------|-------------|-------------------------|-----------------|-------------|---------------|
| 221.3920 | 10.65 | 10.86 | 21.51 | 46.00 | -24.49 | QP |
| 270.3747 | 21.42 | 11.61 | 33.03 | 46.00 | -12.97 | QP |
| 319.9370 | 13.54 | 13.21 | 26.75 | 46.00 | -19.25 | QP |
| 744.8660 | 12.52 | 22.04 | 34.56 | 46.00 | -11.44 | QP |
| 818.8341 | 15.62 | 23.07 | 38.69 | 46.00 | -7.31 | QP |
| 866.0878 | 16.28 | 23.60 | 39.88 | 46.00 | -6.12 | QP |

Remark:

1. Factor = Antenna Factor + Cable Loss – Pre-amplifier.

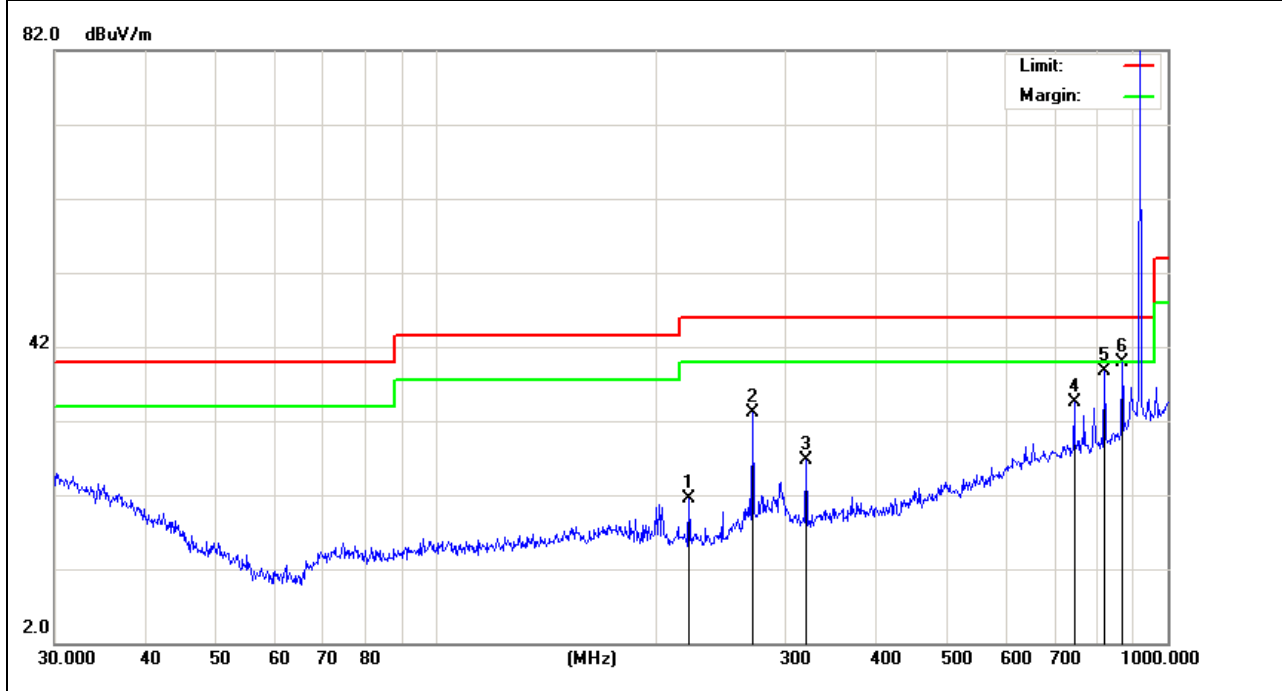

3.4.7 TEST RESULTS (ABOVE 1000 MHZ)

| | | | |
|---------------|-------------------|---------------------|------------|
| EUT : | Bluetooth Speaker | Model Name : | Magic |
| Temperature : | 20 °C | Relative Humidity : | 48% |
| Pressure : | 1010 hPa | Test Voltage : | DC 3.7V |
| Test Mode : | TX 915MHz | Polarization : | Horizontal |

| Frequency (MHz) | Meter Reading (dBμV) | Factor (dB) | Emission Level (dBμV/m) | Limits (dBμV/m) | Margin (dB) | Detector Type |
|-----------------|----------------------|-------------|-------------------------|-----------------|-------------|---------------|
| 1832.142 | 59.79 | -9.67 | 50.12 | 74 | -23.88 | peak |
| 1832.142 | 50.11 | -9.67 | 40.44 | 54 | -13.56 | AVG |
| 2748.157 | 59.23 | -6.16 | 53.07 | 74 | -20.93 | peak |
| 2748.157 | 49.66 | -6.16 | 43.5 | 54 | -10.5 | AVG |
| 5496.201 | 49.95 | 1.19 | 51.14 | 74 | -22.86 | peak |
| 5496.201 | 40.95 | 1.19 | 42.14 | 54 | -11.86 | AVG |

Remark:
 Factor = Antenna Factor + Cable Loss – Pre-amplifier.
 No emission above 18GHz.

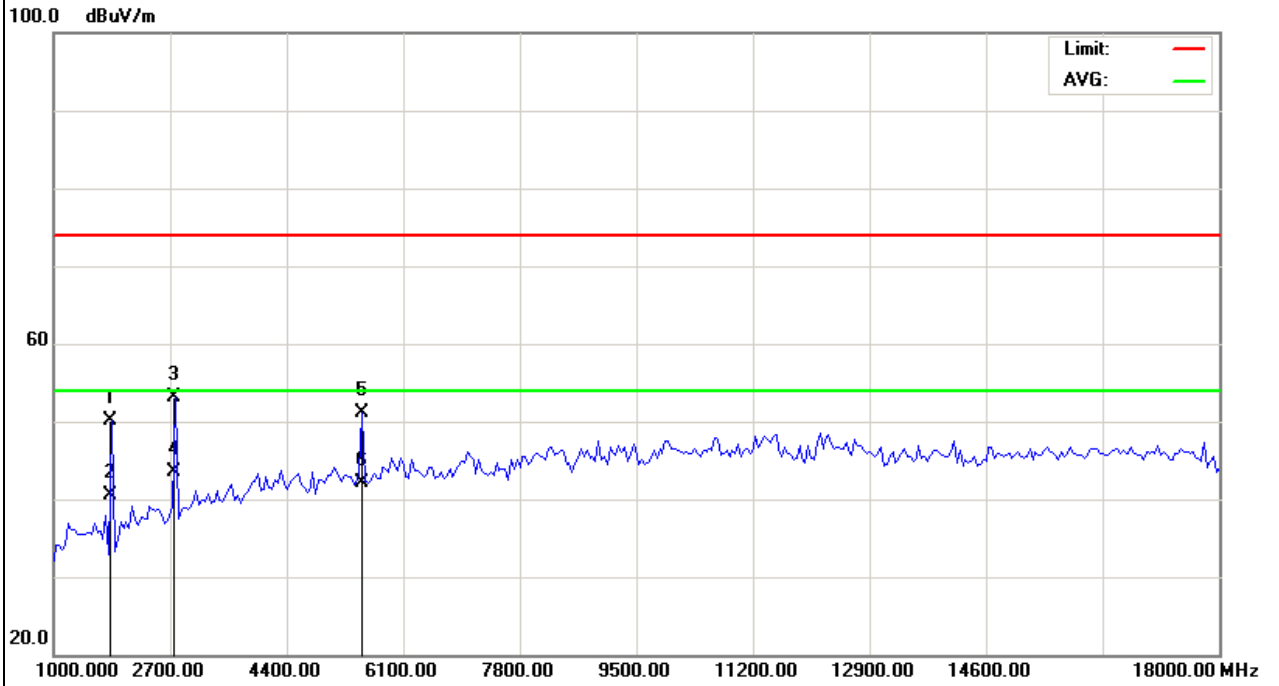

| | | | |
|---------------|-------------------|---------------------|----------|
| EUT : | Bluetooth Speaker | Model Name : | Magic |
| Temperature : | 20 °C | Relative Humidity : | 48% |
| Pressure : | 1010 hPa | Test Voltage : | DC 3.7V |
| Test Mode : | TX 915MHz | Polarization : | Vertical |

| Frequency (MHz) | Meter Reading (dBμV) | Factor (dB) | Emission Level (dBμV/m) | Limits (dBμV/m) | Margin (dB) | Detector Type |
|-----------------|----------------------|-------------|-------------------------|-----------------|-------------|---------------|
| 1832.095 | 59.29 | -9.67 | 49.62 | 74 | -24.38 | peak |
| 1832.095 | 48.66 | -9.67 | 38.99 | 54 | -15.01 | AVG |
| 2748.142 | 59.12 | -6.16 | 52.96 | 74 | -21.04 | peak |
| 2748.142 | 47.11 | -6.16 | 40.95 | 54 | -13.05 | AVG |
| 5496.117 | 51.1 | 1.19 | 52.29 | 74 | -21.71 | peak |
| 5496.117 | 40.55 | 1.19 | 41.74 | 54 | -12.26 | AVG |

Remark:

Factor = Antenna Factor + Cable Loss – Pre-amplifier.

No emission above 18GHz.

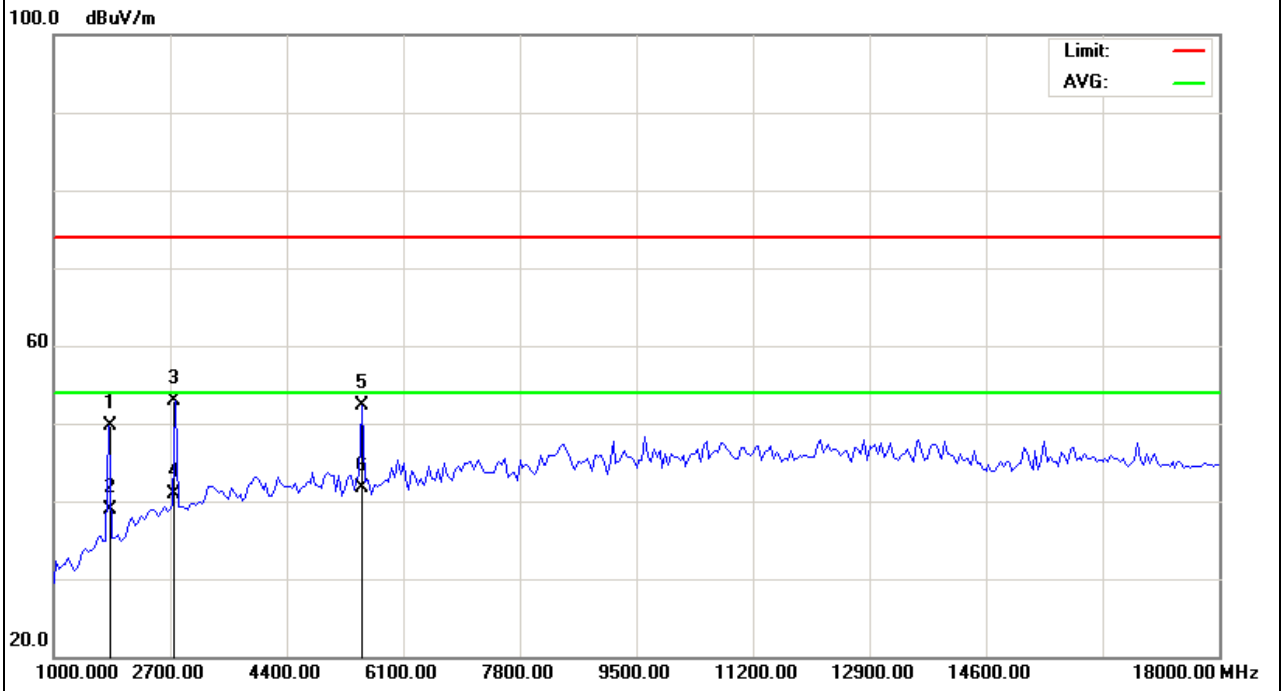

3.4.8 TEST RESULTS (RESTRICTED BANDS REQUIREMENTS)

| | | | |
|---------------|-------------------|---------------------|----------|
| EUT : | Bluetooth Speaker | Model Name : | Magic |
| Temperature : | 20 °C | Relative Humidity : | 48% |
| Pressure : | 1010 hPa | Test Voltage : | DC 3.7V |
| Test Mode : | TX 915MHz | Polarization : | Vertical |

| Frequency (MHz) | Meter Reading (dBμV) | Factor (dB) | Emission Level (dBμV/m) | Limits (dBμV/m) | Margin (dB) | Detector Type |
|-----------------|----------------------|-------------|-------------------------|-----------------|-------------|---------------|
| 902.0000 | 8.09 | 24.16 | 32.25 | 46.00 | -13.75 | QP |
| 928.0000 | 6.97 | 25.29 | 32.26 | 46.00 | -13.74 | QP |

Remark:
Factor = Antenna Factor + Cable Loss – Pre-amplifier.

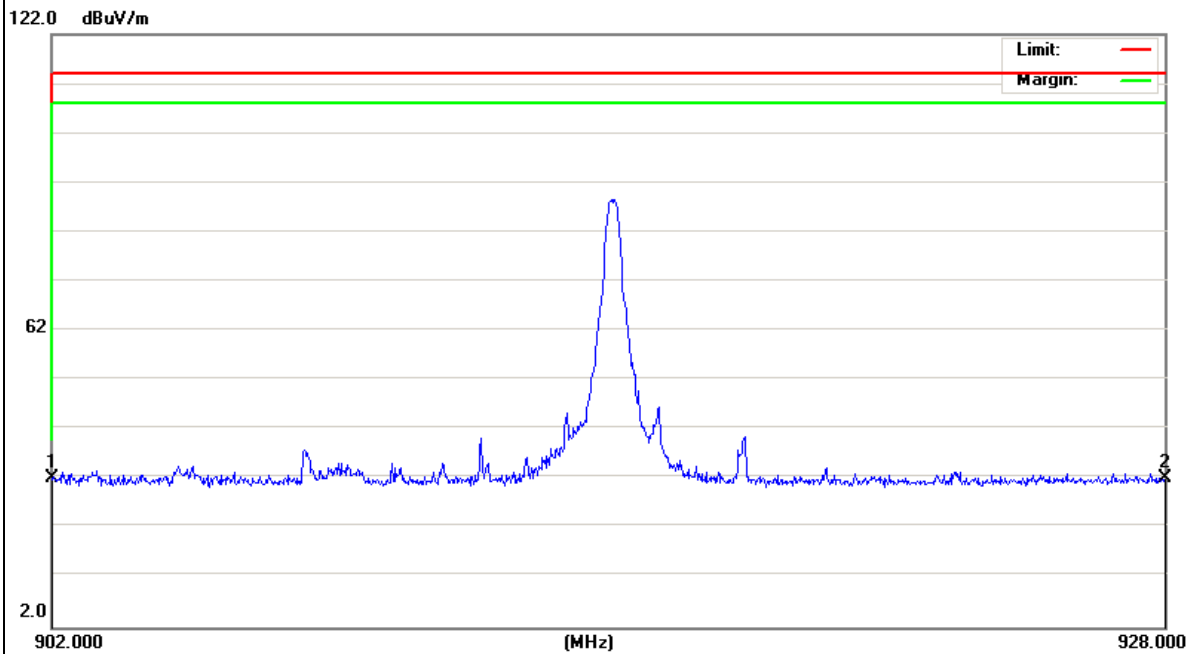

| | | | |
|---------------|-------------------|---------------------|------------|
| EUT : | Bluetooth Speaker | Model Name : | Magic |
| Temperature : | 20 °C | Relative Humidity : | 48% |
| Pressure : | 1010 hPa | Test Voltage : | DC 3.7V |
| Test Mode : | TX 915MHz | Polarization : | Horizontal |

| Frequency (MHz) | Meter Reading (dBμV) | Factor (dB) | Emission Level (dBμV/m) | Limits (dBμV/m) | Margin (dB) | Detector Type |
|-----------------|----------------------|-------------|-------------------------|-----------------|-------------|---------------|
| 902.0000 | 7.31 | 24.16 | 31.47 | 46.00 | -14.53 | QP |
| 928.0000 | 6.81 | 25.29 | 32.10 | 46.00 | -13.90 | QP |

Remark:
Factor = Antenna Factor + Cable Loss – Pre-amplifier.

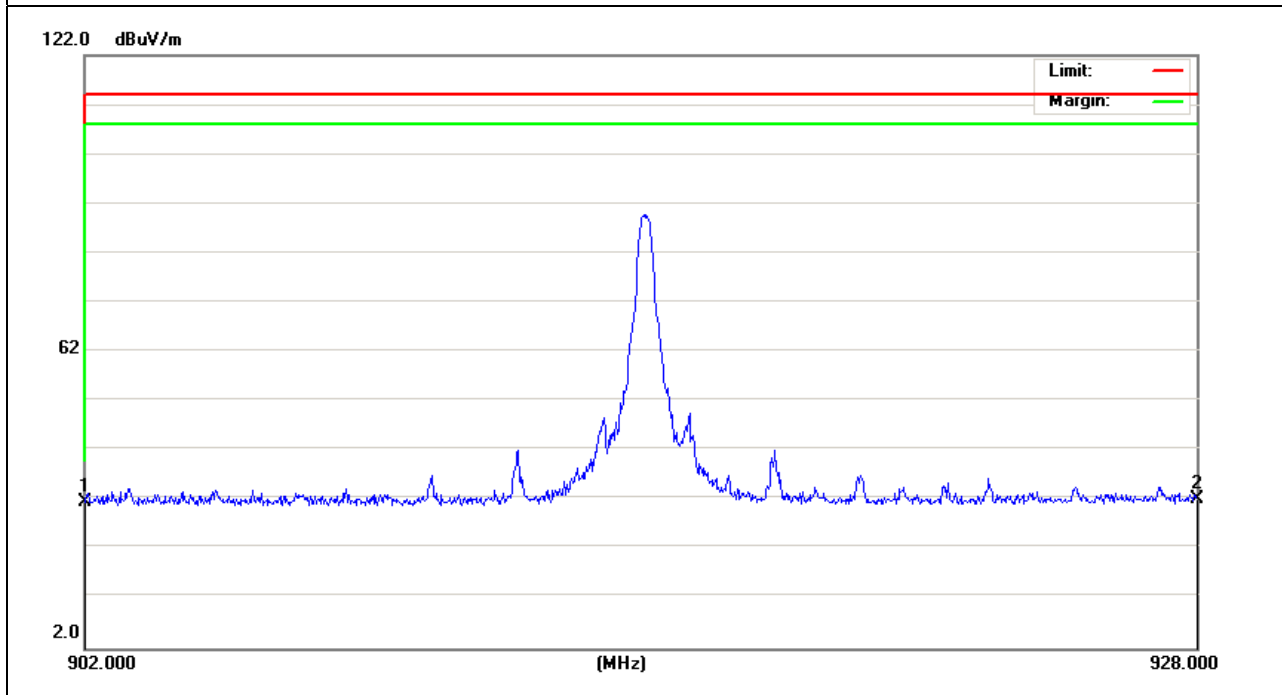

4. BANDWIDTH TEST

4.1 TEST PROCEDURE

- a. The EUT was directly connected to the spectrum analyzer and antenna output port as show in the block diagram below,
- b. Spectrum Setting : RBW= 100KHz, VBW \geq RBW, Sweep time = Auto.

4.2 DEVIATION FROM STANDARD

No deviation.

4.3 TEST SETUP



4.4 TEST RESULTS

| | | | |
|---------------|-------------------|---------------------|---------|
| EUT : | Bluetooth Speaker | Model Name : | Magic |
| Temperature : | 26 °C | Relative Humidity : | 53% |
| Pressure : | 1020 hPa | Test Power : | DC 3.7V |
| Test Mode : | TX 915MHz | | |

| Test Channel | Frequency (MHz) | 20 dBc Bandwidth (MHz) |
|--------------|-----------------|------------------------|
| CH1 | 915 | 0.446 |

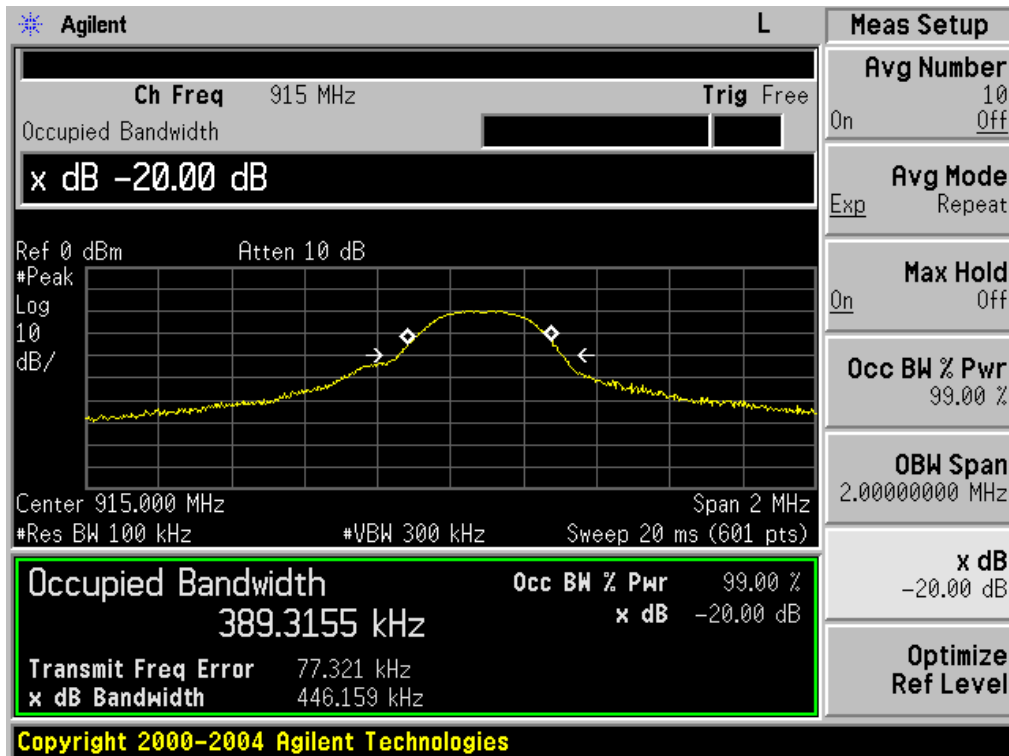

5. EUT TEST PHOTO

Radiated Measurement Photos



CONDUCTED EMISSION Photos

