

Insta360™ Pro 2

QUICKSTART GUIDE + PRODUCT INTRODUCTION



Scan to learn more about the product
<https://www.insta360.com/r/pro2detail>

1 Insta360 Pro 2 Panoramic Camera

1.1 Insta360 Pro 2 Overview

EN

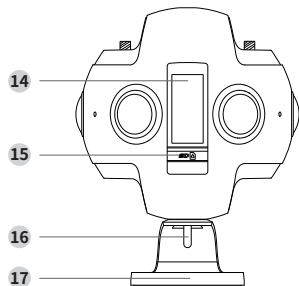
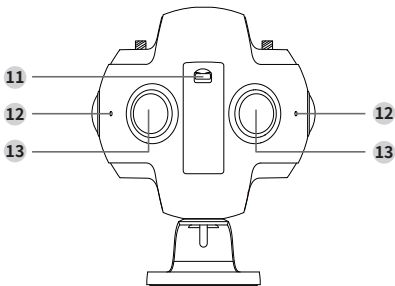
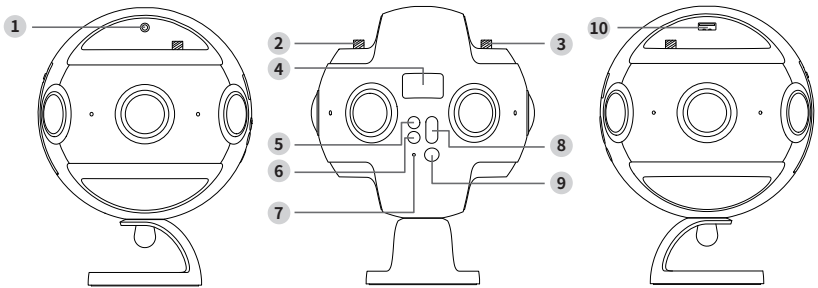

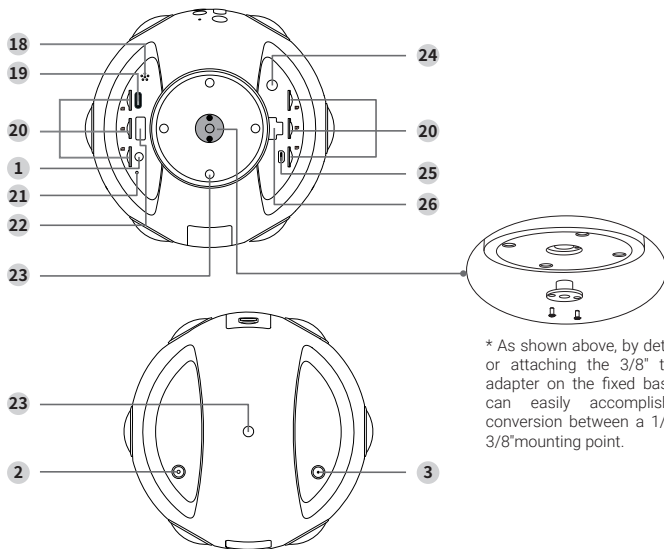

* As shown above, by detaching or attaching the 3/8" to 1/4" adapter on the fixed base, you can easily accomplish the conversion between a 1/4" and 3/8" mounting point.

- | | | | |
|----|---|----|------------------------------|
| 1 | 3.5mm Audio input port × 2 | 14 | Battery slot |
| 2 | GPS antenna | 15 | SD card slot |
| 3 | WiFi (AP) antenna | 16 | Bolt |
| 4 | OLED display | 17 | Fixed base |
| 5 | Return button | 18 | Speaker |
| 6 | Setting button | 19 | USB Type-C port |
| 7 | Power indicator | 20 | MicroSD card slot × 6 |
| 8 | Switch button | 21 | Reset pinhole |
| 9 | Power/Enter button | 22 | USB 3.0 port |
| 10 | USB 2.0 port | 23 | Standard 1/4" mounting point |
| 11 | Battery hatch release | 24 | DC power Input port |
| 12 | Microphone/Operation status indicator × 4 | 25 | HDMI 2.0 Type D port |
| 13 | Lens × 6 | 26 | LAN port |

1.2 Specifications

| Items | Parameters |
|--|--|
| Lens | 200° F2.4 fish-eye lens |
| Max. resolution of still image from single lens | 4000 x 3000 (In-camera stitched panorama at maximum of 8K, 3D or mono) |
| Max. resolution of video from single lens in 360° panoramic mode | 3840 x 2160 (Stitched panorama at maximum 8K mono) |
| Max. resolution of video from single lens in 360° 3D mode | 3840 x 2880 (Stitched panorama at maximum 8K 3D) |
| Battery capacity | 5100 mAh detachable lithium battery |
| Use time on full charge | 75 min |
| Input | 12 V / 5 A |
| Weight (with battery) | About 1.362 kg |
| Dimensions | φ143 mm |

2 Before You Start

① Before using the camera, please insert the rechargeable lithium polymer battery. Please connect the the power adapter in case of low or depleted battery.

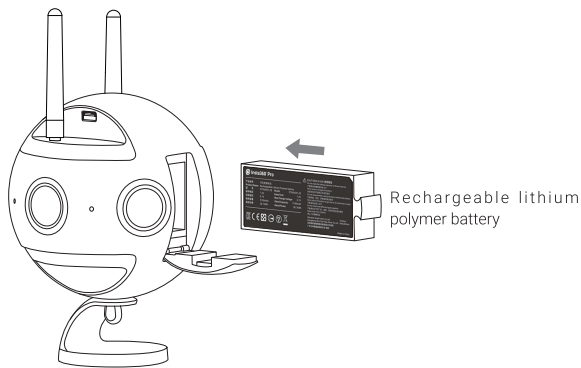

② Before using the camera, please insert 6 MicroSD cards, and insert an SD card or connect to an external USB 3.0 mobile hard disk (SSD mobile hard disk is recommended).

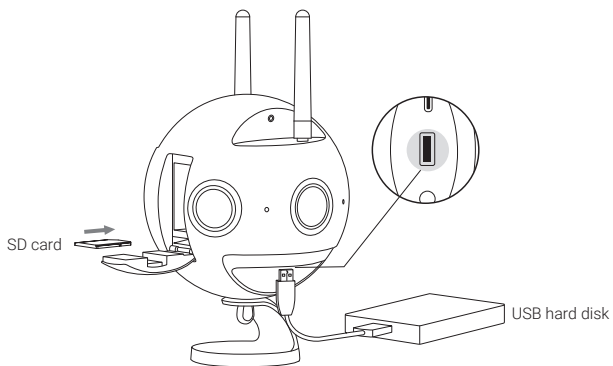
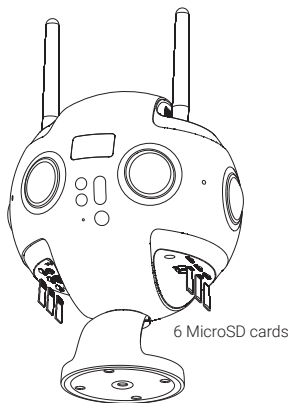

3 Official App

Scan the QR code below or visit https://www.insta360.com/r/download_insta360pro2 to download Insta360 Pro 2's official control app.



4 Remote Connection

After the camera connects to a wired/wireless network, it can be controlled remotely by the accompanying control software.

4.1 Wired Connection

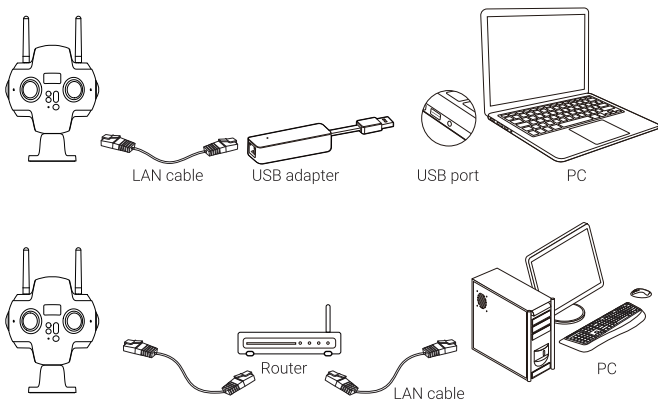

4.2 Wireless Connection

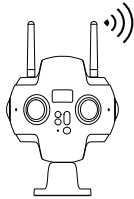
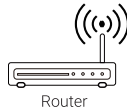
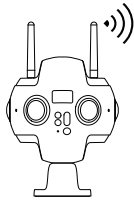

* Notice of further updates of this manual will not be issued.

This device complies with part 15 of the FCC Rules. Operation is subject to the following two conditions:

(1) This device may not cause harmful interference, and (2) this must accept any interference received, including interference that may cause undesired operation.

Any Charges or modifications not expressly approved by the party responsible for compliance could void the user's authority to operate the equipment.

Note: This equipment has been tested and found to comply with the limits for a Class B digital device, pursuant to part 15 of the FCC Rules. These limits are designed to provide reasonable protection against harmful interference in a residential installation. This equipment generates uses and can radiate radio frequency energy and, if not installed and used in accordance with the instructions, may cause harmful interference to radio communications. However, there is no guarantee that interference will not occur a particular installation. If this equipment does cause harmful interference to radio or television reception, which can be determined by turning the equipment off and on, the user is encouraged to try to correct the interference by one or more of the following measures:

- Reorient or relocate the receiving antenna.
- Increase the separation between the equipment and receiver.
- Connect the equipment into an outlet on a circuit different from that to which the receiver is connected.
- Consult the dealer or an experienced radio / TV technician for help.

This equipment complies with FCC radiation exposure limits set forth for an uncontrolled environment. This equipment should be installed and operated with minimum distance 20cm between the radiator & your body.

5.15-5.25GHz Band

Operations in the 5.15-5.25GH band are restricted to indoor use only.



IP-QS2-CM.1

Shenzhen Arashi Vision Company Limited

TEL (+86) 400-833-4360
EMAIL service@insta360.com
WEB www.insta360.com
ADD 6/F, Building A, Logan Century Center, 23 Haixiu Road,
Bao'an District, Shenzhen, China

