

# FCC Radio Test Report

## FCC ID: 2AFSGMA-2241

### Original Grant

**Report No.** : TB-FCC146995  
**Applicant** : Dongguan Jin wen hua digital technology Co., LTD.  
**Equipment Under Test (EUT)**  
**EUT Name** : Bluetooth speaker  
**Model No.** : MA-2241  
**Series Model No.** : A6  
**Brand Name** : N/A  
**Receipt Date** : 2016-03-04  
**Test Date** : 2016-03-04 to 2016-03-10  
**Issue Date** : 2016-03-11  
**Standards** : FCC Part 15: 2015, Subpart C(15.247)  
**Test Method** : ANSI C63.10: 2013  
**Conclusions** : **PASS**

In the configuration tested, the EUT complied with the standards specified above,  
The EUT technically complies with the FCC requirements

**Test/Witness Engineer** :

*WAN SU*

**Approved & Authorized** :

*Ray Shi*



This report details the results of the testing carried out on one sample. The results contained in this test report do not relate to other samples of the same product. The manufacturer should ensure that all products in series production are in conformity with the product sample detailed in the report.

---

---

## Contents

<b>CONTENTS</b> .....	<b>2</b>
<b>1. GENERAL INFORMATION ABOUT EUT</b> .....	<b>4</b>
1.1 Client Information.....	4
1.2 General Description of EUT (Equipment Under Test) .....	4
1.3 Block Diagram Showing the Configuration of System Tested.....	5
1.4 Description of Support Units .....	6
1.5 Description of Test Mode.....	6
1.6 Description of Test Software Setting .....	7
1.7 Measurement Uncertainty .....	7
1.8 Test Facility.....	8
<b>2. TEST SUMMARY</b> .....	<b>9</b>
<b>3. TEST EQUIPMENT</b> .....	<b>10</b>
<b>4. CONDUCTED EMISSION TEST</b> .....	<b>11</b>
4.1 Test Standard and Limit.....	11
4.2 Test Setup.....	11
4.3 Test Procedure.....	11
4.4 EUT Operating Mode .....	12
4.5 Test Data.....	12
<b>5. RADIATED EMISSION TEST</b> .....	<b>17</b>
5.1 Test Standard and Limit.....	17
5.2 Test Setup.....	18
5.3 Test Procedure.....	19
5.4 EUT Operating Condition .....	19
<b>6. RESTRICTED BANDS REQUIREMENT</b> .....	<b>38</b>
6.1 Test Standard and Limit.....	38
6.2 Test Setup.....	38
6.3 Test Procedure.....	38
6.4 EUT Operating Condition .....	39
6.4 Test Data.....	39
<b>7. NUMBER OF HOPPING CHANNEL</b> .....	<b>52</b>
7.1 Test Standard and Limit.....	52
7.2 Test Setup.....	52
7.3 Test Procedure.....	52
7.4 EUT Operating Condition .....	52
7.5 Test Data.....	52
<b>8. AVERAGE TIME OF OCCUPANCY</b> .....	<b>54</b>
8.1 Test Standard and Limit.....	54
8.2 Test Setup.....	54
8.3 Test Procedure.....	54

---

8.4 EUT Operating Condition .....	54
8.5 Test Data.....	55
<b>9. CHANNEL SEPARATION AND BANDWIDTH TEST .....</b>	<b>73</b>
9.1 Test Standard and Limit.....	73
9.2 Test Setup.....	73
9.3 Test Procedure.....	73
9.4 EUT Operating Condition .....	73
9.5 Test Data.....	74
<b>10. PEAK OUTPUT POWER TEST.....</b>	<b>86</b>
10.1 Test Standard and Limit .....	86
10.2 Test Setup.....	86
10.3 Test Procedure.....	86
10.4 EUT Operating Condition .....	86
10.5 Test Data.....	87
<b>11. ANTENNA REQUIREMENT.....</b>	<b>93</b>
11.1 Standard Requirement.....	93
11.2 Antenna Connected Construction.....	93

# 1. General Information about EUT

## 1.1 Client Information

**Applicant** : Dongguan Jin wen hua digital technology Co., LTD.  
**Address** : Floor 4, Building E, No. 655-90, Qiming Road, Yinzhou Investment & Innovation Center, Ningbo, China  
**Manufacturer** : Dongguan Jin wen hua digital technology Co., LTD.  
**Address** : Floor 4, Building E, No. 655-90, Qiming Road, Yinzhou Investment & Innovation Center, Ningbo, China

## 1.2 General Description of EUT (Equipment Under Test)

<b>EUT Name</b>	:	Bluetooth speaker			
<b>Models No.</b>	:	MA-2241, A6			
<b>Model Difference</b>	:	All these models are identical in the same PCB, layout and electrical circuit, the only difference is model name for commercial.			
<b>Product Description</b>	:	Operation Frequency: Bluetooth 2.1+EDR: 2402~2480MHz			
		Number of Channel:	Bluetooth:79 Channels See Note 3		
		Max Peak Output Power:	Bluetooth: 0.753 dBm(GFSK)		
		Antenna Gain:	2 dBi PCB Antenna		
		Modulation Type:	GFSK 1Mbps(1 Mbps) $\pi$ /4-DQPSK(2 Mbps) 8-DPSK(3 Mbps)		
<b>Power Supply</b>	:	DC Voltage supplied from Host System by USB cable. DC power by Li-ion Battery.			
<b>Power Rating</b>	:	DC 5.0V by USB cable. DC 3.7V by 500mAh Li-ion Battery.			
<b>Connecting I/O Port(S)</b>	:	Please refer to the User's Manual			

**Note:**

- (1) For a more detailed features description, please refer to the manufacturer's specifications or the User's Manual.
- (2) Channel List:

Bluetooth Channel List					
Channel	Frequency (MHz)	Channel	Frequency (MHz)	Channel	Frequency (MHz)
00	2402	27	2429	54	2456
01	2403	28	2430	55	2457
02	2404	29	2431	56	2458
03	2405	30	2432	57	2459

04	2406	31	2433	58	2460
05	2407	32	2434	59	2461
06	2408	33	2435	60	2462
07	2409	34	2436	61	2463
08	2410	35	2437	62	2464
09	2411	36	2438	63	2465
10	2412	37	2439	64	2466
11	2413	38	2440	65	2467
12	2414	<b>39</b>	<b>2441</b>	66	2468
13	2415	40	2442	67	2469
14	2416	41	2443	68	2470
15	2417	42	2444	69	2471
16	2418	43	2445	70	2472
17	2419	44	2446	71	2473
18	2420	45	2447	72	2474
19	2421	46	2448	73	2475
20	2422	47	2449	74	2476
21	2423	48	2450	75	2477
22	2424	49	2451	76	2478
23	2425	50	2452	77	2479
24	2426	51	2453	<b>78</b>	<b>2480</b>
25	2427	52	2454		
26	2428	53	2455		

(3) The Antenna information about the equipment is provided by the applicant.

### 1.3 Block Diagram Showing the Configuration of System Tested

**TX Mode**

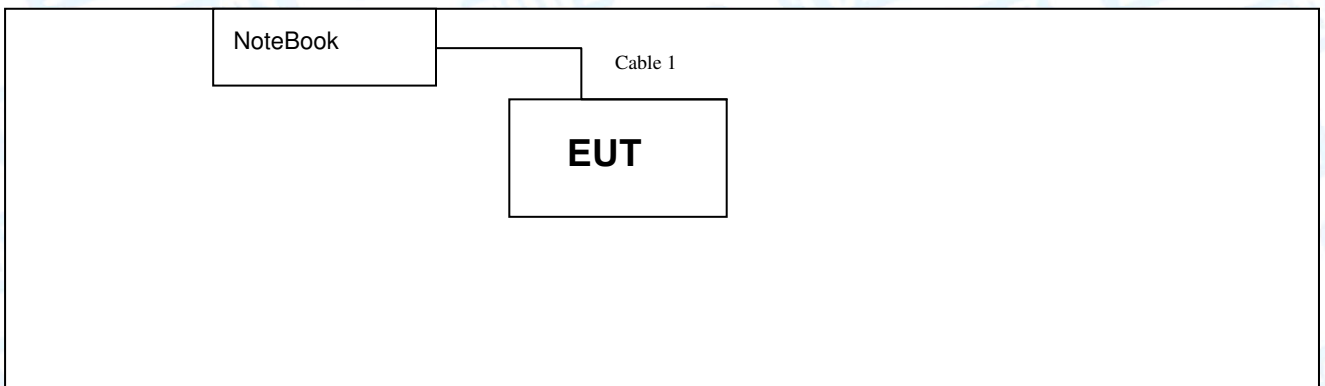

#### 1.4 Description of Support Units

Equipment Information				
Name	Model	FCC ID/DOC	Manufacturer	Used “√”
NoteBook	T60P	-----	Thinkpad	-----
Cable Information				
Number	Shielded Type	Ferrite Core	Length	Note
Cable 1	NO	NO	0.3m	Accessorise

#### 1.5 Description of Test Mode

To investigate the maximum EMI emission characteristics generates from EUT, the test system was pre-scanning tested base on the consideration of following EUT operation mode or test configuration mode which possible have effect on EMI emission level. Each of these EUT operation mode(s) or test configuration mode(s) mentioned follow was evaluated respectively.

For Conducted Test	
Final Test Mode	Description
Mode 1	USB Charging with TX GFSK Mode

For Radiated Test	
Final Test Mode	Description
Mode 1	USB Charging with TX GFSK Mode
Mode 2	TX Mode(GFSK) Channel 00/39/78
Mode 3	TX Mode( $\pi/4$ -DQPSK) Channel 00/39/78
Mode 4	TX Mode(8-DPSK) Channel 00/39/78
Mode 5	Hopping Mode(GFSK)
Mode 6	Hopping Mode( $\pi/4$ -DQPSK)
Mode 7	Hopping Mode(8-DPSK)

**Note:**

- (1) For all test, we have verified the construction and function in typical operation. And all the test modes were carried out with the EUT in transmitting operation in maximum power with all kinds of data rate. We have pretested all the test mode above.  
According to ANSI C63.10 standards, the measurements are performed at the highest, middle, lowest available channels, and the worst case data rate as follows:

- TX Mode: GFSK (1 Mbps)
- TX Mode:  $\pi/4$ -DQPSK (2 Mbps)
- TX Mode: 8-DPSK (3Mbps)

(2) The EUT is considered a portable unit; it was pre-tested on the positioned of each 3 axis, X-plane, Y-plane and Z-plane. The worst case was found positioned on X-plane as the normal use. Therefore only the test data of this X-plane was used for radiated emission measurement test.

### 1.6 Description of Test Software Setting

During testing channel & Power controlling software provided by the customer was used to control the operating channel as well as the output power level. The RF output power selection is for the setting of RF output power expected by the customer and is going to be fixed on the firmware of the final end product power parameters of Bluetooth mode.

Test Software Version	Appo Tech RF Control Kit V4.0		
Frequency	2402 MHz	2441MHz	2480 MHz
GFSK	DEF	DEF	DEF
$\pi/4$ -DQPSK	DEF	DEF	DEF
8-DPSK	DEF	DEF	DEF

### 1.7 Measurement Uncertainty

The reported uncertainty of measurement  $y \pm U$ , where expanded uncertainty U is based on a standard uncertainty multiplied by a coverage factor of  $k=2$ , providing a level of confidence of approximately 95 %.

Test Item	Parameters	Expanded Uncertainty ( $U_{Lab}$ )
Conducted Emission	Level Accuracy: 9kHz~150kHz	$\pm 3.42$ dB
	150kHz to 30MHz	$\pm 3.42$ dB
Radiated Emission	Level Accuracy: 9kHz to 30 MHz	$\pm 4.60$ dB
Radiated Emission	Level Accuracy: 30MHz to 1000 MHz	$\pm 4.40$ dB
Radiated Emission	Level Accuracy: Above 1000MHz	$\pm 4.20$ dB

## 1.8 Test Facility

The testing report were performed by the Shenzhen Toby Technology Co., Ltd., in their facilities located at 1A/F., Bldg.6, Yusheng Industrial Zone, The National Road No.107 Xixiang Section 467, Xixiang, Bao'an, Shenzhen, Guangdong, China. At the time of testing, the following bodies accredited the Laboratory:

### **CNAS (L5813)**

The Laboratory has been accredited by CNAS to ISO/IEC 17025: 2005 General Requirements for the Competence of Testing and Calibration Laboratories for the competence in the field of testing. And the Registration No.: CNAS L5813.

### **FCC List No.: (811562)**

The Laboratory is listed in the United States of American Federal Communications Commission (FCC), and the registration number is 811562.

### **IC Registration No.: (11950A-1)**

The Laboratory has been registered by Certification and Engineering Bureau of Industry Canada for radio equipment testing. The site registration: Site# 11950A-1.



## 2. Test Summary

FCC Part 15 Subpart C(15.247)/ RSS 247 Issue 1				
Standard Section		Test Item	Judgment	Remark
FCC	IC			
15.203		Antenna Requirement	PASS	N/A
15.207	RSS-GEN 7.2.2	Conducted Emission	PASS	N/A
15.205	RSS-Gen 7.2.3	Restricted Bands	PASS	N/A
15.247(a)(1)	RSS 247 5.1 (2)	Hopping Channel Separation	PASS	N/A
15.247(a)(1)	RSS 247 5.1 (4)	Dwell Time	PASS	N/A
15.247(b)(1)	RSS 247 5.4 (2)	Peak Output Power	PASS	N/A
15.247(b)(1)	RSS 247 5.1 (4)	Number of Hopping Frequency	PASS	N/A
15.247(c)	RSS 247 5.5	Radiated Spurious Emission	PASS	N/A
15.247(a)	RSS 247 5.1 (1)	99% Occupied Bandwidth & 20dB Bandwidth	PASS	99%OBW GFSK:981.6931kHz $\pi$ /4-DQPSK: 1070.90kHz 8-DPSK: 1143.00KHz

**Note:** N/A is an abbreviation for Not Applicable.

### 3. Test Equipment

Conducted Emission Test					
Equipment	Manufacturer	Model No.	Serial No.	Last Cal.	Cal. Due Date
EMI Test Receiver	Rohde & Schwarz	ESCI	100321	Aug. 07, 2015	Aug. 06, 2016
RF Switching Unit	Compliance Direction Systems Inc	RSU-A4	34403	Aug. 07, 2015	Aug. 06, 2016
AMN	SCHWARZBECK	NNBL 8226-2	8226-2/164	Aug. 07, 2015	Aug. 06, 2016
LISN	Rohde & Schwarz	ENV216	101131	Aug. 07, 2015	Aug. 06, 2016
Radiation Emission Test					
Equipment	Manufacturer	Model No.	Serial No.	Last Cal.	Cal. Due Date
Spectrum Analyzer	Agilent	E4407B	MY45106456	Aug. 29, 2015	Aug. 28, 2016
EMI Test Receiver	Rohde & Schwarz	ESCI	100010/007	Aug. 07, 2015	Aug. 06, 2016
Bilog Antenna	ETS-LINDGREN	3142E	00117537	Mar. 28, 2015	Mar. 27, 2016
Bilog Antenna	ETS-LINDGREN	3142E	00117542	Mar. 28, 2015	Mar. 27, 2016
Horn Antenna	ETS-LINDGREN	3117	00143207	Mar. 28, 2015	Mar. 27, 2016
Horn Antenna	ETS-LINDGREN	3117	00143209	Mar. 28, 2015	Mar. 27, 2016
Pre-amplifier	Sonoma	310N	185903	Mar. 28, 2015	Mar. 27, 2016
Pre-amplifier	HP	8447B	3008A00849	Mar. 28, 2015	Mar. 27, 2016
Cable	HUBER+SUHNER	100	SUCOFLEX	Mar. 28, 2015	Mar. 27, 2016
Positioning Controller	ETS-LINDGREN	2090	N/A	N/A	N/A

## 4. Conducted Emission Test

### 4.1 Test Standard and Limit

4.1.1 Test Standard  
FCC Part 15.207

4.1.2 Test Limit

**Conducted Emission Test Limit**

Frequency	Maximum RF Line Voltage (dB $\mu$ V)	
	Quasi-peak Level	Average Level
150kHz~500kHz	66 ~ 56 *	56 ~ 46 *
500kHz~5MHz	56	46
5MHz~30MHz	60	50

Notes:

- (1) \*Decreasing linearly with logarithm of the frequency.
- (2) The lower limit shall apply at the transition frequencies.
- (3) The limit decrease in line with the logarithm of the frequency in the range of 0.15 to 0.50MHz.

### 4.2 Test Setup

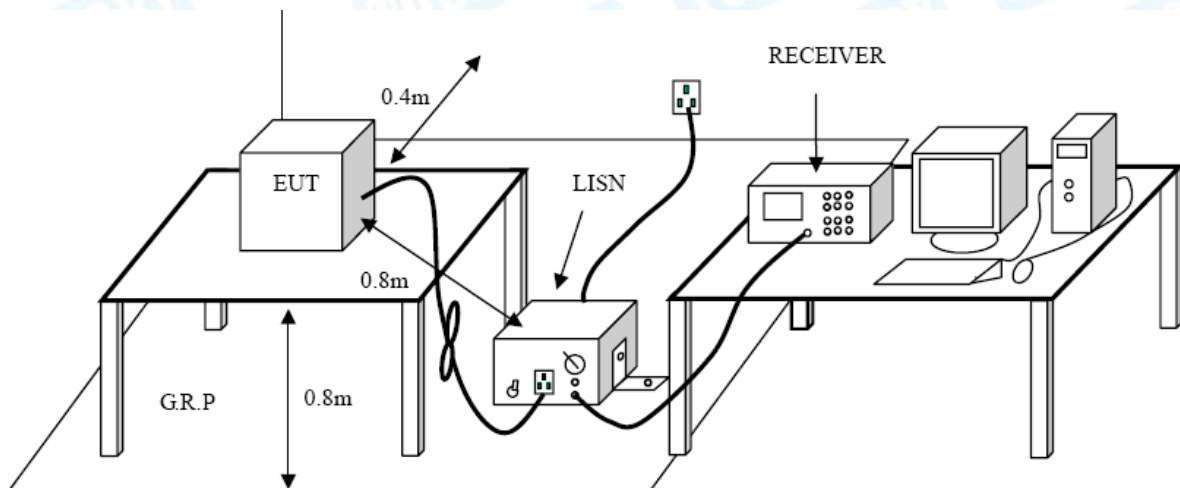

### 4.3 Test Procedure

The EUT was placed 0.8 meters from the horizontal ground plane with EUT being connected to the power mains through a line impedance stabilization network (LISN). All other support equipments powered from additional LISN(s). The LISN provide 50 Ohm/50uH of coupling impedance for the measuring instrument.

Interconnecting cables that hang closer than 40 cm to the ground plane shall be folded back and forth in the center forming a bundle 30 to 40 cm long.

I/O cables that are not connected to a peripheral shall be bundled in the center. The end of the cable may be terminated, if required, using the correct terminating impedance. The overall length shall not exceed 1 m.

LISN at least 80 cm from nearest part of EUT chassis

The bandwidth of EMI test receiver is set at 9kHz, and the test frequency band is from 0.15MHz to 30MHz.

#### 4.4 EUT Operating Mode

Please refer to the description of test mode.

#### 4.5 Test Data

Test data please refer the following pages.

<b>EUT:</b>	Bluetooth speaker	<b>Model Name :</b>	MA-2241
<b>Temperature:</b>	25 °C	<b>Relative Humidity:</b>	55%
<b>Test Voltage:</b>	AC 120V/60 Hz		
<b>Terminal:</b>	Line		
<b>Test Mode:</b>	USB Charging with TX GFSK Mode 2402 MHz		
<b>Remark:</b>	Only worse case is reported		

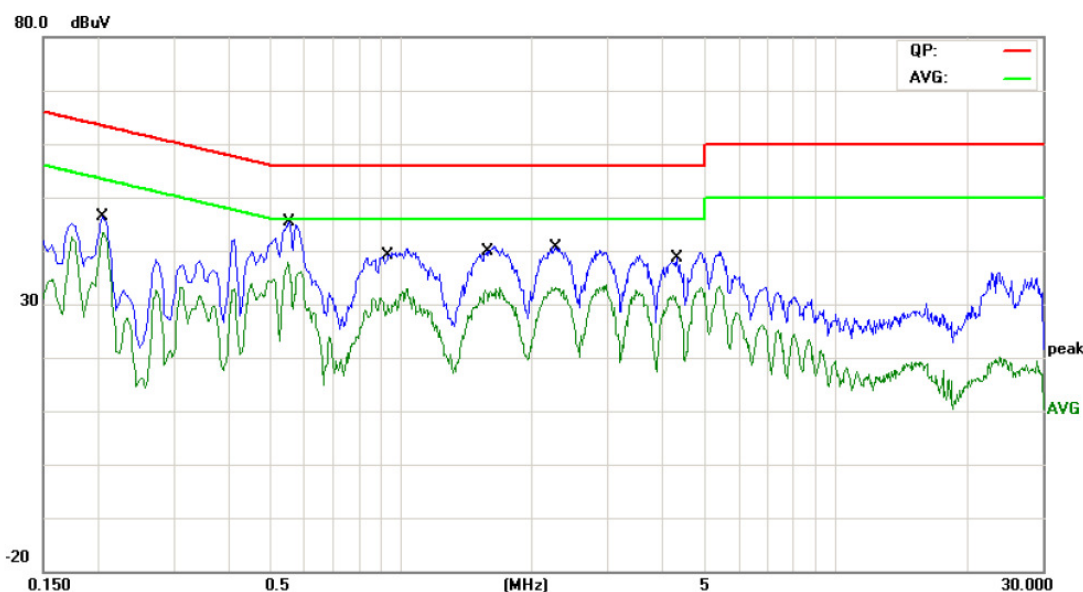

No.	Mk.	Freq. MHz	Reading Level dBuV	Correct Factor dB	Measure- ment dBuV	Limit dBuV	Over dB	Detector
1		0.2060	31.08	10.12	41.20	63.36	-22.16	QP
2		0.2060	29.96	10.12	40.08	53.36	-13.28	AVG
3		0.5540	35.45	10.02	45.47	56.00	-10.53	QP
4	*	0.5540	28.16	10.02	38.18	46.00	-7.82	AVG
5		0.9340	27.01	10.13	37.14	56.00	-18.86	QP
6		0.9340	19.62	10.13	29.75	46.00	-16.25	AVG
7		1.5780	26.10	10.10	36.20	56.00	-19.80	QP
8		1.5780	21.97	10.10	32.07	46.00	-13.93	AVG
9		2.2659	27.40	10.06	37.46	56.00	-18.54	QP
10		2.2659	22.64	10.06	32.70	46.00	-13.30	AVG
11		4.3259	24.05	10.06	34.11	56.00	-21.89	QP
12		4.3259	19.12	10.06	29.18	46.00	-16.82	AVG

Emission Level= Read Level+ Correct Factor

<b>EUT:</b>	Bluetooth speaker	<b>Model Name :</b>	MA-2241
<b>Temperature:</b>	25 °C	<b>Relative Humidity:</b>	55%
<b>Test Voltage:</b>	AC 120V/60 Hz		
<b>Terminal:</b>	Neutral		
<b>Test Mode:</b>	USB Charging with TX GFSK Mode 2402 MHz		
<b>Remark:</b>	Only worse case is reported		

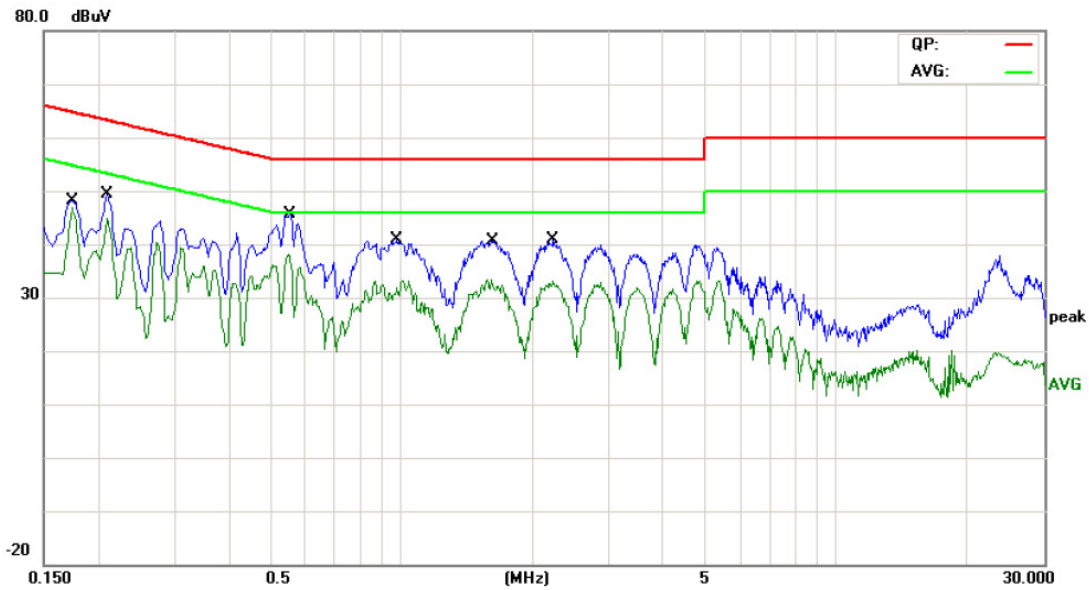

No.	Mk.	Freq. MHz	Reading Level dBuV	Correct Factor dB	Measure- ment dBuV	Limit dBuV	Over dB	Detector
1		0.1740	37.44	9.97	47.41	64.76	-17.35	QP
2	*	0.1740	36.78	9.97	46.75	54.76	-8.01	AVG
3		0.2100	37.62	10.02	47.64	63.20	-15.56	QP
4		0.2100	34.46	10.02	44.48	53.20	-8.72	AVG
5		0.5540	35.00	10.05	45.05	56.00	-10.95	QP
6		0.5540	27.57	10.05	37.62	46.00	-8.38	AVG
7		0.9780	29.25	10.06	39.31	56.00	-16.69	QP
8		0.9780	21.57	10.06	31.63	46.00	-14.37	AVG
9		1.6220	28.88	10.06	38.94	56.00	-17.06	QP
10		1.6220	22.14	10.06	32.20	46.00	-13.80	AVG
11		2.2260	27.66	10.05	37.71	56.00	-18.29	QP
12		2.2260	22.83	10.05	32.88	46.00	-13.12	AVG

Emission Level= Read Level+ Correct Factor

<b>EUT:</b>	Bluetooth speaker	<b>Model Name :</b>	MA-2241
<b>Temperature:</b>	25 °C	<b>Relative Humidity:</b>	55%
<b>Test Voltage:</b>	AC 240V/60 Hz		
<b>Terminal:</b>	Line		
<b>Test Mode:</b>	USB Charging with TX GFSK Mode 2402 MHz		
<b>Remark:</b>	Only worse case is reported		

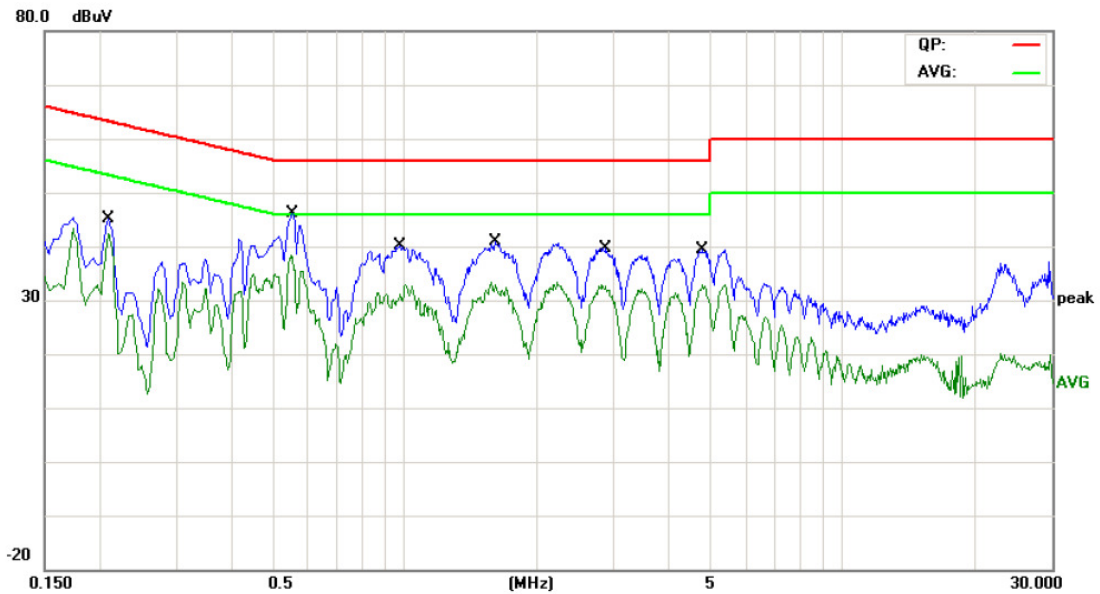

No.	Mk.	Freq. MHz	Reading Level dBuV	Correct Factor dB	Measure- ment dBuV	Limit dBuV	Over dB	Detector
1		0.2100	34.02	10.12	44.14	63.20	-19.06	QP
2		0.2100	32.39	10.12	42.51	53.20	-10.69	AVG
3		0.5540	35.77	10.02	45.79	56.00	-10.21	QP
4	*	0.5540	28.20	10.02	38.22	46.00	-7.78	AVG
5		0.9740	28.97	10.15	39.12	56.00	-16.88	QP
6		0.9740	21.00	10.15	31.15	46.00	-14.85	AVG
7		1.6060	27.80	10.10	37.90	56.00	-18.10	QP
8		1.6060	22.42	10.10	32.52	46.00	-13.48	AVG
9		2.8740	26.83	10.06	36.89	56.00	-19.11	QP
10		2.8740	22.45	10.06	32.51	46.00	-13.49	AVG
11		4.7860	26.62	10.06	36.68	56.00	-19.32	QP
12		4.7860	22.86	10.06	32.92	46.00	-13.08	AVG

Emission Level= Read Level+ Correct Factor

<b>EUT:</b>	Bluetooth speaker	<b>Model Name :</b>	MA-2241
<b>Temperature:</b>	25 °C	<b>Relative Humidity:</b>	55%
<b>Test Voltage:</b>	AC 240V/60 Hz		
<b>Terminal:</b>	Neutral		
<b>Test Mode:</b>	USB Charging with TX GFSK Mode 2402 MHz		
<b>Remark:</b>	Only worse case is reported		

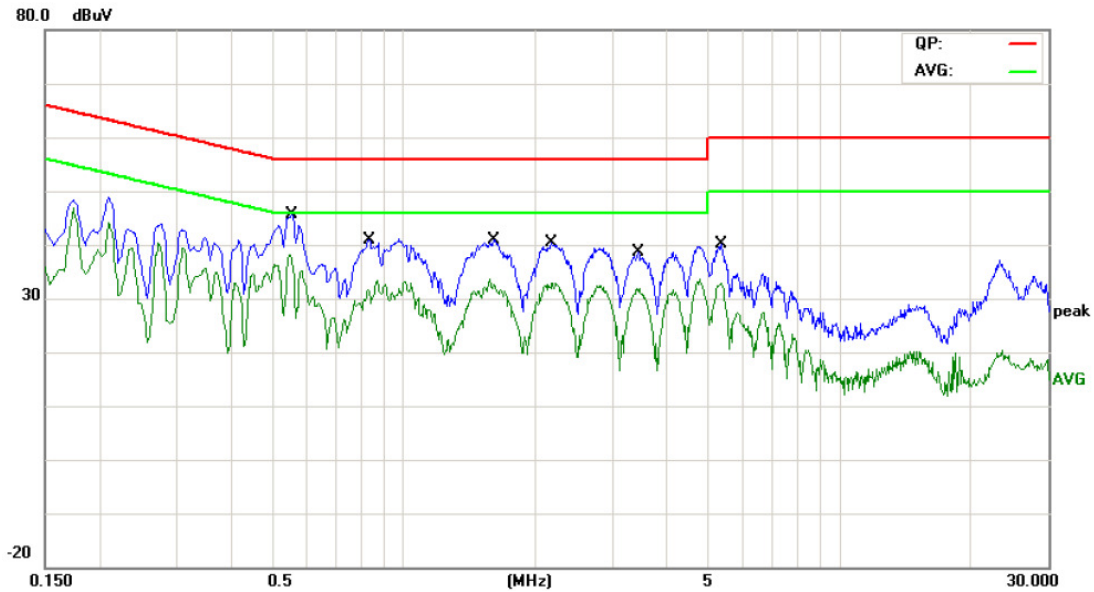

No.	Mk.	Freq. MHz	Reading Level dBuV	Correct Factor dB	Measure- ment dBuV	Limit dBuV	Over dB	Detector
1		0.5540	35.01	10.05	45.06	56.00	-10.94	QP
2	*	0.5540	27.44	10.05	37.49	46.00	-8.51	AVG
3		0.8340	29.99	10.09	40.08	56.00	-15.92	QP
4		0.8340	21.08	10.09	31.17	46.00	-14.83	AVG
5		1.6060	27.99	10.06	38.05	56.00	-17.95	QP
6		1.6060	22.51	10.06	32.57	46.00	-13.43	AVG
7		2.1740	27.42	10.05	37.47	56.00	-18.53	QP
8		2.1740	21.69	10.05	31.74	46.00	-14.26	AVG
9		3.4500	24.11	10.01	34.12	56.00	-21.88	QP
10		3.4500	21.07	10.01	31.08	46.00	-14.92	AVG
11		5.3340	27.02	9.98	37.00	60.00	-23.00	QP
12		5.3340	22.76	9.98	32.74	50.00	-17.26	AVG

**Emission Level= Read Level+ Correct Factor**



## 5. Radiated Emission Test

### 5.1 Test Standard and Limit

#### 5.1.1 Test Standard

FCC Part 15.209

#### 5.1.2 Test Limit

#### Radiated Emission Limit (9 kHz~1000MHz)

Frequency (MHz)	Field Strength (microvolt/meter)	Measurement Distance (meters)
0.009~0.490	2400/F(KHz)	300
0.490~1.705	24000/F(KHz)	30
1.705~30.0	30	30
30~88	100	3
88~216	150	3
216~960	200	3
Above 960	500	3

#### Radiated Emission Limit (Above 1000MHz)

Frequency (MHz)	Class B (dBuV/m)(at 3m)	
	Peak	Average
Above 1000	74	54

**Note:**

- (1) The tighter limit applies at the band edges.
- (2) Emission Level (dBuV/m)=20log Emission Level (uV/m)

5.2 Test Setup

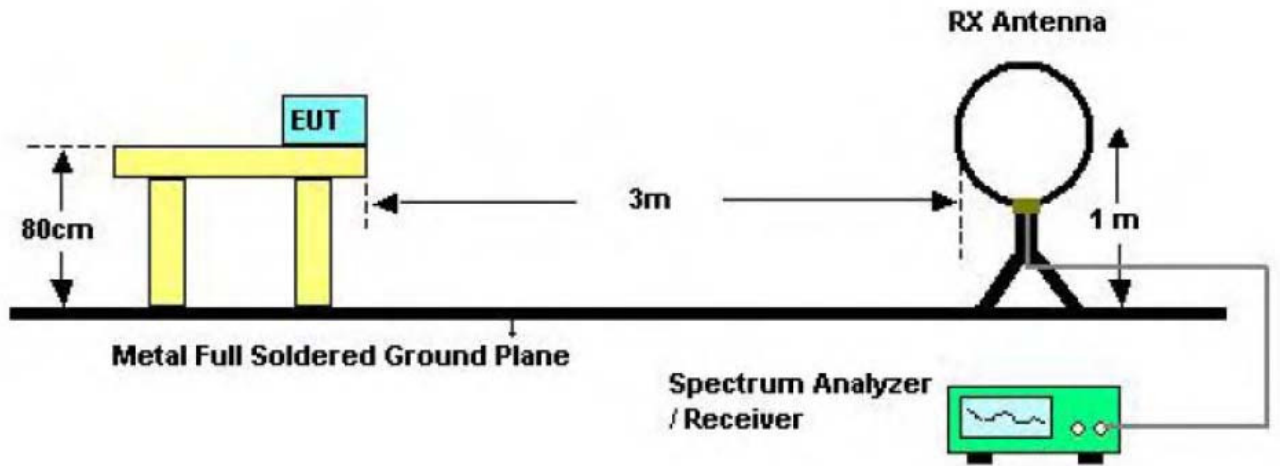

Bellow 30MHz Test Setup

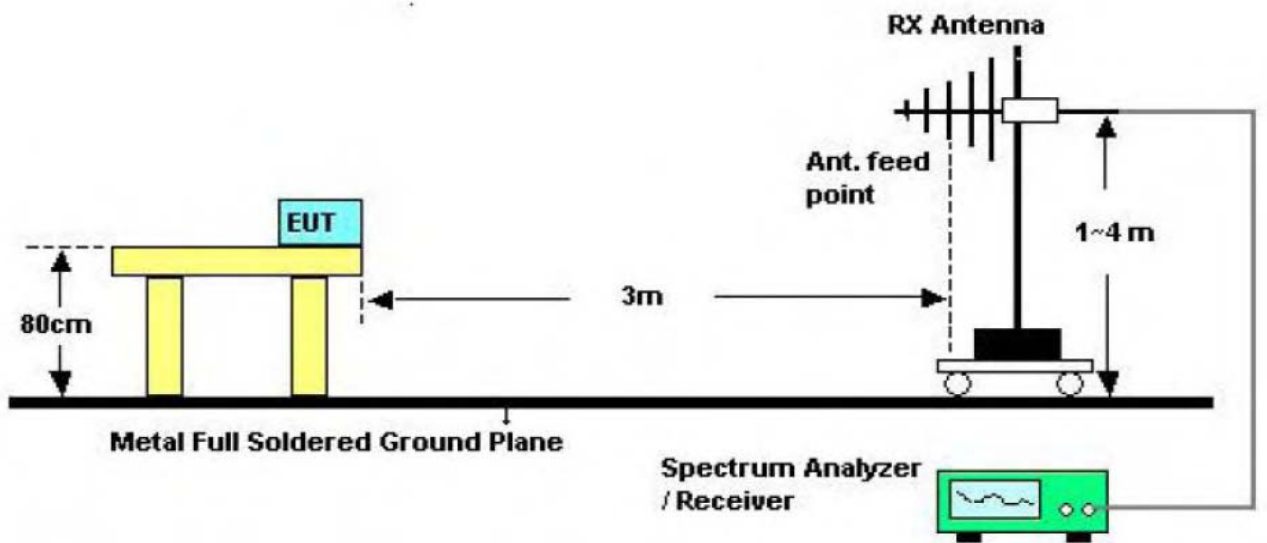

Bellow 1000MHz Test Setup

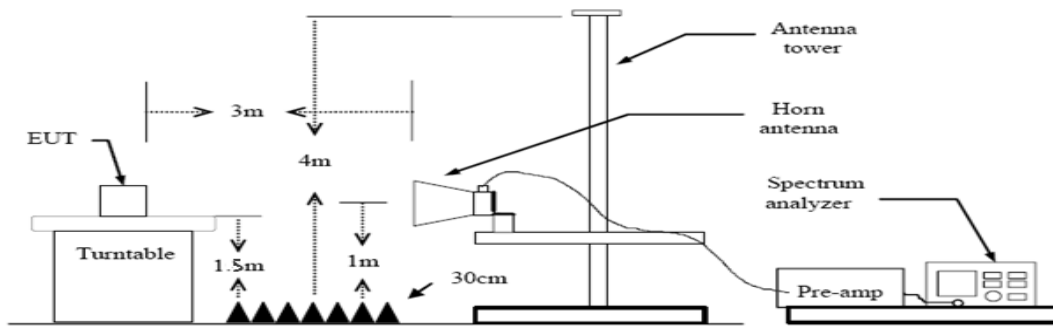

**Above 1GHz Test Setup**

### 5.3 Test Procedure

- (1) The measuring distance of 3m shall be used for measurements at frequency up to 1GHz and above 1 GHz. The EUT was placed on a rotating 0.8m high above ground, the table was rotated 360 degrees to determine the position of the highest radiation.
- (2) Measurements at frequency above 1GHz. The EUT was placed on a rotating 1.5m high above the ground. RF absorbers covered the ground plane with a minimum area of 3.0m by 3.0m between the EUT and measurement receiver antenna. The RF absorber shall not exceed 30cm in high above the conducting floor. The table was rotated 360 degrees to determine the position of the highest radiation.
- (3) The Test antenna shall vary between 1m and 4m, Both Horizontal and Vertical antenna are set to make measurement.
- (4) The initial step in collecting conducted emission data is a spectrum analyzer peak detector mode pre-scanning the measurement frequency range. Significant peaks are then marked and then Quasi Peak detector mode re-measured.
- (5) If the Peak Mode measured value compliance with and lower than Quasi Peak Mode Limit Bellow 1 GHz, the EUT shall be deemed to meet QP Limits and then no additional QP Mode measurement performed. But the Peak Value and average value both need to comply with applicable limit above 1 GHz.
- (6) Testing frequency range below 1GHz the measuring instrument use VBW=120 kHz with Quasi-peak detection.
- (7) Testing frequency range above 1GHz the measuring instrument use RBW=1 MHz and VBW=3 MHz with Peak Detector for Peak Values, and use RBW=1 MHz and VBW=10 Hz with Peak Detector for Average Values.
- (8) For the actual test configuration, please see the test setup photo.

### 5.4 EUT Operating Condition

The Equipment Under Test was set to Continual Transmitting in maximum power in TX mode.

### 5.5 Test Data

Remark: During testing above 1GHz the measuring instrument use RBW=1 MHz and VBW=3 MHz with Peak Detector for Peak Values, and use RBW=1 MHz and VBW=1 kHz with Peak Detector for Average Values.

Test data please refer the following pages.

<b>EUT:</b>	Bluetooth speaker	<b>Model Name :</b>	MA-2241
<b>Temperature:</b>	25 °C	<b>Relative Humidity:</b>	55%
<b>Test Voltage:</b>	DC 5V		
<b>Ant. Pol.</b>	Horizontal		
<b>Test Mode:</b>	TX GFSK Mode 2402MHz		
<b>Remark:</b>	Only worse case is reported		

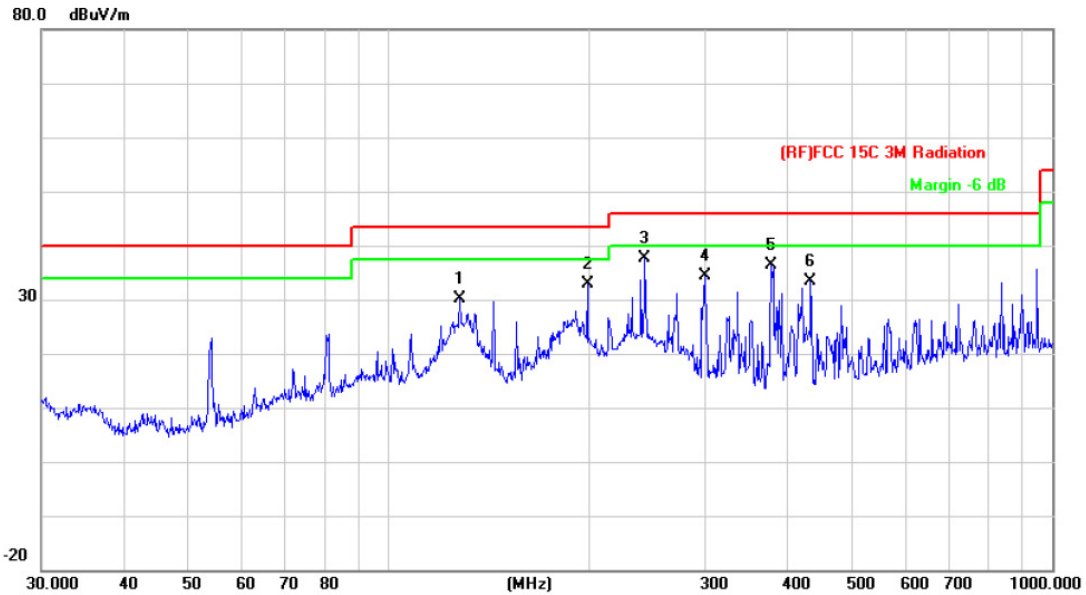

No.	Mk.	Freq.	Reading Level	Correct Factor	Measurement	Limit	Over	
		MHz	dBuV	dB/m	dBuV/m	dBuV/m	dB	Detector
1		128.1130	52.30	-22.24	30.06	43.50	-13.44	peak
2		199.2855	53.19	-20.43	32.76	43.50	-10.74	peak
3	*	243.3772	56.01	-18.43	37.58	46.00	-8.42	peak
4		299.3158	51.50	-17.10	34.40	46.00	-11.60	peak
5		377.2591	50.58	-14.31	36.27	46.00	-9.73	peak
6		432.5457	46.27	-12.78	33.49	46.00	-12.51	peak

\*:Maximum data    x:Over limit    !:over margin

**Emission Level= Read Level+ Correct Factor**

<b>EUT:</b>	Bluetooth speaker	<b>Model Name :</b>	MA-2241
<b>Temperature:</b>	25 °C	<b>Relative Humidity:</b>	55%
<b>Test Voltage:</b>	DC 5V		
<b>Ant. Pol.</b>	Vertical		
<b>Test Mode:</b>	TX GFSK Mode 2402MHz		
<b>Remark:</b>	Only worse case is reported		

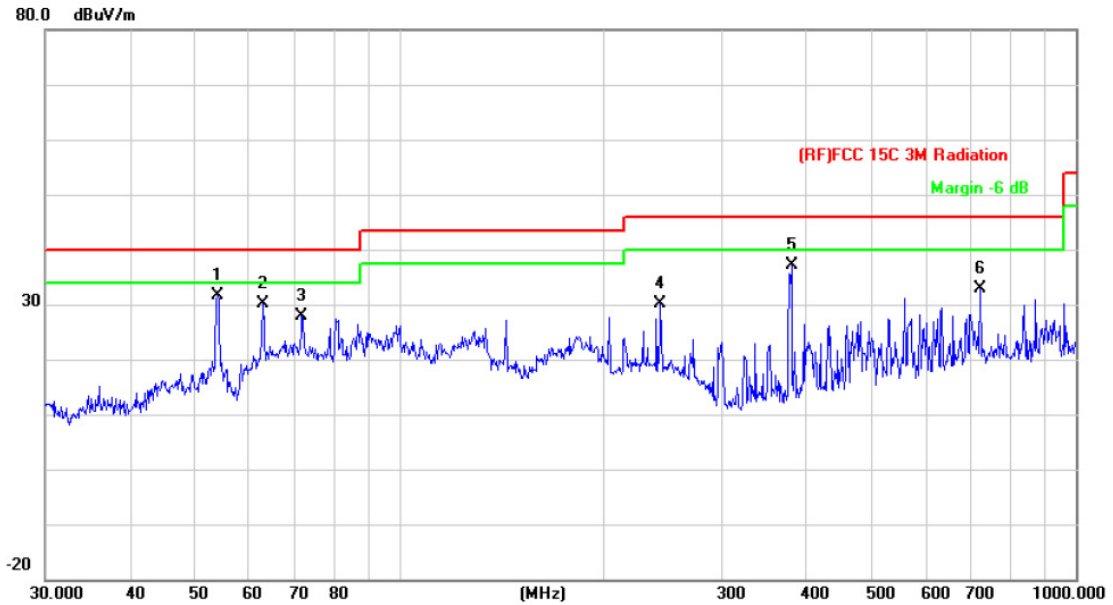

No.	Mk.	Freq. MHz	Reading Level dBuV	Correct Factor dB/m	Measure- ment dBuV/m	Limit dBuV/m	Over dB	Detector
1	*	53.8817	56.11	-24.45	31.66	40.00	-8.34	peak
2		62.8708	54.41	-24.26	30.15	40.00	-9.85	peak
3		71.8319	51.52	-23.56	27.96	40.00	-12.04	peak
4		243.3771	48.66	-18.43	30.23	46.00	-15.77	peak
5		379.9141	51.39	-14.14	37.25	46.00	-8.75	peak
6		721.7259	40.10	-7.10	33.00	46.00	-13.00	peak

\*:Maximum data    x:Over limit    !:over margin

**Emission Level= Read Level+ Correct Factor**

<b>EUT:</b>	Bluetooth speaker	<b>Model Name :</b>	MA-2241
<b>Temperature:</b>	25 °C	<b>Relative Humidity:</b>	55%
<b>Test Voltage:</b>	DC 5V		
<b>Ant. Pol.</b>	Horizontal		
<b>Test Mode:</b>	TX $\pi/4$ -DQPSK Mode 2402MHz		
<b>Remark:</b>	Only worse case is reported		

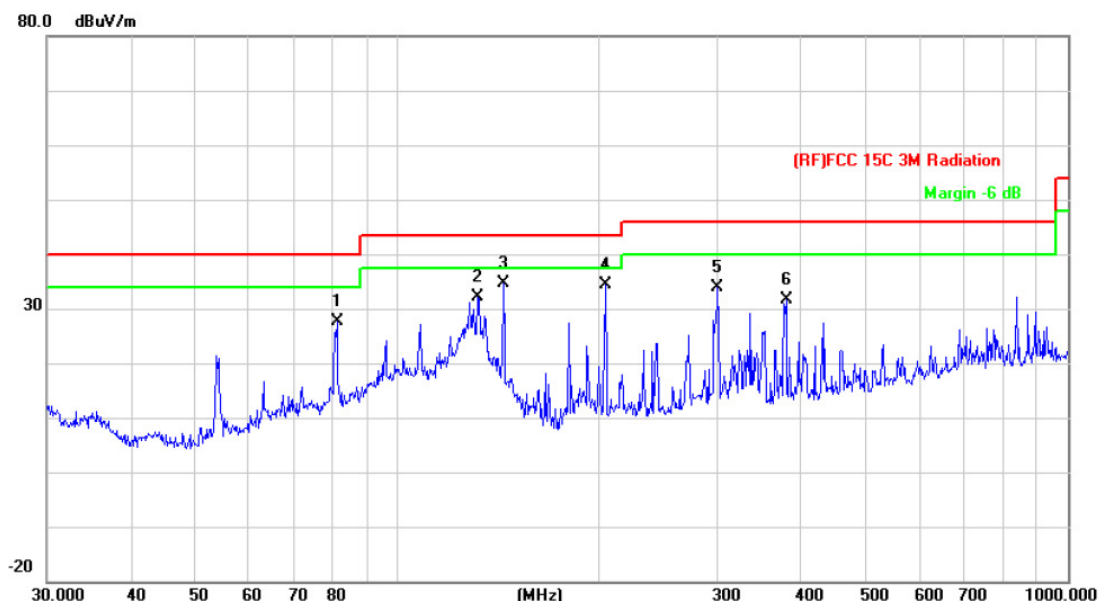

No. Mk.	Freq. MHz	Reading Level dBuV	Correct Factor dB/m	Measure- ment dBuV/m	Limit dBuV/m	Over dB	Detector
1	81.2116	50.73	-23.21	27.52	40.00	-12.48	peak
2	131.7576	54.16	-22.14	32.02	43.50	-11.48	peak
3 *	143.8294	56.28	-21.67	34.61	43.50	-8.89	peak
4	204.2376	54.51	-20.20	34.31	43.50	-9.19	peak
5	300.3672	50.86	-17.07	33.79	46.00	-12.21	peak
6	379.9141	45.72	-14.14	31.58	46.00	-14.42	peak

\*:Maximum data x:Over limit !:over margin

**Emission Level= Read Level+ Correct Factor**

<b>EUT:</b>	Bluetooth speaker	<b>Model Name :</b>	MA-2241
<b>Temperature:</b>	25 °C	<b>Relative Humidity:</b>	55%
<b>Test Voltage:</b>	DC 5V		
<b>Ant. Pol.</b>	Vertical		
<b>Test Mode:</b>	TX $\pi/4$ -DQPSK Mode 2402MHz		
<b>Remark:</b>	Only worse case is reported		

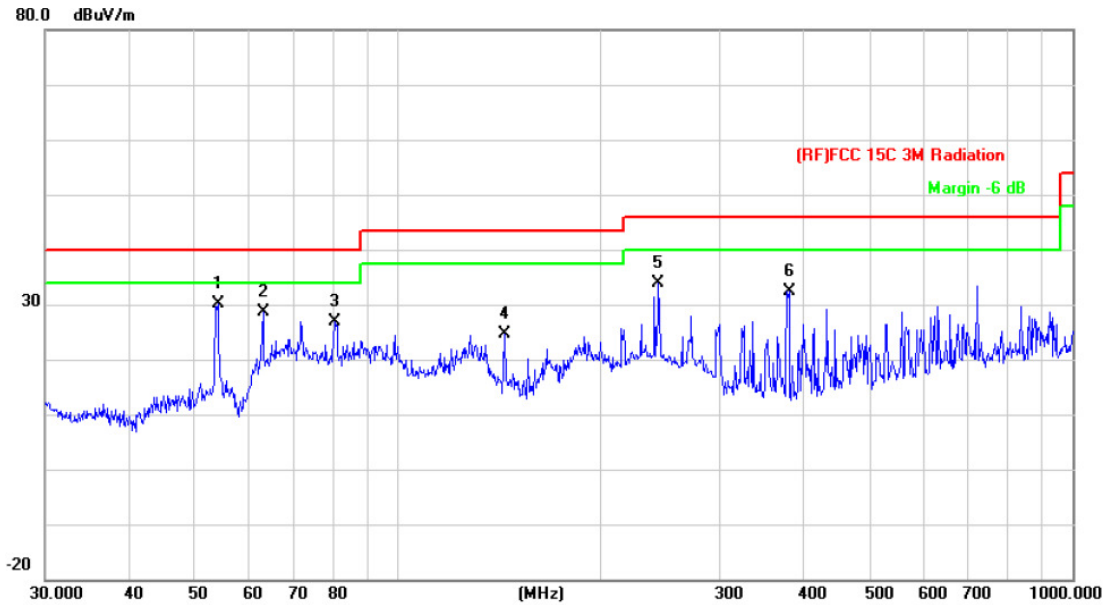

No.	Mk.	Freq. MHz	Reading Level dBuV	Correct Factor dB/m	Measure- ment dBuV/m	Limit dBuV/m	Over dB	Detector
1	*	54.0711	54.47	-24.45	30.02	40.00	-9.98	peak
2		63.0916	52.97	-24.25	28.72	40.00	-11.28	peak
3		80.6442	50.09	-23.25	26.84	40.00	-13.16	peak
4		143.8295	46.35	-21.67	24.68	43.50	-18.82	peak
5		243.3772	52.22	-18.43	33.79	46.00	-12.21	peak
6		379.9141	46.53	-14.14	32.39	46.00	-13.61	peak

\*:Maximum data x:Over limit !:over margin

**Emission Level= Read Level+ Correct Factor**

<b>EUT:</b>	Bluetooth speaker	<b>Model Name :</b>	MA-2241
<b>Temperature:</b>	25 °C	<b>Relative Humidity:</b>	55%
<b>Test Voltage:</b>	DC 5V		
<b>Ant. Pol.</b>	Horizontal		
<b>Test Mode:</b>	TX 8-DPSK Mode 2402MHz		
<b>Remark:</b>	Only worse case is reported		

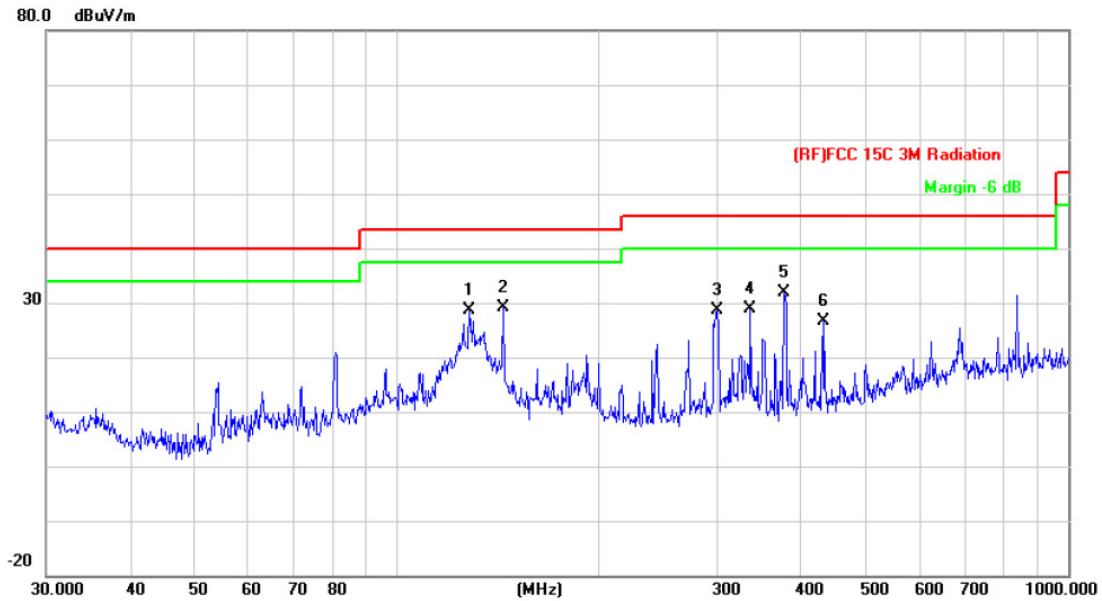

No.	Mk.	Freq. MHz	Reading Level dBuV	Correct Factor dB/m	Measure- ment dBuV/m	Limit dBuV/m	Over dB	Detector
1		128.1130	50.84	-22.24	28.60	43.50	-14.90	peak
2		143.8295	50.77	-21.67	29.10	43.50	-14.40	peak
3		299.3158	45.75	-17.10	28.65	46.00	-17.35	peak
4		336.0352	44.33	-15.46	28.87	46.00	-17.13	peak
5	*	377.2591	46.27	-14.31	31.96	46.00	-14.04	peak
6		432.5457	39.42	-12.78	26.64	46.00	-19.36	peak

\*:Maximum data    x:Over limit    !:over margin

**Emission Level= Read Level+ Correct Factor**



<b>EUT:</b>	Bluetooth speaker	<b>Model Name :</b>	MA-2241
<b>Temperature:</b>	25 °C	<b>Relative Humidity:</b>	55%
<b>Test Voltage:</b>	DC 5V		
<b>Ant. Pol.</b>	Vertical		
<b>Test Mode:</b>	TX 8-DPSK Mode 2402MHz		
<b>Remark:</b>	Only worse case is reported		

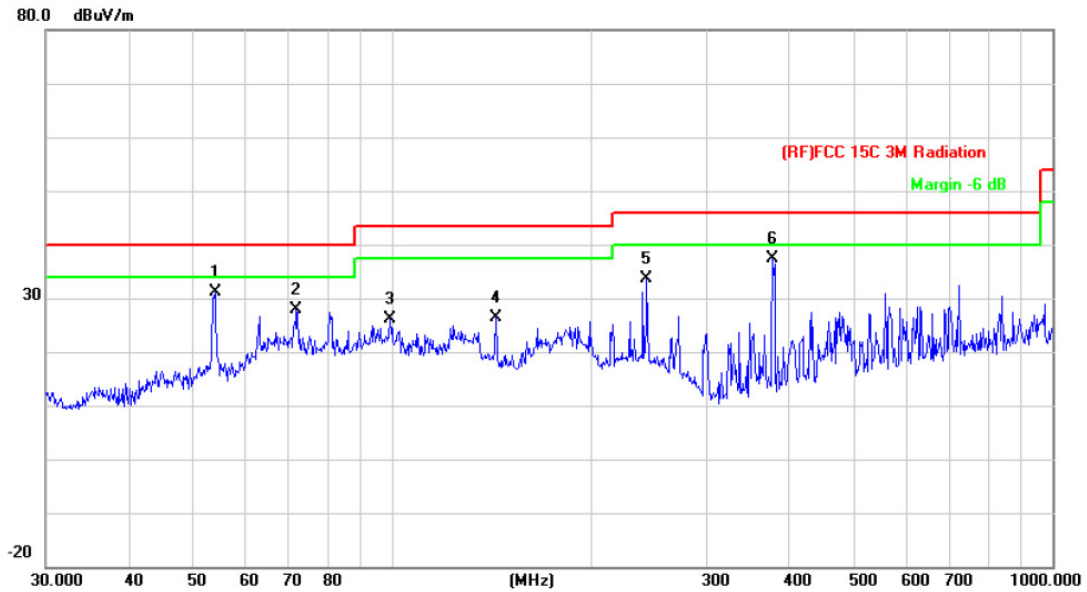

No.	Mk.	Freq.	Reading Level	Correct Factor	Measurement	Limit	Over	Detector
		MHz	dBuV	dB/m	dBuV/m	dBuV/m	dB	
1		54.0711	55.47	-24.45	31.02	40.00	-8.98	peak
2		71.8320	51.38	-23.56	27.82	40.00	-12.18	peak
3		99.5281	47.97	-21.86	26.11	43.50	-17.39	peak
4		143.8295	48.17	-21.67	26.50	43.50	-17.00	peak
5		243.3772	52.04	-18.43	33.61	46.00	-12.39	peak
6	*	377.2591	51.58	-14.31	37.27	46.00	-8.73	peak

\*:Maximum data x:Over limit !:over margin

**Emission Level= Read Level+ Correct Factor**

<b>EUT:</b>	Bluetooth speaker	<b>Model Name :</b>	MA-2241
<b>Temperature:</b>	25 °C	<b>Relative Humidity:</b>	55%
<b>Test Voltage:</b>	DC 5V		
<b>Ant. Pol.</b>	Horizontal		
<b>Test Mode:</b>	TX GFSK Mode 2402MHz		
<b>Remark:</b>	No report for the emission which more than 10 dB below the prescribed limit.		

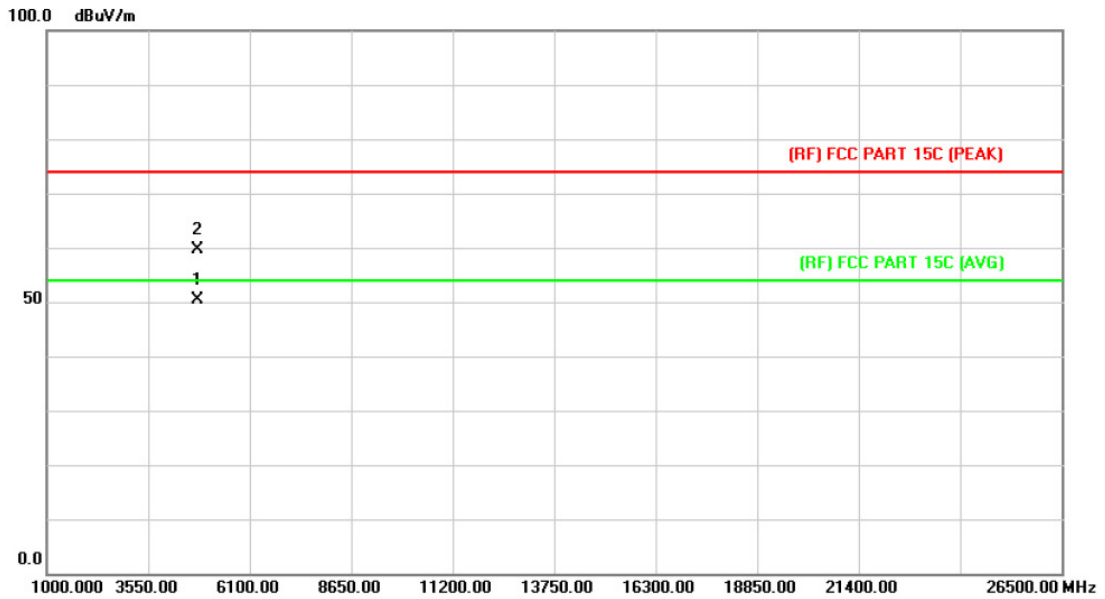

No.	Mk.	Freq.	Reading Level	Correct Factor	Measurement	Limit	Over	
		MHz	dBuV	dB/m	dBuV/m	dBuV/m	dB	Detector
1	*	4804.050	36.90	13.44	50.34	54.00	-3.66	AVG
2		4804.115	46.27	13.44	59.71	74.00	-14.29	peak

Emission Level= Read Level+ Correct Factor

<b>EUT:</b>	Bluetooth speaker	<b>Model Name :</b>	MA-2241
<b>Temperature:</b>	25 °C	<b>Relative Humidity:</b>	55%
<b>Test Voltage:</b>	DC 5V		
<b>Ant. Pol.</b>	Vertical		
<b>Test Mode:</b>	TX GFSK Mode 2402MHz		
<b>Remark:</b>	No report for the emission which more than 10 dB below the prescribed limit.		

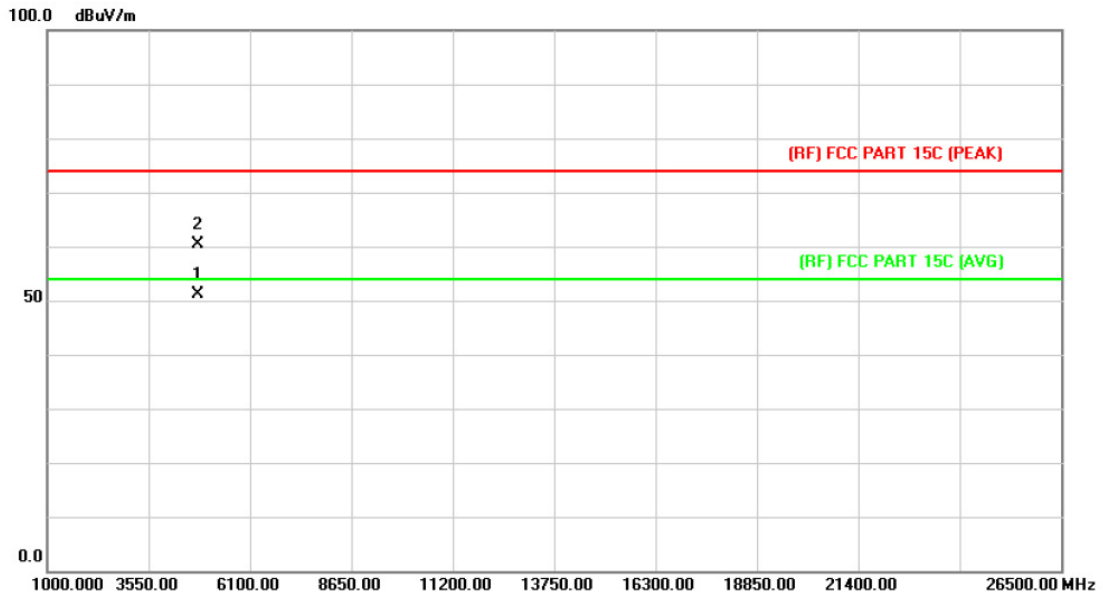

No.	Mk.	Freq.	Reading Level	Correct Factor	Measurement	Limit	Over	
		MHz	dBuV	dB/m	dBuV/m	dBuV/m	dB	Detector
1	*	4804.050	37.63	13.44	51.07	54.00	-2.93	AVG
2		4804.105	46.89	13.44	60.33	74.00	-13.67	peak

Emission Level= Read Level+ Correct Factor

<b>EUT:</b>	Bluetooth speaker	<b>Model Name :</b>	MA-2241
<b>Temperature:</b>	25 °C	<b>Relative Humidity:</b>	55%
<b>Test Voltage:</b>	DC 5V		
<b>Ant. Pol.</b>	Horizontal		
<b>Test Mode:</b>	TX GFSK Mode 2441MHz		
<b>Remark:</b>	No report for the emission which more than 10 dB below the prescribed limit.		

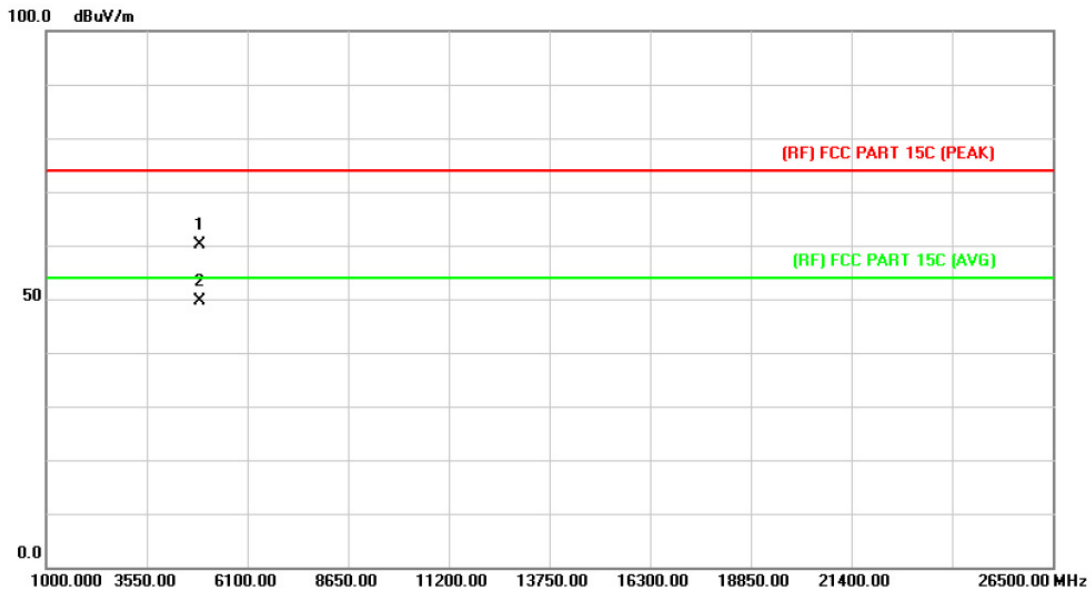

No.	Mk.	Freq.	Reading Level	Correct Factor	Measurement	Limit	Over	Detector
		MHz	dBuV	dB/m	dBuV/m	dBuV/m	dB	
1		4881.475	46.26	13.90	60.16	74.00	-13.84	peak
2	*	4881.647	35.67	13.90	49.57	54.00	-4.43	AVG

Emission Level= Read Level+ Correct Factor

<b>EUT:</b>	Bluetooth speaker	<b>Model Name :</b>	MA-2241
<b>Temperature:</b>	25 °C	<b>Relative Humidity:</b>	55%
<b>Test Voltage:</b>	DC 5V		
<b>Ant. Pol.</b>	Vertical		
<b>Test Mode:</b>	TX GFSK Mode 2441MHz		
<b>Remark:</b>	No report for the emission which more than 10 dB below the prescribed limit.		

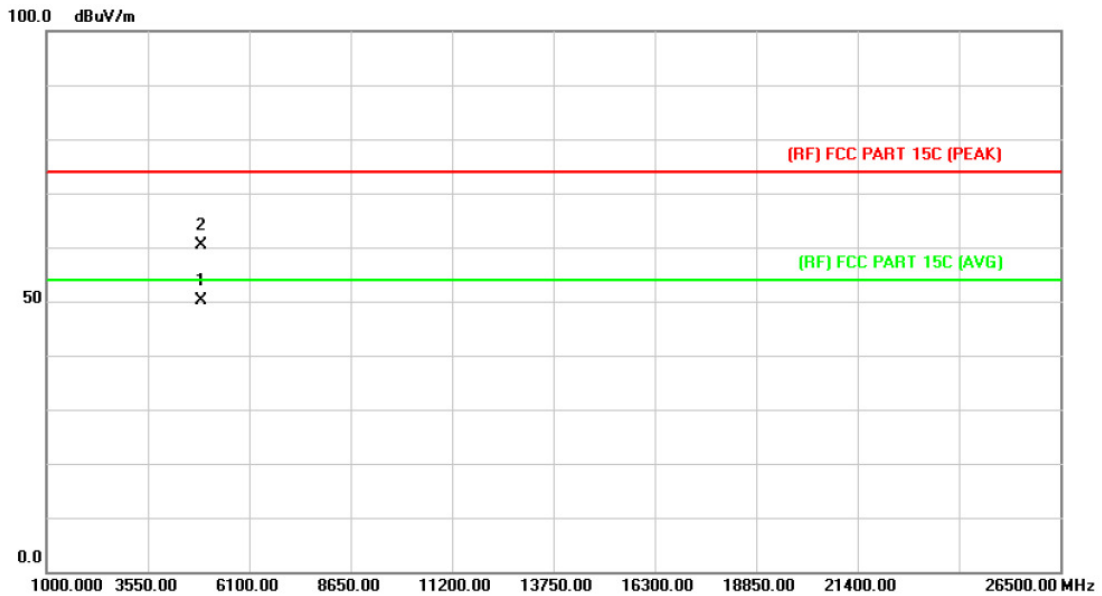

No.	Mk.	Freq.	Reading Level	Correct Factor	Measurement	Limit	Over	
		MHz	dBuV	dB/m	dBuV/m	dBuV/m	dB	Detector
1	*	4882.351	36.31	13.90	50.21	54.00	-3.79	AVG
2		4882.368	46.49	13.90	60.39	74.00	-13.61	peak

Emission Level= Read Level+ Correct Factor

<b>EUT:</b>	Bluetooth speaker	<b>Model Name :</b>	MA-2241
<b>Temperature:</b>	25 °C	<b>Relative Humidity:</b>	55%
<b>Test Voltage:</b>	DC 5V		
<b>Ant. Pol.</b>	Horizontal		
<b>Test Mode:</b>	TX GFSK Mode 2480MHz		
<b>Remark:</b>	No report for the emission which more than 10 dB below the prescribed limit.		

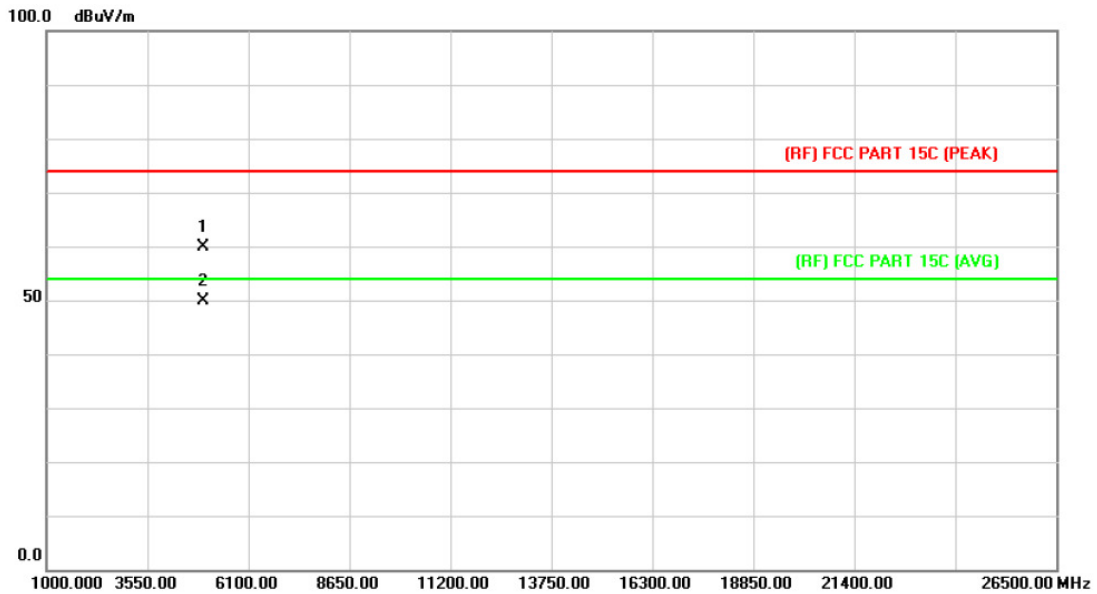

No. Mk.	Freq. MHz	Reading Level dBuV	Correct Factor dB/m	Measure- ment dBuV/m	Limit dBuV/m	Over dB	Detector
1	4960.147	45.57	14.36	59.93	74.00	-14.07	peak
2	* 4960.368	35.48	14.36	49.84	54.00	-4.16	AVG

Emission Level= Read Level+ Correct Factor

<b>EUT:</b>	Bluetooth speaker	<b>Model Name :</b>	MA-2241
<b>Temperature:</b>	25 °C	<b>Relative Humidity:</b>	55%
<b>Test Voltage:</b>	DC 5V		
<b>Ant. Pol.</b>	Vertical		
<b>Test Mode:</b>	TX GFSK Mode 2480MHz		
<b>Remark:</b>	No report for the emission which more than 10 dB below the prescribed limit.		

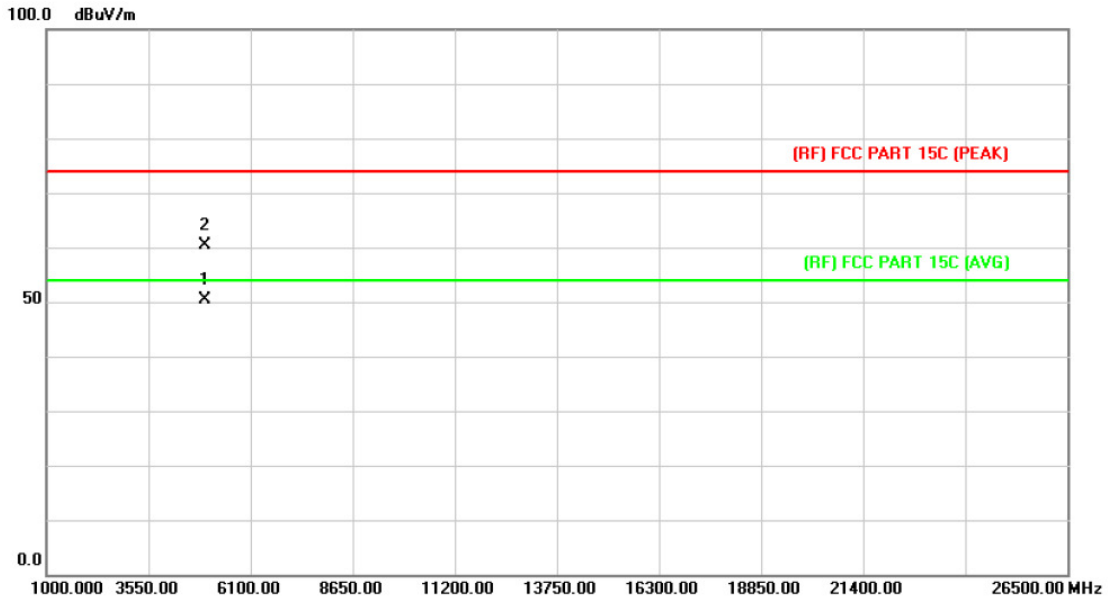

No.	Mk.	Freq.	Reading Level	Correct Factor	Measurement	Limit	Over	Detector
		MHz	dBuV	dB/m	dBuV/m	dBuV/m	dB	
1	*	4960.551	36.01	14.36	50.37	54.00	-3.63	AVG
2		4960.627	46.05	14.36	60.41	74.00	-13.59	peak

**Emission Level= Read Level+ Correct Factor**

<b>EUT:</b>	Bluetooth speaker	<b>Model Name :</b>	MA-2241
<b>Temperature:</b>	25 °C	<b>Relative Humidity:</b>	55%
<b>Test Voltage:</b>	DC 5V		
<b>Ant. Pol.</b>	Horizontal		
<b>Test Mode:</b>	TX 8-DPSK Mode 2402MHz		
<b>Remark:</b>	No report for the emission which more than 10 dB below the prescribed limit.		

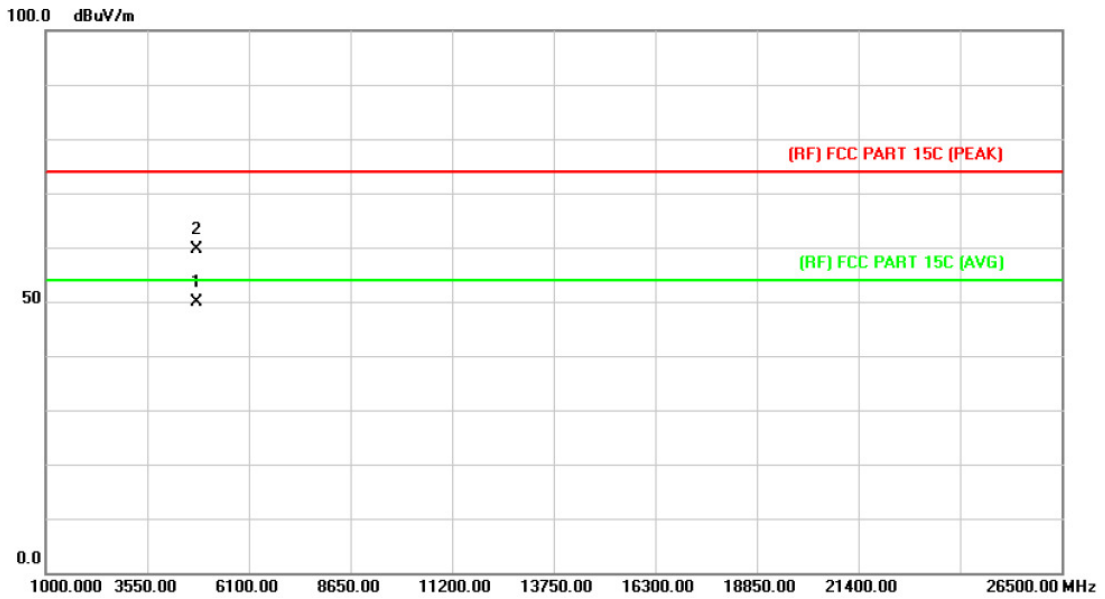

No.	Mk.	Freq.	Reading Level	Correct Factor	Measurement	Limit	Over	
		MHz	dBuV	dB/m	dBuV/m	dBuV/m	dB	Detector
1	*	4804.030	36.43	13.44	49.87	54.00	-4.13	AVG
2		4804.387	46.29	13.44	59.73	74.00	-14.27	peak

**Emission Level= Read Level+ Correct Factor**



<b>EUT:</b>	Bluetooth speaker	<b>Model Name :</b>	MA-2241
<b>Temperature:</b>	25 °C	<b>Relative Humidity:</b>	55%
<b>Test Voltage:</b>	DC 5V		
<b>Ant. Pol.</b>	Vertical		
<b>Test Mode:</b>	TX 8-DPSK Mode 2402MHz		
<b>Remark:</b>	No report for the emission which more than 10 dB below the prescribed limit.		

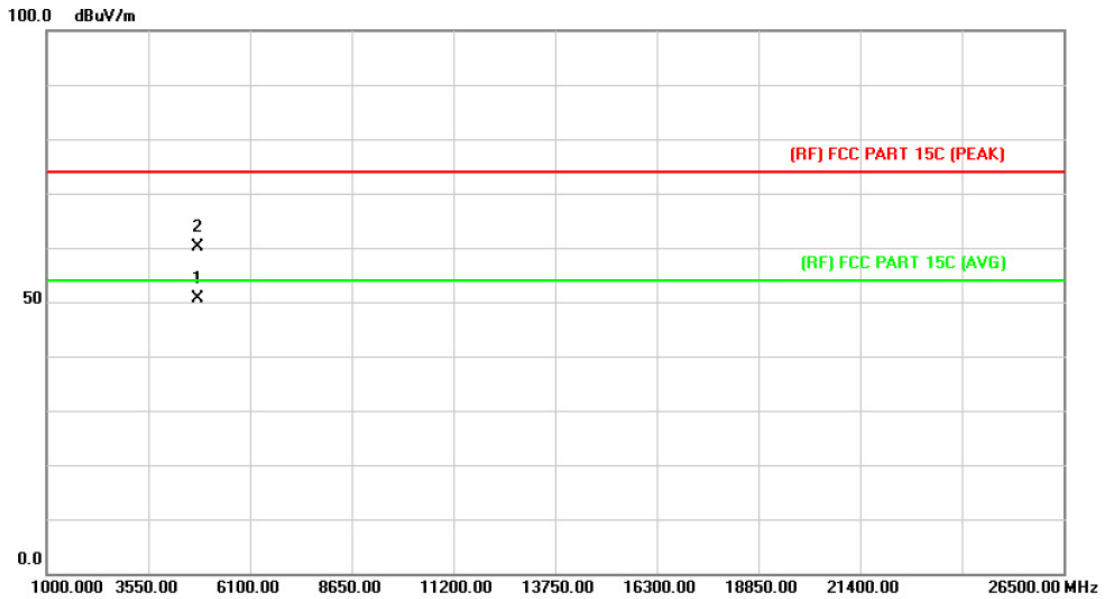

No.	Mk.	Freq.	Reading Level	Correct Factor	Measurement	Limit	Over	Detector
		MHz	dBuV	dB/m	dBuV/m	dBuV/m	dB	
1	*	4804.012	37.27	13.44	50.71	54.00	-3.29	AVG
2		4804.366	46.65	13.44	60.09	74.00	-13.91	peak

Emission Level= Read Level+ Correct Factor

<b>EUT:</b>	Bluetooth speaker	<b>Model Name :</b>	MA-2241
<b>Temperature:</b>	25 °C	<b>Relative Humidity:</b>	55%
<b>Test Voltage:</b>	DC 5V		
<b>Ant. Pol.</b>	Horizontal		
<b>Test Mode:</b>	TX 8-DPSK Mode 2441MHz		
<b>Remark:</b>	No report for the emission which more than 10 dB below the prescribed limit.		

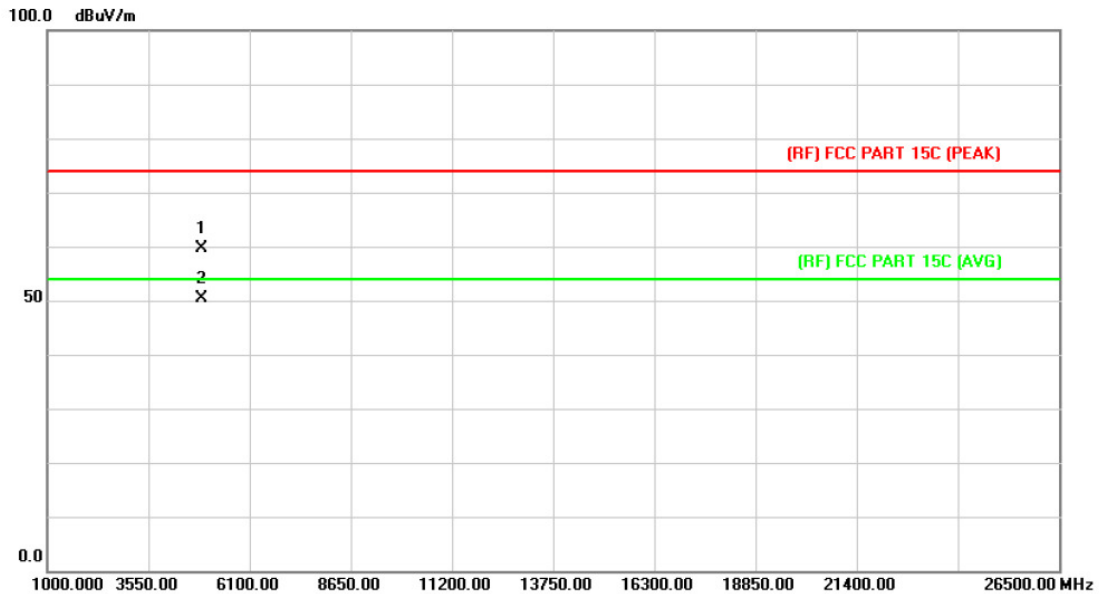

No.	Mk.	Freq.	Reading Level	Correct Factor	Measurement	Limit	Over	
		MHz	dBuV	dB/m	dBuV/m	dBuV/m	dB	Detector
1		4881.853	45.64	13.90	59.54	74.00	-14.46	peak
2	*	4881.949	36.42	13.90	50.32	54.00	-3.68	AVG

Emission Level= Read Level+ Correct Factor

<b>EUT:</b>	Bluetooth speaker	<b>Model Name :</b>	MA-2241
<b>Temperature:</b>	25 °C	<b>Relative Humidity:</b>	55%
<b>Test Voltage:</b>	DC 5V		
<b>Ant. Pol.</b>	Vertical		
<b>Test Mode:</b>	TX 8-DPSK Mode 2441MHz		
<b>Remark:</b>	No report for the emission which more than 10 dB below the prescribed limit.		

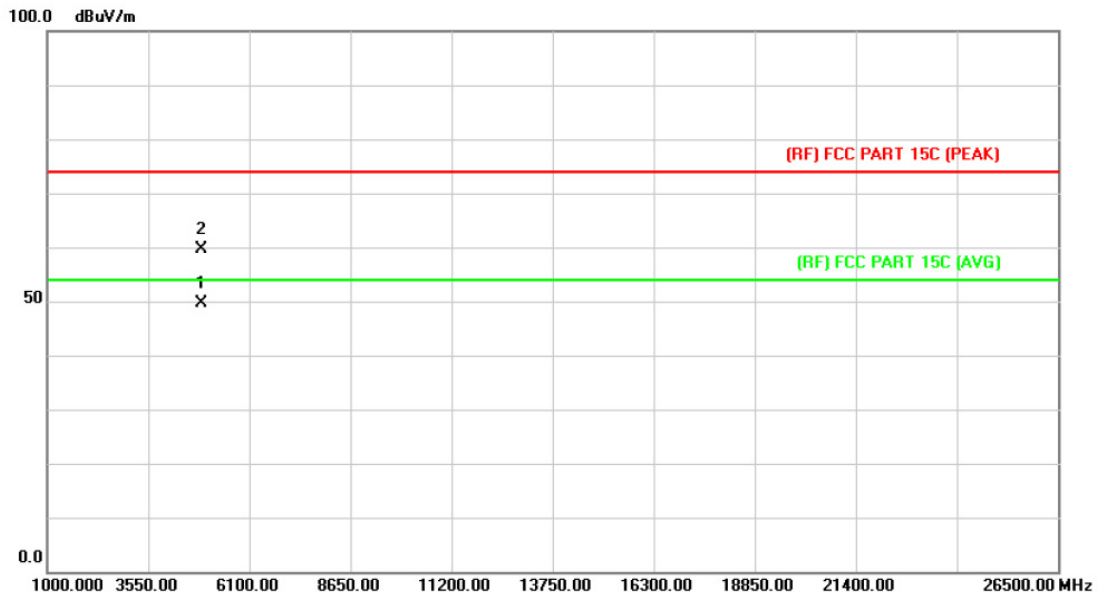

No.	Mk.	Freq.	Reading Level	Correct Factor	Measurement	Limit	Over	Detector
		MHz	dBuV	dB/m	dBuV/m	dBuV/m	dB	
1	*	4882.072	35.75	13.90	49.65	54.00	-4.35	AVG
2		4882.243	45.79	13.90	59.69	74.00	-14.31	peak

Emission Level= Read Level+ Correct Factor

<b>EUT:</b>	Bluetooth speaker	<b>Model Name :</b>	MA-2241
<b>Temperature:</b>	25 °C	<b>Relative Humidity:</b>	55%
<b>Test Voltage:</b>	DC 5V		
<b>Ant. Pol.</b>	Horizontal		
<b>Test Mode:</b>	TX 8-DPSK Mode 2480MHz		
<b>Remark:</b>	No report for the emission which more than 10 dB below the prescribed limit.		

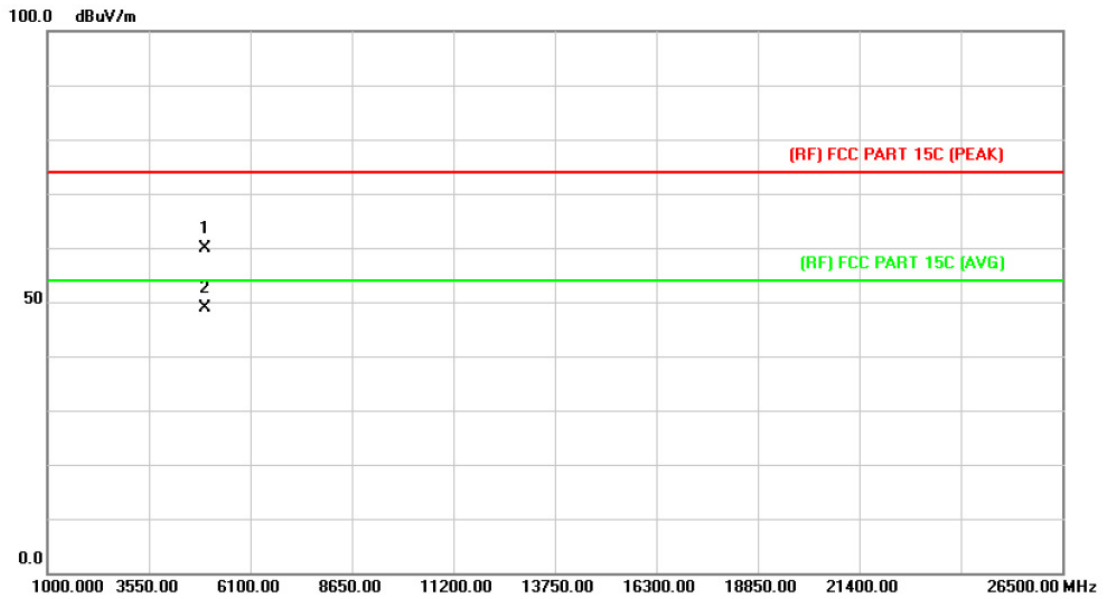

No.	Mk.	Freq.	Reading Level	Correct Factor	Measurement	Limit	Over	Detector
		MHz	dBuV	dB/m	dBuV/m	dBuV/m	dB	
1		4960.000	45.51	14.36	59.87	74.00	-14.13	peak
2	*	4960.009	34.45	14.36	48.81	54.00	-5.19	AVG

Emission Level= Read Level+ Correct Factor

<b>EUT:</b>	Bluetooth speaker	<b>Model Name :</b>	MA-2241
<b>Temperature:</b>	25 °C	<b>Relative Humidity:</b>	55%
<b>Test Voltage:</b>	DC 5V		
<b>Ant. Pol.</b>	Vertical		
<b>Test Mode:</b>	TX 8-DPSK Mode 2480MHz		
<b>Remark:</b>	No report for the emission which more than 10 dB below the prescribed limit.		

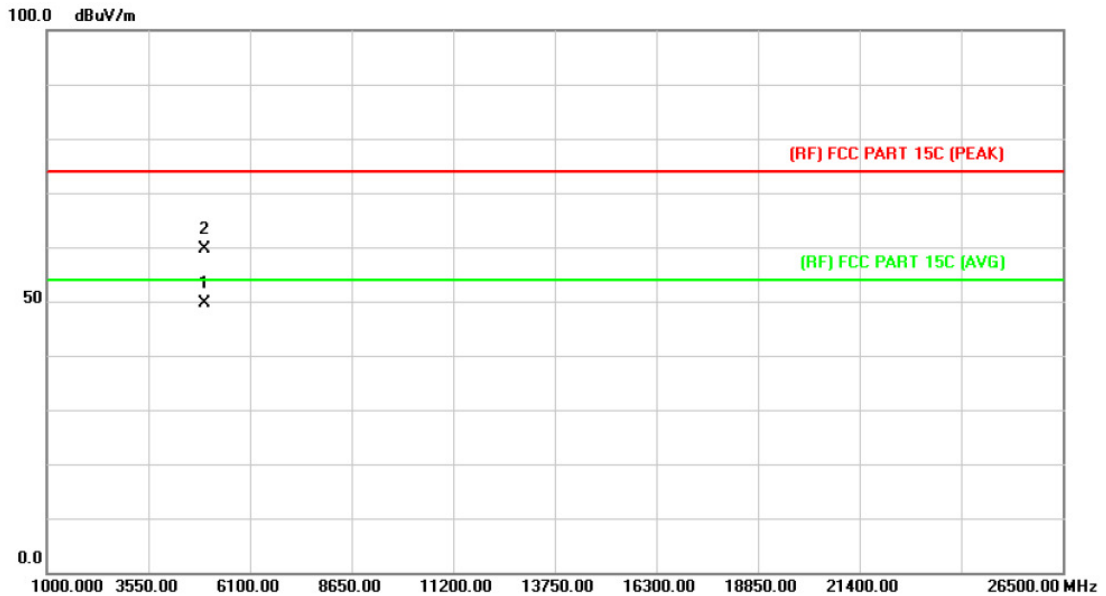

No.	Mk.	Freq.	Reading Level	Correct Factor	Measurement	Limit	Over	Detector
		MHz	dBuV	dB/m	dBuV/m	dBuV/m	dB	
1	*	4960.111	35.39	14.36	49.75	54.00	-4.25	AVG
2		4960.291	45.32	14.36	59.68	74.00	-14.32	peak

Emission Level= Read Level+ Correct Factor

## 6. Restricted Bands Requirement

### 6.1 Test Standard and Limit

- 6.1.1 Test Standard
  - FCC Part 15.209
  - FCC Part 15.205
- 6.1.2 Test Limit

Restricted Frequency Band (MHz)	Class B (dBuV/m)(at 3m)	
	Peak	Average
2310 ~2390	74	54
2483.5 ~2500	74	54

**Note: All restriction bands have been tested, only the worst case is reported.**

### 6.2 Test Setup

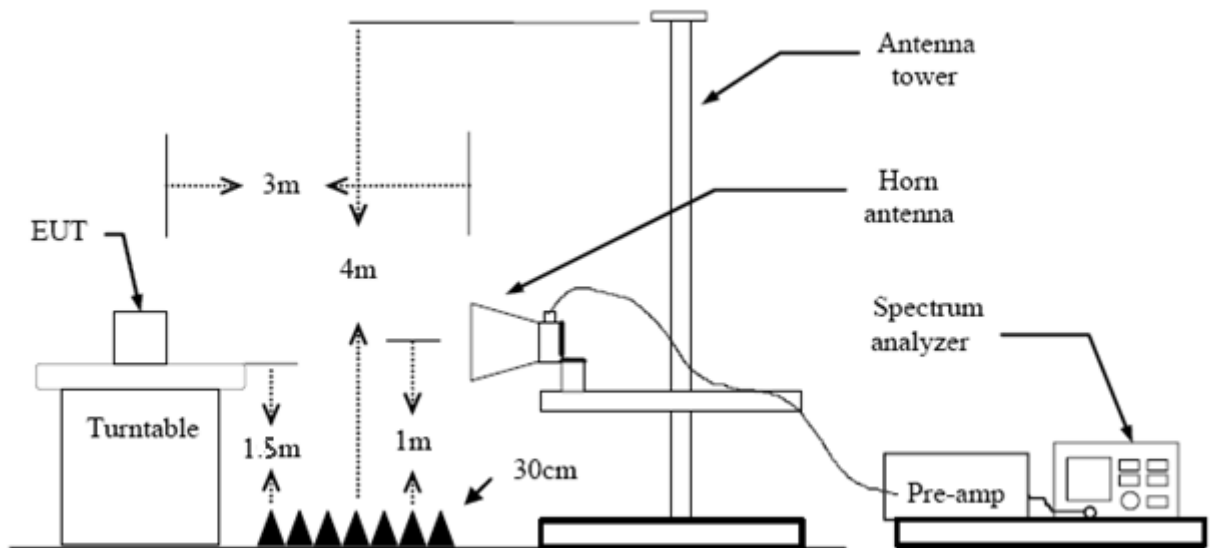

### 6.3 Test Procedure

- (1) The measuring distance of 3m shall be used for measurements at frequency up to 1GHz and above 1 GHz. The EUT was placed on a rotating 0.8m high above ground, the table was rotated 360 degrees to determine the position of the highest radiation.
- (2) Measurements at frequency above 1GHz. The EUT was placed on a rotating 1.5m high above the ground. RF absorbers covered the ground plane with a minimum area of 3.0m by 3.0m between the EUT and measurement receiver antenna. The RF absorber shall not exceed 30cm in high above the conducting floor. The table was rotated 360 degrees to determine the position of the highest radiation.

- (3) The Test antenna shall vary between 1m and 4m, Both Horizontal and Vertical antenna are set to make measurement.
- (4) The initial step in collecting conducted emission data is a spectrum analyzer peak detector mode pre-scanning the measurement frequency range. Significant peaks are then marked and then Quasi Peak detector mode re-measured.
- (5) If the Peak Mode measured value compliance with and lower than Quasi Peak Mode Limit Bellow 1 GHz, the EUT shall be deemed to meet QP Limits and then no additional QP Mode measurement performed. But the Peak Value and average value both need to comply with applicable limit above 1 GHz.
- (6) Testing frequency range below 1GHz the measuring instrument use VBW=120 kHz with Quasi-peak detection.
- (7) Testing frequency range above 1GHz the measuring instrument use RBW=1 MHz and VBW=3 MHz with Peak Detector for Peak Values, and use RBW=1 MHz and VBW=10 Hz with Peak Detector for Average Values.
- (8) For the actual test configuration, please see the test setup photo.

#### 6.4 EUT Operating Condition

The Equipment Under Test was set to Continual Transmitting in maximum power.

#### 6.4 Test Data

Remark: During testing above 1GHz the measuring instrument use RBW=1 MHz and VBW=3 MHz with Peak Detector for Peak Values, and use RBW=1 MHz and VBW=1 KHz with Peak Detector for Average Values.

All restriction bands have been tested, only the worst case is reported.

## (1) Radiation Test

<b>EUT:</b>	Bluetooth speaker	<b>Model Name :</b>	MA-2241
<b>Temperature:</b>	25 °C	<b>Relative Humidity:</b>	55%
<b>Test Voltage:</b>	DC 5V		
<b>Ant. Pol.</b>	Horizontal		
<b>Test Mode:</b>	TX GFSK Mode 2402MHz		
<b>Remark:</b>	N/A		

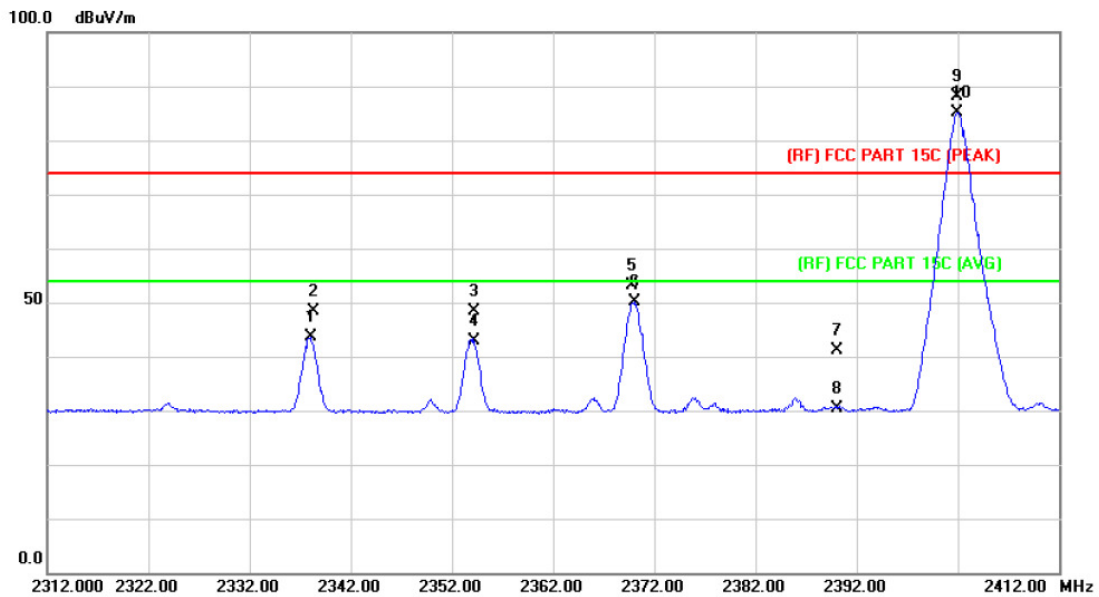

No.	Mk.	Freq. MHz	Reading Level dBuV	Correct Factor dB/m	Measure- ment dBuV/m	Limit dBuV/m	Over dB	Detector
1		2338.000	42.96	0.55	43.51	54.00	-10.49	AVG
2		2338.300	47.71	0.56	48.27	74.00	-25.73	peak
3		2354.200	47.66	0.62	48.28	74.00	-25.72	peak
4		2354.200	42.16	0.62	42.78	54.00	-11.22	AVG
5		2369.800	52.55	0.68	53.23	74.00	-20.77	peak
6		2370.000	49.49	0.69	50.18	54.00	-3.82	AVG
7		2390.000	40.27	0.77	41.04	74.00	-32.96	peak
8		2390.000	29.59	0.77	30.36	54.00	-23.64	AVG
9	X	2401.900	87.36	0.82	88.18	Fundamental Frequency		peak
10	*	2401.900	84.33	0.82	85.15	Fundamental Frequency		AVG

Emission Level= Read Level+ Correct Factor



<b>EUT:</b>	Bluetooth speaker	<b>Model Name :</b>	MA-2241
<b>Temperature:</b>	25 °C	<b>Relative Humidity:</b>	55%
<b>Test Voltage:</b>	DC 5V		
<b>Ant. Pol.</b>	Vertical		
<b>Test Mode:</b>	TX GFSK Mode 2402MHz		
<b>Remark:</b>	N/A		

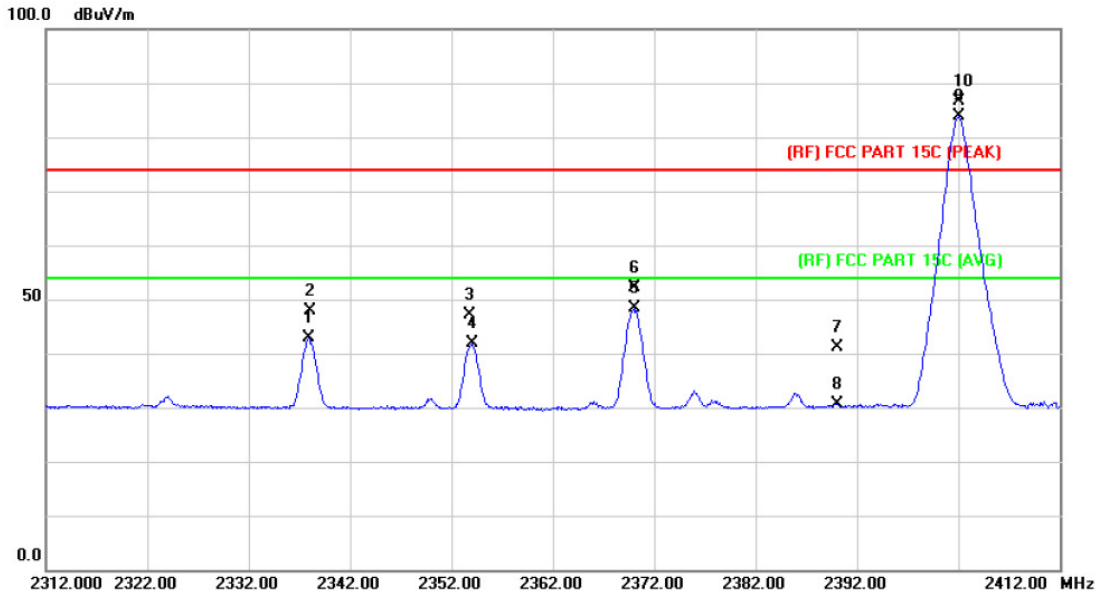

No.	Mk.	Freq. MHz	Reading Level dBuV	Correct Factor dB/m	Measure- ment dBuV/m	Limit dBuV/m	Over dB	Detector
1		2337.900	42.23	0.55	42.78	54.00	-11.22	AVG
2		2338.100	47.42	0.56	47.98	74.00	-26.02	peak
3		2353.800	46.60	0.62	47.22	74.00	-26.78	peak
4		2354.000	41.22	0.62	41.84	54.00	-12.16	AVG
5		2370.000	47.72	0.69	48.41	54.00	-5.59	AVG
6		2370.100	51.44	0.69	52.13	74.00	-21.87	peak
7		2390.000	40.35	0.77	41.12	74.00	-32.88	peak
8		2390.000	29.84	0.77	30.61	54.00	-23.39	AVG
9	*	2402.000	82.98	0.82	83.80	Fundamental Frequency		AVG
10	X	2402.100	85.69	0.82	86.51	Fundamental Frequency		peak

Emission Level= Read Level+ Correct Factor

<b>EUT:</b>	Bluetooth speaker	<b>Model Name :</b>	MA-2241
<b>Temperature:</b>	25 °C	<b>Relative Humidity:</b>	55%
<b>Test Voltage:</b>	DC 5V		
<b>Ant. Pol.</b>	Horizontal		
<b>Test Mode:</b>	TX GFSK Mode 2480 MHz		
<b>Remark:</b>	N/A		

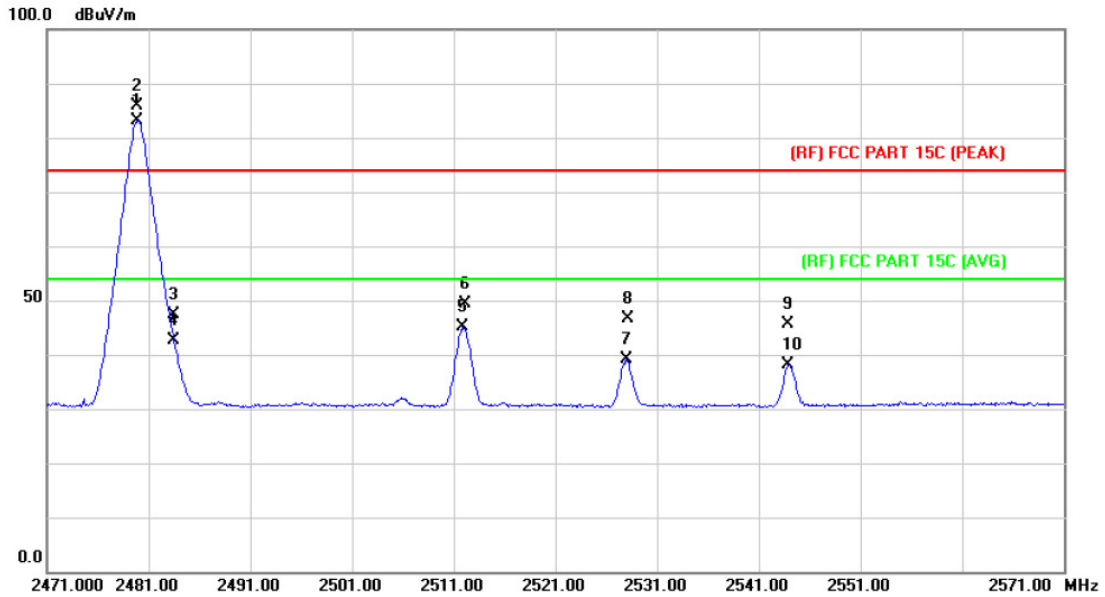

No.	Mk.	Freq. MHz	Reading Level dBuV	Correct Factor dB/m	Measure- ment dBuV/m	Limit dBuV/m	Over dB	Detector
1	*	2479.800	81.94	1.15	83.09	Fundamental Frequency		AVG
2	X	2479.900	84.72	1.15	85.87	Fundamental Frequency		peak
3		2483.500	46.11	1.17	47.28	74.00	-26.72	peak
4		2483.500	41.45	1.17	42.62	54.00	-11.38	AVG
5		2511.800	43.71	1.31	45.02	54.00	-8.98	AVG
6		2512.100	48.02	1.32	49.34	74.00	-24.66	peak
7		2528.000	37.85	1.40	39.25	54.00	-14.75	AVG
8		2528.100	45.31	1.40	46.71	74.00	-27.29	peak
9		2543.900	44.22	1.49	45.71	74.00	-28.29	peak
10		2543.900	36.70	1.49	38.19	54.00	-15.81	AVG

Emission Level= Read Level+ Correct Factor

<b>EUT:</b>	Bluetooth speaker	<b>Model Name :</b>	MA-2241
<b>Temperature:</b>	25 °C	<b>Relative Humidity:</b>	55%
<b>Test Voltage:</b>	DC 5V		
<b>Ant. Pol.</b>	Vertical		
<b>Test Mode:</b>	TX GFSK Mode 2480 MHz		
<b>Remark:</b>	N/A		

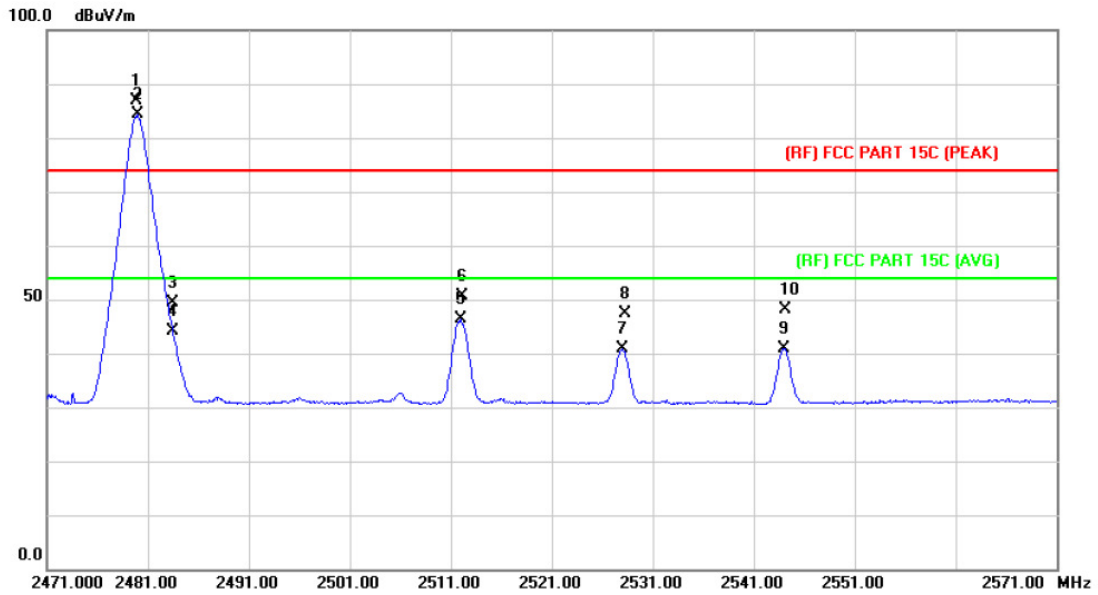

No.	Mk.	Freq. MHz	Reading Level dBuV	Correct Factor dB/m	Measure- ment dBuV/m	Limit dBuV/m	Over dB	Detector
1	X	2479.900	85.78	1.15	86.93	Fundamental Frequency		peak
2	*	2480.000	83.11	1.15	84.26	Fundamental Frequency		AVG
3		2483.500	48.17	1.17	49.34	74.00	-24.66	peak
4		2483.500	42.84	1.17	44.01	54.00	-9.99	AVG
5		2512.000	45.00	1.31	46.31	54.00	-7.69	AVG
6		2512.100	49.27	1.32	50.59	74.00	-23.41	peak
7		2528.000	39.43	1.40	40.83	54.00	-13.17	AVG
8		2528.300	45.97	1.40	47.37	74.00	-26.63	peak
9		2544.000	39.49	1.49	40.98	54.00	-13.02	AVG
10		2544.100	46.57	1.49	48.06	74.00	-25.94	peak

Emission Level= Read Level+ Correct Factor

<b>EUT:</b>	Bluetooth speaker	<b>Model Name :</b>	MA-2241
<b>Temperature:</b>	25 °C	<b>Relative Humidity:</b>	55%
<b>Test Voltage:</b>	DC 5V		
<b>Ant. Pol.</b>	Horizontal		
<b>Test Mode:</b>	TX 8-DPSK Mode 2402MHz		
<b>Remark:</b>	N/A		

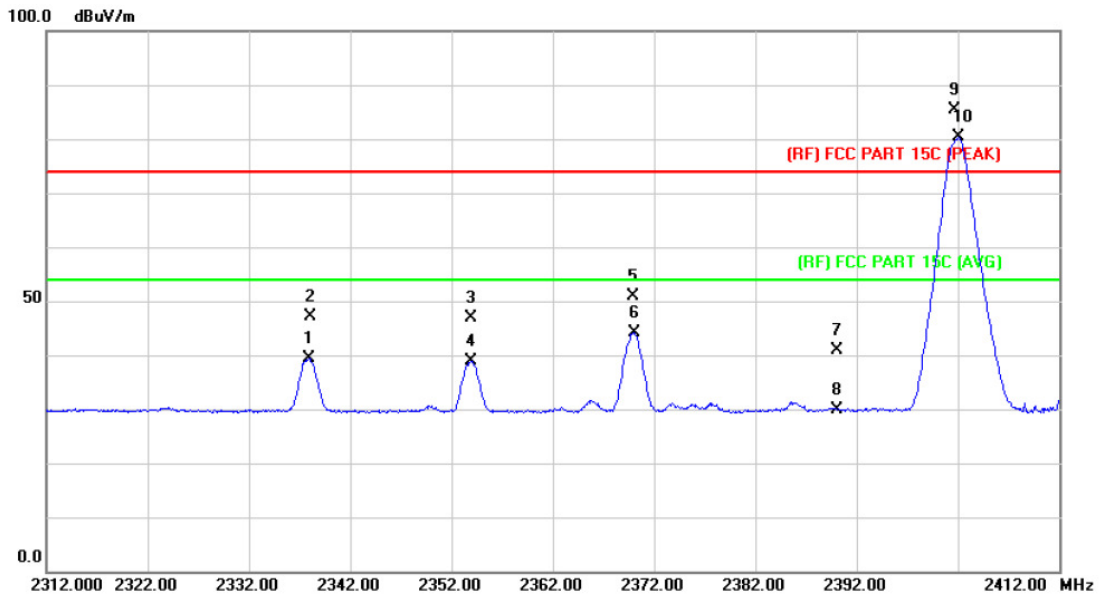

No. Mk.	Freq. MHz	Reading Level dBuV	Correct Factor dB/m	Measure- ment dBuV/m	Limit dBuV/m	Over dB	Detector
1	2337.900	38.78	0.55	39.33	54.00	-14.67	AVG
2	2338.100	46.51	0.56	47.07	74.00	-26.93	peak
3	2353.900	46.20	0.62	46.82	74.00	-27.18	peak
4	2353.900	38.26	0.62	38.88	54.00	-15.12	AVG
5	2369.900	50.25	0.68	50.93	74.00	-23.07	peak
6	2370.000	43.48	0.69	44.17	54.00	-9.83	AVG
7	2390.000	40.07	0.77	40.84	74.00	-33.16	peak
8	2390.000	29.07	0.77	29.84	54.00	-24.16	AVG
9	X 2401.700	84.66	0.82	85.48	Fundamental Frequency		peak
10	* 2402.000	79.52	0.82	80.34	Fundamental Frequency		AVG

Emission Level= Read Level+ Correct Factor

<b>EUT:</b>	Bluetooth speaker	<b>Model Name :</b>	MA-2241
<b>Temperature:</b>	25 °C	<b>Relative Humidity:</b>	55%
<b>Test Voltage:</b>	DC 5V		
<b>Ant. Pol.</b>	Vertical		
<b>Test Mode:</b>	TX 8-DPSK Mode 2402MHz		
<b>Remark:</b>	N/A		

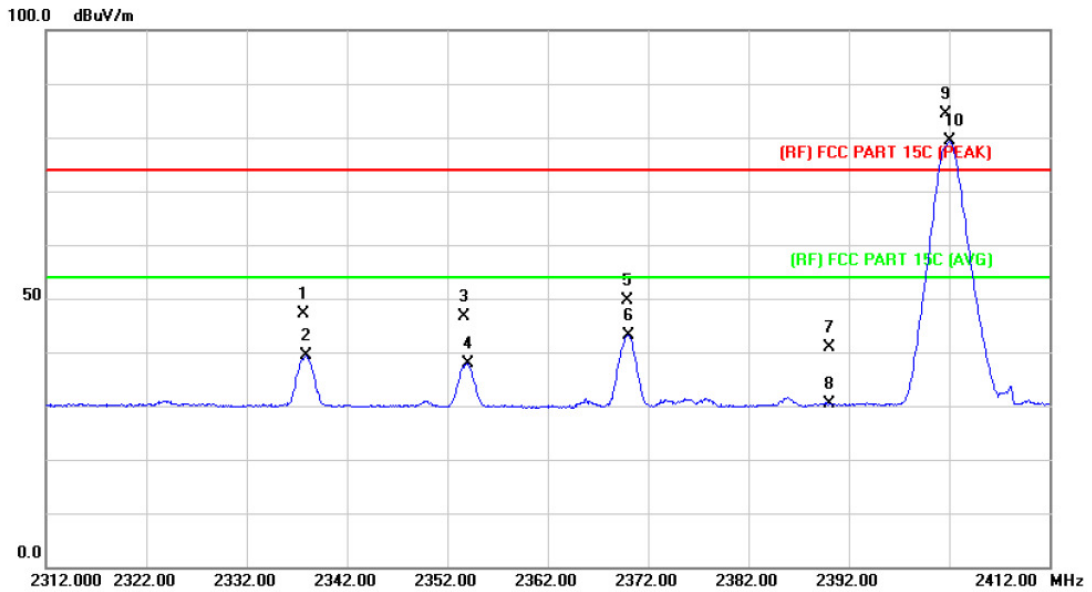

No.	Mk.	Freq. MHz	Reading Level dBuV	Correct Factor dB/m	Measure- ment dBuV/m	Limit dBuV/m	Over dB	Detector
1		2337.700	46.50	0.55	47.05	74.00	-26.95	peak
2		2337.900	38.83	0.55	39.38	54.00	-14.62	AVG
3		2353.700	45.90	0.62	46.52	74.00	-27.48	peak
4		2354.000	37.17	0.62	37.79	54.00	-16.21	AVG
5		2369.900	49.00	0.68	49.68	74.00	-24.32	peak
6		2370.100	42.53	0.69	43.22	54.00	-10.78	AVG
7		2390.000	40.20	0.77	40.97	74.00	-33.03	peak
8		2390.000	29.60	0.77	30.37	54.00	-23.63	AVG
9	X	2401.700	83.57	0.82	84.39	Fundamental Frequency		peak
10	*	2402.000	78.55	0.82	79.37	Fundamental Frequency		AVG

Emission Level= Read Level+ Correct Factor

<b>EUT:</b>	Bluetooth speaker	<b>Model Name :</b>	MA-2241
<b>Temperature:</b>	25 °C	<b>Relative Humidity:</b>	55%
<b>Test Voltage:</b>	DC 5V		
<b>Ant. Pol.</b>	Horizontal		
<b>Test Mode:</b>	TX 8-DPSK Mode 2480MHz		
<b>Remark:</b>	N/A		

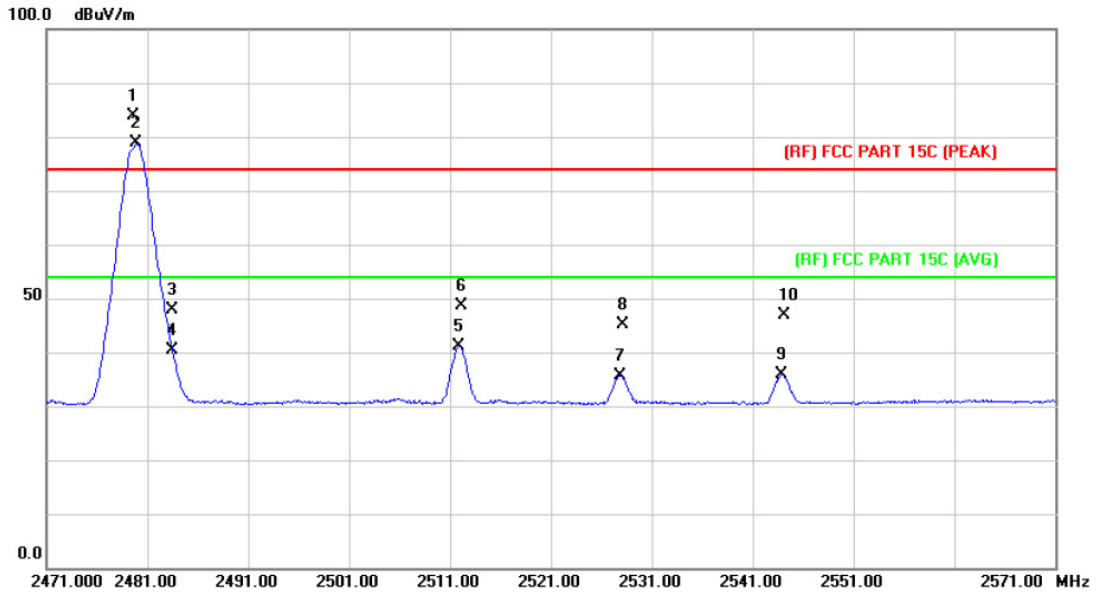

No.	Mk.	Freq. MHz	Reading Level dBuV	Correct Factor dB/m	Measure- ment dBuV/m	Limit dBuV/m	Over dB	Detector
1	X	2479.600	82.73	1.15	83.88	Fundamental Frequency		peak
2	*	2479.900	77.69	1.15	78.84	Fundamental Frequency		AVG
3		2483.500	46.74	1.17	47.91	74.00	-26.09	peak
4		2483.500	39.10	1.17	40.27	54.00	-13.73	AVG
5		2511.800	39.81	1.31	41.12	54.00	-12.88	AVG
6		2512.200	47.30	1.32	48.62	74.00	-25.38	peak
7		2527.800	34.34	1.40	35.74	54.00	-18.26	AVG
8		2528.100	43.82	1.40	45.22	74.00	-28.78	peak
9		2543.900	34.49	1.49	35.98	54.00	-18.02	AVG
10		2544.100	45.46	1.49	46.95	74.00	-27.05	peak

Emission Level= Read Level+ Correct Factor

<b>EUT:</b>	Bluetooth speaker	<b>Model Name :</b>	MA-2241
<b>Temperature:</b>	25 °C	<b>Relative Humidity:</b>	55%
<b>Test Voltage:</b>	DC 5V		
<b>Ant. Pol.</b>	Vertical		
<b>Test Mode:</b>	TX 8-DPSK Mode 2480MHz		
<b>Remark:</b>	N/A		

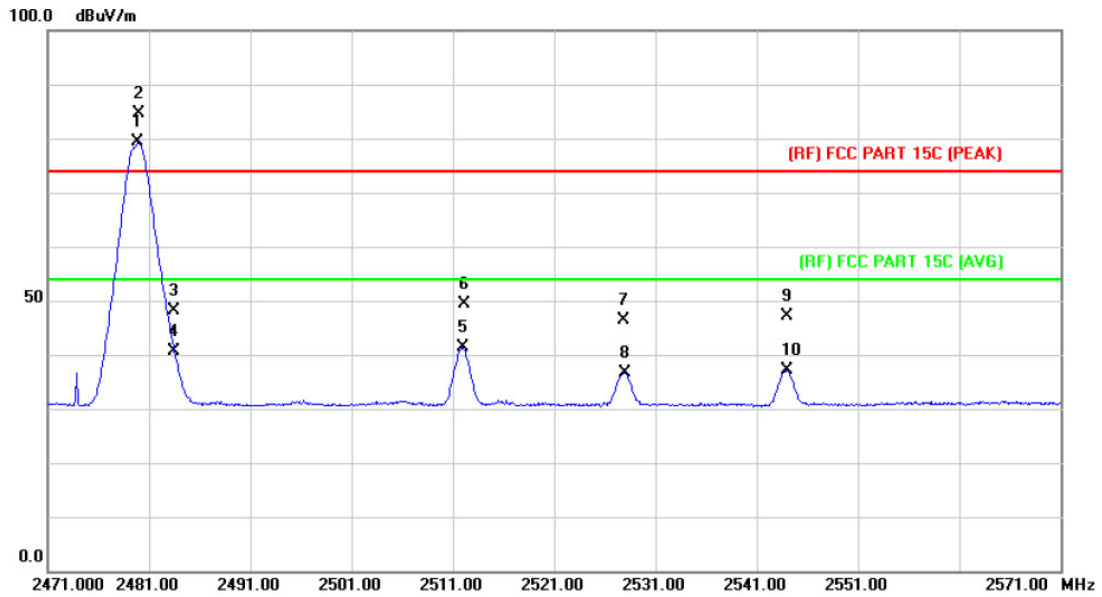

No.	Mk.	Freq. MHz	Reading Level dBuV	Correct Factor dB/m	Measure- ment dBuV/m	Limit dBuV/m	Over dB	Detector
1	*	2479.900	78.19	1.15	79.34	Fundamental Frequency		AVG
2	X	2480.000	83.56	1.15	84.71	Fundamental Frequency		peak
3		2483.500	46.86	1.17	48.03	74.00	-25.97	peak
4		2483.500	39.35	1.17	40.52	54.00	-13.48	AVG
5		2512.000	40.01	1.31	41.32	54.00	-12.68	AVG
6		2512.100	48.02	1.32	49.34	74.00	-24.66	peak
7		2527.800	44.94	1.40	46.34	74.00	-27.66	peak
8		2528.000	35.30	1.40	36.70	54.00	-17.30	AVG
9		2544.000	45.58	1.49	47.07	74.00	-26.93	peak
10		2544.000	35.68	1.49	37.17	54.00	-16.83	AVG

Emission Level= Read Level+ Correct Factor

**(2) Conducted Test**

<b>EUT:</b>	Bluetooth speaker	<b>Model Name :</b>	MA-2241
<b>Temperature:</b>	25 °C	<b>Relative Humidity:</b>	55%
<b>Test Voltage:</b>	DC 5V		
<b>Test Mode:</b>	TX GFSK Mode 2402MHz / 2480 MHz		
<b>Remark:</b>	N/A		

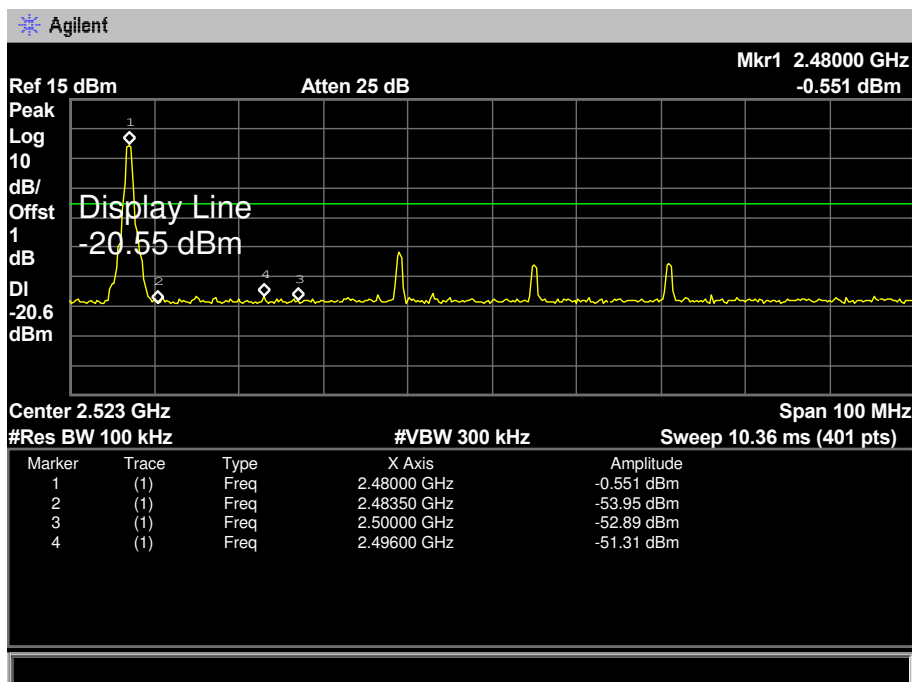
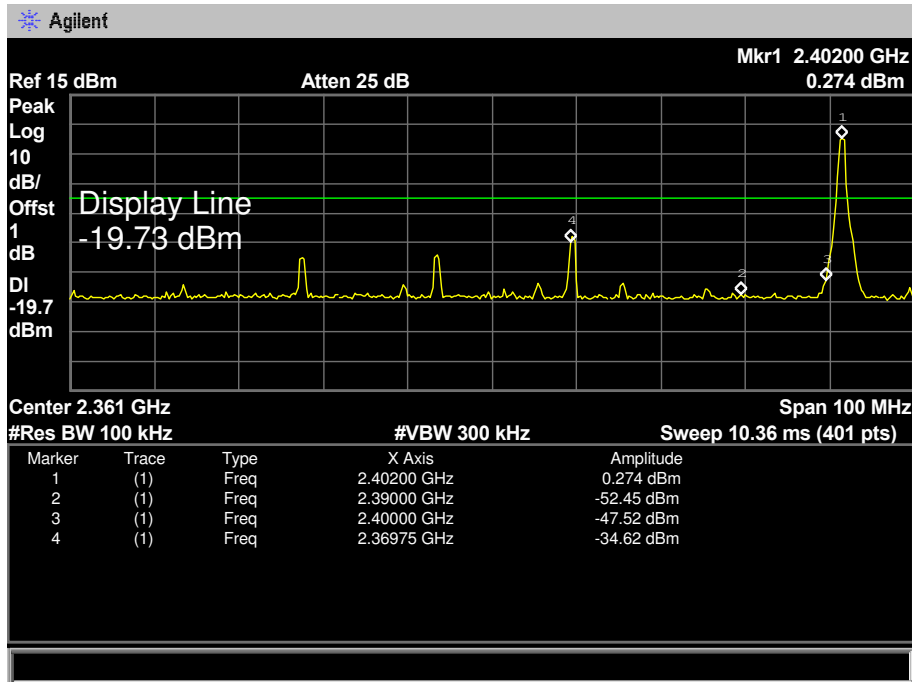



<b>EUT:</b>	Bluetooth speaker	<b>Model Name :</b>	MA-2241
<b>Temperature:</b>	25 °C	<b>Relative Humidity:</b>	55%
<b>Test Voltage:</b>	DC 5V		
<b>Test Mode:</b>	GFSK Hopping Mode		
<b>Remark:</b>	N/A		

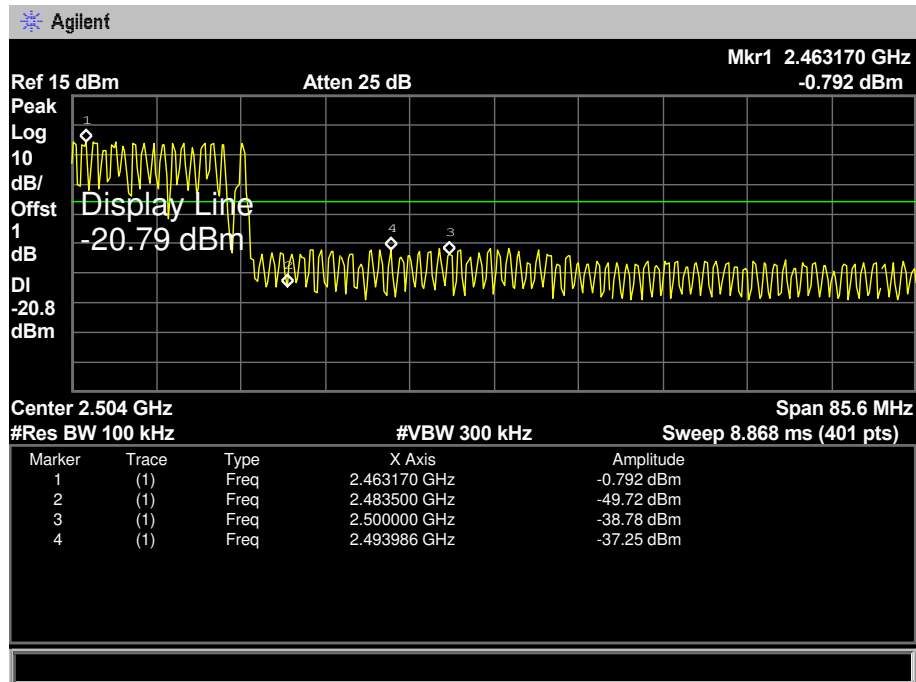
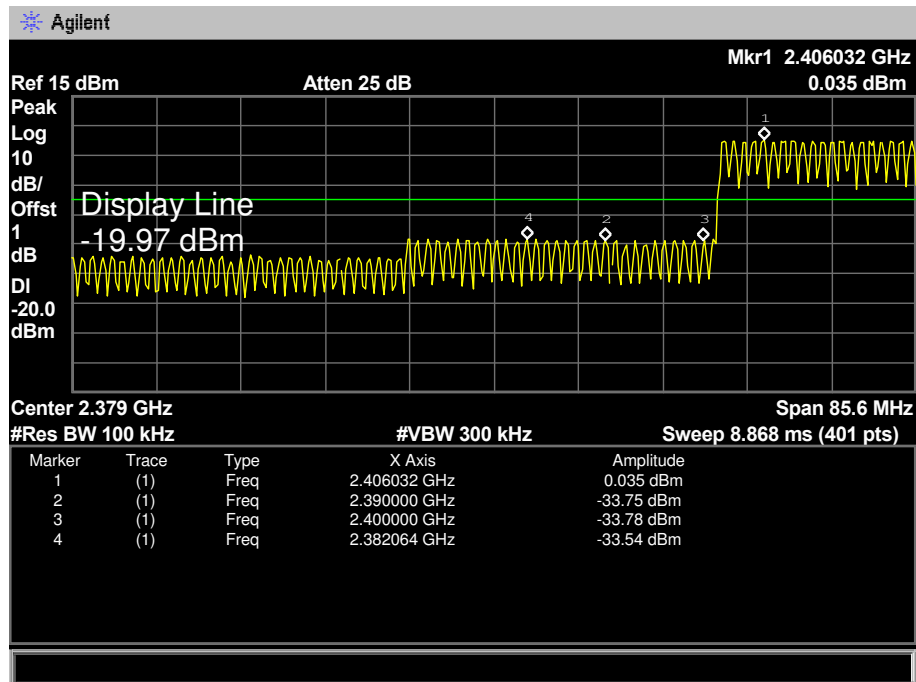

<b>EUT:</b>	Bluetooth speaker	<b>Model Name :</b>	MA-2241
<b>Temperature:</b>	25 °C	<b>Relative Humidity:</b>	55%
<b>Test Voltage:</b>	DC 5V		
<b>Test Mode:</b>	TX 8-DPSK Mode 2402MHz / 2480 MHz		
<b>Remark:</b>	N/A		

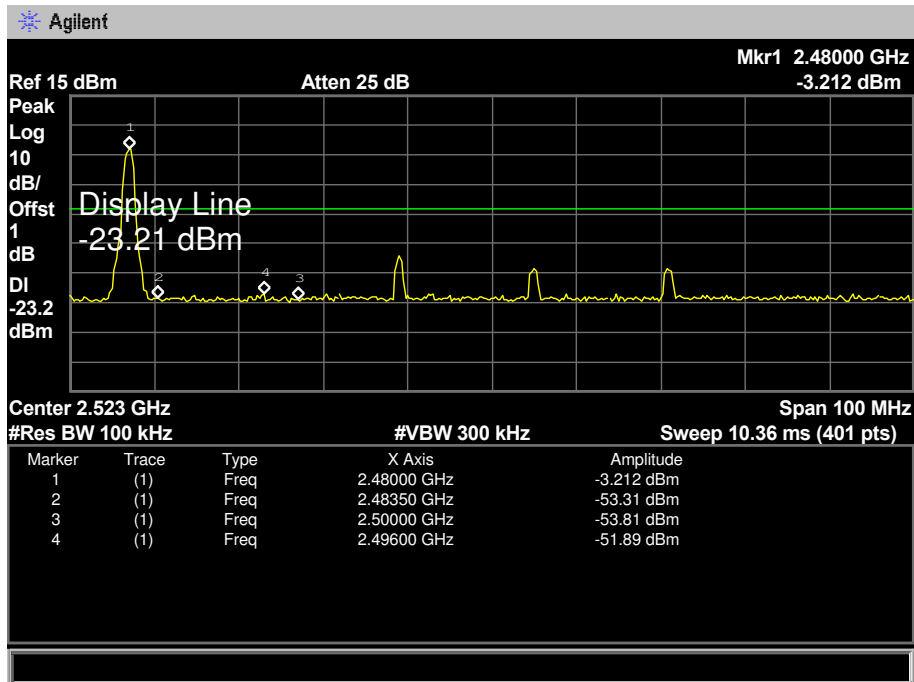
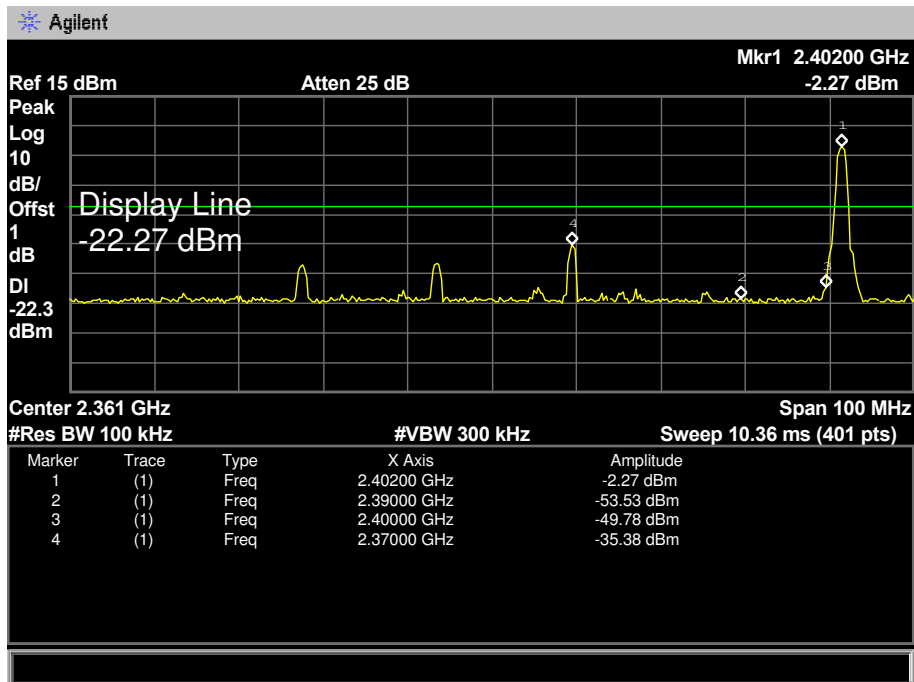

<b>EUT:</b>	Bluetooth speaker	<b>Model Name :</b>	MA-2241
<b>Temperature:</b>	25 °C	<b>Relative Humidity:</b>	55%
<b>Test Voltage:</b>	DC 5V		
<b>Test Mode:</b>	8-DPSK Hopping Mode		
<b>Remark:</b>	N/A		

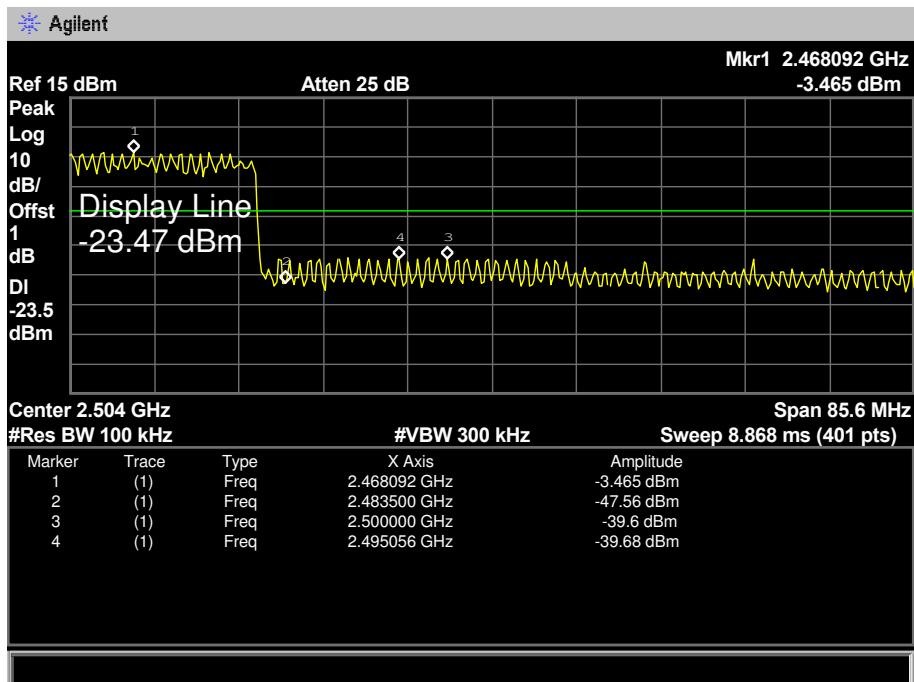
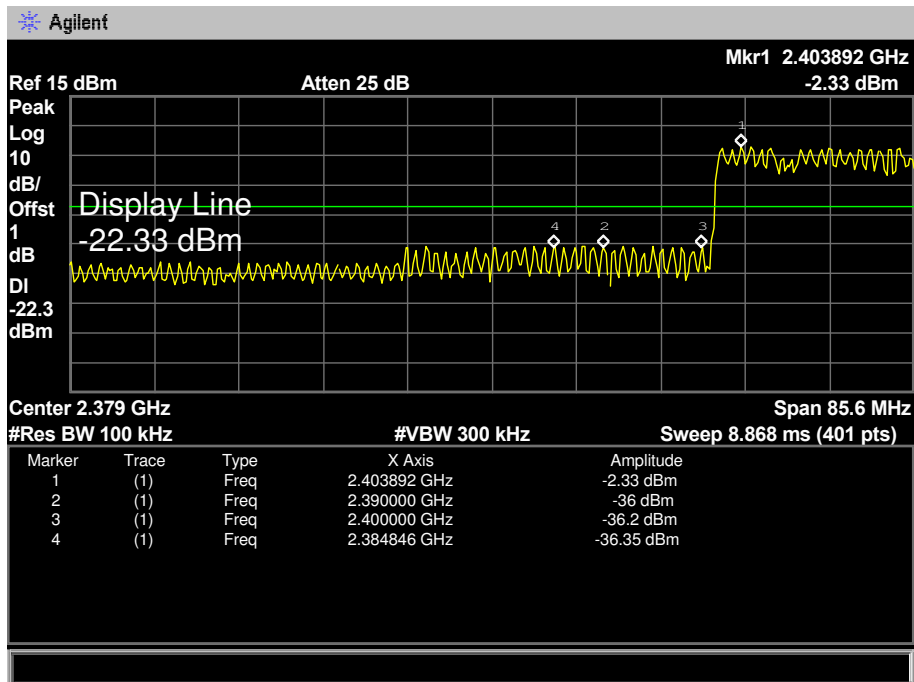

## 7. Number of Hopping Channel

### 7.1 Test Standard and Limit

#### 6.1.1 Test Standard

FCC Part 15.247 (a)(1)

#### 6.1.2 Test Limit

Section	Test Item	Limit
15.247	Number of Hopping Channel	>15

### 7.2 Test Setup

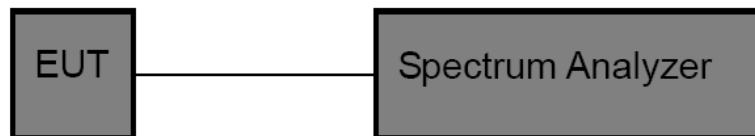

### 7.3 Test Procedure

- (1) The EUT was directly connected to the spectrum analyzer and antenna output port as show in the block diagram above.
- (2) Spectrum Setting: RBW=100 KHz, VBW=100 KHz, Sweep time= Auto.

### 7.4 EUT Operating Condition

The EUT was set to the Hopping Mode by the Customer.

### 7.5 Test Data

<b>EUT:</b>	Bluetooth speaker	<b>Model Name :</b>	MA-2241
<b>Temperature:</b>	25 °C	<b>Relative Humidity:</b>	55%
<b>Test Voltage:</b>	DC 5V		
<b>Test Mode:</b>	Hopping Mode (GFSK/8-DPSK)		
<b>Frequency Range</b>	<b>Quantity of Hopping Channel</b>		<b>Limit</b>
2402MHz~2480MHz	79		>15
	79		

**GFSK Mode**

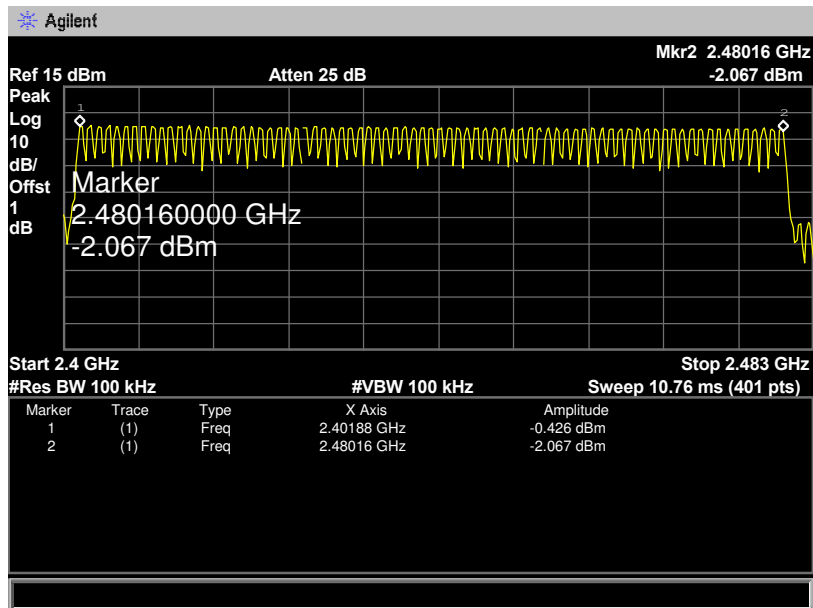

**8-DPSK Mode**

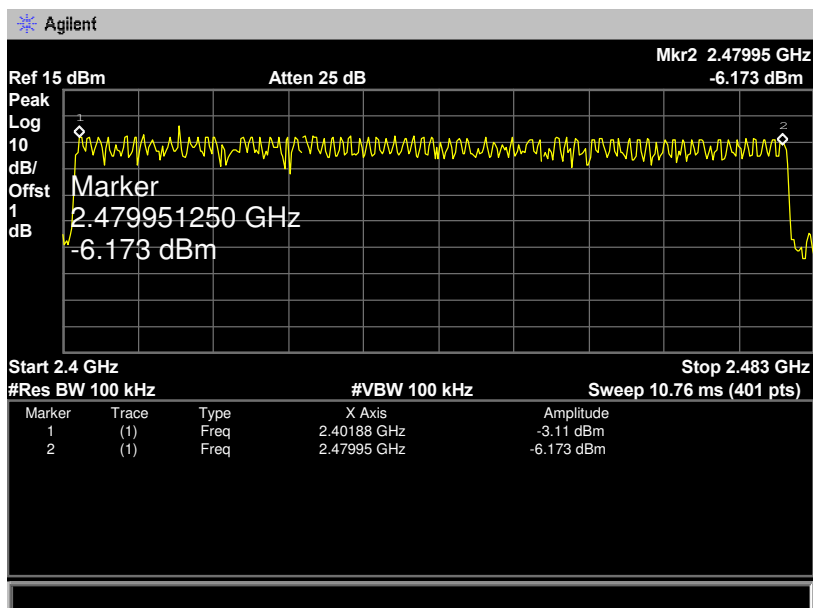

## 8. Average Time of Occupancy

### 8.1 Test Standard and Limit

- 8.1.1 Test Standard  
FCC Part 15.247 (a)(1)
- 8.1.2 Test Limit

Section	Test Item	Limit
15.247(a)(1)/ RSS-210 Annex 8(A8.1d)	Average Time of Occupancy	0.4 sec

### 8.2 Test Setup

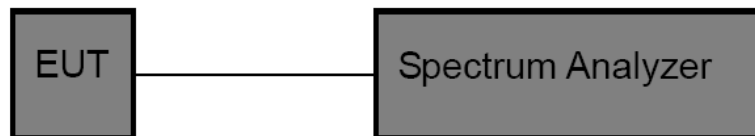

### 8.3 Test Procedure

- (1) The EUT was directly connected to the spectrum analyzer and antenna output port as show in the block diagram above.
- (2) Spectrum Setting: RBW=1MHz, VBW=1MHz.
- (3) Use video trigger with the trigger level set to enable triggering only on full pulses.
- (4) Sweep Time is more than once pulse time.
- (5) Set the center frequency on any frequency would be measure and set the frequency span to zero.
- (6) Measure the maximum time duration of one single pulse.
- (7) Set the EUT for packet transmitting.
- (8) Measure the maximum time duration of one single pulse.

### 8.4 EUT Operating Condition

The EUT was set to the Hopping Mode by the Customer.

8.5 Test Data

<b>EUT:</b>	Bluetooth speaker	<b>Model Name :</b>	MA-2241		
<b>Temperature:</b>	25 °C	<b>Relative Humidity:</b>	55%		
<b>Test Voltage:</b>	DC 5V				
<b>Test Mode:</b>	Hopping Mode (GFSK DH1)				
Channel (MHz)	Pulse Time (ms)	Total of Dwell (ms)	Period Time (s)	Limit (ms)	Result
2402	0.520	166.40	31.60	400	<b>PASS</b>
2441	0.520	166.40			
2480	0.520	166.40			

**GFSK Hopping Mode DH1**

**2402 MHz**

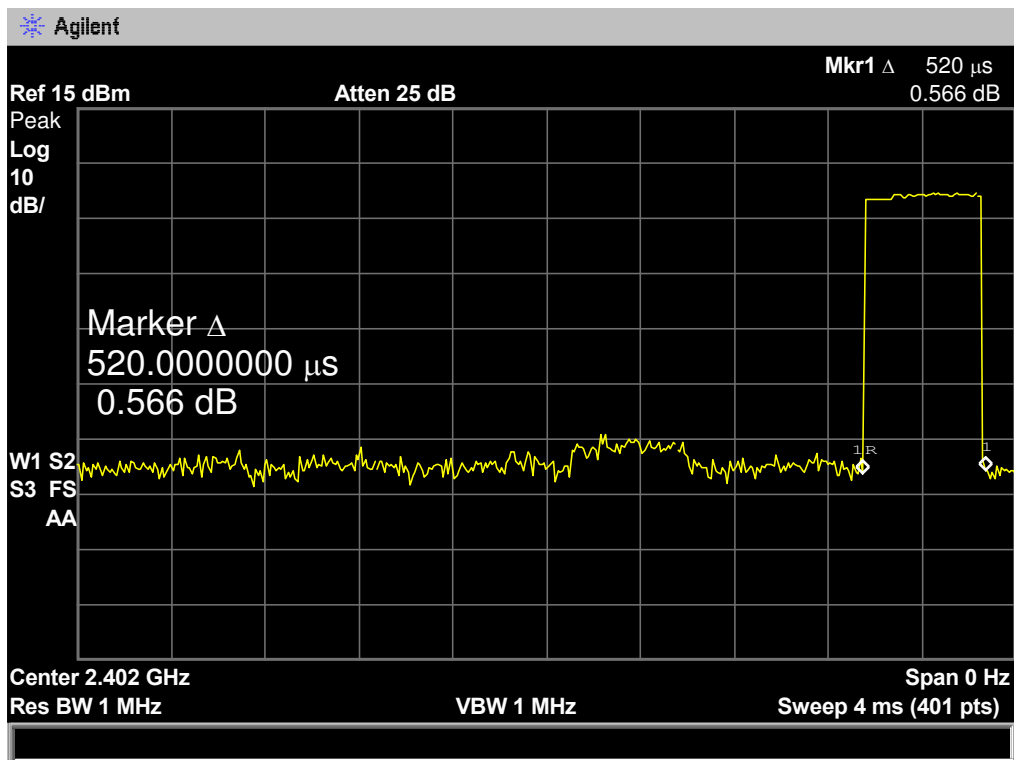

**GFSK Hopping Mode DH1**

**2441 MHz**

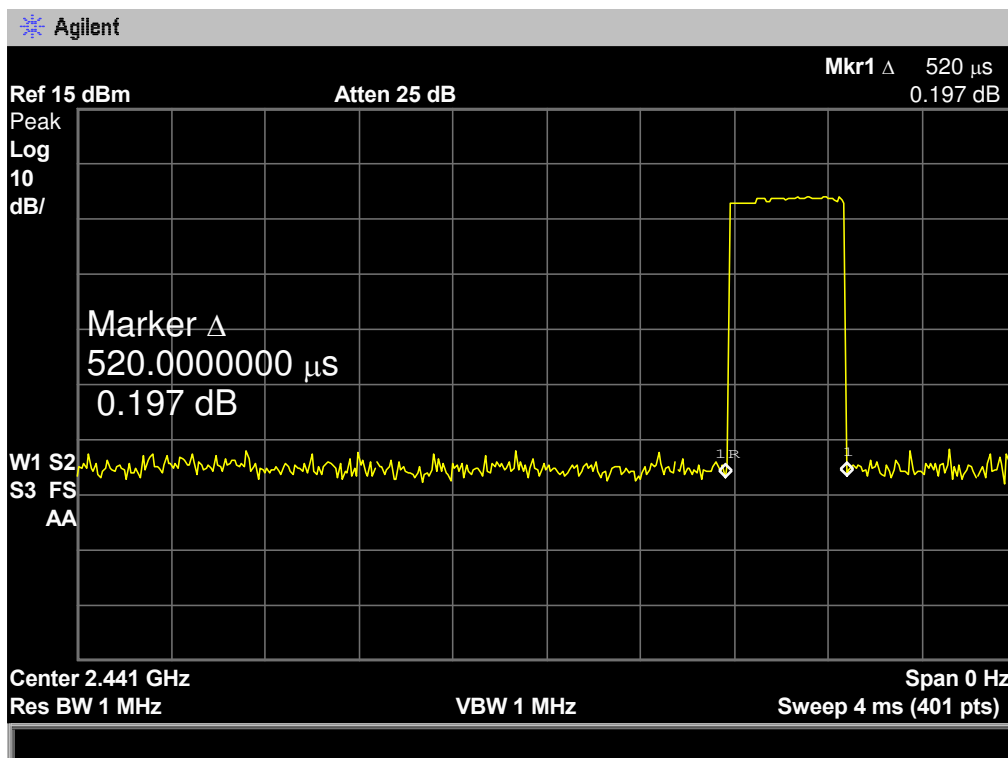

**GFSK Hopping Mode DH1**

**2480 MHz**

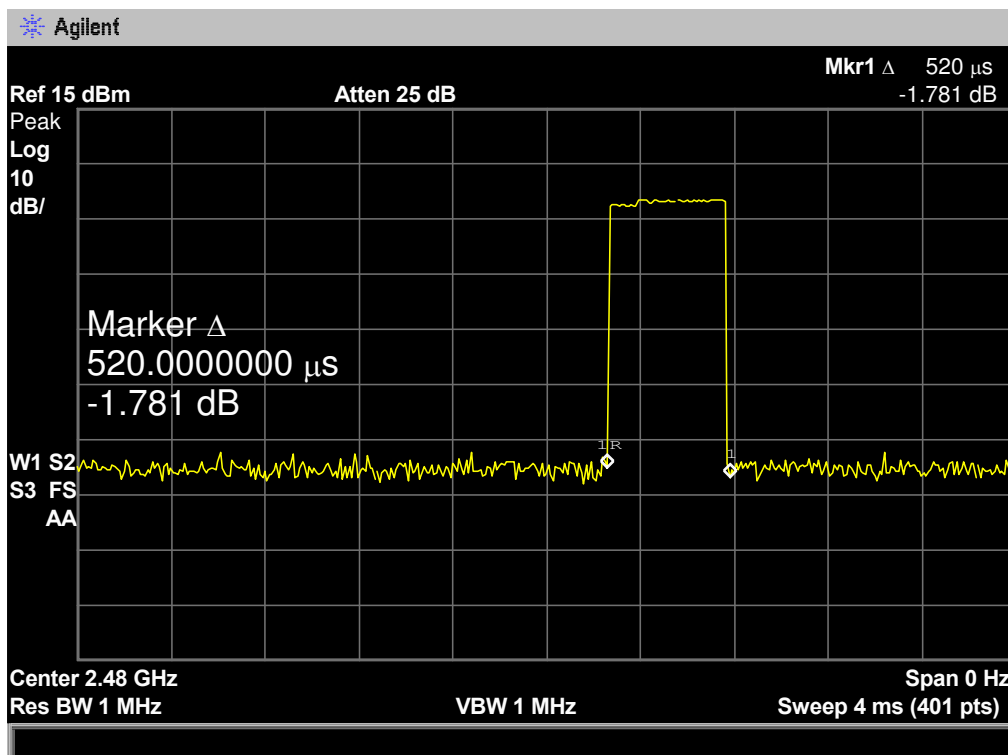



<b>EUT:</b>	Bluetooth speaker	<b>Model Name :</b>	MA-2241		
<b>Temperature:</b>	25 °C	<b>Relative Humidity:</b>	55%		
<b>Test Voltage:</b>	DC 5V				
<b>Test Mode:</b>	Hopping Mode (GFSK DH3)				
Channel (MHz)	Pulse Time (ms)	Total of Dwell (ms)	Period Time (s)	Limit (ms)	Result
2402	1.820	291.20	31.60	400	<b>PASS</b>
2441	1.820	291.20			
2480	1.820	291.20			

**GFSK Hopping Mode DH3**

**2402 MHz**

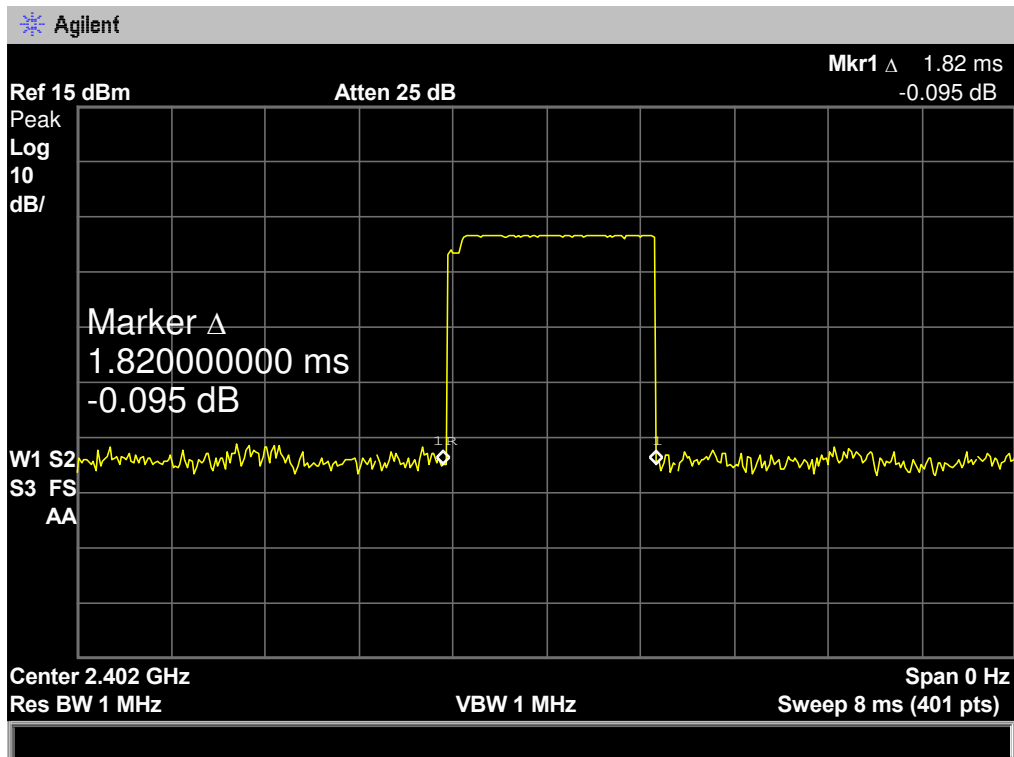

**GFSK Hopping Mode DH3**

**2441 MHz**

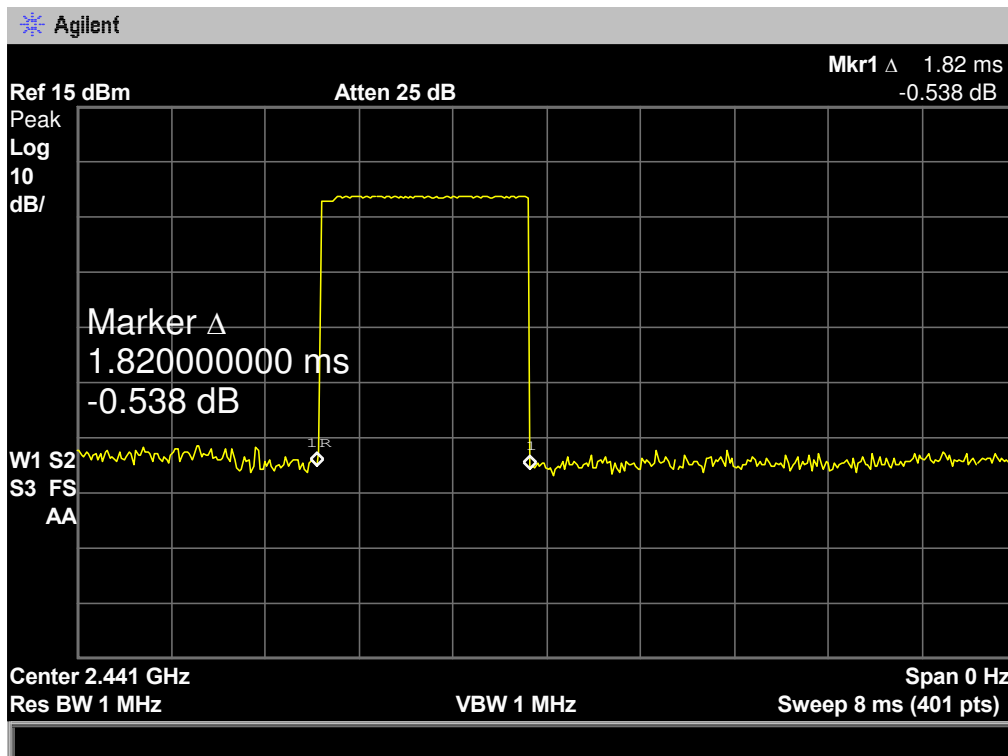

**GFSK Hopping Mode DH3**

**2480 MHz**

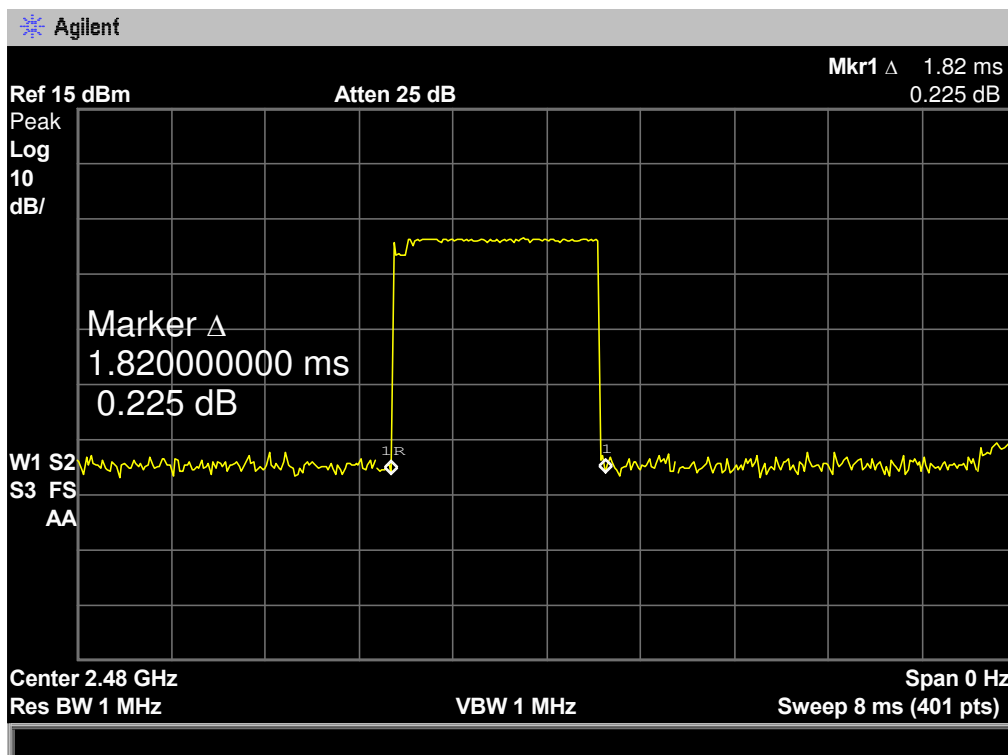

<b>EUT:</b>	Bluetooth speaker	<b>Model Name :</b>	MA-2241		
<b>Temperature:</b>	25 °C	<b>Relative Humidity:</b>	55%		
<b>Test Voltage:</b>	DC 5V				
<b>Test Mode:</b>	Hopping Mode (GFSK DH5)				
Channel (MHz)	Pulse Time (ms)	Total of Dwell (ms)	Period Time (s)	Limit (ms)	Result
2402	3.120	332.80	31.60	400	<b>PASS</b>
2441	3.120	332.80			
2480	3.120	332.80			

**GFSK Hopping Mode DH5**

**2402 MHz**

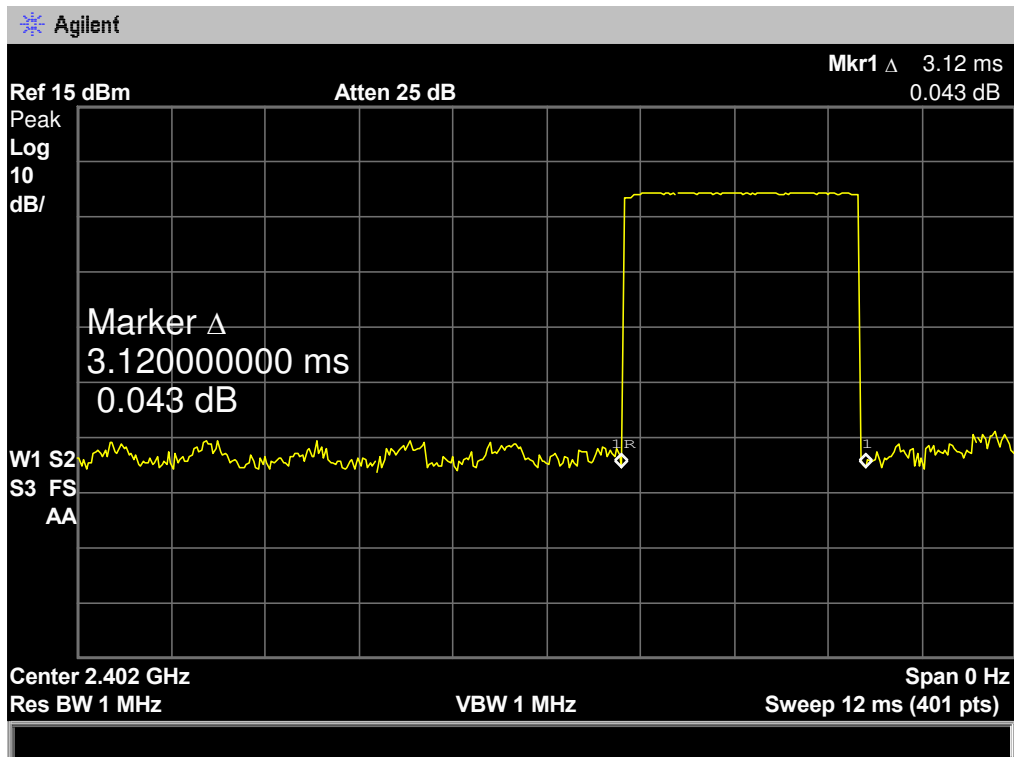

**GFSK Hopping Mode DH5**

**2441 MHz**

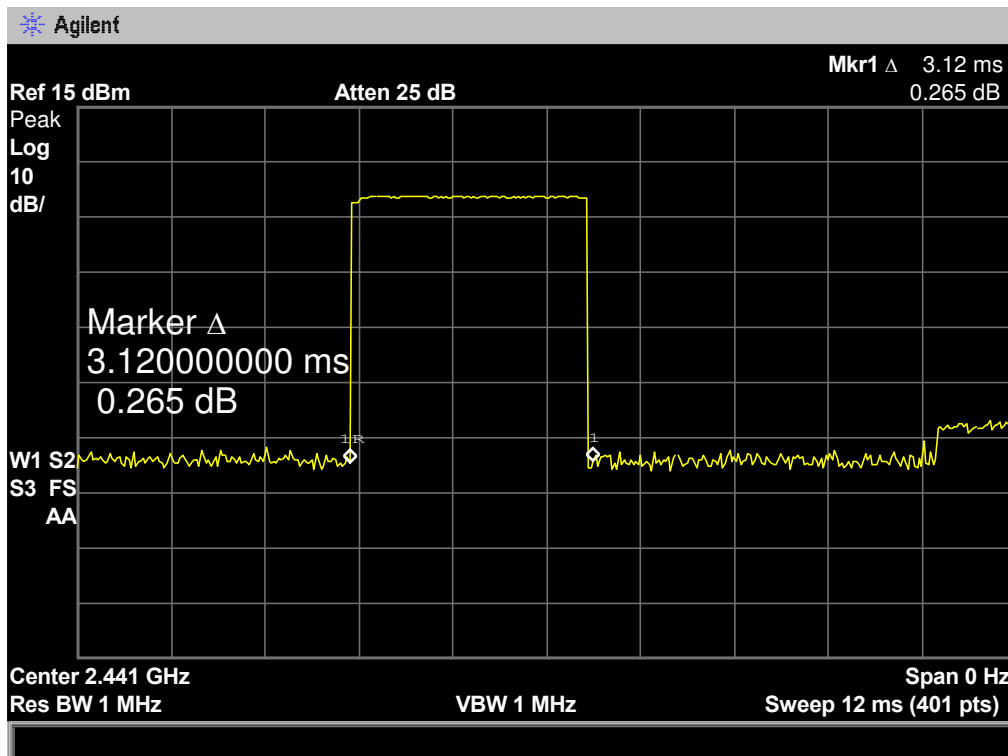

**GFSK Hopping Mode DH5**

**2480 MHz**

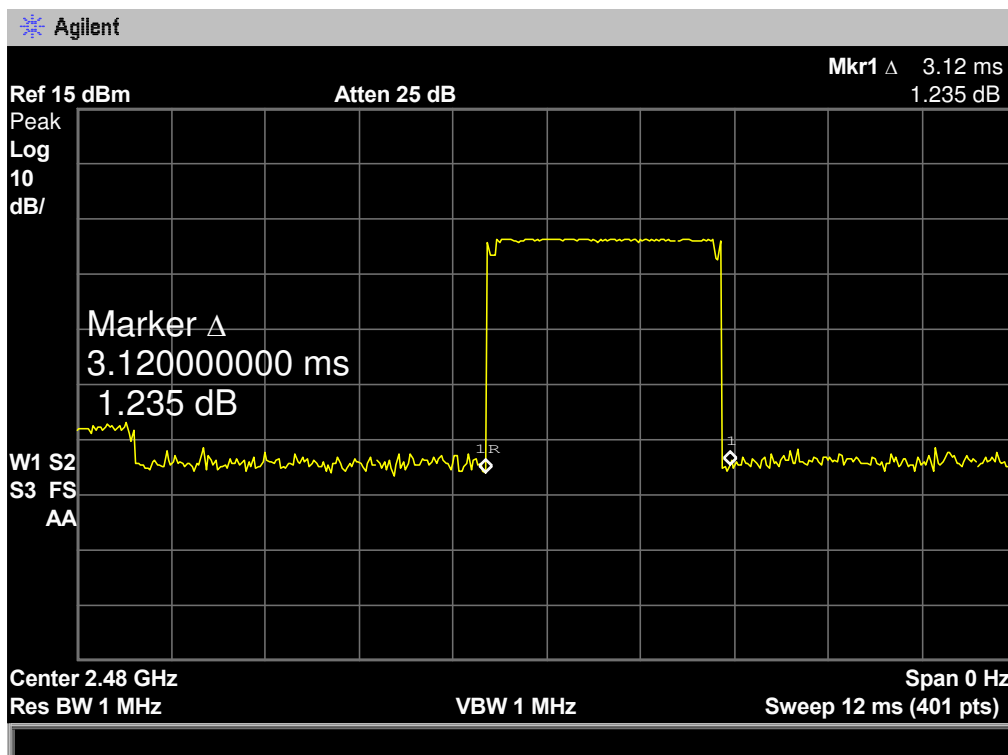

<b>EUT:</b>	Bluetooth speaker	<b>Model Name :</b>	MA-2241		
<b>Temperature:</b>	25 °C	<b>Relative Humidity:</b>	55%		
<b>Test Voltage:</b>	DC 5V				
<b>Test Mode:</b>	Hopping Mode ( $\pi/4$ -DQPSK DH1)				
Channel (MHz)	Pulse Time (ms)	Total of Dwell (ms)	Period Time (s)	Limit (ms)	Result
2402	0.520	166.40	31.60	400	<b>PASS</b>
2441	0.520	166.40			
2480	0.520	166.40			

$\pi/4$ -DQPSK Hopping Mode DH1

2402 MHz

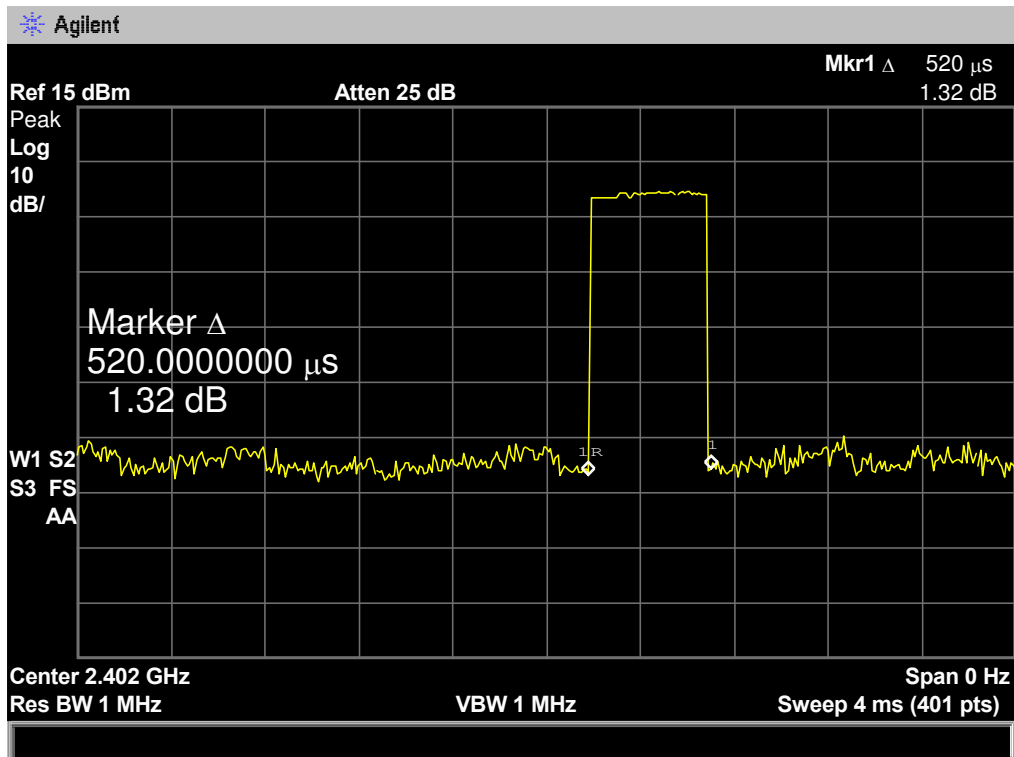

$\pi$  /4-DQPSK Hopping Mode DH1

2441 MHz

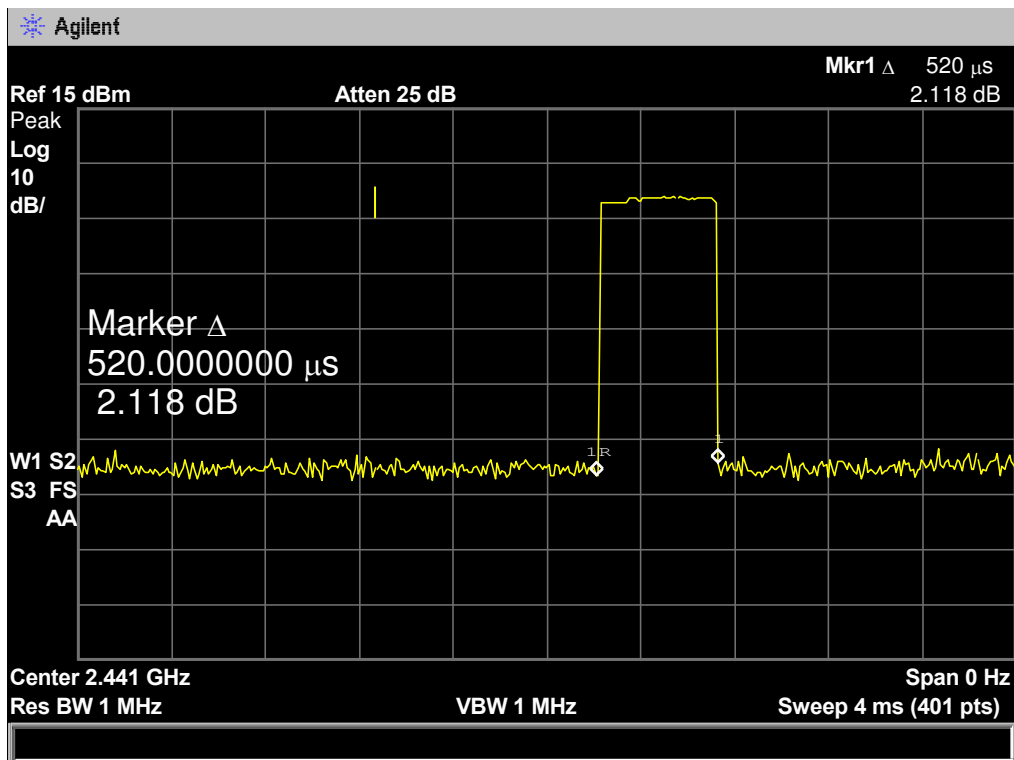

$\pi$  /4-DQPSK Hopping Mode DH1

2480 MHz

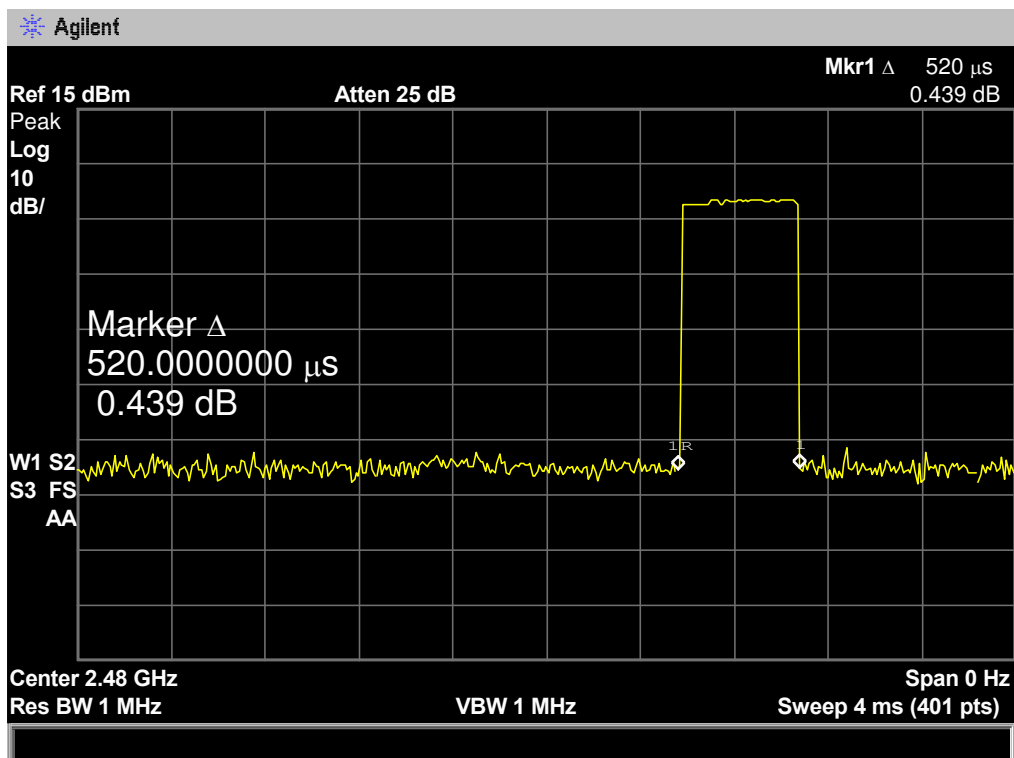

<b>EUT:</b>	Bluetooth speaker	<b>Model Name :</b>	MA-2241		
<b>Temperature:</b>	25 °C	<b>Relative Humidity:</b>	55%		
<b>Test Voltage:</b>	DC 5V				
<b>Test Mode:</b>	Hopping Mode ( $\pi/4$ -DQPSK DH3)				
Channel (MHz)	Pulse Time (ms)	Total of Dwell (ms)	Period Time (s)	Limit (ms)	Result
2402	1.820	291.20	31.60	400	<b>PASS</b>
2441	1.820	291.20			
2480	1.820	291.20			

$\pi/4$ -DQPSK Hopping Mode DH3

2402 MHz

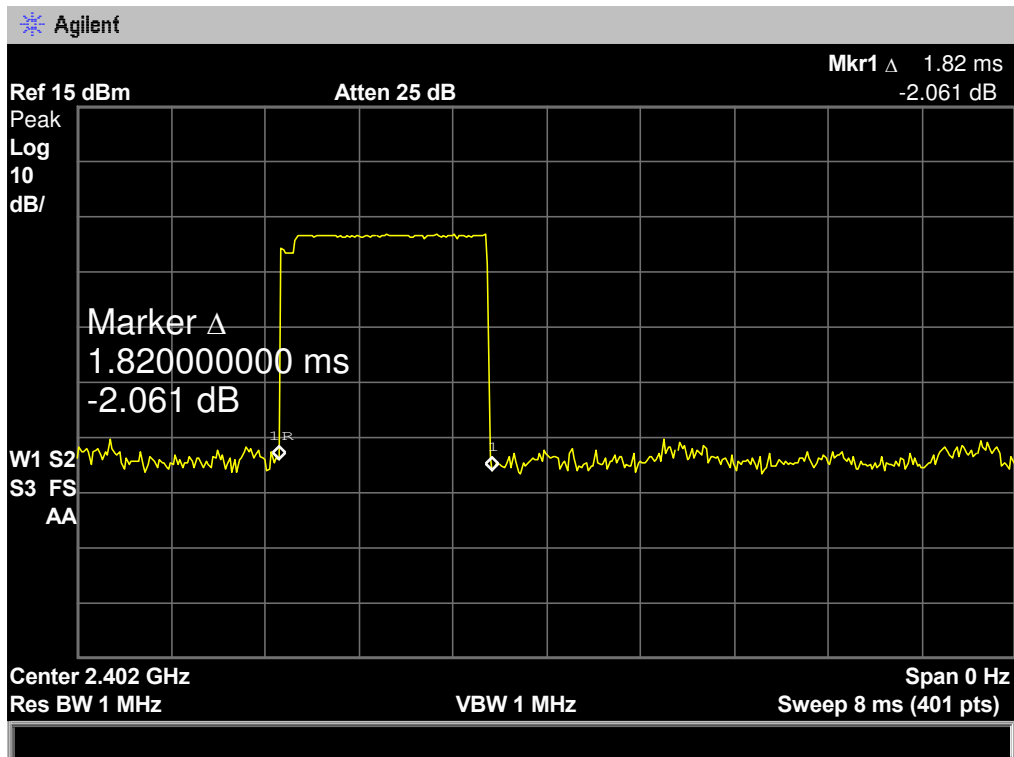

$\pi$  /4-DQPSK Hopping Mode DH3

2441 MHz

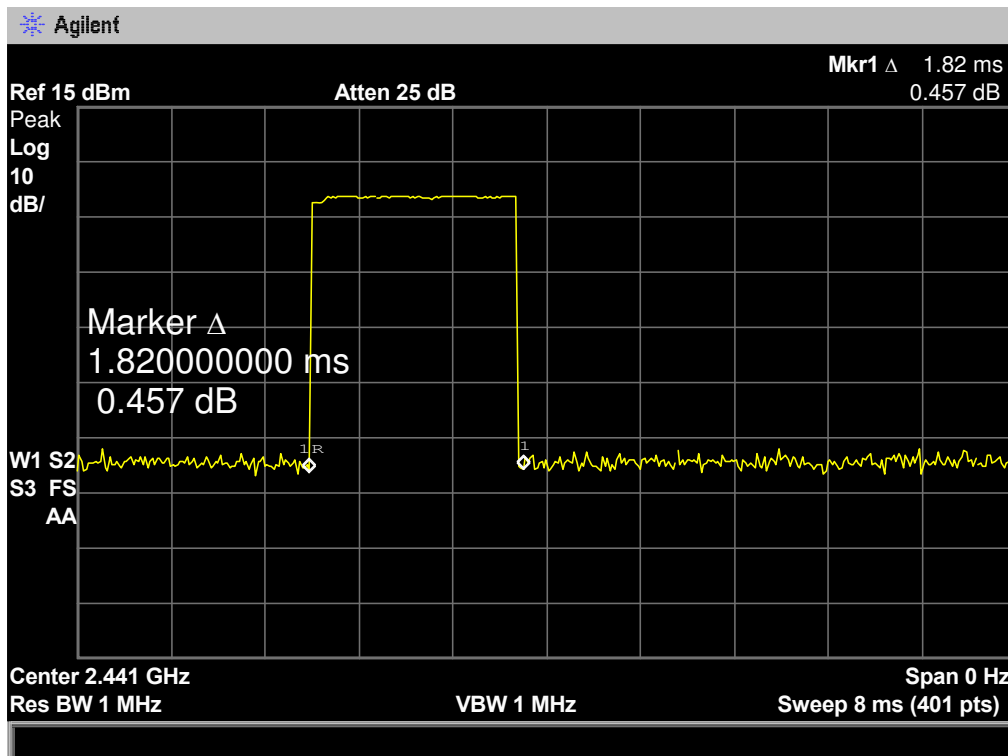

$\pi$  /4-DQPSK Hopping Mode DH3

2480 MHz

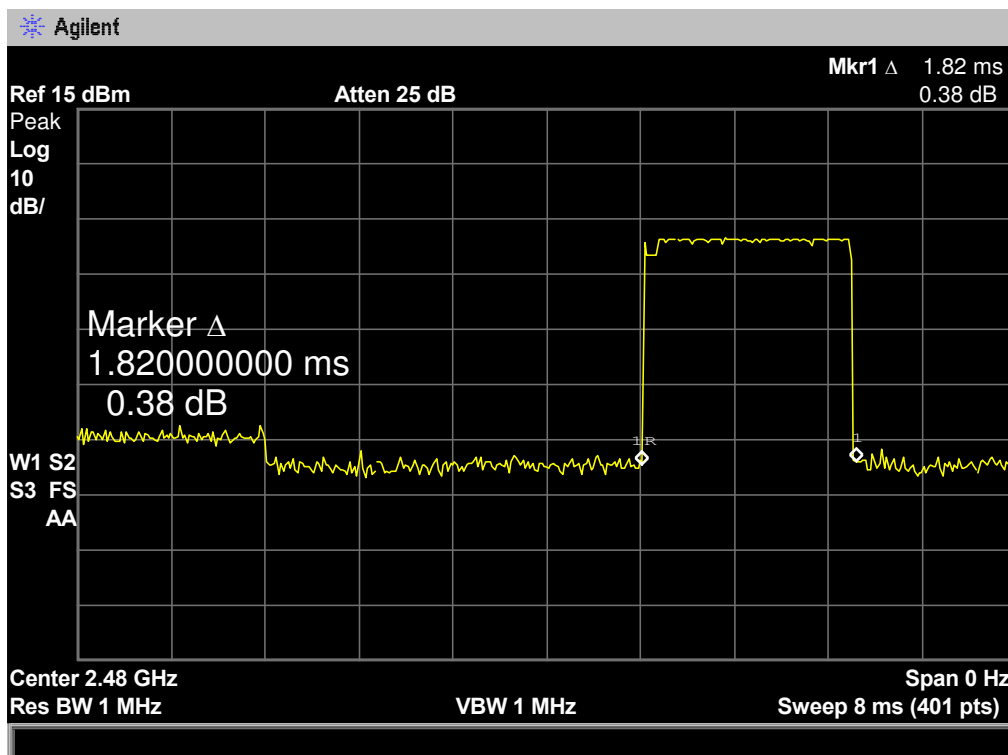



<b>EUT:</b>	Bluetooth speaker	<b>Model Name :</b>	MA-2241		
<b>Temperature:</b>	25 °C	<b>Relative Humidity:</b>	55%		
<b>Test Voltage:</b>	DC 5V				
<b>Test Mode:</b>	Hopping Mode ( $\pi/4$ -DQPSK DH5)				
Channel (MHz)	Pulse Time (ms)	Total of Dwell (ms)	Period Time (s)	Limit (ms)	Result
2402	3.120	332.80	31.60	400	<b>PASS</b>
2441	3.120	332.80			
2480	3.120	332.80			

$\pi/4$ -DQPSK Hopping Mode DH5

2402 MHz

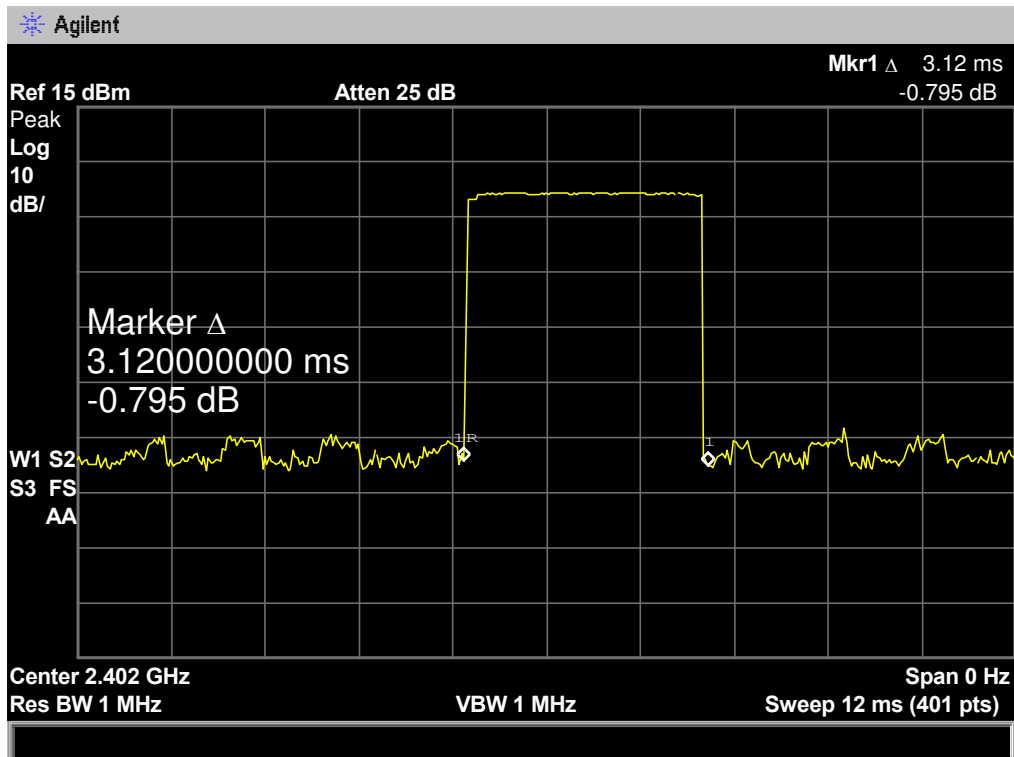

$\pi$  /4-DQPSK Hopping Mode DH5

2441 MHz

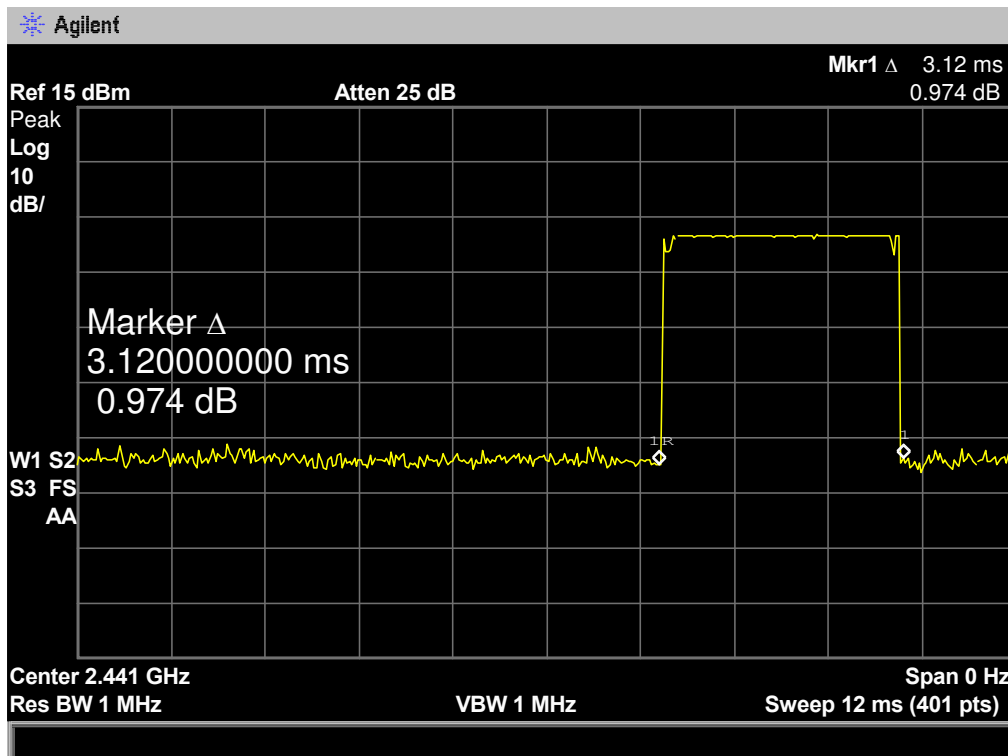

$\pi$  /4-DQPSK Hopping Mode DH5

2480 MHz

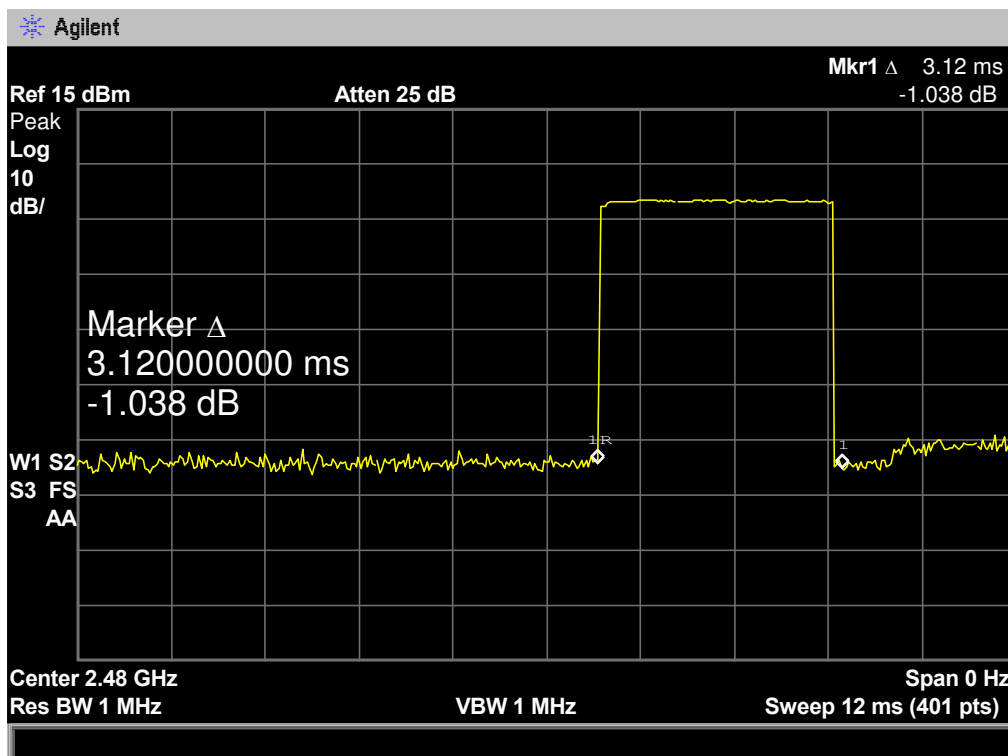

<b>EUT:</b>	Bluetooth speaker	<b>Model Name :</b>	MA-2241		
<b>Temperature:</b>	25 °C	<b>Relative Humidity:</b>	55%		
<b>Test Voltage:</b>	DC 5V				
<b>Test Mode:</b>	Hopping Mode (8-DPSK DH1)				
Channel (MHz)	Pulse Time (ms)	Total of Dwell (ms)	Period Time (s)	Limit (ms)	Result
2402	0.520	166.40	31.60	400	PASS
2441	0.520	166.40			
2480	0.520	166.40			

**8-DPSK Hopping Mode DH1**

**2402 MHz**

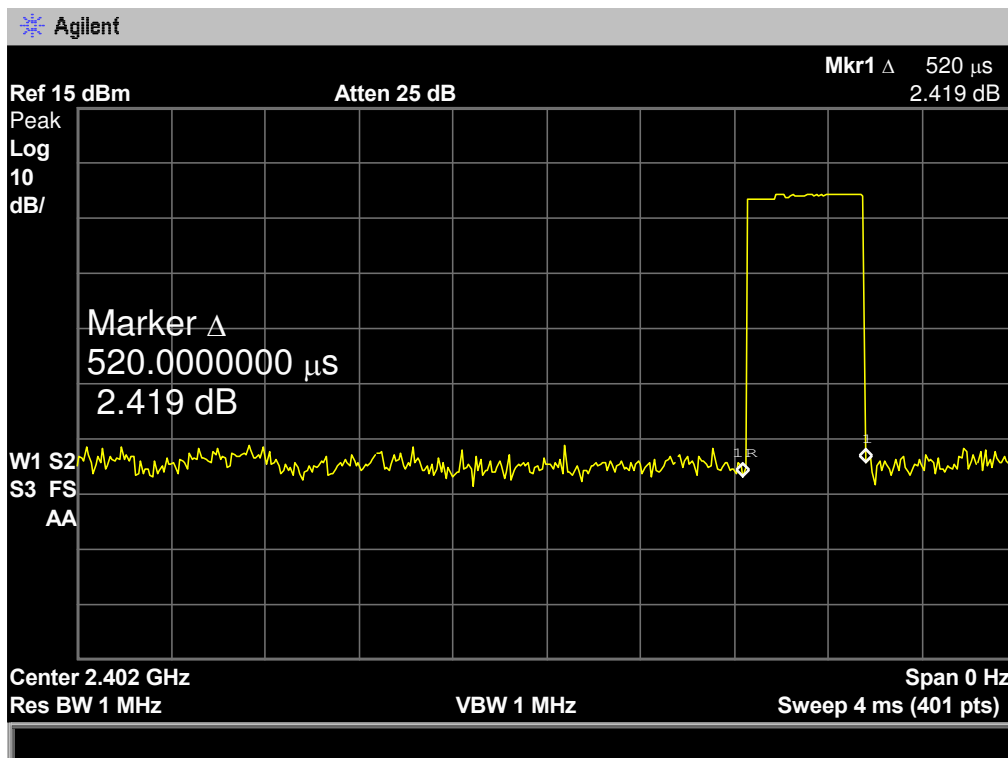

**8-DPSK Hopping Mode DH1**

**2441 MHz**

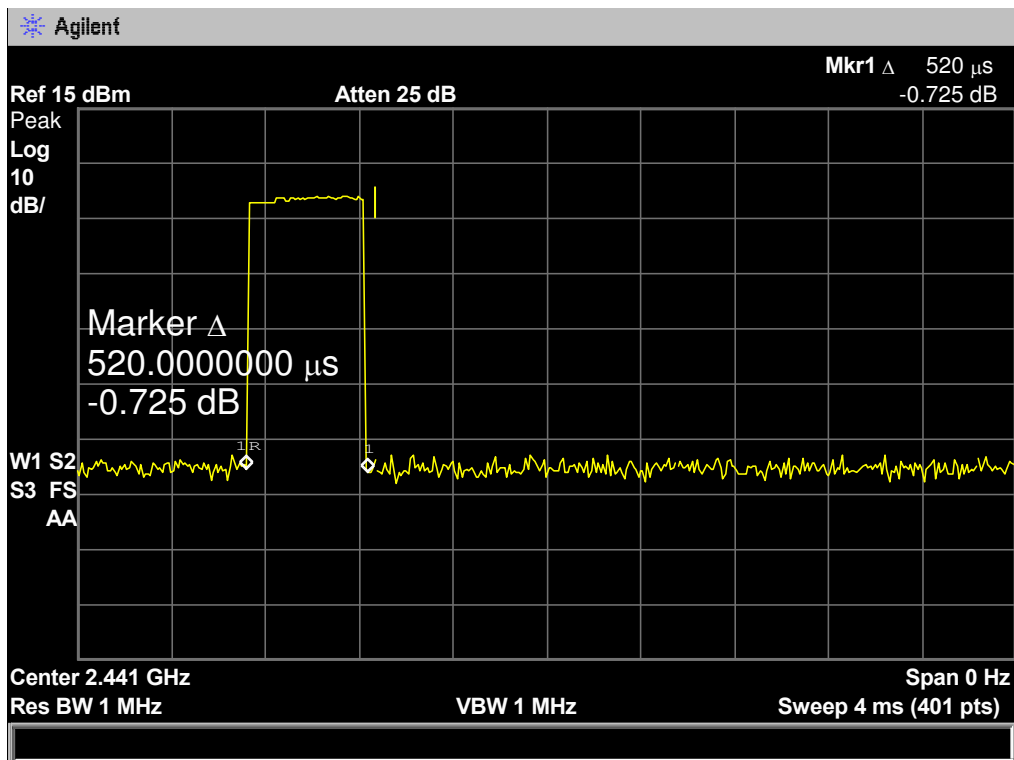

**8-DPSK Hopping Mode DH1**

**2480 MHz**

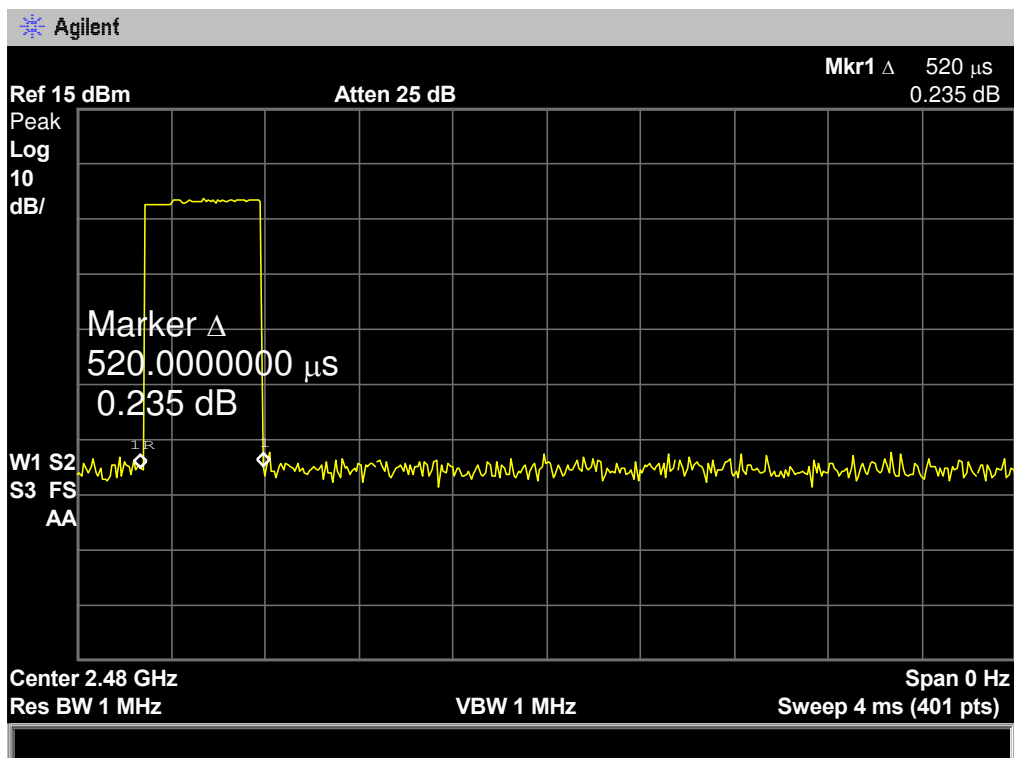

<b>EUT:</b>	Bluetooth speaker	<b>Model Name :</b>	MA-2241		
<b>Temperature:</b>	25 °C	<b>Relative Humidity:</b>	55%		
<b>Test Voltage:</b>	DC 5V				
<b>Test Mode:</b>	Hopping Mode (8-DPSK DH3)				
Channel (MHz)	Pulse Time (ms)	Total of Dwell (ms)	Period Time (s)	Limit (ms)	Result
2402	1.820	291.20	31.60	400	<b>PASS</b>
2441	1.820	291.20			
2480	1.820	291.20			

**8-DPSK Hopping Mode DH3**

**2402 MHz**

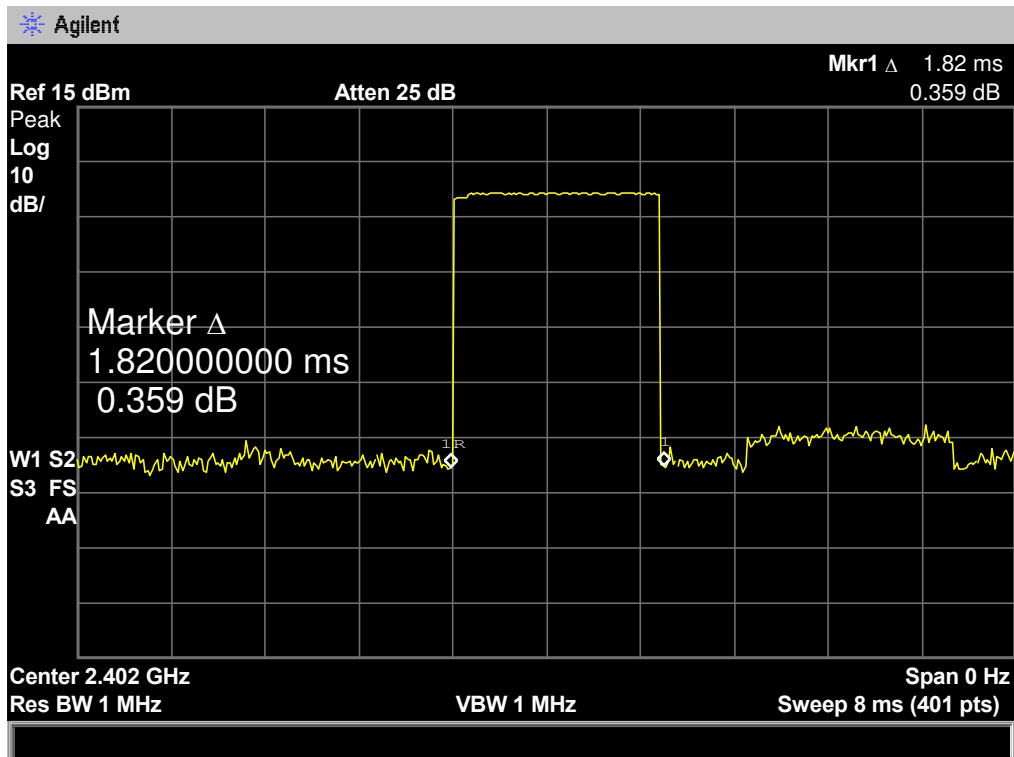

**8-DPSK Hopping Mode DH3**

**2441 MHz**

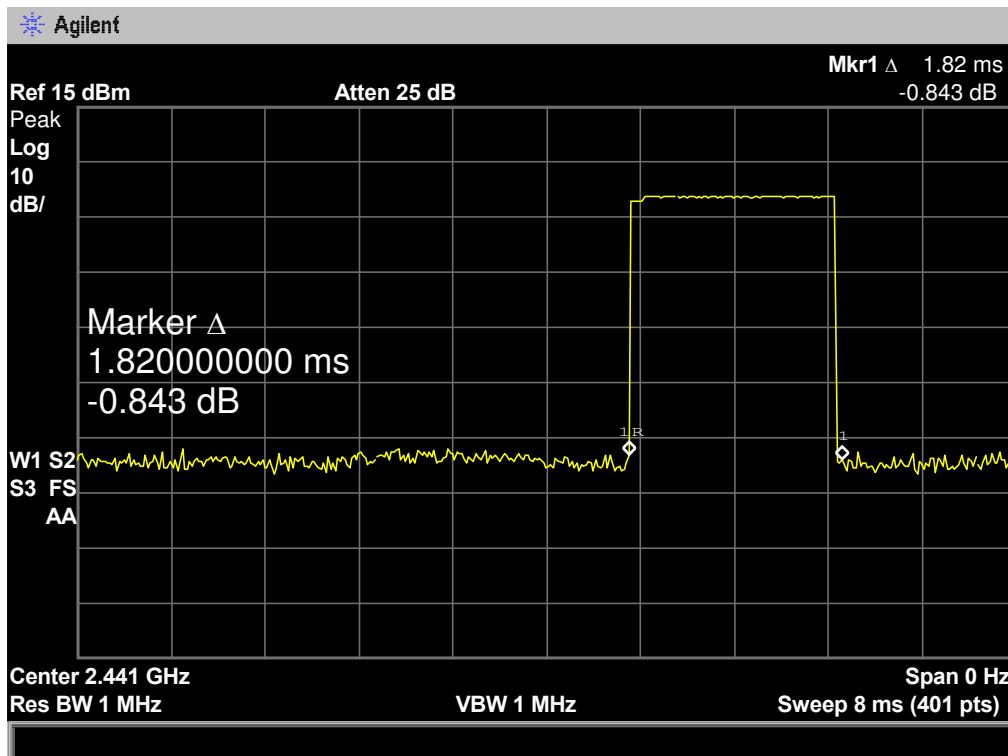

**8-DPSK Hopping Mode DH3**

**2480 MHz**

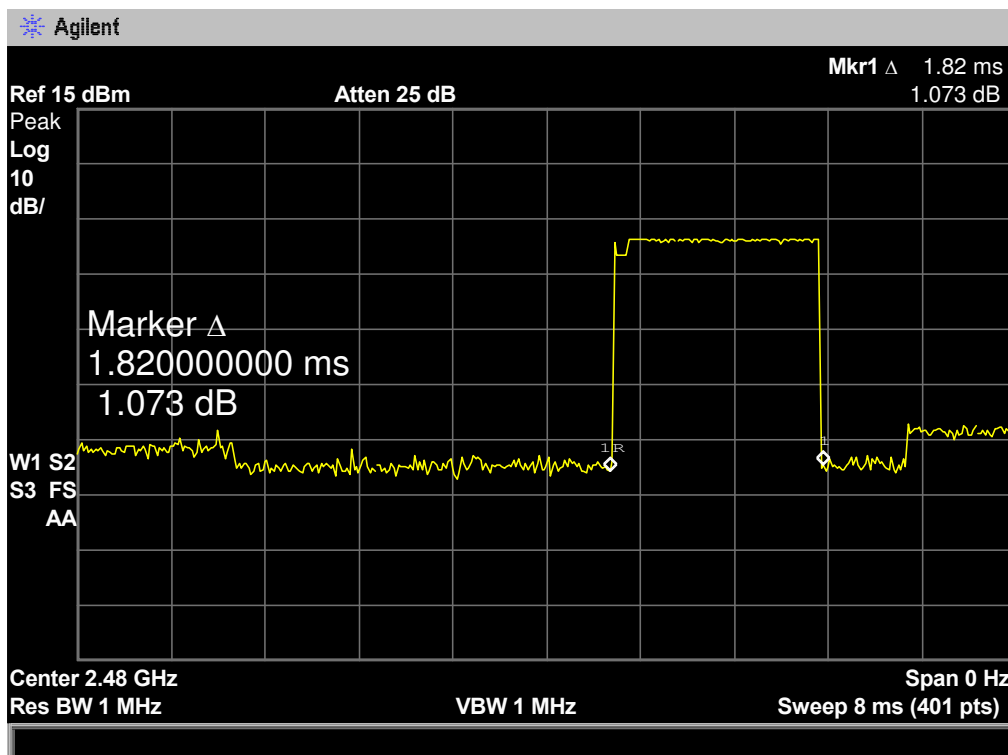

<b>EUT:</b>	Bluetooth speaker	<b>Model Name :</b>	MA-2241		
<b>Temperature:</b>	25 °C	<b>Relative Humidity:</b>	55%		
<b>Test Voltage:</b>	DC 5V				
<b>Test Mode:</b>	Hopping Mode (8-DPSK DH5)				
Channel (MHz)	Pulse Time (ms)	Total of Dwell (ms)	Period Time (s)	Limit (ms)	Result
2402	3.120	332.80	31.60	400	<b>PASS</b>
2441	3.120	332.80			
2480	3.120	332.80			

**8-DPSK Hopping Mode DH5**

**2402 MHz**

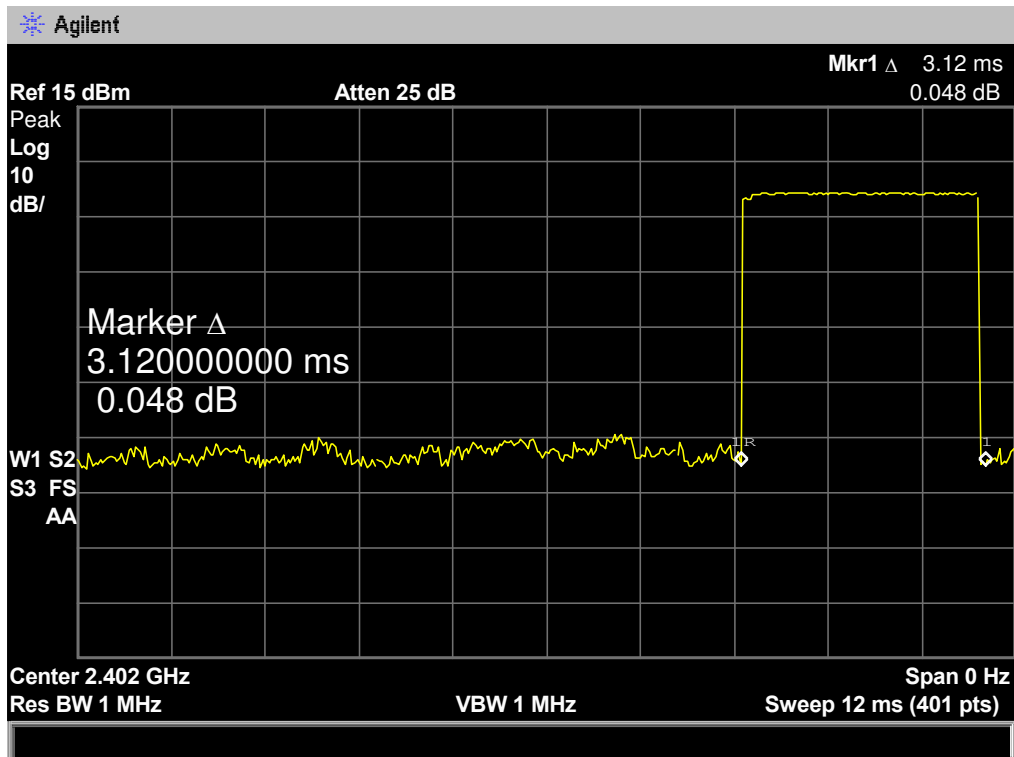

**8-DPSK Hopping Mode DH5**

**2441 MHz**

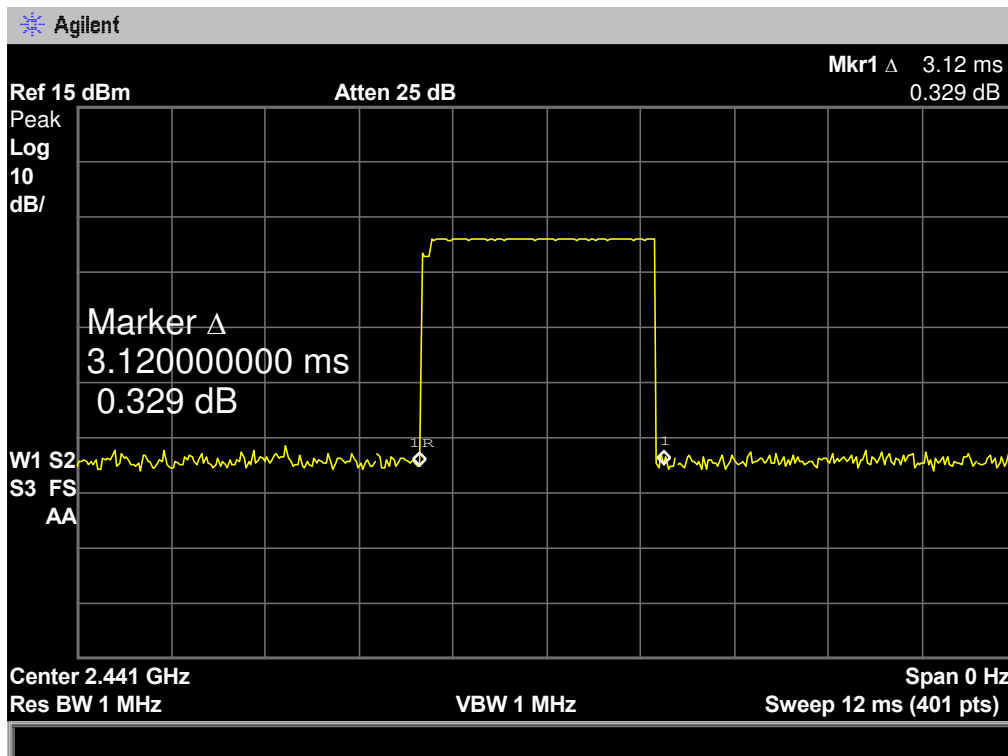

**8-DPSK Hopping Mode DH5**

**2480 MHz**

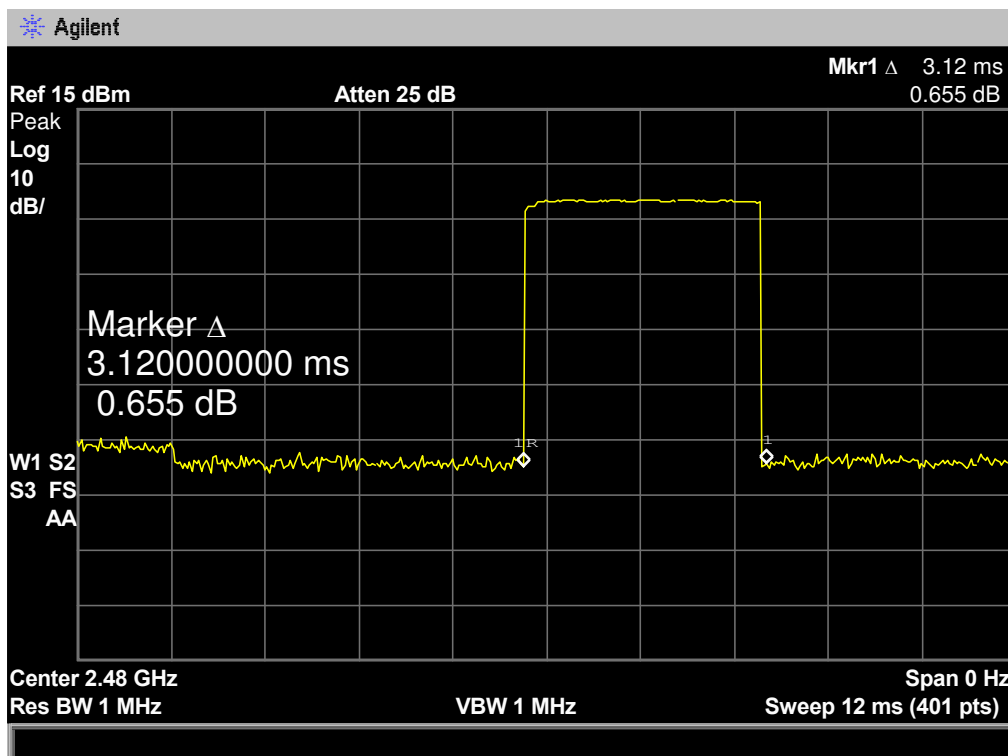



## 9. Channel Separation and Bandwidth Test

### 9.1 Test Standard and Limit

- 9.1.1 Test Standard  
FCC Part 15.247
- 9.1.2 Test Limit

Test Item	Limit	Frequency Range(MHz)
Bandwidth	$\leq 1$ MHz (20dB bandwidth)	2400~2483.5
Channel Separation	$>25$ kHz or $>$ two-thirds of the 20 dB bandwidth Which is greater	2400~2483.5

### 9.2 Test Setup

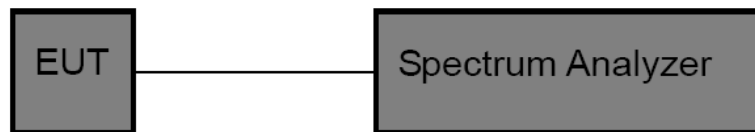

### 9.3 Test Procedure

- (1) The EUT was directly connected to the spectrum analyzer and antenna output port as show in the block diagram above.
- (2) Spectrum Setting:  
Channel Separation: RBW=30 kHz, VBW=100 kHz.  
Bandwidth: RBW=30 kHz, VBW=100 kHz.
- (3) The bandwidth is measured at an amplitude level reduced 20dB from the reference level. The reference level is the level of the highest amplitude signal observed from the transmitter at the fundamental frequency. Once the reference level is established, the equipment is conditioned with typical modulating signal to produce the worst –case (i.e the widest) bandwidth.
- (4) Measure the channel separation the spectrum analyzer was set to Resolution Bandwidth:30 kHz, and Video Bandwidth:100 kHz. Sweep Time set auto.

### 9.4 EUT Operating Condition

The EUT was set to the Hopping Mode for Channel Separation Test and continuously transmitting for the Bandwidth Test.

9.5 Test Data

<b>EUT:</b>	Bluetooth speaker	<b>Model Name :</b>	MA-2241
<b>Temperature:</b>	25 °C	<b>Relative Humidity:</b>	55%
<b>Test Voltage:</b>	DC 5V		
<b>Test Mode:</b>	TX Mode (GFSK)		
Channel frequency (MHz)	99% OBW (kHz)	20dB Bandwidth (kHz)	20dB Bandwidth *2/3 (kHz)
2402	950.4221	1047.00	698.00
2441	981.6931	1046.00	697.33
2480	978.6928	1040.00	693.33

**GFSK TX Mode**

**2402 MHz**

Agilent

Ref 15 dBm      Atten 25 dB

#Peak

Log

10

dB/

Offst

1

dB

Center 2.402000000 GHz

Center 2.402 GHz      #Res BW 30 kHz      #VBW 100 kHz      Span 3 MHz

Occupied Bandwidth      Occ BW % Pwr      99.00 %

950.4221 kHz      x dB      -20.00 dB

Transmit Freq Error      -44.906 kHz

x dB Bandwidth      1.047 MHz

### GFSK TX Mode

2441 MHz

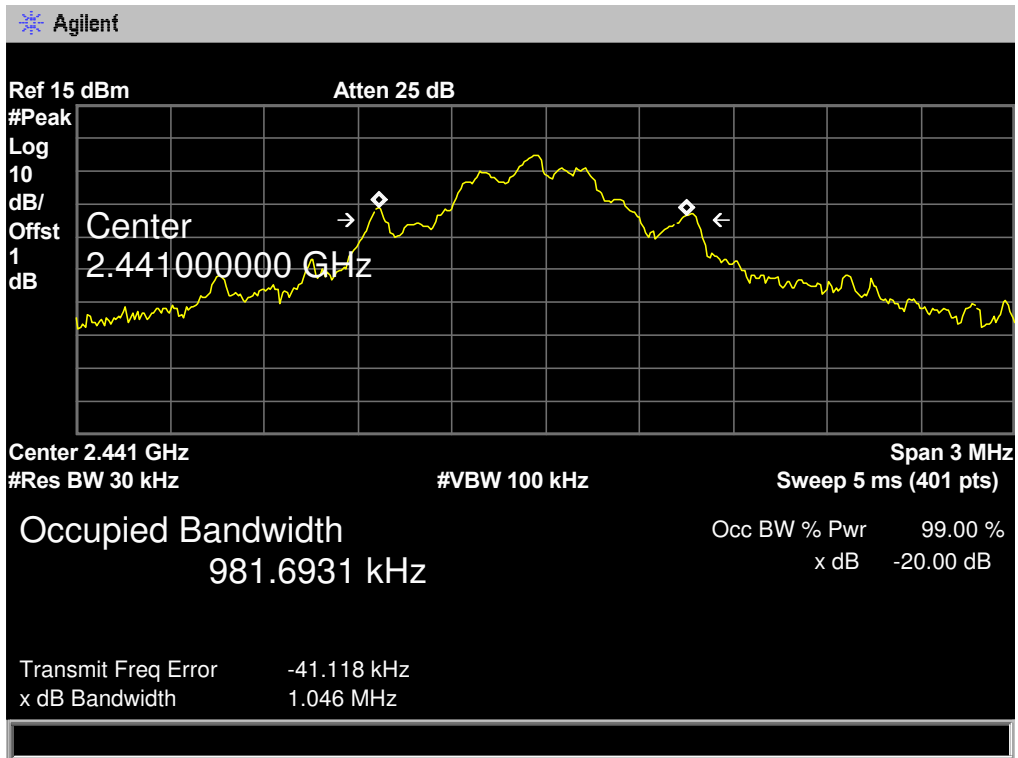

### GFSK TX Mode

2480 MHz

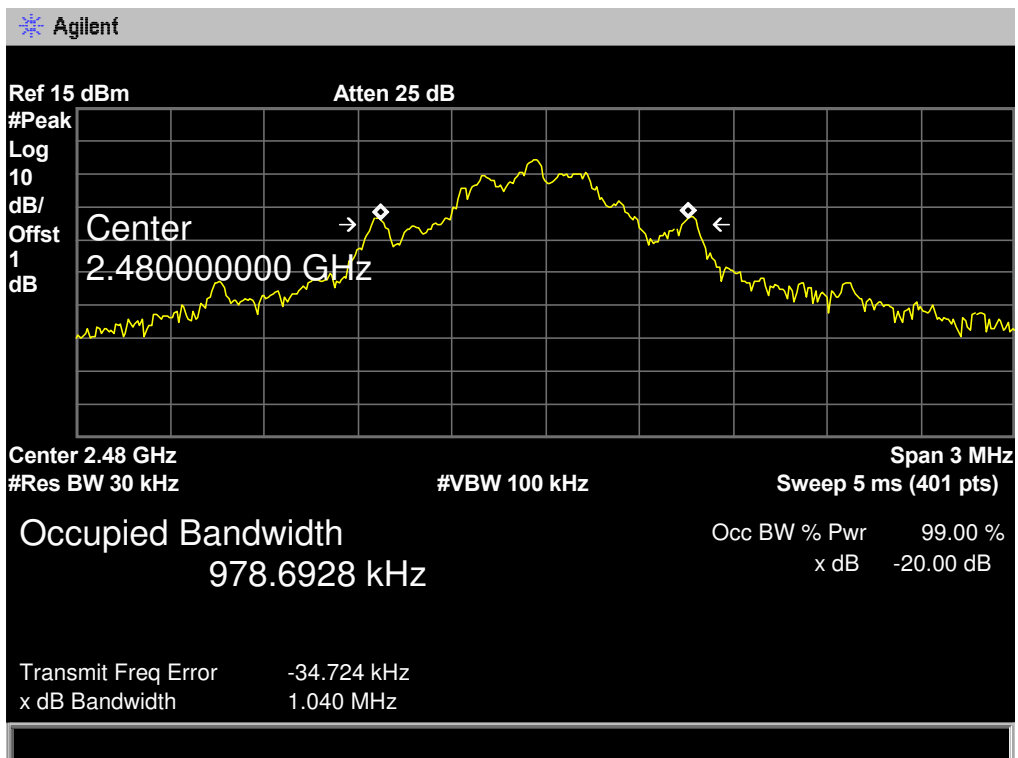

<b>EUT:</b>	Bluetooth speaker	<b>Model Name :</b>	MA-2241
<b>Temperature:</b>	25 °C	<b>Relative Humidity:</b>	55%
<b>Test Voltage:</b>	DC 5V		
<b>Test Mode:</b>	TX Mode ( $\pi/4$ -DQPSK)		
Channel frequency (MHz)	99% OBW (kHz)	20dB Bandwidth (kHz)	20dB Bandwidth *2/3 (kHz)
2402	1069.70	1134.00	756.00
2441	1070.90	1136.00	757.33
2480	1059.00	1118.00	745.33

$\pi/4$ -DQPSK TX Mode

2402 MHz

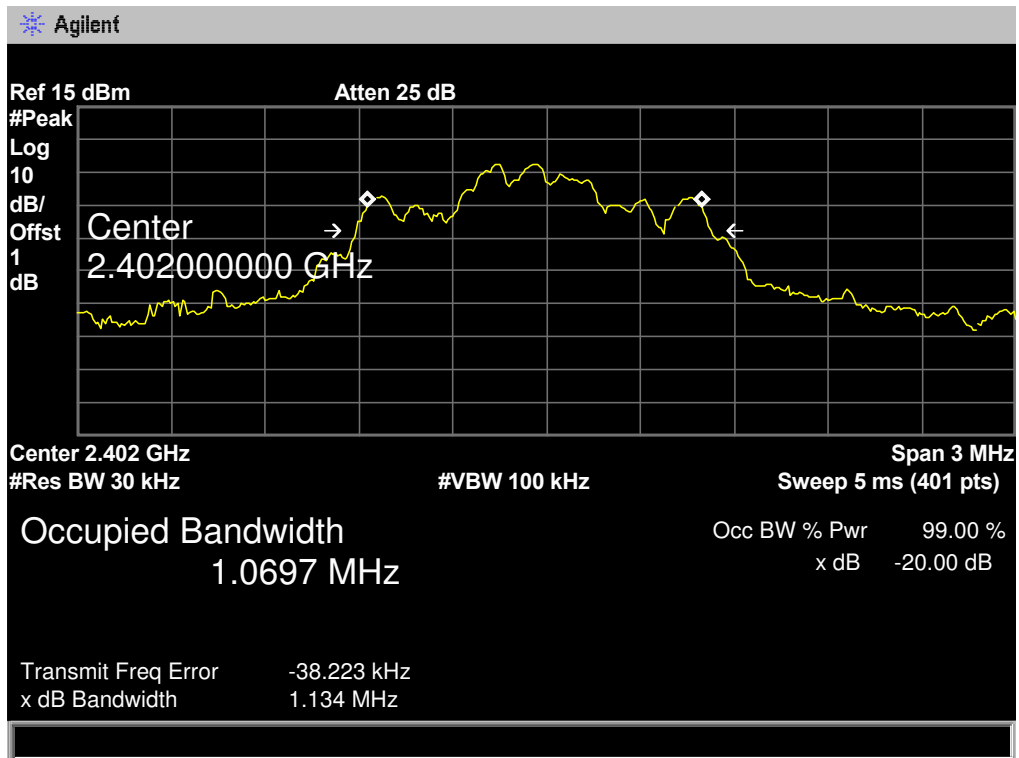

$\pi/4$ -DQPSK TX Mode

2441 MHz

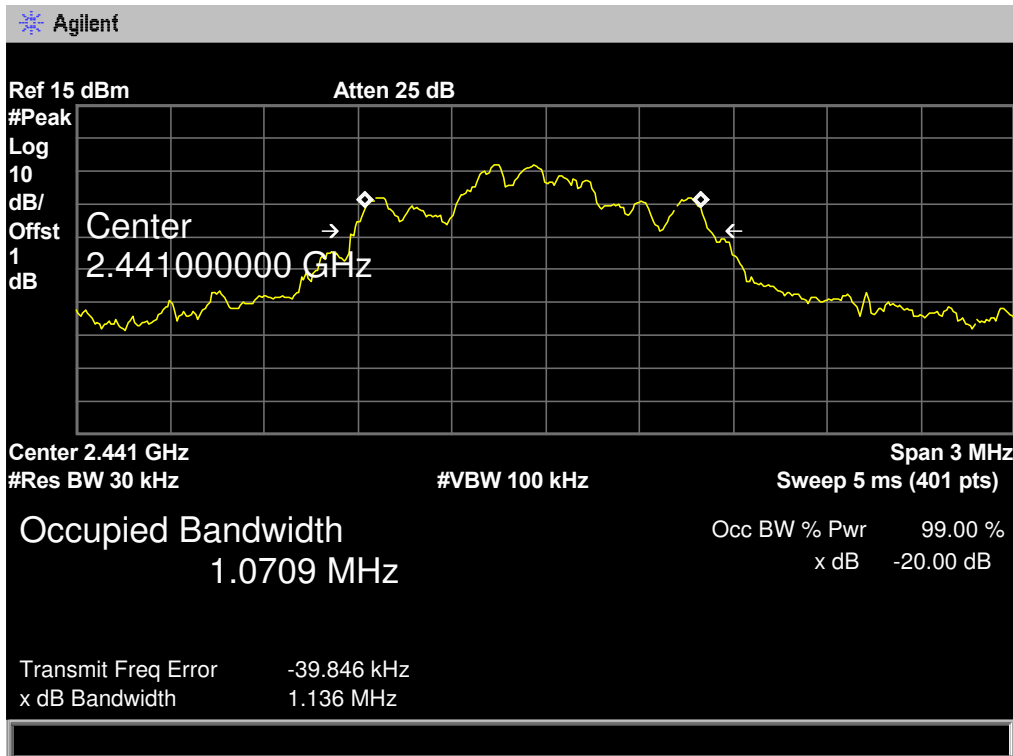

$\pi/4$ -DQPSK TX Mode

2480 MHz

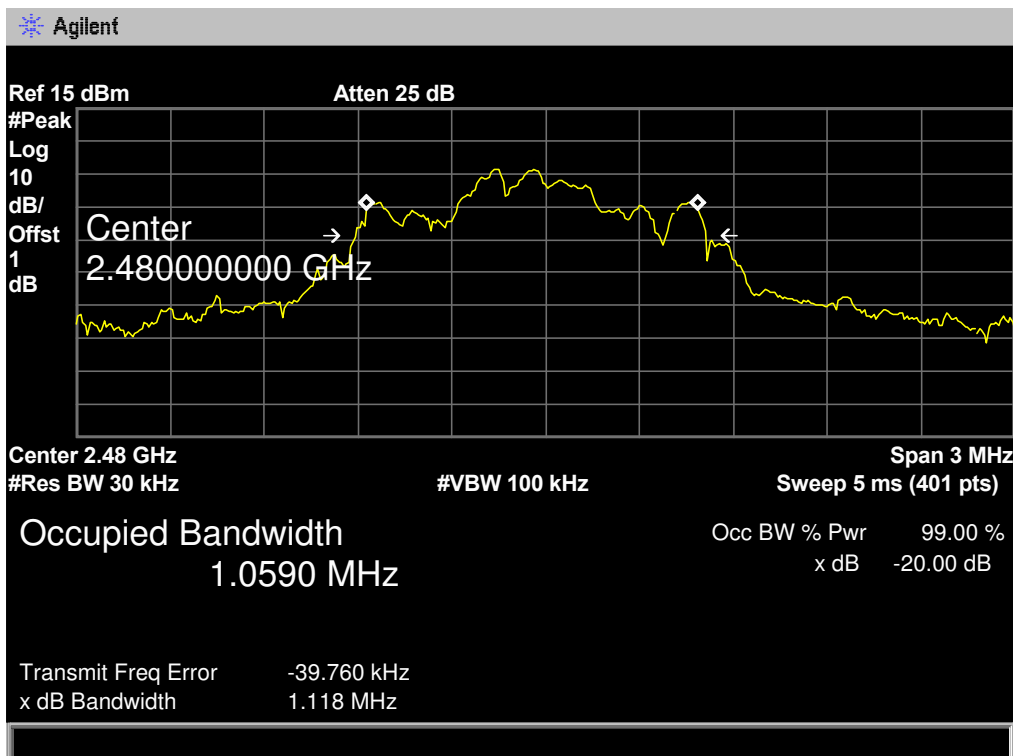

<b>EUT:</b>	Bluetooth speaker	<b>Model Name :</b>	MA-2241
<b>Temperature:</b>	25 °C	<b>Relative Humidity:</b>	55%
<b>Test Voltage:</b>	DC 5V		
<b>Test Mode:</b>	TX Mode (8-DPSK)		
Channel frequency (MHz)	99% OBW (kHz)	20dB Bandwidth (kHz)	20dB Bandwidth *2/3 (kHz)
2402	1143.00	1212.00	808.00
2441	1043.10	1210.00	806.67
2480	1141.60	1213.00	808.67
<b>8-DPSK TX Mode</b>			
<b>2402 MHz</b>			
<p>Agilent</p> <p>Ref 15 dBm      Atten 25 dB</p> <p>#Peak</p> <p>Log</p> <p>10</p> <p>dB/</p> <p>Offst</p> <p>Center</p> <p>2.402000000 GHz</p> <p>1</p> <p>dB</p> <p>Center 2.402 GHz      Span 3 MHz</p> <p>#Res BW 30 kHz      #VBW 100 kHz      Sweep 5 ms (401 pts)</p> <p>Occupied Bandwidth      Occ BW % Pwr      99.00 %</p> <p>1.1430 MHz      x dB      -20.00 dB</p> <p>Transmit Freq Error      -23.969 kHz</p> <p>x dB Bandwidth      1.212 MHz</p>			

**8-DPSK TX Mode**

**2441 MHz**

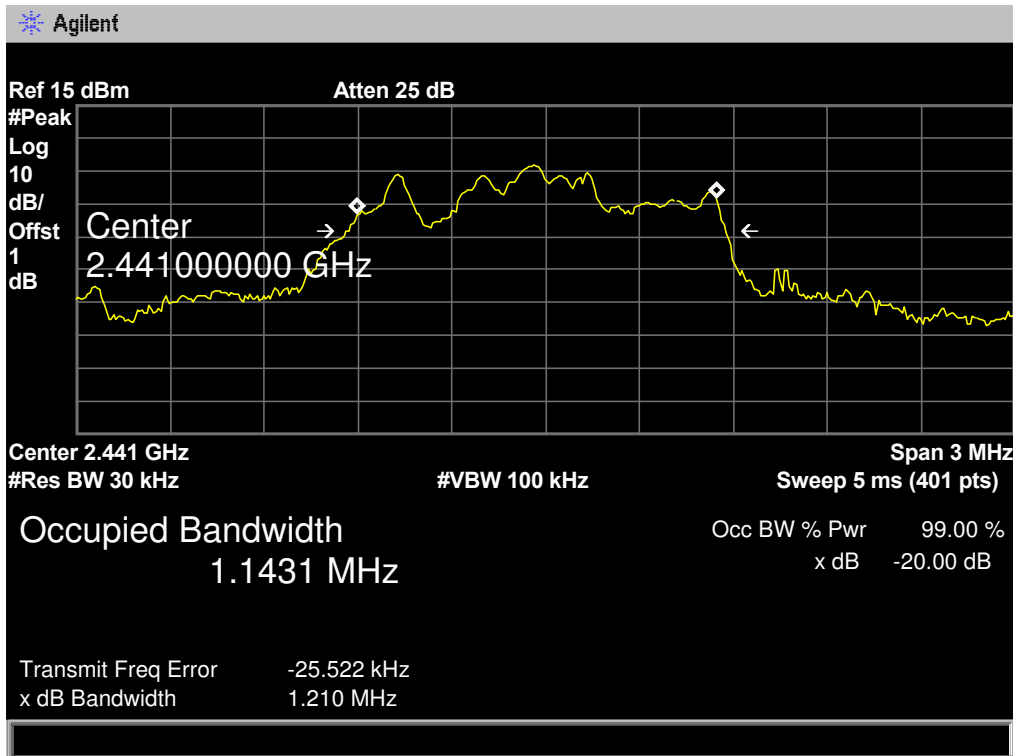

**8-DPSK TX Mode**

**2480 MHz**

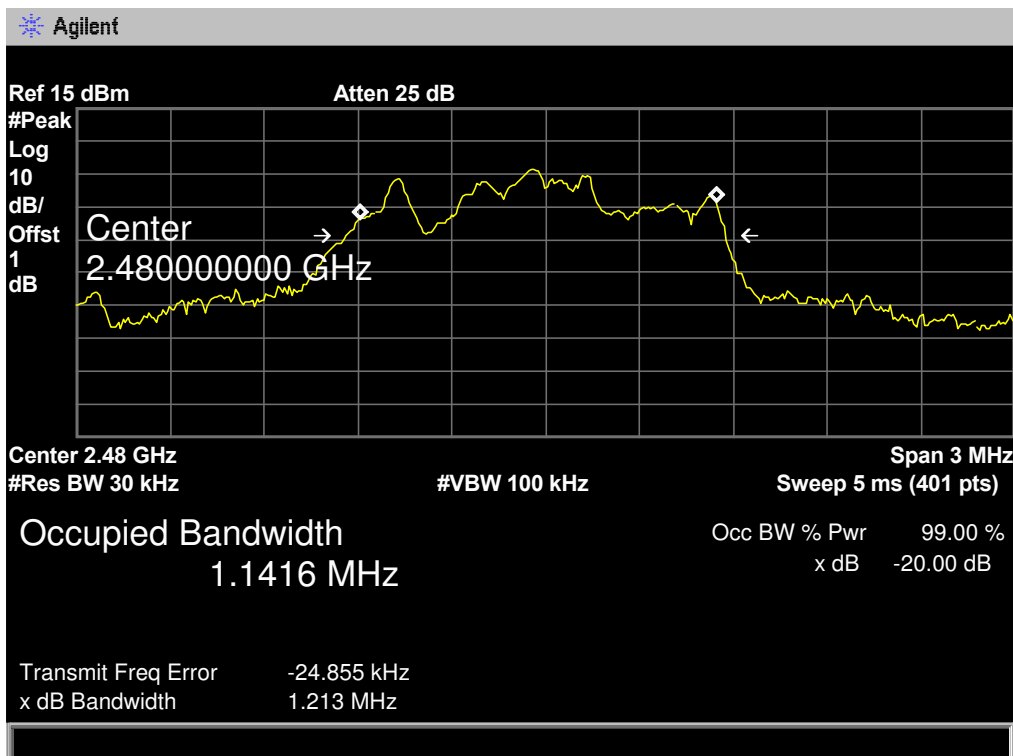

<b>EUT:</b>	Bluetooth speaker	<b>Model Name :</b>	MA-2241															
<b>Temperature:</b>	25 °C	<b>Relative Humidity:</b>	55%															
<b>Test Voltage:</b>	DC 3.7V																	
<b>Test Mode:</b>	Hopping Mode (GFSK)																	
Channel frequency (MHz)	Separation Read Value (kHz)	Separation Limit (kHz)																
2402	1005.00	698.00																
2441	1005.00	697.33																
2480	1005.00	693.33																
<b>GFSK Hopping Mode</b>																		
<b>2402 MHz</b>																		
<p>Agilent</p> <p>Ref 15 dBm      Atten 25 dB      Mkr1 Δ 1.0050 MHz 0.035 dB</p> <p>Peak Log 10 dB/Offst 1 dB</p> <p>Marker Δ 1.005000 MHz 0.035 dB</p> <p>Center 2.402 GHz      Span 3 MHz #Res BW 30 kHz      #VBW 100 kHz      Sweep 5 ms (401 pts)</p> <table border="1"> <thead> <tr> <th>Marker</th> <th>Trace</th> <th>Type</th> <th>X Axis</th> <th>Amplitude</th> </tr> </thead> <tbody> <tr> <td>1R</td> <td>(1)</td> <td>Freq</td> <td>2.4019675 GHz</td> <td>0.535 dBm</td> </tr> <tr> <td>1Δ</td> <td>(1)</td> <td>Freq</td> <td>1.0050 MHz</td> <td>0.035 dB</td> </tr> </tbody> </table>				Marker	Trace	Type	X Axis	Amplitude	1R	(1)	Freq	2.4019675 GHz	0.535 dBm	1Δ	(1)	Freq	1.0050 MHz	0.035 dB
Marker	Trace	Type	X Axis	Amplitude														
1R	(1)	Freq	2.4019675 GHz	0.535 dBm														
1Δ	(1)	Freq	1.0050 MHz	0.035 dB														



**GFSK Hopping Mode**

**2441 MHz**

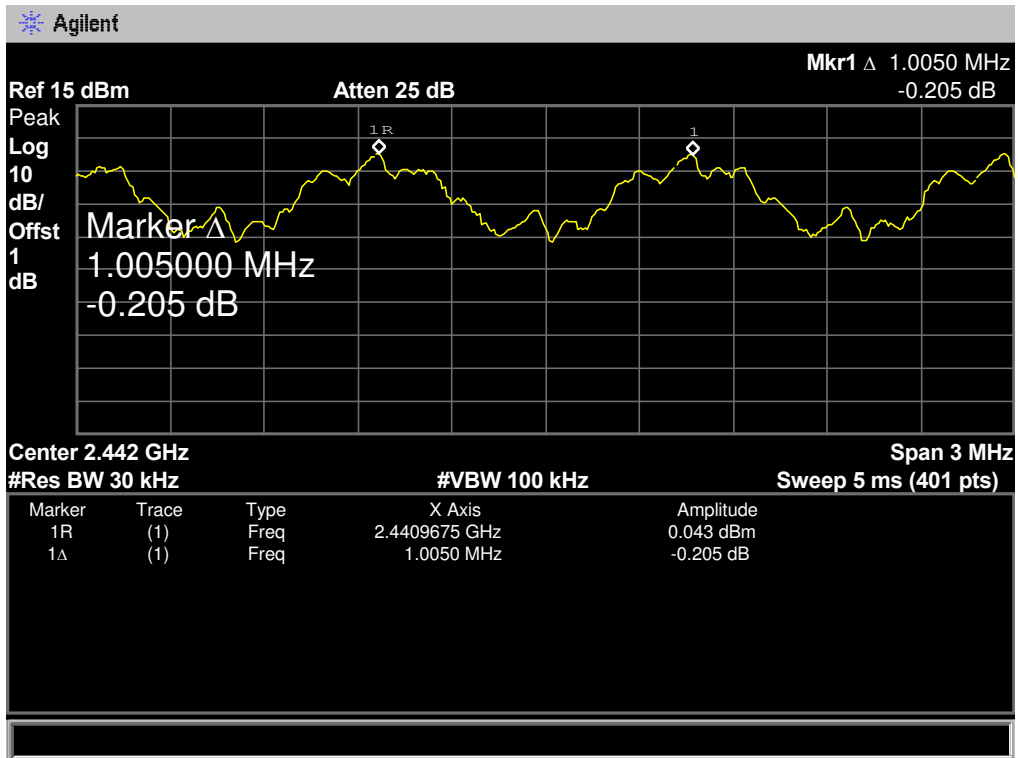

**GFSK Hopping Mode**

**2480 MHz**

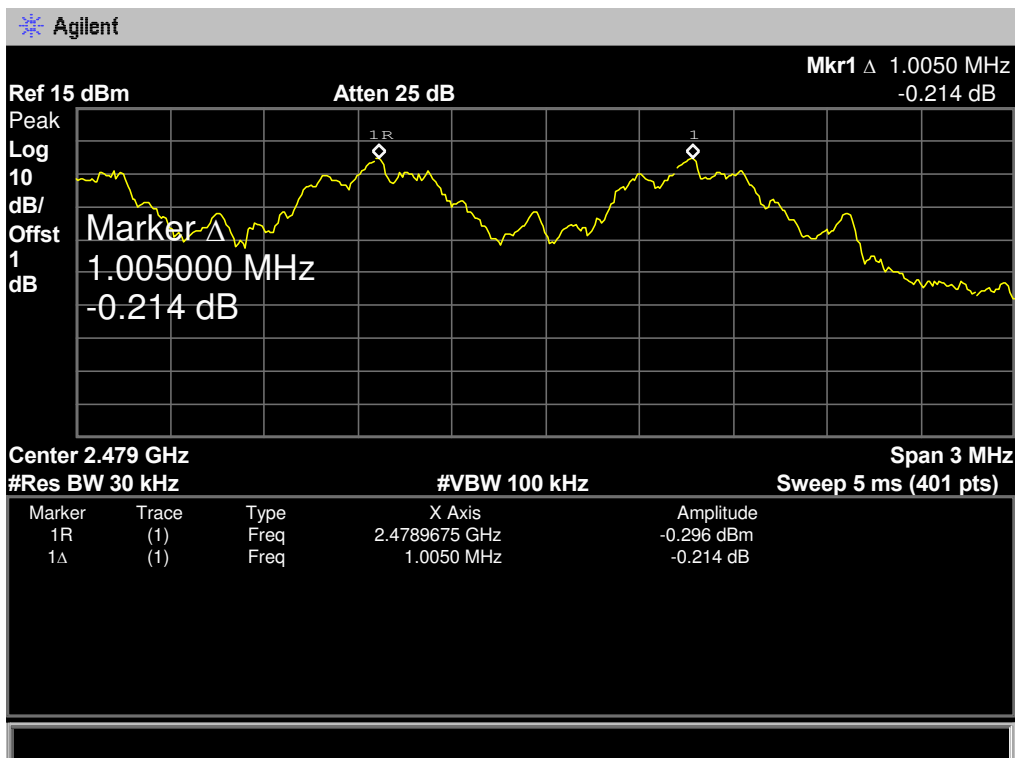

<b>EUT:</b>	Bluetooth speaker	<b>Model Name :</b>	MA-2241															
<b>Temperature:</b>	25 °C	<b>Relative Humidity:</b>	55%															
<b>Test Voltage:</b>	DC 3.7V																	
<b>Test Mode:</b>	Hopping Mode ( $\pi/4$ -DQPSK)																	
Channel frequency (MHz)	Separation Read Value (kHz)	Separation Limit (kHz)																
2402	1005.00	756.00																
2441	1005.00	757.33																
2480	1005.00	745.33																
<b><math>\pi/4</math>-DQPSK Hopping Mode</b>																		
<b>2402 MHz</b>																		
<p>Agilent</p> <p>Ref 15 dBm      Atten 25 dB      Mkr1 <math>\Delta</math> 1.0050 MHz 0.061 dB</p> <p>Peak Log 10 dB/ Offst 1 dB</p> <p>Marker <math>\Delta</math> 1.005000 MHz -2.688 dB</p> <p>Center 2.402 GHz      Span 3 MHz #Res BW 30 kHz      #VBW 100 kHz      Sweep 5 ms (401 pts)</p> <table border="1"> <thead> <tr> <th>Marker</th> <th>Trace</th> <th>Type</th> <th>X Axis</th> <th>Amplitude</th> </tr> </thead> <tbody> <tr> <td>1R</td> <td>(1)</td> <td>Freq</td> <td>2.4018400 GHz</td> <td>-2.688 dBm</td> </tr> <tr> <td>1<math>\Delta</math></td> <td>(1)</td> <td>Freq</td> <td>1.0050 MHz</td> <td>0.061 dB</td> </tr> </tbody> </table>				Marker	Trace	Type	X Axis	Amplitude	1R	(1)	Freq	2.4018400 GHz	-2.688 dBm	1 $\Delta$	(1)	Freq	1.0050 MHz	0.061 dB
Marker	Trace	Type	X Axis	Amplitude														
1R	(1)	Freq	2.4018400 GHz	-2.688 dBm														
1 $\Delta$	(1)	Freq	1.0050 MHz	0.061 dB														

### $\pi/4$ -DQPSK Hopping Mode

2441 MHz

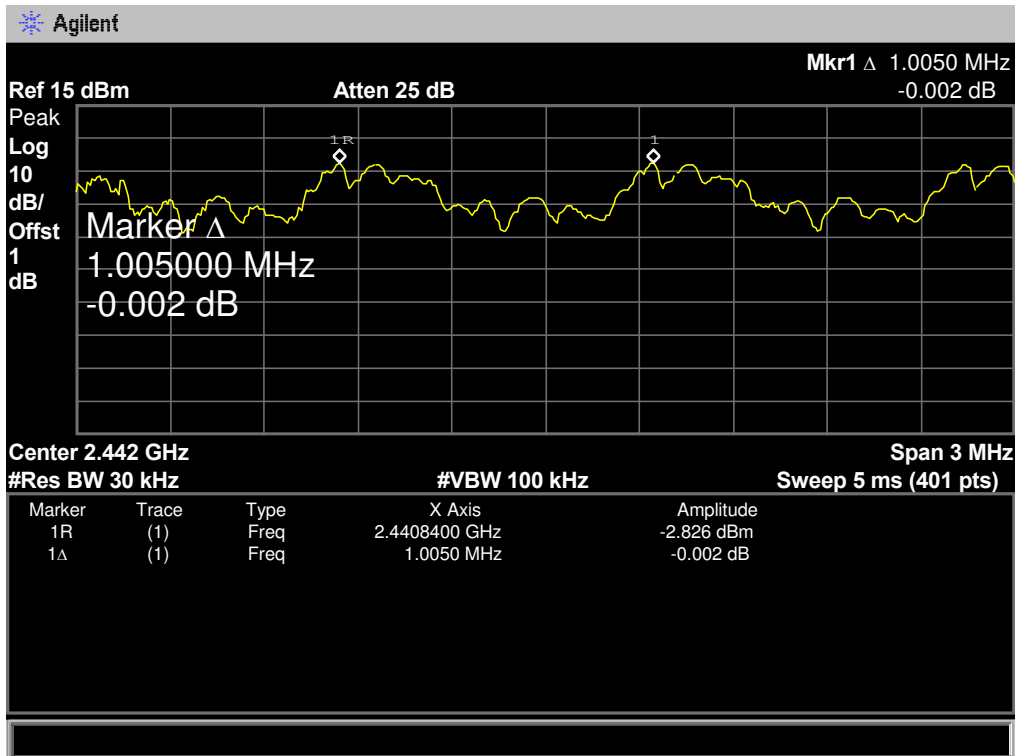

### $\pi/4$ -DQPSK Hopping Mode

2480 MHz

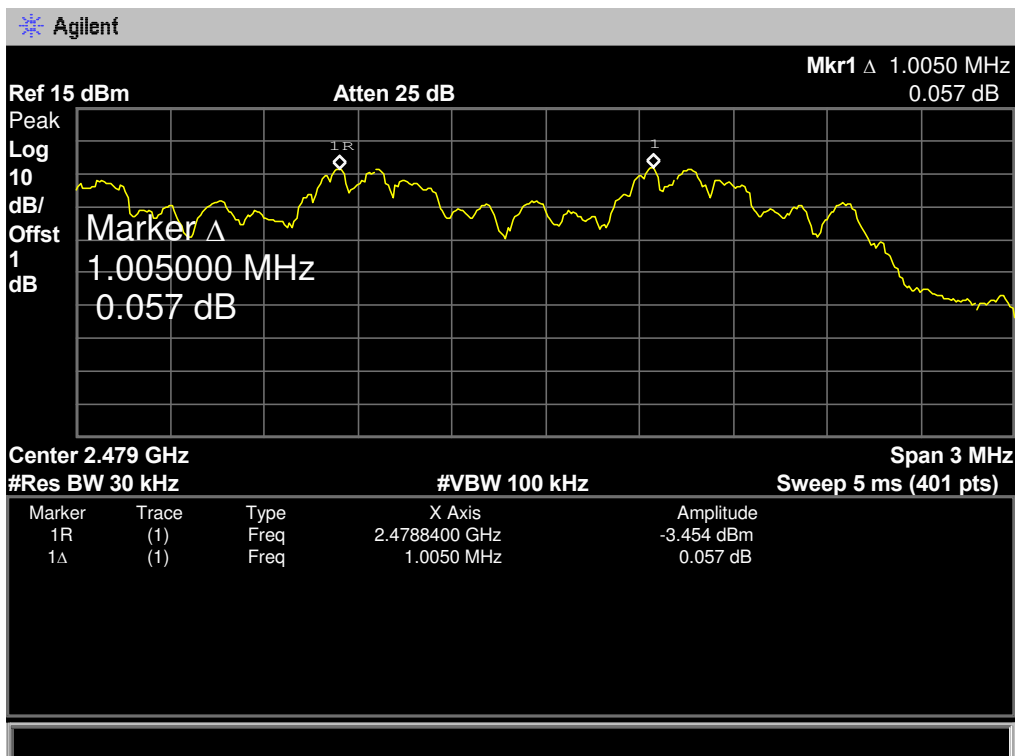

<b>EUT:</b>	Bluetooth speaker	<b>Model Name :</b>	MA-2241															
<b>Temperature:</b>	25 °C	<b>Relative Humidity:</b>	55%															
<b>Test Voltage:</b>	DC 3.7V																	
<b>Test Mode:</b>	Hopping Mode (8-DPSK)																	
Channel frequency (MHz)	Separation Read Value (kHz)	Separation Limit (kHz)																
2402	1005.00	808.00																
2441	1005.00	806.67																
2480	1005.00	808.67																
<b>8-DPSK Hopping Mode</b>																		
<b>2402 MHz</b>																		
<p>Agilent</p> <p>Ref 15 dBm      Atten 25 dB      Mkr1 Δ 1.0050 MHz 0.128 dB</p> <p>Peak Log 10 dB/ Offst 1 dB</p> <p>Marker Δ 1.005000 MHz -2.959 dB</p> <p>Center 2.402 GHz      Span 3 MHz #Res BW 30 kHz      #VBW 100 kHz      Sweep 5 ms (401 pts)</p> <table border="1"> <thead> <tr> <th>Marker</th> <th>Trace</th> <th>Type</th> <th>X Axis</th> <th>Amplitude</th> </tr> </thead> <tbody> <tr> <td>1R</td> <td>(1)</td> <td>Freq</td> <td>2.4019600 GHz</td> <td>-2.959 dBm</td> </tr> <tr> <td>1Δ</td> <td>(1)</td> <td>Freq</td> <td>1.0050 MHz</td> <td>0.128 dB</td> </tr> </tbody> </table>				Marker	Trace	Type	X Axis	Amplitude	1R	(1)	Freq	2.4019600 GHz	-2.959 dBm	1Δ	(1)	Freq	1.0050 MHz	0.128 dB
Marker	Trace	Type	X Axis	Amplitude														
1R	(1)	Freq	2.4019600 GHz	-2.959 dBm														
1Δ	(1)	Freq	1.0050 MHz	0.128 dB														

### 8-DPSK Hopping Mode

2441 MHz

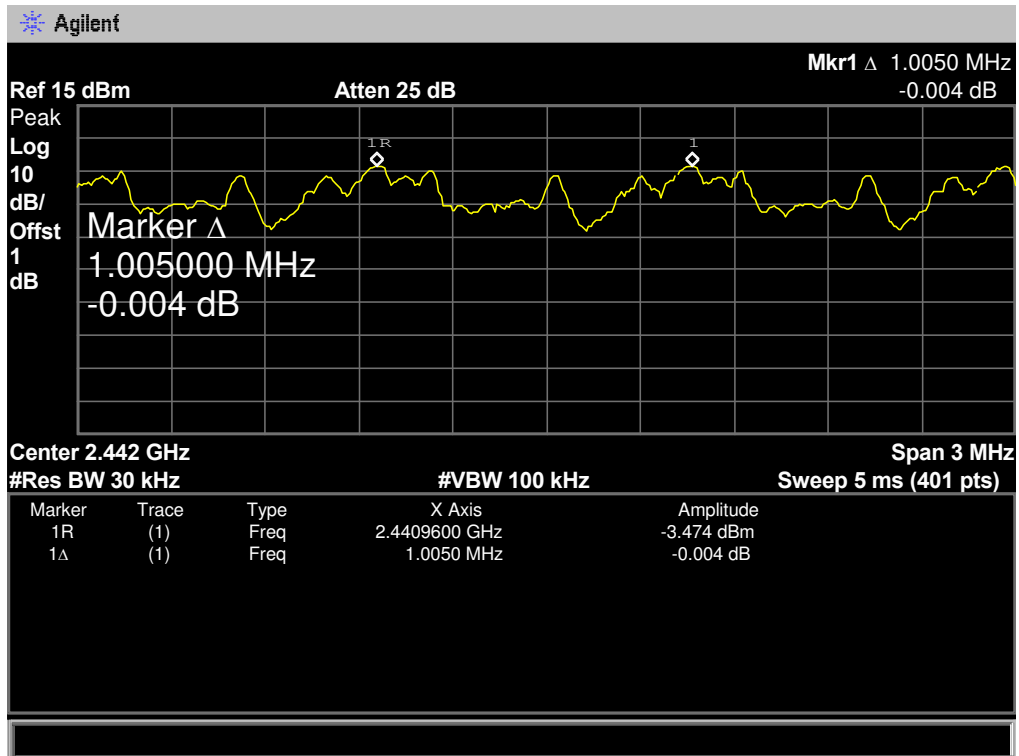

### 8-DPSK Hopping Mode

2480 MHz

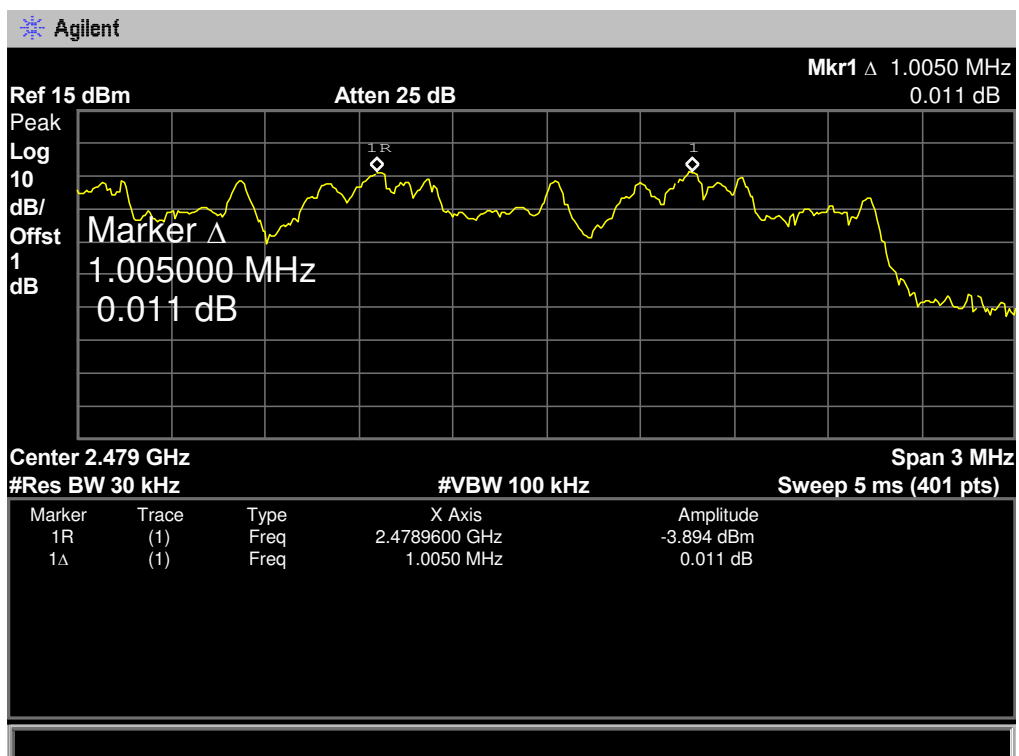

## 10. Peak Output Power Test

### 10.1 Test Standard and Limit

#### 10.1.1 Test Standard

FCC Part 15.247 (b) (1)

#### 10.1.2 Test Limit

Test Item	Limit	Frequency Range(MHz)
Peak Output Power	Hopping Channels>75 Power<1W(30dBm) Other <125 mW(21dBm)	2400~2483.5

### 10.2 Test Setup

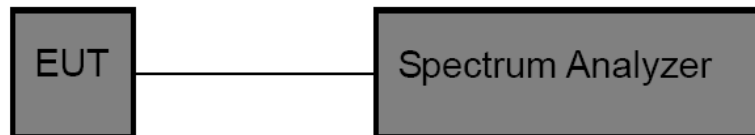

### 10.3 Test Procedure

- (1) The EUT was directly connected to the spectrum analyzer and antenna output port as show in the block diagram above.
- (2) Spectrum Setting:  
Peak Detector: RBW=1 MHz, VBW=3 MHz for bandwidth less than 1MHz.  
RBW=3 MHz, VBW=3 MHz for bandwidth more than 1MHz.

### 10.4 EUT Operating Condition

The EUT was set to continuously transmitting in the max power during the test.

10.5 Test Data

<b>EUT:</b>	Bluetooth speaker	<b>Model Name :</b>	MA-2241
<b>Temperature:</b>	25 °C	<b>Relative Humidity:</b>	55%
<b>Test Voltage:</b>	DC 5V		
<b>Test Mode:</b>	TX Mode (GFSK)		
<b>Channel frequency (MHz)</b>	<b>Test Result (dBm)</b>	<b>Limit (dBm)</b>	
2402	0.753	<b>21</b>	
2441	0.236		
2480	-0.131		
<b>GFSK TX Mode</b>			
<b>2402 MHz</b>			
<p>Agilent Ref 15 dBm      Atten 25 dB      Mkr1 2.4020500 GHz Peak      0.753 dBm Log 10 dB/ Offst 1 dB Marker 2.40205000 GHz 0.753 dBm M1 S2 S3 FC AA Center 2.402 GHz      Span 5 MHz #Res BW 3 MHz      #VBW 3 MHz      Sweep 5 ms (401 pts)</p>			

**GFSK TX Mode**

**2441 MHz**

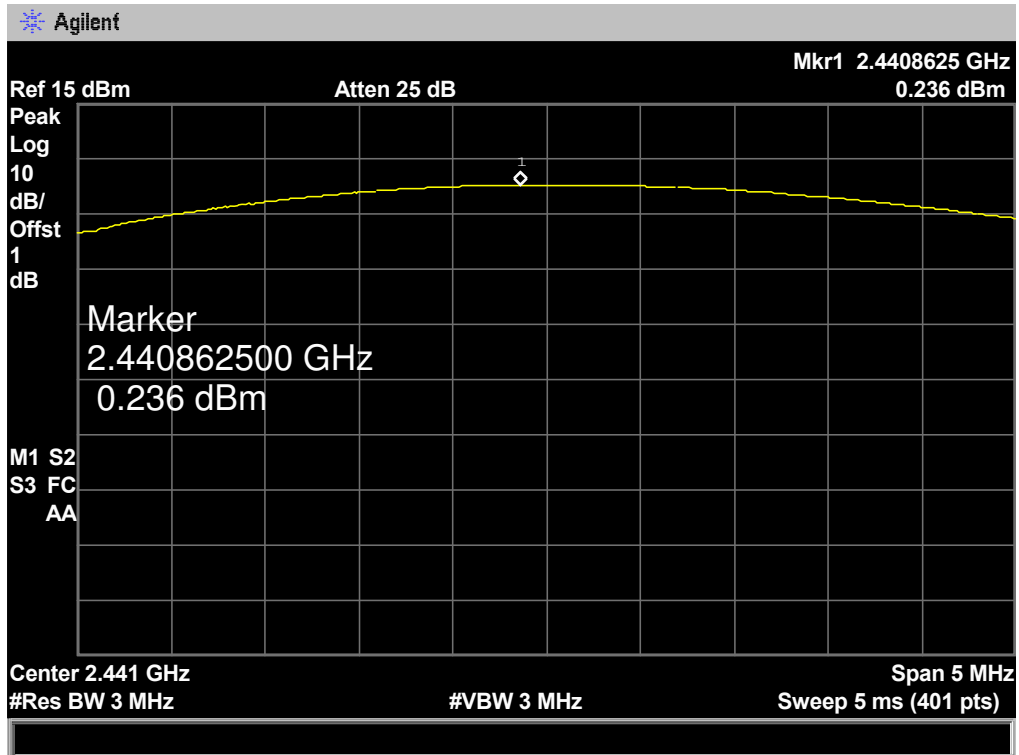

**GFSK TX Mode**

**2480 MHz**

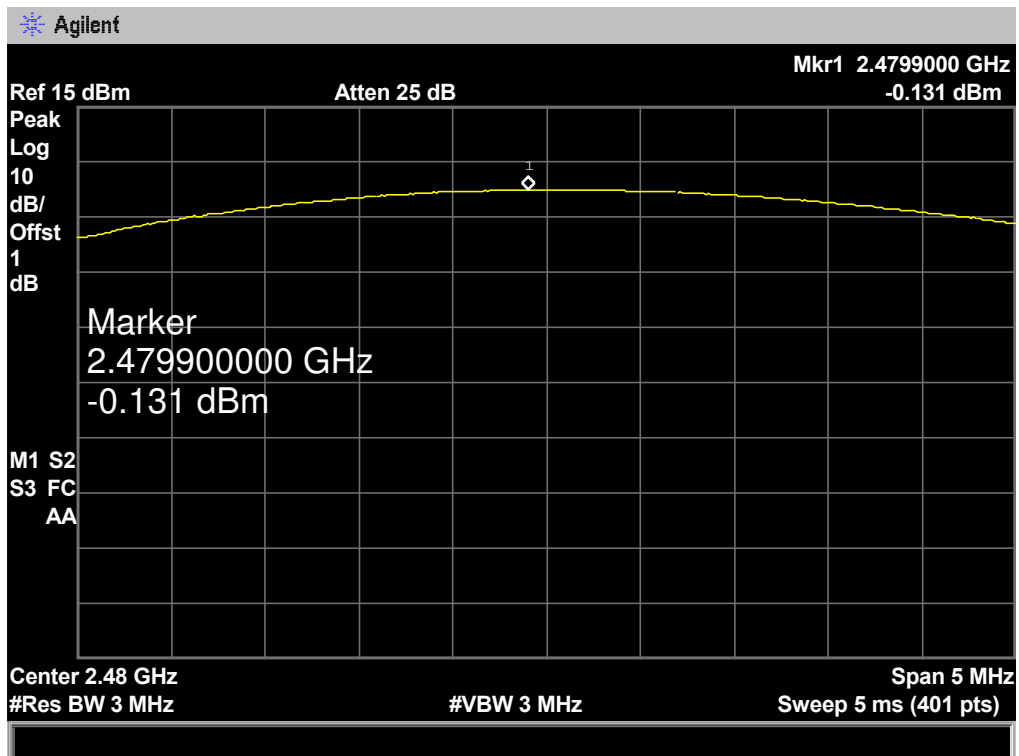



<b>EUT:</b>	Bluetooth speaker	<b>Model Name :</b>	MA-2241
<b>Temperature:</b>	25 °C	<b>Relative Humidity:</b>	55%
<b>Test Voltage:</b>	DC 5V		
<b>Test Mode:</b>	TX Mode ( $\pi/4$ -DQPSK)		
<b>Channel frequency (MHz)</b>	<b>Test Result (dBm)</b>	<b>Limit (dBm)</b>	
2402	-0.211	<b>21</b>	
2441	-0.698		
2480	-1.155		

$\pi/4$ -DQPSK TX Mode

2402 MHz

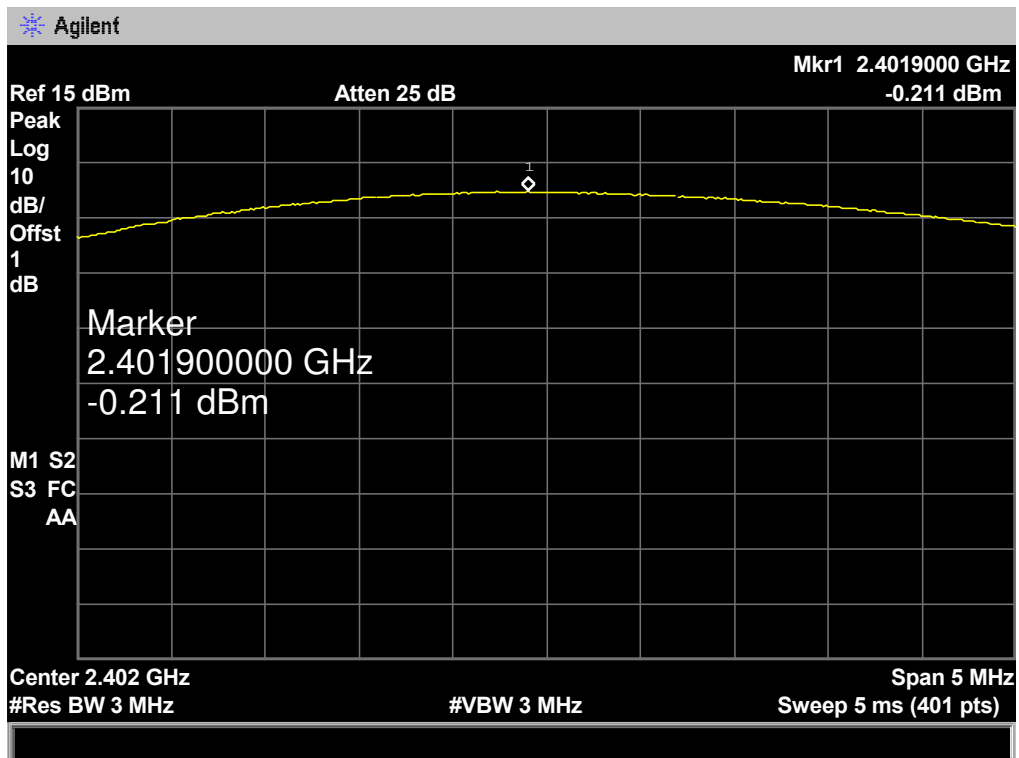

$\pi/4$ -DQPSK TX Mode  
2441 MHz

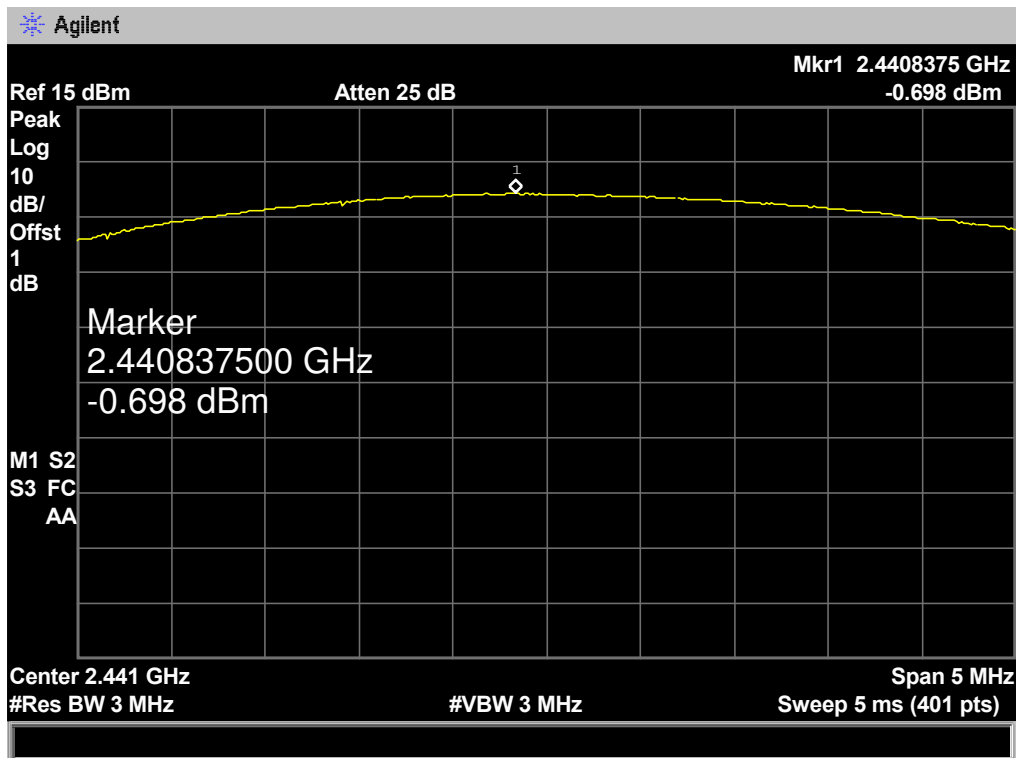

$\pi/4$ -DQPSK TX Mode  
2480 MHz

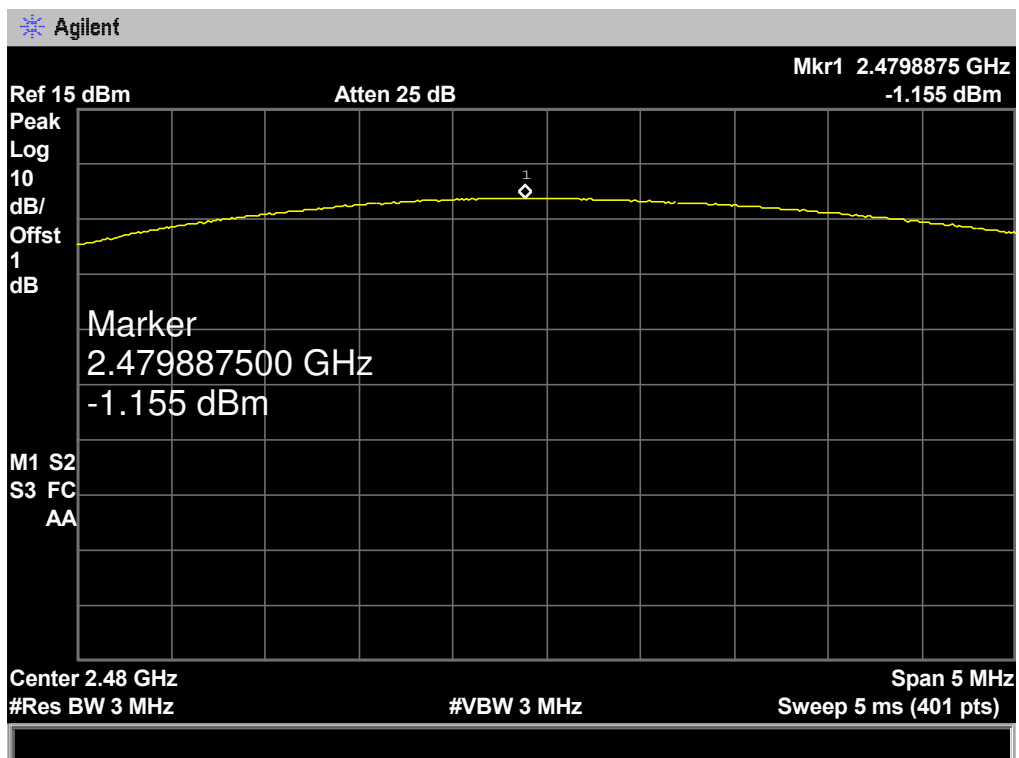

<b>EUT:</b>	Bluetooth speaker	<b>Model Name :</b>	MA-2241
<b>Temperature:</b>	25 °C	<b>Relative Humidity:</b>	55%
<b>Test Voltage:</b>	DC 5V		
<b>Test Mode:</b>	TX Mode (8-DPSK)		
<b>Channel frequency (MHz)</b>	<b>Test Result (dBm)</b>	<b>Limit (dBm)</b>	
2402	-0.598	<b>21</b>	
2441	-0.635		
2480	-1.543		

**8-DPSK TX Mode**

**2402 MHz**

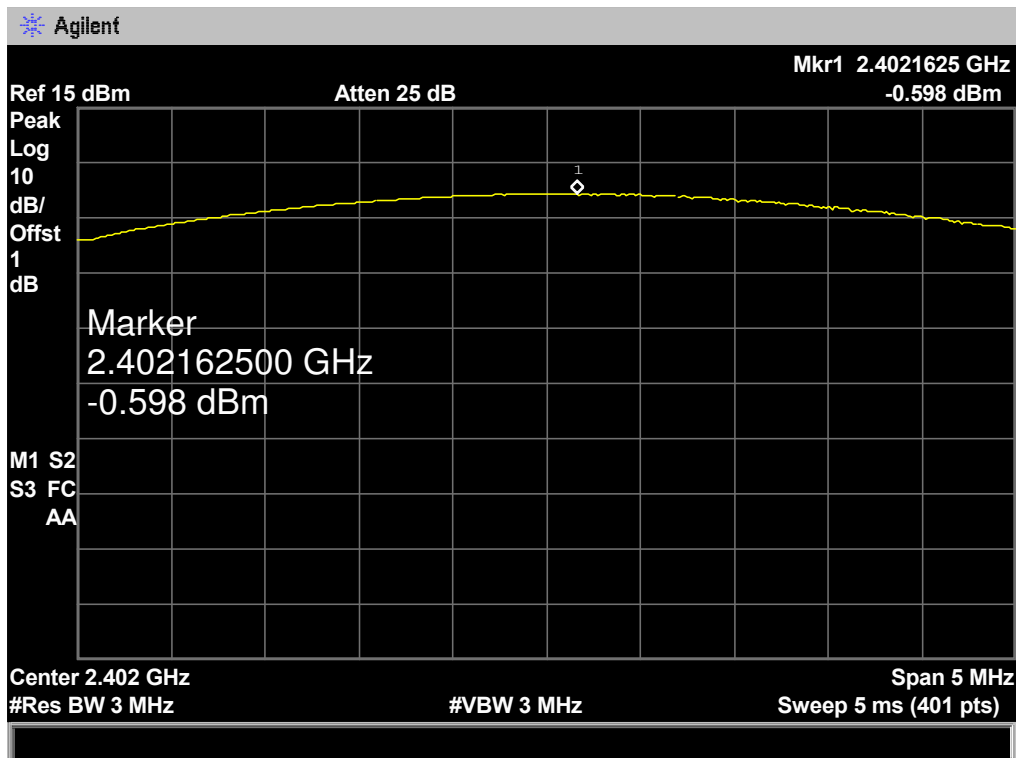

**8-DPSK TX Mode**

**2441 MHz**

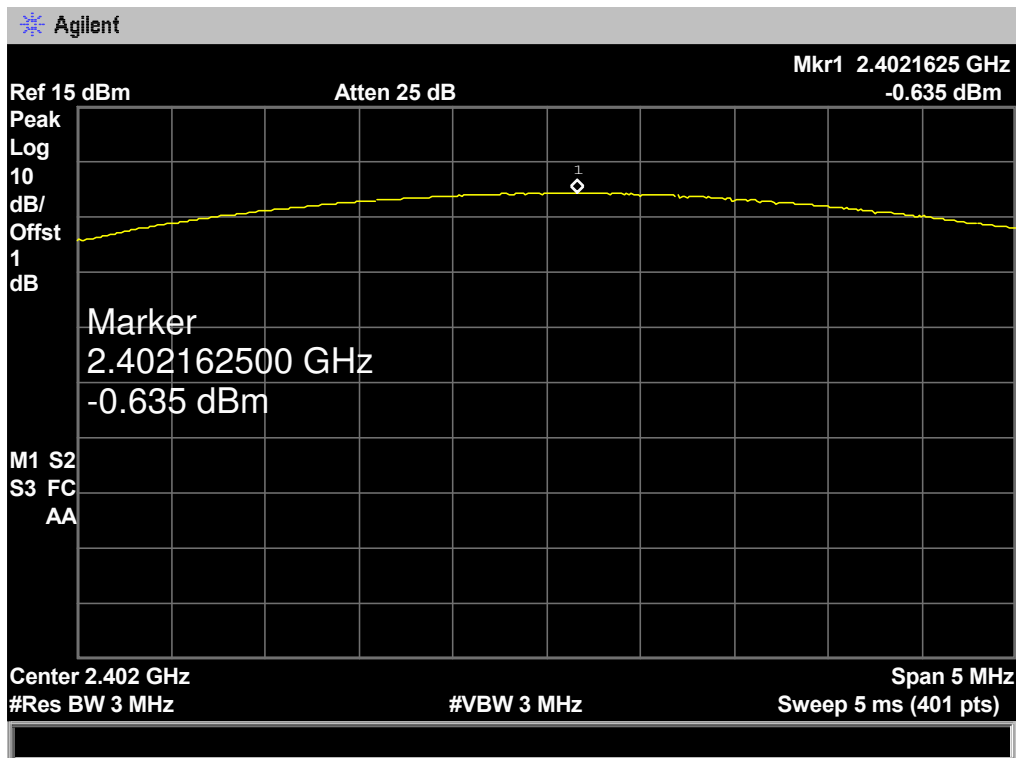

**8-DPSK TX Mode**

**2480 MHz**

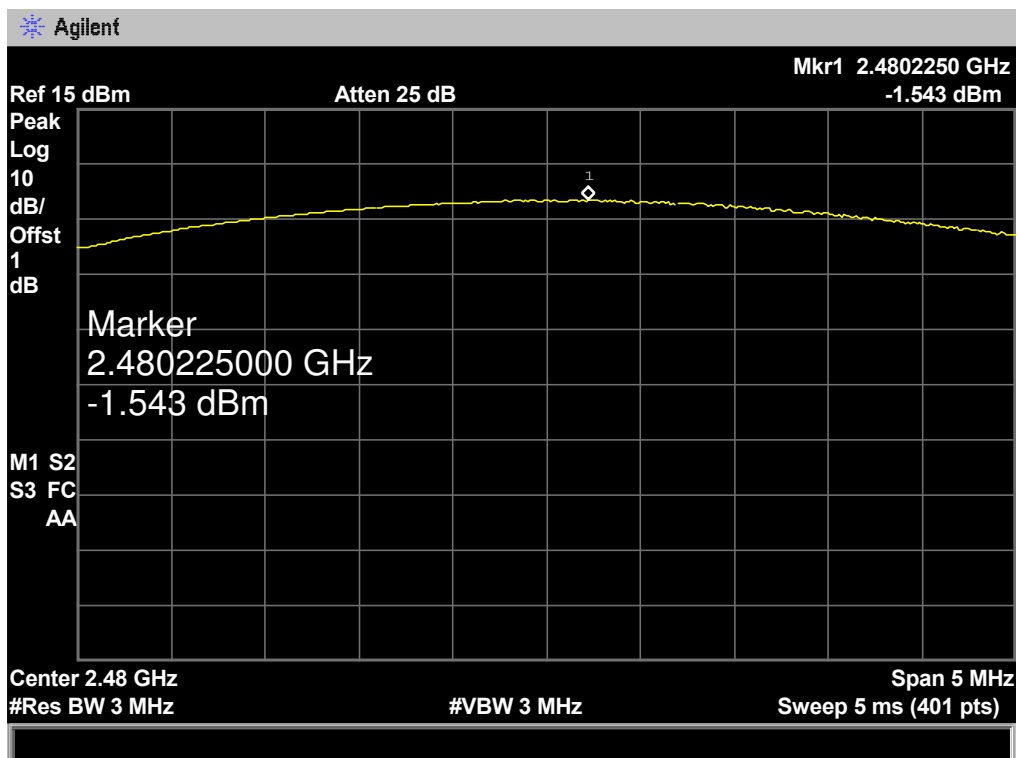

---

---

## 11. Antenna Requirement

### 11.1 Standard Requirement

#### 11.1.1 Standard

FCC Part 15.203

#### 11.1.2 Requirement

An intentional radiator shall be designed to ensure that no antenna other than that furnished by the responsible party shall be used with the device. The use of a permanently attached antenna or of an antenna that uses a unique coupling to the intentional radiator shall be considered sufficient to comply with the provisions of this Section. The manufacturer may design the unit so that a broken antenna can be replaced by the user, but the use of a standard antenna jack or electrical connector is prohibited.

### 11.2 Antenna Connected Construction

The directional gains of the antenna used for transmitting is 2 dBi, and the antenna connector is de-signed with permanent attachment and no consideration of replacement. Please see the EUT photo for details.

The EUT antenna is a PCB antenna. It complies with the standard requirement.

Antenna Type
<input checked="" type="checkbox"/> Permanent attached antenna
<input type="checkbox"/> Unique connector antenna
<input type="checkbox"/> Professional installation antenna