



RADIO TEST REPORT

Report No: STS1606054F01

Issued for

Dongguan Jin wen hua digital technology Co., LTD.

NO.1 Hua Da Road, Long Bei Ling Village, Tangxia Town,
Dongguan City, Guangdong, China

Product Name:	Bluetooth Speaker
Brand Name:	AOMAIS
Model Name:	F3
Series Model:	N/A
FCC ID:	2AFSGF3
Test Standard:	FCC Part 15.247

Any reproduction of this document must be done in full. No single part of this document may be reproduced without permission from STS, All Test Data Presented in this report is only applicable to presented Test sample.





TEST RESULT CERTIFICATION

Applicant's name..... Dongguan Jin wen hua digital technology Co., LTD.
 Address NO.1 Hua Da Road, Long Bei Ling Village, Tangxia Town, Dongguan City, Guangdong, China
Manufacture's Name Dongguan Jin wen hua digital technology Co., LTD.
 Address NO.1 Hua Da Road, Long Bei Ling Village, Tangxia Town, Dongguan City, Guangdong, China

Product description

Product name..... Bluetooth Speaker
 Brand name..... AOMAIS
 Model and/or type reference .. F3
Standards..... FCC Part15.247
 Test procedure..... ANSI C63.10-2013

This device described above has been tested by STS, and the test results show that the equipment under test (EUT) is in compliance with the FCC requirements. And it is applicable only to the tested sample identified in the report.
 This report shall not be reproduced except in full, without the written approval of STS, this document may be altered or revised by STS, personal only, and shall be noted in the revision of the document.

Date of Test.....

Date (s) of performance of tests.. 07 June 2016 ~20 June 2016
 Date of Issue 21 June 2016
 Test Result Pass

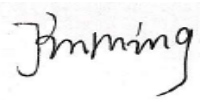
Testing Engineer : 

 (Jin Ming)

Technical Manager : 

 (Vita Li)

Authorized Signatory : 

 (Bovey Yang)





Table of Contents	Page
1. SUMMARY OF TEST RESULTS	6
1.1 TEST FACTORY	7
1.2 MEASUREMENT UNCERTAINTY	7
2. GENERAL INFORMATION	8
2.1 GENERAL DESCRIPTION OF EUT	8
2.2 DESCRIPTION OF TEST MODES	10
2.3 TABLE OF PARAMETERS OF TEXT SOFTWARE SETTING	10
2.4 BLOCK DIGRAM SHOWING THE CONFIGURATION OF SYSTEM TESTED	11
2.5 DESCRIPTION OF SUPPORT UNITS	12
2.6 EQUIPMENTS LIST FOR ALL TEST ITEMS	13
3. EMC EMISSION TEST	14
3.1 CONDUCTED EMISSION MEASUREMENT	14
3.2 RADIATED EMISSION MEASUREMENT	18
4. CONDUCTED SPURIOUS EMISSIONS	33
4.1 REQUIREMENT	33
4.2 TEST PROCEDURE	33
4.3 TEST SETUP	33
4.4 EUT OPERATION CONDITIONS	33
4.5 TEST RESULTS	34
5. NUMBER OF HOPPING CHANNEL	46
5.1 APPLIED PROCEDURES / LIMIT	46
5.2 TEST PROCEDURE	46
5.3 TEST SETUP	46
5.4 EUT OPERATION CONDITIONS	46
5.5 TEST RESULTS	47
6. AVERAGE TIME OF OCCUPANCY	48
6.1 APPLIED PROCEDURES / LIMIT	48
6.2 TEST PROCEDURE	48
6.3 TEST SETUP	48
6.4 EUT OPERATION CONDITIONS	48
6.5 TEST RESULTS	49
7. HOPPING CHANNEL SEPARATION MEASUREMEN	55



Table of Contents	Page
7.1 APPLIED PROCEDURES / LIMIT	55
7.2 TEST PROCEDURE	55
7.3 TEST SETUP	55
7.4 EUT OPERATION CONDITIONS	55
7.5 TEST RESULTS	56
8. BANDWIDTH TEST	62
8.1 APPLIED PROCEDURES / LIMIT	62
8.2 TEST PROCEDURE	62
8.3 TEST SETUP	62
8.4 EUT OPERATION CONDITIONS	62
8.5 TEST RESULTS	63
9. PEAK OUTPUT POWER TEST	69
9.1 APPLIED PROCEDURES / LIMIT	69
9.2 TEST PROCEDURE	69
9.3 TEST SETUP	69
9.4 EUT OPERATION CONDITIONS	69
9.5 TEST RESULTS	70
10. ANTENNA REQUIREMENT	71
10.1 STANDARD REQUIREMENT	71
10.2 EUT ANTENNA	71



Revision History

Rev.	Issue Date	Report NO.	Effect Page	Contents
00	21 June 2016	STS1606054F01	ALL	Initial Issue





1. SUMMARY OF TEST RESULTS

Test procedures according to the technical standards:

(1)KDB DA 00-705

(2)KDB 558074 D01 DTS Meas Guidance v03r04

FCC Part15 (15.247) , Subpart C			
Standard Section	Test Item	Judgment	Remark
15.207	Conducted Emission	PASS	--
15.247(a)(1)	Hopping Channel Separation	PASS	--
15.247(a)(1)&(b)(1)	Output Power	PASS	--
15.247(c)	Radiated Spurious Emission	PASS	--
15.247(d)	Conducted Spurious & Band Edge Emission	PASS	--
15.247(a)(iii)	Number of Hopping Frequency	PASS	--
15.247(a)(iii)	Dwell Time	PASS	--
15.247(a)(1)	Bandwidth	PASS	--
15.205	Band Edge Emission	PASS	--
15.203	Antenna Requirement	PASS	--

NOTE:

(1) "N/A" denotes test is not applicable in this Test Report

(2) all tests are according to ANSI C63.10-2013



1.1 TEST FACTORY

Shenzhen STS Test Services Co., Ltd.

Add. : 1/F., Building B, Zhuoke Science Park, No.190,Chongqing Road,
Fuyong Street, Bao'an District, Shenzhen, Guangdong,China

CNAS Registration No.: L7649;

FCC Registration No.: 842334; IC Registration No.: 12108A-1

1.2 MEASUREMENT UNCERTAINTY

The reported uncertainty of measurement $y \pm U$, where expanded uncertainty U is based on a standard uncertainty multiplied by a coverage factor of $k=2$, providing a level of confidence of approximately **95 %**.

No.	Item	Uncertainty
1	Conducted Emission (9KHz-150KHz)	$\pm 2.88\text{dB}$
2	Conducted Emission (150KHz-30MHz)	$\pm 2.67\text{dB}$
3	RF power,conducted	$\pm 0.70\text{dB}$
4	Spurious emissions,conducted	$\pm 1.19\text{dB}$
5	All emissions,radiated(<1G) 30MHz-200MHz	$\pm 2.83\text{dB}$
6	All emissions,radiated(<1G) 200MHz-1000MHz	$\pm 2.94\text{dB}$
7	All emissions,radiated(>1G)	$\pm 3.03\text{dB}$
8	Temperature	$\pm 0.5^{\circ}\text{C}$
9	Humidity	$\pm 2\%$



2. GENERAL INFORMATION

2.1 GENERAL DESCRIPTION OF EUT

Equipment	Bluetooth Speaker
Trade Name	AOMAIS
Model Name	F3
Series Model	N/A
Model Difference	N/A
Channel List	Please refer to the Note 2.
Bluetooth	Frequency:2402 – 2480 MHz Modulation: GFSK(1Mbps), $\pi/4$ -DQPSK(2Mbps), 8-DPSK(3Mbps)
Power Adapter	Power supply and ADP(rating): Input:AC120V,60Hz Output: DC5V,1000mA
Battery	Battery(rating):. Rated Voltage: 3.7V Charge Limit: 4.2V Capacity :1500mAh
Hardware version number	WMHXP571BKCA
Software version number	V.01
Connecting I/O Port(s)	Please refer to the User's Manual

Note:

1. For a more detailed features description, please refer to the manufacturer's specifications or the User's Manual.



2.

Channel List					
Channel	Frequency (MHz)	Channel	Frequency (MHz)	Channel	Frequency (MHz)
00	2402	27	2429	54	2456
01	2403	28	2430	55	2457
02	2404	29	2431	56	2458
03	2405	30	2432	57	2459
04	2406	31	2433	58	2460
05	2407	32	2434	59	2461
06	2408	33	2435	60	2462
07	2409	34	2436	61	2463
08	2410	35	2437	62	2464
09	2411	36	2438	63	2465
10	2412	37	2439	64	2466
11	2413	38	2440	65	2467
12	2414	39	2441	66	2468
13	2415	40	2442	67	2469
14	2416	41	2443	68	2470
15	2417	42	2444	69	2471
16	2418	43	2445	70	2472
17	2419	44	2446	71	2473
18	2420	45	2447	72	2474
19	2421	46	2448	73	2475
20	2422	47	2449	74	2476
21	2423	48	2450	75	2477
22	2424	49	2451	76	2478
23	2425	50	2452	77	2479
24	2426	51	2453	78	2480
25	2427	52	2454		
26	2428	53	2455		

3. Table for Filed Antenna

Ant	Brand	Model Name	Antenna Type	Connector	Gain (dBi)	NOTE
1	AOMAIS	F3	PCB Antenna	N/A	0	BT Antenna

The EUT antenna is PCB Antenna. no antenna other than that furnished by the responsible party shall be used with the device.



2.2 DESCRIPTION OF TEST MODES

To investigate the maximum EMI emission characteristics generates from EUT, the test system was pre-scanning tested base on the consideration of following EUT operation mode or test configuration mode which possible have effect on EMI emission level. Each of these EUT operation mode(s) or test configuration mode(s) mentioned above was evaluated respectively.

Pretest Mode	Description	Data Rate/Modulation
Mode 1	TX CH00	1Mbps/GFSK
Mode 2	TX CH39	1Mbps/GFSK
Mode 3	TX CH78	1Mbps/GFSK
Mode 4	TX CH00	2 Mbps/ π /4-DQPSK
Mode 5	TX CH39	2 Mbps/ π /4-DQPSK
Mode 6	TX CH78	2 Mbps/ π /4-DQPSK
Mode7	TX CH00	3 Mbps/8-DPSK
Mode 8	TX CH39	3 Mbps/8-DPSK
Mode 9	TX CH78	3 Mbps/8-DPSK

Note:

- (1) All above mode have been measurement, only worst data was reported.
- (2) We have be tested for all available U.S. voltage and frequencies (For 120V, 60Hz) for which the device is capable of operation.

ForACConductedEmission

Test Case	
AC Conducted Emission	Mode 10 : Keeping BT TX

2.3 TABLE OF PARAMETERS OF TEXT SOFTWARE SETTING

During testing channel & power controlling software provided by the customer was used to control the operating channel as well as the output power level. The RF output power selection is for the setting of RF output power expected by the customer and is going to be fixed on the firmware of the final end product power parameters of FHSS

Test software Version	Test program: Bluetooth		
Frequency	2402 MHz	2441 MHz	2480 MHz
CSR (Power control software) Parameters(1/2/3Mbps)	Power class: 1 M rate:4:27 2 M rate:11:183 3 M rate:15:339	Power class: 1 M rate:4:27 2 M rate:11:183 3 M rate:15:339	Power class: 1 M rate:4:27 2 M rate:11:183 3 M rate:15:339



2.4 BLOCK DIGRAM SHOWING THE CONFIGURATION OF SYSTEM TESTED

During testing channel & power controlling software provided by the customer was used to control the operating channel as well as the output power level. The RF output power selection is for the setting of RF output power expected by the customer and is going to be fixed on the firmware of the final end product power parameters of FHSS

Radiated Spurious Emission Test

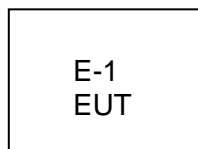

Conducted Emission Test

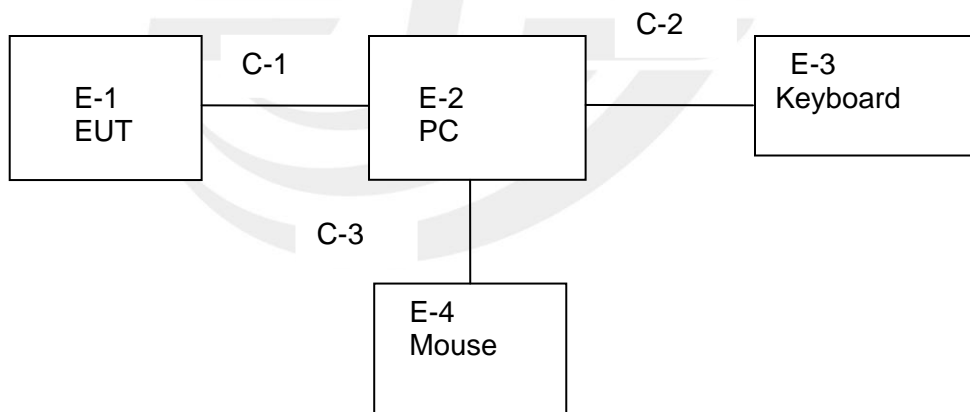



2.5 DESCRIPTION OF SUPPORT UNITS

The EUT has been tested as an independent unit together with other necessary accessories or support units. The following support units or accessories were used to form a representative test configuration during the tests.

Item	Equipment	Mfr/Brand	Model/Type No.	Serial No.	Note
E-1	Bluetooth Speaker	AOMAIS	F3	N/A	EUT
E-2	PC	4CV428DQXR	500-320cx	4CV428DQYN	N/A
E-3	Keyboard	HP	PR1101U	DKUSB1B06Q42209FBK800	N/A
E-4	Mouse	MOTOSPEED	F66	697738-001	N/A

Item	Shielded Type	Ferrite Core	Length	Note
C-1	USB Cable (FTP)	NO	100cm	N/A
C-2	USB Cable(FTP)	NO	120cm	N/A
C-3	USB Cable(FTP)	NO	100cm	N/A

Note:

- (1) The support equipment was authorized by Declaration of Confirmation.
- (2) For detachable type I/O cable should be specified the length in cm in 『Length』 column.
- (3) “YES” is means “shielded” “with core”; “NO” is means “unshielded” “without core”.



2.6 EQUIPMENTS LIST FOR ALL TEST ITEMS

Radiation Test equipment

Kind of Equipment	Manufacturer	Type No.	Serial No.	Last calibration	Calibrated until
Spectrum Analyzer	Agilent	E4407B	MY50140340	2015.10.25	2016.10.24
Test Receiver	R&S	ESCI	101427	2015.10.25	2016.10.24
Bilog Antenna	TESEQ	CBL6111D	34678	2015.11.25	2016.11.24
Horn Antenna	Schwarzbeck	BBHA 9120D	9120D-1343	2016.03.06	2017.03.05
Horn Antenna	Schwarzbeck	BBHA 9170	9170-0741	2016.03.06	2017.03.05
50Ω Coaxial Switch	Anritsu	MP59B	6200264416	2016.06.06	2017.06.05
PreAmplifier	Agilent	8449B	60538	2015.10.25	2016.10.24
Loop Antenna	ARA	PLA-1030/B	1029	2016.06.08	2017.06.07
Preamplifier	Agilent	8449B	60538	2015.11.05	2016.11.05
Low frequency cable	EM	R01	N/A	N/A	N/A
High frequency cable	SCHWARZBECK	AK9515H	SN-96286/96287	N/A	N/A

Conduction Test equipment

Kind of Equipment	Manufacturer	Type No.	Serial No.	Last calibration	Calibrated until
EMI Test Receiver	R&S	ESPI	102086	2015.11.20	2016.11.19
LISN	R&S	ENV216	101242	2015.10.25	2016.10.24
LISN	EMCO	3810/2NM	000-23625	2015.10.25	2016.10.24
Conduction Cable	EM	C01	N/A	N/A	N/A

RF Connected Test

Kind of Equipment	Manufacturer	Type No.	Serial No.	Last calibration	Calibrated until
USB RF power sensor	DARE	RPR3006W	15I00041SNO03	2015.10.25	2016.10.24
Spectrum Analyzer	Agilent	E4407B	MY50140340	2015.10.25	2016.10.24
Signal Analyzer	Agilent	N9020A	MY49100060	2015.11.18	2016.11.17



3. EMC EMISSION TEST

3.1 CONDUCTED EMISSION MEASUREMENT

3.1.1 POWER LINE CONDUCTED EMISSION LIMITS

Operating frequency band. In case the emission fall within the restricted band specified on Part 15.107(a)&207(a) limit in the table below has to be followed.

FREQUENCY (MHz)	Conducted Emissionlimit (dBuV)	
	Quasi-peak	Average
0.15 -0.5	66 - 56 *	56 - 46 *
0.50 -5.0	56.00	46.00
5.0 -30.0	60.00	50.00

Note:

- (1) The tighter limit applies at the band edges.
- (2) The limit of " * " marked band means the limitation decreases linearly with the logarithm of the frequency in the range.

The following table is the setting of the receiver

Receiver Parameters	Setting
Attenuation	10 dB
Start Frequency	0.15 MHz
Stop Frequency	30 MHz
IF Bandwidth	9 kHz

3.1.2 TEST PROCEDURE

- a. The EUT was placed 0.4 meters from the horizontal ground plane with EUT being connected to the power mains through a line impedance stabilization network (LISN). All other support equipments powered from additional LISN(s). The LISN provide 50 Ohm/ 50uH of coupling impedance for the measuring instrument.
- b. Interconnecting cables that hang closer than 40 cm to the ground plane shall be folded back and forth in the center forming a bundle 30 to 40 cm long.
- c. I/O cables that are not connected to a peripheral shall be bundled in the center. The end of the cable may be terminated, if required, using the correct terminating impedance. The overall length shall not exceed 1 m.
- d. LISN at least 80 cm from nearest part of EUT chassis.
- e. For the actual test configuration, please refer to the related Item –EUT Test Photos.

3.1.3 TEST SETUP

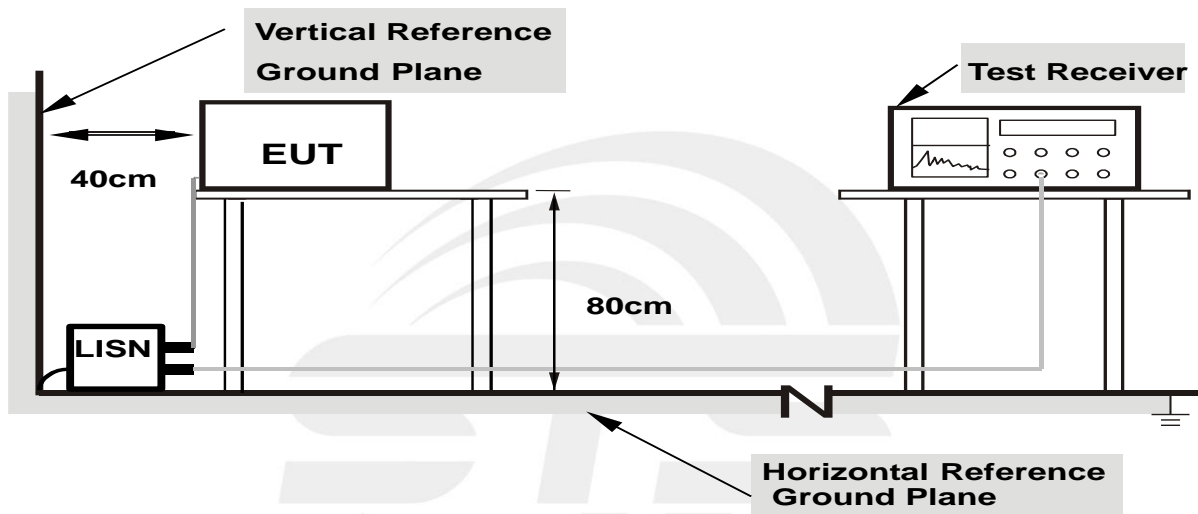

Note: 1.Support units were connected to second LISN.

2.Both of LISNs (AMN) are 80 cm from EUT and at least 80 from other units and other metal planes

3.1.4 EUT OPERATING CONDITIONS

The EUT was configured for testing in a typical fashion (as a customer would normally use it). The EUT has been programmed to continuously transmit during test. This operating condition was tested and used to collect the included data.



3.1.5 TEST RESULTS

Temperature:	26 °C	Relative Humidity:	54%
Pressure:	1010hPa	Phase:	L
Test Mode:	Mode 10		

Frequency (MHz)	Reading (dBuV)	Correct Factor(dB)	Result (dBuV)	Limit (dBuV)	Margin (dB)	Remark
0.1820	39.99	9.55	49.54	64.39	-14.85	QP
0.1820	23.47	9.55	33.02	54.39	-21.37	AVG
0.2500	32.96	9.63	42.59	61.76	-19.17	QP
0.2500	13.77	9.63	23.40	51.76	-28.36	AVG
2.4300	27.68	9.64	37.32	56.00	-18.68	QP
2.4300	24.78	9.64	34.42	46.00	-11.58	AVG
3.3140	29.31	9.63	38.94	56.00	-17.06	QP
3.3140	25.39	9.63	35.02	46.00	-10.98	AVG
3.7580	31.69	9.62	41.31	56.00	-14.69	QP
3.7580	26.30	9.62	35.92	46.00	-10.08	AVG
9.8700	33.08	9.63	42.71	60.00	-17.29	QP
9.8700	16.91	9.63	26.54	50.00	-23.46	AVG

Remark:

1. All readings are Quasi-Peak and Average values.
2. Margin = Result (Result =Reading + Factor)–Limit

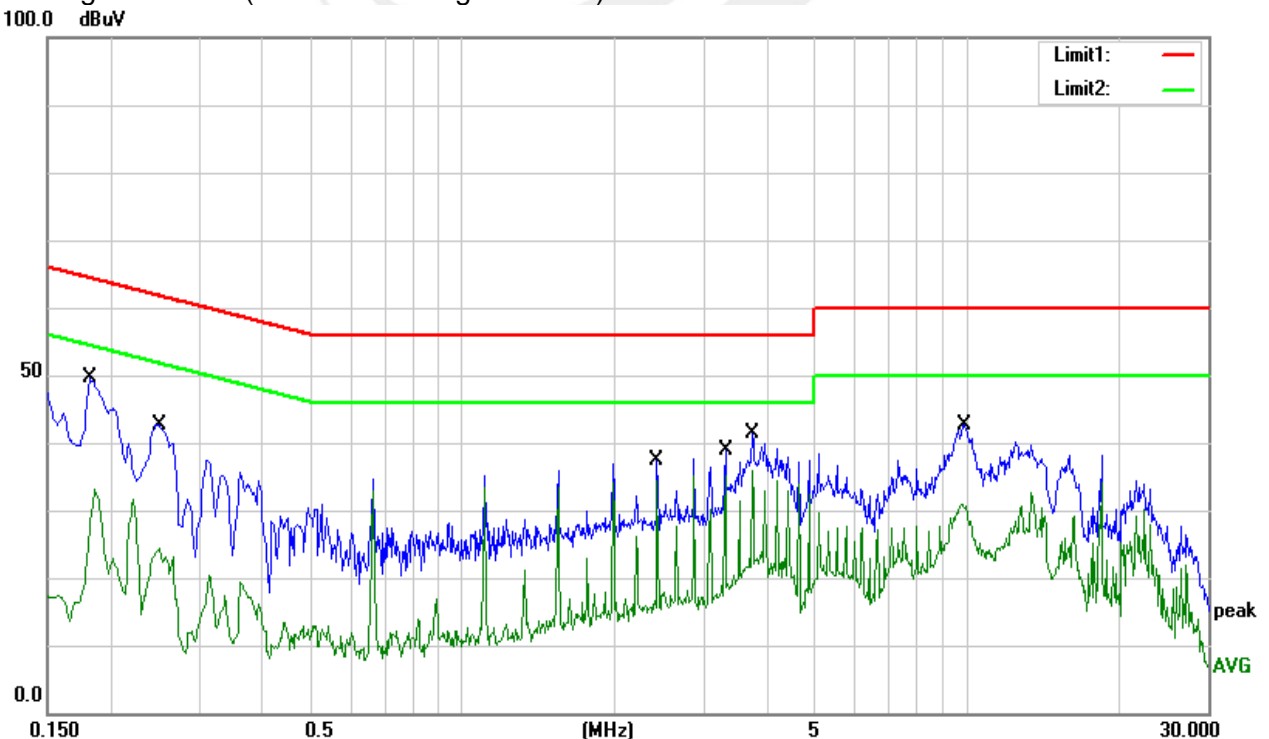



Temperature:	26 °C	Relative Humidity:	54%
Pressure:	1010hPa	Phase:	N
Test Mode:	Mode 10		

Frequency (MHz)	Reading (dBuV)	Correct Factor(dB)	Result (dBuV)	Limit (dBuV)	Margin (dB)	Remark
0.1820	39.83	0.03	39.86	64.39	-24.53	QP
0.1820	26.28	0.03	26.31	54.39	-28.08	AVG
0.6620	26.25	0.04	26.29	56.00	-29.71	QP
0.6620	24.03	0.04	24.07	46.00	-21.93	AVG
1.1060	26.77	0.05	26.82	56.00	-29.18	QP
1.1060	24.59	0.05	24.64	46.00	-21.36	AVG
2.4300	28.35	0.06	28.41	56.00	-27.59	QP
2.4300	25.08	0.06	25.14	46.00	-20.86	AVG
3.7580	29.89	0.06	29.95	56.00	-26.05	QP
3.7580	25.32	0.06	25.38	46.00	-20.62	AVG
9.8740	33.23	0.10	33.33	60.00	-26.67	QP
9.8740	18.14	0.10	18.24	50.00	-31.76	AVG

Remark:

1. All readings are Quasi-Peak and Average values.
2. Margin = Result (Result = Reading + Factor) – Limit

100.0 dBuV

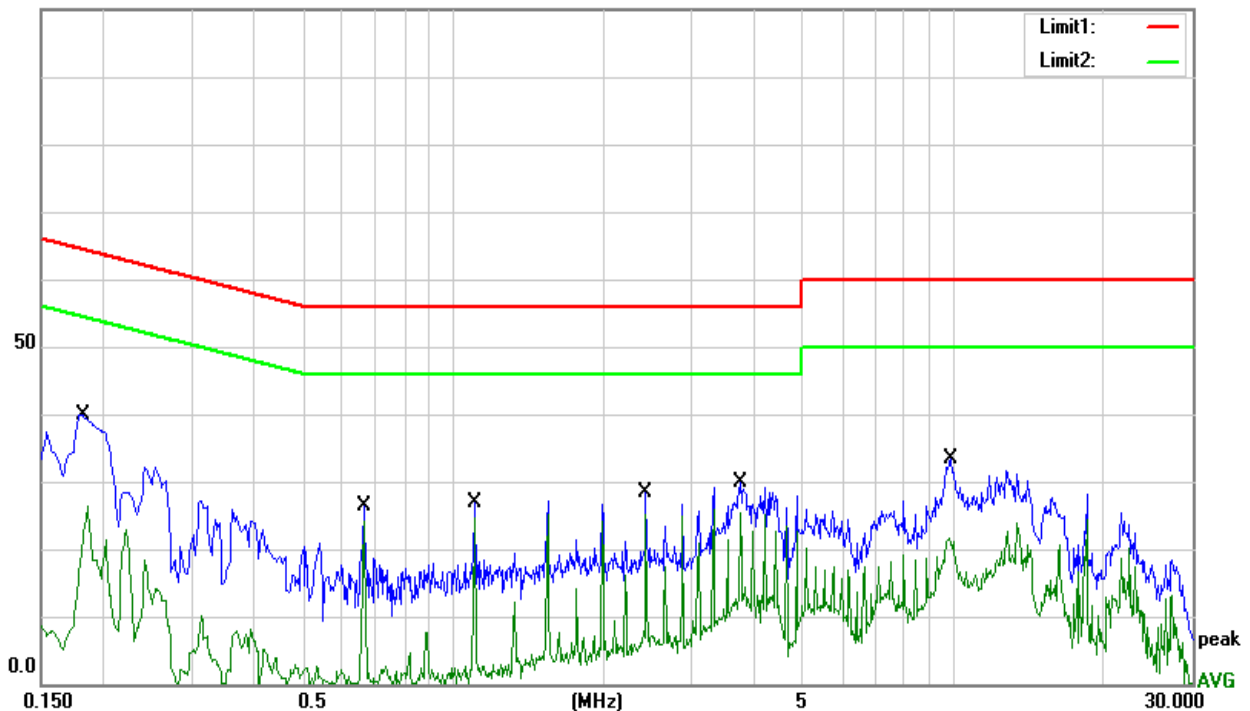



3.2 RADIATED EMISSION MEASUREMENT

3.2.1 RADIATED EMISSION LIMITS

in any 100 kHz bandwidth outside the operating frequency band. In case the emission fall within the restricted band specified on Part15.205(a)&209(a) limit in the table below has to be followed.

LIMITS OF RADIATED EMISSION MEASUREMENT (0.009MHz - 1000MHz)

Frequencies (MHz)	Field Strength (microrvolts/meter)	Measurement Distance (meters)
0.009~0.490	2400/F(KHz)	300
0.490~1.705	24000/F(KHz)	30
1.705~30.0	30	30
30~88	100	3
88~216	150	3
216~960	200	3
Above 960	500	3

LIMITS OF RADIATED EMISSION MEASUREMENT (1GHz-25 GHz)

FREQUENCY (MHz)	Class B (dBuV/m) (at 3M)	
	PEAK	AVERAGE
Above 1000	74	54

Notes:

- (1) The limit for radiated test was performed according to FCC PART 15C.
- (2) The tighter limit applies at the band edges.
- (3) Emission level (dBuV/m)=20log Emission level (uV/m).

For Radiated Emission

Spectrum Parameter	Setting
Attenuation	Auto
Detector	Peak
Start Frequency	1000 MHz(Peak/AV)
Stop Frequency	10 th carrier hamonic(Peak/AV)
RB / VB (emission in restricted band)	PK=1MHz / 1MHz, AV=1 MHz /10 Hz

For Band edge

Spectrum Parameter	Setting
Detector	Peak
Start/Stop Frequency	Lower Band Edge: 2300 to 2430 MHz Upper Band Edge: 2450 to 2500 MHz
RB / VB (emission in restricted band)	PK=1MHz / 1MHz, AV=1 MHz /10 Hz



Receiver Parameter	Setting
Attenuation	Auto
Start ~ Stop Frequency	9kHz~90kHz / RB 200Hz for PK & AV
Start ~ Stop Frequency	90kHz~110kHz / RB 200Hz for QP
Start ~ Stop Frequency	110kHz~490kHz / RB 200Hz for PK & AV
Start ~ Stop Frequency	490kHz~30MHz / RB 9kHz for QP
Start ~ Stop Frequency	30MHz~1000MHz / RB 120kHz for QP

3.2.2 TEST PROCEDURE

- The measuring distance of at 3 m shall be used for measurements at frequency 0.009MHz up to 1GHz and above 1GHz.
- The EUT was placed on the top of a rotating table 0.8 meters(above 1GHz is 1.5 m) above the ground at a 3 meter anechoic chamber test site. The table was rotated 360 degrees to determine the position of the highest radiation.
- The height of the equipment or of the measurement antenna shall be 0.8 m(above 1GHz is 1.5 m); the height of the test antenna shall vary between 1 m to 4 m. horizontal and vertical polarizations of the antenna are set to make the measurement.
- The initial step in collecting conducted emission data is a spectrum analyzer peak detector mode pre-scanning the measurement frequency range. Significant peaks are then marked and then Quasi Peak detector mode re-measured.
- If the Peak Mode measured value compliance with and lower than Quasi Peak Mode Limit, the EUT shall be deemed to meet QP Limits and then no additional QP Mode measurement performed.
- For the actual test configuration, please refer to the related Item –EUT Test Photos.

Note:

Both horizontal and vertical antenna polarities were tested and performed pretest to three orthogonal axis. The worst case emissions were reported

3.2.3 DEVIATION FROM TEST STANDARD

No deviation

3.2.4 TEST SETUP

(A) Radiated Emission Test-Up Frequency Below 30MHz

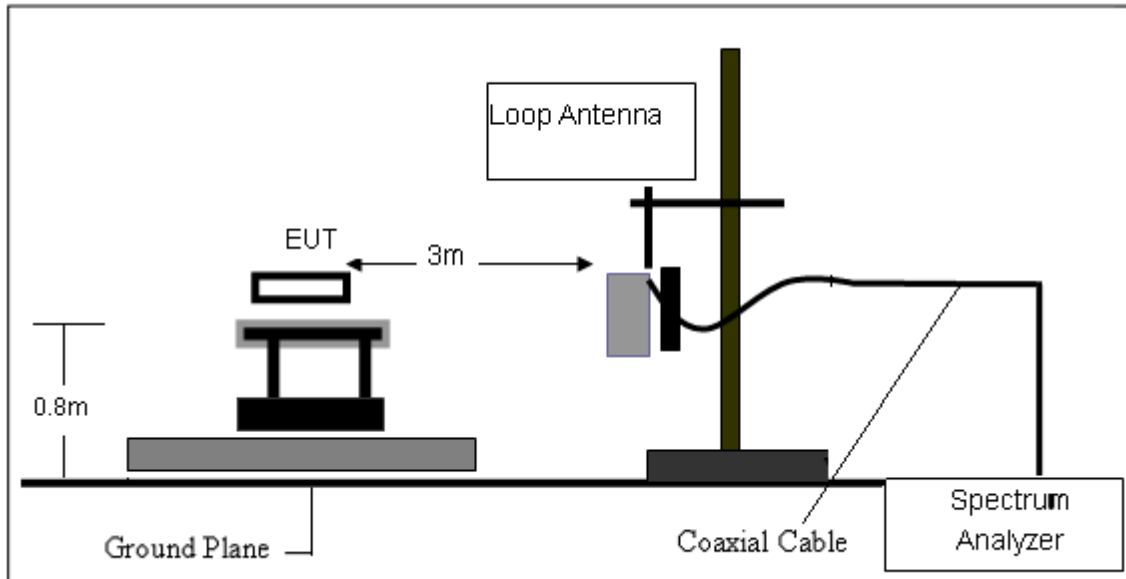

(B) Radiated Emission Test-Up Frequency 30MHz~1GHz

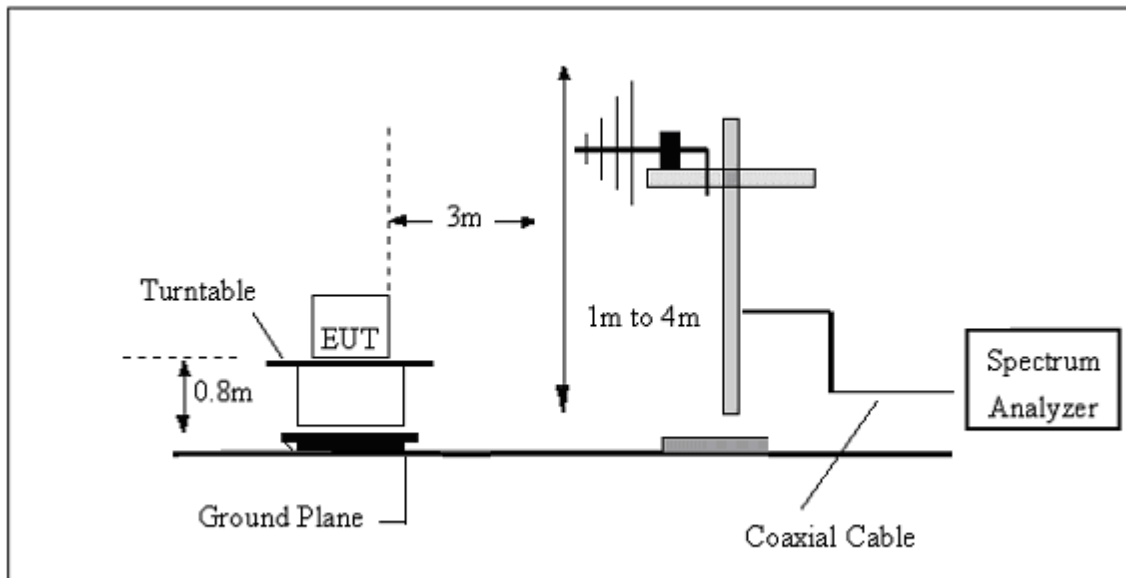

(C) Radiated Emission Test-Up Frequency Above 1GHz

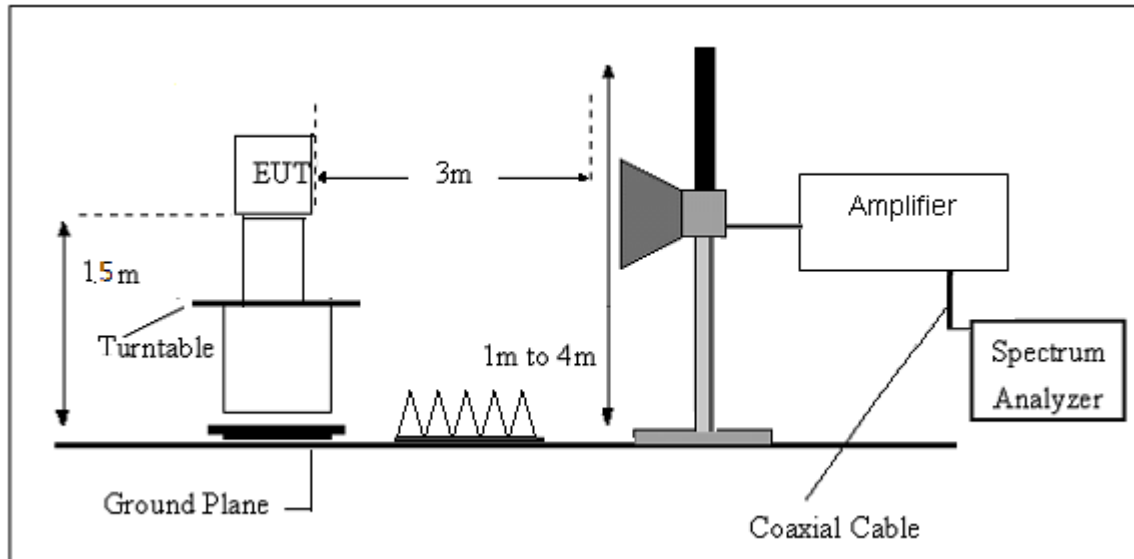

3.2.5 EUT OPERATING CONDITIONS

The EUT tested system was configured as the statements of 2.4 Unless otherwise a special operating condition is specified in the follows during the testing.



3.2.6 TEST RESULTS

Below 30MHz

Temperature:	26 °C	Relative Humidity:	54%
Pressure:	1010hPa	Test Mode:	TX Mode
Test Voltage:	3.7V from Battery		

Freq. (MHz)	Reading (dBuV/m)	Limit (dBuV/m)	Margin (dB)	State P/F	Test Result
--	--	--	--	--	PASS
--	--	--	--	--	PASS

Note:

The amplitude of spurious emissions which are attenuated by more than 20dB below the permissible value has no need to be reported.

Distance extrapolation factor = $40 \log(\text{specific distance}/\text{test distance})$ (dB);

Limit line = specific limits(dBuv) + distance extrapolation factor.

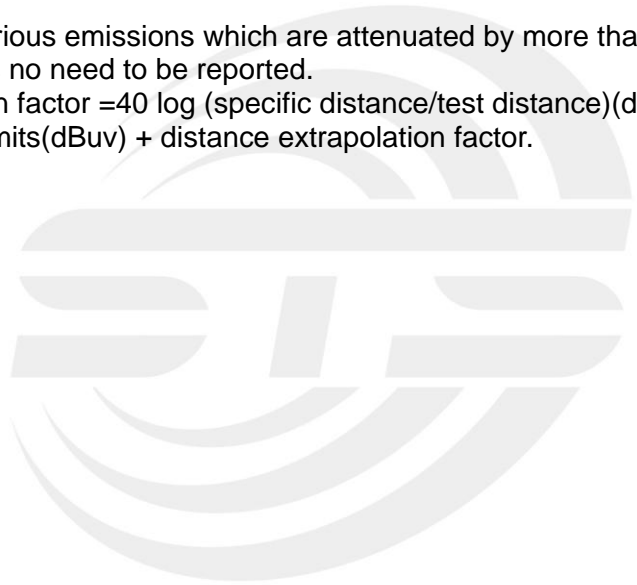



Between 30-1000MHz

Temperature:	26 °C	Relative Humidity:	54%
Pressure:	1010hPa	Phase:	Horizontal
Test Voltage:	3.7V from Battery	Test Mode:	Mode 1/2/3/4/5/6/7/8/9 (Mode 1 1M worst mode)

Frequency (MHz)	Reading (dBuV)	Correct Factor(dB/m)	Result (dBuV/m)	Limit (dBuV/m)	Margin (dB)	Remark
71.8320	54.83	-23.84	30.99	40.00	-9.01	QP
191.7450	53.09	-20.24	32.85	43.50	-10.65	QP
236.6447	51.39	-17.99	33.40	46.00	-12.60	QP
263.8190	47.41	-15.22	32.19	46.00	-13.81	QP
699.3046	40.95	-5.36	35.59	46.00	-10.41	QP
798.9796	39.43	-3.45	35.98	46.00	-10.02	QP

Remark:

1. All readings are Quasi-Peak and Average values.
2. Margin = Result (Result =Reading + Factor)–Limit

80.0 dBuV/m

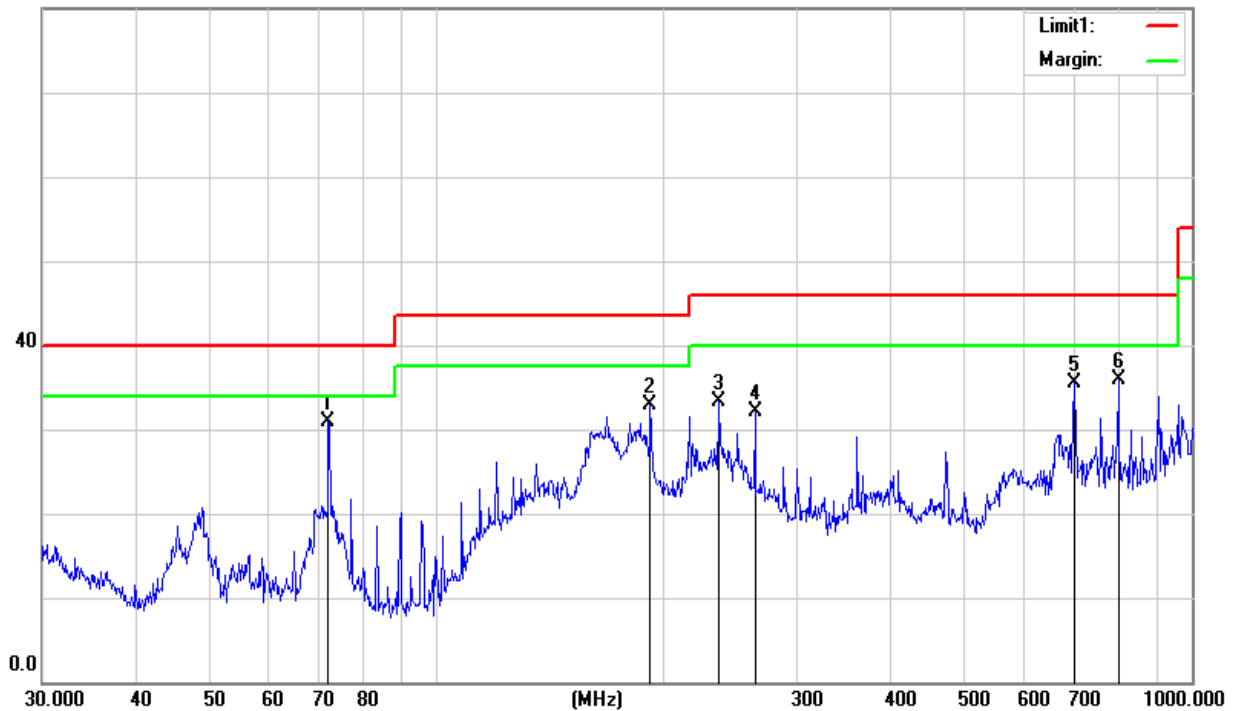



EUT:	Bluetooth Speaker	Model Name.:	F3
Temperature:	26 °C	Relative Humidity:	54%
Pressure:	1010hPa	Phase:	Vertical
Test Voltage:	3.7V from Battery	Test Mode:	Mode 1/2/3/4/5/6/7/8/9 (Mode 1 1M worst mode)

Frequency (MHz)	Reading (dBuV)	Correct Factor(dB/m)	Result (dBuV/m)	Limit (dBuV/m)	Margin (dB)	Remark
72.0841	54.87	-23.81	31.06	40.00	-8.94	QP
119.8555	50.46	-17.70	32.76	43.50	-10.74	QP
166.0680	52.57	-19.00	33.57	43.50	-9.93	QP
216.0240	52.44	-19.37	33.07	46.00	-12.93	QP
473.8346	43.36	-9.62	33.74	46.00	-12.26	QP
696.8567	37.80	-5.42	32.38	46.00	-13.62	QP

Remark:

1. All readings are Quasi-Peak and Average values.
2. Margin = Result (Result = Reading + Factor) – Limit

80.0 dBuV/m

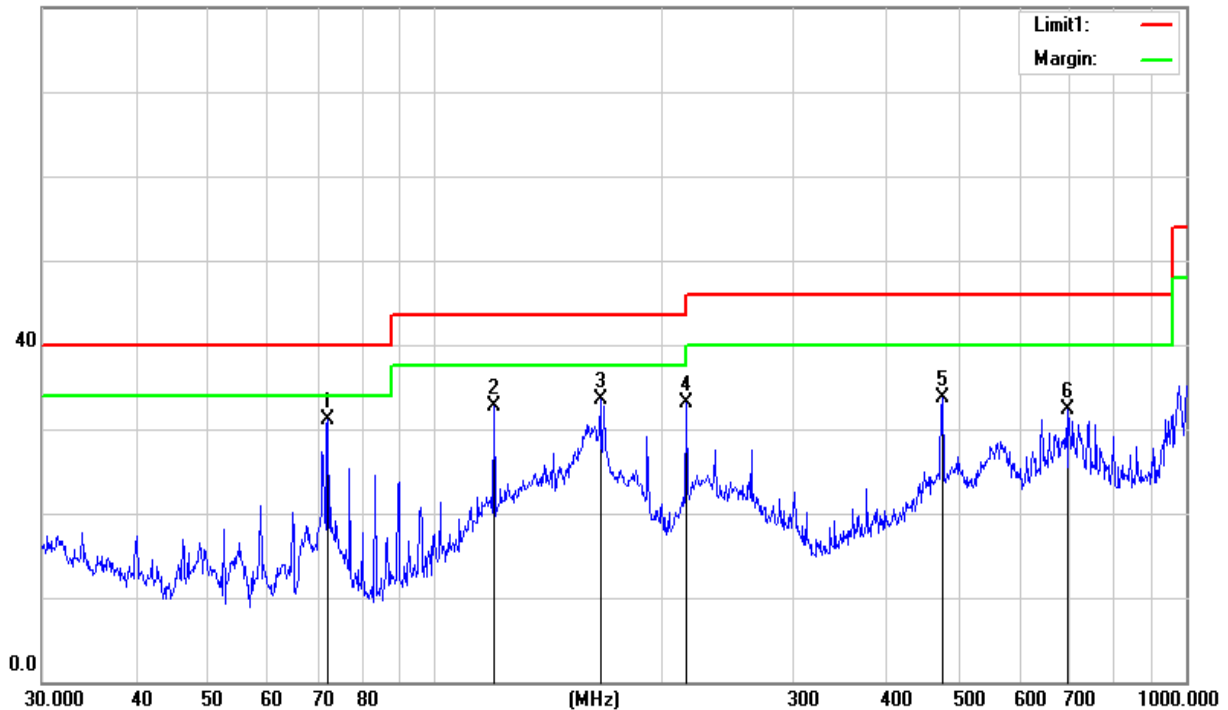



Above 1000 MHz

GFSK Low Channel

Frequency	Meter Reading	Factor	Emission Level	Limits	Margin	Detector	Comment
(MHz)	(dB μ V)	(dB)	(dB μ V/m)	(dB μ V/m)	(dB)	Type	
3265.27	50.13	-9.80	40.33	74.00	-33.67	PK	Vertical
3265.27	40.10	-9.80	30.30	54.00	-23.70	AV	Vertical
3265.25	50.12	-9.80	40.32	74.00	-33.68	PK	Horizontal
3265.25	40.13	-9.80	30.33	54.00	-23.67	AV	Horizontal
3334.86	52.80	-9.75	43.05	74.00	-30.95	PK	Vertical
3334.86	42.94	-9.75	33.19	54.00	-20.81	AV	Vertical
3334.86	52.89	-9.75	43.14	74.00	-30.86	PK	Horizontal
3334.86	42.84	-9.75	33.09	54.00	-20.91	AV	Horizontal
3349.90	52.63	-9.75	42.88	74.00	-31.12	PK	Vertical
3349.90	42.67	-9.75	32.92	54.00	-21.08	AV	Vertical
3349.96	52.65	-9.75	42.90	74.00	-31.10	PK	Horizontal
3349.96	42.68	-9.75	32.93	54.00	-21.07	AV	Horizontal
4000.22	53.02	-6.60	46.42	74.00	-27.58	PK	Vertical
4000.22	45.04	-6.60	38.44	54.00	-15.56	AV	Vertical
4000.21	52.03	-6.60	45.43	74.00	-28.57	PK	Horizontal
4000.21	44.97	-6.60	38.37	54.00	-15.63	AV	Horizontal
4803.93	60.39	-3.56	56.83	74.00	-17.17	PK	Vertical
4803.93	50.44	-3.56	46.88	54.00	-7.12	AV	Vertical
4804.94	60.41	-3.56	56.85	74.00	-17.15	PK	Horizontal
4804.94	50.40	-3.56	46.84	54.00	-7.16	AV	Horizontal
5360.22	47.31	-2.34	44.97	74.00	-29.03	PK	Vertical
5360.22	39.35	-2.34	37.01	54.00	-16.99	AV	Vertical
5360.20	47.38	-2.34	45.04	74.00	-28.96	PK	Horizontal
5360.20	39.31	-2.34	36.97	54.00	-17.03	AV	Horizontal
7206.32	52.86	3.40	56.26	74.00	-17.74	PK	Vertical
7206.32	44.81	3.40	48.21	54.00	-5.79	AV	Vertical
7206.32	52.81	3.40	56.21	74.00	-17.79	PK	Horizontal
7206.32	44.79	3.40	48.19	54.00	-5.81	AV	Horizontal
8124.44	45.28	4.80	50.08	74.00	-23.92	PK	Vertical
8124.44	35.25	4.80	40.05	54.00	-13.95	AV	Vertical
8124.39	45.28	4.80	50.08	74.00	-23.92	PK	Horizontal
8124.39	35.30	4.80	40.10	54.00	-13.90	AV	Horizontal
9105.12	46.10	5.00	51.10	74.00	-22.90	PK	Vertical



9105.12	36.10	5.00	41.10	54.00	-12.90	AV	Vertical
9105.45	46.10	5.00	51.10	74.00	-22.90	PK	Horizontal
9105.45	36.10	5.00	41.10	54.00	-12.90	AV	Horizontal
11036.36	42.10	10.20	52.30	74.00	-21.70	PK	Vertical
11036.36	32.03	10.20	42.23	54.00	-11.77	AV	Vertical
11036.60	42.07	10.20	52.27	74.00	-21.73	PK	Horizontal
11036.60	32.04	10.20	42.24	54.00	-11.76	AV	Horizontal
13299.78	41.91	12.20	54.11	74.00	-19.89	PK	Vertical
13299.78	31.92	12.20	44.12	54.00	-9.88	AV	Vertical
13299.87	41.94	12.20	54.14	74.00	-19.86	PK	Horizontal
13299.87	30.89	12.20	43.09	54.00	-10.91	AV	Horizontal
14480.24	41.82	13.40	55.22	74.00	-18.78	PK	Vertical
14480.24	30.85	13.40	44.25	54.00	-9.75	AV	Vertical
14480.24	41.81	13.40	55.21	74.00	-18.79	PK	Horizontal
14480.24	30.83	13.40	44.23	54.00	-9.77	AV	Horizontal
16000.31	41.93	12.40	54.33	74.00	-19.67	PK	Vertical
16000.31	31.97	12.40	44.37	54.00	-9.63	AV	Vertical
16000.19	41.96	12.40	54.36	74.00	-19.64	PK	Horizontal
16000.19	31.24	12.40	43.64	54.00	-10.36	AV	Horizontal
17998.31	32.10	23.10	55.20	74.00	-18.80	PK	Vertical
17998.31	22.08	23.10	45.18	54.00	-8.82	AV	Vertical
17998.17	32.11	23.10	55.21	74.00	-18.79	PK	Horizontal
17998.17	22.12	23.10	45.22	54.00	-8.78	AV	Horizontal



GFSK Mid Channel

Frequency	Meter Reading	Factor	Emission Level	Limits	Margin	Detector	Comment
(MHz)	(dB μ V)	(dB)	(dB μ V/m)	(dB μ V/m)	(dB)	Type	
3265.25	45.20	-9.80	35.40	74.00	-38.60	PK	Vertical
3265.25	35.08	-9.80	25.28	54.00	-28.72	AV	Vertical
3265.25	45.14	-9.80	35.34	74.00	-38.66	PK	Horizontal
3265.25	35.14	-9.80	25.34	54.00	-28.66	AV	Horizontal
3334.89	42.89	-9.75	33.14	74.00	-40.86	PK	Vertical
3334.89	33.90	-9.75	24.15	54.00	-29.85	AV	Vertical
3334.83	42.93	-9.75	33.18	74.00	-40.82	PK	Horizontal
3334.83	33.92	-9.75	24.17	54.00	-29.83	AV	Horizontal
3349.85	42.62	-9.75	32.87	74.00	-41.13	PK	Vertical
3349.85	33.67	-9.75	23.92	54.00	-30.08	AV	Vertical
3349.87	42.65	-9.75	32.90	74.00	-41.10	PK	Horizontal
3349.87	33.66	-9.75	23.91	54.00	-30.09	AV	Horizontal
4000.22	40.01	-6.60	33.41	74.00	-40.59	PK	Vertical
4000.22	30.00	-6.60	23.40	54.00	-30.60	AV	Vertical
4000.20	40.01	-6.60	33.41	74.00	-40.59	PK	Horizontal
4000.20	30.02	-6.60	23.42	54.00	-30.58	AV	Horizontal
4882.94	39.43	-3.56	35.87	74.00	-38.13	PK	Vertical
4882.94	29.45	-3.56	25.89	54.00	-28.11	AV	Vertical
4882.92	39.42	-3.56	35.86	74.00	-38.14	PK	Horizontal
4882.92	29.43	-3.56	25.87	54.00	-28.13	AV	Horizontal
5360.19	38.34	-2.34	36.00	74.00	-38.00	PK	Vertical
5360.19	28.36	-2.34	26.02	54.00	-27.98	AV	Vertical
5360.21	38.34	-2.34	36.00	74.00	-38.00	PK	Horizontal
5360.21	28.36	-2.34	26.02	54.00	-27.98	AV	Horizontal
7323.29	37.78	3.40	41.18	74.00	-32.82	PK	Vertical
7323.29	28.76	3.40	32.16	54.00	-21.84	AV	Vertical
7323.31	37.84	3.40	41.24	74.00	-32.76	PK	Horizontal
7323.31	27.81	3.40	31.21	54.00	-22.79	AV	Horizontal
8124.42	36.29	4.80	41.09	74.00	-32.91	PK	Vertical
8124.42	26.26	4.80	31.06	54.00	-22.94	AV	Vertical
8124.42	36.28	4.80	41.08	74.00	-32.92	PK	Horizontal
8124.42	26.28	4.80	31.08	54.00	-22.92	AV	Horizontal
9105.13	35.10	5.00	40.10	74.00	-33.90	PK	Vertical
9105.13	25.06	5.00	30.06	54.00	-23.94	AV	Vertical
9105.12	35.07	5.00	40.07	74.00	-33.93	PK	Horizontal
9105.12	25.04	5.00	30.04	54.00	-23.96	AV	Horizontal



11036.37	34.03	10.20	44.23	74.00	-29.77	PK	Vertical
11036.37	24.09	10.20	34.29	54.00	-19.71	AV	Vertical
11036.39	34.02	10.20	44.22	74.00	-29.78	PK	Horizontal
11036.39	24.06	10.20	34.26	54.00	-19.74	AV	Horizontal
13299.91	32.94	12.20	45.14	74.00	-28.86	PK	Vertical
13299.91	24.96	12.20	37.16	54.00	-16.84	AV	Vertical
13299.87	32.86	12.20	45.06	74.00	-28.94	PK	Horizontal
13299.87	24.91	12.20	37.11	54.00	-16.89	AV	Horizontal
14480.26	31.76	13.40	45.16	74.00	-28.84	PK	Vertical
14480.26	20.81	13.40	34.21	54.00	-19.79	AV	Vertical
14480.23	31.83	13.40	45.23	74.00	-28.77	PK	Horizontal
14480.23	20.83	13.40	34.23	54.00	-19.77	AV	Horizontal
16000.26	31.00	12.40	43.40	74.00	-30.60	PK	Vertical
16000.26	20.91	12.40	33.31	54.00	-20.69	AV	Vertical
16000.19	30.95	12.40	43.35	74.00	-30.65	PK	Horizontal
16000.19	20.92	12.40	33.32	54.00	-20.68	AV	Horizontal
17998.38	28.11	23.10	51.21	74.00	-22.79	PK	Vertical
17998.38	18.13	23.10	41.23	54.00	-12.77	AV	Vertical
17998.24	28.10	23.10	51.20	74.00	-22.80	PK	Horizontal
17998.24	18.13	23.10	41.23	54.00	-12.77	AV	Horizontal



GFSK High Channel

Frequency	Meter Reading	Factor	Emission Level	Limits	Margin	Detector	Comment
(MHz)	(dB μ V)	(dB)	(dB μ V/m)	(dB μ V/m)	(dB)	Type	
3265.10	45.02	-9.80	35.22	74.00	-38.78	PK	Vertical
3265.10	35.04	-9.80	25.24	54.00	-28.76	AV	Vertical
3265.09	44.98	-9.80	35.18	74.00	-38.82	PK	Horizontal
3265.09	34.93	-9.80	25.13	54.00	-28.87	AV	Horizontal
3334.67	42.70	-9.75	32.95	74.00	-41.05	PK	Vertical
3334.67	32.71	-9.75	22.96	54.00	-31.04	AV	Vertical
3334.67	42.72	-9.75	32.97	74.00	-41.03	PK	Horizontal
3334.67	32.80	-9.75	23.05	54.00	-30.95	AV	Horizontal
3349.68	42.50	-9.75	32.75	74.00	-41.25	PK	Vertical
3349.68	32.48	-9.75	22.73	54.00	-31.27	AV	Vertical
3349.75	42.56	-9.75	32.81	74.00	-41.19	PK	Horizontal
3349.75	32.48	-9.75	22.73	54.00	-31.27	AV	Horizontal
4000.09	39.85	-6.60	33.25	74.00	-40.75	PK	Vertical
4000.09	29.89	-6.60	23.29	54.00	-30.71	AV	Vertical
4000.00	39.91	-6.60	33.31	74.00	-40.69	PK	Horizontal
4000.00	29.87	-6.60	23.27	54.00	-30.73	AV	Horizontal
4960.83	39.29	-3.56	35.73	74.00	-38.27	PK	Vertical
4960.83	29.32	-3.56	25.76	54.00	-28.24	AV	Vertical
4960.81	39.28	-3.56	35.72	74.00	-38.28	PK	Horizontal
4960.81	29.33	-3.56	25.77	54.00	-28.23	AV	Horizontal
5360.06	38.23	-2.34	35.89	74.00	-38.11	PK	Vertical
5360.06	28.19	-2.34	25.85	54.00	-28.15	AV	Vertical
5360.07	38.25	-2.34	35.91	74.00	-38.09	PK	Horizontal
5360.07	28.24	-2.34	25.90	54.00	-28.10	AV	Horizontal
7440.14	37.63	3.40	41.03	74.00	-32.97	PK	Vertical
7440.14	27.59	3.40	30.99	54.00	-23.01	AV	Vertical
7440.14	37.64	3.40	41.04	74.00	-32.96	PK	Horizontal
7440.14	27.63	3.40	31.03	54.00	-22.97	AV	Horizontal
8124.27	36.17	4.80	40.97	74.00	-33.03	PK	Vertical
8124.27	26.14	4.80	30.94	54.00	-23.06	AV	Vertical
8124.35	36.10	4.80	40.90	74.00	-33.10	PK	Horizontal
8124.35	26.16	4.80	30.96	54.00	-23.04	AV	Horizontal
9105.01	34.89	5.00	39.89	74.00	-34.11	PK	Vertical
9105.01	24.90	5.00	29.90	54.00	-24.10	AV	Vertical
9104.96	35.01	5.00	40.01	74.00	-33.99	PK	Horizontal
9104.96	24.92	5.00	29.92	54.00	-24.08	AV	Horizontal



11036.18	33.92	10.20	44.12	74.00	-29.88	PK	Vertical
11036.18	23.96	10.20	34.16	54.00	-19.84	AV	Vertical
11036.21	33.92	10.20	44.12	74.00	-29.88	PK	Horizontal
11036.21	23.85	10.20	34.05	54.00	-19.95	AV	Horizontal
13299.72	32.70	12.20	44.90	74.00	-29.10	PK	Vertical
13299.72	22.74	12.20	34.94	54.00	-19.06	AV	Vertical
13299.74	32.73	12.20	44.93	74.00	-29.07	PK	Horizontal
13299.74	22.75	12.20	34.95	54.00	-19.05	AV	Horizontal
14480.04	31.66	13.40	45.06	74.00	-28.94	PK	Vertical
14480.04	21.66	13.40	35.06	54.00	-18.94	AV	Vertical
14480.01	31.67	13.40	45.07	74.00	-28.93	PK	Horizontal
14480.01	21.72	13.40	35.12	54.00	-18.88	AV	Horizontal
16000.14	30.86	12.40	43.26	74.00	-30.74	PK	Vertical
16000.14	20.72	12.40	33.12	54.00	-20.88	AV	Vertical
16000.06	30.77	12.40	43.17	74.00	-30.83	PK	Horizontal
16000.06	20.73	12.40	33.13	54.00	-20.87	AV	Horizontal
17998.21	27.98	23.10	51.08	74.00	-22.92	PK	Vertical
17998.21	17.97	23.10	41.07	54.00	-12.93	AV	Vertical
17998.11	28.03	23.10	51.13	74.00	-22.87	PK	Horizontal
17998.11	17.96	23.10	41.06	54.00	-12.94	AV	Horizontal

Note:

1) 30MHz~25GHz:(Scan with GFSK, $\pi/4$ -DQPSK,8DPSK, the worst case is GFSK Mode)

2) Factor = Antenna Factor + Cable Loss – Pre-amplifier.

Emission Level = Meter Reading + Factor

Margin = Limit - Emission Level

3 Above did not show the frequency of the emission peaks form is at least 20 decibel limits, transmitting frequency noise mainly comes from the environment.



Band edge

Frequency (MHz)	Meter Reading (dBμV)	Factor (dB)	Emission Level (dBμV/m)	Limits (dBμV/m)	Margin (dB)	Detector Type	Comment
GFSK							
2390.0	69.25	-12.99	56.26	74	-17.74	PK	Vertical
2390.0	54.96	-12.99	41.97	54	-12.03	AV	Vertical
2390.0	69.90	-12.99	56.91	74	-17.09	PK	Horizontal
2390.0	53.84	-12.99	40.85	54	-13.15	AV	Horizontal
2483.6	70.85	-12.78	58.07	74	-15.93	PK	Vertical
2483.6	53.86	-12.78	41.08	54	-12.92	AV	Vertical
2483.6	71.07	-12.78	58.29	74	-15.71	PK	Horizontal
2483.6	54.05	-12.78	41.27	54	-12.73	AV	Horizontal
π/4-DQPSK							
2390.0	67.23	-12.99	54.24	74	-19.76	PK	Vertical
2390.0	53.21	-12.99	40.22	54	-13.78	AV	Vertical
2390.0	67.82	-12.99	54.83	74	-19.17	PK	Horizontal
2390.0	53.81	-12.99	40.82	54	-13.18	AV	Horizontal
2483.6	67.14	-12.78	54.36	74	-19.64	PK	Vertical
2483.6	52.97	-12.78	40.19	54	-13.81	AV	Vertical
2483.6	66.97	-12.78	54.19	74	-19.81	PK	Horizontal
2483.6	53.32	-12.78	40.54	54	-13.46	AV	Horizontal
8DPSK							
2390.0	67.24	-12.99	54.25	74	-19.75	PK	Vertical
2390.0	53.18	-12.99	40.19	54	-13.81	AV	Vertical
2390.0	67.85	-12.99	54.86	74	-19.14	PK	Horizontal
2390.0	53.80	-12.99	40.81	54	-13.19	AV	Horizontal
2483.6	67.20	-12.78	54.42	74	-19.58	PK	Vertical
2483.6	53.92	-12.78	41.14	54	-12.86	AV	Vertical
2483.6	66.96	-12.78	54.18	74	-19.82	PK	Horizontal
2483.6	53.27	-12.78	40.49	54	-13.51	AV	Horizontal

Low measurement frequencies is range from 2310 to 2400 MHz, high measurement frequencies is range from 2483.5 to 2500 MHz.

Only show the worst point data of the emissions in the frequency 2310-2400 MHz and 2483.5-2500 MHz.



Hopping(Band edge)

Frequency (MHz)	Meter Reading (dB μ V)	Factor (dB)	Emission Level (dB μ V/m)	Limits (dB μ V/m)	Margin (dB)	Detector Type	Comment
GFSK							
2390.0	70.86	-12.99	57.87	74	-16.13	PK	Vertical
2390.0	56.89	-12.99	43.90	54	-10.10	AV	Vertical
2390.0	70.10	-12.99	57.11	74	-16.89	PK	Horizontal
2390.0	56.82	-12.99	43.83	54	-10.17	AV	Horizontal
2483.5	70.87	-12.78	58.09	74	-15.91	PK	Vertical
2483.5	55.97	-12.78	43.19	54	-10.81	AV	Vertical
2483.5	70.89	-12.78	58.11	74	-15.89	PK	Horizontal
2483.5	56.81	-12.78	44.03	54	-9.97	AV	Horizontal
π /4-DQPSK							
2390.0	67.77	-12.99	54.78	74	-19.22	PK	Vertical
2390.0	55.95	-12.99	42.96	54	-11.04	AV	Vertical
2390.0	67.76	-12.99	54.77	74	-19.23	PK	Horizontal
2390.0	53.76	-12.99	40.77	54	-13.23	AV	Horizontal
2483.5	67.80	-12.78	55.02	74	-18.98	PK	Vertical
2483.5	53.92	-12.78	41.14	54	-12.86	AV	Vertical
2483.5	67.83	-12.78	55.05	74	-18.95	PK	Horizontal
2483.5	54.88	-12.78	42.10	54	-11.90	AV	Horizontal
8DPSK							
2390.0	67.81	-12.99	54.82	74	-19.18	PK	Vertical
2390.0	54.88	-12.99	41.89	54	-12.11	AV	Vertical
2390.0	67.77	-12.99	54.78	74	-19.22	PK	Horizontal
2390.0	54.90	-12.99	41.91	54	-12.09	AV	Horizontal
2483.5	67.84	-12.78	55.06	74	-18.94	PK	Vertical
2483.5	54.98	-12.78	42.20	54	-11.80	AV	Vertical
2483.5	67.80	-12.78	55.02	74	-18.98	PK	Horizontal
2483.5	54.88	-12.78	42.10	54	-11.90	AV	Horizontal

Low measurement frequencies is range from 2310 to 2400 MHz, high measurement frequencies is range from 2483.5 to 2500 MHz.

Only show the worst point data of the emissions in the frequency 2310-2400 MHz and 2483.5-2500 MHz.

4. CONDUCTED SPURIOUS EMISSIONS

4.1 REQUIREMENT

According to FCC section 15.247(d), in any 100kHz bandwidth outside the frequency band in which the spread spectrum or digitally modulated intentional radiator is operating, the radio frequency power that is produced by the intentional radiator shall be at least 20dB below that in the 100kHz bandwidth within the band that contains the highest level of the desired power, based on either an RF conducted or a radiated measurement.

4.2 TEST PROCEDURE

Spectrum Parameter	Setting
Detector	Peak
Start/Stop Frequency	30 MHz to 10th carrier harmonic
RB / VB (emission in restricted band)	100 KHz/300 KHz
Trace-Mode:	Max hold

For Band edge

Spectrum Parameter	Setting
Detector	Peak
Start/Stop Frequency	Lower Band Edge: 2310 – 2404 MHz Upper Band Edge: 2478 – 2500 MHz
RB / VB (emission in restricted band)	100 KHz/300 KHz
Trace-Mode:	Max hold

Remark : Hopping on and Hopping off mode all have been tested, only worst case hopping off is reported.

4.3 TEST SETUP

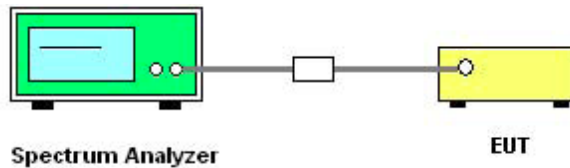

The EUT which is powered by the Battery, is coupled to the Spectrum Analyzer; the RF load attached to the EUT antenna terminal is 50Ohm; the path loss as the factor is calibrated to correct the reading. Make the measurement with the spectrum analyzer's resolution bandwidth(RBW) = 100 kHz. In order to make an accurate measurement, set the span greater than RBW.

4.4 EUT OPERATION CONDITIONS

The EUT tested system was configured as the statements of 2.3 Unless otherwise a special operating condition is specified in the follows during the testing.



4.5 TEST RESULTS

Temperature :	25 °C	Relative Humidity :	50%
Pressure :	1012 hPa	Test Voltage :	DC 3.7V
Test Mode :	GFSK(1Mbps)-00/39/78 CH		

0 CH

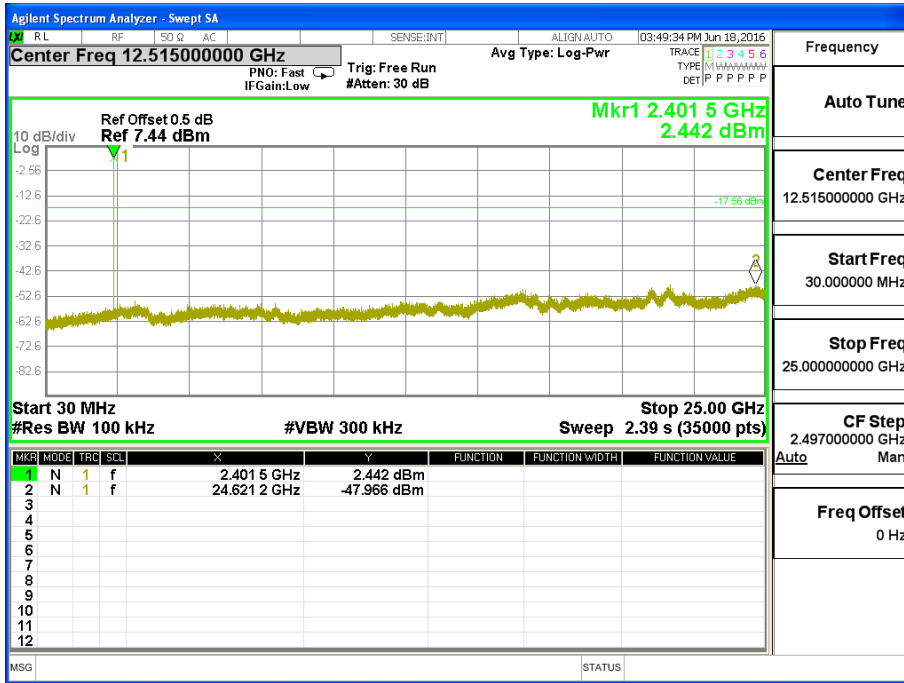

39 CH

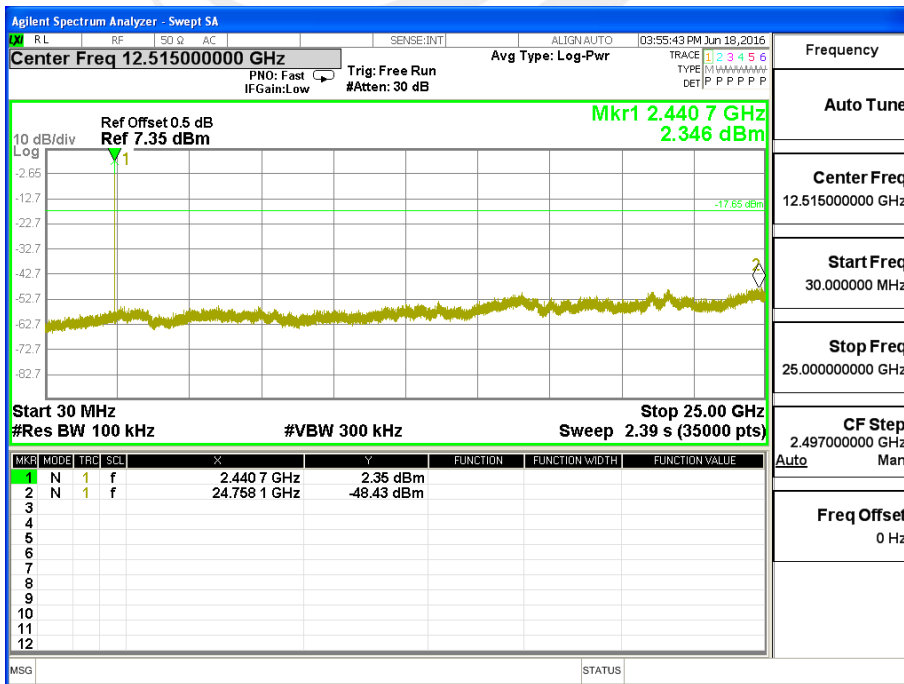



78 CH

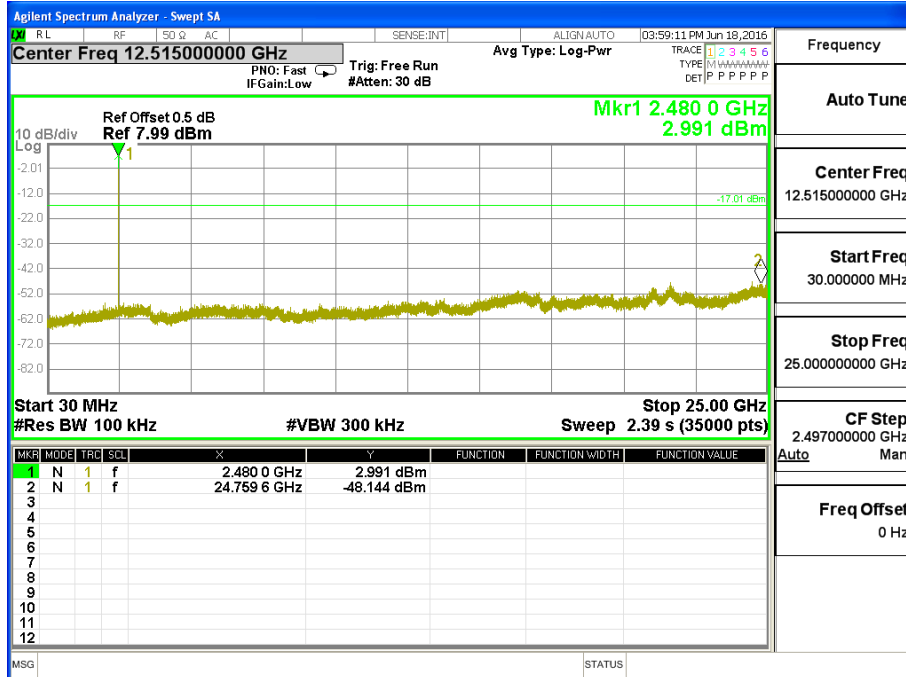



For Band edge

0 CH

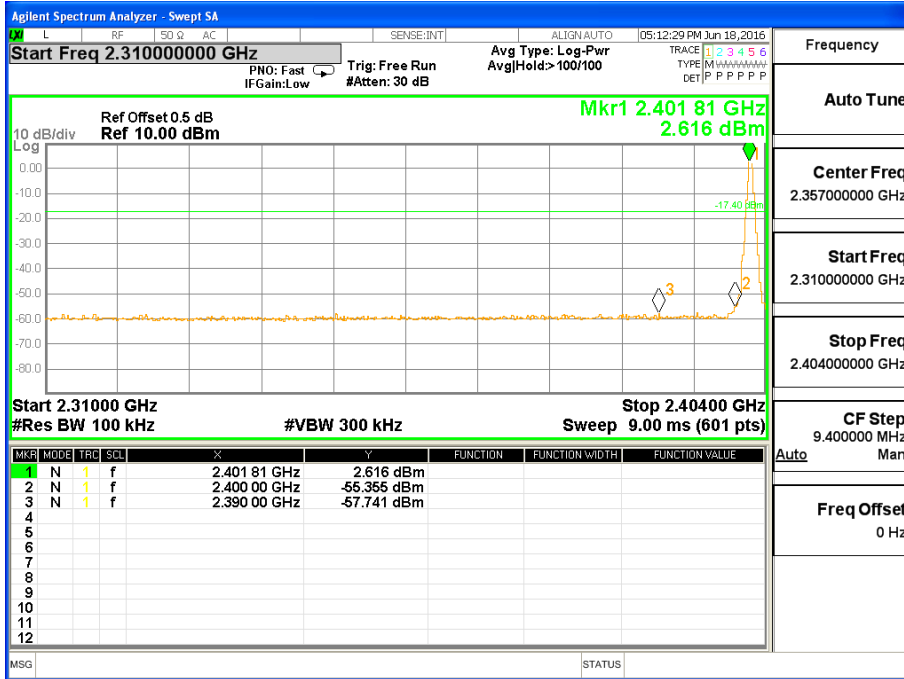

78 CH

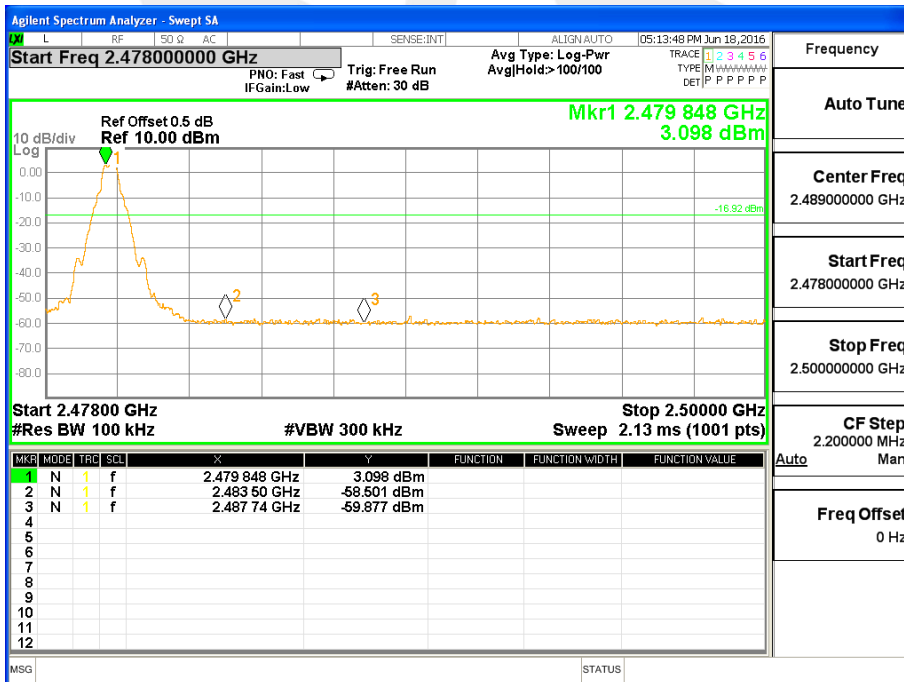



For Hopping Band edge

0 CH

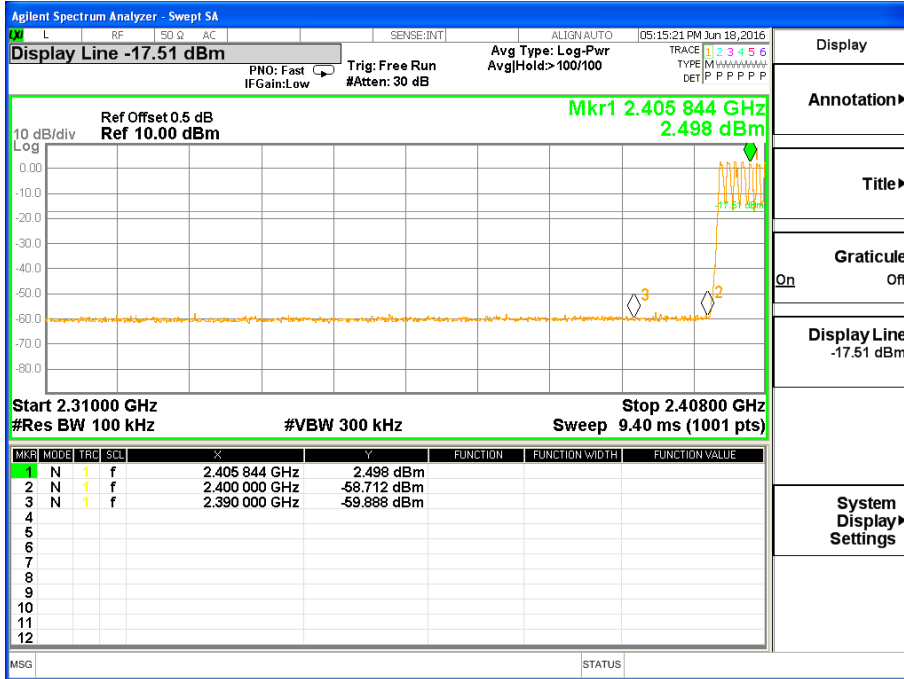

78 CH

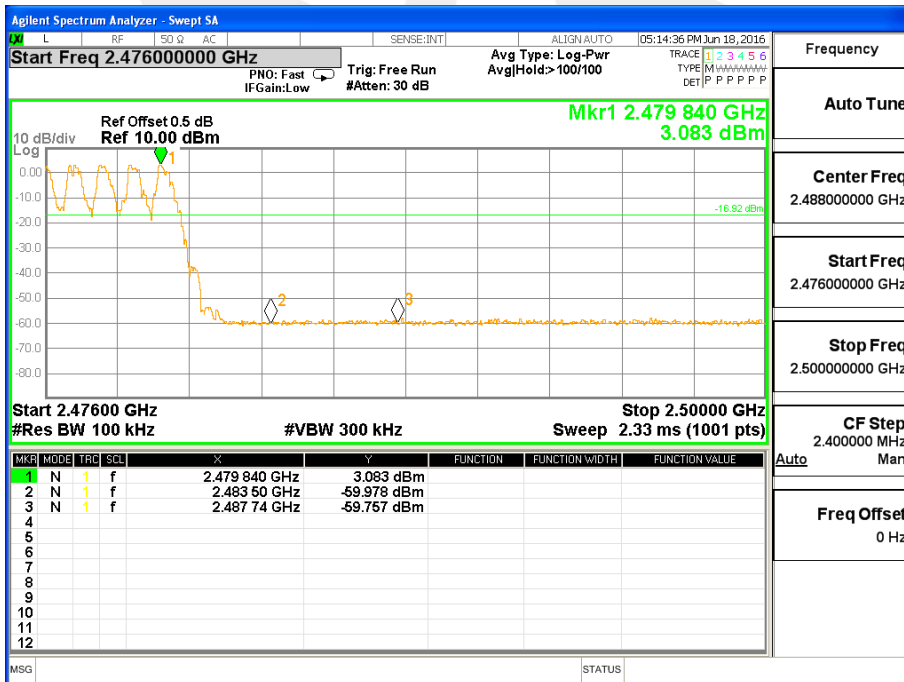



Temperature :	25 °C	Relative Humidity :	50%
Pressure :	1012 hPa	Test Voltage :	DC 3.7V
Test Mode :	π/4-DQPSK(2Mbps) -00/39/78 CH		

0 CH

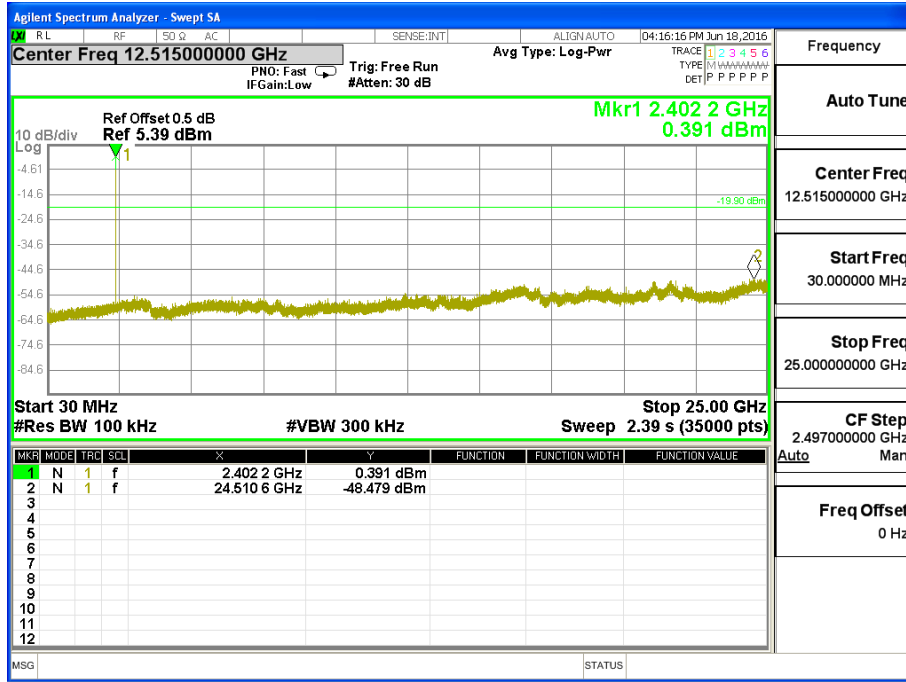

39 CH

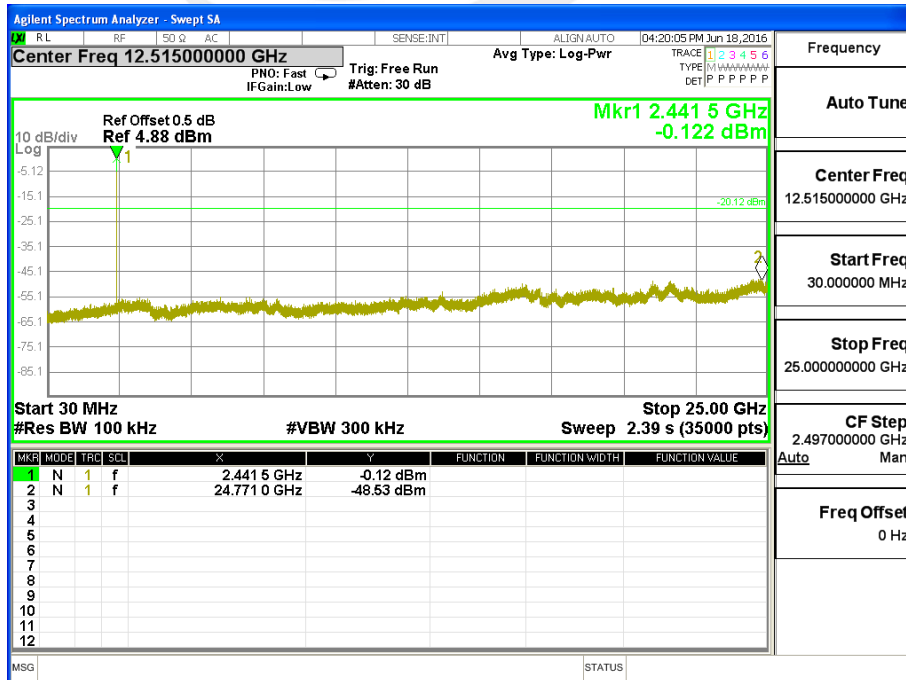



78 CH

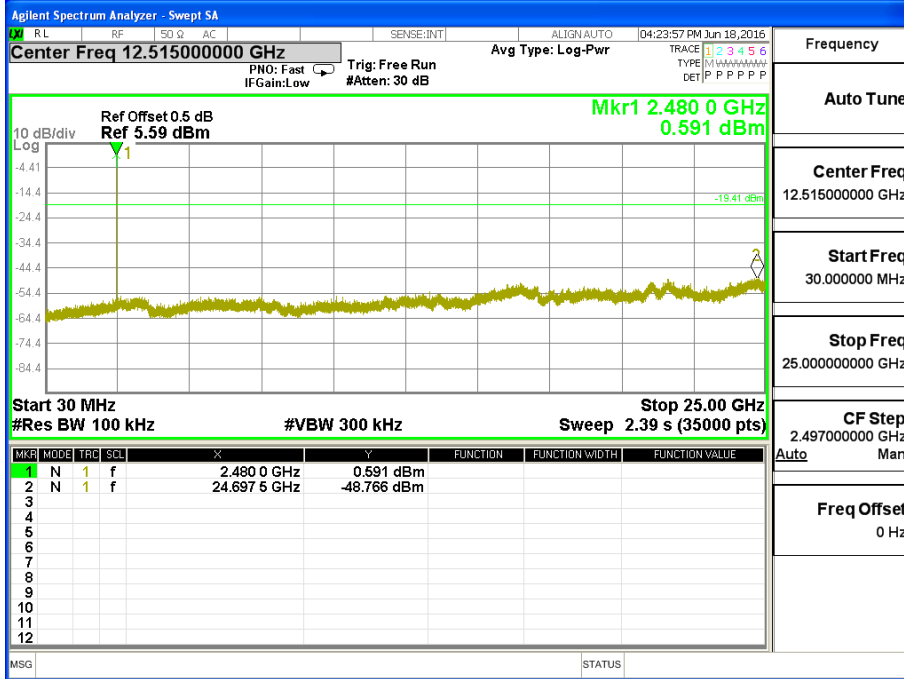



For Band edge

00 CH

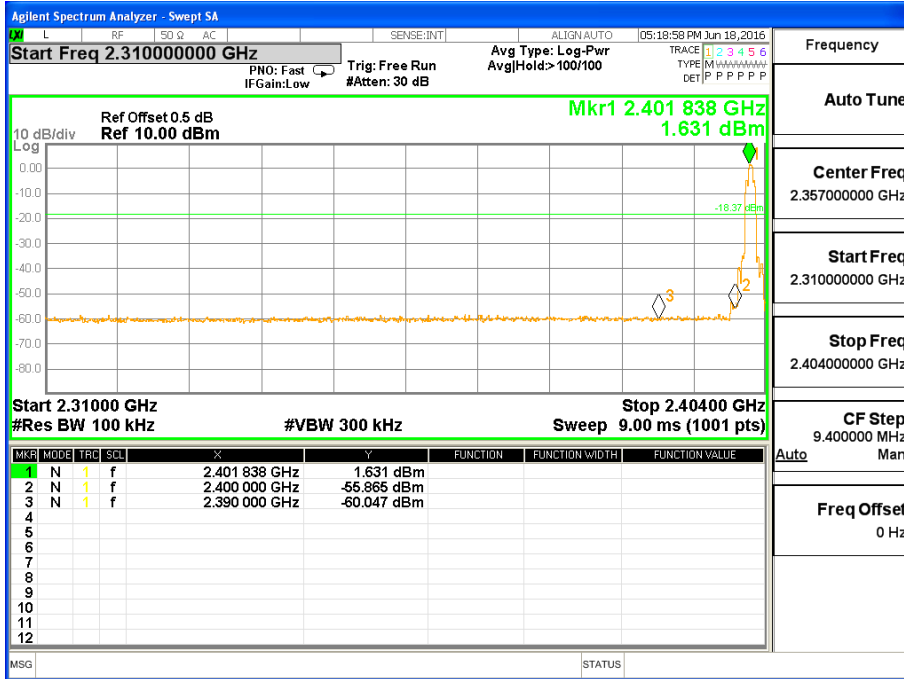

78 CH

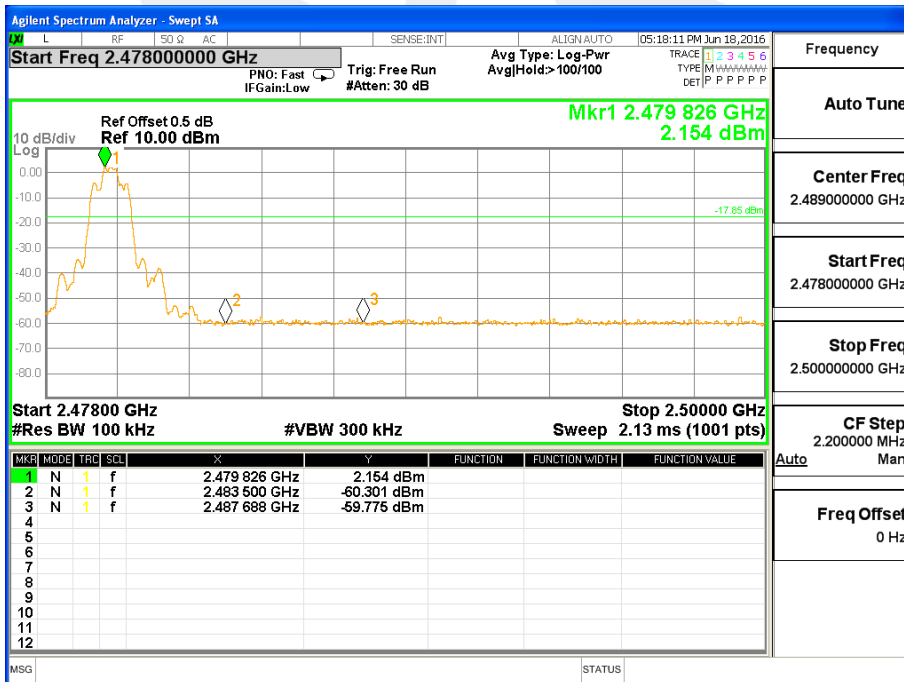



For Hopping Band edge

00 CH

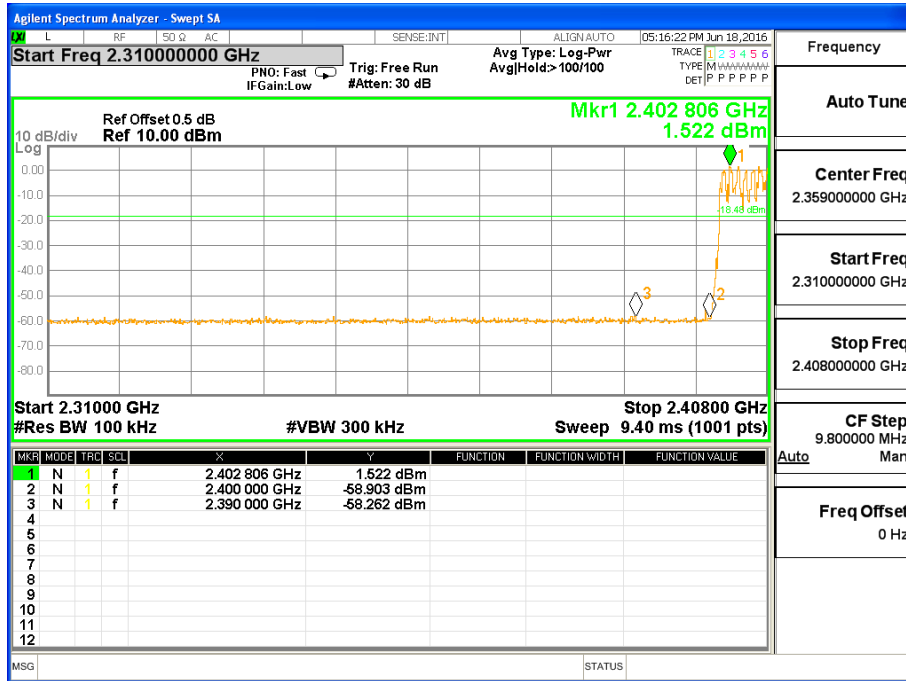

78 CH

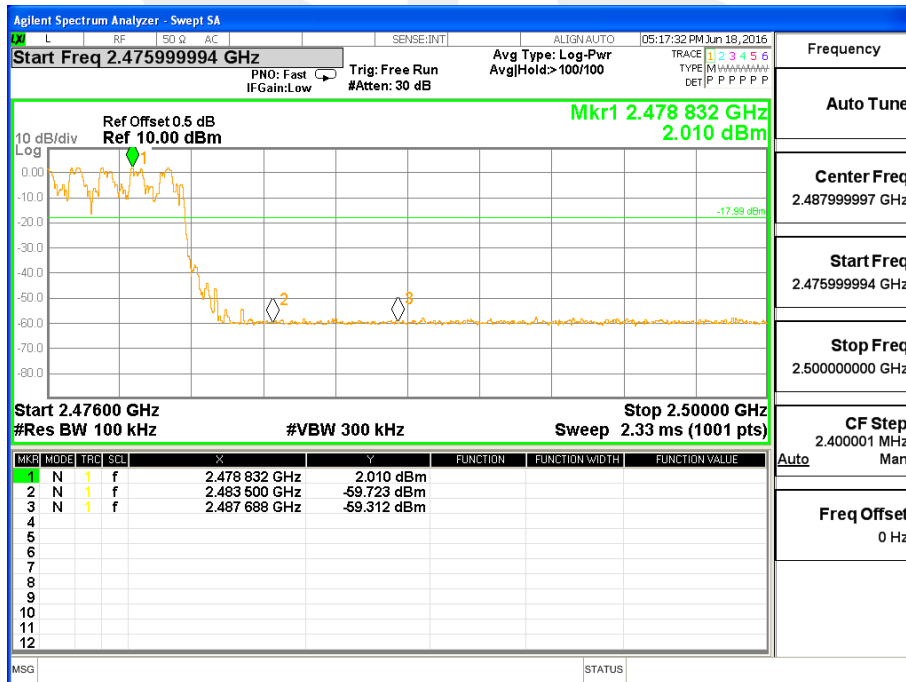



Temperature :	25 °C	Relative Humidity :	50%
Pressure :	1012 hPa	Test Voltage :	DC 3.7V
Test Mode :	8-DPSK(3Mbps) -00/39/78 CH		

00 CH

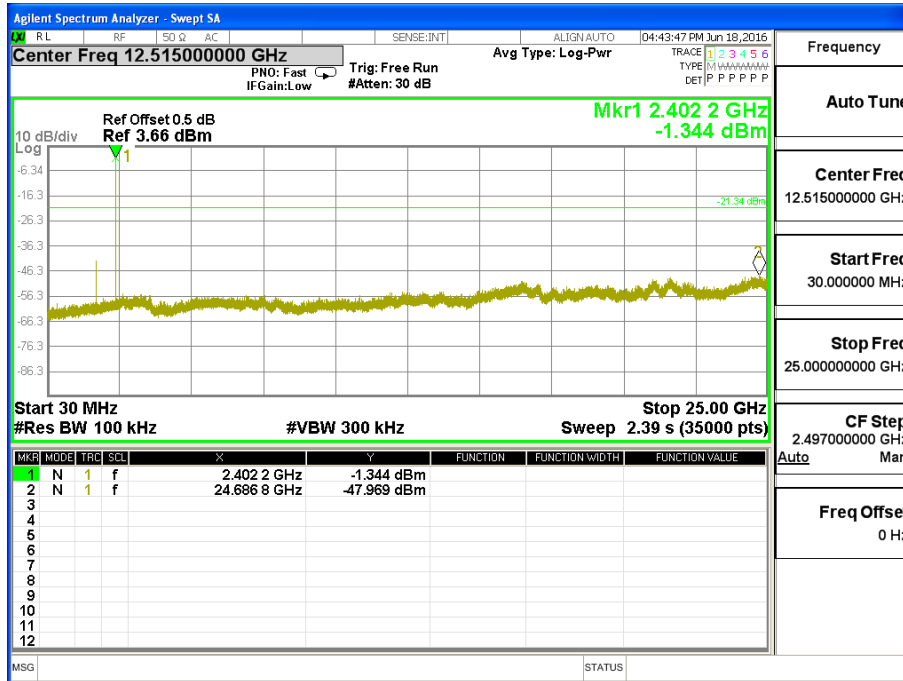

39 CH

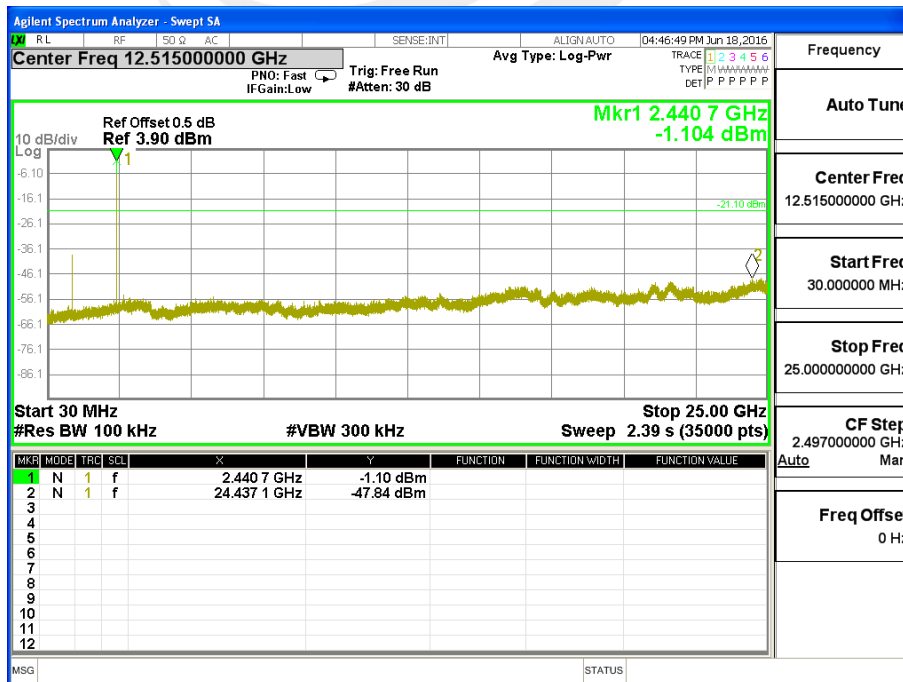



78 CH

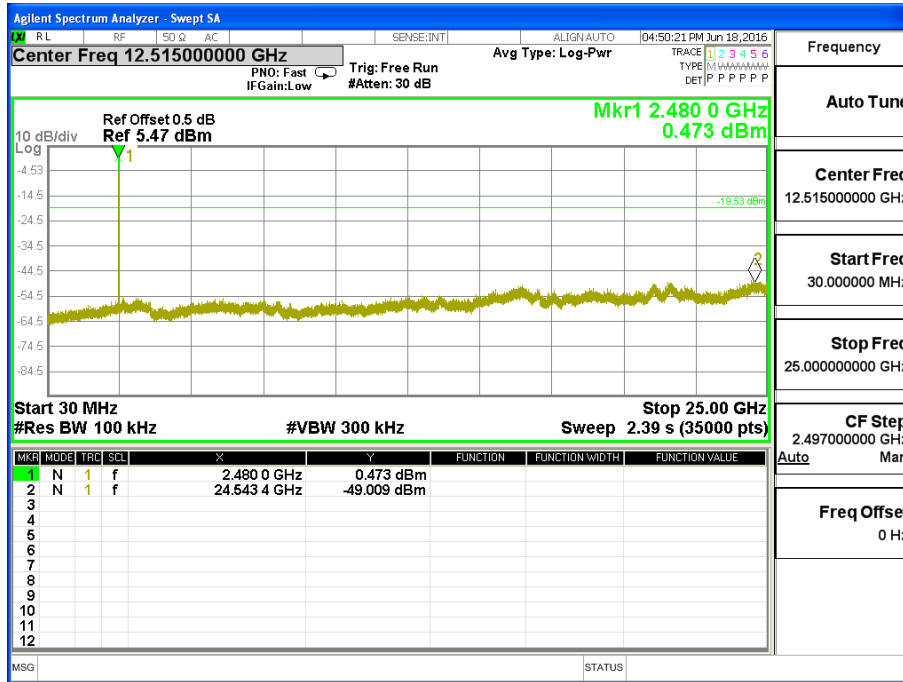



For Band edge

00 CH

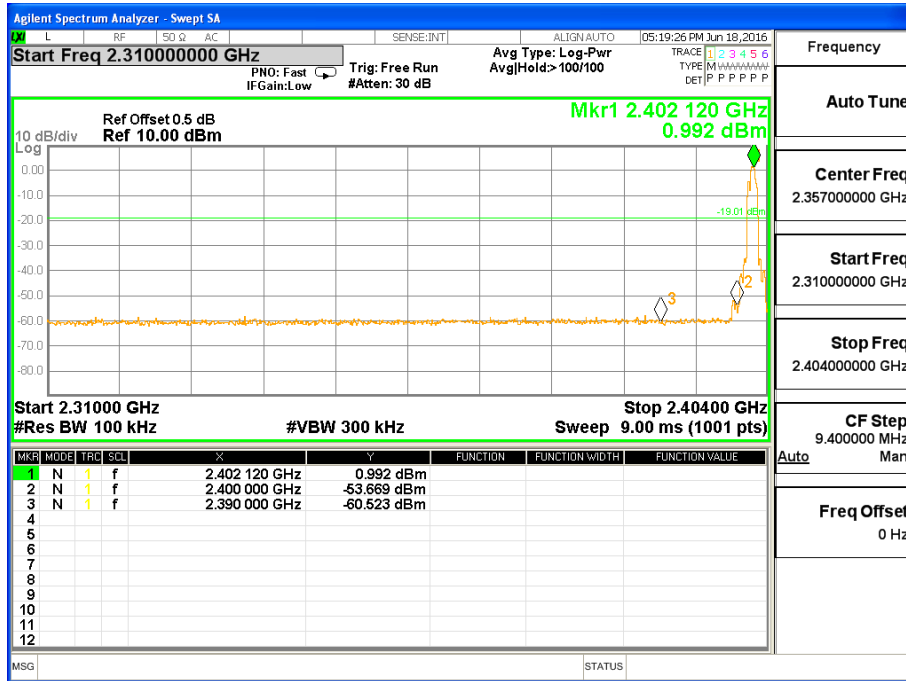

78 CH

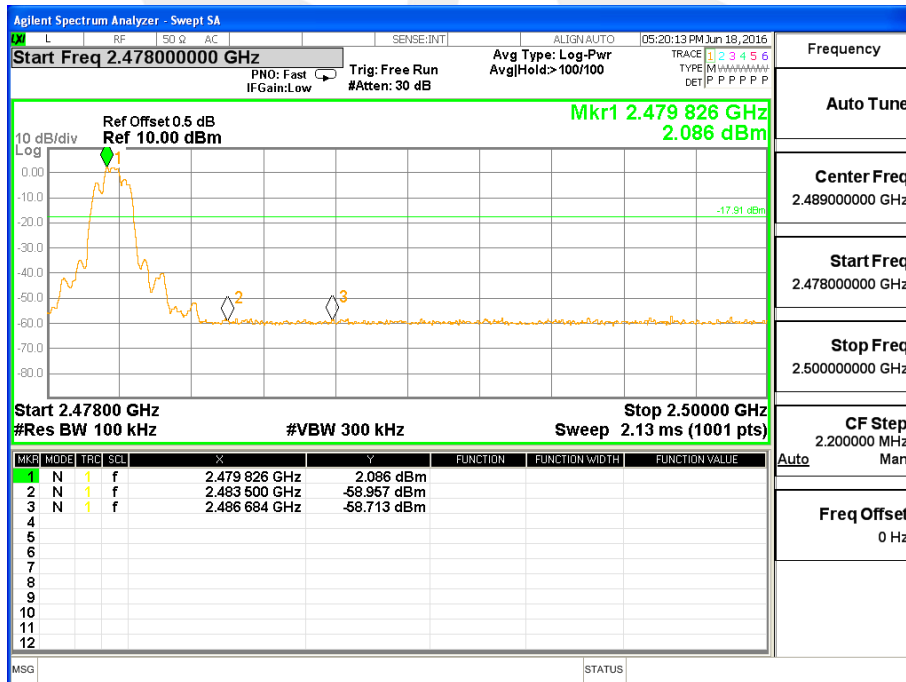



For Hopping Band edge

00 CH

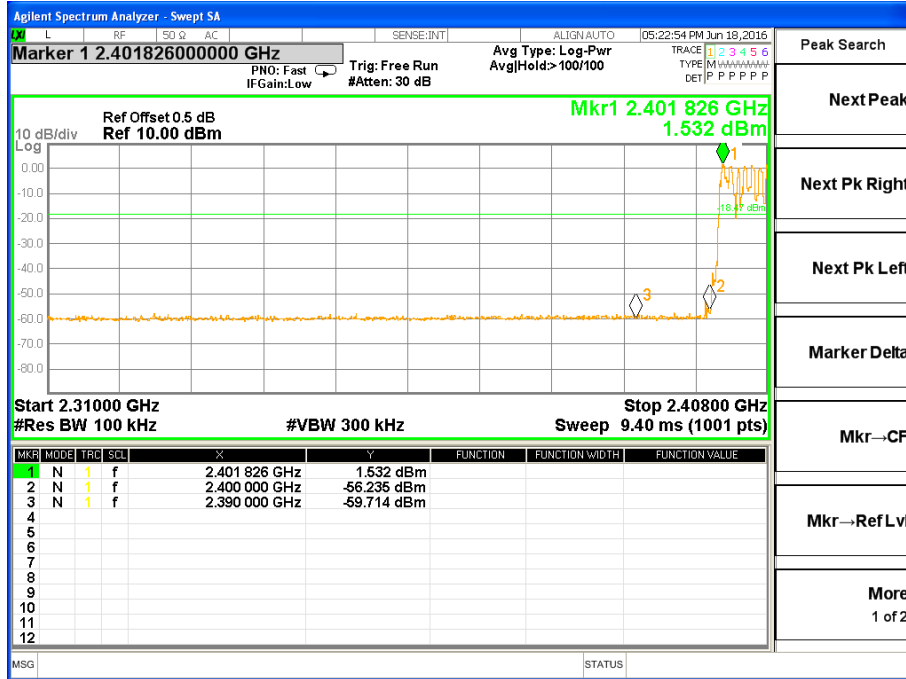

78 CH

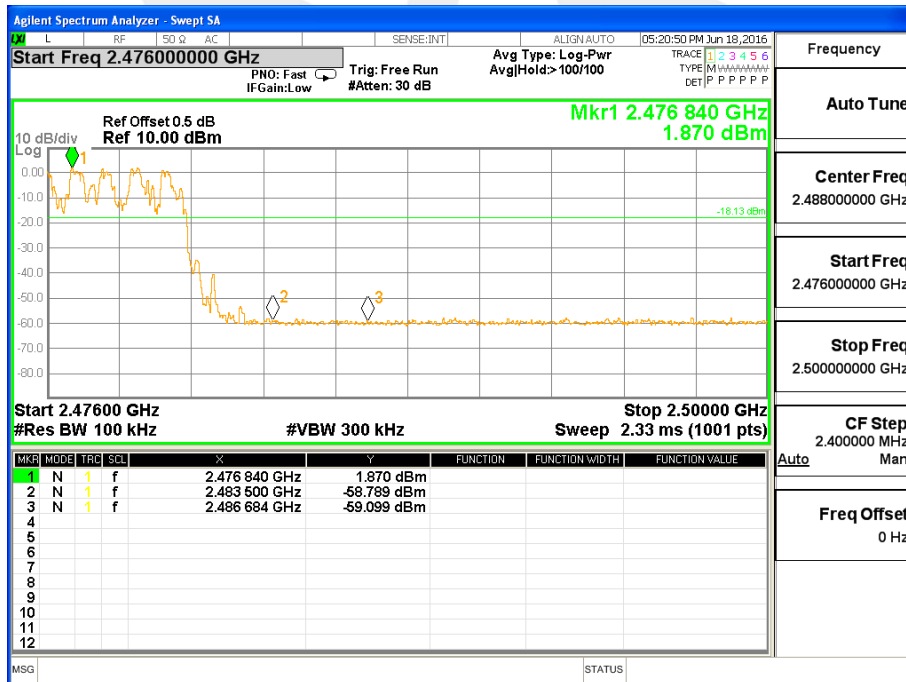



5. NUMBER OF HOPPING CHANNEL

5.1 APPLIED PROCEDURES / LIMIT

FCC Part15 (15.247) , Subpart C				
Section	Test Item	Limit	FrequencyRange (MHz)	Result
15.247 (a)(1)(iii)	Number of Hopping Channel	≥15	2400-2483.5	PASS

Spectrum Parameters	Setting
Attenuation	Auto
Span Frequency	> Operating Frequency Range
RB	100 KHz
VB	100 KHz
Detector	Peak
Trace	Max Hold
Sweep Time	Auto

5.2 TEST PROCEDURE

- a. The EUT was directly connected to the spectrum analyzer and antenna output port as show in the block diagram below,
- b. Spectrum Setting : RBW= 100K, VBW=100K, Sweep time = Auto.

5.3 TEST SETUP



5.4 EUT OPERATION CONDITIONS

The EUT tested system was configured as the statements of 2.4 Unless otherwise a special operating condition is specified in the follows during the testing.



5.5 TEST RESULTS

Temperature :	25 °C	Relative Humidity :	60%
Pressure :	1015 hPa	Test Voltage :	DC 3.7V
Test Mode :	Hopping Mode		

Number of Hopping Channel

79

Hopping channel

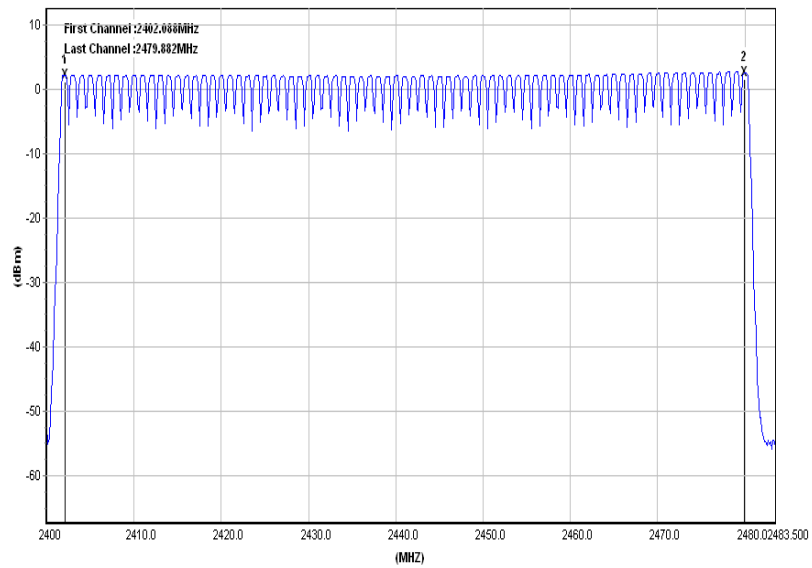



6. AVERAGE TIME OF OCCUPANCY

6.1 APPLIED PROCEDURES / LIMIT

FCC Part15 (15.247) , Subpart C				
Section	Test Item	Limit	FrequencyRange (MHz)	Result
15.247 (a)(1)(iii)	Average Time of Occupancy	0.4sec	2400-2483.5	PASS

6.2 TEST PROCEDURE

- a. The transmitter output (antenna port) was connected to the spectrum analyzer
- b. Set RBW =1MHz/VBW =3MHz.
- c. Use a video trigger with the trigger level set to enable triggering only on full pulses.
- d. Sweep Time is more than once pulse time.
Set the center frequency on any frequency would be measure and set the frequency span to
- e. zero span.
- f. Measure the maximum time duration of one single pulse.
- g. Set the EUT for DH5, DH3 and DH1 packet transmitting.
- h. Measure the maximum time duration of one single pulse.
- i. DH5 Packet permit maximum $1600 / 79 / 6 = 3.37$ hops per second in each channel (5 time slots RX, 1 time slot TX). Sothe dwell time is the time duration of the pulse times $3.37 \times 31.6 = 106.6$ within 31.6 seconds.
- j. DH3 Packet permit maximum $1600 / 79 / 4 = 5.06$ hops per second in each channel (3 time slots RX, 1 time slot TX). Sothe dwell time is the time duration of the pulse times $5.06 \times 31.6 = 160$ within 31.6 seconds.
- k. DH1 Packet permit maximum $1600 / 79 / 2 = 10.12$ hops per second in each channel (1 time slot RX, 1 time slot TX). So the dwell time is the time duration of the pulse times $10.12 \times 31.6 = 320$ within 31.6 seconds.

6.3 TEST SETUP

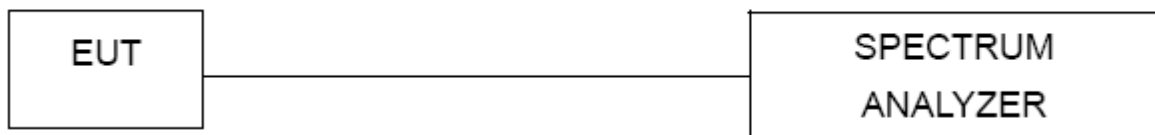

6.4 EUT OPERATION CONDITIONS

The EUT tested system was configured as the statements of 2.4 Unless otherwise a special operating condition is specified in the follows during the testing.



6.5 TEST RESULTS

Temperature :	25 °C	Relative Humidity :	50%
Pressure :	1012 hPa	Test Voltage :	DC 3.7V
Test Mode :	GFSK(1Mbps)-DH1/DH3/DH5		

Data Packet	Frequency	Pulse Duration (ms)	Dwell Time (s)	Limits(s)
DH1	2441 MHz	0.370	0.118	0.4
DH3	2441 MHz	1.640	0.262	0.4
DH5	2441 MHz	2.880	0.307	0.4





CH39-DH1

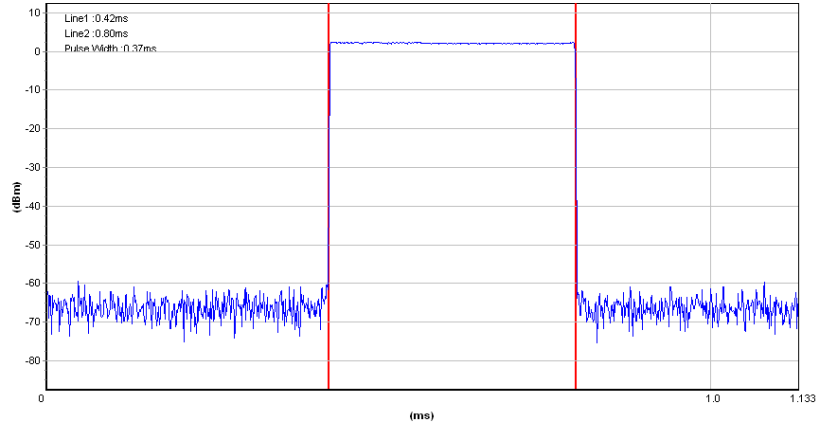

CH39-DH3

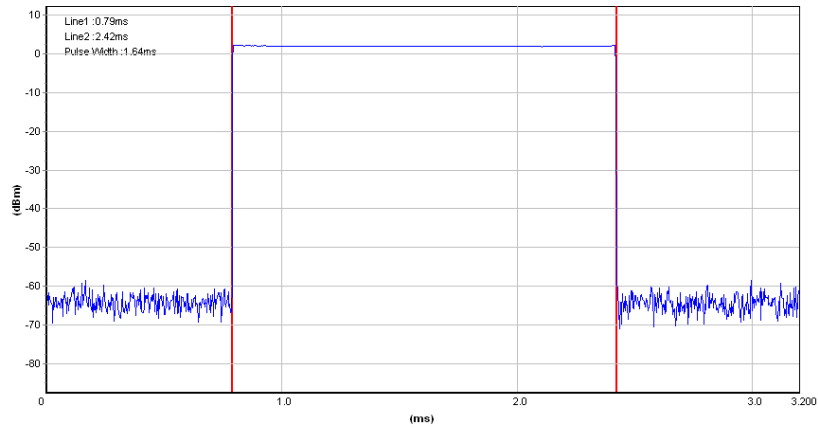

CH39-DH5

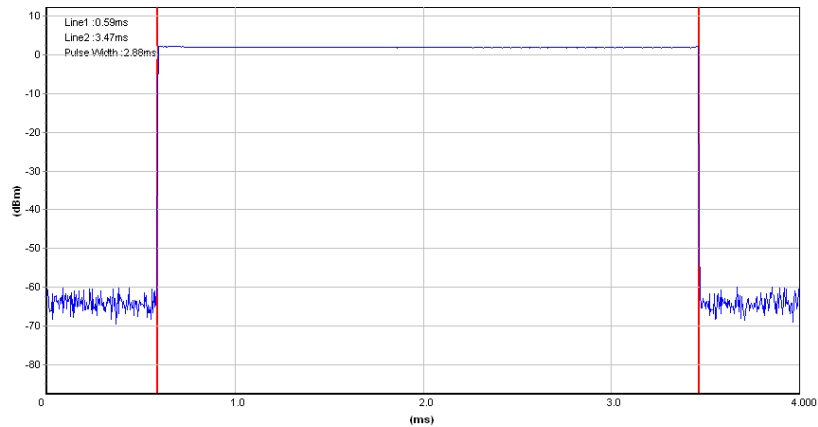



Temperature :	25 °C	Relative Humidity :	50%
Pressure :	1012 hPa	Test Voltage :	DC 3.7V
Test Mode :	$\pi/4$ -DQPSK(2Mbps) –2DH1/2DH3/2DH5		

Data Packet	Frequency	Pulse Duration (ms)	Dwell Time (s)	Limits(s)
2DH1	2441 MHz	0.380	0.122	0.4
2DH3	2441 MHz	1.640	0.262	0.4
2DH5	2441 MHz	2.890	0.308	0.4





CH39-2DH1

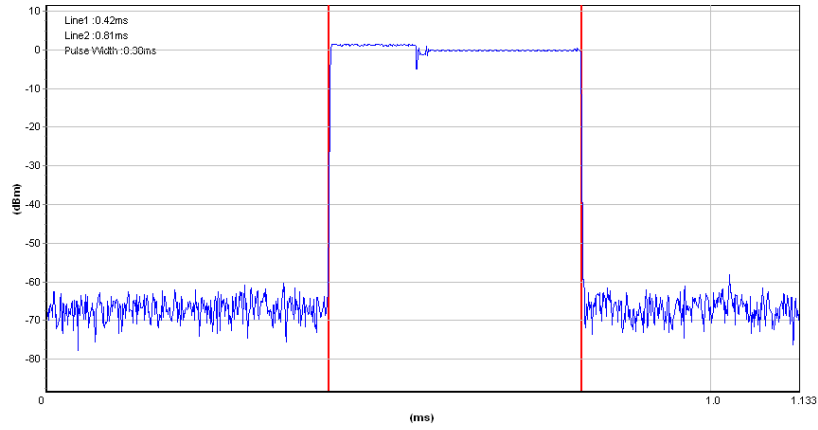

CH39-2DH3

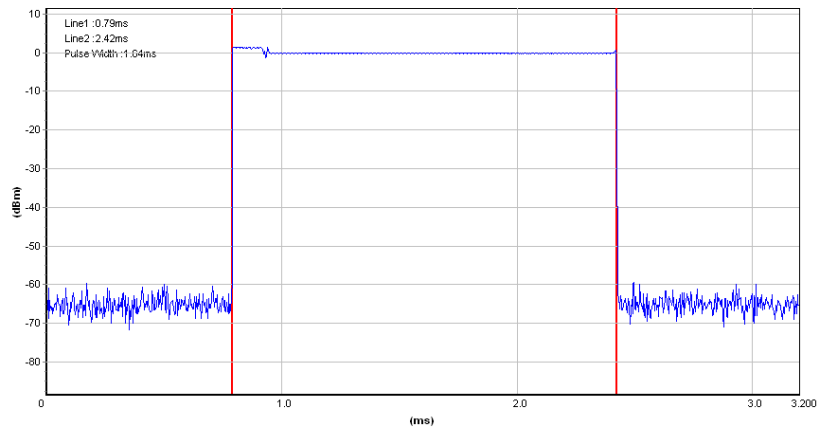

CH39-2DH5

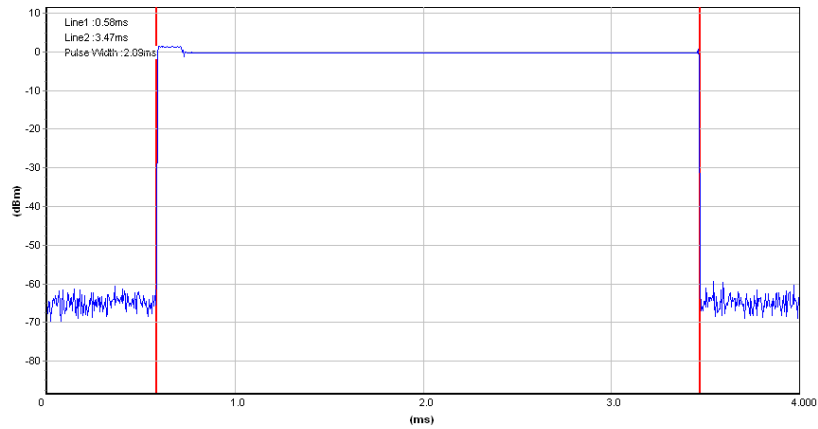



Temperature :	25 °C	Relative Humidity :	50%
Pressure :	1012 hPa	Test Voltage :	DC 3.7V
Test Mode :	8DPSK(3Mbps) –3DH1/3DH3/3DH5		

Data Packet	Frequency	Pulse Duration (ms)	Dwell Time (s)	Limits(s)
3DH1	2441 MHz	0.380	0.122	0.4
3DH3	2441 MHz	1.640	0.262	0.4
3DH5	2441 MHz	2.890	0.308	0.4





CH39-3DH1

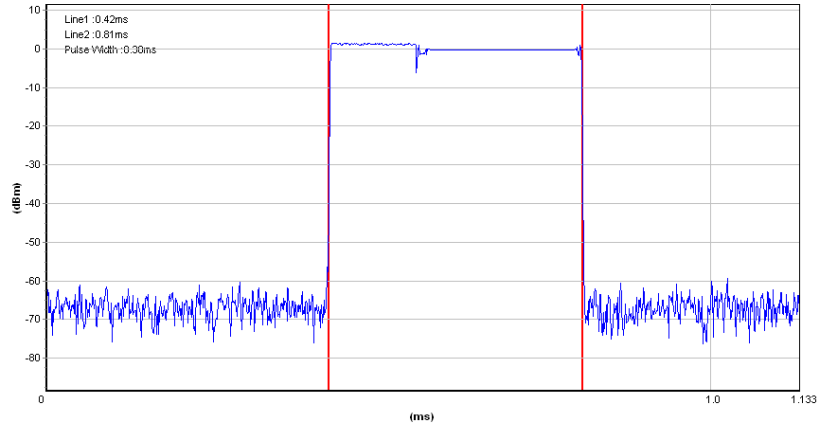

CH39-3DH3

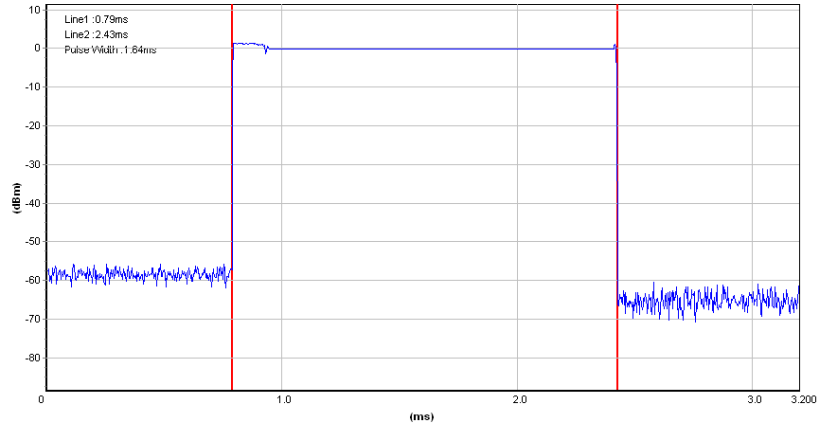

CH39-3DH5

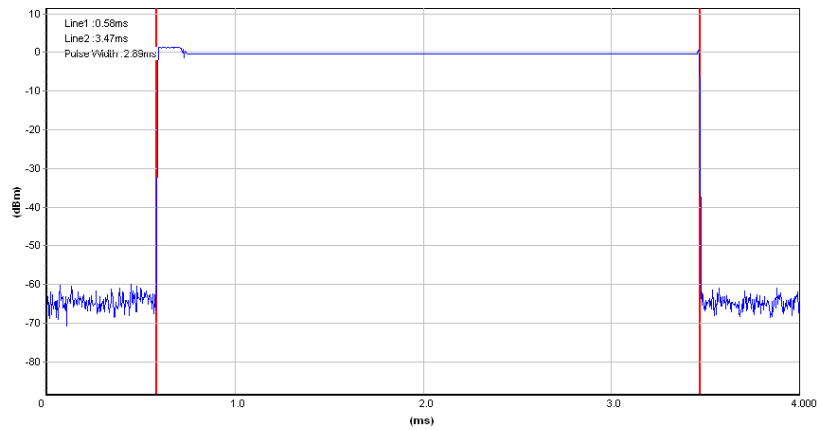

7. HOPPING CHANNEL SEPARATION MEASUREMENT

7.1 APPLIED PROCEDURES / LIMIT

Frequency hopping systems operating in the 2400-2483.5 MHz band may have hopping channel carrier frequencies that are separated by 20 dB bandwidth of the hopping channel, whichever is greater.

Spectrum Parameter	Setting
Attenuation	Auto
Span Frequency	> Measurement Bandwidth or Channel Separation
RB	30 kHz (20dB Bandwidth) / 30 kHz (Channel Separation)
VB	100 kHz (20dB Bandwidth) / 100 kHz (Channel Separation)
Detector	Peak
Trace	Max Hold
Sweep Time	Auto

7.2 TEST PROCEDURE

- The transmitter output (antenna port) was connected to the spectrum analyser in peak hold mode.
- The resolution bandwidth of 30 kHz and the video bandwidth of 100 kHz were utilised for 20 dB bandwidth measurement.
- The resolution bandwidth of 30 kHz and the video bandwidth of 100 kHz were utilised for channel separation measurement.

7.3 TEST SETUP

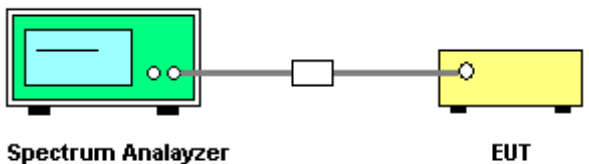

7.4 EUT OPERATION CONDITIONS

The EUT was programmed to be in continuously transmitting mode.



7.5 TEST RESULTS

Temperature :	25 °C	Relative Humidity :	50%
Pressure :	1012 hPa	Test Voltage :	DC 3.7V
Test Mode :	CH00 / CH39 /CH78 (GFSK(1Mbps) Mode)		

Frequency	Ch. Separation (MHz)	Limit	Result
2402 MHz	1.000	0.824	Complies
2441 MHz	1.000	0.827	Complies
2480 MHz	1.000	0.827	Complies

For GFSK: Ch. Separation Limits: >20dB bandwidth

CH00 -1Mbps

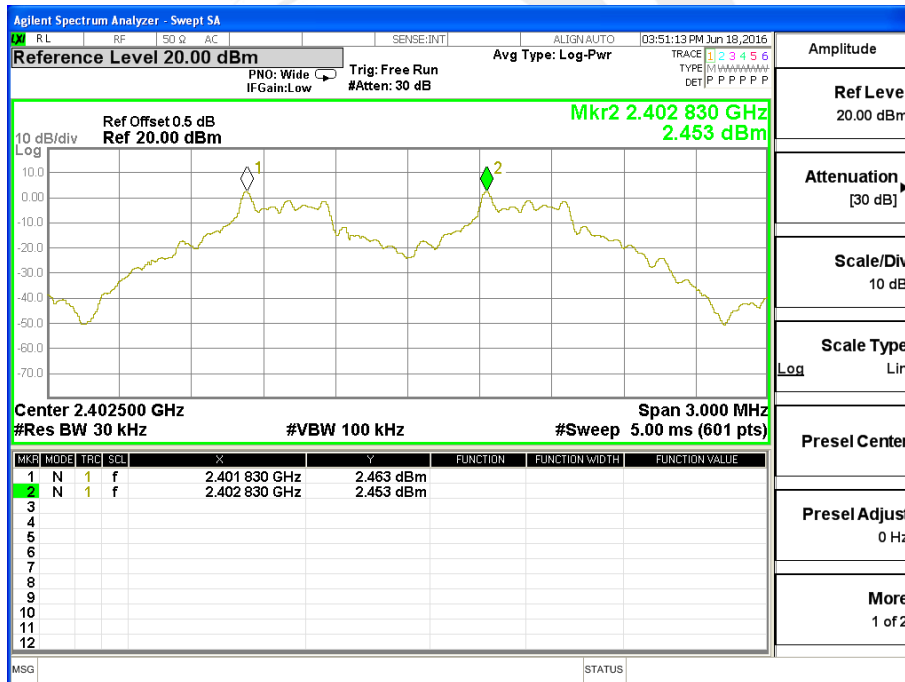



CH39 -1Mbps

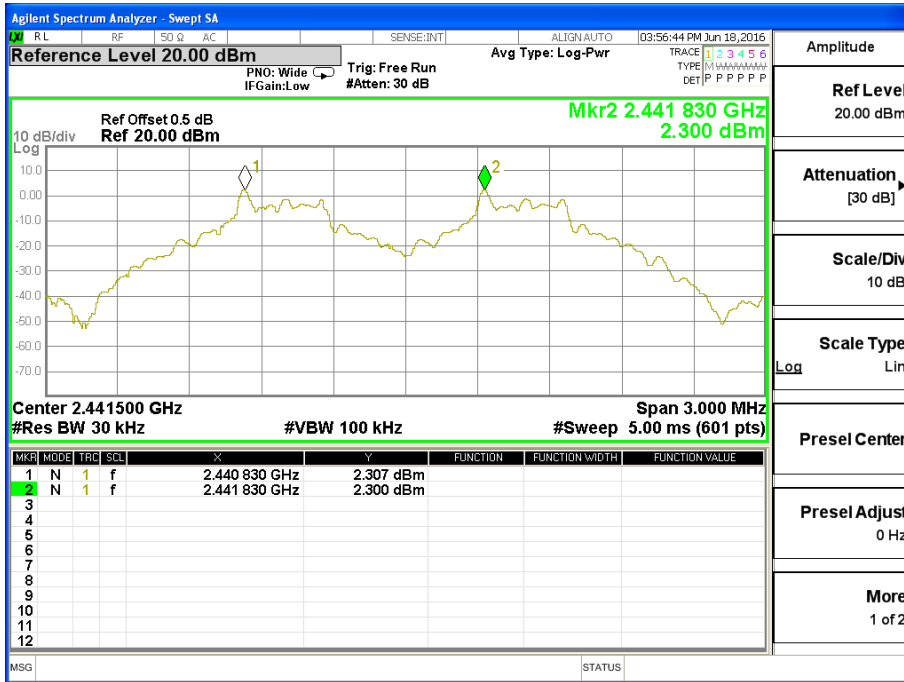

CH78 -1Mbps

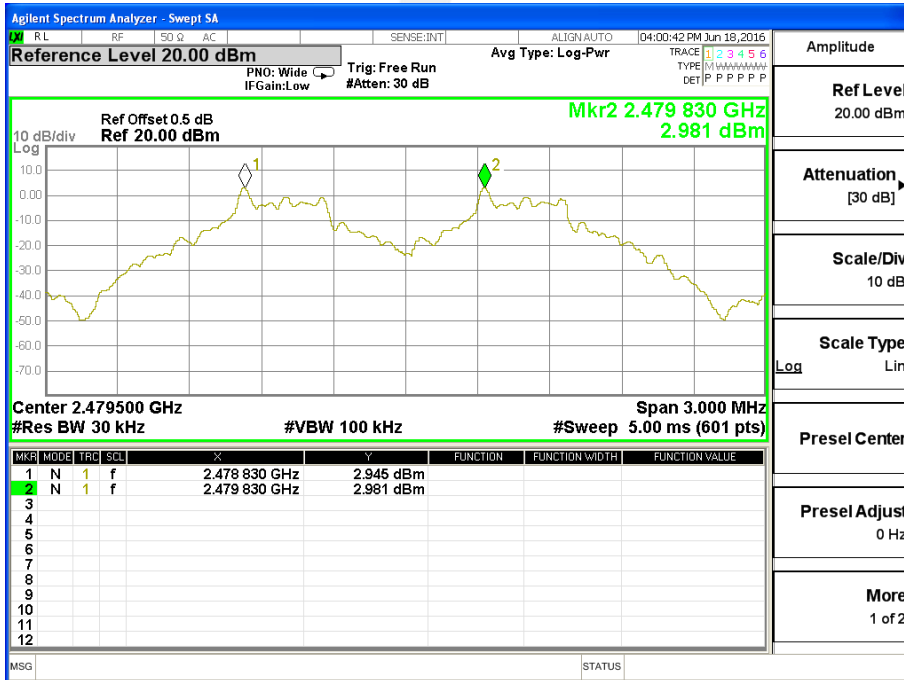



Temperature :	25 °C	Relative Humidity :	50%
Pressure :	1012 hPa	Test Voltage :	DC 3.7V
Test Mode :	CH00 / CH39 /CH78 ($\pi/4$ -DQPSK(2Mbps) Mode)		

Frequency	Ch. Separation (MHz)	Limit	Result
2402 MHz	1.000	0.742	Complies
2441 MHz	1.000	0.743	Complies
2480 MHz	1.000	0.743	Complies

For $\pi/4$ -DQPSK(2Mbps): Ch. Separation Limits: > two-thirds 20dB bandwidth

CH00 -2Mbps

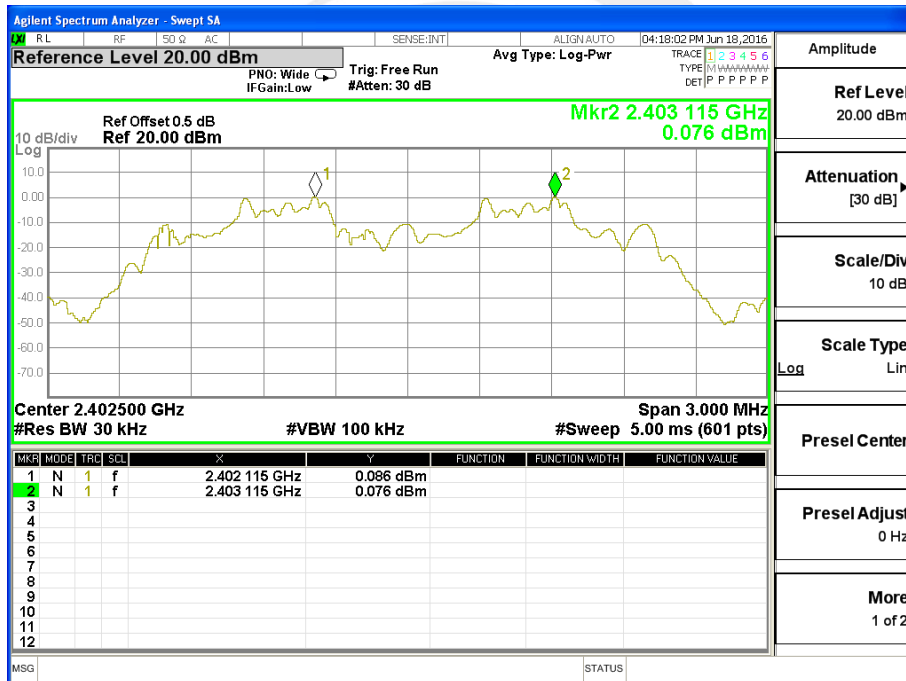



CH39 -2Mbps

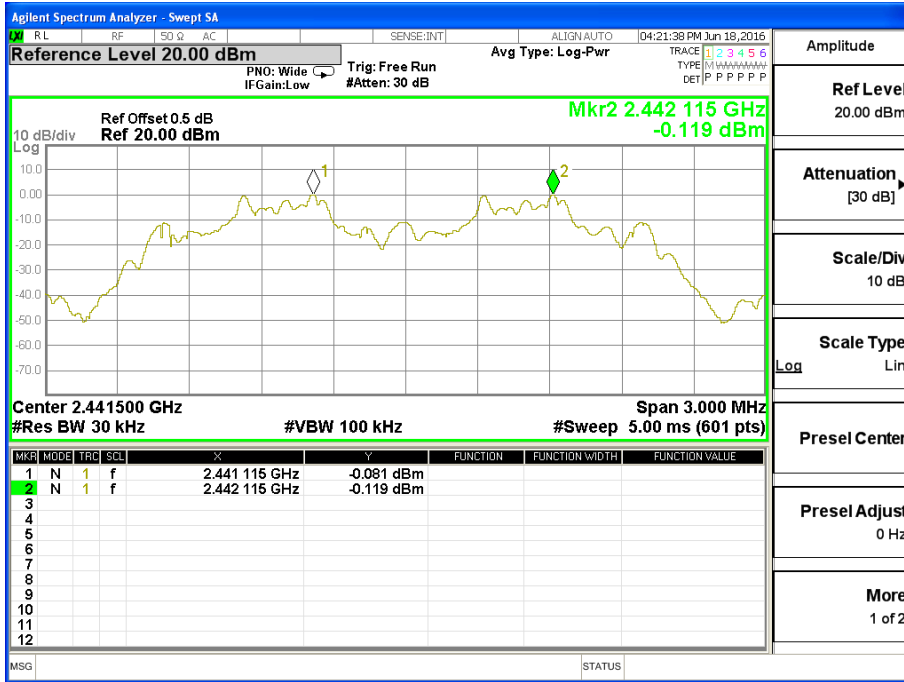

CH78 -2Mbps

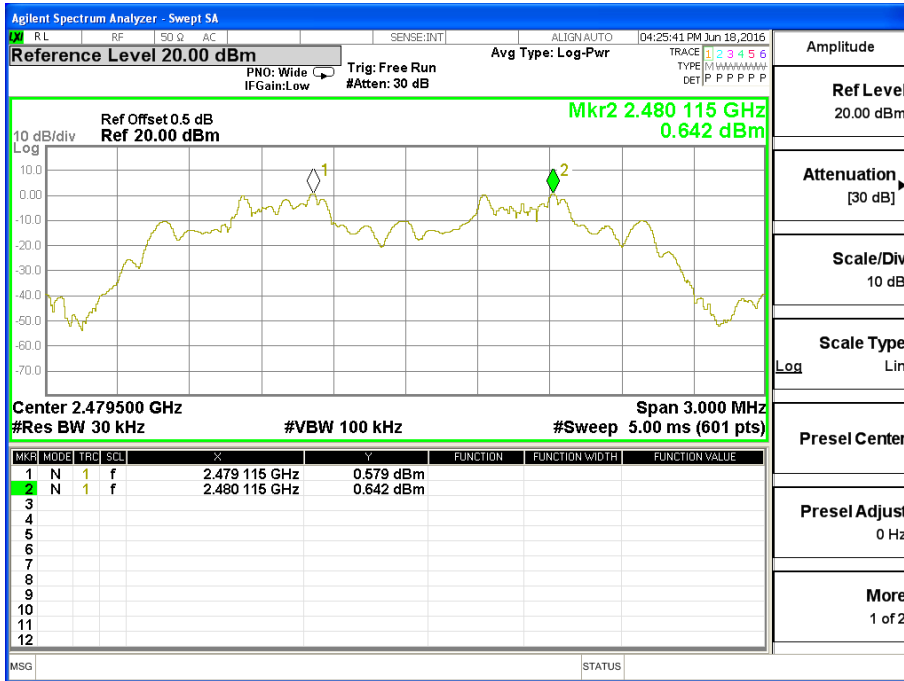



Temperature :	25 °C	Relative Humidity :	50%
Pressure :	1012 hPa	Test Voltage :	DC 3.7V
Test Mode :	CH00 / CH39 /CH78 (8-DPSK(3Mbps)Mode)		

Frequency	Ch. Separation (MHz)	Limit	Result
2402 MHz	1.000	0.775	Complies
2441 MHz	1.000	0.774	Complies
2480 MHz	1.000	0.774	Complies

For 8-DPSK(3Mbps):

Ch. Separation Limits: > two-thirds 20dB bandwidth

CH00 -3Mbps

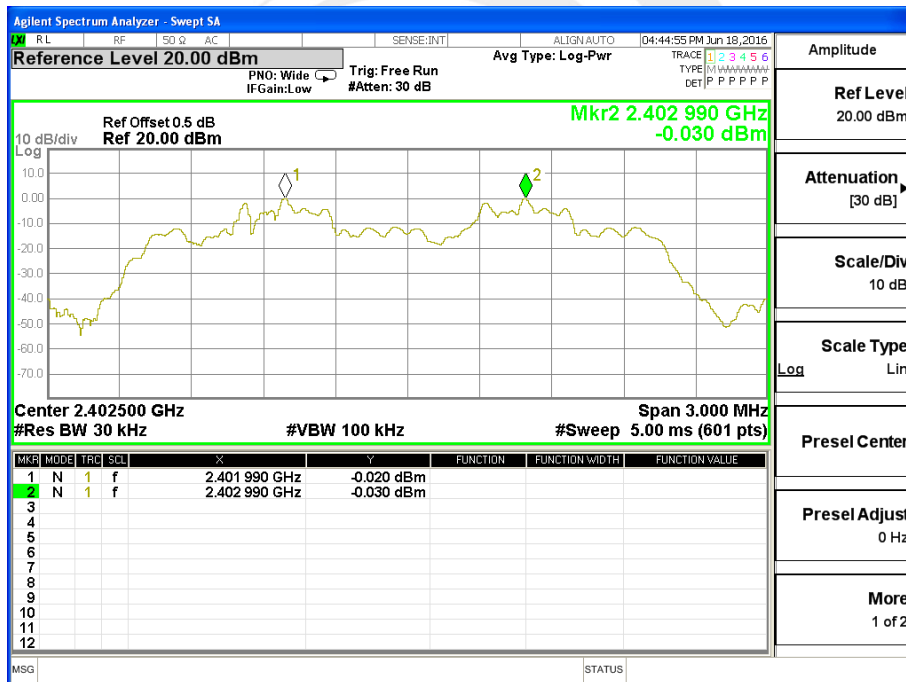



CH39 -3Mbps

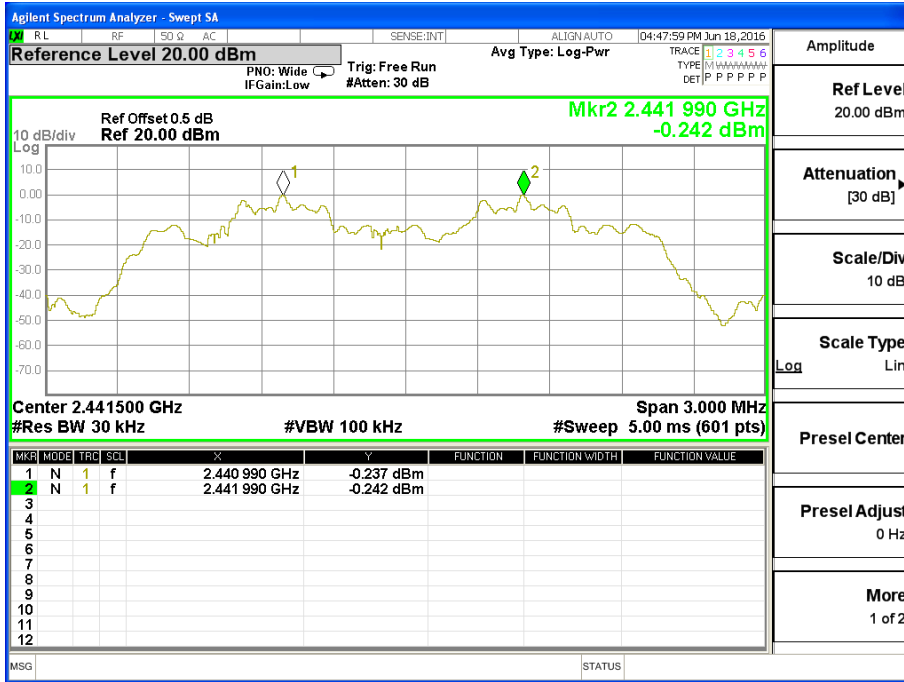

CH78 -3Mbps

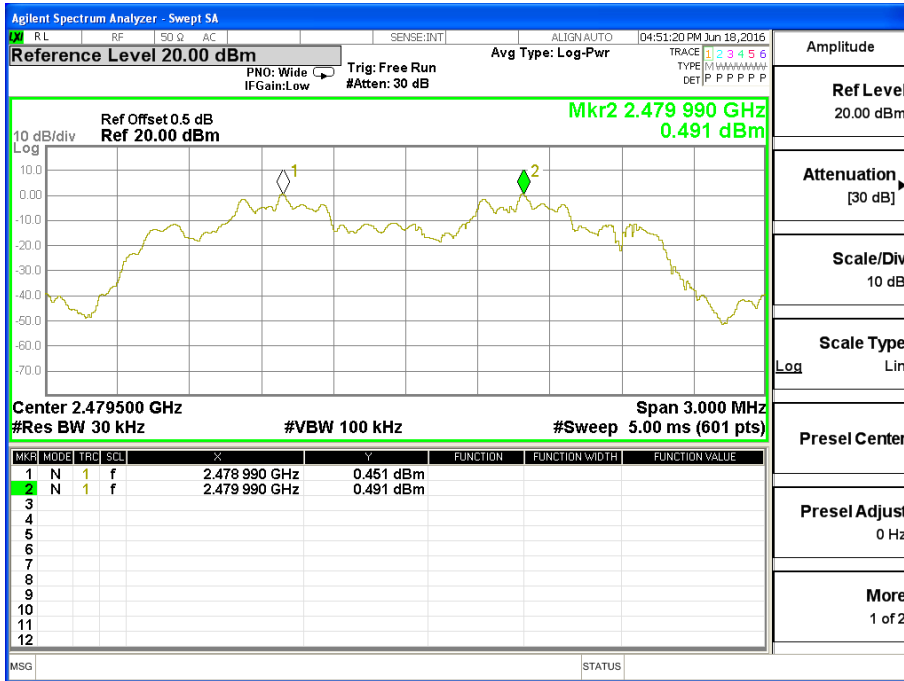



8. BANDWIDTH TEST

8.1 APPLIED PROCEDURES / LIMIT

FCC Part15 (15.247) , Subpart C

Section	Test Item	Limit	FrequencyRange (MHz)	Result
15.247 (a)(1)	Bandwidth	(20dB bandwidth)	2400-2483.5	PASS

Spectrum Parameter	Setting
Attenuation	Auto
Span Frequency	> Measurement Bandwidth or Channel Separation
RB	30 kHz (20dB Bandwidth) / 30 kHz (Channel Separation)
VB	100 kHz (20dB Bandwidth) / 100 kHz (Channel Separation)
Detector	Peak
Trace	Max Hold
Sweep Time	Auto

8.2 TEST PROCEDURE

- The EUT was directly connected to the spectrum analyzer and antenna output port as show in the block diagram below,
- Spectrum Setting : RBW= 30KHz, VBW=100KHz, Sweep time = Auto.

8.3 TEST SETUP



8.4 EUT OPERATION CONDITIONS

The EUT tested system was configured as the statements of 2.4 Unless otherwise a special operating condition is specified in the follows during the testing.



8.5 TEST RESULTS

Temperature :	25 °C	Relative Humidity :	50%
Pressure :	1012 hPa	Test Voltage :	DC 3.7V
Test Mode :	GFSK(1Mbps)CH00 / CH39 /C78		

Frequency	20dB Bandwidth (MHz)	Result
2402 MHz	0.824	PASS
2441 MHz	0.827	PASS
2480 MHz	0.827	PASS

CH00 -1Mbps

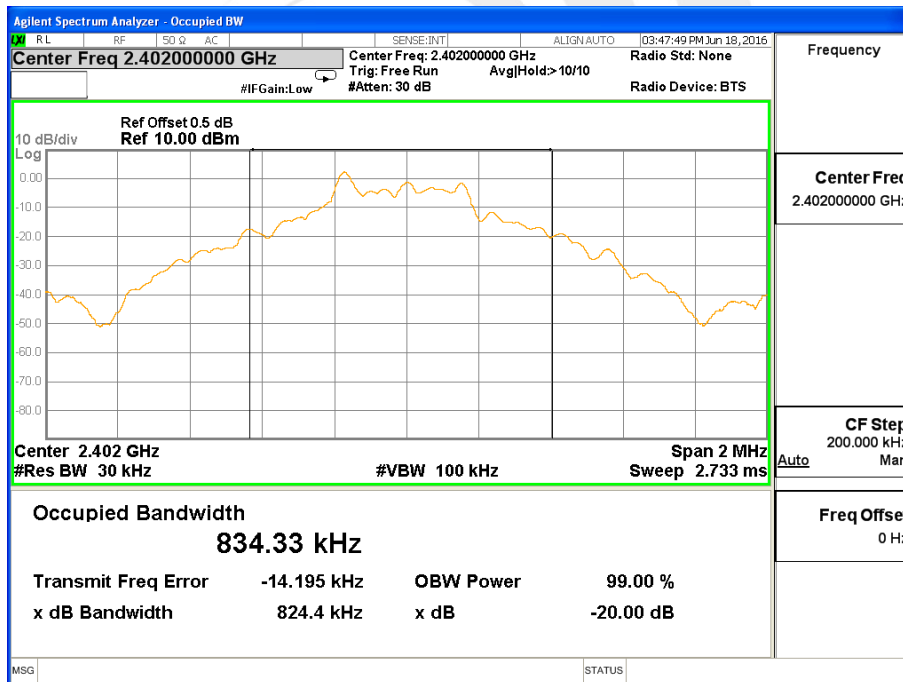



CH39 -1Mbps

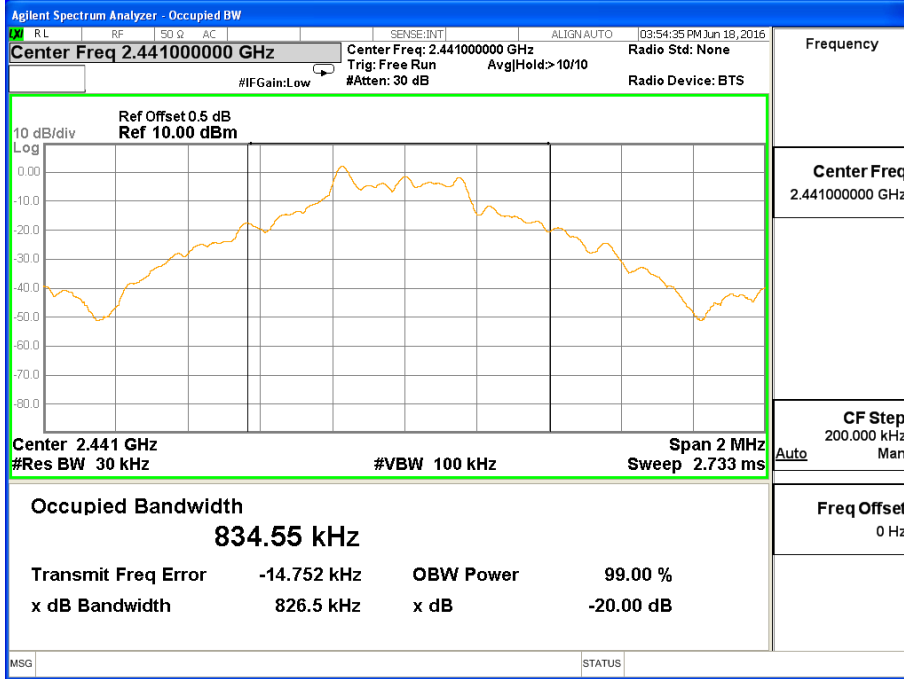

CH78 -1Mbps

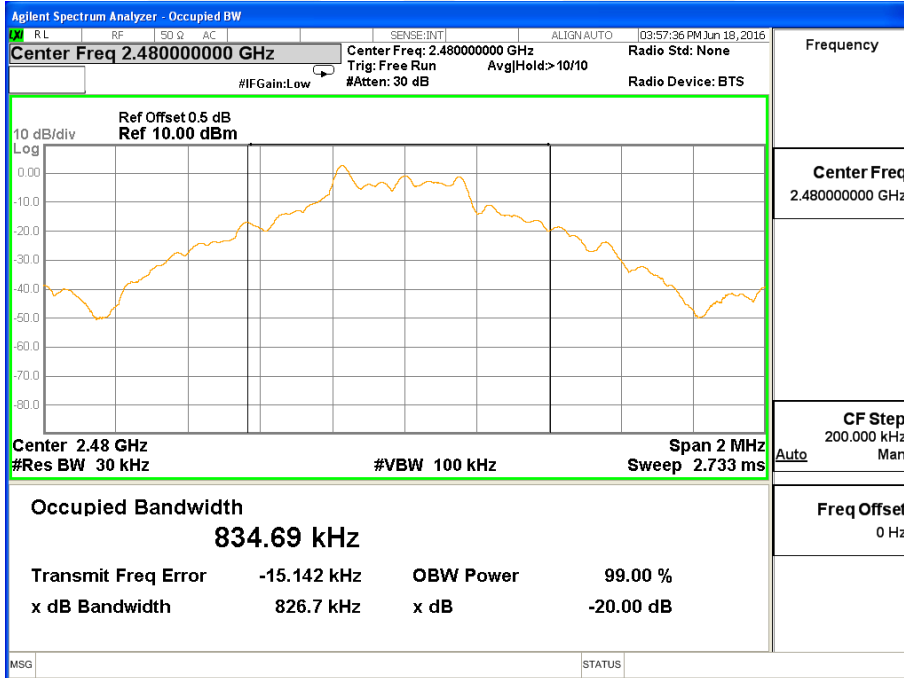



Temperature :	25 °C	Relative Humidity :	50%
Pressure :	1012 hPa	Test Voltage :	DC 3.7V
Test Mode :	π/4-DQPSK(2Mbps)CH00 / CH39 /C78		

Frequency	20dB Bandwidth(MHz)	Result
2402 MHz	1.113	PASS
2441 MHz	1.114	PASS
2480 MHz	1.114	PASS

CH00 -2Mbps

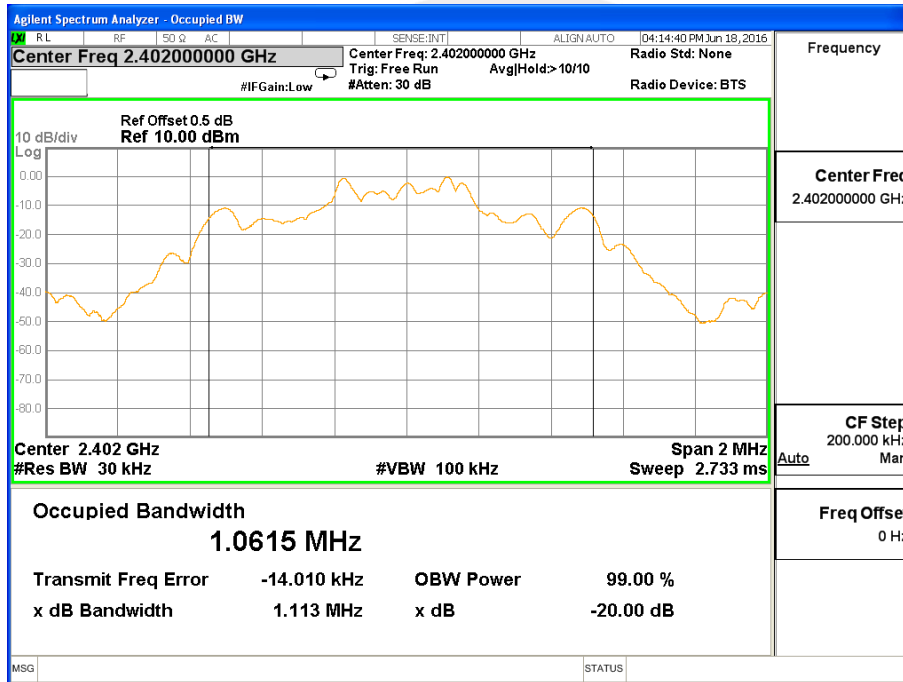



CH39 -2Mbps

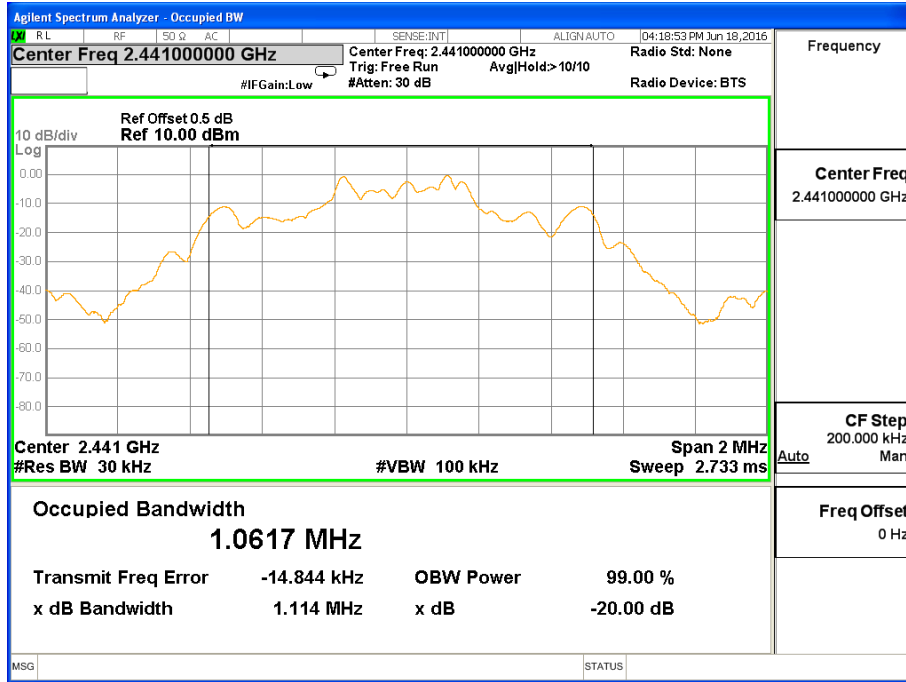

CH78 -2Mbps

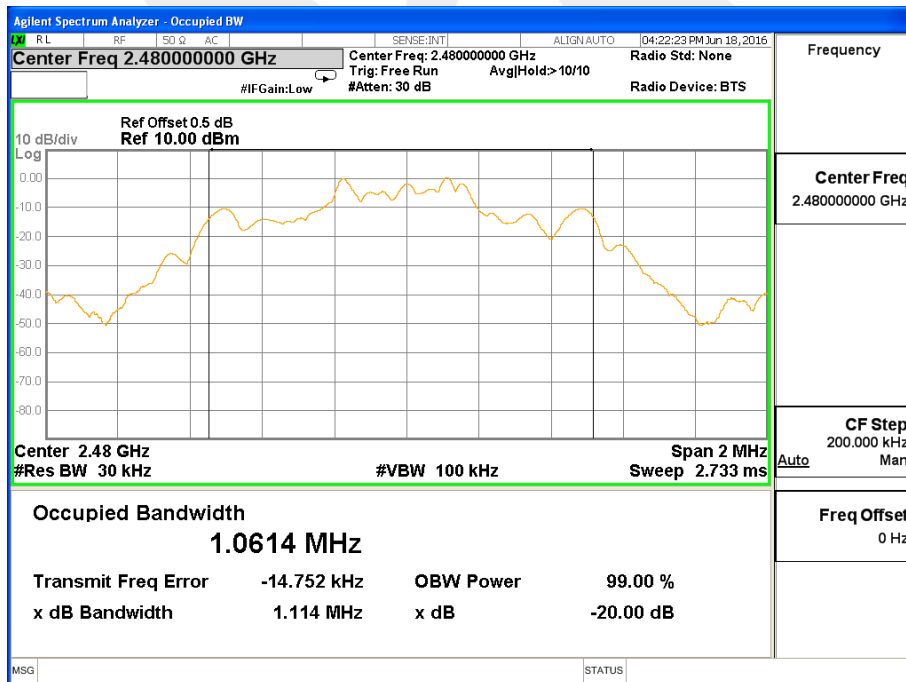



Temperature :	25 °C	Relative Humidity :	50%
Pressure :	1012 hPa	Test Voltage :	DC 3.7V
Test Mode :	8DPSK(3Mbps)CH00 / CH39 /C78		

Frequency	20dB Bandwidth (MHz)	Result
2402 MHz	1.162	PASS
2441 MHz	1.161	PASS
2480 MHz	1.161	PASS

CH00 -3Mbps

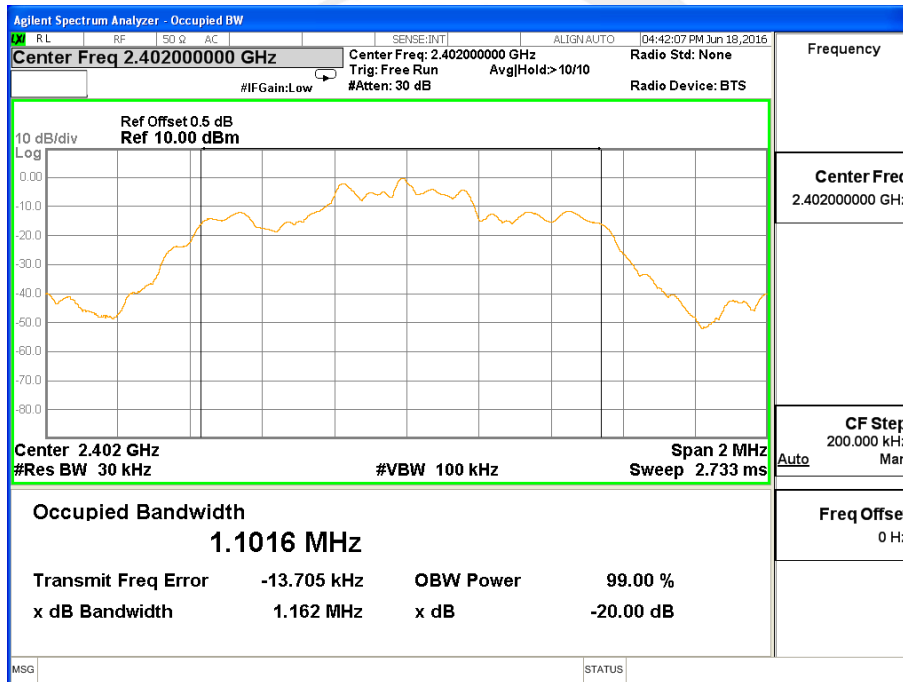



CH39 -3Mbps

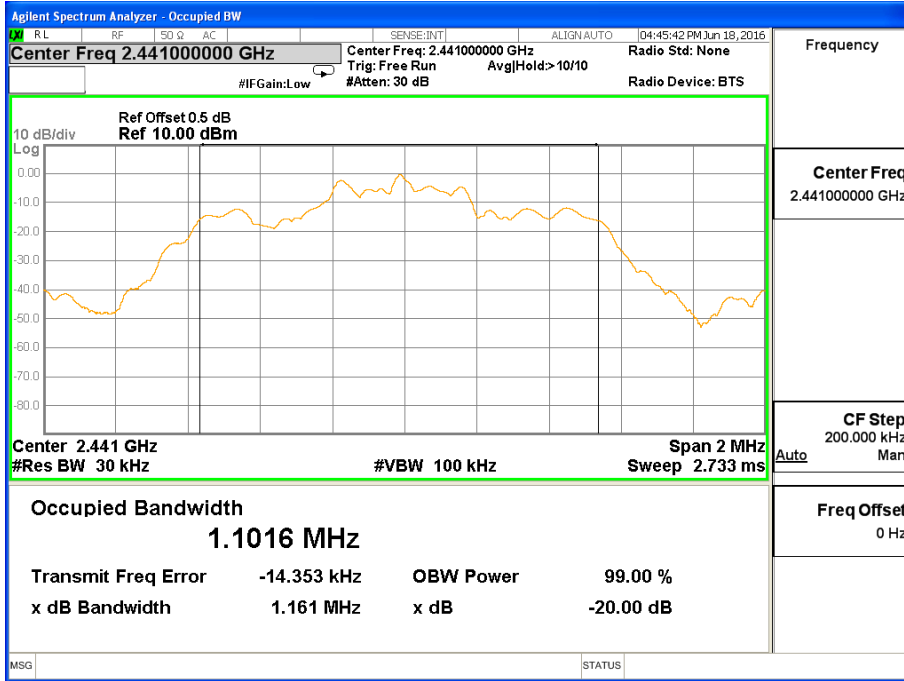

CH78 -3Mbps

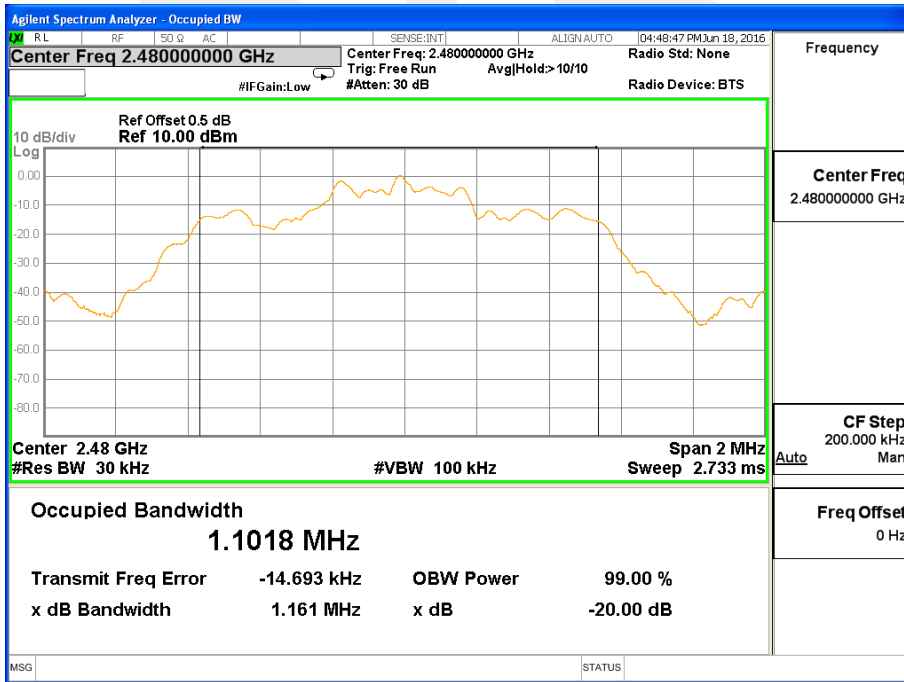



9. PEAK OUTPUT POWER TEST

9.1 APPLIED PROCEDURES / LIMIT

FCC Part15 (15.247) , Subpart C				
Section	Test Item	Limit	FrequencyRange (MHz)	Result
15.247 (a)(1)&(b)(1)	Output Power	1 W or 0.125W	2400-2483.5	PASS
		Or if channel separation > 2/3 bandwidth provided the systems operate with an output power no greater than 125 mW (20.96dBm)		

9.2 TEST PROCEDURE

- a. The EUT was directly connected to the Power Sensor & PC

9.3 TEST SETUP



9.4 EUT OPERATION CONDITIONS

The EUT tested system was configured as the statements of 2.4 Unless otherwise a special operating condition is specified in the follows during the testing.



9.5 TEST RESULTS

Temperature :	25 °C	Relative Humidity :	60%
Pressure :	1012 hPa	Test Voltage :	DC 3.7V
Test Mode :	CH00/ CH39 /CH78 GFSK(1Mbps)		

Test Channel	Frequency (MHz)	Peak Output Power (dBm)	Average Output Power (dBm)	LIMIT (dBm)
CH00	2402	3.874	-1.210	30
CH39	2441	3.759	-1.330	30
CH78	2480	3.771	-1.320	30

Temperature :	25 °C	Relative Humidity :	60%
Pressure :	1012 hPa	Test Voltage :	DC 3.7V
Test Mode :	CH00/ CH39 /CH78 $\pi/4$ -DQPSK(2Mbps)		

Test Channel	Frequency (MHz)	Peak Output Power (dBm)	Average Output Power (dBm)	LIMIT (dBm)
CH00	2402	2.634	-2.450	20.96
CH39	2441	2.659	-2.430	20.96
CH78	2480	2.662	-2.420	20.96

Temperature :	25 °C	Relative Humidity :	60%
Pressure :	1012 hPa	Test Voltage :	DC 3.7V
Test Mode :	CH00/ CH39 /CH78 8-DPSK(3Mbps)		

Test Channel	Frequency (MHz)	Peak Output Power (dBm)	Average Output Power (dBm)	LIMIT (dBm)
CH00	2402	2.638	-2.450	20.96
CH39	2441	2.594	-2.490	20.96
CH78	2480	2.586	-2.500	20.96



10. ANTENNA REQUIREMENT

10.1 STANDARD REQUIREMENT

15.203 requirement: For intentional device, according to 15.203: an intentional radiator shall be designed to ensure that no antenna other than that furnished by the responsible party shall be used with the device.

10.2 EUT ANTENNA

The EUT antenna is PCB Antenna. It comply with the standard requirement.





APPENDIX- PHOTOS OF TEST SETUP

Radiated Measurement Photos





Conducted Measurement Photos



※※※※END OF THE REPORT※※※※