

FCC TEST REPORT

Report No. NTC-ER2311001

Applicant's name Dongguan Jin wen hua digital technology Co., LTD.

Address NO.1 hua Da Road, Long Bei Ling Village, Tangxia Town,
Dongguan City, Guangdong, china

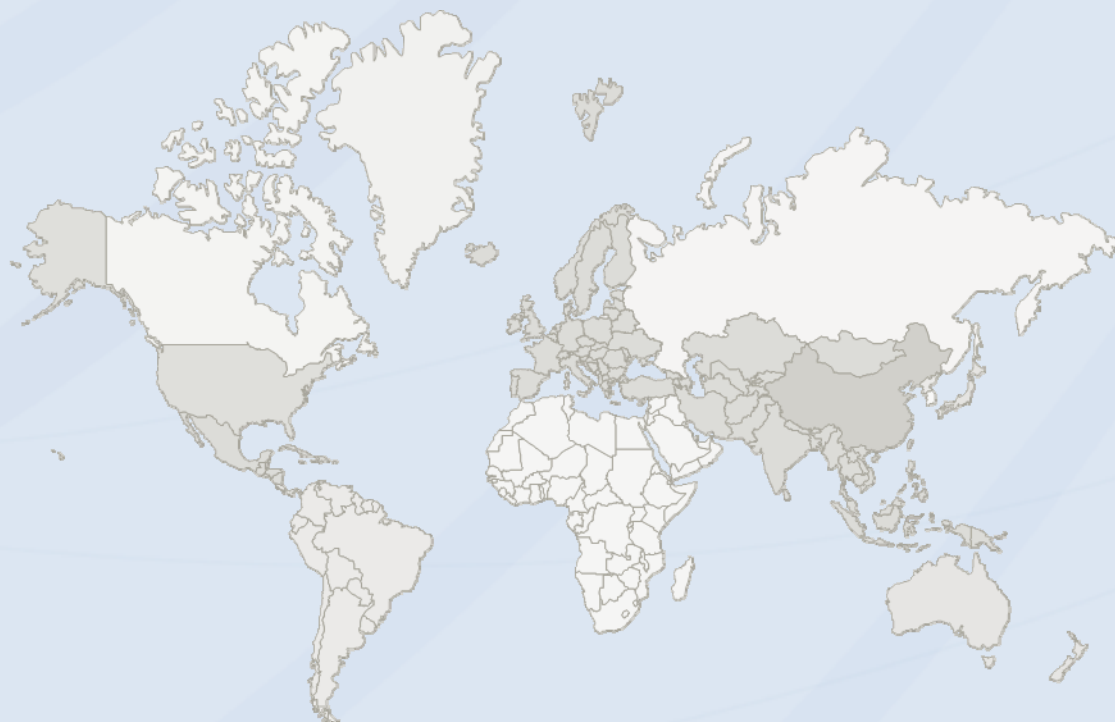

DONGGUAN NEW TESTING CENTRE CO., LTD

Ⓞ Address: 1F & 3F, No. 1 the 1st North Industry Road Songshan Lake Science & Technology Park Dongguan, People's Republic of China 523808

☎ Tel: +86-769-22212079

🌐 Web: <http://www.ntc-cert.com>

✉ E-mail: dave@ntc-cert.com

TABLE OF CONTENTS

Test Report Declare	3
1. Summary of test results	5
2. General test information	5
2.1. Description of EUT	5
2.2. Detail models.....	6
2.3. Block diagram EUT configuration for test.....	6
2.4. Test environment conditions	7
2.5. Measurement uncertainty	8
2.6. Test Peripheral List.....	8
3. Power Line Conducted Emission Test.....	9
3.1. Test equipment	9
3.2. Block diagram of test setup.....	9
3.3. Power Line Conducted Emission Limits (Class B)	9
3.4. Test Procedure.....	10
3.5. Test Result.....	10
4. Radiated emission test.....	13
4.1. Test equipment	13
4.2. Block diagram of test setup	14
4.3. Limit.....	16
4.4. Test Procedure.....	17
4.5. Test result	17
5. Maximum Peak Output Power	24
5.1. Applied procedures / Limit.....	24
5.2. Test procedure	24
5.3. Deviation from standard.....	24
5.4. Test setup	24
5.5. TEST RESULTS	24
6. BANDWIDTH TEST.....	31
6.1. Applied procedures / Limit.....	31
6.2. Test procedure	31
6.3. Deviation from standard.....	31
6.4. Test setup	31
6.5. Test results	31
7. Carrier Frequencies Separated	38

7.1. Applied procedures / Limit.....	38
7.2. Test procedure	38
7.3. Deviation from standard.....	38
7.4. Test setup	38
7.5. Test results	38
8. Hopping Channel Number	41
8.1. Applied procedures / Limit.....	41
8.2. Test procedure	41
8.3. Deviation from standard.....	41
8.4. Test setup	41
8.5. Test result	41
9. Dwell time.....	48
9.1. Applied procedures / Limit.....	48
9.2. Test procedure	48
9.3. Deviation from standard.....	48
9.4. Test setup	48
Test result	49
10. Band edge.....	54
10.1. Applied procedures / Limit.....	54
10.2. Test procedure	54
10.3. Deviation from standard.....	54
10.4. Test setup	54
10.5. Test results	54
11. Conducted Spurious Emissions.....	67
11.1. Applied procedures / Limit.....	67
11.2. Test procedure	67
11.3. Deviation from standard.....	67
11.4. Test setup	67
11.5. Test results	67
12. Antenna Requirement	77
12.1. Standard requirement	77
12.2. EUT Antenna	77
13. Test setup photograph	78
14. Photos of the EUT	80

TEST REPORT DECLARE

FCC ID	: 2AFSG-G306
Equipment under Test	: Wireless earbuds
Model /Type	: G306
Listed Models	: G306-A, G306-B, G306-C, G306-D, G306-E, : SKYWORTH-SEB002, SEB002
Trade Mark	: N/A
Applicant	: Dongguan Jin wen hua digital technology Co., LTD.
Address	: NO.1 hua Da Road, Long Bei Ling Village, Tangxia Town, : Dongguan City, Guangdong, china
Manufacturer	: Dongguan Jin wen hua digital technology Co., LTD.
Address	: NO.1 hua Da Road, Long Bei Ling Village, Tangxia Town, : Dongguan City, Guangdong, china
Test Laboratory	: Dongguan New Testing Centre Co., Ltd
Address	: 1F & 3F, No. 1 the 1st North Industry Road Songshan Lake : Science & Technology Park Dongguan, People’ s Republic of : China 523808

Test Standard Used:

FCC Part 15.247: Operation within the bands 902-928 MHz, 2400-2483.5 MHz and 5725-5850 MHz, ANSI C63.10:2020.

We Declare:

The equipment described above is tested by Dongguan New Testing Centre Co., Ltd and in the configuration tested the equipment complied with the standards specified above. The test results are contained in this test report and Dongguan New Testing Centre Co., Ltd is assumed of full responsibility for the accuracy and completeness of these tests.

After test and evaluation, our opinion is that the equipment provided for test compliance with the requirement of the above FCC standards.

Report No.:	NTC-ER2311001		
Date of Test:	Nov.03, 2023 to Nov.18, 2023	Date of Report.:	Nov.21, 2023

Prepared By:

Jack Liu

Jack Liu/Engineer

Approved By:

Dave

Dave Gao/LAB Manager

Note: This report applies to above tested sample only. This report shall not be reproduced in parts without written approval of Dongguan New Testing Centre Co., Ltd

**** Modified History ****

Revisions	Description	Issued Data	Report No.	Remark
Version 1.0	Initial Test Report Release	2023-11-21	NTC-ER2311001	Dave Gao

1. Summary of test results

Description of Test Item	Standard	Results
Antenna Requirement	Section 15.247(c)	PASS
Conduction Emissions	Section 15.207(a)	PASS
Radiated Emissions	Section 15.247(d)	PASS
Carrier Frequencies Separated	Section 15.247(a)(1)	PASS
Hopping Channel Number	Section 15.247(a)(1) (iii)	PASS
Dwell Time	Section 15.247(a)(1) (iii)	PASS
Maximum Peak Output Power	Section 15.247(b)	PASS
Band edge	Section 15.247(d)	PASS
Conducted Spurious Emissions	Section 15.247(d)	PASS

2. General test information

2.1. Description of EUT

Product Name:	Wireless earbuds
Model/Type reference:	G306
Power supply:	DC 5V charging from adapter Battery DC 3.7V
Bluetooth :	
Supported type:	Bluetooth BR/EDR
Modulation:	GFSK, $\pi/4$ DQPSK, 8DPSK
Operation frequency:	2402MHz~2480MHz
Channel number:	79
Channel separation:	1MHz
Hardware Version:	V1.0
Software Version:	V1.0
Antenna type:	Ceramic Antenna
Antenna gain:	2.5dBi

Note1: For more details, please refer to the user's manual of the EUT.

Note2: Antenna gain provided by the applicant.

2.2. Detail models

Model	Rating	Note
G306	DC 5V charging from adapter Battery DC 3.7	N/A
G306-A		
G306-B		
G306-C		
G306-D		
G306-E		
SKYWORTH-SEB002		
SEB002		

2.3. Block diagram EUT configuration for test

1. Block diagram of EUT configuration (TX Mode)

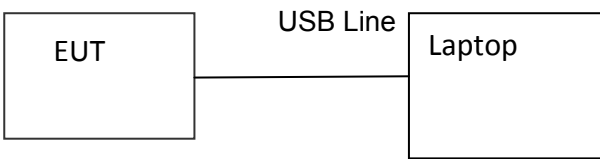

```

graph LR
    EUT[EUT] --- USB[USB Line] --- Laptop[Laptop]
  
```

Note:

- 1.Connect the EUT as above block diagram of configuration, Run the software, set the transmit serial port/power/channel/packet type/data type/hopping or not, send configuration, than EUT enter the TX mode.
- 2.Set EUT in continuous transmission signal mode.
- 3.Using the laptop and the transform board to control the fixed transmitting frequency and other test mode. After finishing the test setting, the notebook and the transform board will be removed during measurements.

2.4. Test environment conditions

During the measurement the environmental conditions were within the listed ranges:

(1) Test frequencies:

According to the 15.31(m) Measurements on intentional radiators or receivers, other than TV broadcast receivers, shall be performed and. If required reported for each band in which the device can be operated with the device operating at the number of frequencies in each band specified in the following table:

Frequency range over which device operates	Number of frequencies	Location in the range of operation
1 MHz or less	1	Middle
1 to 10 MHz	2	1 near top and 1 near bottom
More than 10 MHz	3	1 near top, 1 near middle and 1 near bottom

(2) Frequency range of radiated measurements:

According to the 15.33, the test range will be up to the tenth harmonic of the highest fundamental frequency.

Description of Test Modes and Test Frequency

The Applicant provides communication tools software to control the EUT for staying in continuous transmitting (Duty Cycle more than 98%) and receiving mode for testing .There are 79 channels provided to the EUT and Channel 00/39/78 were selected to test.

(3) Operation Frequency:

Channel	Frequency (MHz)
00	2402
01	2403
⋮	⋮
38	2440
39	2441
40	2442
⋮	⋮
77	2479
78	2480

Test Items	Worst case
Conducted Emissions	DH5 Middle channel
Radiated Emissions and Band Edge	DH5
Maximum Conducted Output Power	DH5/2DH5/3DH5
20dB Bandwidth	DH5/2DH5/3DH5
Frequency Separation	DH5/2DH5/3DH5 Middle channel
Number of hopping frequency	DH5/2DH5/3DH5
Time of Occupancy (Dwell Time)	DH1/DH3/DH5 Middle channel 2DH1/2DH3/2DH5 Middle channel 3DH1/3DH3/3DH5 Middle channel
Out-of-band Emissions	DH5/2DH5/3DH5

Preliminary tests were performed in each mode and packet length of BT, and found worst case as bellow, finally test were conducted at those mode and recorded in this report.

2.5. Measurement uncertainty

Test Item	Uncertainty
Uncertainty for Conduction emission test	2.44dB
Uncertainty for Radiation Emission test (30MHz – 1GHz)	3.14 dB (Polarize: V)
	3.16 dB (Polarize: H)
Uncertainty for Radiation Emission test (1GHz – 18GHz)	4.27 dB (Polarize: V)
	4.51 dB (Polarize: H)
Uncertainty for conducted RF Power	0.63dB
Stop Transmitting Time Test	±0.5%
Uncertainty for frequency error	5.8 x 10 ⁻⁸

Note: This uncertainty represents an expanded uncertainty expressed at approximately the 95% confidence level using a coverage factor of k=2.

2.6. Test Peripheral List

No.	Equipment	Manufacturer	FCC approved	Model No.	Serial No.	signal cable
1	Lap top	lenovo	DOC	7457	7457A82	N/A

3. Power Line Conducted Emission Test

3.1. Test equipment

Item	Equipment	Manufacturer	Model No.	Serial No.	Last Cal.	Cal. Interval
1	Test Receiver	R&S	ESCI	101699	2023-07-27	1 Year
2	LISN	R&S	ENV216	3650.6550.06	2023-05-19	1 Year
3	LISN	KHC	KH3765	37650053	2023-05-19	1 Year
4	8-WIRE ISN for CAT6	R&S	ENY81-CA6	101862	2023-05-19	1 Year
5	RF Cable	HUBER	SUCOFLEX100	30722/4E	2023-05-19	2 Year
6	MEASUREMENT SOFTWARE	FARAD	EZ-EMC(VER:1.1.4.2)	N/A	N/A	N/A

3.2. BLOCK DIAGRAM OF TEST SETUP

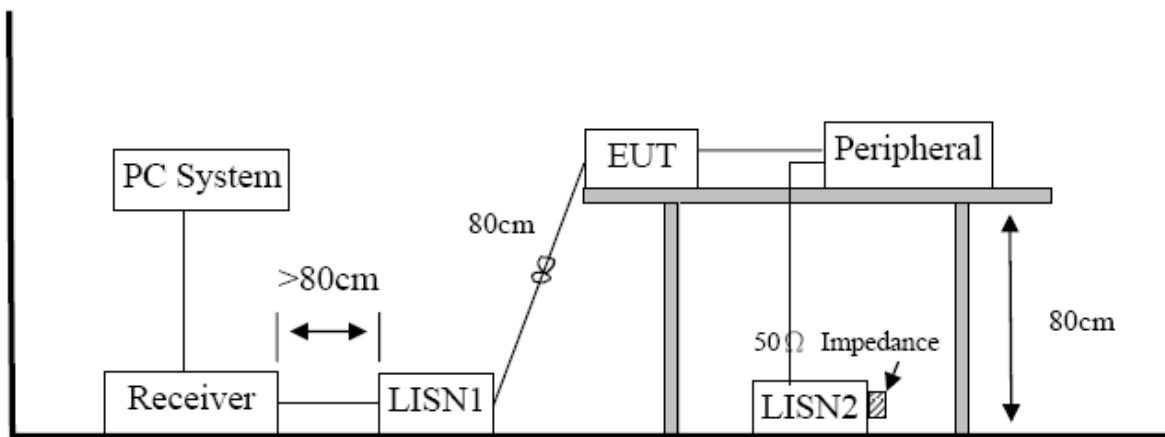

3.3. Power Line Conducted Emission Limits (Class B)

Frequency	Quasi-Peak Level dB(μ V)	Average Level dB(μ V)
150kHz ~ 500kHz	66 ~ 56*	56 ~ 46*
500kHz ~ 5MHz	56	46
5MHz ~ 30MHz	60	50

Note 1: * Decreasing linearly with logarithm of frequency.

Note 2: The lower limit shall apply at the transition frequencies.

3.4. Test Procedure

The EUT and Support equipment, if needed, were put placed on a non-metallic table, 80cm above the ground plane.

Configuration EUT to simulate typical usage as described in clause 2.3 and test equipment as described in clause 3.2 of this report.

All I/O cables were positioned to simulate typical actual usage as per ANSI C63.10.

All support equipment power received from a second LISN.

Emissions were measured on each current carrying line of the EUT using an EMI Test Receiver connected to the LISN powering the EUT.

The Receiver scanned from 150 kHz to 30MHz for emissions in each of the test modes.

During the above scans, the emissions were maximized by cable manipulation.

The test mode(s) described in clause 2.3 were scanned during the preliminary test.

After the preliminary scan, we found the test mode producing the highest emission level.

The EUT configuration and worse cable configuration of the above highest emission levels were recorded for reference of the final test.

EUT and support equipment were set up on the test bench as per the configuration with highest emission level in the preliminary test.

A scan was taken on both power lines, Neutral and Line, recording at least the six highest emissions. Emission frequency and amplitude were recorded into a computer in which correction factors were used to calculate the emission level and compare reading to the applicable limit.

The test data of the worst-case condition(s) was recorded.

The bandwidth of test receiver is set at 9 KHz.

3.5. Test Result

PASS. (See below detailed test result)

Note1: All emissions not reported below are too low against the prescribed limits.

Note2: "-----" means Peak detection; "-----" means Average detection

Note3: Measurement = Reading Level + Factor, Margin= Measurement-Limit

Note4: All modes of GFSK, Pi/4 DQPSK, and 8DPSK were test at Low, Middle, and High channel; only the worst result of GFSK Middle Channel was reported as below:

Conducted Emission Test Result

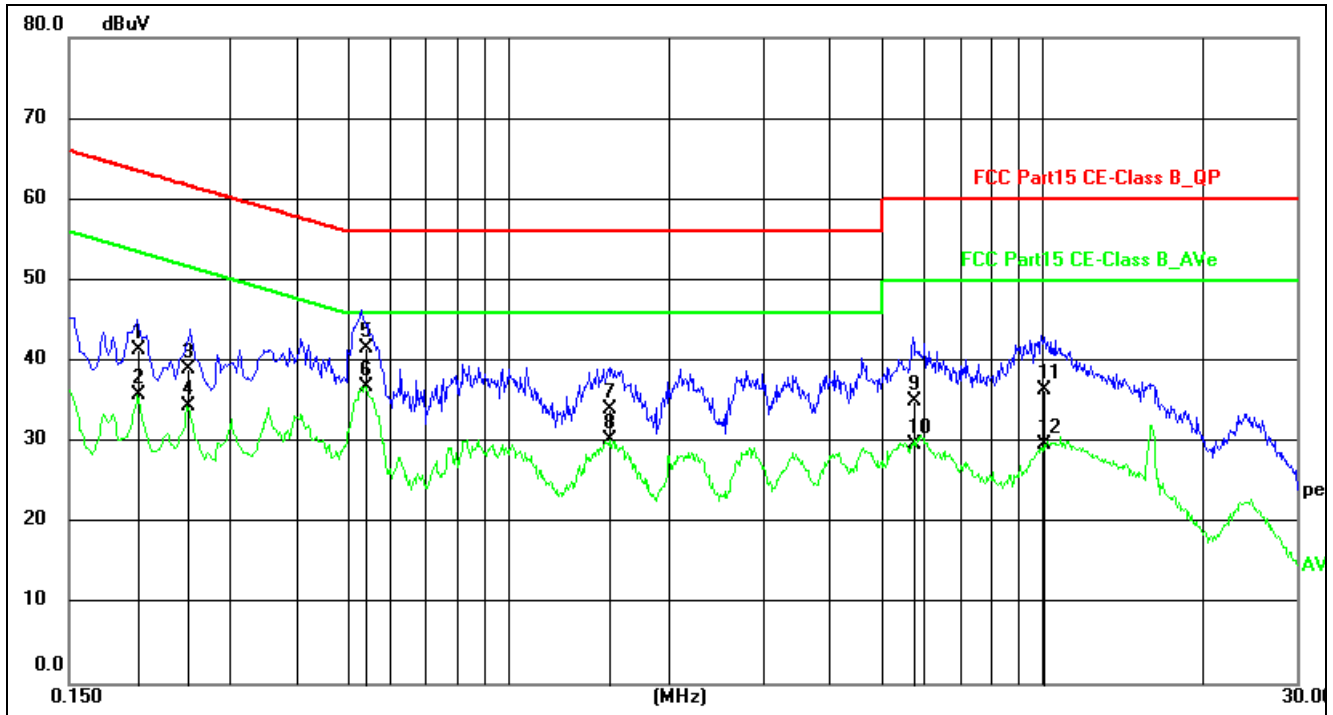

Site:	844 LAB	Phase:	L1	Temperature(C):	24(C)
Limit:	FCC Part15 CE-Class B_QP	Test Time:	2023/11/13 16:51:17	Humidity(%):	63%
EUT:	Wireless earbuds	Power Rating:	DC 5V charging from adapter	Test Engineer:	Taylor Chen
M/N.:	G306	Note:	GFSK Middle		

No.	Frequency (MHz)	Reading Level(dBuV)	Factor (dB)	Measure-ment(dBuV)	Limit (dBuV)	Margin (dB)	Detector	Comment
1	0.2020	30.28	11.14	41.42	63.53	-22.11	QP	
2	0.2020	24.74	11.14	35.88	53.53	-17.65	AVG	
3	0.2500	27.96	11.14	39.10	61.76	-22.66	QP	
4	0.2500	23.33	11.14	34.47	51.76	-17.29	AVG	
5	0.5380	30.42	11.21	41.63	56.00	-14.37	QP	
6 *	0.5380	25.63	11.21	36.84	46.00	-9.16	AVG	
7	1.5460	22.90	11.24	34.14	56.00	-21.86	QP	
8	1.5460	18.98	11.24	30.22	46.00	-15.78	AVG	
9	5.7266	23.90	11.18	35.08	60.00	-24.92	QP	
10	5.7266	18.48	11.18	29.66	50.00	-20.34	AVG	
11	10.0783	25.15	11.20	36.35	60.00	-23.65	QP	
12	10.0783	18.45	11.20	29.65	50.00	-20.35	AVG	

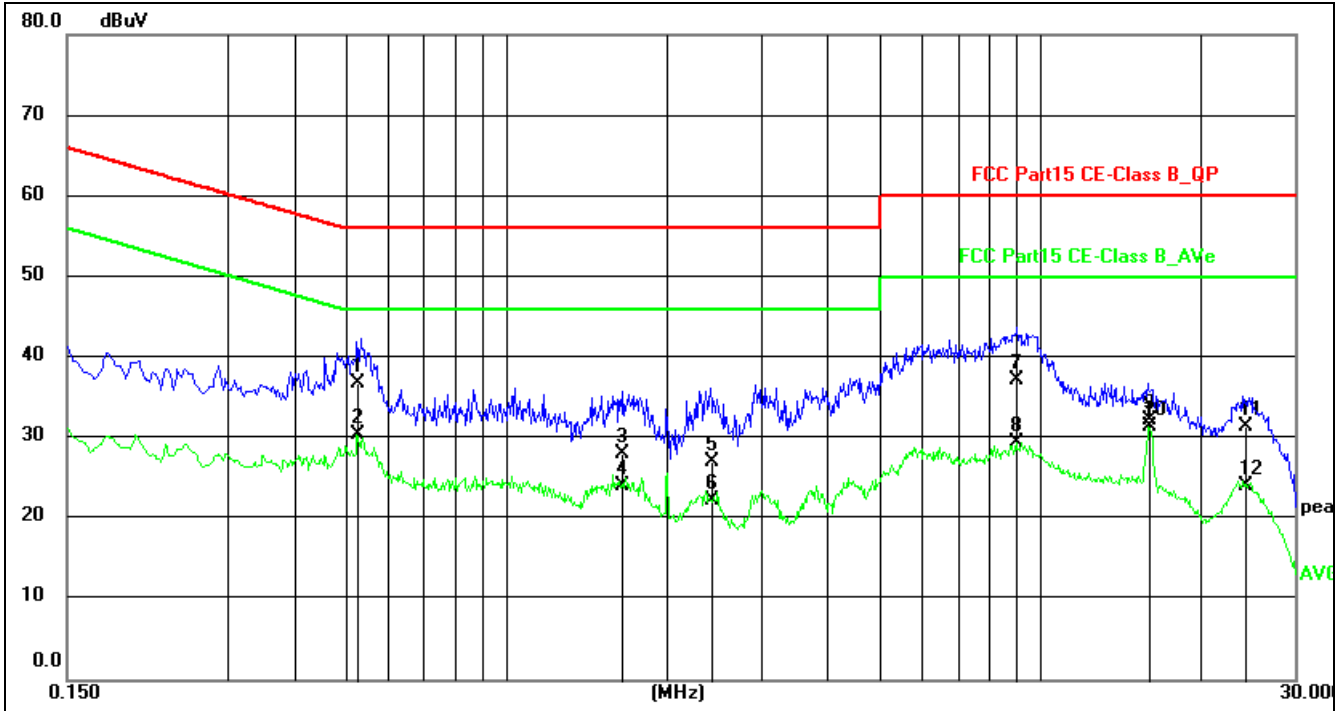

Site:	844 LAB	Phase:	N	Temperature(C):	24(C)
Limit:	FCC Part15 CE-Class B_QP	Test Time:	2023/11/13 16:54:10	Humidity(%):	63%
EUT:	Wireless earbuds	Power Rating:	DC 5V charging from adapter	Test Engineer:	Taylor Chen
M/N.:	G306	Note:	GFSK Middle		

No.	Frequency (MHz)	Reading Level(dBuV)	Factor (dB)	Measurement(dBuV)	Limit (dBuV)	Margin (dB)	Detector	Comment
1	0.5260	25.43	11.31	36.74	56.00	-19.26	QP	
2 *	0.5260	19.14	11.31	30.45	46.00	-15.55	AVG	
3	1.6420	16.87	11.22	28.09	56.00	-27.91	QP	
4	1.6420	12.80	11.22	24.02	46.00	-21.98	AVG	
5	2.4300	15.82	11.19	27.01	56.00	-28.99	QP	
6	2.4300	11.12	11.19	22.31	46.00	-23.69	AVG	
7	9.0539	26.15	11.12	37.27	60.00	-22.73	QP	
8	9.0539	18.37	11.12	29.49	50.00	-20.51	AVG	
9	16.0379	20.94	11.39	32.33	60.00	-27.67	QP	
10	16.0379	20.11	11.39	31.50	50.00	-18.50	AVG	
11	24.2060	19.97	11.57	31.54	60.00	-28.46	QP	
12	24.2060	12.61	11.57	24.18	50.00	-25.82	AVG	

4. Radiated emission test

4.1. Test equipment

Item	Equipment	Manufacturer	Model No.	Serial No.	Last Cal.	Cal. Interval
1	Test Receiver	R&S	ESR	101380	2023-05-19	1Year
2	Trilog Broadband Antenna	Schwarzbeck	VULB9168	00969	2023-05-19	2 Year
3	Horn antenna	Schwarzbeck	BBHA9120D	453	2023-05-19	2Year
4	Pre-amplifier	Agilent	8449B	3008A04721	2023-05-19	1Year
5	Double Ridged Horn Antenna	A.H. System	SAS-574	584	2023-05-19	1Year
6	Active Loop antenna	Schwarzbeck	FMZB-1519	1519-038	2023-05-19	1Year
7	Pre-amplifier	R&S	8447F	3113A04553	2023-05-19	1Year
8	RF Cable	GORE	OSQ01Q010 78.7	SN1545847 3	2023-05-19	2Year
9	RF Cable	ESCO	ETS-LINGR EN	RFC-SMS-1 00-SMS-340 -IN	2023-05-19	2Year
10	Measurement software	Farad	EZ-EMC(VE R:1.1.4.2)	N/A	N/A	N/A

4.2. Block diagram of test setup

In 3m Anechoic Chamber Test Setup Diagram for 9KHz to 30MHz:

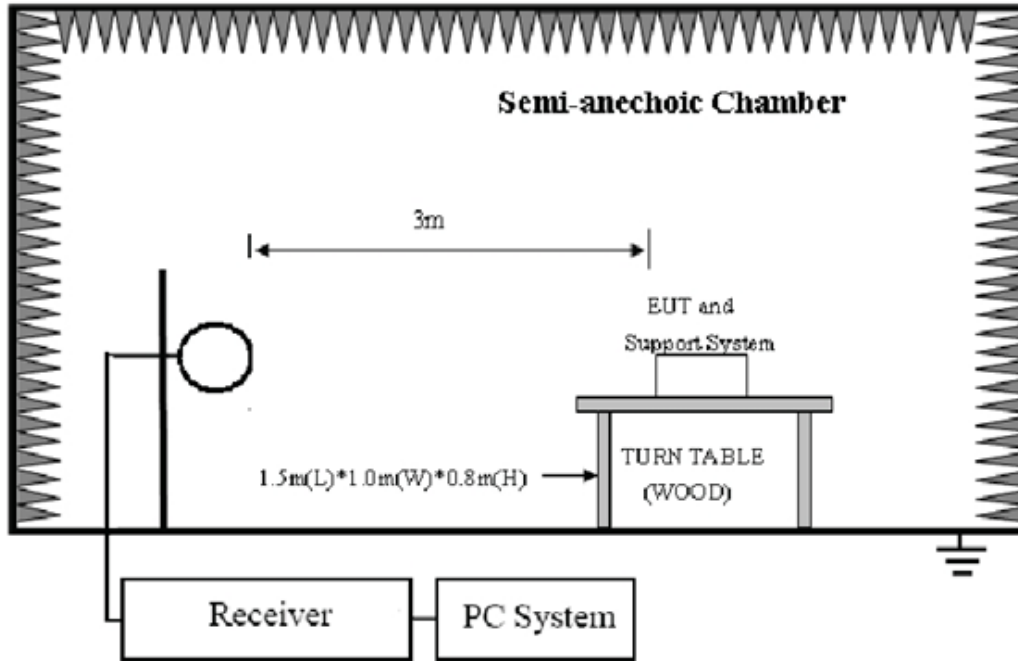

In 3m Anechoic Chamber Test Setup Diagram for 30MHz to 1GHz:

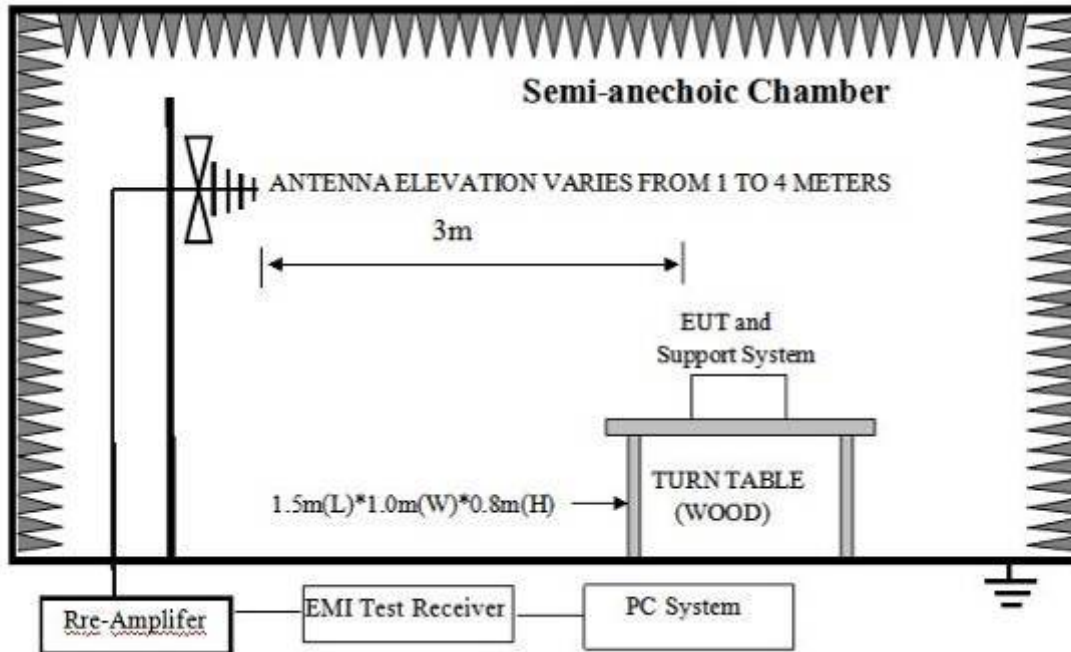

In 3m Anechoic Chamber Test Setup Diagram for frequency above 1GHz:

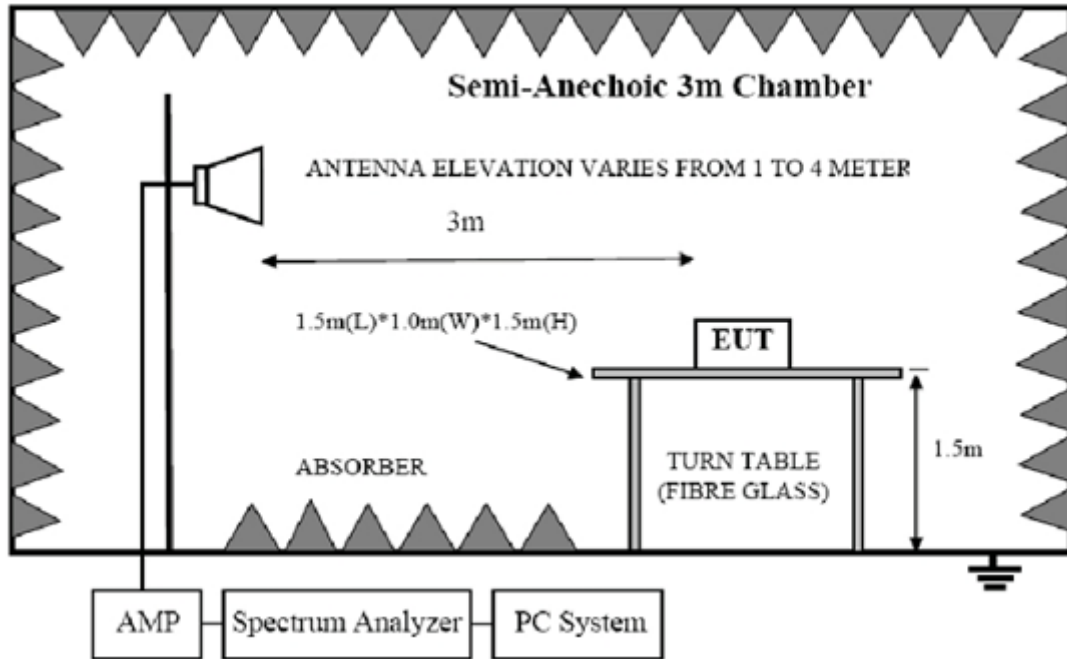

4.3. Limit

FCC 15.205 Restricted frequency band:

MHz	MHz	MHz	GHz
0.090 - 0.110	16.42 - 16.423	399.9 - 410	4.5 - 5.15
¹ 0.495 - 0.505	16.69475 - 16.69525	608 - 614	5.35 - 5.46
2.1735 - 2.1905	16.80425 - 16.80475	960 - 1240	7.25 - 7.75
4.125 - 4.128	25.5 - 25.67	1300 - 1427	8.025 - 8.5
4.17725 - 4.17775	37.5 - 38.25	1435 - 1626.5	9.0 - 9.2
4.20725 - 4.20775	73 - 74.6	1645.5 - 1646.5	9.3 - 9.5
6.215 - 6.218	74.8 - 75.2	1660 - 1710	10.6 - 12.7
6.26775 - 6.26825	108 - 121.94	1718.8 - 1722.2	13.25 - 13.4
6.31175 - 6.31225	123 - 138	2200 - 2300	14.47 - 14.5
8.291 - 8.294	149.9 - 150.05	2310 - 2390	15.35 - 16.2
8.362 - 8.366	156.52475 - 156.52525	2483.5 - 2500	17.7 - 21.4
8.37625 - 8.38675	156.7 - 156.9	2690 - 2900	22.01 - 23.12
8.41425 - 8.41475	162.0125 - 167.17	3260 - 3267	23.6 - 24.0
12.29 - 12.293	167.72 - 173.2	3332 - 3339	31.2 - 31.8
12.51975 - 12.52025	240 - 285	3345.8 - 3358	36.43 - 36.5
12.57675 - 12.57725	322 - 335.4	3600 - 4400	(²)

FCC 15.209 Limit

Frequency (MHz)	Distance (Meters)	Field Strengths Limits dB(μV)/m
30--88	3	40.0
88--216	3	43.5
216--960	3	46.0
960--1000	3	54.0
Above 1GHz	3	Peak: 74.0
	3	Average: 54.0

Note: (1) The smaller limit shall apply at the cross point between two frequency bands.

(2) Distance is the distance in meters between the measuring instrument, antenna and the closest point of any part of the device or system.

(3) The emission limits shown in the above table are based on measurements employing a CISPR QP detector except for the frequency bands 9-90KHz, 110-490KHz and above 1000MHz. Radiated emissions limits in these three bands are based on measurements employing an average detector.

(4) At frequencies below 30MHz, measurement may be performed at a distance closer than that specified, and the limit at closer measurement distance can be extrapolated by below formula:

$$\text{Limit}_{3m}(\text{dBuV}/\text{m}) = \text{Limit}_{30m}(\text{dBuV}/\text{m}) + 40\text{Log}(30\text{m}/3\text{m})$$

(5) All the emissions appearing within 15.205 restricted frequency bands shall not exceed the limits shown in 15.209, all the other emissions shall be at least 20dB below the fundamental emissions, or comply with 15.209 limits.

4.4. Test Procedure

Procedure of Preliminary Test

Configuration EUT to simulate typical usage as described in clause 2.3 and test equipment as described in clause 4.2 of this report.

Mains cables, telephone lines or other connections to auxiliary equipment located outside the test are shall drape to the floor, be fitted with ferrite clamps or ferrite tubes placed on the floor at the point where the cable reaches the floor and then routed to the place where they leave the turntable. No extension cords shall be used to mains receptacle.

EUT height should be 0.8m for below 1GHz and 1.5m for above 1GHz at ground with absorbers.

The antenna was placed at 3 meter away from the EUT as stated in ANSI C63.10. The antenna connected to the Spectrum Analyzer via a cable and at times a pre-amplifier would be used.

The Analyzer / Receiver quickly scanned from 30MHz to 18GHz. The EUT test program was started. Emissions were scanned and measured rotating the EUT to 360 degrees and positioning the antenna 1 to 4 meters above the ground plane, in both the vertical and the horizontal polarization, to maximize the emission reading level.

The X, Y, Z three axial are tested and the report only the worst case.

The emissions from 9KHz to 1GHz, QP or average values were measured with EMI receiver with below RBW:

Frequency band	RBW
9KHz-150KHz	200Hz
150KHz-30MHz	9KHz
30MHz-1GHz	120KHz

For emissions above 1GHz, both Peak and Average level were measured with Spectrum Analyzer, and the RBW is set at 1MHz, VBW is set at 3MHz for Peak measure; RMS detector RBW 1MHz VBW 3MHz for Average measure.

4.5. Test result

PASS. (See below detailed test result)

All the emissions except fundamental emission from 9 KHz to 40GHz were comply with FCC PART 15.209 limits limit.

Note1: For emissions above 1GHz. If peak results comply with AV limit, AV Result is deemed to comply with AV limit.

Note2: Level = Reading Level + Factor, Margin= Level-Limit

Note3: We measured Radiated Emission at GFSK, $\pi/4$ DQPSK and 8DPSK mode from 9 KHz to 25GHz and recorded worst case at GFSK DH5 mode.

Note4: For below 1GHz testing recorded worst at GFSK DH5 low channel.

Radiated Emission Test Result

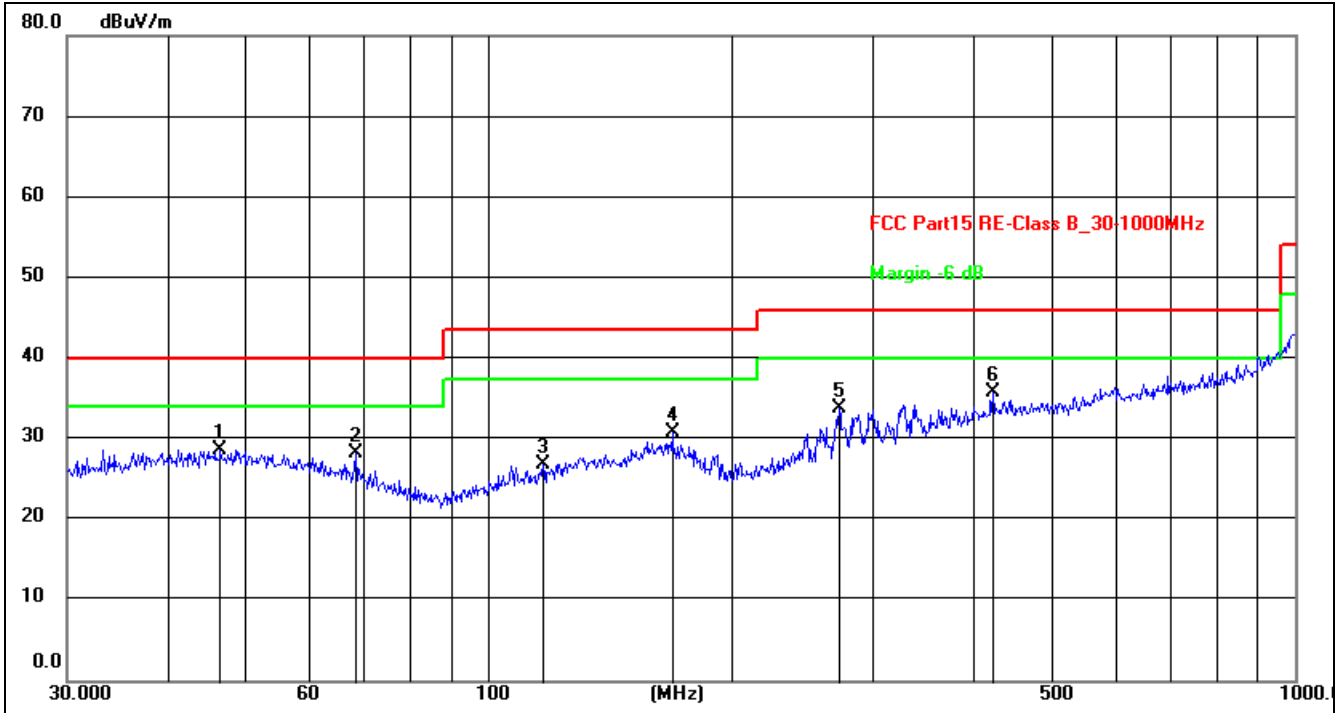

Site:	966 LAB	Antenna::Horizontal	Temperature(C):24(C)
Limit:	FCC Part15 RE-Class B_30-1000MHz		Humidity(%):60%
EUT:	Wireless earbuds	Test Time:	2023/11/10 11:39:32
M/N.:	G306	Power Rating:	Battery DC 3.7V
Mode:	Working	Test Engineer:	Cody_dai
Note:	GFSK DH5 mode		

No.	Frequency (MHz)	Reading (dBuV)	Factor (dB/m)	Level (dBuV/m)	Limit (dBuV/m)	Margin (dB)	Det.	Height (cm)	Azimuth (deg)	Remark
1	46.5030	14.50	14.28	28.78	40.00	-11.22	peak	200	236	
2	68.3908	16.92	11.40	28.32	40.00	-11.68	peak	200	253	
3	116.9494	14.70	12.23	26.93	43.50	-16.57	peak	200	305	
4	169.0053	16.21	14.56	30.77	43.50	-12.73	peak	200	271	
5	272.2776	19.97	13.85	33.82	46.00	-12.18	peak	100	343	
6*	422.0577	18.48	17.35	35.83	46.00	-10.17	peak	200	308	

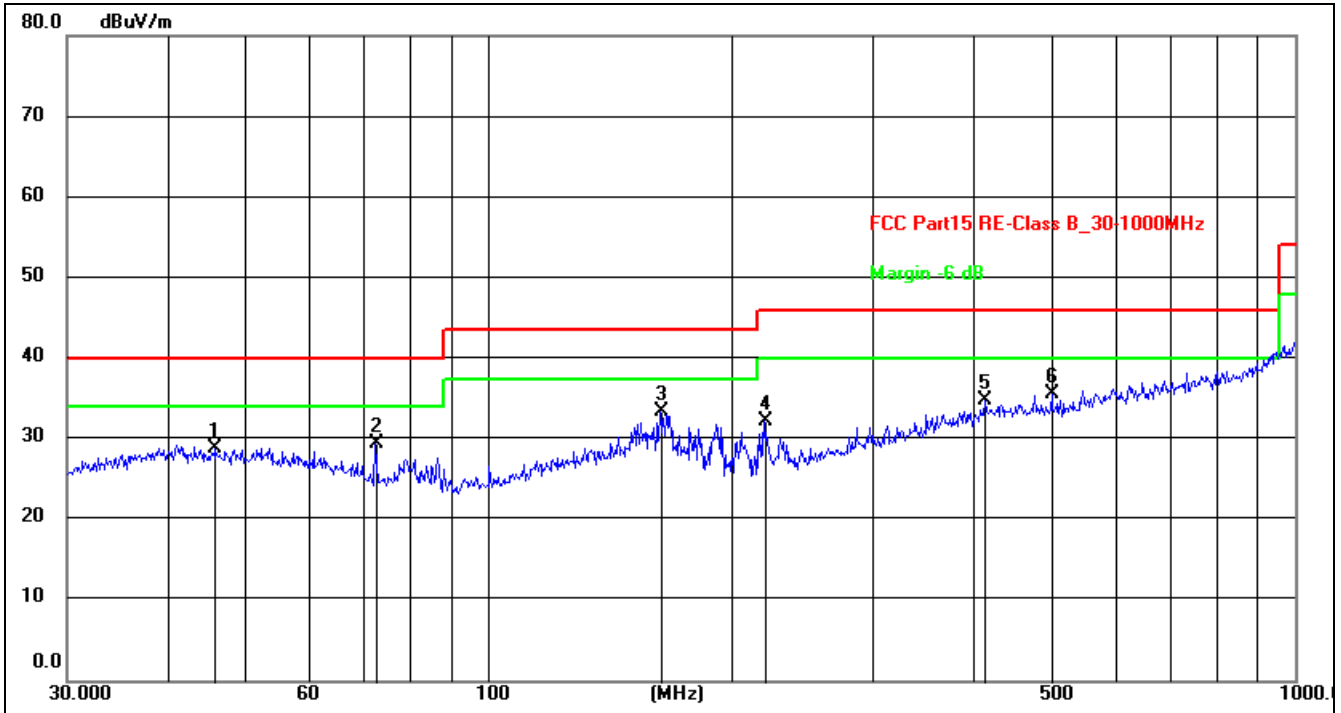

Site:	966 LAB	Antenna::Vertical	Temperature(C):24(C)
Limit:	FCC Part15 RE-Class B_30-1000MHz		Humidity(%):60%
EUT:	Wireless earbuds	Test Time:	2023/11/10 11:42:07
M/N.:	G306	Power Rating:	Battery DC 3.7V
Mode:	Working	Test Engineer:	Cody_dai
Note:	GFSK DH5 mode		

No.	Frequency (MHz)	Reading (dBuV)	Factor (dB/m)	Level (dBuV/m)	Limit (dBuV/m)	Margin (dB)	Det.	Height (cm)	Azimuth (deg)	Remark
1	45.8553	14.54	14.34	28.88	40.00	-11.12	peak	200	127	
2	72.3376	18.20	11.30	29.50	40.00	-10.50	peak	100	125	
3*	163.1818	18.30	15.16	33.46	43.50	-10.04	peak	100	254	
4	219.8449	20.17	12.14	32.31	46.00	-13.69	peak	100	336	
5	413.2706	17.66	17.12	34.78	46.00	-11.22	peak	100	0	
6	499.4247	16.91	18.73	35.64	46.00	-10.36	peak	200	3	

For 1GHz to 25GHz

Note: 1. GFSK, Pi/4 DQPSK and 8DPSK all have been tested, only worse case GFSK is reported.
 2. 8~25GHz at least have 20dB margin. No recording in the test report.

GFSK (above 1GHz)

Frequency(MHz):			2402		Polarity:			HORIZONTAL	
Frequency (MHz)	Emission Level (dBuV/m)		Limit (dBuV/m)	Margin (dB)	Raw Value (dBuV)	Antenna Factor (dB/m)	Cable Factor (dB)	Pre-amplifier (dB)	Correction Factor (dB/m)
4804.00	51.25	PK	74.00	22.75	46.74	33.49	6.91	35.89	4.51
4804.00	42.83	AV	54.00	11.17	38.32	33.49	6.91	35.89	4.51
5020.00	49.52	PK	74.00	24.48	42.66	34.06	7.04	34.24	6.86
5020.00	--	AV	54.00	--	--	--	--	--	--
7206.00	47.25	PK	74.00	26.75	36.15	36.95	9.18	35.03	11.10
7206.00	--	AV	54.00	--	--	--	--	--	--

Frequency(MHz):			2402		Polarity:			VERTICAL	
Frequency (MHz)	Emission Level (dBuV/m)		Limit (dBuV/m)	Margin (dB)	Raw Value (dBuV)	Antenna Factor (dB/m)	Cable Factor (dB)	Pre-amplifier (dB)	Correction Factor (dB/m)
4804.00	51.74	PK	74.00	22.26	47.23	33.49	6.91	35.89	4.51
4804.00	46.82	AV	54.00	7.18	42.31	33.49	6.91	35.89	4.51
5128.00	49.25	PK	74.00	24.75	42.39	34.06	7.04	34.24	6.86
5128.00	--	AV	54.00	--	--	--	--	--	--
7206.00	44.2	PK	74.00	29.8	33.10	36.95	9.18	35.03	11.10
7206.00	--	AV	54.00	--	--	--	--	--	--

Frequency(MHz):			2441		Polarity:			HORIZONTAL	
Frequency (MHz)	Emission Level (dBuV/m)		Limit (dBuV/m)	Margin (dB)	Raw Value (dBuV)	Antenna Factor (dB/m)	Cable Factor (dB)	Pre-amplifier (dB)	Correction Factor (dB/m)
4882.00	46.25	PK	74.00	27.75	39.89	33.60	6.95	34.19	6.36
4882.00	41.45	AV	54.00	12.55	35.09	33.60	6.95	34.19	6.36
5369.00	45.41	PK	74.00	28.59	37.81	34.56	7.15	34.11	7.60
5369.00	--	AV	54.00	--	--	--	--	--	--
7323.00	43.28	PK	74.00	30.72	31.58	37.46	9.23	35.00	11.70
7323.00	--	AV	54.00	--	--	--	--	--	--

Frequency(MHz):			2441		Polarity:			VERTICAL	
Frequency (MHz)	Emission Level (dBuV/m)		Limit (dBuV/m)	Margin (dB)	Raw Value (dBuV)	Antenna Factor (dB/m)	Cable Factor (dB)	Pre-amplifier (dB)	Correction Factor (dB/m)
4882.00	56.63	PK	74.00	17.37	50.27	33.60	6.95	34.19	6.36
4882.00	46.42	AV	54.00	7.58	40.06	33.60	6.95	34.19	6.36
5450.00	44.62	PK	74.00	29.38	37.02	34.56	7.15	34.11	7.60
5450.00	--	AV	54.00	--	--	--	--	--	--
7323.00	44.26	PK	74.00	29.74	32.56	37.46	9.23	35.00	11.70
7323.00	--	AV	54.00	--	--	--	--	--	--

Frequency(MHz):			2480		Polarity:			HORIZONTAL	
Frequency (MHz)	Emission Level (dBuV/m)		Limit (dBuV/m)	Margin (dB)	Raw Value (dBuV)	Antenna Factor (dB/m)	Cable Factor (dB)	Pre-amplifier (dB)	Correction Factor (dB/m)
4960.00	56.02	PK	74.00	17.98	51.1	33.84	7.00	35.92	4.92
4960.00	48.62	AV	54.00	5.38	43.70	33.84	7.00	35.92	4.92
5998.00	44.96	PK	74.00	29.04	37.68	34.45	7.12	34.29	7.28
5998.00	--	AV	54.00	--	--	--	--	--	--
7440.00	47.26	PK	74.00	26.74	35.31	37.64	9.28	34.97	11.95
7440.00	--	AV	54.00	--	--	--	--	--	--

Frequency(MHz):			2480		Polarity:			VERTICAL	
Frequency (MHz)	Emission Level (dBuV/m)		Limit (dBuV/m)	Margin (dB)	Raw Value (dBuV)	Antenna Factor (dB/m)	Cable Factor (dB)	Pre-amplifier (dB)	Correction Factor (dB/m)
4960.00	57.62	PK	74.00	16.38	52.7	33.84	7.00	35.92	4.92
4960.00	47.19	AV	54.00	6.81	42.27	33.84	7.00	35.92	4.92
5650.00	43.94	PK	74.00	30.06	36.66	34.45	7.12	34.29	7.28
5650.00	--	AV	54.00	--	--	--	--	--	--
7440.00	42.62	PK	74.00	31.38	30.67	37.64	9.28	34.97	11.95
7440.00	--	AV	54.00	--	--	--	--	--	--

REMARKS:

- (1) Emission level (dBuV/m) =Raw Value (dBuV)+Correction Factor (dB/m)
- (2) Correction Factor (dB/m) = Antenna Factor (dB/m)+Cable Factor (dB)-Pre-amplifier Factor
- (3) Margin value = Limit value- Emission level.
- (4) -- Mean the PK detector measured value is below average limit.
- (5) The other emission levels were very low against the limit.
- (6) RBW1MHz VBW3MHz Peak detector is for PK value; RBW 1MHz VBW10Hz Peak detector is for AV value.

Results of Band Edges Test (Radiated)

Note: All modulations have been tested, only worse case GFSK is reported.

Frequency(MHz):			2402		Polarity:			HORIZONTAL	
Frequency (MHz)	Emission Level (dBuV/m)		Limit (dBuV/m)	Margin (dB)	Raw Value (dBuV)	Antenna Factor (dB/m)	Cable Factor (dB)	Pre-amplifier (dB)	Correction Factor (dB/m)
2402.00	108.52	PK	--	--	75.13	28.78	4.61	0	33.39
2402.00	99.22	AV	--	--	65.83	28.78	4.61	0	33.39
2355.00	52.62	PK	74.00	21.38	19.54	28.52	4.56	0	33.08
2355.00	--	AV	54.00	--	--	--	--	--	--
2390.00	47.62	PK	74.00	26.38	14.3	28.72	4.60	0	33.32
2390.00	--	AV	54.00	--	--	--	--	--	--
2400.00	53.52	PK	74.00	20.48	20.13	28.78	4.61	0	33.39
2400.00	--	AV	54.00	--	--	--	--	--	--

Frequency(MHz):			2402		Polarity:			VERTICAL	
Frequency (MHz)	Emission Level (dBuV/m)		Limit (dBuV/m)	Margin (dB)	Raw Value (dBuV)	Antenna Factor (dB/m)	Cable Factor (dB)	Pre-amplifier (dB)	Correction Factor (dB/m)
2402.00	104.15	PK	--	--	70.76	28.78	4.61	0	33.39
2402.00	95.62	AV	--	--	62.23	28.78	4.61	0	33.39
2378.00	48.62	PK	74.00	25.38	15.54	28.52	4.56	0	33.08
2378.00	--	AV	54.00	--	--	--	--	--	--
2390.00	44.62	PK	74.00	29.38	11.3	28.72	4.60	0	33.32
2390.00	--	AV	54.00	--	--	--	--	--	--
2400.00	48.62	PK	74.00	25.38	15.23	28.78	4.61	0	33.39
2400.00	--	AV	54.00	--	--	--	--	--	--

Frequency(MHz):			2480		Polarity:			HORIZONTAL	
Frequency (MHz)	Emission Level (dBuV/m)		Limit (dBuV/m)	Margin (dB)	Raw Value (dBuV)	Antenna Factor (dB/m)	Cable Factor (dB)	Pre-amplifier (dB)	Correction Factor (dB/m)
2480.00	100.65	PK	--	--	67.03	28.92	4.70	0.00	33.62
2480.00	91.75	AV	--	--	58.13	28.92	4.70	0.00	33.62
2483.50	50.36	PK	74.00	23.64	16.73	28.93	4.70	0.00	33.63
2483.50	--	AV	54.00	--	--	--	--	--	--
2485.00	46.75	PK	74.00	27.25	13.09	28.95	4.71	0.00	33.66
2485.00	--	AV	54.00	--	--	--	--	--	--
2500.00	43.69	PK	74.00	30.31	10.01	28.96	4.72	0.00	33.68
2500.00	--	AV	54.00	--	--	--	--	--	--

Frequency(MHz):			2480		Polarity:			VERTICAL	
Frequency (MHz)	Emission Level (dBuV/m)		Limit (dBuV/m)	Margin (dB)	Raw Value (dBuV)	Antenna Factor (dB/m)	Cable Factor (dB)	Pre-amplifier (dB)	Correction Factor (dB/m)
2480.00	103.62	PK	--	--	70	28.92	4.70	0.00	33.62
2480.00	94.68	AV	--	--	61.06	28.92	4.70	0.00	33.62
2483.50	52.63	PK	74.00	21.37	19	28.93	4.70	0.00	33.63
2483.50	--	AV	54.00	--	--	--	--	--	--
2489.00	48.36	PK	74.00	25.64	14.7	28.95	4.71	0.00	33.66
2489.00	--	AV	54.00	--	--	--	--	--	--
2500.00	49.45	PK	74.00	24.55	15.77	28.96	4.72	0.00	33.68
2500.00	--	AV	54.00	--	--	--	--	--	--

REMARKS:

- (1) Emission level (dBuV/m) =Raw Value (dBuV)+Correction Factor (dB/m)
- (2) Correction Factor (dB/m) = Antenna Factor (dB/m)+Cable Factor (dB)-Pre-amplifier Factor
- (3) Margin value = Limit value- Emission level.
- (4) -- Mean the PK detector measured value is below average limit.
- (5) The other emission levels were very low against the limit.
- (6) RBW1MHz VBW3MHz Peak detector is for PK value; RBW 1MHz VBW10Hz Peak detector is for AV value.
- (7) For fundamental frequency, RBW 3MHz VBW 3MHz Peak detector is for PK Value; RMS detector is for AV value.

5. Maximum Peak Output Power

5.1. Applied procedures / Limit

15.247(a) (1) Frequency hopping systems shall have hopping channel carrier frequencies separated by a minimum of 25 kHz or the 20 dB bandwidth of the hopping channel, whichever is greater. Alternatively, frequency hopping systems operating in the 2400–2483.5 MHz band may have hopping channel carrier frequencies that are separated by 25 kHz or two-thirds of the 20 dB bandwidth of the hopping channel, whichever is greater, provided the systems operate with an output power no greater than 125 mW.

15.247(b) (1) For frequency hopping systems operating in the 2400-2483.5 MHz band employing at least 75 non-overlapping hopping channels, and all frequency hopping systems in the 5725-5850 MHz band: 1watt. For all other frequency hopping systems in the 2400-2483.5 MHz band: 0.125 watts.

5.2. Test procedure

- (1) Connected the antenna port to the Spectrum Analyzer, set the Spectrum Analyzer as Span = approximately 5 times the 20 dB bandwidth, centered on a hopping channel
RBW > the 20 dB bandwidth of the emission being measured, VBW ≥ RBW, Sweep = auto
Detector function = peak, Trace = max hold
- (2) The EUT should be transmitting at its maximum data rate. Allow the trace to stabilize. Use the marker-to-peak function to set the marker to the peak of the emission. The indicated level is the peak output power.
- (3) The above procedure shall be repeated at the lowest, the middle, and the highest frequency of the stated frequency range with modulated mode. Also shall be performed at different modes of operation.

5.3. Deviation from standard

No deviation.

5.4. Test setup



5.5. TEST RESULTS

Condition	Mode	Frequency (MHz)	Antenna	Conducted Power (dBm)	Duty Factor (dB)	Total Power (dBm)	Limit (dBm)	Verdict
NVNT	1-DH5	2402	Ant 1	4.423	0	4.423	21	Pass
NVNT	1-DH5	2441	Ant 1	3.993	0	3.993	21	Pass
NVNT	1-DH5	2480	Ant 1	3.040	0	3.040	21	Pass

Power NVNT 1-DH5 2402MHz Ant1

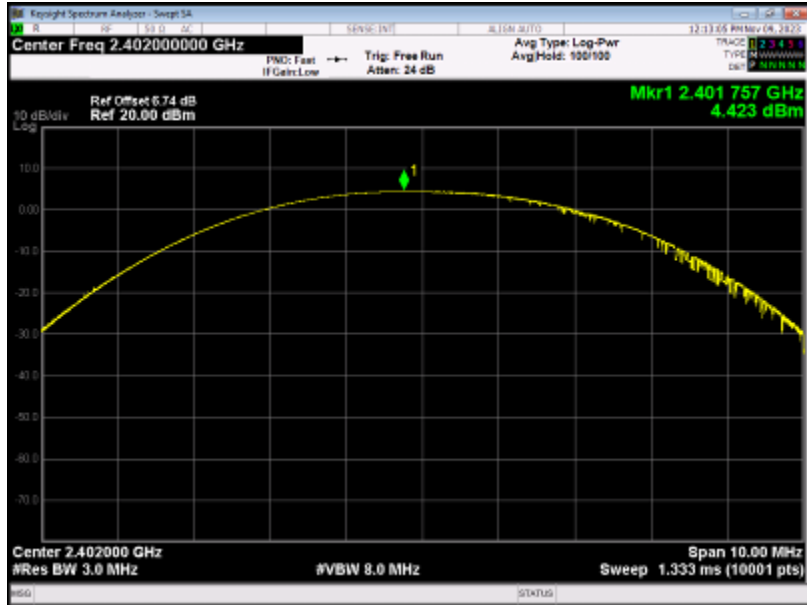

Power NVNT 1-DH5 2441MHz Ant1

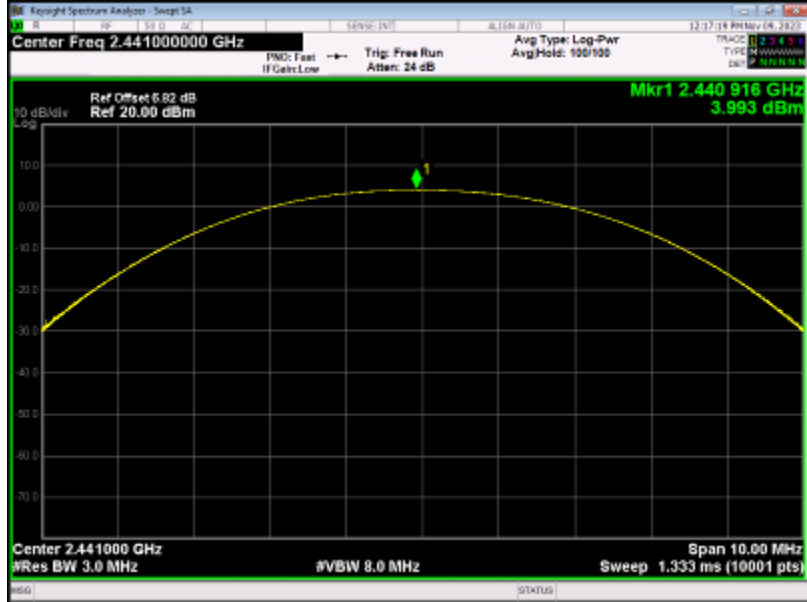

Power NVNT 1-DH5 2480MHz Ant1

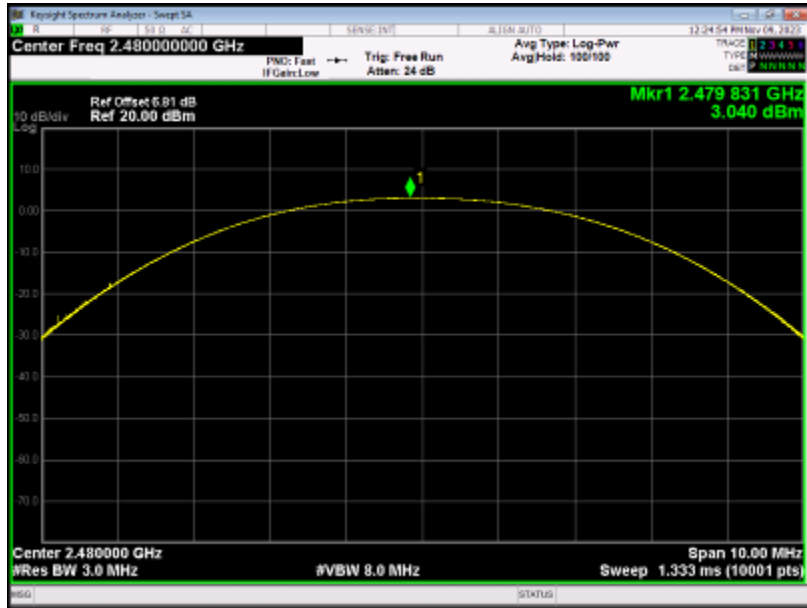

Condition	Mode	Frequency (MHz)	Antenna	Conducted Power (dBm)	Duty Factor (dB)	Total Power (dBm)	Limit (dBm)	Verdict
NVNT	2-DH5	2402	Ant 1	5.306	0	5.306	21	Pass
NVNT	2-DH5	2441	Ant 1	4.806	0	4.806	21	Pass
NVNT	2-DH5	2480	Ant 1	3.857	0	3.857	21	Pass

Power NVNT 2-DH5 2402MHz Ant1

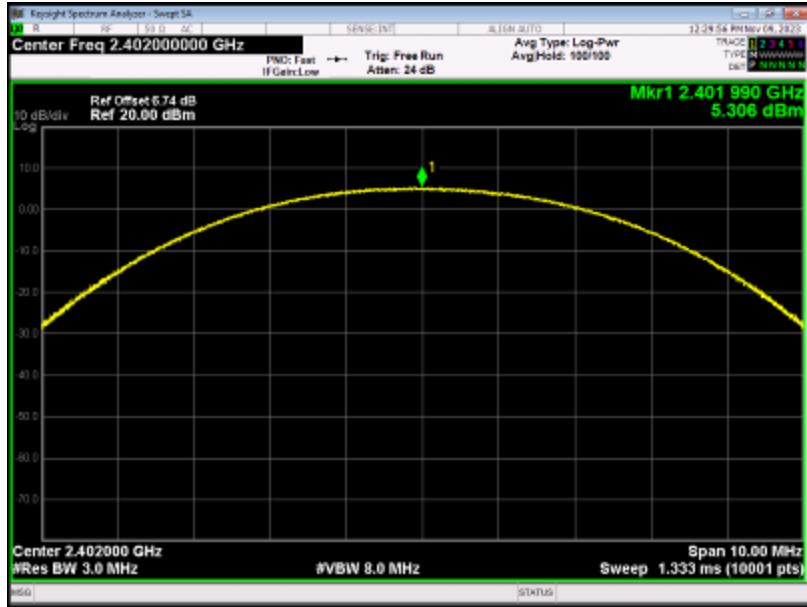

Power NVNT 2-DH5 2441MHz Ant1

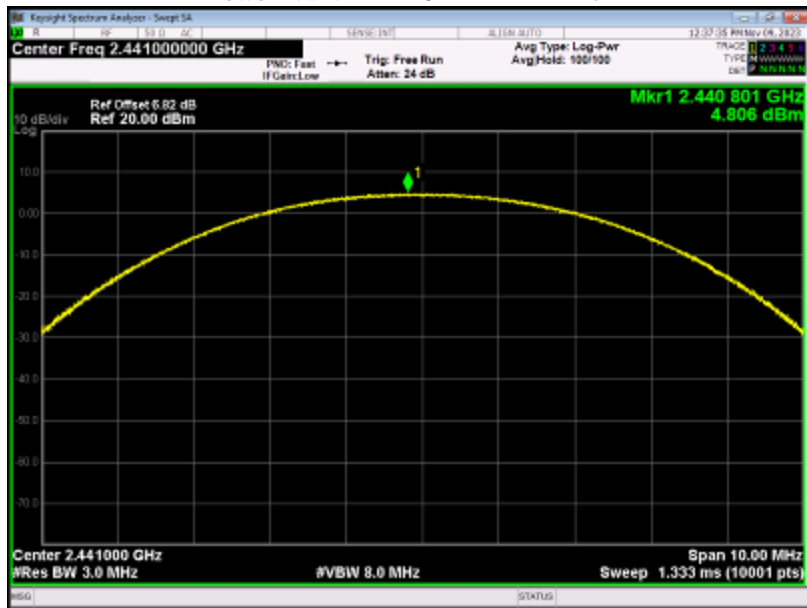

Power NVNT 2-DH5 2480MHz Ant1

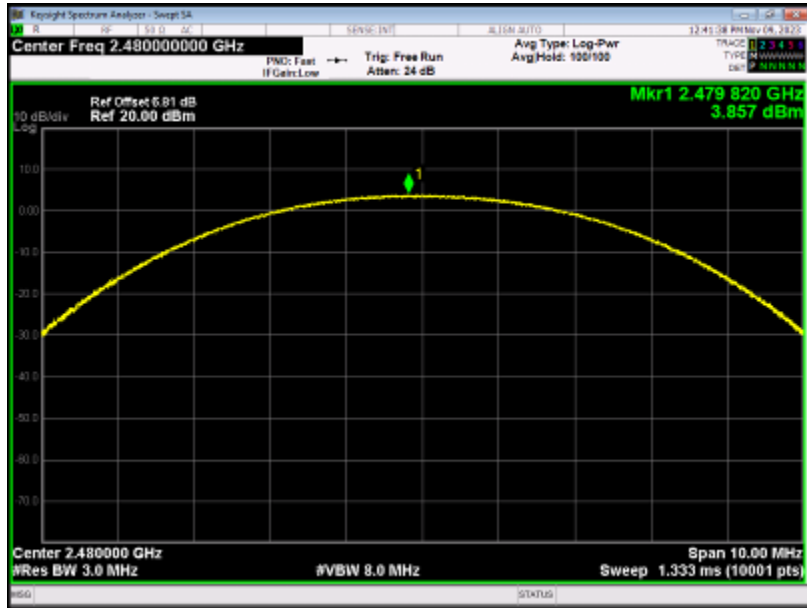

Condition	Mode	Frequency (MHz)	Antenna	Conducted Power (dBm)	Duty Factor (dB)	Total Power (dBm)	Limit (dBm)	Verdict
NVNT	3-DH5	2402	Ant 1	5.964	0	5.964	21	Pass
NVNT	3-DH5	2441	Ant 1	5.49	0	5.49	21	Pass
NVNT	3-DH5	2480	Ant 1	4.567	0	4.567	21	Pass

Power NVNT 3-DH5 2402MHz Ant1

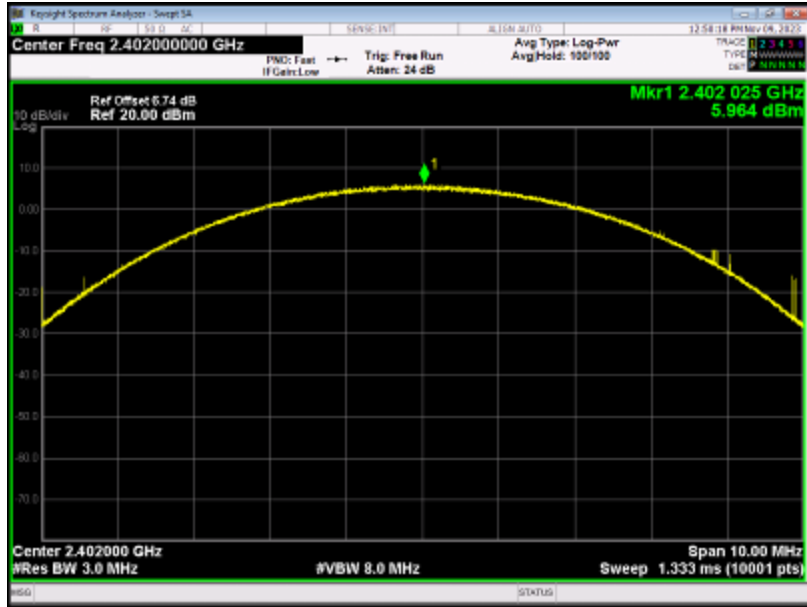

Power NVNT 3-DH5 2441MHz Ant1

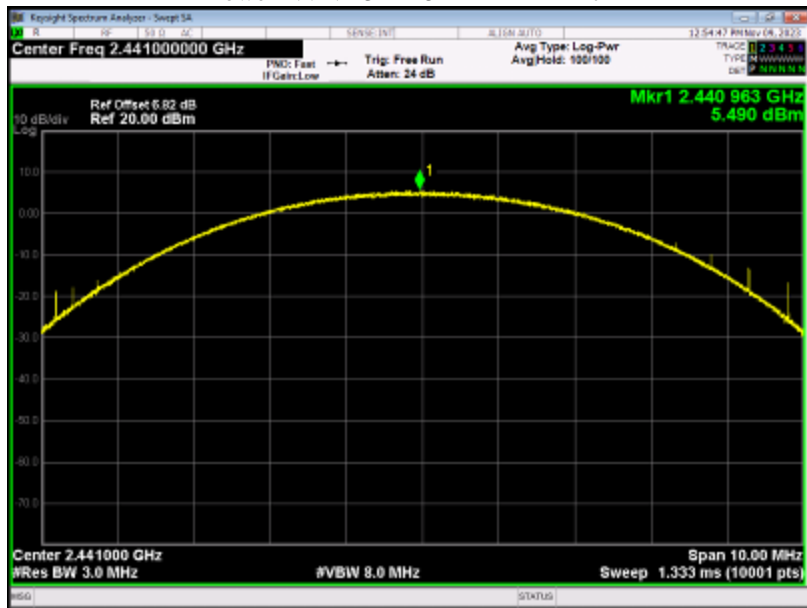

Power NVNT 3-DH5 2480MHz Ant1

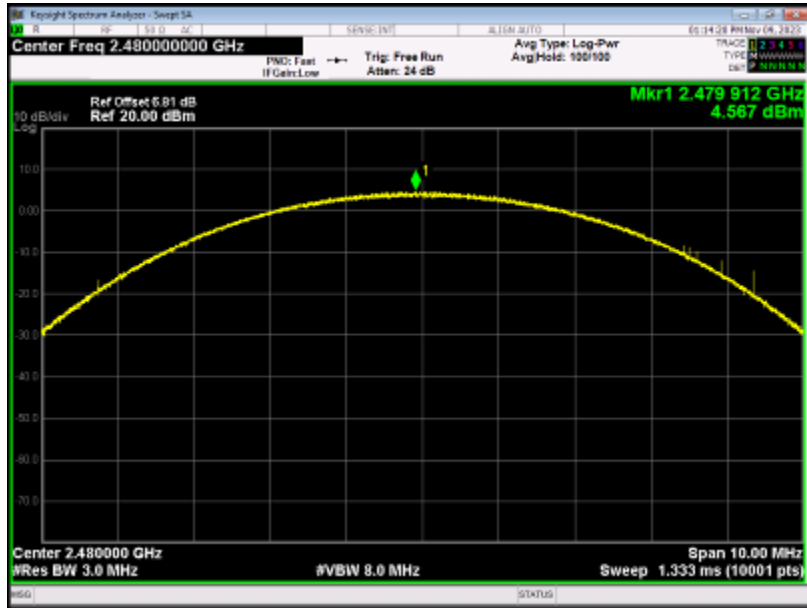

6. BANDWIDTH TEST

6.1. Applied procedures / Limit

For frequency hopping system operating in the 2400-2483.5MHz, If the 20dB bandwidth of hopping channel is greater than 25kHz, two-thirds 20dB bandwidth of hopping channel shall be a minimum limit for the hopping channel separation.

6.2. Test procedure

- a. The EUT was directly connected to the spectrum analyzer and antenna output port as show in the block diagram below.
- b. Span = approximately 2 to 3 times the 20 dB bandwidth, centered on a hopping channel
RBW \geq 1% of the 20 dB bandwidth, VBW \geq RBW, Sweep = auto, Detector function = peak
Trace = max hold

6.3. Deviation from standard

No deviation.

6.4. Test setup

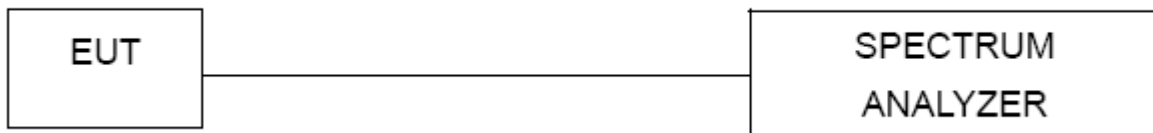

6.5. Test results

Condition	Mode	Frequency (MHz)	Antenna	99% OBW (MHz)	-20 dB Bandwidth (MHz)	Limit -20 dB Bandwidth (MHz)	Verdict
NVNT	1-DH5	2402	Ant 1	0.7544	0.7192	0	Pass
NVNT	1-DH5	2441	Ant 1	0.8643	0.9356	0	Pass
NVNT	1-DH5	2480	Ant 1	0.8767	0.955	0	Pass

OBW NVNT 1-DH5 2402MHz Ant1

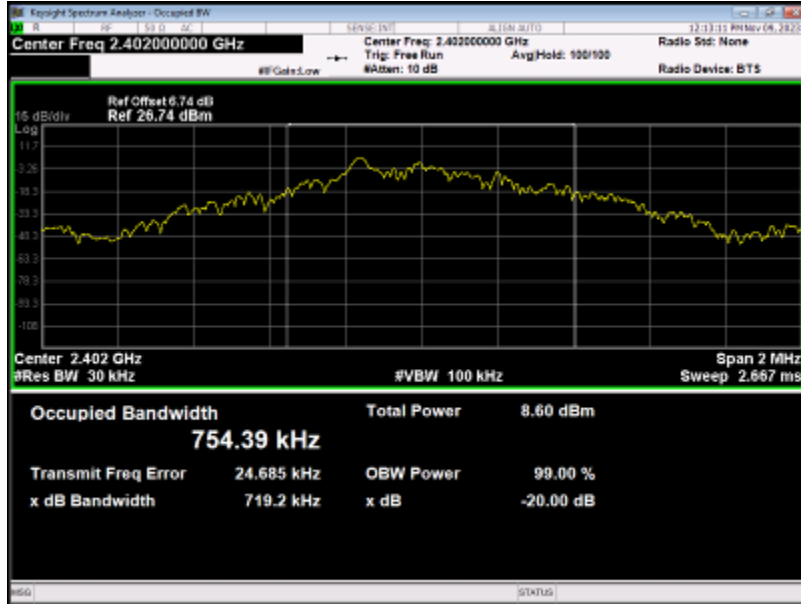

OBW NVNT 1-DH5 2441MHz Ant1

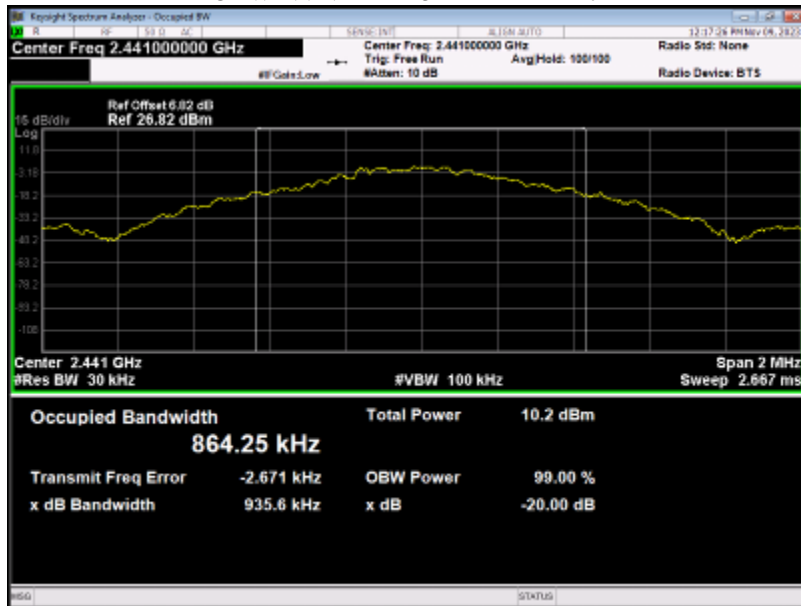

OBW NVNT 1-DH5 2480MHz Ant1

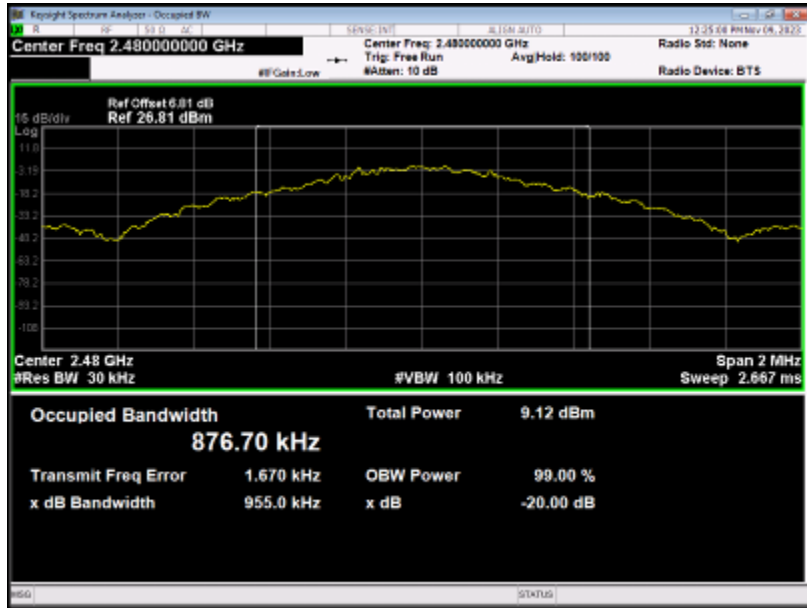

Condition	Mode	Frequency (MHz)	Antenna	99% OBW (MHz)	-20 dB Bandwidth (MHz)	Limit -20 dB Bandwidth (MHz)	Verdict
NVNT	2-DH5	2402	Ant 1	1.1673	1.2754	0	Pass
NVNT	2-DH5	2441	Ant 1	1.1738	1.2806	0	Pass
NVNT	2-DH5	2480	Ant 1	1.1654	1.2802	0	Pass

OBW NVNT 2-DH5 2402MHz Ant1

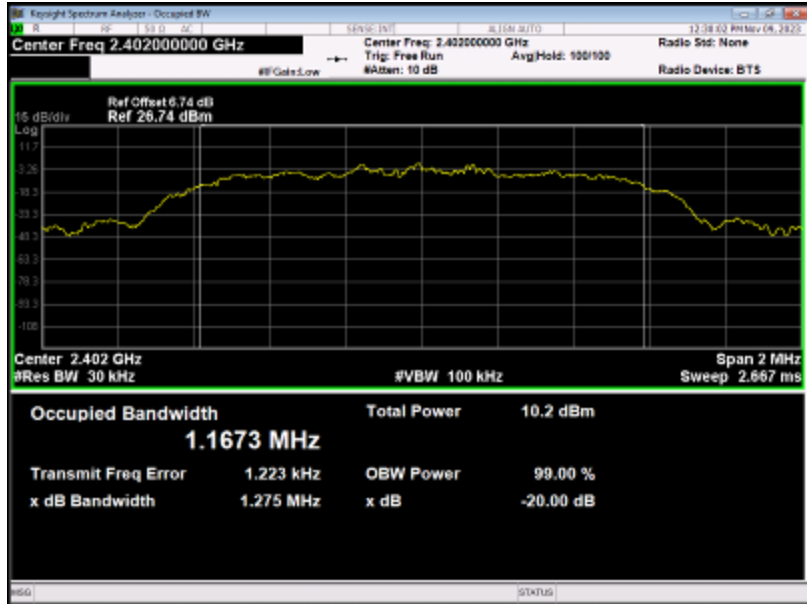

OBW NVNT 2-DH5 2441MHz Ant1

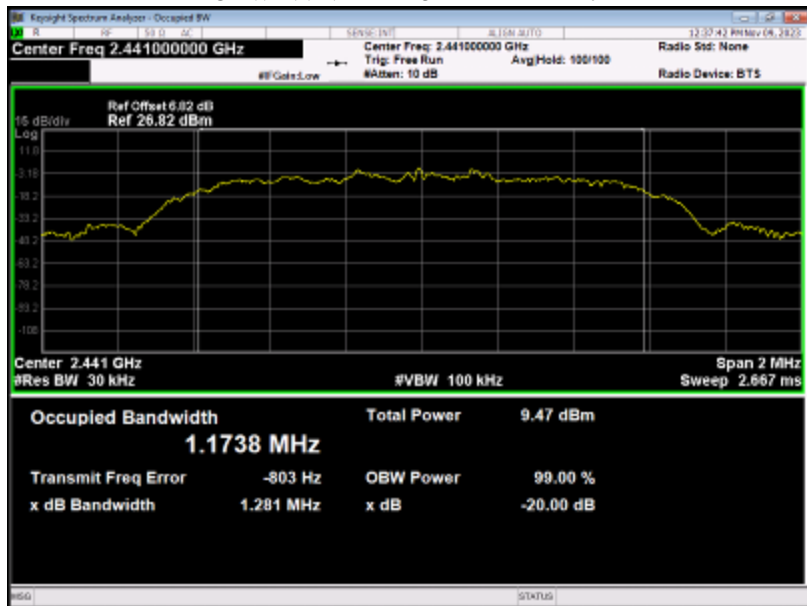

OBW NVNT 2-DH5 2480MHz Ant1

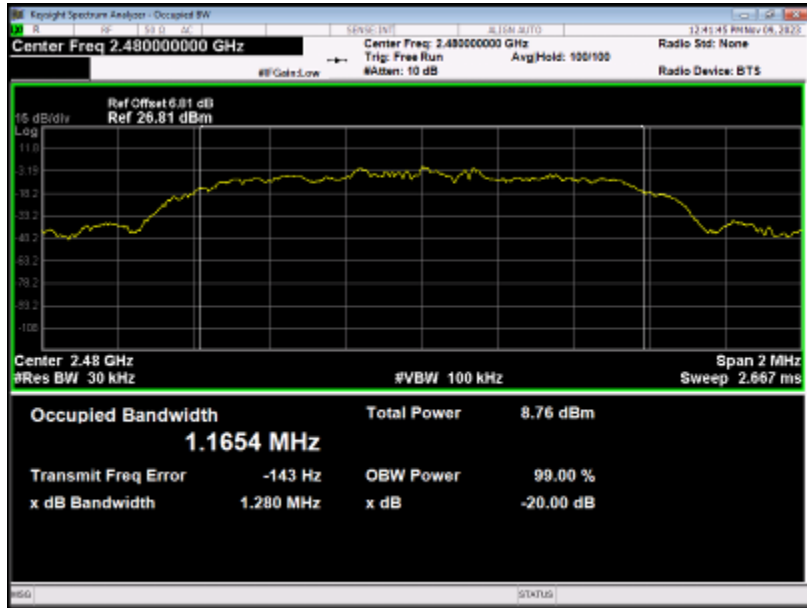

Condition	Mode	Frequency (MHz)	Antenna	99% OBW (MHz)	-20 dB Bandwidth (MHz)	Limit -20 dB Bandwidth (MHz)	Verdict
NVNT	3-DH5	2402	Ant 1	1.1713	1.2784	0	Pass
NVNT	3-DH5	2441	Ant 1	1.1906	1.3181	0	Pass
NVNT	3-DH5	2480	Ant 1	1.1844	1.2926	0	Pass

OBW NVNT 3-DH5 2402MHz Ant1

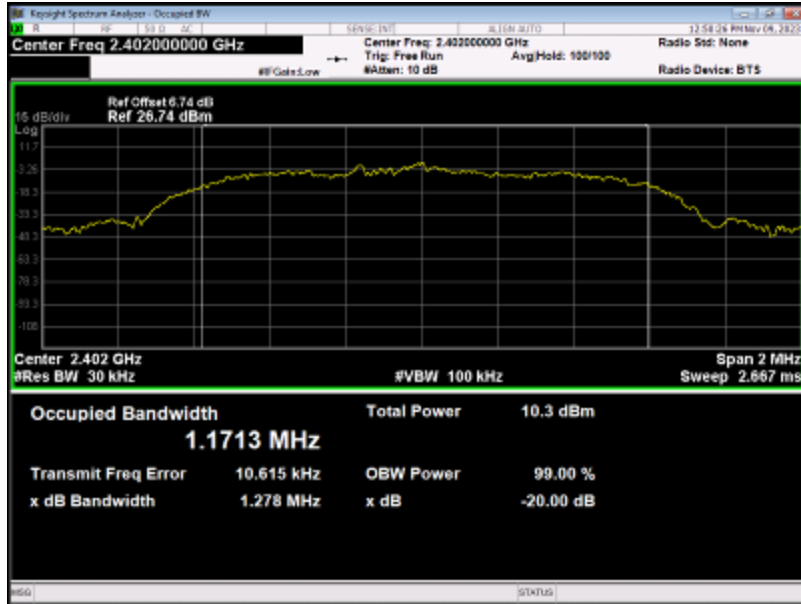

OBW NVNT 3-DH5 2441MHz Ant1

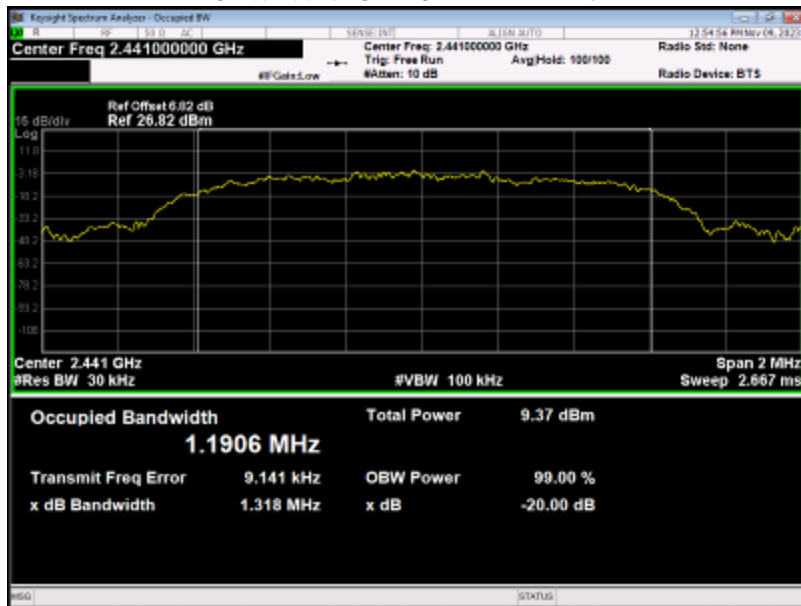

OBW NVNT 3-DH5 2480MHz Ant1

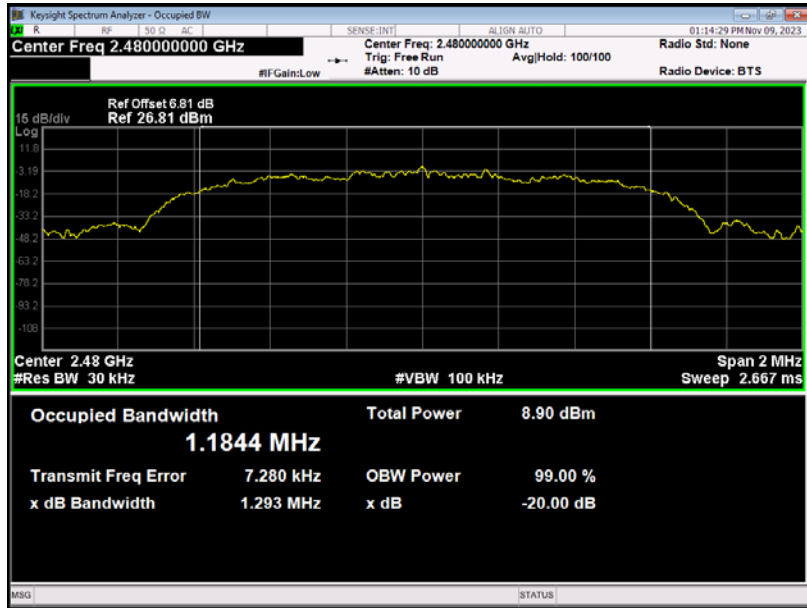

7. Carrier Frequencies Separated

7.1. Applied procedures / Limit

15.247(a) (1) Frequency hopping systems shall have hopping channel carrier frequencies separated by a minimum of 25 kHz or the 20 dB bandwidth of the hopping channel, whichever is greater. Alternatively, frequency hopping systems operating in the 2400-2483.5 MHz band may have hopping channel carrier frequencies that are separated by 25 kHz or two-thirds of the 20 dB bandwidth of the hopping channel, whichever is greater, provided the systems operate with an output power no greater than 125 mW.

7.2. Test procedure

- (1) Connected the antenna port to the Spectrum Analyzer, set the Spectrum Analyzer as
Span = wide enough to capture the peaks of two adjacent channels, Resolution (or IF) Bandwidth (RBW) $\geq 1\%$ of the span, Video (or Average) Bandwidth (VBW) \geq RBW
Sweep = auto, Detector function = peak, Trace = max hold
- (2) The EUT should be transmitting at its maximum data rate. Use the marker-delta function to determine the separation between the peaks of the adjacent channels.
- (3) The above procedure shall be repeated at the lowest, the middle, and the highest frequency of the stated frequency range with modulated mode. also shall be performed at different modes of operation.

7.3. Deviation from standard

No deviation.

7.4. Test setup

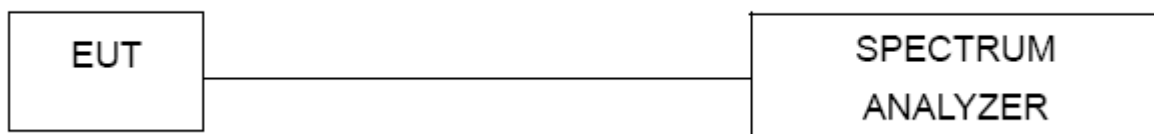

7.5. Test results

Condition	Mode	Hopping Freq1 (MHz)	Hopping Freq2 (MHz)	HFS (MHz)	Limit (MHz)	Verdict
NVNT	1-DH5	2440.999	2442.01	1.011	0.624	Pass

CFS NVNT 1-DH5 2441MHz

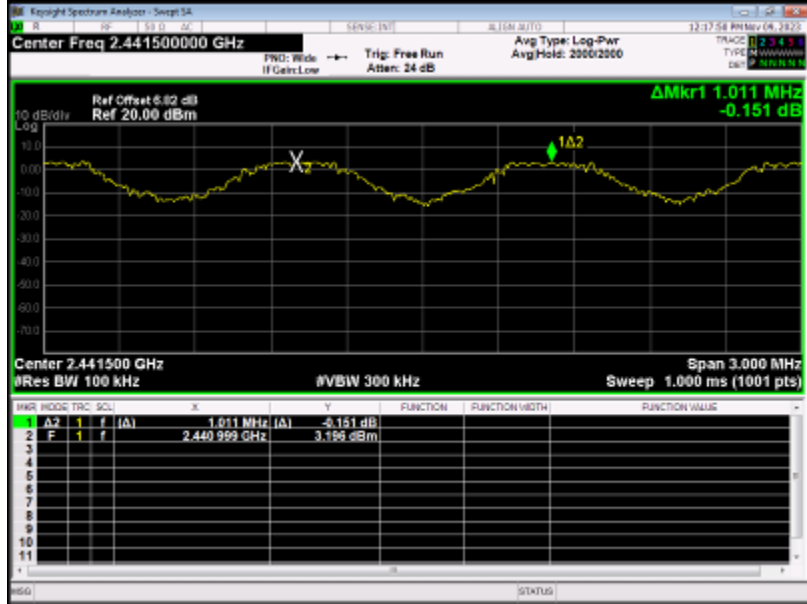

Condition	Mode	Hopping Freq1 (MHz)	Hopping Freq2 (MHz)	HFS (MHz)	Limit (MHz)	Verdict
NVNT	2-DH5	2440.84	2441.968	1.128	0.854	Pass

CFS NVNT 2-DH5 2441MHz



Condition	Mode	Hopping Freq1 (MHz)	Hopping Freq2 (MHz)	HFS (MHz)	Limit (MHz)	Verdict
NVNT	3-DH5	2441.011	2442.166	1.155	0.879	Pass

CFS NVNT 3-DH5 2441MHz

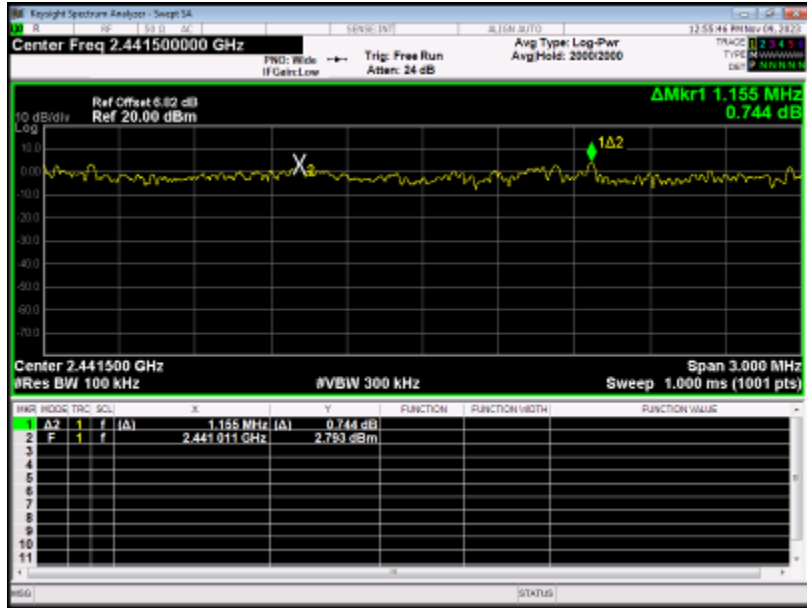

8. Hopping Channel Number

8.1. Applied procedures / Limit

15.247(a) (1) (iii) Frequency hopping systems in the 2400-2483.5 MHz band shall use at least 15 channels. The average time of occupancy on any channel shall not be greater than 0.4 seconds within a period of 0.4 seconds multiplied by the number of hopping channels employed. Frequency hopping systems may avoid or suppress transmissions on a particular hopping frequency provided that a minimum of 15 channels are used.

8.2. Test procedure

- (1) Connected the antenna port to the Spectrum Analyzer , set the Spectrum Analyzer as
Span = the frequency band of operation, RBW \geq 1% of the span, VBW \geq RBW Sweep = auto
Detector function = peak, Trace = max hold
- (2) The EUT should be have its hopping function enabled. Maxhold and record hopping channels
It may prove necessary to break the span up to sections, in order to clearly show all of the hopping frequencies.

8.3. Deviation from standard

No deviation.

8.4. Test setup

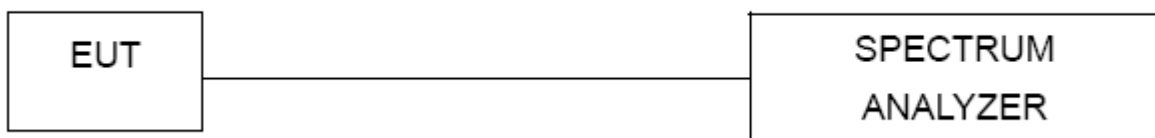

8.5. Test result

Condition	Mode	Hopping Number	Limit	Verdict
NVNT	1-DH5	79	15	Pass
NVNT	1-DH5	79	15	Pass
NVNT	1-DH5	79	15	Pass

Hopping No. NVNT 1-DH5 2402MHz

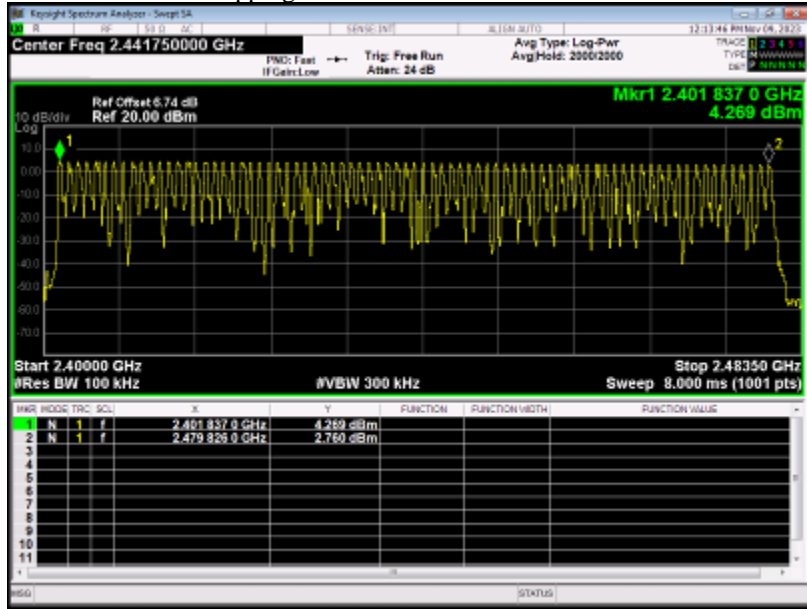

Hopping No. NVNT 1-DH5 2441MHz

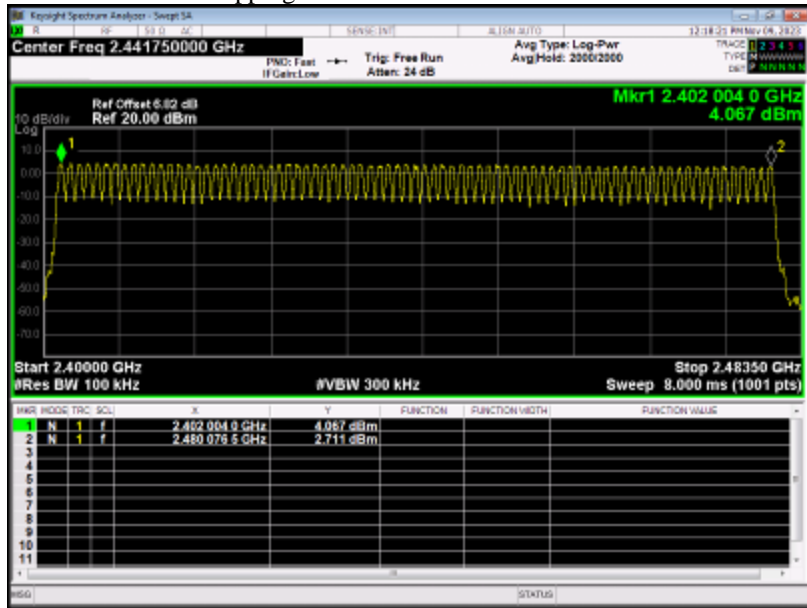

Hopping No. NVNT 1-DH5 2480MHz

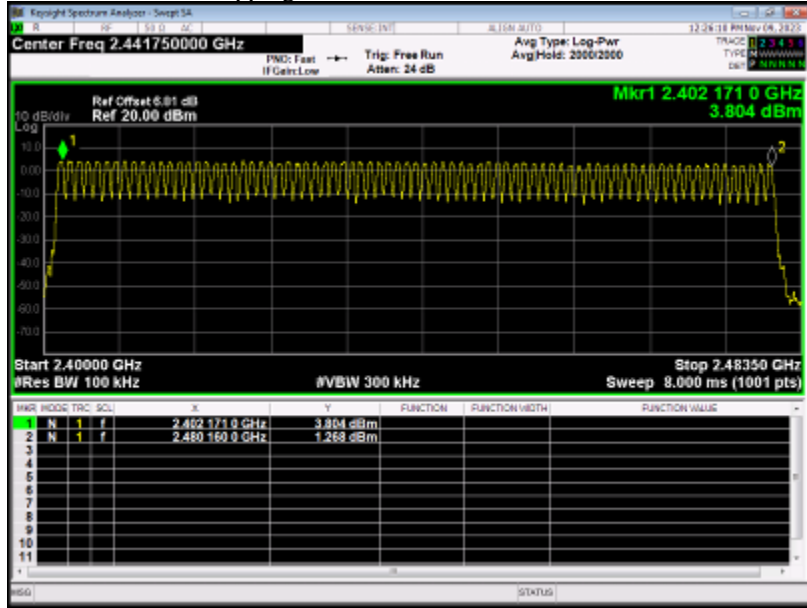

Condition	Mode	Hopping Number	Limit	Verdict
NVNT	2-DH5	79	15	Pass
NVNT	2-DH5	79	15	Pass
NVNT	2-DH5	79	15	Pass

Hopping No. NVNT 2-DH5 2402MHz

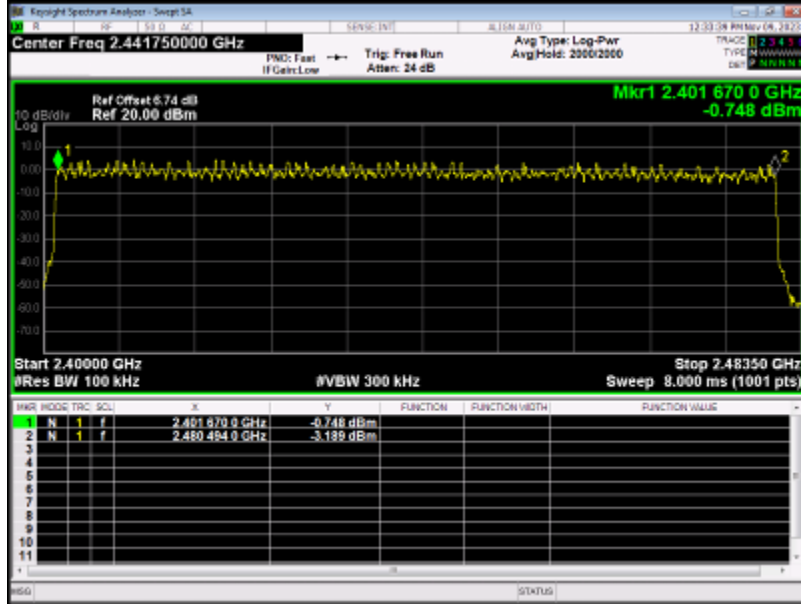

Hopping No. NVNT 2-DH5 2441MHz

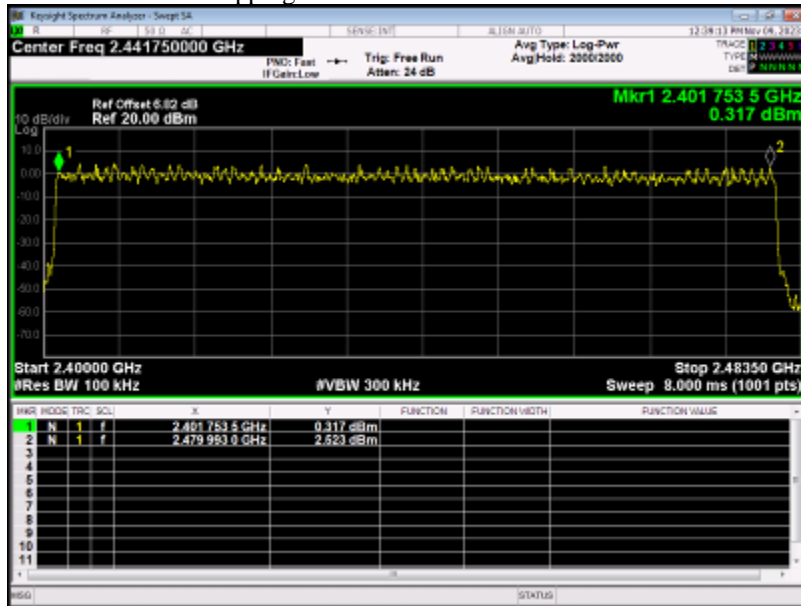

Hopping No. NVNT 2-DH5 2480MHz

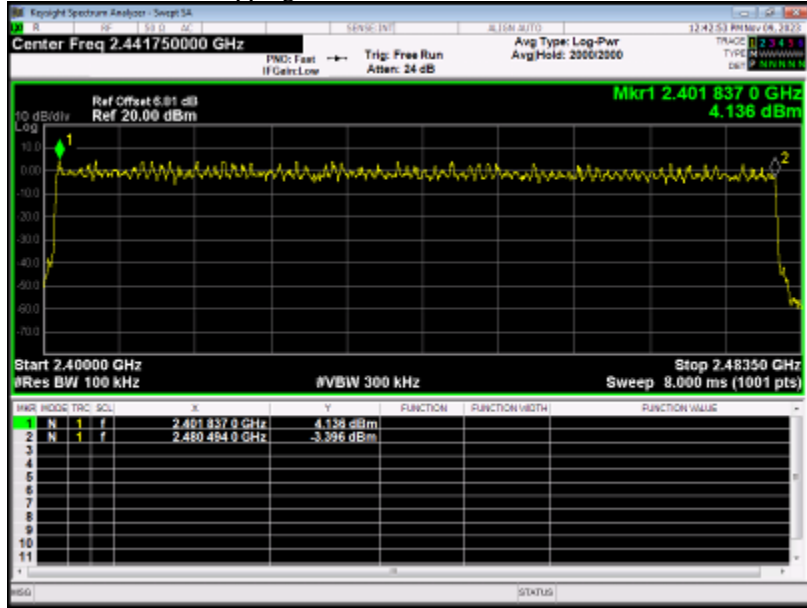

Condition	Mode	Hopping Number	Limit	Verdict
NVNT	3-DH5	79	15	Pass
NVNT	3-DH5	79	15	Pass
NVNT	3-DH5	79	15	Pass

Hopping No. NVNT 3-DH5 2402MHz

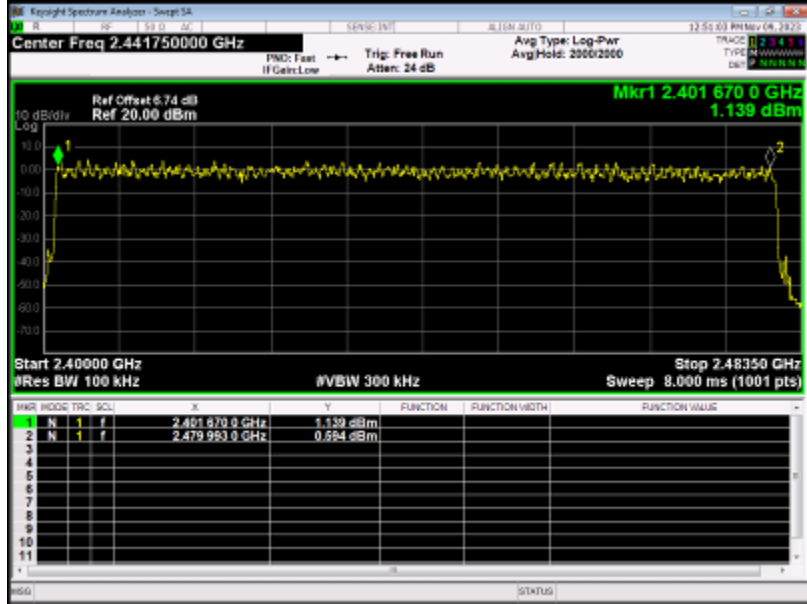

Hopping No. NVNT 3-DH5 2441MHz

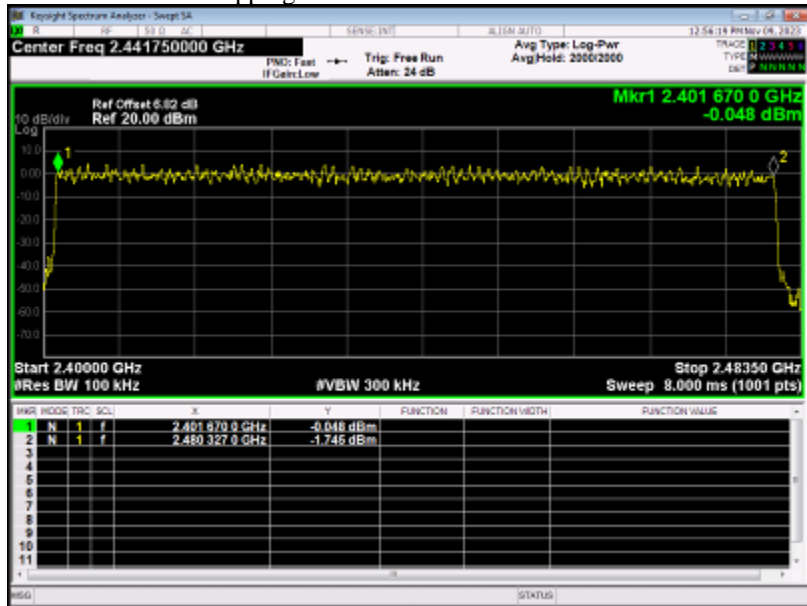

Hopping No. NVNT 3-DH5 2480MHz

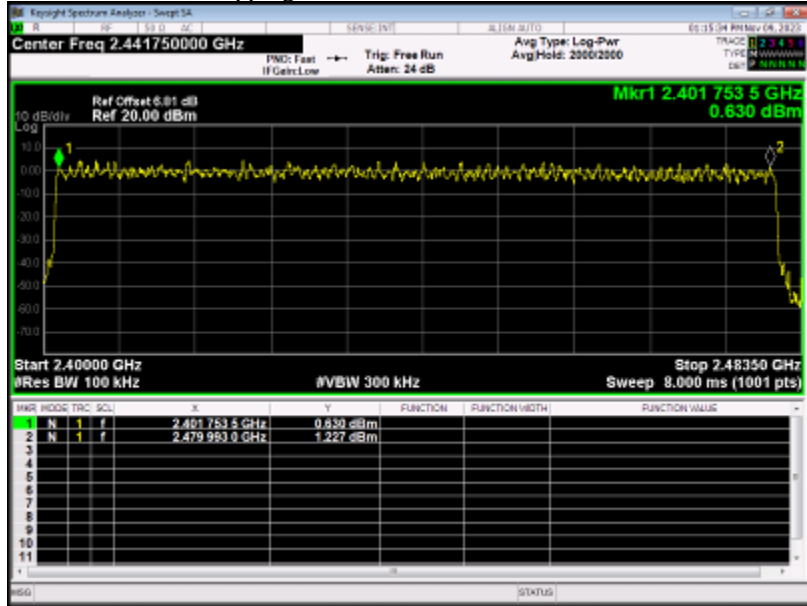

9. Dwell time

9.1. Applied procedures / Limit

15.247(a) (1) (iii) Frequency hopping systems in the 2400-2483.5 MHz band shall use at least 15 channels. The average time of occupancy on any channel shall not be greater than 0.4 seconds within a period of 0.4 seconds multiplied by the number of hopping channels employed. Frequency hopping systems may avoid or suppress transmissions on a particular hopping frequency provided that a minimum of 15 channels are used.

9.2. Test procedure

- (1) Place the EUT on the table in the chamber or connect the antenna port of the EUT to spectrum analyzer and set it in transmitting mode.
- (2) Set RBW of spectrum analyzer to 1MHz, $VBW \geq RBW$
- (3) Use a video trigger with the trigger level set to enable triggering only on full pulses.
- (4) Sweep Time is more than once pulse time.
- (5) Set the center frequency on any frequency would be measure and set the frequency span to zero span.
- (6) Measure the maximum time duration of one single pulse.
- (7) Set the EUT for DH5, DH3 and DH1 packet transmitting.
- (8) Measure the maximum time duration of one single pulse.
- (9) A Period Time = $79 \times 0.4 = 31.6$ S
DH1 Time Slot: Reading * $(1600/2) \times 31.6/79$
DH3 Time Slot: Reading * $(1600/4) \times 31.6/79$
DH5 Time Slot: Reading * $(1600/6) \times 31.6/79$

9.3. Deviation from standard

No deviation.

9.4. Test setup



Test result

Condition	Mode	Frequency (MHz)	Pulse Time (ms)	Total Dwell Time (ms)	Period Time (ms)	Limit (ms)	Verdict
NVNT	1-DH1	2441	0.399	127.68	31600	400	Pass

Dwell NVNT 1-DH1 2441MHz

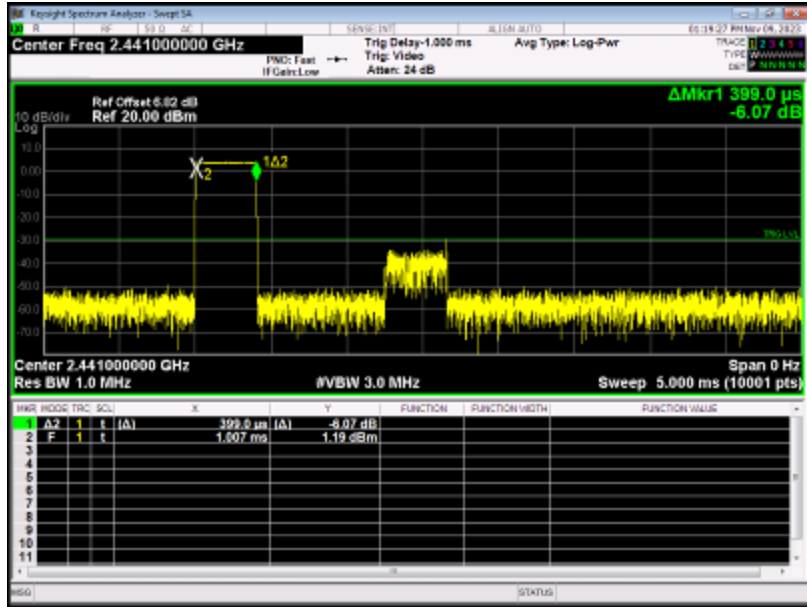

Condition	Mode	Frequency (MHz)	Pulse Time (ms)	Total Dwell Time (ms)	Period Time (ms)	Limit (ms)	Verdict
NVNT	1-DH3	2441	1.654	264.64	31600	400	Pass

Dwell NVNT 1-DH3 2441MHz

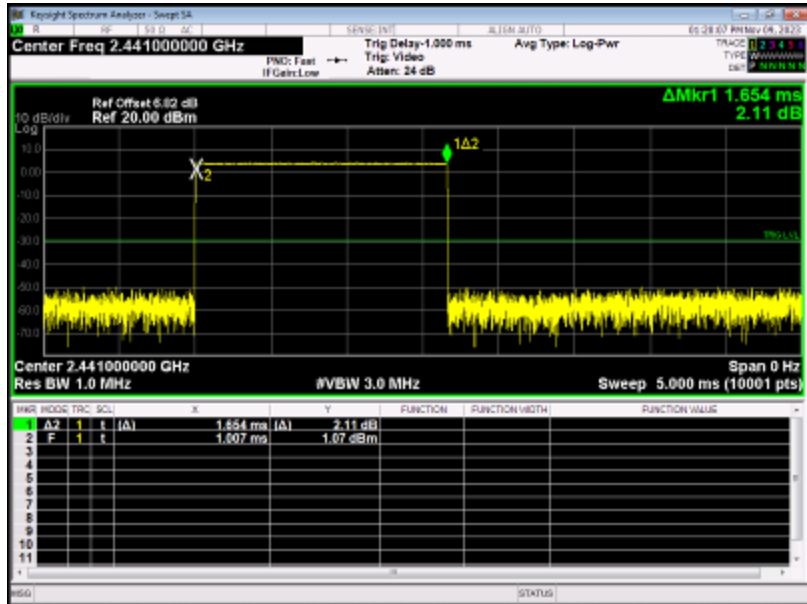

Condition	Mode	Frequency (MHz)	Pulse Time (ms)	Total Dwell Time (ms)	Period Time (ms)	Limit (ms)	Verdict
NVNT	1-DH5	2441	2.883	307.52	31600	400	Pass

Dwell NVNT 1-DH5 2441MHz

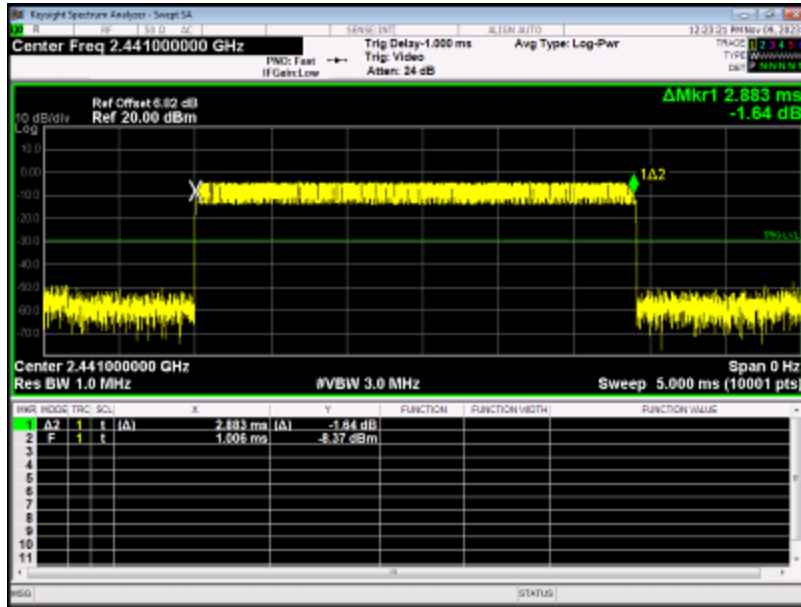

Condition	Mode	Frequency (MHz)	Pulse Time (ms)	Total Dwell Time (ms)	Period Time (ms)	Limit (ms)	Verdict
NVNT	2-DH1	2441	0.392	125.44	31600	400	Pass

Dwell NVNT 2-DH1 2441MHz

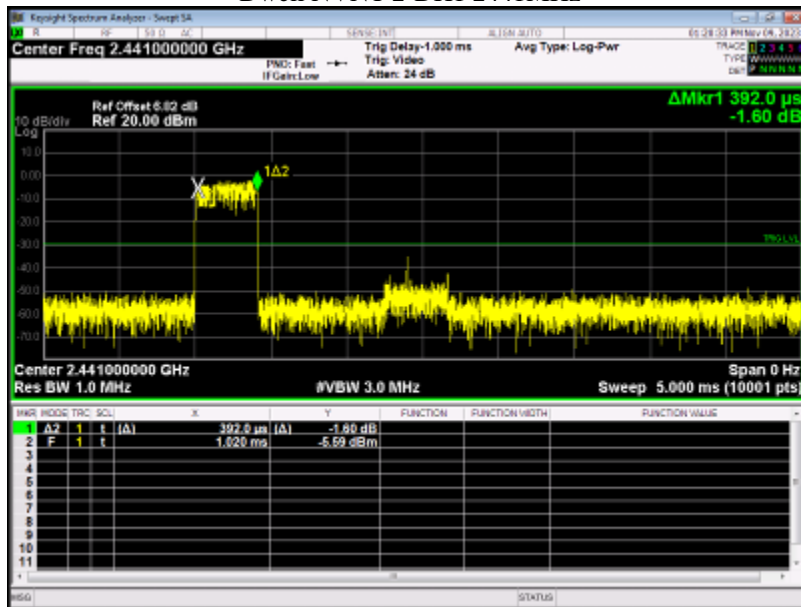

Condition	Mode	Frequency (MHz)	Pulse Time (ms)	Total Dwell Time (ms)	Period Time (ms)	Limit (ms)	Verdict
NVNT	2-DH3	2441	1.66	265.6	31600	400	Pass

Dwell NVNT 2-DH3 2441MHz

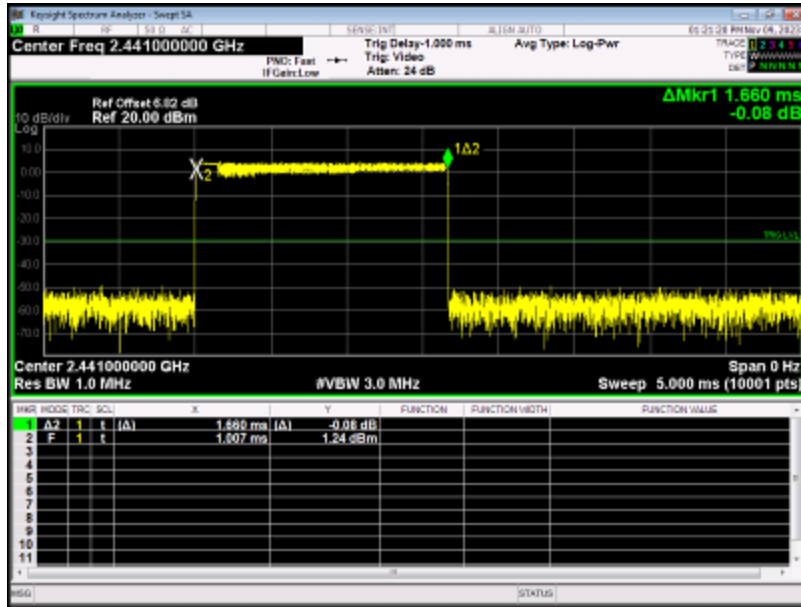

Condition	Mode	Frequency (MHz)	Pulse Time (ms)	Total Dwell Time (ms)	Period Time (ms)	Limit (ms)	Verdict
NVNT	2-DH5	2441	2.873	306.453	31600	400	Pass

Dwell NVNT 2-DH5 2441MHz

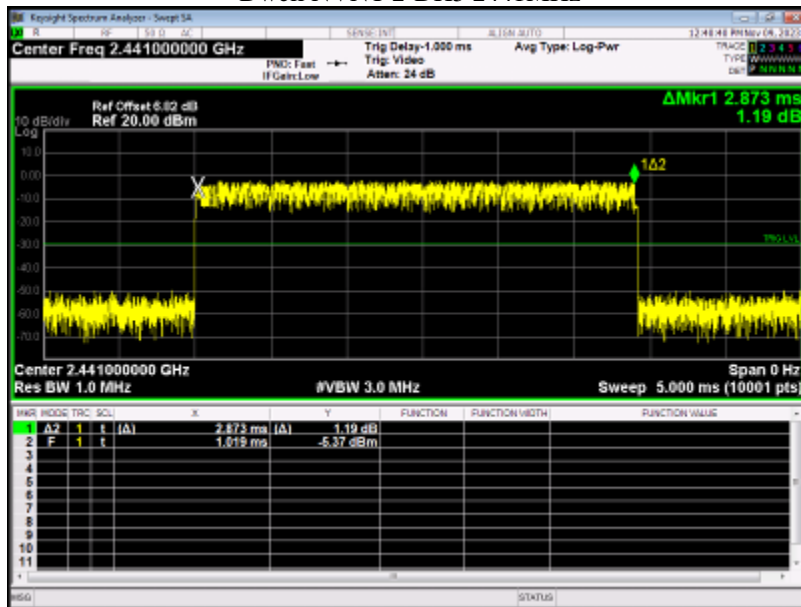

Condition	Mode	Frequency (MHz)	Pulse Time (ms)	Total Dwell Time (ms)	Period Time (ms)	Limit (ms)	Verdict
NVNT	3-DH1	2441	0.372	119.04	31600	400	Pass

Dwell NVNT 3-DH1 2441MHz

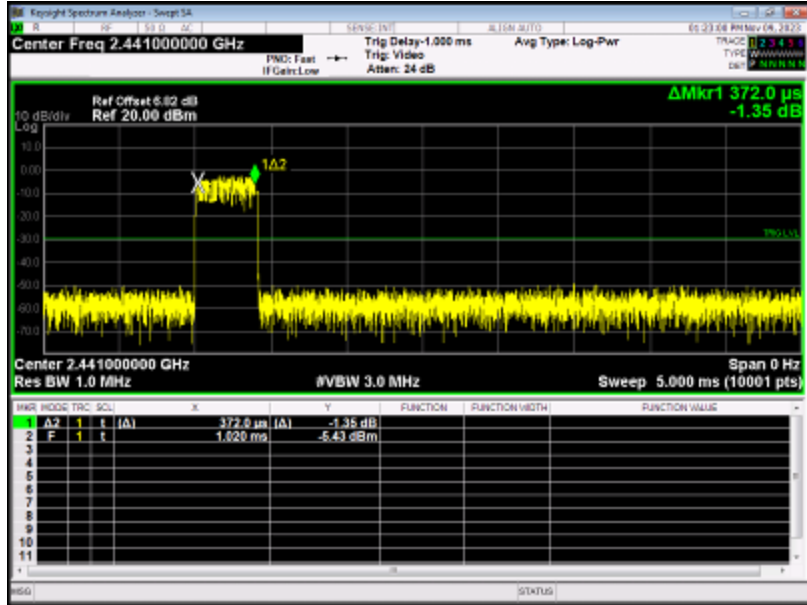

Condition	Mode	Frequency (MHz)	Pulse Time (ms)	Total Dwell Time (ms)	Period Time (ms)	Limit (ms)	Verdict
NVNT	3-DH3	2441	1.66	265.6	31600	400	Pass

Dwell NVNT 3-DH3 2441MHz

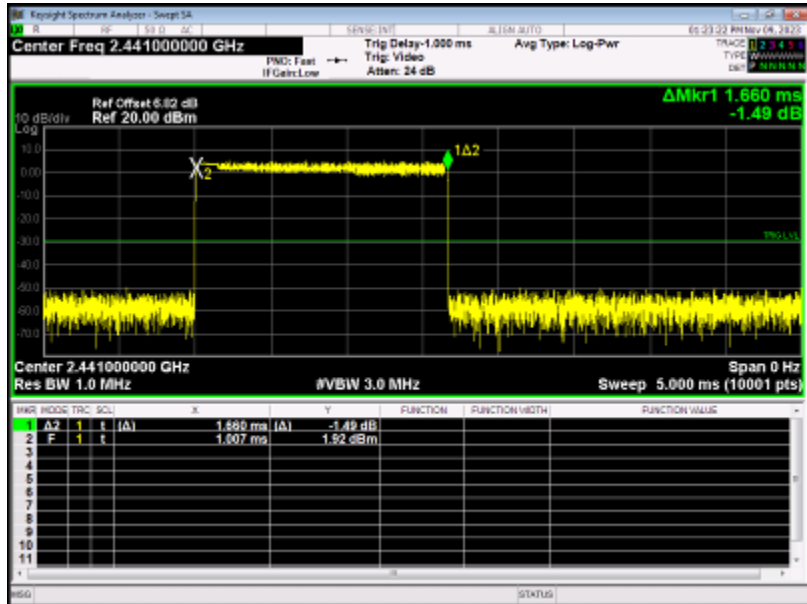

Condition	Mode	Frequency (MHz)	Pulse Time (ms)	Total Dwell Time (ms)	Period Time (ms)	Limit (ms)	Verdict
NVNT	3-DH5	2441	2.911	306.453	31600	400	Pass

Dwell NVNT 3-DH5 2441MHz

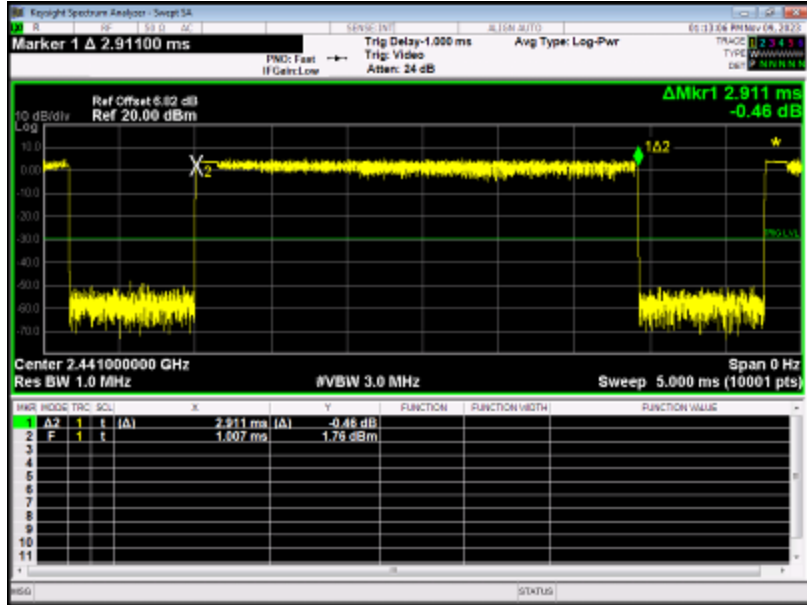

10. Band edge

10.1. Applied procedures / Limit

15.247(d) In any 100 kHz bandwidth outside the frequency band in which the spread spectrum or digitally modulated intentional radiator is operating, the radio frequency power that is produced by the intentional radiator shall be at least 20 dB below that in the 100 kHz bandwidth within the band that contains the highest level of the desired power, based on either an RF conducted or a radiated measurement, provided the transmitter demonstrates compliance with the peak conducted power limits. If the transmitter complies with the conducted power limits based on the use of RMS averaging over a time interval, as permitted under paragraph (b)(3) of this section, the attenuation required under this paragraph shall be 30 dB instead of 20 dB. Attenuation below the general limits specified in Section 15.209(a) is not required. In addition, radiated emissions which fall in the restricted bands, as defined in Section 15.205(a), must also comply with the radiated emission limits specified in Section 15.209(a) (see Section 15.205(c)).

10.2. Test procedure

- a. The EUT was directly connected to the spectrum analyzer and antenna output port as show in the block diagram below.
- b. Span = wide enough to capture the peak level of the emission operating on the channel closest to the band edge, as well as any modulation products which fall outside of the authorized band of operation, RBW \geq 1% of the span, VBW \geq RBW, Sweep = auto, Detector function = peak, Trace = max hold

10.3. Deviation from standard

No deviation.

10.4. Test setup



10.5. Test results

Condition	Mode	Frequency (MHz)	Antenna	Hopping Mode	Max Value (dBc)	Limit (dBc)	Verdict
NVNT	1-DH5	2402	Ant 1	No-Hopping	-61.313	-20	Pass
NVNT	1-DH5	2480	Ant 1	No-Hopping	-53.379	-20	Pass

Band Edge NVNT 1-DH5 2402MHz Ant1 No-Hopping Ref

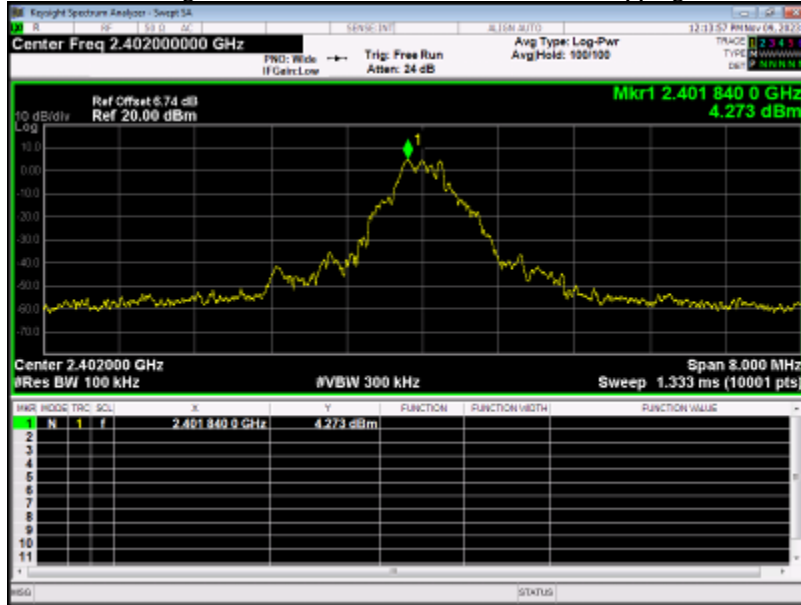

Band Edge NVNT 1-DH5 2402MHz Ant1 No-Hopping Emission

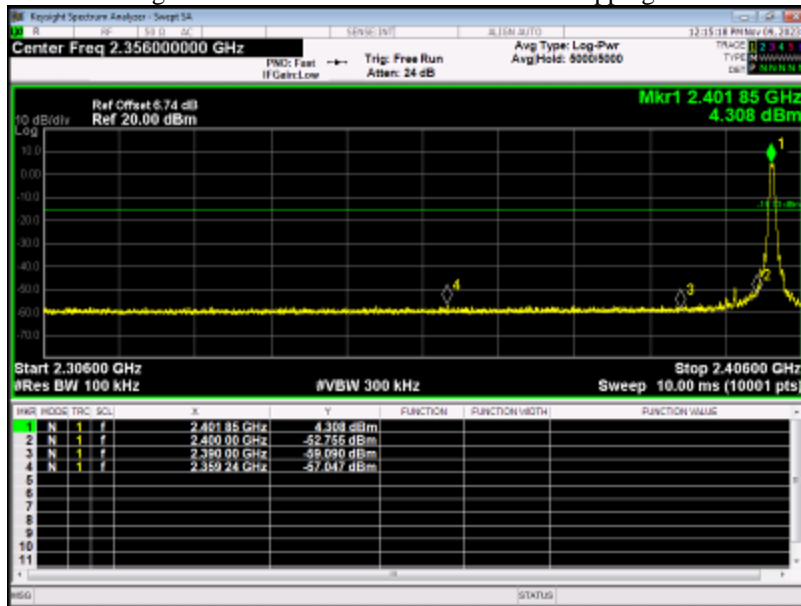

Band Edge NVNT 1-DH5 2480MHz Ant1 No-Hopping Ref

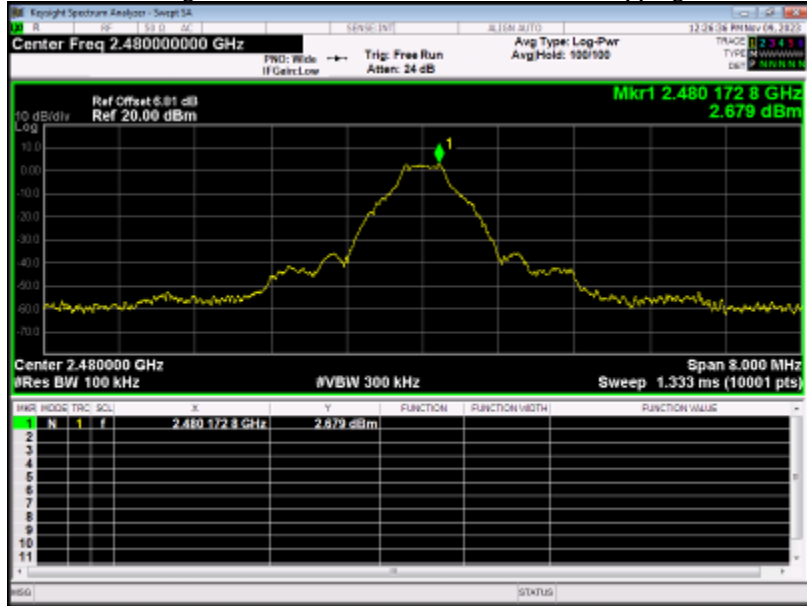

Band Edge NVNT 1-DH5 2480MHz Ant1 No-Hopping Emission

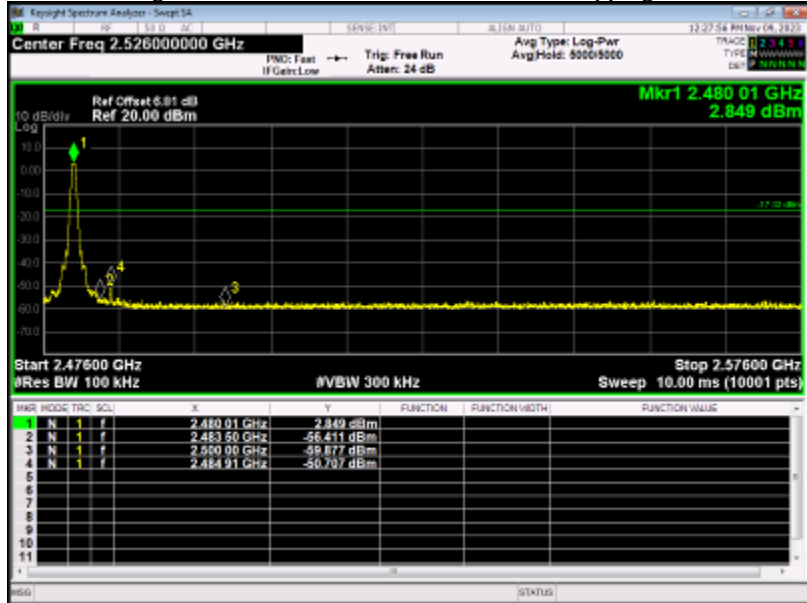

Condition	Mode	Frequency (MHz)	Antenna	Hopping Mode	Max Value (dBc)	Limit (dBc)	Verdict
NVNT	2-DH5	2402	Ant 1	No-Hopping	-59.092	-20	Pass
NVNT	2-DH5	2480	Ant 1	No-Hopping	-53.929	-20	Pass

Band Edge NVNT 2-DH5 2402MHz Ant1 No-Hopping Ref

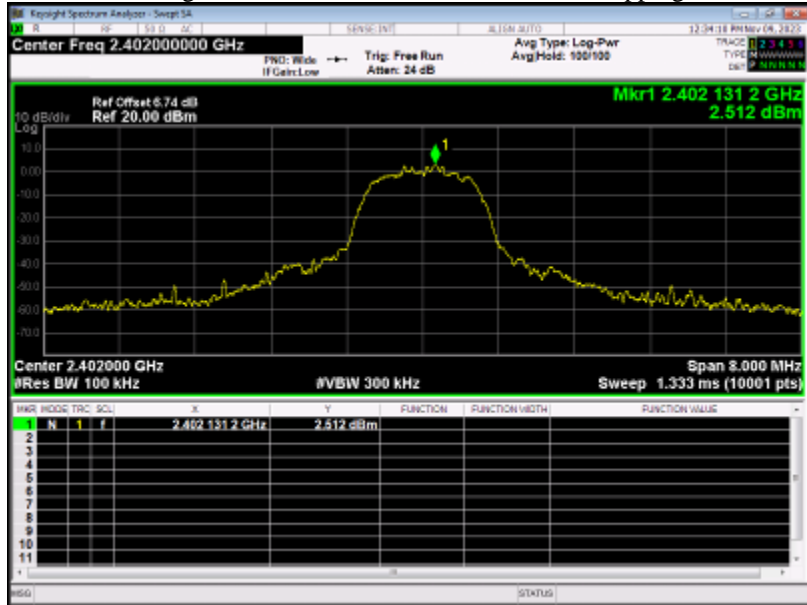

Band Edge NVNT 2-DH5 2402MHz Ant1 No-Hopping Emission

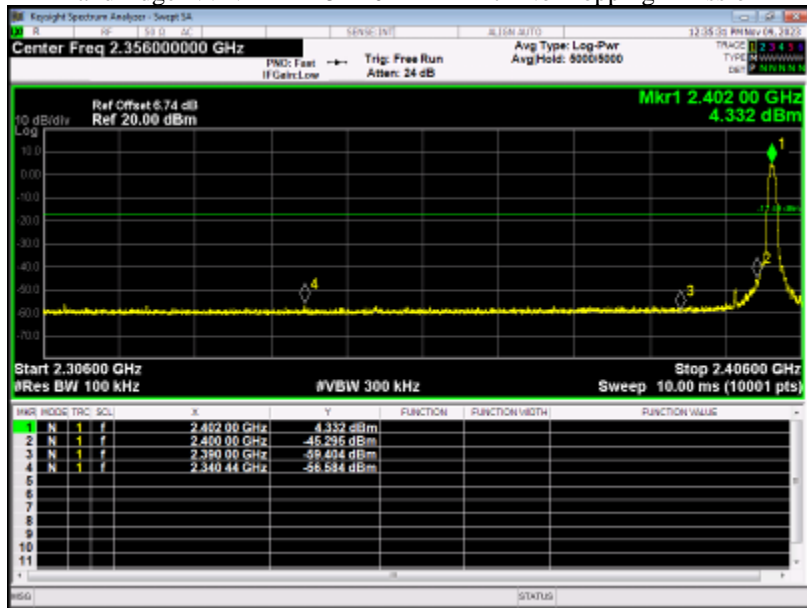

Band Edge NVNT 2-DH5 2480MHz Ant1 No-Hopping Ref

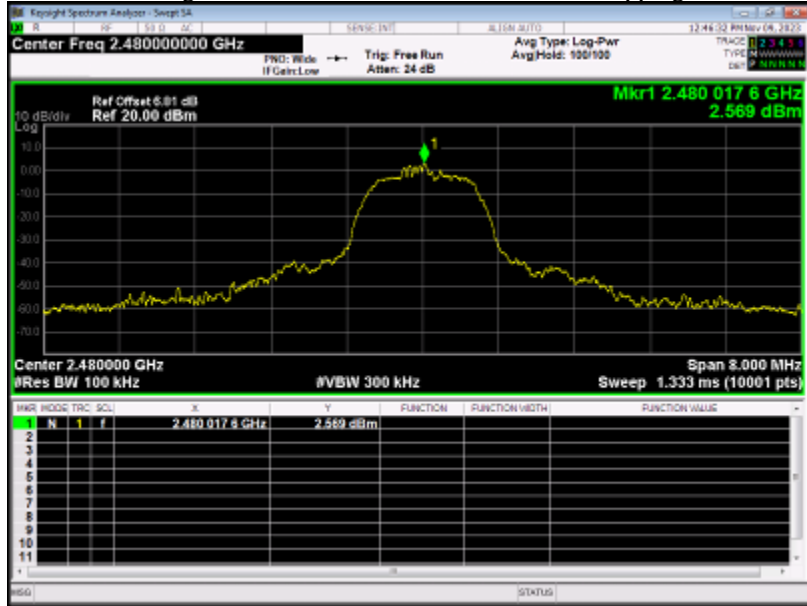

Band Edge NVNT 2-DH5 2480MHz Ant1 No-Hopping Emission

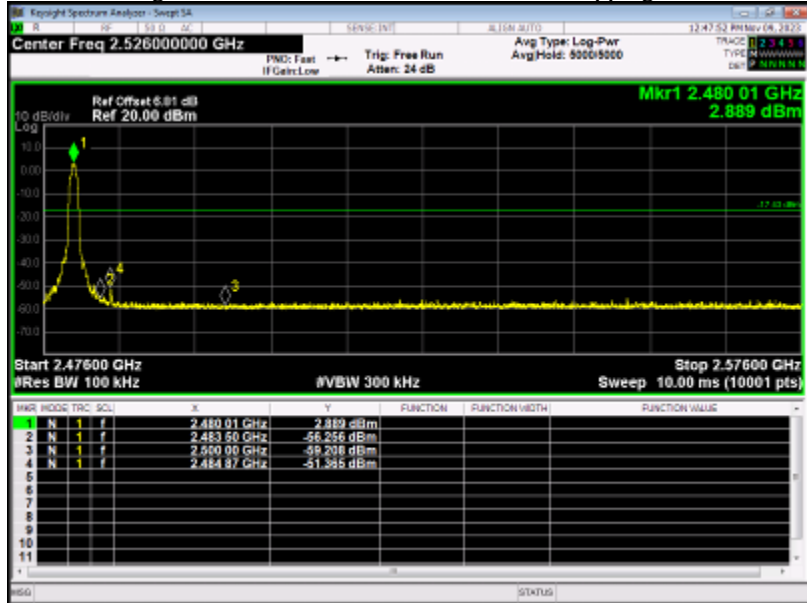

Condition	Mode	Frequency (MHz)	Antenna	Hopping Mode	Max Value (dBc)	Limit (dBc)	Verdict
NVNT	3-DH5	2402	Ant 1	No-Hopping	-59.641	-20	Pass
NVNT	3-DH5	2480	Ant 1	No-Hopping	-45.684	-20	Pass

Band Edge NVNT 3-DH5 2402MHz Ant1 No-Hopping Ref

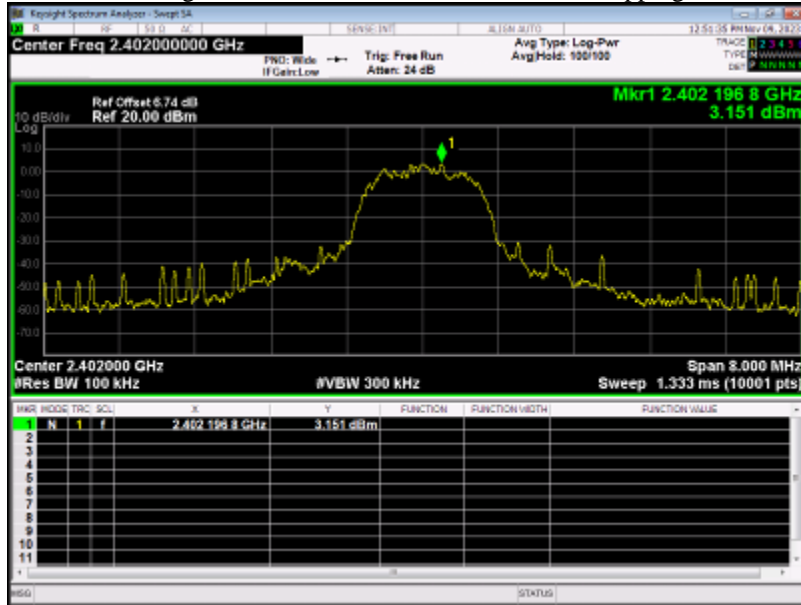

Band Edge NVNT 3-DH5 2402MHz Ant1 No-Hopping Emission

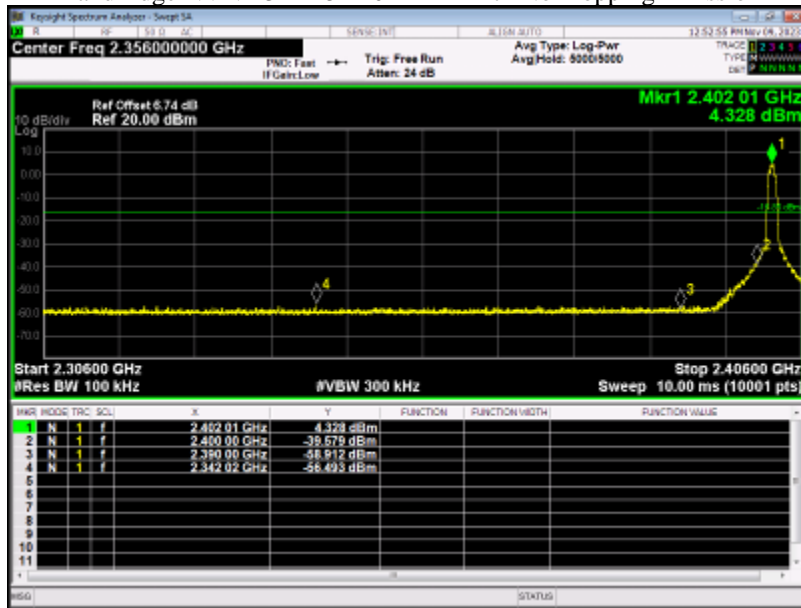

Band Edge NVNT 3-DH5 2480MHz Ant1 No-Hopping Ref



Band Edge NVNT 3-DH5 2480MHz Ant1 No-Hopping Emission

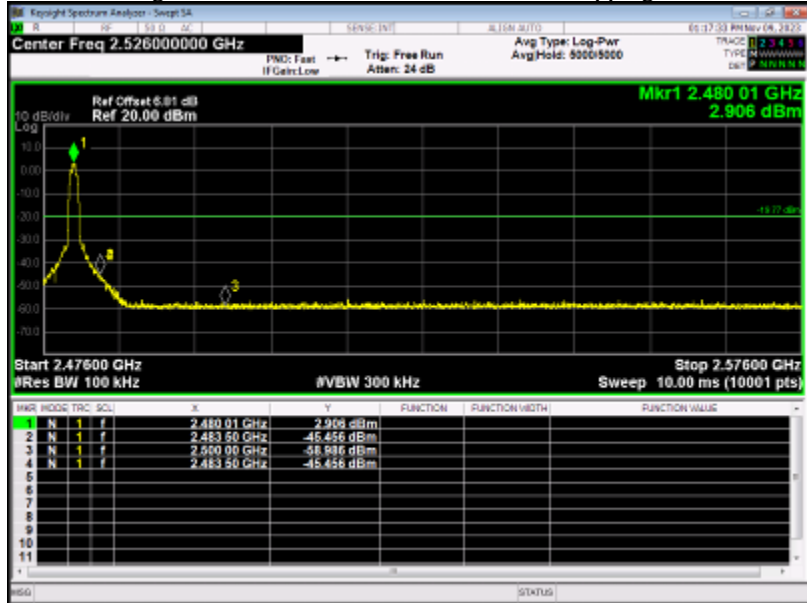

Condition	Mode	Frequency (MHz)	Antenna	Hopping Mode	Max Value (dBc)	Limit (dBc)	Verdict
NVNT	1-DH5	2402	Ant 1	Hopping	-54.164	-20	Pass
NVNT	1-DH5	2480	Ant 1	Hopping	-52.964	-20	Pass

Band Edge(Hopping) NVNT 1-DH5 2402MHz Ant1 Hopping Ref

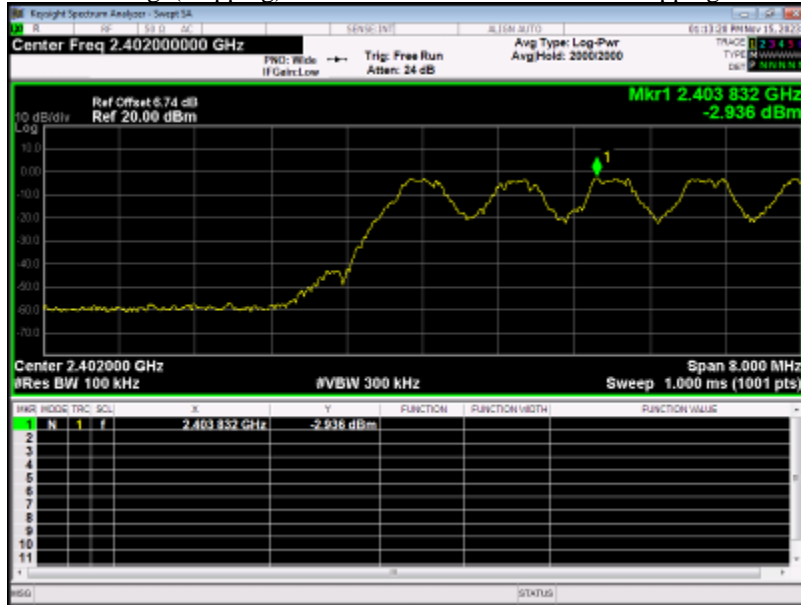

Band Edge(Hopping) NVNT 1-DH5 2402MHz Ant1 Hopping Emission

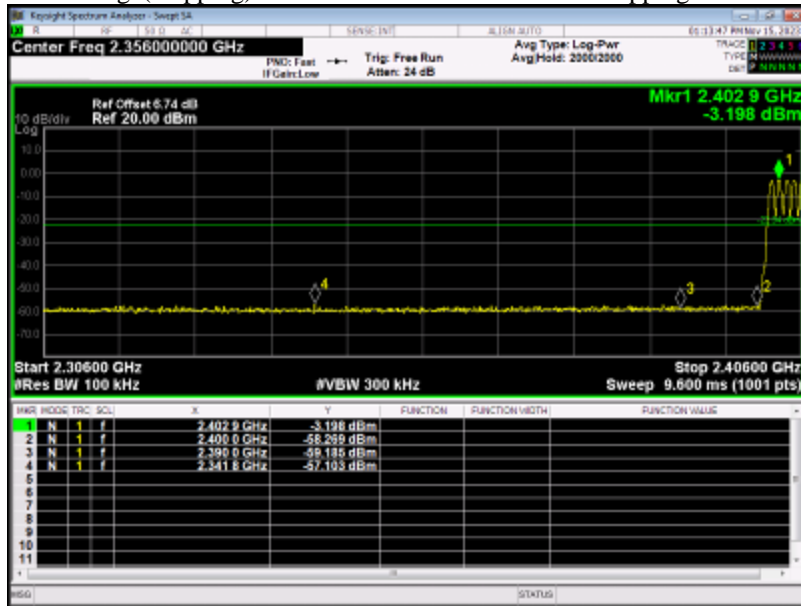

Band Edge(Hopping) NVNT 1-DH5 2480MHz Ant1 Hopping Ref



Band Edge(Hopping) NVNT 1-DH5 2480MHz Ant1 Hopping Emission

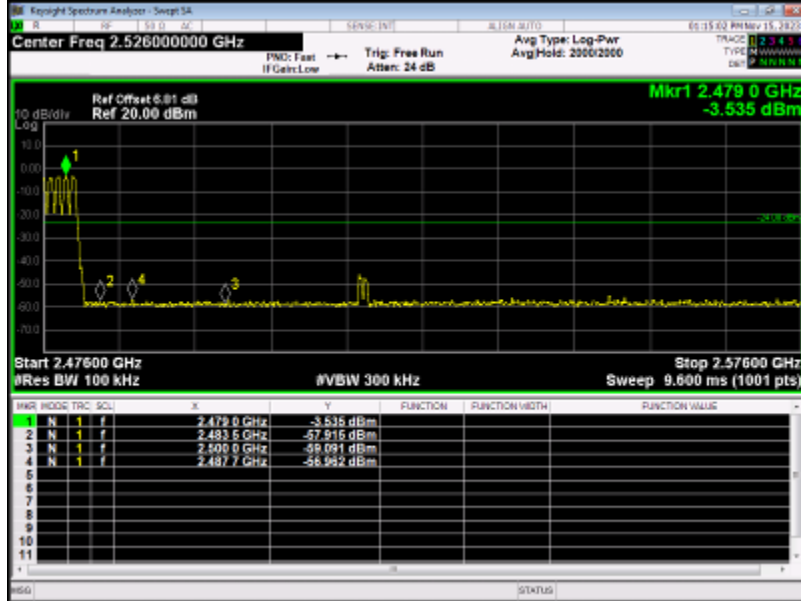

Condition	Mode	Frequency (MHz)	Antenna	Hopping Mode	Max Value (dBc)	Limit (dBc)	Verdict
NVNT	2-DH5	2402	Ant 1	Hopping	-53.996	-20	Pass
NVNT	2-DH5	2480	Ant 1	Hopping	-52.953	-20	Pass

Band Edge(Hopping) NVNT 2-DH5 2402MHz Ant1 Hopping Ref

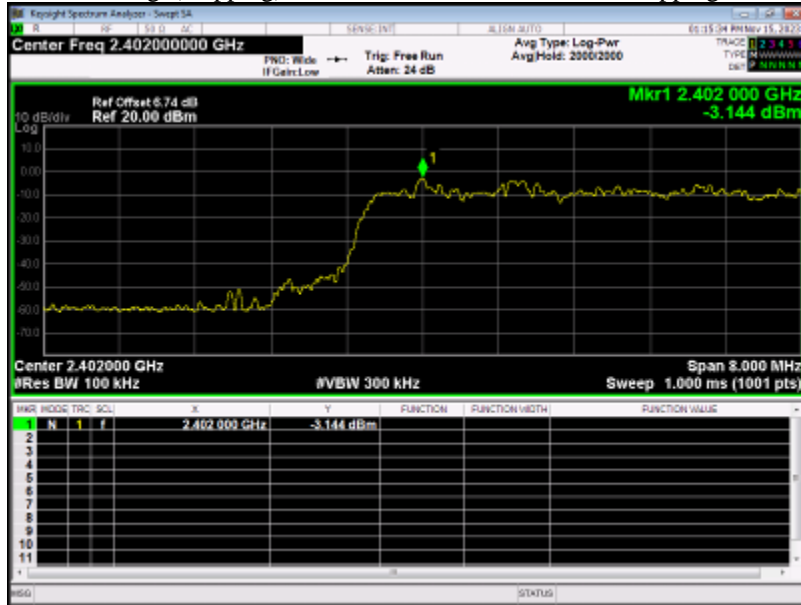

Band Edge(Hopping) NVNT 2-DH5 2402MHz Ant1 Hopping Emission

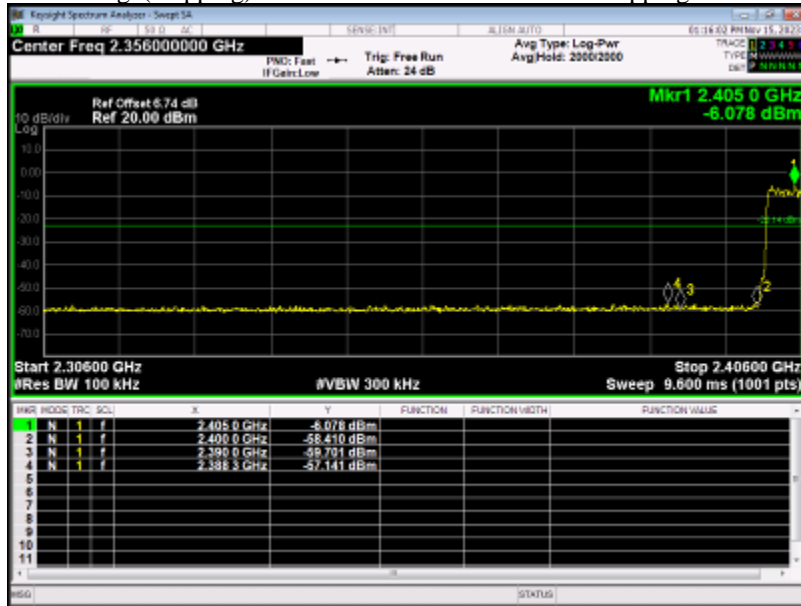

Band Edge(Hopping) NVNT 2-DH5 2480MHz Ant1 Hopping Ref



Band Edge(Hopping) NVNT 2-DH5 2480MHz Ant1 Hopping Emission

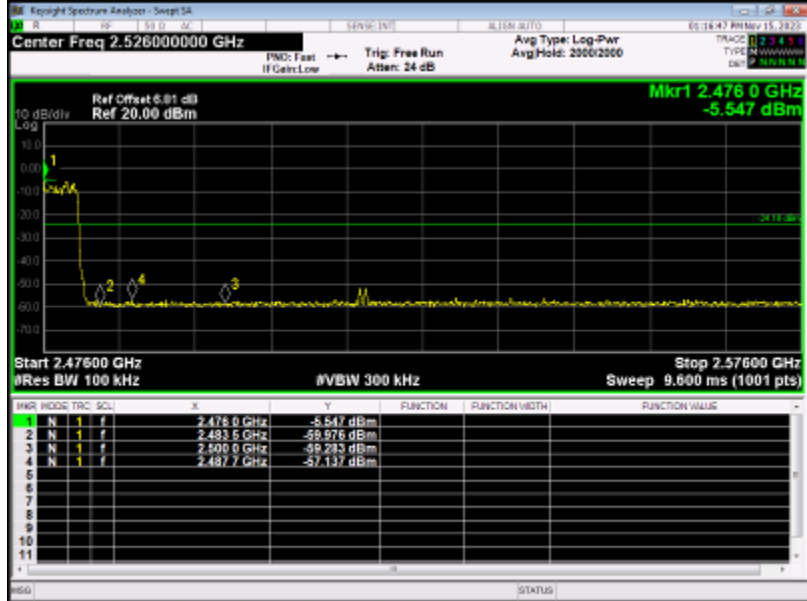

Condition	Mode	Frequency (MHz)	Antenna	Hopping Mode	Max Value (dBc)	Limit (dBc)	Verdict
NVNT	3-DH5	2402	Ant 1	Hopping	-52.532	-20	Pass
NVNT	3-DH5	2480	Ant 1	Hopping	-52.052	-20	Pass

Band Edge(Hopping) NVNT 3-DH5 2402MHz Ant1 Hopping Ref

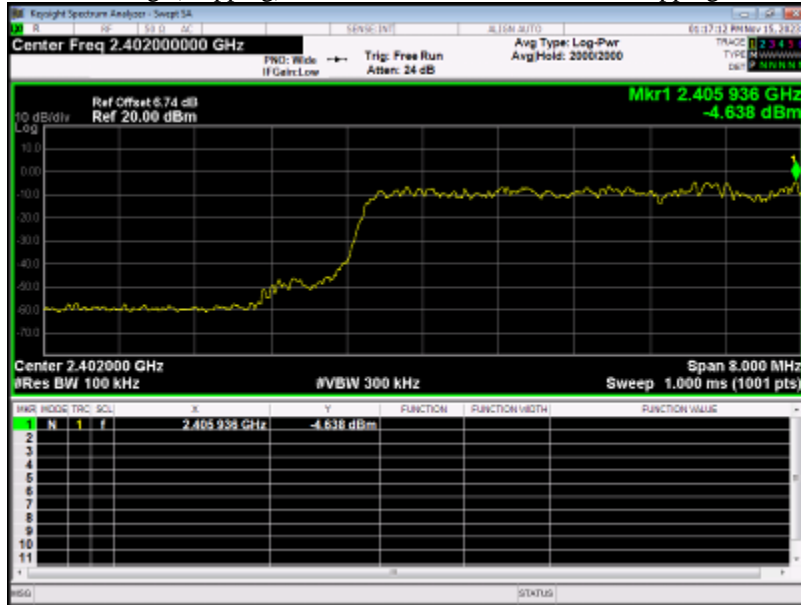

Band Edge(Hopping) NVNT 3-DH5 2402MHz Ant1 Hopping Emission

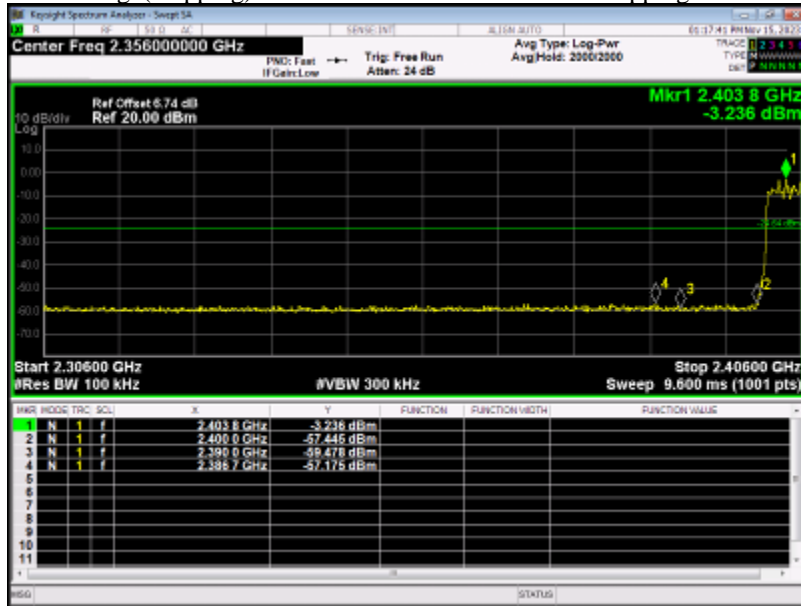

Band Edge(Hopping) NVNT 3-DH5 2480MHz Ant1 Hopping Ref



Band Edge(Hopping) NVNT 3-DH5 2480MHz Ant1 Hopping Emission

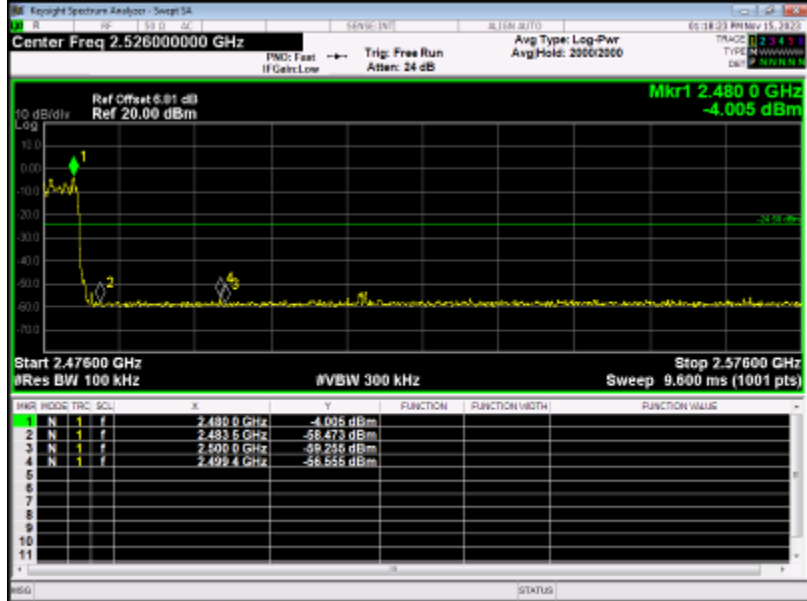

11. Conducted Spurious Emissions

11.1. Applied procedures / Limit

15.247(d) In any 100 kHz bandwidth outside the frequency band in which the spread spectrum or digitally modulated intentional radiator is operating, the radio frequency power that is produced by the intentional radiator shall be at least 20 dB below that in the 100 kHz bandwidth within the band that contains the highest level of the desired power, based on either an RF conducted or a radiated measurement, provided the transmitter demonstrates compliance with the peak conducted power limits. If the transmitter complies with the conducted power limits based on the use of RMS averaging over a time interval, as permitted under paragraph (b)(3) of this section, the attenuation required under this paragraph shall be 30 dB instead of 20 dB. Attenuation below the general limits specified in Section 15.209(a) is not required. In addition, radiated emissions which fall in the restricted bands, as defined in Section 15.205(a), must also comply with the radiated emission limits specified in Section 15.209(a) (see Section 15.205(c)).

11.2. Test procedure

- a. The EUT was directly connected to the spectrum analyzer and antenna output port as show in the block diagram below.
- b. Span = wide enough to capture the peak level of the in-band emission and all spurious emissions (e.g., harmonics) from the lowest frequency generated in the EUT up through the 10th harmonic. Typically, several plots are required to cover this entire span. RBW = 100 kHz
VBW \geq RBW, Sweep = auto, Detector function = peak, Trace = max hold
sweep points \geq investigated frequency range/RBW.

11.3. Deviation from standard

No deviation.

11.4. Test setup



11.5. Test results

Condition	Mode	Frequency (MHz)	Antenna	Max Value (dBc)	Limit (dBc)	Verdict
NVNT	1-DH5	2402	Ant 1	-28.598	-20	Pass
NVNT	1-DH5	2441	Ant 1	-28.112	-20	Pass
NVNT	1-DH5	2480	Ant 1	-26.67	-20	Pass

Tx. Spurious NVNT 1-DH5 2402MHz Ant1 Ref

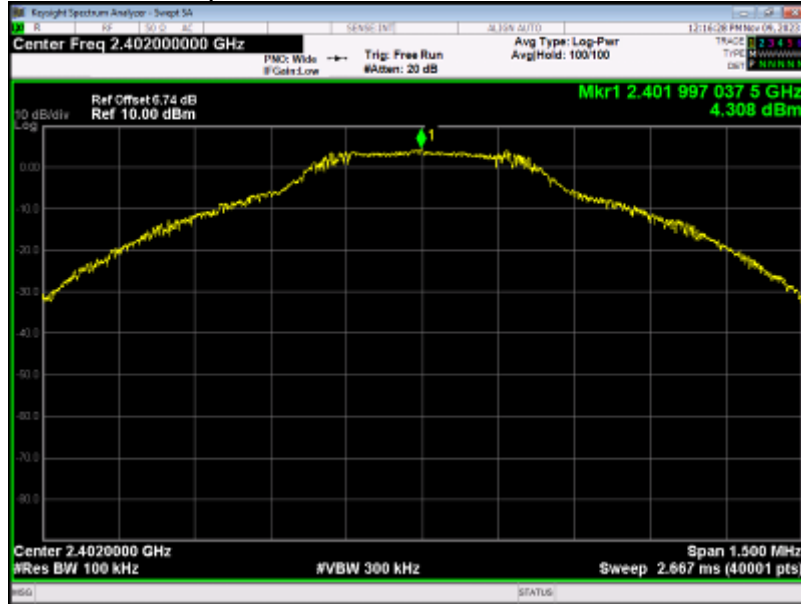

Tx. Spurious NVNT 1-DH5 2402MHz Ant1 Emission

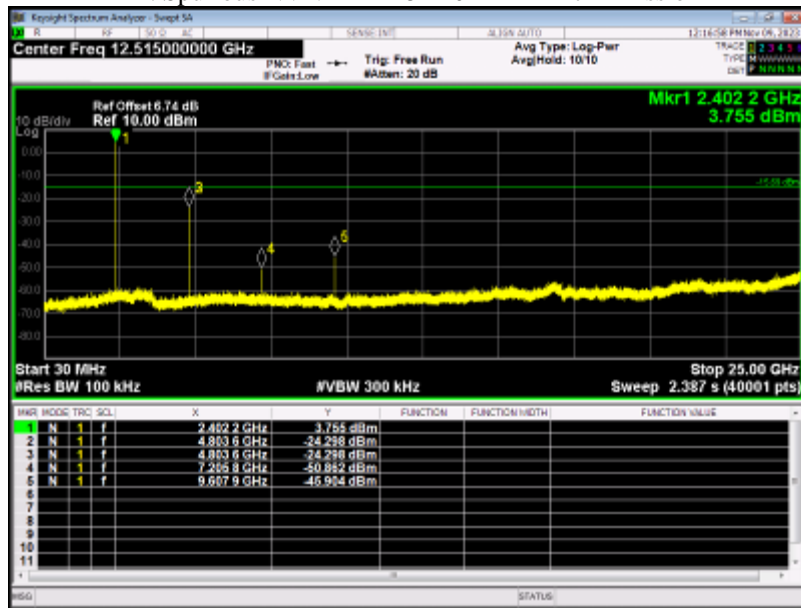

Tx. Spurious NVNT 1-DH5 2441MHz Ant1 Ref

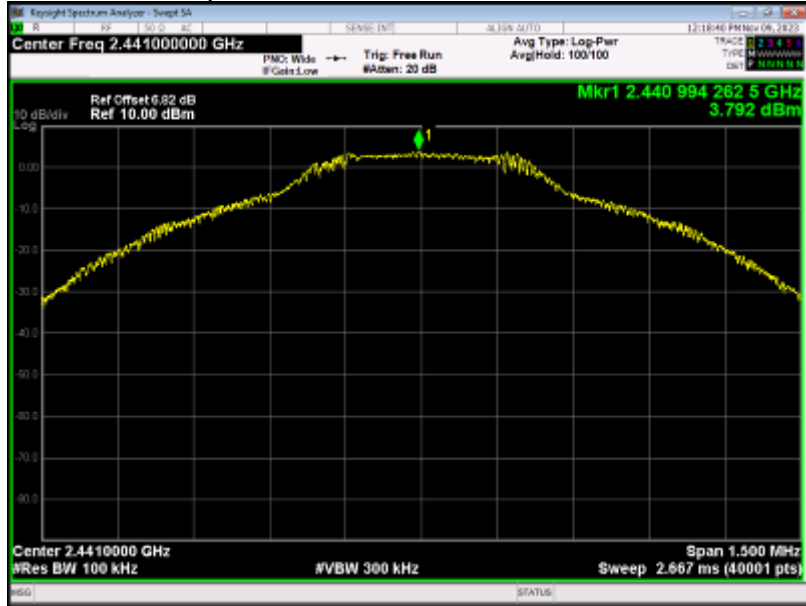

Tx. Spurious NVNT 1-DH5 2441MHz Ant1 Emission

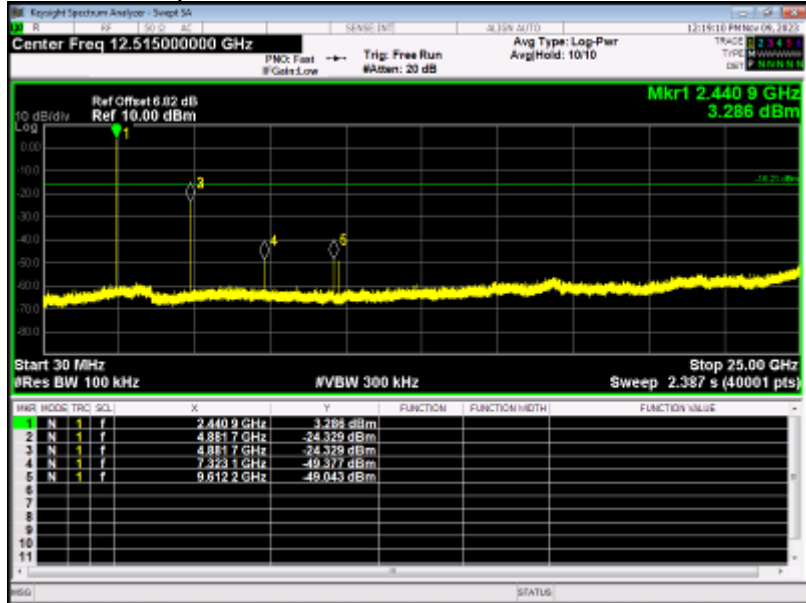

Tx. Spurious NVNT 1-DH5 2480MHz Ant1 Ref

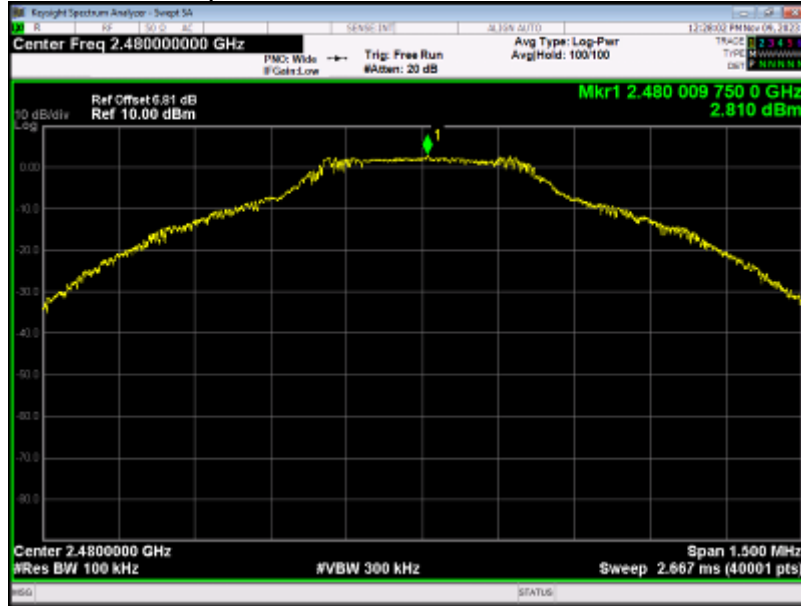

Tx. Spurious NVNT 1-DH5 2480MHz Ant1 Emission

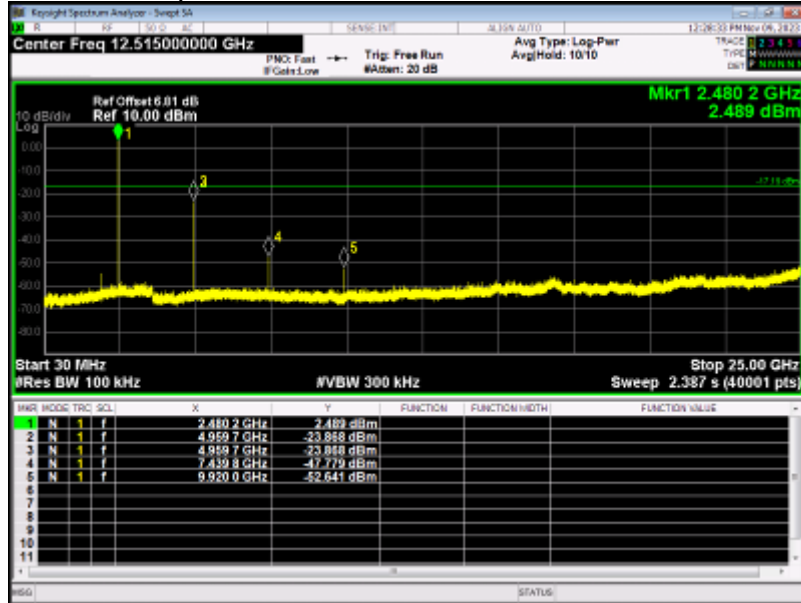

Condition	Mode	Frequency (MHz)	Antenna	Max Value (dBc)	Limit (dBc)	Verdict
NVNT	2-DH5	2402	Ant 1	-32.239	-20	Pass
NVNT	2-DH5	2441	Ant 1	-27.41	-20	Pass
NVNT	2-DH5	2480	Ant 1	-33.152	-20	Pass

Tx. Spurious NVNT 2-DH5 2402MHz Ant1 Ref

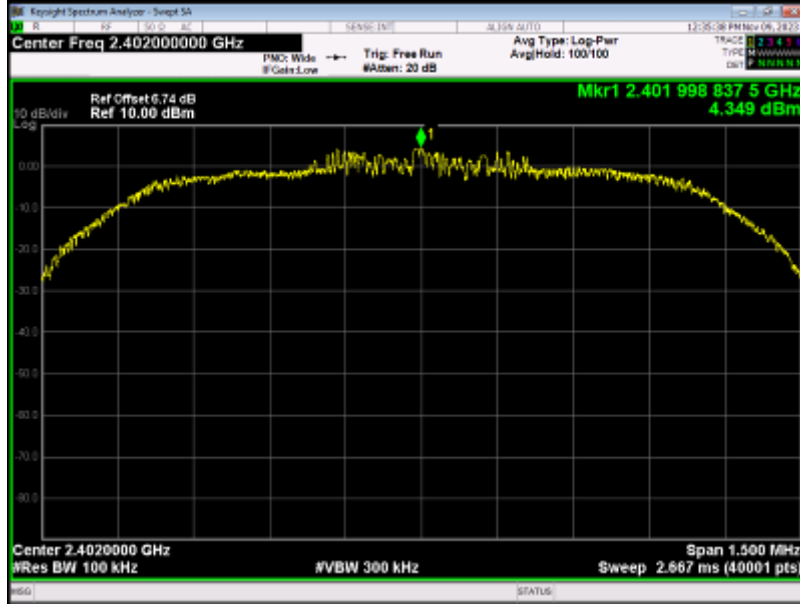

Tx. Spurious NVNT 2-DH5 2402MHz Ant1 Emission

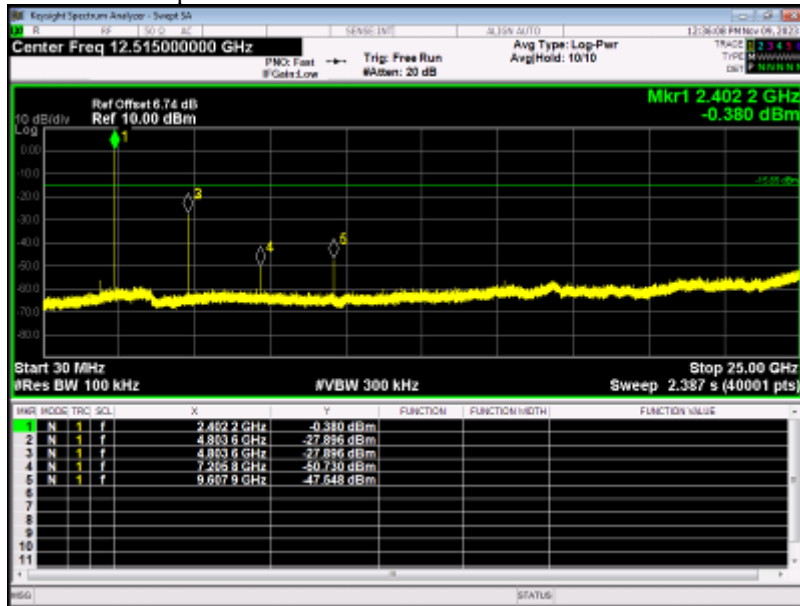

Tx. Spurious NVNT 2-DH5 2441MHz Ant1 Ref



Tx. Spurious NVNT 2-DH5 2441MHz Ant1 Emission

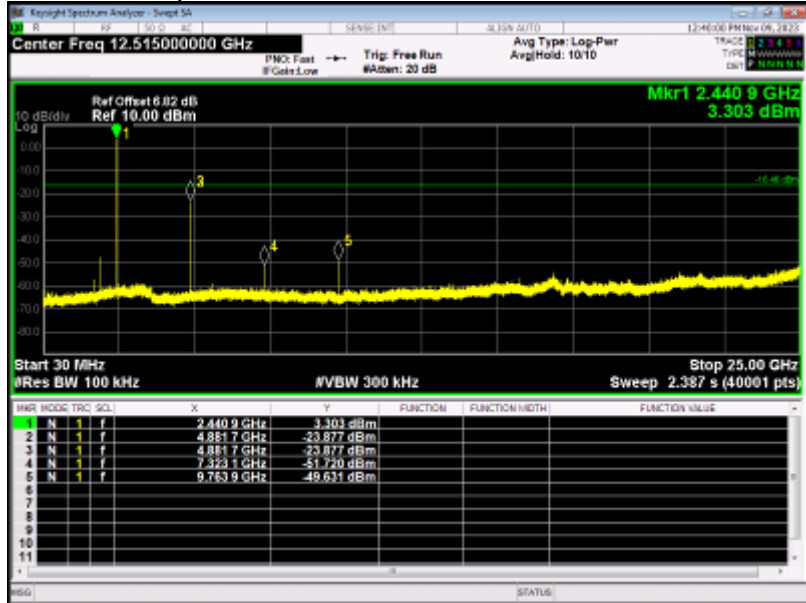

Tx. Spurious NVNT 2-DH5 2480MHz Ant1 Ref

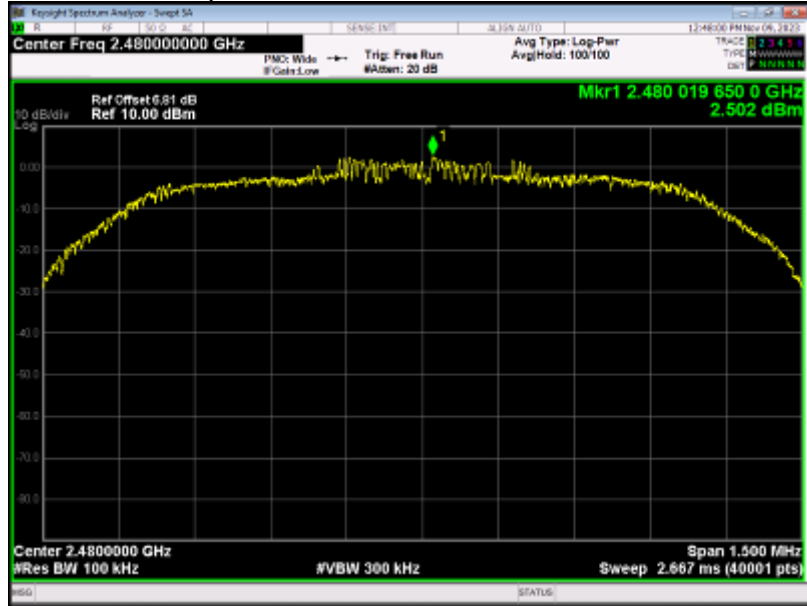

Tx. Spurious NVNT 2-DH5 2480MHz Ant1 Emission

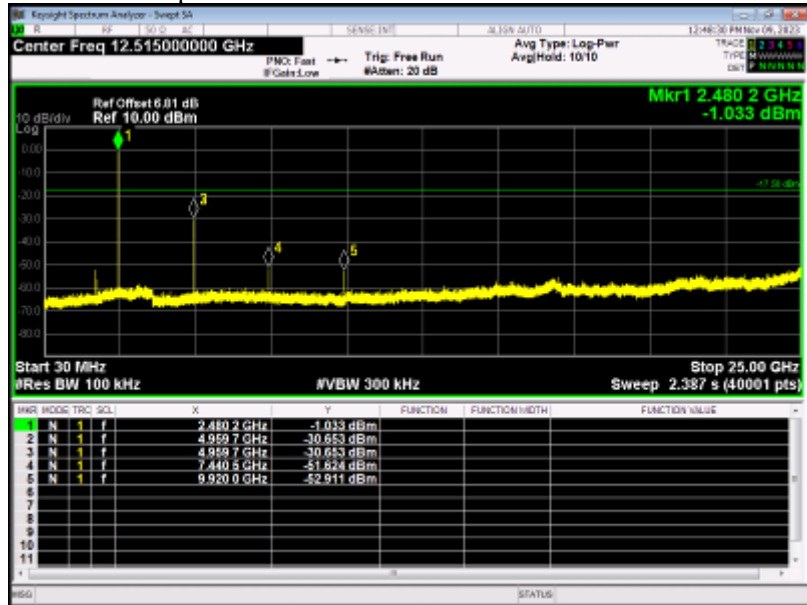

Condition	Mode	Frequency (MHz)	Antenna	Max Value (dBc)	Limit (dBc)	Verdict
NVNT	3-DH5	2402	Ant 1	-26.708	-20	Pass
NVNT	3-DH5	2441	Ant 1	-32.905	-20	Pass
NVNT	3-DH5	2480	Ant 1	-31.186	-20	Pass

Tx. Spurious NVNT 3-DH5 2402MHz Ant1 Ref

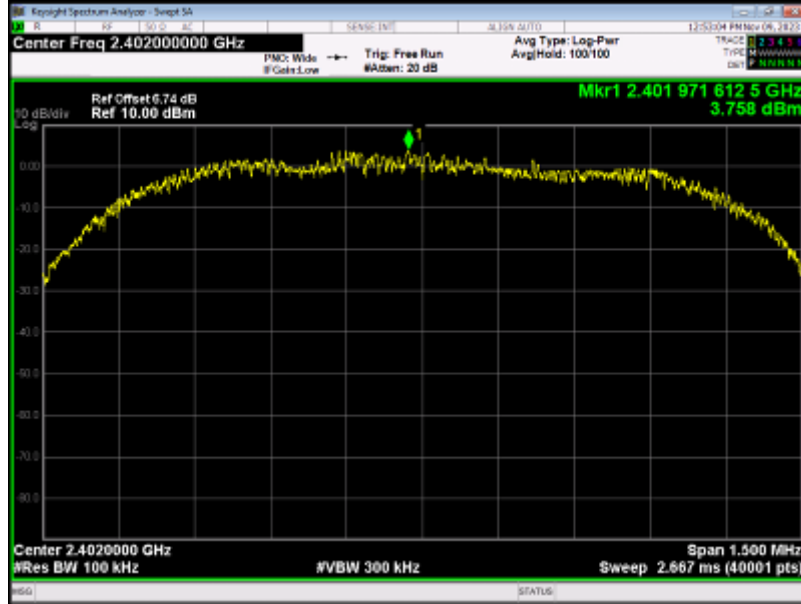

Tx. Spurious NVNT 3-DH5 2402MHz Ant1 Emission

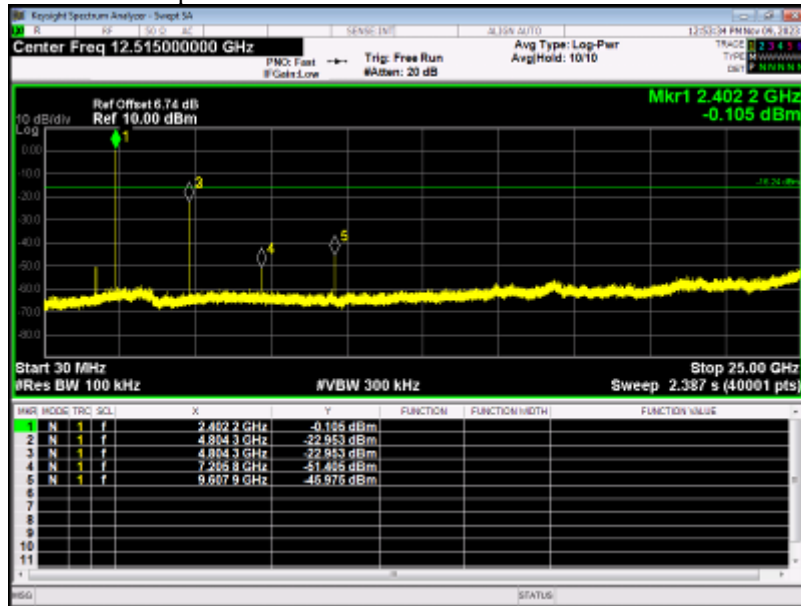

Tx. Spurious NVNT 3-DH5 2441MHz Ant1 Ref

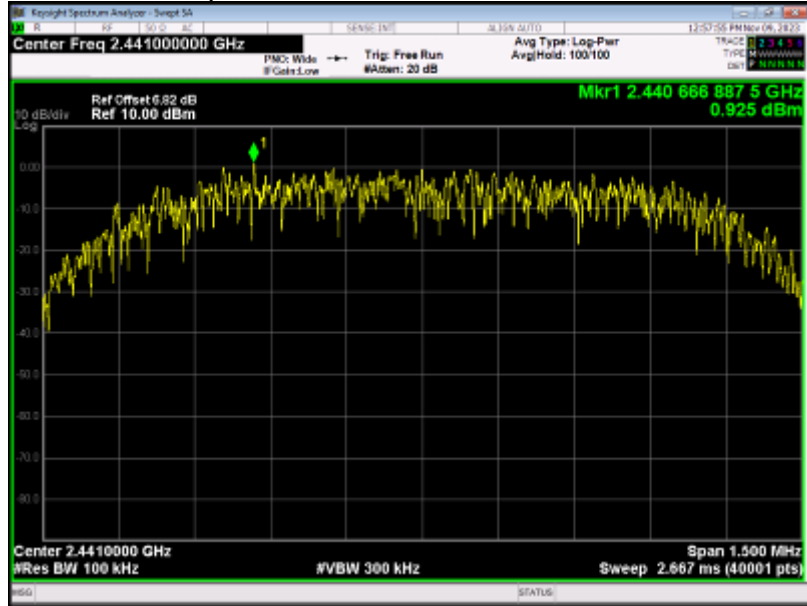

Tx. Spurious NVNT 3-DH5 2441MHz Ant1 Emission

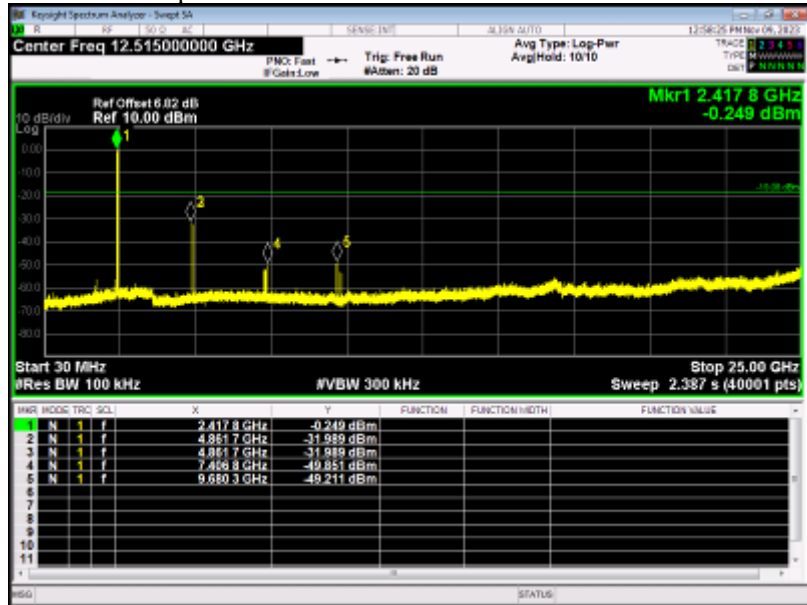

Tx. Spurious NVNT 3-DH5 2480MHz Ant1 Ref

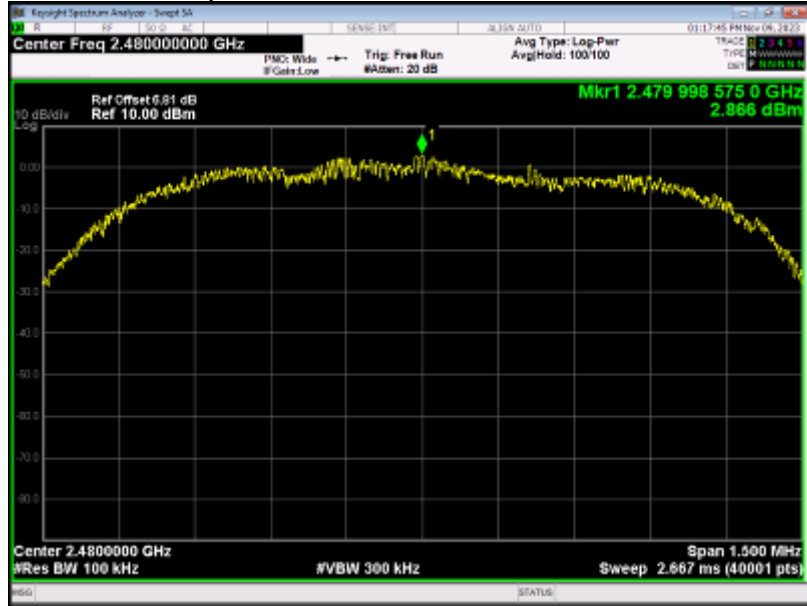

Tx. Spurious NVNT 3-DH5 2480MHz Ant1 Emission

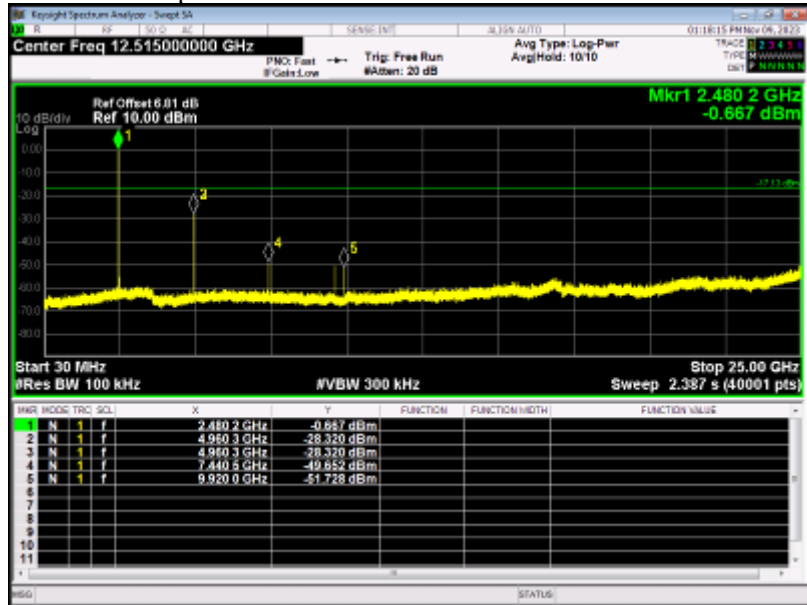

12. Antenna Requirement

12.1. Standard requirement

15.203 requirement: For intentional device, according to 15.203: an intentional radiator shall be designed to ensure that no antenna other than that furnished by the responsible party shall be used with the device. 15.247(c) (1)(i) requirement: (i) Systems operating in the 2400-2483.5 MHz band that is used exclusively for fixed. Point-to-point operations may employ transmitting antennas with directional gain greater than 6dBi provided the maximum conducted output power of the intentional radiator is reduced by 1 dB for every 3 dB that the directional gain of the antenna exceeds 6dBi.

12.2. EUT Antenna

The antenna is Integral Antenna and no consideration of replacement. Antenna gain is Maximum 2.5dBi from 2.4GHz to 2.5GHz.

13. Test setup photograph

Photos of power line conducted emission test



Photos of radiated emission test
30MHz – 1GHz



Photos of radiated emission test
Above 1GHz



14. Photos of the EUT

External Photos of EUT







Internal Photos of EUT







--End of Report--