

Product Specifications

Products name: RF Mini RGB controller

Model number: FC-MB-R10Q



Product Description:

This RF Mini RGB controller adopted the advanced computer control chip. Controlled by 433Mhz wireless remote.Its mainly used to controlled all kinds of constant voltage led lights,such as:LED source, LED strips,led wall washer,wall Glass curtain lights,etc.It integrated with low cost,easy connection,simple manipulation and others advantages.User can choose the mode of fade, strobe,Blasting flash,flicker,and other Static color model. What's more, this controller have the characteristics of small volume, easy to carry,etc, its popular amount the many markets.

Technical Parameters:

- Working temperature: -20-60℃
- Input voltage: DC5-24V
- Output: 3 circuit
- Connection mode: Common anode
- controller size: L40.0×W12.0×H5mm
- controller size: L85.9×W39.6×H6.9mm
- Net weight: 35g

- Gross weight: 40g
- Static power consumption: <0.5W
- Output current: <2A*3CH(each circuit)
- Output power: 5V:<30W, 12V:<72W

External dimension:

(controller size)

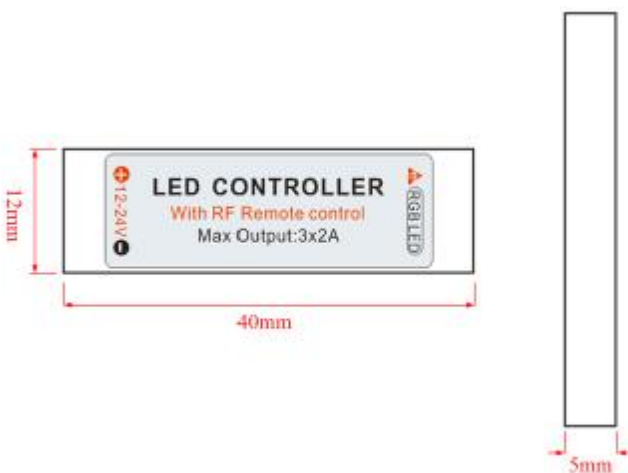

(Remote size)

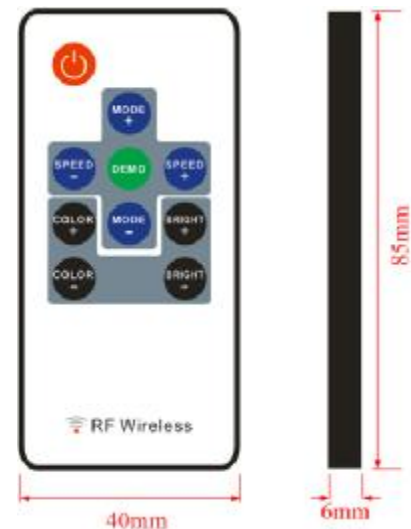

Connection description:



Power input :5.5x2.1mm female DC connector



Signal output port:2.54mm female 4 pins

Direction for use:

1.The match code instructions:

Press the ON/OFF key  within 4 seconds when power the controller. Each time powered the controller, just can be match code for one time. If want to match code again, then

need to cut off the power , connected to the power again.

2.Remote control function instructions:

There are 10 buttons on the remote , the functions are as below:

 Turn ON/OFF the controller. Press this key within 4 seconds to match code when powered the controller.

 Auto play key. on any state to press this button , the controller will be take turns to play each dynamic mode by cycle for 3 times.

 In dynamic mode, press this key switch to static mode for the first time,the color will backward/forward to the next color when press each time.

 In dynamic mode, press this key switch to static mode for the first time,the brightness will increase/decrease for one level when press each time,total 5 level.

 In static mode, press this key switch to dynamic mode for the first time,switch to the next backward/forward mode when press each time.

 In static mode, press this key switch to dynamic mode,the changing speed will increase/decrease for one level when press each time,total 10 level.

3、 This controller's sequence is +RGB order,in case of other sequence(+BRG/+GRB) will appear in the other effect. Based on sequence of + RGB, pattern are as follows:

	NO.	Mode	NO.	Mode	NO.	Mode
Dynamic model	1	7 color fade	8	Purple fade in and fade out	15	Blue blasting flash
	2	3 color fade in and fade out	9	Blue fade in and fade out	16	Purple blasting flash
	3	7 color fade in and fade out	10	3 Color Jump	17	Yellow blasting flash
	4	White fade in and fade out	11	6 color Jump	18	White blasting flash
	5	Green fade in and fade out	12	3 color flash	19	3 color blasting flash
	6	Yellow fade in and fade out	13	Red blasting flash		

	7	Red fade in and fade out	14	Green blasting flash		
Static mode	NO.	Mode	NO.	Mode	NO.	Mode
	1	Red	8	Milk-white	15	Blue-purple
	2	Green	9	Dark yellow	16	Yellow-white
	3	Blue	10	Sky blue	17	yellow
	4	White	11	Brown	18	cyan
	5	Orange	12	Pink-white	19	purple
	6	Light green	13	Light-yellow	20	Blue-white
	7	Dark blue	14	Light blue		

Typical Applications:

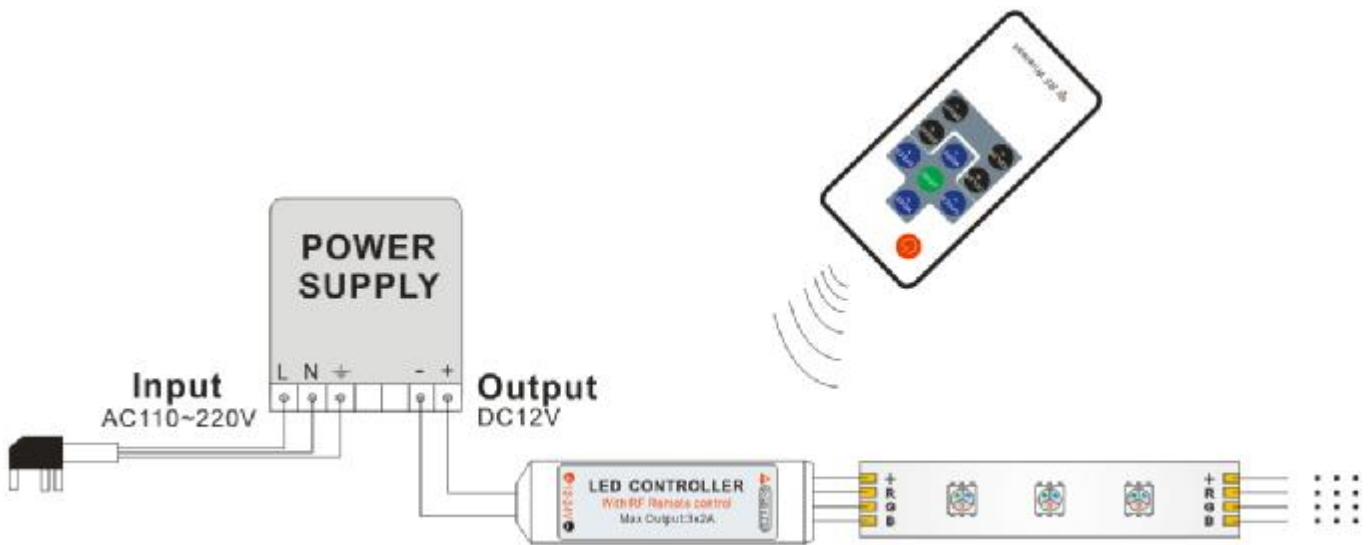

cautions

- 1、 This products Input voltage is DC5-24V,other input voltage are not allowed.
- 2、 Lead wire should be connected correctly,according to the wire color and the connecting diagram offers.
- 3、 Overload are prohibited.

FCC Caution:

This device complies with part 15 of the FCC Rules. Operation is subject to the following two conditions: (1) This device may not cause harmful interference, and (2) this device must accept any interference received, including interference that may cause undesired operation.

Any Changes or modifications not expressly approved by the party responsible for compliance could void the user's authority to operate the equipment.

Note: This equipment has been tested and found to comply with the limits for a Class B digital device, pursuant to part 15 of the FCC Rules. These limits are designed to provide reasonable protection against harmful interference in a residential installation. This equipment generates uses and can radiate radio frequency energy and, if not installed and used in accordance with the instructions, may cause harmful interference to radio communications. However, there is no guarantee that interference will not occur in a particular installation. If this equipment does cause harmful interference to radio or television reception, which can be determined by turning the equipment off and on, the user is encouraged to try to correct the interference by one or more of the following measures:

- Reorient or relocate the receiving antenna.
- Increase the separation between the equipment and receiver.
- Connect the equipment into an outlet on a circuit different from that to which the receiver is connected.
- Consult the dealer or an experienced radio/TV technician for help.