



RADIO TEST REPORT

Report No:STS1909134W02

Issued for

Arrow Electronics, Inc

9201 East Dry Creek road Centennial, CO 80112 United States

Product Name:	iMX8M_HMI_Platform
Brand Name:	Thor96
Model Name:	Thor96
Series Model:	IMX-THOR96
FCC ID:	2AFQA-IMX-THOR96
Test Standard:	FCC Part 15.247

Any reproduction of this document must be done in full. No single part of this document may be reproduced without permission from STS, All Test Data Presented in this report is only applicable to presented Test sample.





TEST RESULT CERTIFICATION

Applicant's Name.....: Arrow Electronics, Inc
 Address: 9201 East Dry Creek road Centennial, CO 80112 United States
Manufacture's Name.....: elInfochips - An Arrow company
 Address: 11- A/B, Chandra Colony, Behind Cargo Motors, Off C.G Road, Ellisbridge, Ahmedabad, Gujarat, India. Pin Code: 380006

Product Description

Product Name.....: iMX8M_HMI_Platform
 Brand Name: Thor96
 Model Name: Thor96
 Series Model.....: IMX-THOR96

Test Standards.....: FCC Part15.247
 Test Procedure: ANSI C63.10-2013

This device described above has been tested by STS, the test results show that the equipment under test (EUT) is in compliance with the FCC requirements. And it is applicable only to the tested sample identified in the report.
 This report shall not be reproduced except in full, without the written approval of STS, this document may be altered or revised by STS, personal only, and shall be noted in the revision of the document.

Date of Test.....:
 Date (s) of performance of tests: 04 Sept. 2019 ~ 31 Oct. 2019
 Date of Issue.....: 31 Oct. 2019
 Test Result.....: **Pass**

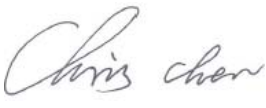
Testing Engineer : 
 (Chris Chen)

Technical Manager : 
 (Sunday Hu)

Authorized Signatory : 
 (Vita Li)





Table of Contents	Page
1. SUMMARY OF TEST RESULTS	5
1.1 TEST FACTORY	6
1.2 MEASUREMENT UNCERTAINTY	6
2. GENERAL INFORMATION	7
2.1 GENERAL DESCRIPTION OF THE EUT	7
2.2 DESCRIPTION OF THE TEST MODES	9
2.3 TEST SOFTWARE AND POWER LEVEL SETTING	9
2.4 BLOCK DIGRAM SHOWING THE CONFIGURATION OF SYSTEM TESTED	10
2.5 DESCRIPTION OF NECESSARY ACCESSORIES AND SUPPORT UNITS	11
2.6 EQUIPMENTS LIST	12
3. EMC EMISSION TEST	13
3.1 CONDUCTED EMISSION MEASUREMENT	13
3.2 RADIATED EMISSION MEASUREMENT	17
4. EUT TEST PHOTO	30



Revision History

Rev.	Issue Date	Report NO.	Effect Page	Contents
00	31 Oct. 2019	STS1909134W02	ALL	Initial Issue





1. SUMMARY OF TEST RESULTS

Test procedures according to the technical standards:
KDB 558074 D01 15.247 Meas Guidance v05r02

FCC Part 15.247, Subpart C			
Standard Section	Test Item	Judgment	Remark
15.207	Conducted Emission	PASS	iMX8M_HMI_Platform contains FCC certified radio modules; hence antenna port measurements of certified modules are excluded. Refer FCC ID: VPYLBEE5HY1MW and FCC ID: QOQMGM111 of the certified radio modules
15.247 (a)(2)	6dB Bandwidth	NT	
15.247 (b)(3)	Output Power	NT	
15.247 (c)	Radiated Spurious Emission	PASS	
15.247 (d)	Conducted Spurious & Band Edge Emission	NT	
15.247 (e)	Power Spectral Density	NT	
15.205	Restricted Band Edge Emission	PASS	
Part 15.247(d)/part 15.209(a)	Band Edge Emission	NT	
15.203	Antenna Requirement	NT	

NOTE:

- (1) "N/A" denotes test is not applicable in this Test Report
- (2) "NT" Not tested in this Test Report
- (3) All tests are according to ANSI C63.10-2013



1.1 TEST FACTORY

Shenzhen STS Test Services Co., Ltd.

Add. : 1/F., Building B, Zhuoke Science Park, No.190, Chongqing Road,
Fuyong Street, Bao'an District, Shenzhen, Guangdong, China

FCC test Firm Registration Number: 625569

IC test Firm Registration Number: 12108A

A2LA Certificate No.: 4338.01

1.2 MEASUREMENT UNCERTAINTY

The reported uncertainty of measurement $y \pm U$, where expanded uncertainty U is based on a standard uncertainty multiplied by a coverage factor of $k=2$, providing a level of confidence of approximately **95 %**.

No.	Item	Uncertainty
1	RF output power, conducted	$\pm 0.71\text{dB}$
2	Unwanted Emissions, conducted	$\pm 0.63\text{dB}$
3	All emissions, radiated 30-200MHz	$\pm 3.43\text{dB}$
4	All emissions, radiated 200MHz-1GHz	$\pm 3.57\text{dB}$
5	All emissions, radiated >1G	$\pm 4.13\text{dB}$
6	Conducted Emission (9KHz-150KHz)	$\pm 3.18\text{dB}$
7	Conducted Emission (150KHz-30MHz)	$\pm 2.70\text{dB}$



2. GENERAL INFORMATION

2.1 GENERAL DESCRIPTION OF THE EUT

Product Name	iMX8M_HMI_Platform	
Trade Name	Thor96	
Model Name	Thor96	
Series Model	IMX-THOR96	
Model Difference	Only different in model name	
Product Description	The EUT is iMX8M_HMI_Platform	
	Operation Frequency:	2400~2483.5 MHz
	Modulation Type:	GFSK
	Radio Technology	BLE
	Bluetooth Version:	4.2 LE
	Number of Channel:	40
	Antenna Designation:	Please see Note 3.
Antenna Gain (dBi):	0.1 dBi	
Channel List	Please refer to the Note 2.	
Adapter	Input: AC100-240V, 1.5A, 50/60Hz Output: DC12V, 4A	
Hardware version number	Version2.0	
Software version number	V2.0	
Connecting I/O Port(s)	Please refer to the User's Manual	

Note:

1. For a more detailed features description, please refer to the manufacturer's specifications or the User's Manual.



2.

Channel List							
Channel	Frequency (MHz)	Channel	Frequency (MHz)	Channel	Frequency (MHz)	Channel	Frequency (MHz)
00	2402	10	2422	20	2442	30	2462
01	2404	11	2424	21	2444	31	2464
02	2406	12	2426	22	2446	32	2466
03	2408	13	2428	23	2448	33	2468
04	2410	14	2430	24	2450	34	2470
05	2412	15	2432	25	2452	35	2472
06	2414	16	2434	26	2454	36	2474
07	2416	17	2436	27	2456	37	2476
08	2418	18	2438	28	2458	38	2478
09	2420	19	2440	29	2460	39	2480

3.

Table for Filed Antenna

Ant.	Brand	Model Name	Antenna Type	Connector	Gain (dBi)	NOTE
1	Thor96	Thor96	PCB Antenna	N/A	0.1	BLE ANT.



2.2 DESCRIPTION OF THE TEST MODES

For conducted test items and radiated spurious emissions
Each of these EUT operation mode(s) or test configuration mode(s) mentioned below was evaluated respectively.

Worst Mode	Description	Data/Modulation
Mode 1	TX CH00(2402MHz)	1 Mbps/GFSK
Mode 2	TX CH19(2440MHz)	1 Mbps/GFSK
Mode 3	TX CH39(2480MHz)	1 Mbps/GFSK

Note:

- (1) The measurements are performed at all Bit Rate of Transmitter, the worst data was reported
- (2) We have be tested for all avaiable U.S. voltage and frequencies(For 120V,50/60Hz and 240V, 50/60Hz) for which the device is capable of operation, and the worst case of 120V/60Hz is shown in the report
- (3) Controlled using a bespoke application on the laptop PC supplied by the customer. The application was used to enable a continuous transmission mode and to select the test channels, data rates and modulation schemes as required.

AC Conducted Emission

Test Case	
AC Conducted Emission	TX Mode

2.3 TEST SOFTWARE AND POWER LEVEL SETTING

The test utility software used during testing was "Minicom", and the version was "v2.7.1".

Power Level setting:

Test mode	Power Level
GFSK	5

2.4 BLOCK DIGRAM SHOWING THE CONFIGURATION OF SYSTEM TESTED

Radiated Spurious Emission Test

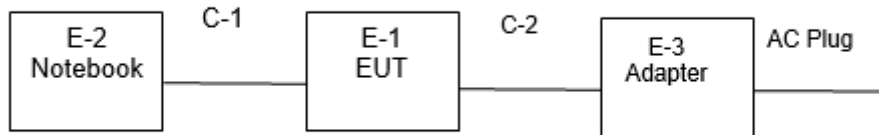

Conducted Emission Test

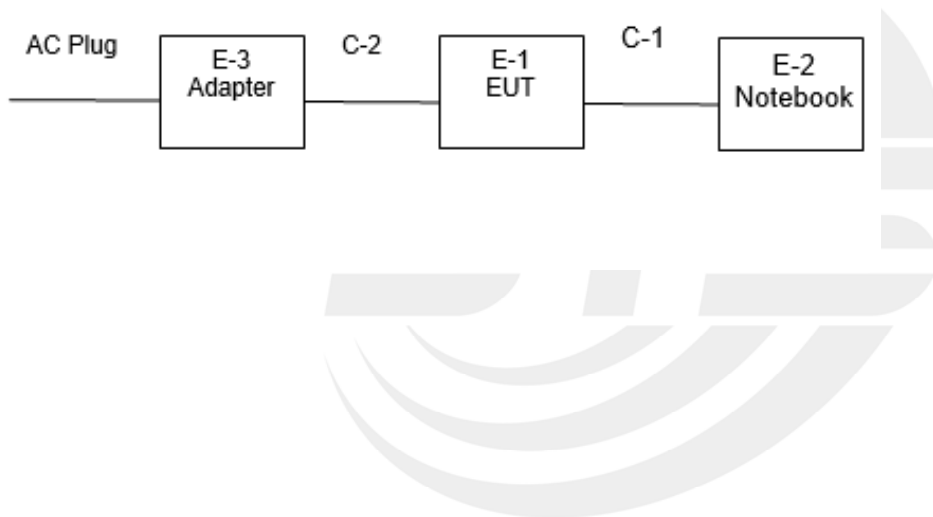



2.5 DESCRIPTION OF NECESSARY ACCESSORIES AND SUPPORT UNITS

The EUT has been tested as an independent unit together with other necessary accessories or support units. The following support units or accessories were used to form a representative test configuration during the tests.

Necessary accessories

Item	Equipment	Mfr/Brand	Model/Type No.	Serial No.	Note
E-3	Adapter	VOTOO (CHINA) CO., LTD	VP-1204000B	N/A	N/A
C-2	DC Cable	N/A	110cm	N/A	N/A

Support units

Item	Equipment	Mfr/Brand	Model/Type No.	Serial No.	Note
E-2	Notebook	DELL	VOSTRO.3800	N/A	N/A
C-1	UART to USB Cable	N/A	100cm	N/A	N/A
/	Display	Lenovo	ThinkvisionX1	NA	NA
/	Display	Lenovo	ThinkvisionX1	NA	NA
/	HDMI cable	TE Connectivity	1770019-1	NA	Ferrite cores S/N 74271112
/	HDMI cable	TE Connectivity	1770019-1	NA	Ferrite cores S/N 74275815
/	LAN cable	NA	NA	NA	Ferrite core S/N 74275815

Note:

- (1) The support equipment was authorized by Declaration of Confirmation.
- (2) For detachable type I/O cable should be specified the length in cm in 『Length』 column.
- (3) “YES” is means “shielded” “with core”; “NO” is means “unshielded” “without core”.



2.6 EQUIPMENTS LIST

Radiation Test equipment

Kind of Equipment	Manufacturer	Type No.	Serial No.	Last calibration	Calibrated until
Test Receiver	R&S	ESCI	101427	2019.07.29	2020.07.28
Signal Analyzer	Agilent	N9020A	MY51110105	2019.03.02	2020.03.01
Active loop Antenna	ZHINAN	ZN30900C	16035	2018.03.11	2021.03.10
Bilog Antenna	TESEQ	CBL6111D	34678	2017.11.02	2020.11.01
Horn Antenna	SCHWARZBECK	BBHA 9120D(1201)	9120D-1343	2018.10.19	2021.10.18
SHF-EHF Horn Antenna (18G-40GHz)	A-INFO	LB-180400-KF	J211020657	2018.03.11	2021.03.10
Pre-Amplifier(0.1M-3G Hz)	EM	EM330	060665	2019.10.09	2020.10.08
Pre-Amplifier (1G-18GHz)	SKET	LNPA-01018G-45	SK201808090 1	2019.10.09	2020.10.08
Temperature & Humidity	HH660	Mieo	N/A	2019.10.09	2020.10.08
turn table	EM	SC100_1	60531	N/A	N/A
Antenna mast	EM	SC100	N/A	N/A	N/A
Test SW	FARAD	EZ-EMC(Ver.STSLAB-03A1 RE)			

Conduction Test equipment

Kind of Equipment	Manufacturer	Type No.	Serial No.	Last calibration	Calibrated until
Test Receiver	R&S	ESCI	101427	2019.7.29	2020.7.28
LISN	R&S	ENV216	101242	2019.10.9	2020.10.8
LISN	EMCO	3810/2NM	23625	2019.10.9	2020.10.8
Temperature & Humidity	HH660	Mieo	N/A	2019.10.12	2020.10.11
Test SW	FARAD	EZ-EMC(Ver.STSLAB-03A1 CE)			

RF Connected Test

Kind of Equipment	Manufacturer	Type No.	Serial No.	Last calibration	Calibrated until
USB RF power sensor	DARE	RPR3006W	15I00041SNO03	2019.10.09	2020.10.08
Signal Analyzer	Agilent	N9020A	MY49100060	2019.10.09	2020.10.08
Temperature & Humidity	HH660	Mieo	N/A	2019.10.12	2020.10.11



3. EMC EMISSION TEST

3.1 CONDUCTED EMISSION MEASUREMENT

3.1.1 POWER LINE CONDUCTED EMISSION LIMITS

Operating frequency band. In case the emission fall within the restricted band specified on Part 207(a) limit in the table below has to be followed.

FREQUENCY (MHz)	Conducted Emissionlimit (dBUV)	
	Quasi-peak	Average
0.15 -0.5	66 - 56 *	56 - 46 *
0.50 -5.0	56.00	46.00
5.0 -30.0	60.00	50.00

Note:

- (1) The tighter limit applies at the band edges.
- (2) The limit of " * " marked band means the limitation decreases linearly with the logarithm of the frequency in the range.

The following table is the setting of the receiver

Receiver Parameters	Setting
Attenuation	10 dB
Start Frequency	0.15 MHz
Stop Frequency	30 MHz
IF Bandwidth	9 kHz

3.1.2 TEST PROCEDURE

- a. The EUT was 0.8 meters from the horizontal ground plane and 0.4 meters from the vertical ground plane with EUT being connected to the power mains through a line impedance stabilization network (LISN). All other support equipments powered from additional LISN(s). The LISN provide 50 Ohm/ 50uH of coupling impedance for the measuring instrument.
- b. Interconnecting cables that hang closer than 40 cm to the ground plane shall be folded back and forth in the center forming a bundle 30 to 40 cm long.
- c. I/O cables that are not connected to a peripheral shall be bundled in the center. The end of the cable may be terminated, if required, using the correct terminating impedance. The overall length shall not exceed 1 m.
- d. LISN at least 80 cm from nearest part of EUT chassis.
- e. For the actual test configuration, please refer to the related Item –EUT Test Photos.

3.1.3 TEST SETUP

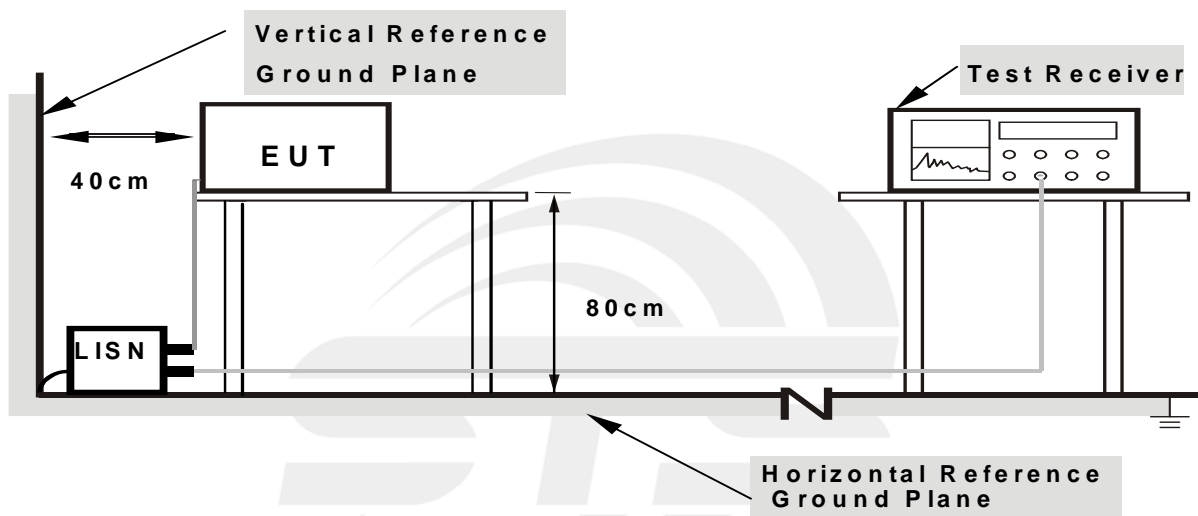

Note: 1. Support units were connected to second LISN.

2. Both of LISNs (AMN) are 80 cm from EUT and at least 80 cm from other units and other metal planes

3.1.4 EUT OPERATING CONDITIONS

The EUT was configured for testing in a typical fashion (as a customer would normally use it). The EUT has been programmed to continuously transmit during test. This operating condition was tested and used to collect the included data.



3.1.5 TEST RESULT

Note: In this case, when the product (ZigBee, BT, WLAN) functions are simultaneous transmission, AC conducted emissions are performed in accordance with the requirements of FCC Part 15 C Part 15.207. Only worst case test results are reported.

Temperature:	28 °C	Relative Humidity:	62%
Test Voltage:	AC 120V/60Hz	Phase:	L
Test Mode:	TX Mode(Worst Mode)		

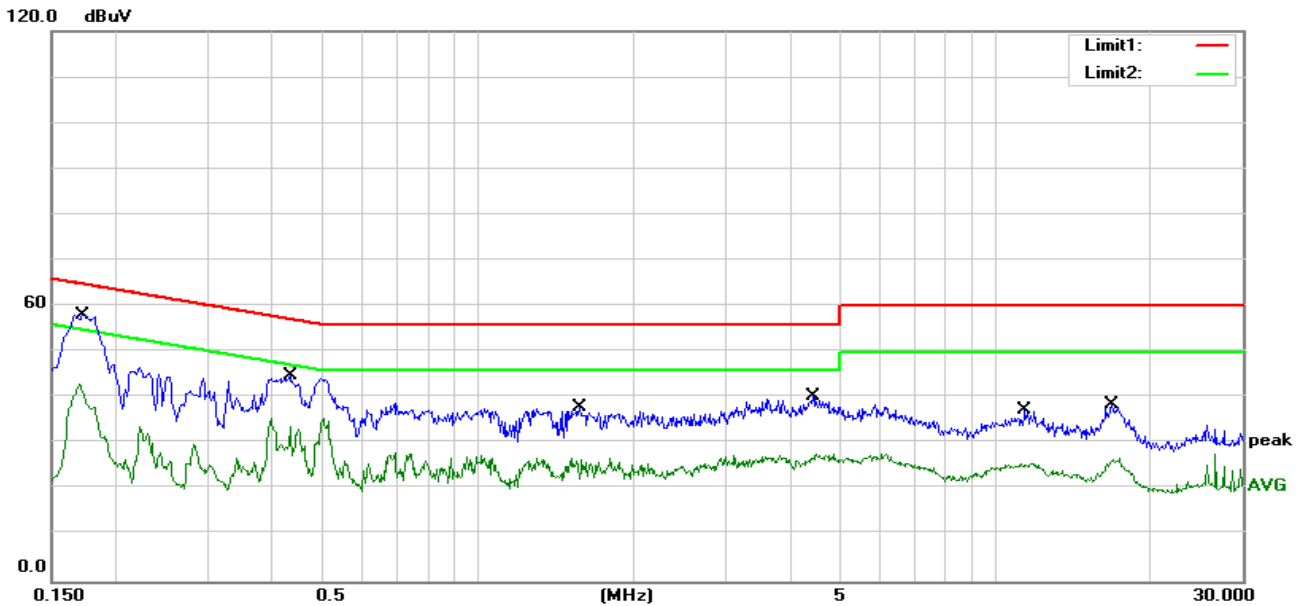

Remark:

1. All readings are Quasi-Peak and Average values.
2. Margin = Result (Result = Reading + Factor) – Limit

No.	Frequency (MHz)	Reading (dBuV)	Correct Factor(dB)	Result (dBuV)	Limit (dBuV)	Margin (dB)	Remark
1	0.1720	37.50	20.57	58.07	64.86	-6.79	QP
2	0.1720	22.39	20.57	42.96	54.86	-11.90	AVG
3	0.4340	24.54	20.18	44.72	57.18	-12.46	QP
4	0.4340	15.39	20.18	35.57	47.18	-11.61	AVG
5	1.5740	18.17	19.71	37.88	56.00	-18.12	QP
6	1.5740	7.19	19.71	26.90	46.00	-19.10	AVG
7	4.4540	20.12	20.34	40.46	56.00	-15.54	QP
8	4.4540	7.41	20.34	27.75	46.00	-18.25	AVG
9	11.3780	16.82	20.62	37.44	60.00	-22.56	QP
10	11.3780	5.12	20.62	25.74	50.00	-24.26	AVG
11	16.8340	17.59	20.99	38.58	60.00	-21.42	QP
12	16.8340	4.33	20.99	25.32	50.00	-24.68	AVG



Temperature:	28 °C	Relative Humidity:	62%
Test Voltage:	AC 120V/60Hz	Phase:	N
Test Mode:	TX Mode(Worst Mode)		

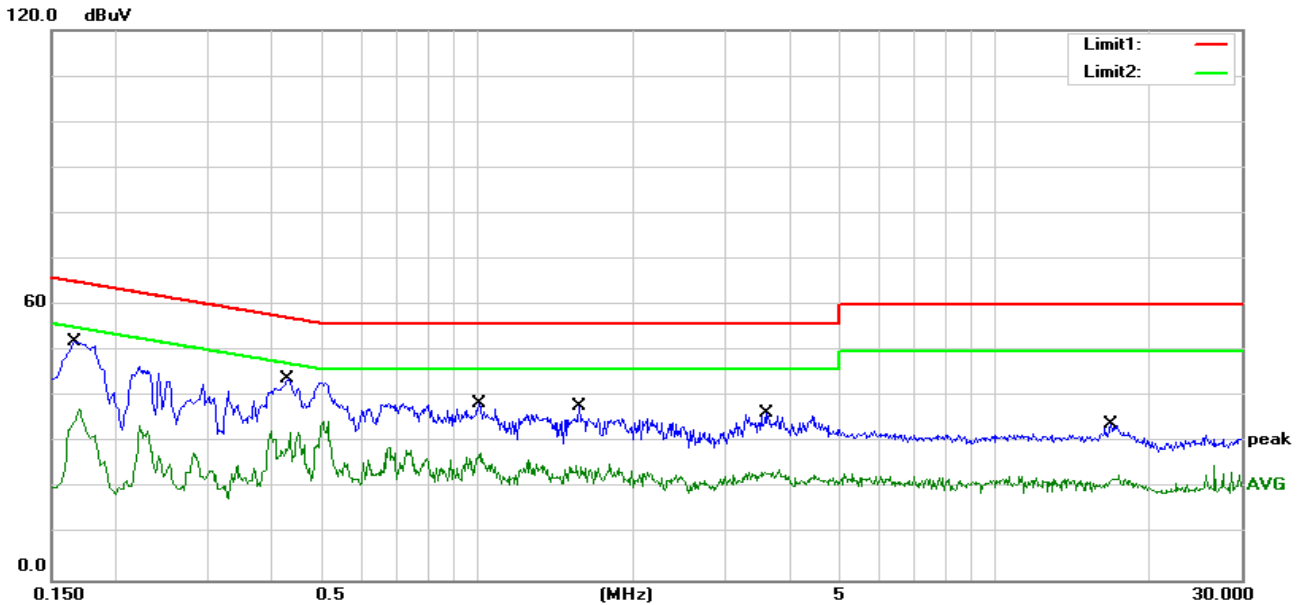

Remark:

1. All readings are Quasi-Peak and Average values.
2. Margin = Result (Result = Reading + Factor) – Limit

No.	Frequency (MHz)	Reading (dBuV)	Correct Factor(dB)	Result (dBuV)	Limit (dBuV)	Margin (dB)	Remark
1	0.1660	31.46	20.57	52.03	65.16	-13.13	QP
2	0.1660	16.89	20.57	37.46	55.16	-17.70	AVG
3	0.4304	23.68	20.19	43.87	57.24	-13.37	QP
4	0.4304	14.39	20.19	34.58	47.24	-12.66	AVG
5	1.0100	19.09	19.41	38.50	56.00	-17.50	QP
6	1.0100	8.46	19.41	27.87	46.00	-18.13	AVG
7	1.5740	18.17	19.71	37.88	56.00	-18.12	QP
8	1.5740	5.67	19.71	25.38	46.00	-20.62	AVG
9	3.6140	16.14	20.24	36.38	56.00	-19.62	QP
10	3.6140	3.79	20.24	24.03	46.00	-21.97	AVG
11	16.8340	13.09	20.99	34.08	60.00	-25.92	QP
12	16.8340	1.81	20.99	22.80	50.00	-27.20	AVG



3.2 RADIATED EMISSION MEASUREMENT

3.2.1 Radiated Emission Limits

in any 100 kHz bandwidth outside the operating frequency band. In case the emission fall within the Restricted band specified on RSS-247 Issue 2 limit in the table and according to ANSI C63.10-2013 below has to be followed.

LIMITS OF RADIATED EMISSION MEASUREMENT (Frequency Range 9kHz-1000MHz)

Frequencies (MHz)	Field Strength (micorvolts/meter)	Measurement Distance (meters)
0.009~0.490	2400/F(KHz)	300
0.490~1.705	24000/F(KHz)	30
1.705~30.0	30	30
30~88	100	3
88~216	150	3
216~960	200	3
Above 960	500	3

LIMITS OF RADIATED EMISSION MEASUREMENT (Above 1000MHz)

FREQUENCY (MHz)	(dBuV/m) (at 3M)	
	PEAK	AVERAGE
Above 1000	74	54

Notes:

- (1) The limit for radiated test was performed according to FCC PART 15C.
- (2) The tighter limit applies at the band edges.
- (3) Emission level (dBuV/m)=20log Emission level (uV/m).

For Radiated Emission

Spectrum Parameter	Setting
Attenuation	Auto
Detector	Peak
Start Frequency	1000 MHz(Peak/AV)
Stop Frequency	10th carrier hamonic(Peak/AV)
RB / VB (emission in restricted band)	1 MHz / 3 MHz

For Band edge

Spectrum Parameter	Setting
Detector	Peak
Start/Stop Frequency	Lower Band Edge: 2300 to 2403 MHz Upper Band Edge: 2479 to 2500 MHz
RB / VB (emission in restricted band)	1 MHz / 3 MHz



Receiver Parameter	Setting
Start ~ Stop Frequency	9kHz~90kHz / RB 200Hz for PK & AV
Start ~ Stop Frequency	90kHz~110kHz / RB 200Hz for QP
Start ~ Stop Frequency	110kHz~490kHz / RB 200Hz for PK & AV
Start ~ Stop Frequency	490kHz~30MHz / RB 9kHz for QP
Start ~ Stop Frequency	30MHz~1000MHz / RB 120kHz for QP

3.2.2 TEST PROCEDURE

- The measuring distance of at 3 m shall be used for measurements at frequency 0.009MHz up to 1GHz, and above 1GHz.
- The EUT was placed on the top of a rotating table 0.8 meters(above 1GHz is 1.5 m) above the ground at a 3 meter anechoic chamber. The table was rotated 360 degrees to determine the position of the highest radiation.
- The height of the equipment shall be 0.8 m(above 1GHz is 1.5 m); the height of the test antenna shall vary between 1 m to 4 m. Horizontal and vertical polarizations of the antenna are set to make the measurement
- The initial step in collecting conducted emission data is a spectrum analyzer peak detector mode pre-scanning the measurement frequency range. Significant peaks are then marked and then Quasi Peak detector mode re-measured.
- If the Peak Mode measured value compliance with and lower than Quasi Peak Mode Limit, the EUT shall be deemed to meet QP Limits and then no additional QP Mode measurement performed.
- For the actual test configuration, please refer to the related Item –EUT Test Photos.

Note:

Both horizontal and vertical antenna polarities were tested and performed pretest to three orthogonal axis. The worst case emissions were reported.

3.2.3 TEST SETUP

(A) Radiated Emission Test-Up Frequency Below 30MHz

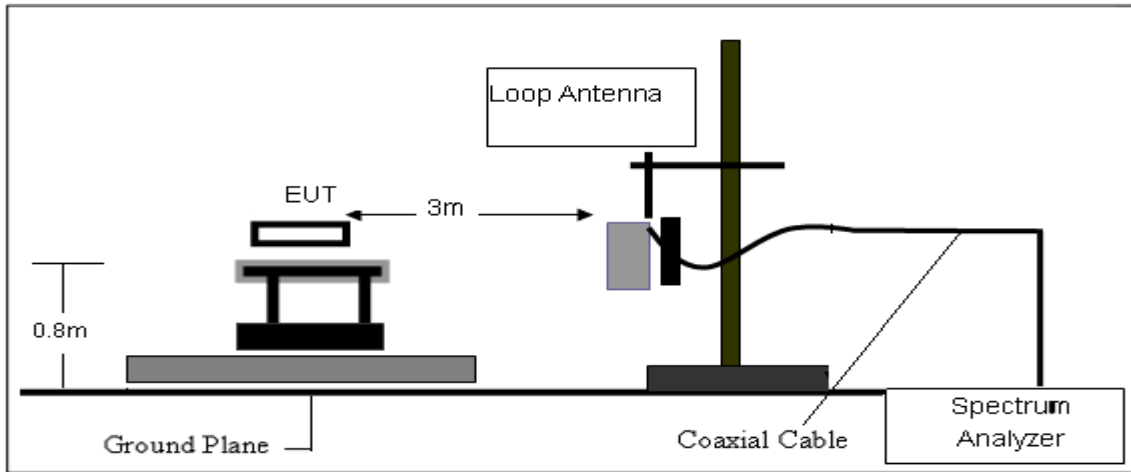

(B) Radiated Emission Test-Up Frequency 30MHz~1GHz

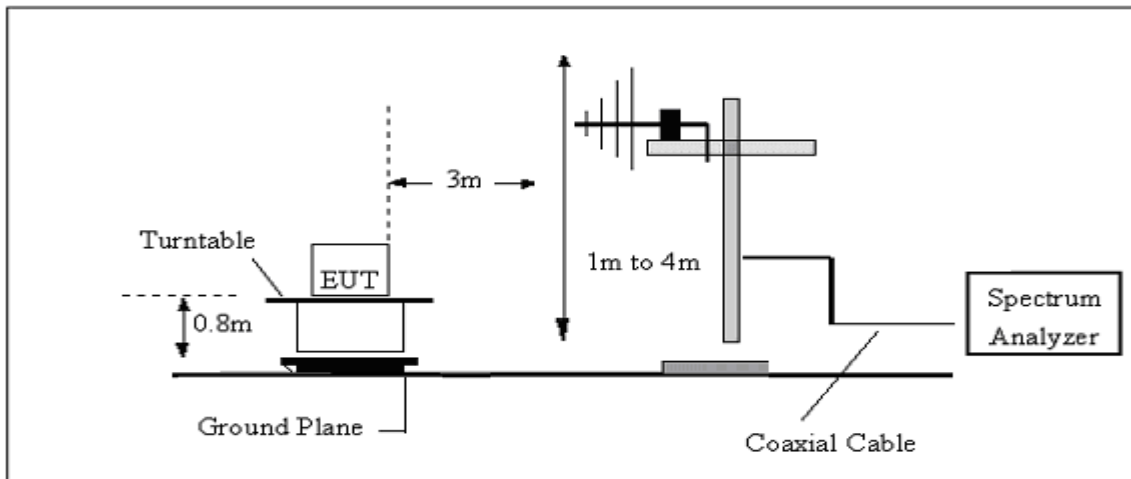

(C) Radiated Emission Test-Up Frequency Above 1GHz

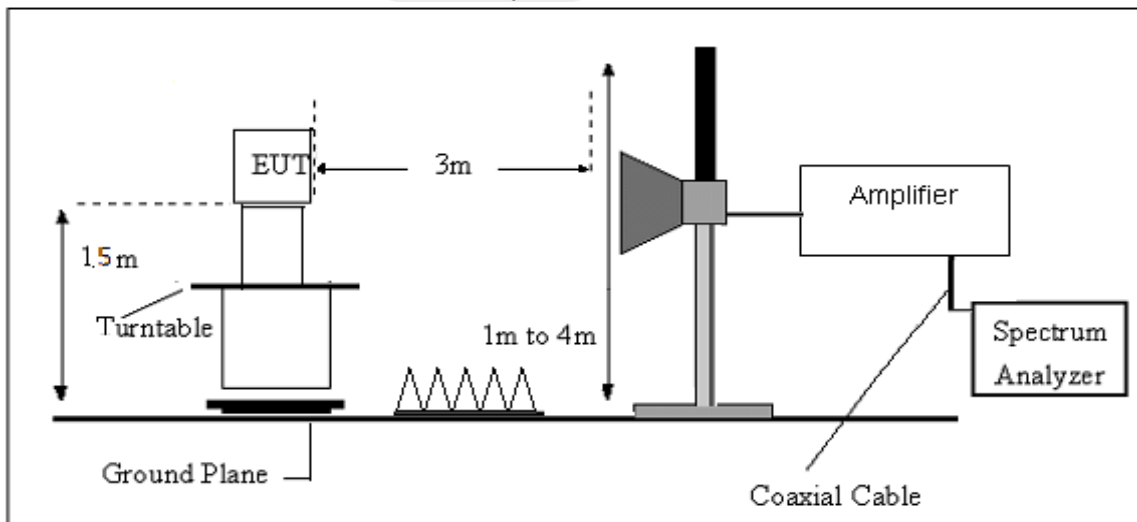

3.2.4 EUT OPERATING CONDITIONS

The EUT tested system was configured as the statements of 2.3 Unless otherwise a special operating condition is specified in the follows during the testing.



3.2.5 FIELD STRENGTH CALCULATION

The field strength is calculated by adding the Antenna Factor and Cable Factor and subtracting the Amplifier Gain and Duty Cycle Correction Factor (if any) from the measured reading. The basic equation with a sample calculation is as follows:

$$FS = RA + AF + CL - AG$$

Where

FS = Field Strength

CL = Cable Attenuation Factor (Cable Loss)

RA = Reading Amplitude

AG = Amplifier Gain

AF = Antenna Factor

For example

Frequency (MHz)	FS (dB μ V/m)	RA (dB μ V/m)	AF (dB)	CL (dB)	AG (dB)	Factor (dB)
300	40	58.1	12.2	1.6	31.9	-18.1

$$\text{Factor} = \text{AF} + \text{CL} - \text{AG}$$





3.2.6 TEST RESULTS

(Between 9KHz – 30 MHz)

Temperature:	25.8 °C	Relative Humidity:	69%
Test Voltage:	AC 120V/60Hz	Polarization:	--
Test Mode:	TX Mode		

Freq. (MHz)	Reading (dBuV/m)	Limit (dBuV/m)	Margin (dB)	State P/F
--	--	--	--	PASS
--	--	--	--	PASS

Note:

The amplitude of spurious emissions which are attenuated by more than 20dB below the permissible value has no need to be reported.

Distance extrapolation factor = $40 \log(\text{specific distance}/\text{test distance})$ (dB);

Limit line = specific limits(dBuv) + distance extrapolation factor.



(30MHz -1000MHz)

Temperature:	25.8 °C	Relative Humidity:	69%
Test Voltage:	AC 120V/60Hz	Phase:	Horizontal
Test Mode:	Mode 1/2/3 (Mode 1 worst mode)		

Frequency (MHz)	Reading (dBuV)	Correct Factor(dB/m)	Result (dBuV/m)	Limit (dBuV/m)	Margin (dB)	Remark
111.4800	50.99	-18.92	32.07	43.50	-11.43	QP
223.0300	52.30	-19.42	32.88	46.00	-13.12	QP
371.4400	54.10	-12.46	41.64	46.00	-4.36	QP
556.7100	38.52	-5.58	32.94	46.00	-13.06	QP
692.5100	36.52	-4.29	32.23	46.00	-13.77	QP
934.0400	32.53	0.89	33.42	46.00	-12.58	QP

Remark:

1. Margin = Result (Result =Reading + Factor)–Limit

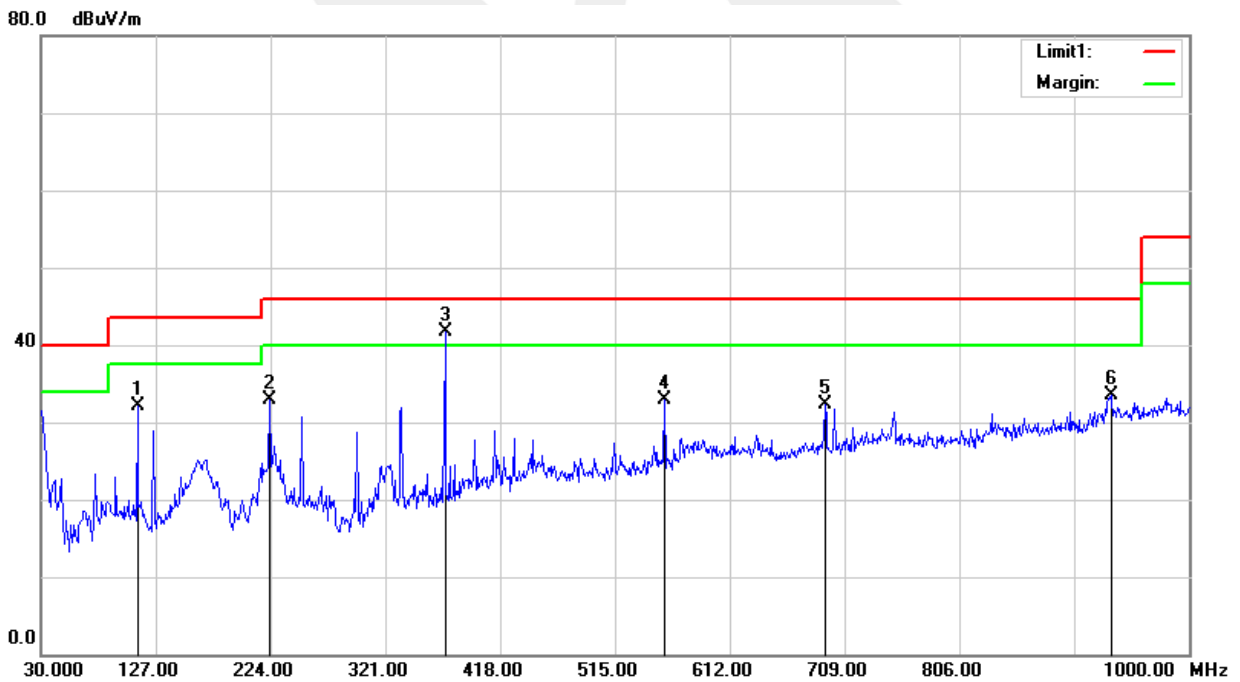



Temperature:	25.8 °C	Relative Humidity:	69%
Test Voltage:	AC 120V/60Hz	Phase:	Vertical
Test Mode:	Mode 1/2/3 (Mode 1 worst mode)		

Frequency (MHz)	Reading (dBuV)	Correct Factor(dB/m)	Result (dBuV/m)	Limit (dBuV/m)	Margin (dB)	Remark
47.4600	59.19	-21.92	37.27	40.00	-2.73	QP
125.0600	47.45	-18.22	29.23	43.50	-14.27	QP
371.4400	50.91	-12.46	38.45	46.00	-7.55	QP
556.7100	37.87	-5.58	32.29	46.00	-13.71	QP
833.1600	35.33	-0.62	34.71	46.00	-11.29	QP
932.1000	36.06	0.72	36.78	46.00	-9.22	QP

Remark:

1. Margin = Result (Result =Reading + Factor)–Limit

80.0 dBuV/m

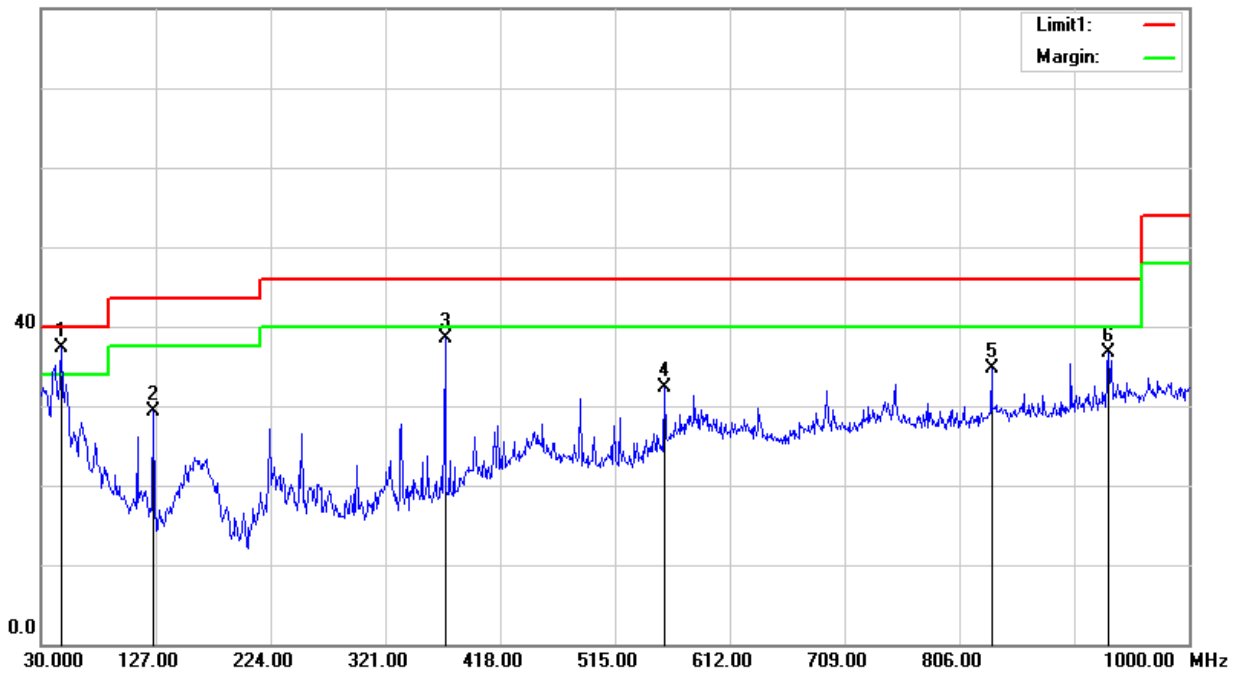



(1GHz-25GHz)Restricted band and Spurious emission Requirements

Low Channel Horizontal

Frequency (MHz)	Peak Reading (dBuV/m)	Average Reading (dBuV/m)	Factor (dB)	Peak Level (dBuV/m)	Average Level (dBuV/m)	PK Limit (dBuV/m)	AV Limit (dBuV/m)	Margin(dB)	ANT
1046.5	41.80	35.06	-1.58	40.22	33.48	74.00	54.00	-13.78	Horizontal
2132.5	40.93	33.27	5.56	46.49	38.83	74.00	54.00	-15.17	Horizontal
2700	40.95	31.74	6.73	47.68	38.47	74.00	54.00	-15.53	Horizontal
5330	54.02	42.56	-3.52	50.50	39.04	74.00	54.00	-14.96	Horizontal
10960	49.01	39.73	10.08	59.09	49.81	74.00	54.00	-4.19	Horizontal
14913.75	49.72	39.67	12.38	62.10	52.05	74.00	54.00	-1.95	Horizontal

Vertical

Frequency (MHz)	Peak Reading (dBuV/m)	Average Reading (dBuV/m)	Factor (dB)	Peak Level (dBuV/m)	Average Level (dBuV/m)	PK Limit (dBuV/m)	AV Limit (dBuV/m)	Margin(dB)	ANT
1260	43.20	32.91	-0.59	42.61	32.32	74.00	54.00	-11.39	Vertical
2200	40.91	30.02	5.19	46.10	35.21	74.00	54.00	-18.79	Vertical
3890	53.37	44.93	-8.34	45.03	36.59	74.00	54.00	-17.41	Vertical
5395	59.84	46.75	-3.52	56.32	43.23	74.00	54.00	-10.77	Vertical
11012.5	48.95	38.96	10.25	59.20	49.21	74.00	54.00	-4.79	Vertical
14903.75	49.76	40.01	12.38	62.14	52.39	74.00	54.00	-1.61	Vertical



Mid Channel Horizontal

Frequency (MHz)	Peak Reading (dBuV/m)	Average Reading (dBuV/m)	Factor (dB)	Peak Level (dBuV/m)	Average Level (dBuV/m)	PK Limit (dBuV/m)	AV Limit (dBuV/m)	Margin(dB)	ANT
1047.5	42.37	36.10	-1.57	40.80	34.53	74.00	54.00	-13.20	Horizontal
1670.5	42.86	35.29	0.36	43.22	35.65	74.00	54.00	-18.35	Horizontal
2696.5	40.21	30.69	6.72	46.93	37.41	74.00	54.00	-16.59	Horizontal
5330	55.08	42.47	-3.52	51.56	38.95	74.00	54.00	-15.05	Horizontal
10917.5	49.61	39.77	9.82	59.43	49.59	74.00	54.00	-4.41	Horizontal
14941.25	49.33	39.06	12.38	61.71	51.44	74.00	54.00	-2.56	Horizontal

Vertical

Frequency (MHz)	Peak Reading (dBuV/m)	Average Reading (dBuV/m)	Factor (dB)	Peak Level (dBuV/m)	Average Level (dBuV/m)	PK Limit (dBuV/m)	AV Limit (dBuV/m)	Margin(dB)	ANT
1671	43.61	39.16	0.35	43.96	39.51	74.00	54.00	-10.04	Vertical
2996	39.25	29.61	8.03	47.28	37.64	74.00	54.00	-16.36	Vertical
5380	58.68	41.46	-3.52	55.16	37.94	74.00	54.00	-16.06	Vertical
8062.5	49.59	39.01	4.8	54.39	43.81	74.00	54.00	-10.19	Vertical
11382.5	49.95	38.70	9.71	59.66	48.41	74.00	54.00	-5.59	Vertical
14886.25	49.42	39.99	12.26	61.68	52.25	74.00	54.00	-1.75	Vertical



High Channel Horizontal

Frequency (MHz)	Peak Reading (dBuV/m)	Average Reading (dBuV/m)	Factor (dB)	Peak Level (dBuV/m)	Average Level (dBuV/m)	PK Limit (dBuV/m)	AV Limit (dBuV/m)	Margin(dB)	ANT
1046	41.53	35.71	-1.58	39.95	34.13	74.00	54.00	-14.05	Horizontal
2402.5	42.54	29.19	5.13	47.67	34.32	74.00	54.00	-19.68	Horizontal
3497.5	53.30	43.62	-10.05	43.25	33.57	74.00	54.00	-20.43	Horizontal
5330	54.69	43.02	-3.52	51.17	39.50	74.00	54.00	-14.50	Horizontal
10952.5	49.74	39.56	10.04	59.78	49.60	74.00	54.00	-4.40	Horizontal
1046	41.53	35.71	-1.58	39.95	34.13	74.00	54.00	-14.05	Horizontal

Vertical

Frequency (MHz)	Peak Reading (dBuV/m)	Average Reading (dBuV/m)	Factor (dB)	Peak Level (dBuV/m)	Average Level (dBuV/m)	PK Limit (dBuV/m)	AV Limit (dBuV/m)	Margin(dB)	ANT
1277	43.44	33.16	-0.42	43.02	32.74	74.00	54.00	-10.98	Vertical
2132	40.39	32.15	5.53	45.92	37.68	74.00	54.00	-16.32	Vertical
3245	55.42	47.08	-10.77	44.65	36.31	74.00	54.00	-17.69	Vertical
5382.5	59.31	46.85	-3.52	55.79	43.33	74.00	54.00	-10.67	Vertical
10970	49.17	39.56	10.14	59.31	49.70	74.00	54.00	-4.30	Vertical
15015	50.22	39.02	12.14	62.36	51.16	74.00	54.00	-2.84	Vertical



Low Channel(Worst case waveform) Horizontal

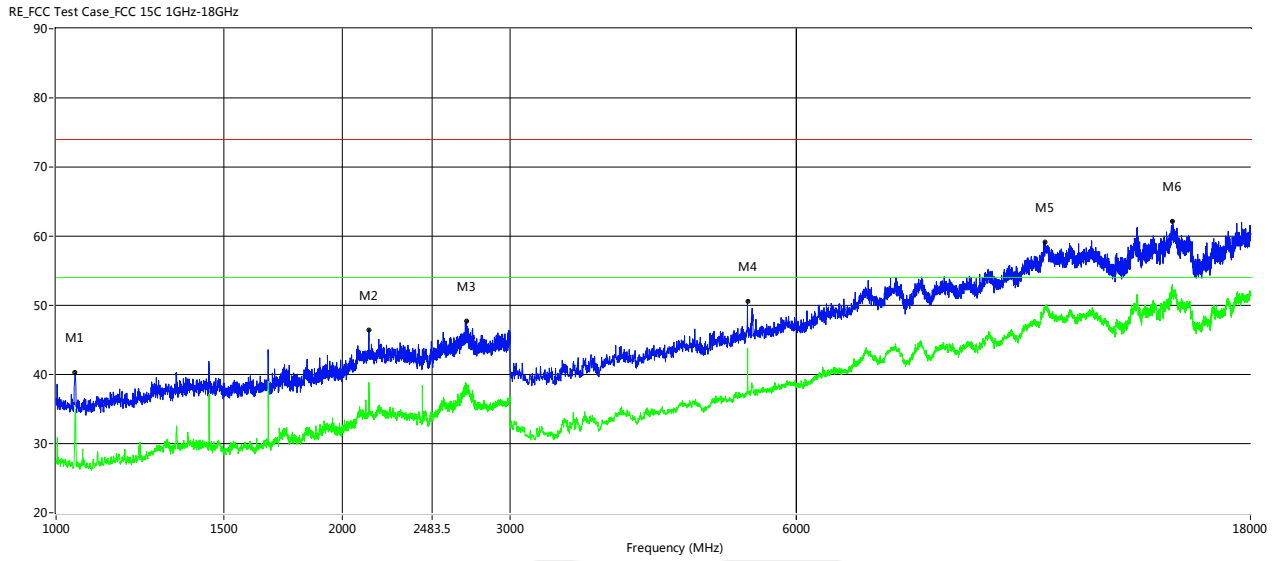

Vertical

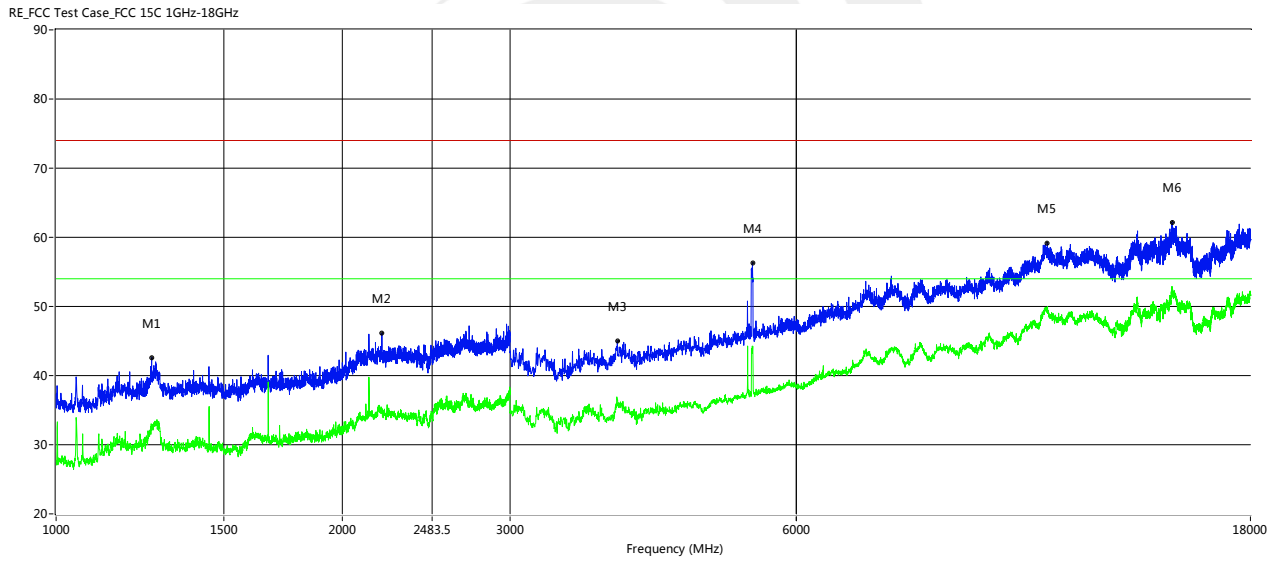

Note: All mode have been test, only showing the worst case waveform plot in this report.



3.6 TEST RESULTS (Restricted Bands Requirements)

GFSK-Low
Horizontal

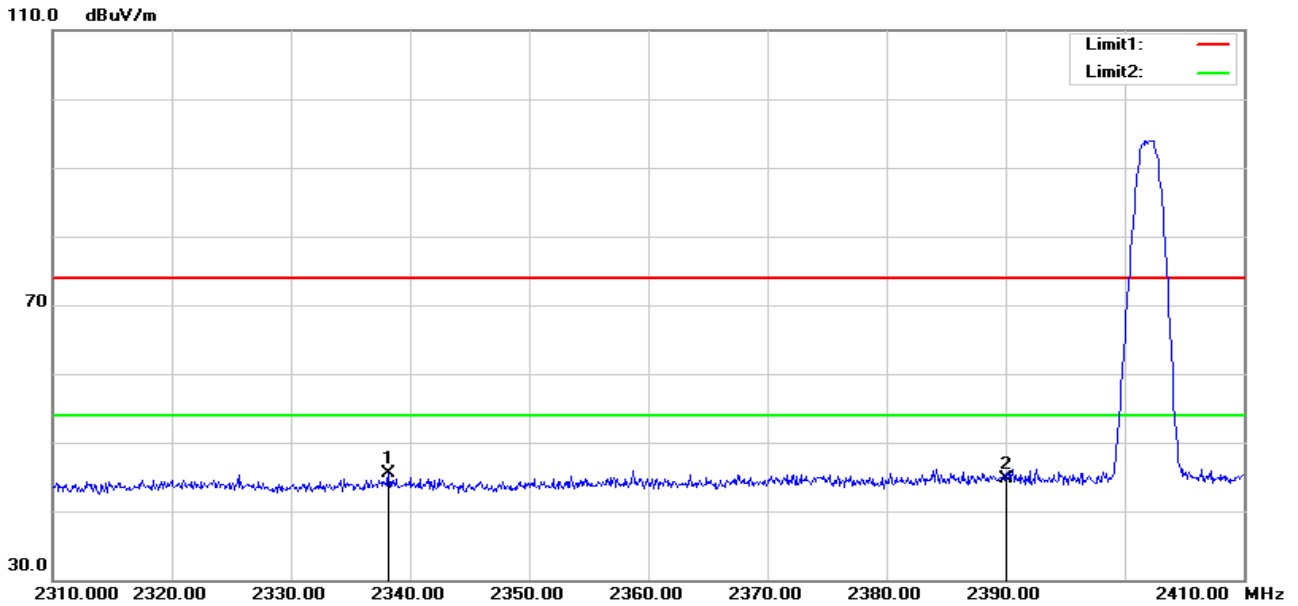

No.	Frequency (MHz)	Reading (dBuV)	Correct Factor(dB/m)	Result (dBuV/m)	Limit (dBuV/m)	Margin (dB)	Remark
1	2338.200	41.76	3.68	45.44	74.00	-28.56	peak
2	2390.000	40.31	4.34	44.65	74.00	-29.35	peak

Vertical

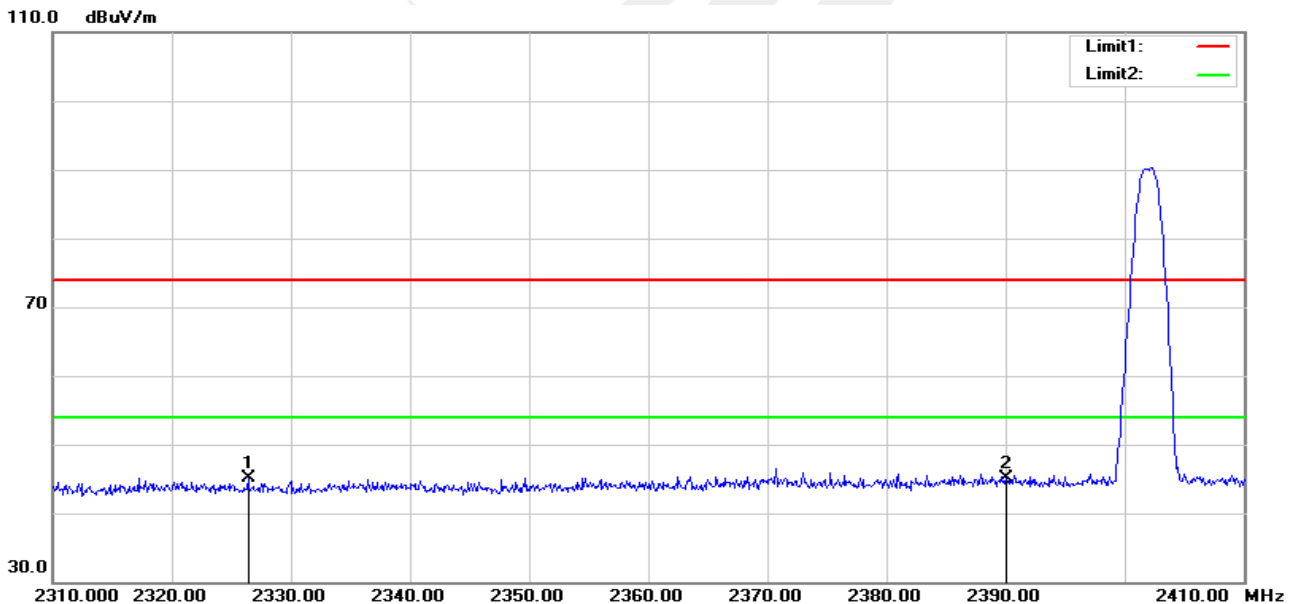

No.	Frequency (MHz)	Reading (dBuV)	Correct Factor(dB/m)	Result (dBuV/m)	Limit (dBuV/m)	Margin (dB)	Remark
1	2326.400	41.57	3.61	45.18	74.00	-28.82	peak
2	2390.000	40.68	4.34	45.02	74.00	-28.98	peak



GFSK-High
Horizontal

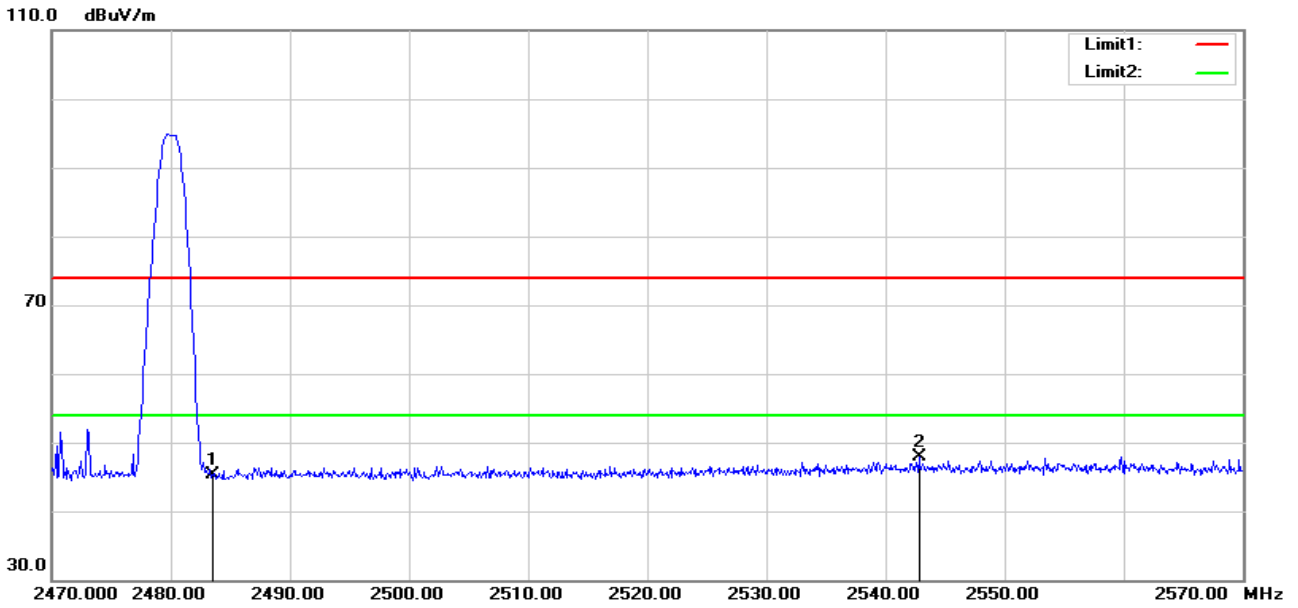

No.	Frequency (MHz)	Reading (dBuV)	Correct Factor(dB/m)	Result (dBuV/m)	Limit (dBuV/m)	Margin (dB)	Remark
1	2483.500	40.70	4.60	45.30	74.00	-28.70	peak
2	2542.800	42.98	4.93	47.91	74.00	-26.09	peak

Vertical

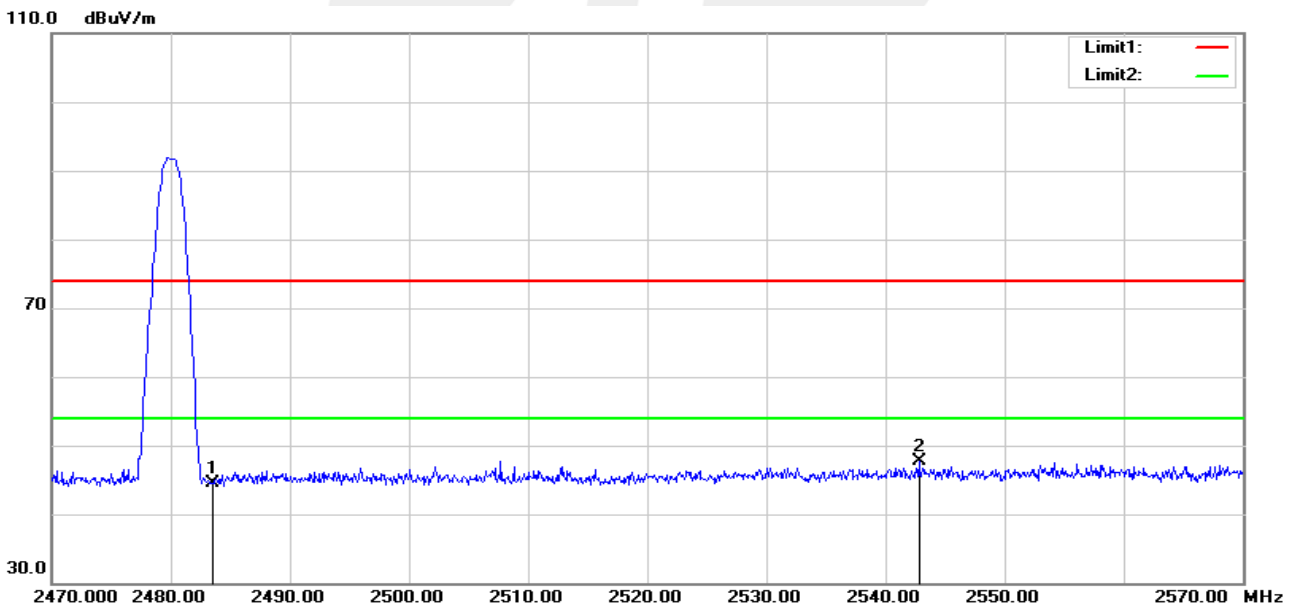

No.	Frequency (MHz)	Reading (dBuV)	Correct Factor(dB/m)	Result (dBuV/m)	Limit (dBuV/m)	Margin (dB)	Remark
1	2483.500	39.97	4.60	44.57	74.00	-29.43	peak
2	2542.800	42.80	4.93	47.73	74.00	-26.27	peak



4. EUT TEST PHOTO

Note: See test photos in setup photo document for the actual connections between Product and support equipment.

*****END OF THE REPORT*****

