



RADIO TEST REPORT

Report No: STS1909134W01

Issued for

Arrow Electronics, Inc

9201 East Dry Creek road Centennial, CO 80112 United States

Product Name:	iMX8M_HMI_Platform
Brand Name:	Thor96
Model Name:	Thor96
Series Model:	IMX-THOR96
FCC ID:	2AFQA-IMX-THOR96
Test Standard:	FCC Part 15.247

Any reproduction of this document must be done in full. No single part of this document may be reproduced without permission from STS, All Test Data Presented in this report is only applicable to presented Test sample.

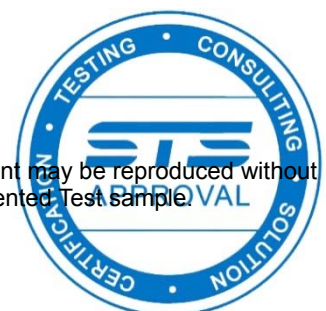



TEST RESULT CERTIFICATION

Applicant's Name.....: Arrow Electronics, Inc
 Address: 9201 East Dry Creek road Centennial, CO 80112 United States
Manufacture's Name: elinfochips - An Arrow company
 Address: 11- A/B, Chandra Colony, Behind Cargo Motors, Off C.G Road, Ellisbridge, Ahmedabad, Gujarat, India. Pin Code: 380006

Product Description

Product Name: iMX8M_HMI_Platform
 Brand Name: Thor96
 Model Name.....: Thor96
 Series Model: IMX-THOR96

Test Standards.....: FCC Part15.247
 Test Procedure.....: ANSI C63.10-2013

This device described above has been tested by STS, the test results show that the equipment under test (EUT) is in compliance with the FCC requirements. And it is applicable only to the tested sample identified in the report.
 This report shall not be reproduced except in full, without the written approval of STS, this document may be altered or revised by STS, personal only, and shall be noted in the revision of the document..

Date of Test.....:
 Date (s) of performance of tests.: 04 Sept. 2019 ~ 31 Oct. 2019
 Date of Issue: 31 Oct. 2019
 Test Result: Pass

Testing Engineer : 

 (Chris Chen)

Technical Manager : 

 (Sunday Hu)

Authorized Signatory : 

 (Vita Li)





Table of Contents	Page
1. SUMMARY OF TEST RESULTS	5
1.1 TEST FACTORY	6
1.2 MEASUREMENT UNCERTAINTY	6
2. GENERAL INFORMATION	7
2.1 GENERAL DESCRIPTION OF THE EUT	7
2.2 DESCRIPTION OF THE TEST MODES	9
2.3 TEST SOFTWARE AND POWER LEVEL SETTING	9
2.4 BLOCK DIGRAM SHOWING THE CONFIGURATION OF SYSTEM TESTED	10
2.5 DESCRIPTION OF NECESSARY ACCESSORIES AND SUPPORT UNITS	11
2.6 EQUIPMENTS LIST FOR ALL TEST ITEMS	12
3. EMC EMISSION TEST	13
3.1 CONDUCTED EMISSION MEASUREMENT	13
3.2 RADIATED EMISSION MEASUREMENT	17
4. EUT TEST PHOTO	40



Revision History

Rev.	Issue Date	Report NO.	Effect Page	Contents
00	31 Oct. 2019	STS1909134W01	ALL	Initial Issue



1. SUMMARY OF TEST RESULTS

Test procedures according to the technical standards:

KDB 558074 D01 15.247 Meas Guidance v05r02

FCC Part 15.247, Subpart C			
Standard Section	Test Item	Judgment	Remark
15.207	Conducted Emission	PASS	iMX8M_HMI_Platform contains FCC certified radio modules; hence antenna port measurements of certified modules are excluded. Refer FCC ID: VPYLBEE5HY1MW and FCC ID: QOQMGM111 of the certified radio modules
15.247(a)(1)	Hopping Channel Separation	NT	
15.247(a)(1)&(b)(1)	Output Power	NT	
15.247(c)	Radiated Spurious Emission	PASS	
15.247(d)	Conducted Spurious & Band Edge Emission	NT	
15.247(a)(iii)	Number of Hopping Frequency	NT	
15.247(a)(iii)	Dwell Time	NT	
15.247(a)(1)	Bandwidth	NT	
15.205	Restricted Band Edge Emission	PASS	
Part 15.247(d)/part 15.209(a)	Band Edge Emission	NT	
15.203	Antenna Requirement	NT	

NOTE:

(1) "N/A" denotes test is not applicable in this Test Report

(2) "NT" Not tested in this Test Report

(2) All tests are according to ANSI C63.10-2013



1.1 TEST FACTORY

Shenzhen STS Test Services Co., Ltd.

Add. : 1/F., Building B, Zhuoke Science Park, No.190, Chongqing Road,
Fuyong Street, Bao'an District, Shenzhen, Guangdong, China

FCC Registration No.: 625569

IC Registration No.: 12108A; A2LA Certificate No.: 4338.01;

1.2 MEASUREMENT UNCERTAINTY

The reported uncertainty of measurement $y \pm U$, where expanded uncertainty U is based on a standard uncertainty multiplied by a coverage factor of $k=2$, providing a level of confidence of approximately **95 %**.

No.	Item	Uncertainty
1	RF output power, conducted	± 0.71 dB
2	Unwanted Emissions, conducted	± 0.63 dB
3	All emissions, radiated 30-200MHz	± 3.43 dB
4	All emissions, radiated 200MHz-1GHz	± 3.57 dB
5	All emissions, radiated >1G	± 4.13 dB
6	Conducted Emission(9KHz-150KHz)	± 3.18 dB
7	Conducted Emission(150KHz-30MHz)	± 2.70 dB



2. GENERAL INFORMATION

2.1 GENERAL DESCRIPTION OF THE EUT

Product Name	iMX8M_HMI_Platform	
Trade Name	Thor96	
Model Name	Thor96	
Series Model	IMX-THOR96	
Model Difference	Only different in model name	
Product Description	The EUT is iMX8M_HMI_Platform	
	Operation Frequency:	2402~2480 MHz
	Modulation Type:	GFSK(1Mbps), $\pi/4$ -DQPSK(2Mbps), 8DPSK(3Mbps)
	Radio Technology	BT
	Bluetooth Version:	4.2 BR+EDR
	Number Of Channel:	79
	Antenna Designation:	Please see Note 3.
	Antenna Gain (dBi)	0.1 dBi
Channel List	Please refer to the Note 2.	
Adapter	Input: AC100-240V, 1.5A, 50/60Hz Output: DC12V, 4A	
Hardware version number	Version2.0	
Software version number	V2.0	
Connecting I/O Port(s)	Please refer to the User's Manual	

Note:

1. For a more detailed features description, please refer to the manufacturer's specifications or the User's Manual.



2.

Channel List					
Channel	Frequency (MHz)	Channel	Frequency (MHz)	Channel	Frequency (MHz)
00	2402	27	2429	54	2456
01	2403	28	2430	55	2457
02	2404	29	2431	56	2458
03	2405	30	2432	57	2459
04	2406	31	2433	58	2460
05	2407	32	2434	59	2461
06	2408	33	2435	60	2462
07	2409	34	2436	61	2463
08	2410	35	2437	62	2464
09	2411	36	2438	63	2465
10	2412	37	2439	64	2466
11	2413	38	2440	65	2467
12	2414	39	2441	66	2468
13	2415	40	2442	67	2469
14	2416	41	2443	68	2470
15	2417	42	2444	69	2471
16	2418	43	2445	70	2472
17	2419	44	2446	71	2473
18	2420	45	2447	72	2474
19	2421	46	2448	73	2475
20	2422	47	2449	74	2476
21	2423	48	2450	75	2477
22	2424	49	2451	76	2478
23	2425	50	2452	77	2479
24	2426	51	2453	78	2480
25	2427	52	2454		
26	2428	53	2455		

3. Table for Filed Antenna

Ant	Brand	Model Name	Antenna Type	Connector	Gain (dBi)	NOTE
1	Thor96	Thor96	PCB Antenna	N/A	0.1	BT Antenna



2.2 DESCRIPTION OF THE TEST MODES

To investigate the maximum EMI emission characteristics generated from EUT, the test system was pre-scanning tested based on the consideration of following EUT operation mode or test configuration mode which possibly have effect on EMI emission level. Each of these EUT operation mode(s) or test configuration mode(s) mentioned above was evaluated respectively.

Worst Mode	Description	Data Rate/Modulation
Mode 1	TX CH00	1Mbps/GFSK
Mode 2	TX CH39	1Mbps/GFSK
Mode 3	TX CH78	1Mbps/GFSK
Mode 4	TX CH00	2 Mbps/ $\pi/4$ -DQPSK
Mode 5	TX CH39	2 Mbps/ $\pi/4$ -DQPSK
Mode 6	TX CH78	2 Mbps/ $\pi/4$ -DQPSK
Mode 7	TX CH00	3 Mbps/8DPSK
Mode 8	TX CH39	3 Mbps/8DPSK
Mode 9	TX CH78	3 Mbps/8DPSK

Note:

- (1) The measurements are performed at all Bit Rate of Transmitter, the worst data was reported
- (2) We have been tested for all available U.S. voltage and frequencies (For 120V, 50/60Hz and 240V, 50/60Hz) for which the device is capable of operation, and the worst case of 120V/ 60Hz is shown in the report
- (3) Controlled using a bespoke application on the laptop PC supplied by the customer. The application was used to enable a continuous transmission mode and to select the test channels, data rates and modulation schemes as required.

AC Conducted Emission

Test Case	
AC Conducted Emission	TX Mode

2.3 TEST SOFTWARE AND POWER LEVEL SETTING

The test utility software used during testing was "Minicom", and the version was "v2.7.1".

Power Level setting:

Test mode	Power Level
GFSK	8
$\pi/4$ -DQPSK	8
8DPSK	5



2.4 BLOCK DIGRAM SHOWING THE CONFIGURATION OF SYSTEM TESTED Radiated Spurious Emission Test

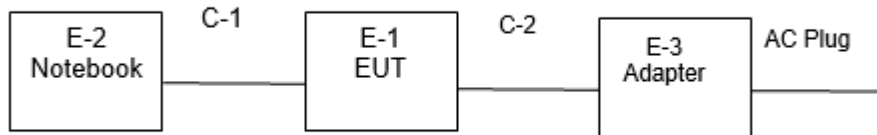

Conducted Emission Test

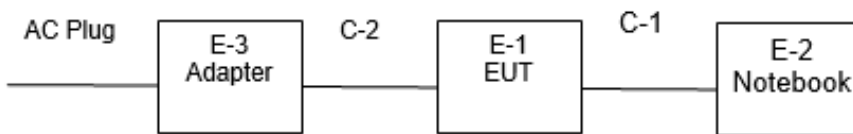



2.5 DESCRIPTION OF NECESSARY ACCESSORIES AND SUPPORT UNITS

The EUT has been tested as an independent unit together with other necessary accessories or support units. The following support units or accessories were used to form a representative test configuration during the tests.

Necessary accessories

Item	Equipment	Mfr/Brand	Model/Type No.	Serial No.	Note
E-3	Adapter	VOTOO (CHINA) CO., LTD	VP-1204000B	N/A	N/A
C-2	DC Cable	N/A	110cm	N/A	N/A

Support units

Item	Equipment	Mfr/Brand	Model/Type No.	Serial No.	Note
E-2	Notebook	DELL	VOSTRO.3800	N/A	N/A
C-1	UART to USB Cable	N/A	100cm	N/A	N/A
/	Display	Lenovo	ThinkvisionX1	NA	NA
/	Display	Lenovo	ThinkvisionX1	NA	NA
/	HDMI cable	TE Connectivity	1770019-1	NA	Ferrite cores S/N 74271112
/	HDMI cable	TE Connectivity	1770019-1	NA	Ferrite cores S/N 74275815
/	LAN cable	NA	NA	NA	Ferrite core S/N 74275815

Note:

- (1) The support equipment was authorized by Declaration of Confirmation.
- (2) For detachable type I/O cable should be specified the length in cm in 『Length』 column.
- (3) “YES” is means “shielded” “with core”; “NO” is means “unshielded” “without core”.



2.6 EQUIPMENTS LIST FOR ALL TEST ITEMS

Radiation Test equipment

Kind of Equipment	Manufacturer	Type No.	Serial No.	Last calibration	Calibrated until
Test Receiver	R&S	ESCI	101427	2019.07.29	2020.07.28
Signal Analyzer	Agilent	N9020A	MY51110105	2019.03.02	2020.03.01
Active loop Antenna	ZHINAN	ZN30900C	16035	2018.03.11	2021.03.10
Bilog Antenna	TESEQ	CBL6111D	34678	2017.11.02	2020.11.01
Horn Antenna	SCHWARZBECK	BBHA 9120D(1201)	9120D-1343	2018.10.19	2021.10.18
SHF-EHF Horn Antenna (18G-40GHz)	A-INFO	LB-180400-KF	J211020657	2018.03.11	2021.03.10
Pre-Amplifier(0.1M-3G Hz)	EM	EM330	060665	2019.10.09	2020.10.08
Pre-Amplifier (1G-18GHz)	SKET	LNPA-01018G-45	SK201808090 1	2019.10.09	2020.10.08
Temperature & Humidity	HH660	Mieo	N/A	2019.10.09	2020.10.08
turn table	EM	SC100_1	60531	N/A	N/A
Antenna mast	EM	SC100	N/A	N/A	N/A
Test SW	FARAD	EZ-EMC(Ver.STSLAB-03A1 RE)			

Conduction Test equipment

Kind of Equipment	Manufacturer	Type No.	Serial No.	Last calibration	Calibrated until
Test Receiver	R&S	ESCI	101427	2019.7.29	2020.7.28
LISN	R&S	ENV216	101242	2019.10.9	2020.10.8
LISN	EMCO	3810/2NM	23625	2019.10.9	2020.10.8
Temperature & Humidity	HH660	Mieo	N/A	2019.10.12	2020.10.11
Test SW	FARAD	EZ-EMC(Ver.STSLAB-03A1 CE)			

RF Connected Test

Kind of Equipment	Manufacturer	Type No.	Serial No.	Last calibration	Calibrated until
USB RF power sensor	DARE	RPR3006W	15I00041SNO03	2019.10.09	2020.10.08
Signal Analyzer	Agilent	N9020A	MY49100060	2019.10.09	2020.10.08
Temperature & Humidity	HH660	Mieo	N/A	2019.10.12	2020.10.11



3. EMC EMISSION TEST

3.1 CONDUCTED EMISSION MEASUREMENT

3.1.1 POWER LINE CONDUCTED EMISSION LIMITS

Operating frequency band. In case the emission fall within the restricted band specified on Part 207(a) limit in the table below has to be followed.

FREQUENCY (MHz)	Conducted Emissionlimit (dBuV)	
	Quasi-peak	Average
0.15 -0.5	66 - 56 *	56 - 46 *
0.50 -5.0	56.00	46.00
5.0 -30.0	60.00	50.00

Note:

- (1) The tighter limit applies at the band edges.
- (2) The limit of " * " marked band means the limitation decreases linearly with the logarithm of the frequency in the range.

The following table is the setting of the receiver

Receiver Parameters	Setting
Attenuation	10 dB
Start Frequency	0.15 MHz
Stop Frequency	30 MHz
IF Bandwidth	9 kHz

3.1.2 TEST PROCEDURE

- a. The EUT was 0.8 meters from the horizontal ground plane and 0.4 meters from the vertical ground plane with EUT being connected to the power mains through a line impedance stabilization network (LISN). All other support equipments powered from additional LISN(s). The LISN provide 50 Ohm/ 50uH of coupling impedance for the measuring instrument.
- b. Interconnecting cables that hang closer than 40 cm to the ground plane shall be folded back and forth in the center forming a bundle 30 to 40 cm long.
- c. I/O cables that are not connected to a peripheral shall be bundled in the center. The end of the cable may be terminated, if required, using the correct terminating impedance. The overall length shall not exceed 1 m.
- d. LISN at least 80 cm from nearest part of EUT chassis.
- e. For the actual test configuration, please refer to the related Item –EUT Test Photos.

3.1.3 TEST SETUP

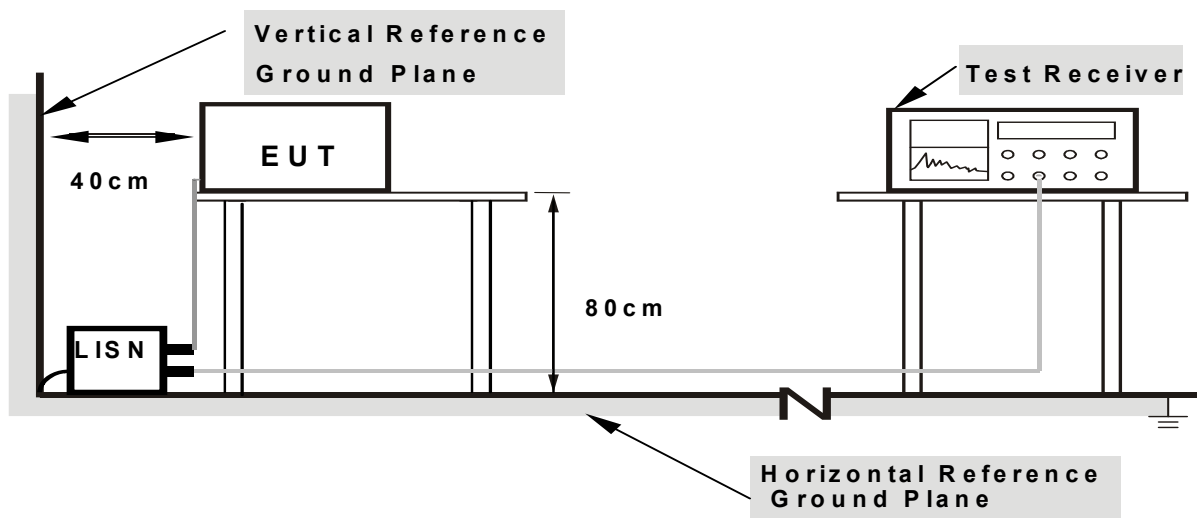

- Note: 1. Support units were connected to second LISN.**
2. Both of LISNs (AMN) are 80 cm from EUT and at least 80 cm from other units and other metal planes

3.1.4 EUT OPERATING CONDITIONS

The EUT was configured for testing in a typical fashion (as a customer would normally use it). The EUT has been programmed to continuously transmit during test. This operating condition was tested and used to collect the included data.



3.1.5 TEST RESULT

Note: In this case, when the product (ZigBee, BT, WLAN) functions are simultaneous transmission, AC conducted emissions are performed in accordance with the requirements of FCC Part 15 C Part 15.207. Only worst case test results are reported.

Temperature:	28 °C	Relative Humidity:	62%
Test Voltage:	AC 120V/60Hz	Phase:	L
Test Mode:	TX Mode(Worst mode)		

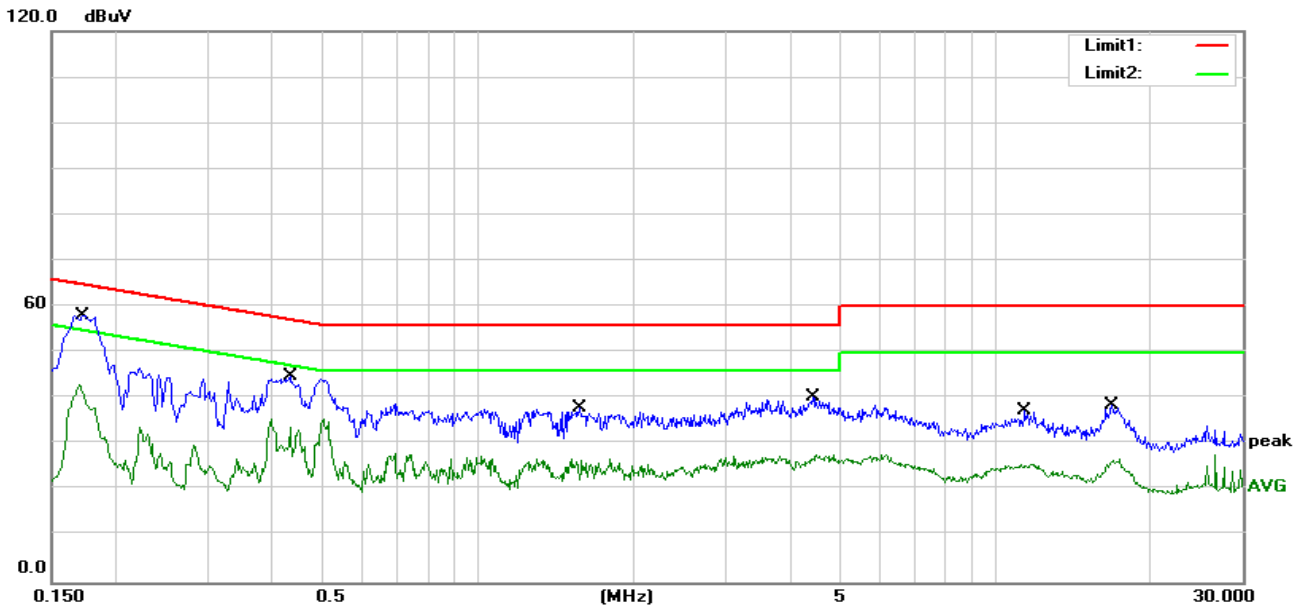

Remark:

1. All readings are Quasi-Peak and Average values.
2. Margin = Result (Result =Reading + Factor)–Limit

No.	Frequency (MHz)	Reading (dBuV)	Correct Factor(dB)	Result (dBuV)	Limit (dBuV)	Margin (dB)	Remark
1	0.1720	37.50	20.57	58.07	64.86	-6.79	QP
2	0.1720	22.39	20.57	42.96	54.86	-11.90	AVG
3	0.4340	24.54	20.18	44.72	57.18	-12.46	QP
4	0.4340	15.39	20.18	35.57	47.18	-11.61	AVG
5	1.5740	18.17	19.71	37.88	56.00	-18.12	QP
6	1.5740	7.19	19.71	26.90	46.00	-19.10	AVG
7	4.4540	20.12	20.34	40.46	56.00	-15.54	QP
8	4.4540	7.41	20.34	27.75	46.00	-18.25	AVG
9	11.3780	16.82	20.62	37.44	60.00	-22.56	QP
10	11.3780	5.12	20.62	25.74	50.00	-24.26	AVG
11	16.8340	17.59	20.99	38.58	60.00	-21.42	QP
12	16.8340	4.33	20.99	25.32	50.00	-24.68	AVG



Temperature:	28 °C	Relative Humidity:	62%
Test Voltage:	AC 120V/60Hz	Phase:	N
Test Mode:	TX Mode(Worst mode)		

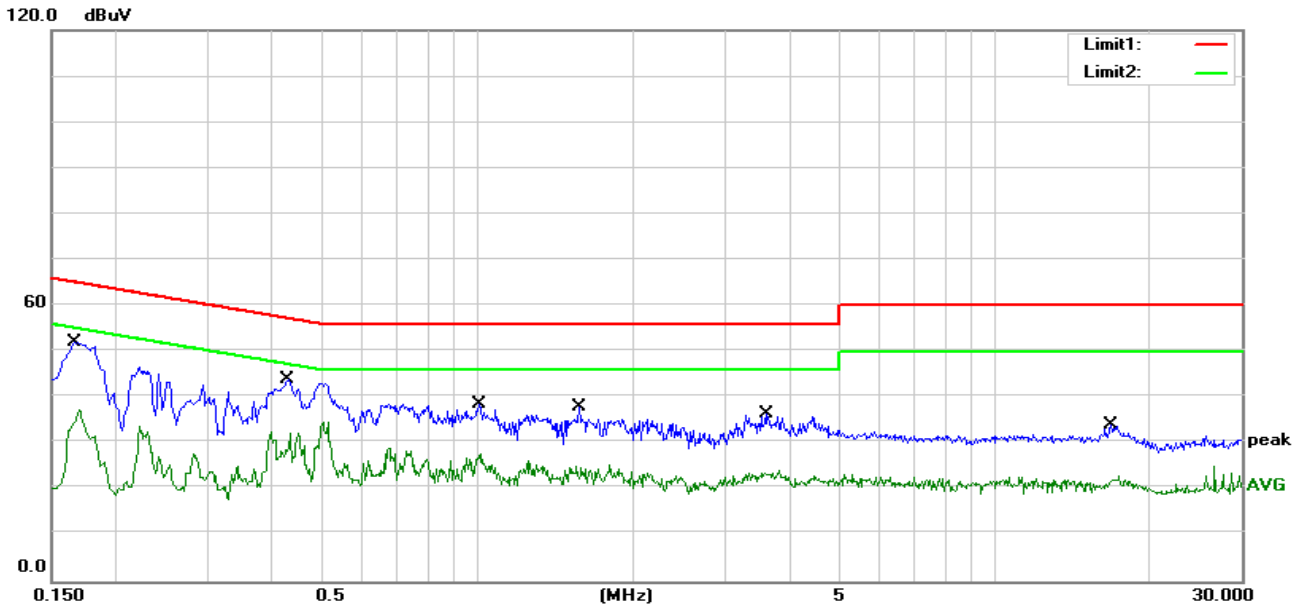

Remark:

1. All readings are Quasi-Peak and Average values.
2. Margin = Result (Result =Reading + Factor)–Limit

No.	Frequency (MHz)	Reading (dBuV)	Correct Factor(dB)	Result (dBuV)	Limit (dBuV)	Margin (dB)	Remark
1	0.1660	31.46	20.57	52.03	65.16	-13.13	QP
2	0.1660	16.89	20.57	37.46	55.16	-17.70	AVG
3	0.4304	23.68	20.19	43.87	57.24	-13.37	QP
4	0.4304	14.39	20.19	34.58	47.24	-12.66	AVG
5	1.0100	19.09	19.41	38.50	56.00	-17.50	QP
6	1.0100	8.46	19.41	27.87	46.00	-18.13	AVG
7	1.5740	18.17	19.71	37.88	56.00	-18.12	QP
8	1.5740	5.67	19.71	25.38	46.00	-20.62	AVG
9	3.6140	16.14	20.24	36.38	56.00	-19.62	QP
10	3.6140	3.79	20.24	24.03	46.00	-21.97	AVG
11	16.8340	13.09	20.99	34.08	60.00	-25.92	QP
12	16.8340	1.81	20.99	22.80	50.00	-27.20	AVG



3.2 RADIATED EMISSION MEASUREMENT

3.2.1 RADIATED EMISSION LIMITS

in any 100 kHz bandwidth outside the operating frequency band. In case the emission fall within the Restricted band specified on Part15.205(a)&209(a) limit in the table and according to ANSI C63.10-2013 below has to be followed

LIMITS OF RADIATED EMISSION MEASUREMENT (0.009MHz - 1000MHz)

Frequencies (MHz)	Field Strength (micorvolts/meter)	Measurement Distance (meters)
0.009~0.490	2400/F(KHz)	300
0.490~1.705	24000/F(KHz)	30
1.705~30.0	30	30
30~88	100	3
88~216	150	3
216~960	200	3
Above 960	500	3

LIMITS OF RADIATED EMISSION MEASUREMENT (1GHz-25 GHz)

FREQUENCY (MHz)	(dBuV/m) (at 3M)	
	PEAK	AVERAGE
Above 1000	74	54

Notes:

- (1) The limit for radiated test was performed according to FCC PART 15C.
- (2) The tighter limit applies at the band edges.
- (3) Emission level (dBuV/m)=20log Emission level (uV/m).

For Radiated Emission

Spectrum Parameter	Setting
Attenuation	Auto
Detector	Peak/AV
Start Frequency	1000 MHz(Peak/AV)
Stop Frequency	10th carrier hamonic(Peak/AV)
RB / VB (emission in restricted band)	PK=1MHz / 1MHz, AV=1 MHz / 10 Hz

For Band edge

Spectrum Parameter	Setting
Detector	Peak/AV
Start/Stop Frequency	Lower Band Edge: 2300 to 2403 MHz Upper Band Edge: 2479 to 2500 MHz
RB / VB (emission in restricted band)	PK=1MHz / 1MHz, AV=1 MHz / 10 Hz



Receiver Parameter	Setting
Attenuation	Auto
Start ~ Stop Frequency	9kHz~90kHz / RB 200Hz for PK & AV
Start ~ Stop Frequency	90kHz~110kHz / RB 200Hz for QP
Start ~ Stop Frequency	110kHz~490kHz / RB 200Hz for PK & AV
Start ~ Stop Frequency	490kHz~30MHz / RB 9kHz for QP
Start ~ Stop Frequency	30MHz~1000MHz / RB 120kHz for QP

3.2.2 TEST PROCEDURE

- The measuring distance of at 3 m shall be used for measurements at frequency 0.009MHz up to 1GHz, and above 1GHz.
- The EUT was placed on the top of a rotating table 0.8 meters (above 1GHz is 1.5 m) above the ground at a 3 meter anechoic chamber test site. The table was rotated 360 degrees to determine the position of the highest radiation.
- The height of the equipment shall be 0.8 m (above 1GHz is 1.5 m); the height of the test antenna shall vary between 1 m to 4 m. horizontal and vertical polarizations of the antenna are set to make the measurement.
- The initial step in collecting conducted emission data is a spectrum analyzer peak detector mode pre-scanning the measurement frequency range. Significant peaks are then marked and then QuasiPeak detector mode re-measured.
- If the Peak Mode measured value compliance with and lower than Quasi Peak Mode Limit, the EUT shall be deemed to meet QP Limits and then no additional QP Mode measurement performed.
- For the actual test configuration, please refer to the related Item –EUT Test Photos.

Note:

Both horizontal and vertical antenna polarities were tested and performed pretest to three orthogonal axis. The worst case emissions were reported

3.2.3 DEVIATION FROM TEST STANDARD

No deviation

3.2.4 TESTSETUP

(A) Radiated Emission Test-Up Frequency Below 30MHz

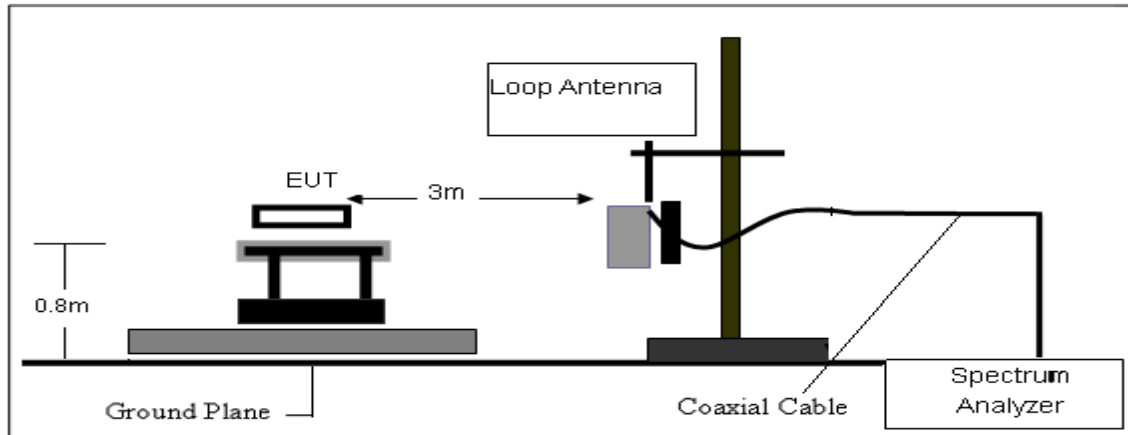

(B) Radiated Emission Test-Up Frequency 30MHz~1GHz

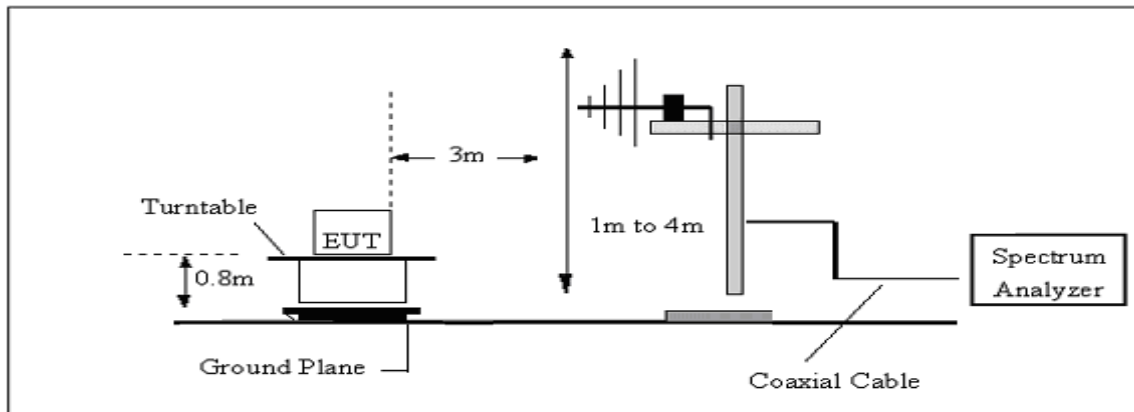

(C) Radiated Emission Test-Up Frequency Above 1GHz

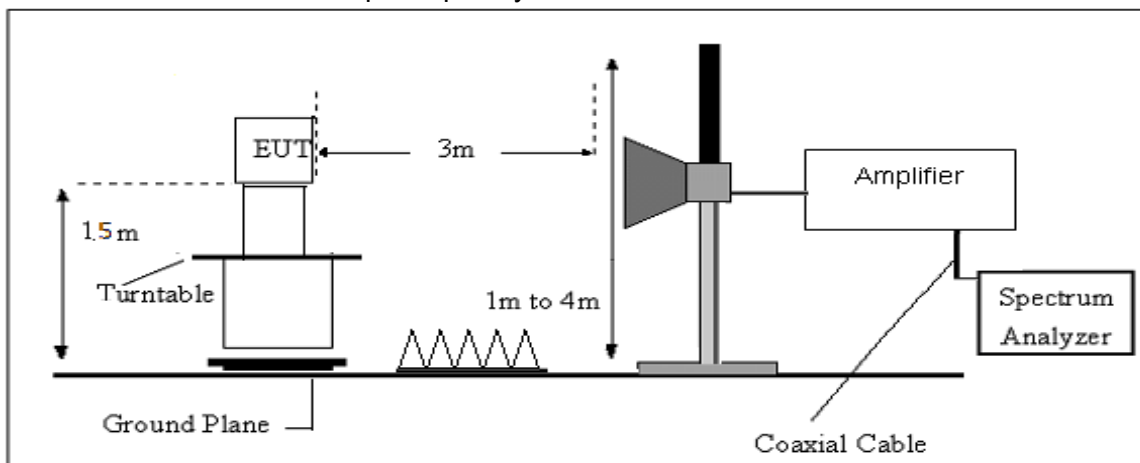

3.2.5 EUT OPERATING CONDITIONS

The EUT tested system was configured as the statements of 2.4 Unless otherwise a special operating condition is specified in the follows during the testing.



3.2.6 FIELD STRENGTH CALCULATION

The field strength is calculated by adding the Antenna Factor and Cable Factor and subtracting the Amplifier Gain and Duty Cycle Correction Factor (if any) from the measured reading. The basic equation with a sample calculation is as follows:

$$FS = RA + AF + CL - AG$$

Where

FS = Field Strength

CL = Cable Attenuation Factor (Cable Loss)

RA = Reading Amplitude

AG = Amplifier Gain

AF = Antenna Factor

For example

Frequency (MHz)	FS (dB μ V/m)	RA (dB μ V/m)	AF (dB)	CL (dB)	AG (dB)	Factor (dB)
300	40	58.1	12.2	1.6	31.9	-18.1

$$\text{Factor} = \text{AF} + \text{CL} - \text{AG}$$



3.2.7 TEST RESULTS

(9KHz-30MHz)

Temperature:	24.3°C	Relative Humidity:	56%
Test Voltage:	AC 120V/60Hz	Test Mode:	TX Mode

Freq. (MHz)	Reading (dBuV/m)	Limit (dBuV/m)	Margin (dB)	State P/F	Test Result
--	--	--	--	--	PASS
--	--	--	--	--	PASS

Note:

The amplitude of spurious emissions which are attenuated by more than 20dB below the permissible value has no need to be reported.

Distance extrapolation factor = $40 \log (\text{specific distance}/\text{test distance})$ (dB);

Limit line = specific limits(dBuv) + distance extrapolation factor.



(30MHz-1000MHz)

Temperature:	24.3 °C	Relative Humidity:	56%
Test Voltage:	AC 120V/60Hz	Phase:	Horizontal
Test Mode:	Mode 1/2/3/4/5/6/7/8/9(Mode 1 worst mode)		

Frequency (MHz)	Reading (dBuV)	Correct Factor(dB/m)	Result (dBuV/m)	Limit (dBuV/m)	Margin (dB)	Remark
111.4800	52.60	-18.92	33.68	43.50	-9.82	QP
223.0300	51.31	-19.42	31.89	46.00	-14.11	QP
371.4400	53.86	-12.46	41.40	46.00	-4.60	QP
556.7100	39.55	-5.58	33.97	46.00	-12.03	QP
755.5600	34.68	-2.17	32.51	46.00	-13.49	QP
934.0400	33.55	0.89	34.44	46.00	-11.56	QP

Remark:

1. Margin = Result (Result =Reading + Factor)–Limit

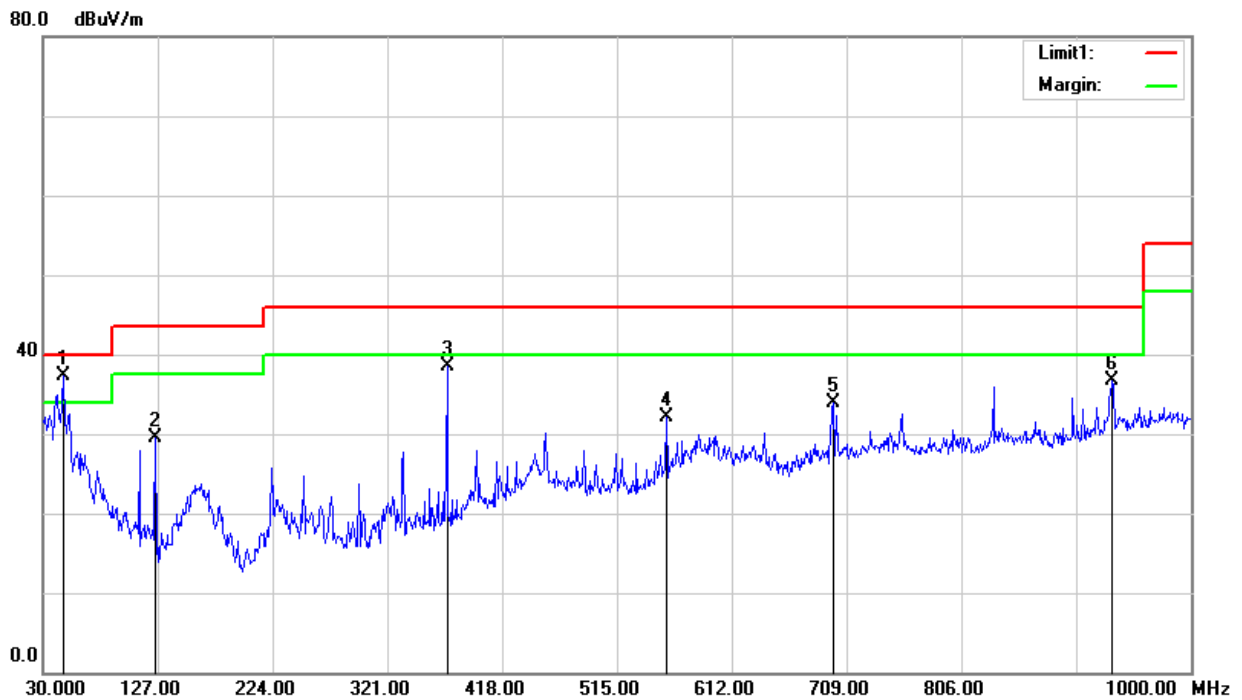



Temperature:	24.3°C	Relative Humidity:	56%
Test Voltage:	AC 120V/60Hz	Phase:	Vertical
Test Mode:	Mode 1/2/3/4/5/6/7/8/9(Mode 1 worst mode)		

Frequency (MHz)	Reading (dBuV)	Correct Factor(dB/m)	Result (dBuV/m)	Limit (dBuV/m)	Margin (dB)	Remark
47.4600	59.21	-21.92	37.29	40.00	-2.71	QP
125.0600	47.79	-18.22	29.57	43.50	-13.93	QP
371.4400	50.87	-12.46	38.41	46.00	-7.59	QP
556.7100	37.72	-5.58	32.14	46.00	-13.86	QP
698.3300	38.13	-4.20	33.93	46.00	-12.07	QP
933.0700	35.91	0.80	36.71	46.00	-9.29	QP

Remark:

1. Margin = Result (Result =Reading + Factor)–Limit

80.0 dBuV/m

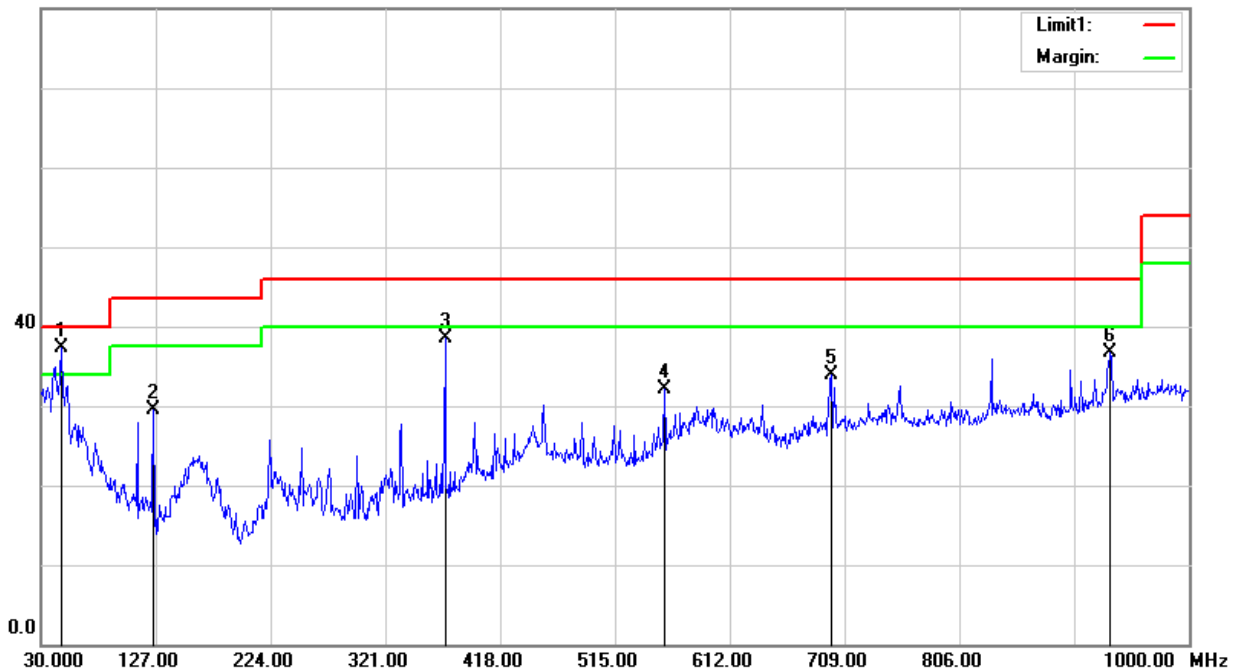



(1GHz~25GHz) Restricted band and Spurious emission Requirements

GFSK,Low Channel Horizontal

Frequency (MHz)	Peak Reading (dBuV/m)	Average Readingl (dBuV/m)	Factor (dB)	Peak Level (dBuV/m)	Average Level (dBuV/m)	PK Limit (dBuV/m)	AV Limit (dBuV/m)	Margin(dB)	ANT
1047	42.17	34.02	-1.57	40.60	32.45	74.00	54.00	-13.40	Horizontal
2132.5	40.66	34.59	5.56	46.22	40.15	74.00	54.00	-13.85	Horizontal
2688	40.63	29.76	6.7	47.33	36.46	74.00	54.00	-17.54	Horizontal
5380	55.33	41.51	-3.52	51.81	37.99	74.00	54.00	-16.01	Horizontal
10952.5	49.29	39.41	10.04	59.33	49.45	74.00	54.00	-4.55	Horizontal
14967.5	50.01	39.08	12.39	62.40	51.47	74.00	54.00	-2.53	Horizontal

Vertical

Frequency (MHz)	Peak Reading (dBuV/m)	Average Readingl (dBuV/m)	Factor (dB)	Peak Level (dBuV/m)	Average Level (dBuV/m)	PK Limit (dBuV/m)	AV Limit (dBuV/m)	Margin(dB)	ANT
1266.5	42.95	33.17	-0.52	42.43	32.65	74.00	54.00	-11.57	Vertical
2132.5	41.75	35.89	5.56	47.31	41.45	74.00	54.00	-12.55	Vertical
5380	59.87	42.35	-3.52	56.35	38.83	74.00	54.00	-15.17	Vertical
8092.5	50.73	39.05	5.08	55.81	44.13	74.00	54.00	-9.87	Vertical
10965	49.52	39.24	10.11	59.63	49.35	74.00	54.00	-4.65	Vertical
14890	49.68	40.35	12.29	61.97	52.64	74.00	54.00	-1.36	Vertical



GFSK, Mid Channel Horizontal

Frequency (MHz)	Peak Reading (dBuV/m)	Average Reading (dBuV/m)	Factor (dB)	Peak Level (dBuV/m)	Average Level (dBuV/m)	PK Limit (dBuV/m)	AV Limit (dBuV/m)	Margin (dB)	ANT
1053	42.58	33.65	-1.54	41.04	32.11	74.00	54.00	-12.96	Horizontal
2464	41.90	36.73	4.96	46.86	41.69	74.00	54.00	-12.31	Horizontal
3952.5	53.26	43.59	-8.25	45.01	35.34	74.00	54.00	-18.66	Horizontal
5387.5	55.27	43.03	-3.52	51.75	39.51	74.00	54.00	-14.49	Horizontal
10942.5	49.19	39.49	9.97	59.16	49.46	74.00	54.00	-4.54	Horizontal
14898.75	49.56	39.99	12.37	61.93	52.36	74.00	54.00	-1.64	Horizontal

Vertical

Frequency (MHz)	Peak Reading (dBuV/m)	Average Reading (dBuV/m)	Factor (dB)	Peak Level (dBuV/m)	Average Level (dBuV/m)	PK Limit (dBuV/m)	AV Limit (dBuV/m)	Margin (dB)	ANT
1067.5	43.15	34.19	-1.49	41.66	32.70	74.00	54.00	-12.34	Vertical
2132	41.77	33.49	5.53	47.30	39.02	74.00	54.00	-14.98	Vertical
3417.5	57.99	47.92	-9.99	48.00	37.93	74.00	54.00	-16.07	Vertical
5390	60.21	47.58	-3.52	56.69	44.06	74.00	54.00	-9.94	Vertical
10950	49.13	39.61	10.02	59.15	49.63	74.00	54.00	-4.37	Vertical
14898.75	49.35	39.67	12.37	61.72	52.04	74.00	54.00	-1.96	Vertical



GFSK,High Channel Horizontal

Frequency (MHz)	Peak Reading (dBuV/m)	Average Reading (dBuV/m)	Factor (dB)	Peak Level (dBuV/m)	Average Level (dBuV/m)	PK Limit (dBuV/m)	AV Limit (dBuV/m)	Margin(dB)	ANT
1009.5	39.57	31.81	-1.72	37.85	30.09	74.00	54.00	-16.15	Horizontal
2166.5	40.31	30.82	5.34	45.65	36.16	74.00	54.00	-17.84	Horizontal
4265	52.91	42.45	-6.81	46.10	35.64	74.00	54.00	-18.36	Horizontal
5387.5	55.70	43.64	-3.52	52.18	40.12	74.00	54.00	-13.88	Horizontal
10970	49.12	39.37	10.14	59.26	49.51	74.00	54.00	-4.49	Horizontal
14866.25	50.50	39.48	12.09	62.59	51.57	74.00	54.00	-2.43	Horizontal

Vertical

Frequency (MHz)	Peak Reading (dBuV/m)	Average Reading (dBuV/m)	Factor (dB)	Peak Level (dBuV/m)	Average Level (dBuV/m)	PK Limit (dBuV/m)	AV Limit (dBuV/m)	Margin(dB)	ANT
1092.5	43.21	33.00	-1.32	41.89	31.68	74.00	54.00	-12.11	Vertical
2132.5	41.38	35.48	5.56	46.94	41.04	74.00	54.00	-12.96	Vertical
3407.5	58.71	48.89	-9.99	48.72	38.90	74.00	54.00	-15.10	Vertical
5382.5	59.94	47.44	-3.52	56.42	43.92	74.00	54.00	-10.08	Vertical
11012.5	50.14	38.85	10.25	60.39	49.10	74.00	54.00	-4.90	Vertical
14896.25	49.55	39.83	12.35	61.90	52.18	74.00	54.00	-1.82	Vertical



$\pi/4$ -DQPSK, Low Channel Horizontal

Frequency (MHz)	Peak Reading (dBuV/m)	Average Reading (dBuV/m)	Factor (dB)	Peak Level (dBuV/m)	Average Level (dBuV/m)	PK Limit (dBuV/m)	AV Limit (dBuV/m)	Margin (dB)	ANT
1030.5	41.99	34.35	-1.88	40.11	32.47	74.00	54.00	-13.89	Horizontal
2132.5	42.44	34.80	4.34	46.78	39.14	74.00	54.00	-14.86	Horizontal
5400	56.33	43.09	-4.75	51.58	38.34	74.00	54.00	-15.66	Horizontal
10927	50.50	39.83	8.68	59.18	48.51	74.00	54.00	-5.49	Horizontal
15393.75	50.47	39.57	10.9	61.37	50.47	74.00	54.00	-3.53	Horizontal
17970	49.92	38.96	11.35	61.27	50.31	74.00	54.00	-3.69	Horizontal

Vertical

Frequency (MHz)	Peak Reading (dBuV/m)	Average Reading (dBuV/m)	Factor (dB)	Peak Level (dBuV/m)	Average Level (dBuV/m)	PK Limit (dBuV/m)	AV Limit (dBuV/m)	Margin (dB)	ANT
1175	44.08	33.28	-1.3	42.78	31.98	74.00	54.00	-11.22	Vertical
2131.5	43.24	34.33	4.32	47.56	38.65	74.00	54.00	-15.35	Vertical
2953	40.03	28.77	5.91	45.94	34.68	74.00	54.00	-19.32	Vertical
5384	59.61	47.65	-4.79	54.82	42.86	74.00	54.00	-11.14	Vertical
11264.5	50.23	39.78	8.57	58.80	48.35	74.00	54.00	-5.65	Vertical
15076.25	51.17	40.48	10.33	61.50	50.81	74.00	54.00	-3.19	Vertical



$\pi/4$ -DQPSK, Mid Channel Horizontal

Frequency (MHz)	Peak Reading (dBuV/m)	Average Reading (dBuV/m)	Factor (dB)	Peak Level (dBuV/m)	Average Level (dBuV/m)	PK Limit (dBuV/m)	AV Limit (dBuV/m)	Margin (dB)	ANT
1022.5	42.55	32.35	-1.89	40.66	30.46	74.00	54.00	-13.34	Horizontal
2177	41.89	31.23	4.35	46.24	35.58	74.00	54.00	-18.42	Horizontal
5387	56.22	43.60	-4.78	51.44	38.82	74.00	54.00	-15.18	Horizontal
8737	51.29	40.62	4.04	55.33	44.66	74.00	54.00	-9.34	Horizontal
14223.75	50.52	39.66	11.42	61.94	51.08	74.00	54.00	-2.92	Horizontal
17971.249	49.89	39.31	11.37	61.26	50.68	74.00	54.00	-3.32	Horizontal

Vertical

Frequency (MHz)	Peak Reading (dBuV/m)	Average Reading (dBuV/m)	Factor (dB)	Peak Level (dBuV/m)	Average Level (dBuV/m)	PK Limit (dBuV/m)	AV Limit (dBuV/m)	Margin (dB)	ANT
1046	43.32	36.18	-1.84	41.48	34.34	74.00	54.00	-12.52	Vertical
2133	42.80	36.78	4.35	47.15	41.13	74.00	54.00	-12.87	Vertical
3251	58.98	48.29	-12.18	46.80	36.11	74.00	54.00	-17.89	Vertical
5398	59.40	46.68	-4.76	54.64	41.92	74.00	54.00	-12.08	Vertical
14442.5	50.26	39.31	10.92	61.18	50.23	74.00	54.00	-3.77	Vertical
17061.25	50.82	39.98	10.2	61.02	50.18	74.00	54.00	-3.82	Vertical



π/4-DQPSK,High Channel Horizontal

Frequency (MHz)	Peak Reading (dBuV/m)	Average Reading (dBuV/m)	Factor (dB)	Peak Level (dBuV/m)	Average Level (dBuV/m)	PK Limit (dBuV/m)	AV Limit (dBuV/m)	Margin(dB)	ANT
1113.5	43.61	38.16	-1.46	42.15	36.70	74.00	54.00	-11.85	Horizontal
2445.5	46.74	42.24	4.06	50.80	46.30	74.00	54.00	-7.70	Horizontal
5393	56.25	43.58	-4.77	51.48	38.81	74.00	54.00	-15.19	Horizontal
11318.5	50.46	39.46	8.61	59.07	48.07	74.00	54.00	-5.93	Horizontal
14903.75	52.23	40.07	9.9	62.13	49.97	74.00	54.00	-4.03	Horizontal
17146.25	51.46	39.65	10.22	61.68	49.87	74.00	54.00	-4.13	Horizontal

Vertical

Frequency (MHz)	Peak Reading (dBuV/m)	Average Reading (dBuV/m)	Factor (dB)	Peak Level (dBuV/m)	Average Level (dBuV/m)	PK Limit (dBuV/m)	AV Limit (dBuV/m)	Margin(dB)	ANT
1046.5	42.79	35.94	-1.84	40.95	34.10	74.00	54.00	-13.05	Vertical
2429	43.02	36.74	4.02	47.04	40.76	74.00	54.00	-13.24	Vertical
5388	58.54	46.26	-4.78	53.76	41.48	74.00	54.00	-12.52	Vertical
11047	50.30	39.07	8.71	59.01	47.78	74.00	54.00	-6.22	Vertical
14228.75	50.18	39.18	11.38	61.56	50.56	74.00	54.00	-3.44	Vertical
17033.75	50.56	39.69	10	60.56	49.69	74.00	54.00	-4.31	Vertical



8DPSK,Low Channel Horizontal

Frequency (MHz)	Peak Reading (dBuV/m)	Average Reading (dBuV/m)	Factor (dB)	Peak Level (dBuV/m)	Average Level (dBuV/m)	PK Limit (dBuV/m)	AV Limit (dBuV/m)	Margin(dB)	ANT
1028	43.96	35.40	-1.88	42.08	33.52	74.00	54.00	-11.92	Horizontal
2166.5	42.06	32.43	4.46	46.52	36.89	74.00	54.00	-17.11	Horizontal
5384	55.50	43.89	-4.79	50.71	39.10	74.00	54.00	-14.90	Horizontal
10955.5	50.23	39.34	8.76	58.99	48.10	74.00	54.00	-5.90	Horizontal
14315	50.48	39.49	10.91	61.39	50.40	74.00	54.00	-3.60	Horizontal
17055	51.02	40.25	10.16	61.18	50.41	74.00	54.00	-3.59	Horizontal

Vertical

Frequency (MHz)	Peak Reading (dBuV/m)	Average Reading (dBuV/m)	Factor (dB)	Peak Level (dBuV/m)	Average Level (dBuV/m)	PK Limit (dBuV/m)	AV Limit (dBuV/m)	Margin(dB)	ANT
1046.5	39.30	31.66	-1.84	37.46	29.82	74.00	54.00	-16.54	Vertical
2415.5	46.33	40.85	3.99	50.32	44.84	74.00	54.00	-9.16	Vertical
5387	58.35	45.95	-4.78	53.57	41.17	74.00	54.00	-12.83	Vertical
11393.5	50.90	39.97	8.47	59.37	48.44	74.00	54.00	-5.56	Vertical
15191.25	50.52	38.95	10.98	61.50	49.93	74.00	54.00	-4.07	Vertical
17988.749	50.29	38.84	11.6	61.89	50.44	74.00	54.00	-3.56	Vertical



8DPSK, Mid Channel Horizontal

Frequency (MHz)	Peak Reading (dBuV/m)	Average Reading (dBuV/m)	Factor (dB)	Peak Level (dBuV/m)	Average Level (dBuV/m)	PK Limit (dBuV/m)	AV Limit (dBuV/m)	Margin (dB)	ANT
1016.5	40.03	31.86	-1.91	38.12	29.95	74.00	54.00	-15.88	Horizontal
2147	40.98	30.01	4.58	45.56	34.59	74.00	54.00	-19.41	Horizontal
5390	54.58	43.22	-4.78	49.80	38.44	74.00	54.00	-15.56	Horizontal
10972	50.68	39.60	8.8	59.48	48.40	74.00	54.00	-5.60	Horizontal
15073.75	51.10	40.31	10.33	61.43	50.64	74.00	54.00	-3.36	Horizontal
17987.5	49.31	38.77	11.58	60.89	50.35	74.00	54.00	-3.65	Horizontal

Vertical

Frequency (MHz)	Peak Reading (dBuV/m)	Average Reading (dBuV/m)	Factor (dB)	Peak Level (dBuV/m)	Average Level (dBuV/m)	PK Limit (dBuV/m)	AV Limit (dBuV/m)	Margin (dB)	ANT
1113.5	42.33	36.49	-1.46	40.87	35.03	74.00	54.00	-13.13	Vertical
2133	42.96	35.96	4.35	47.31	40.31	74.00	54.00	-13.69	Vertical
5383	58.27	46.02	-4.79	53.48	41.23	74.00	54.00	-12.77	Vertical
11276.5	51.14	39.39	8.59	59.73	47.98	74.00	54.00	-6.02	Vertical
15143.75	50.98	39.76	10.63	61.61	50.39	74.00	54.00	-3.61	Vertical
17153.75	50.62	40.26	10.18	60.80	50.44	74.00	54.00	-3.56	Vertical



8DPSK,High Channel Horizontal

Frequency (MHz)	Peak Reading (dBuV/m)	Average Readingl (dBuV/m)	Factor (dB)	Peak Level (dBuV/m)	Average Level (dBuV/m)	PK Limit (dBuV/m)	AV Limit (dBuV/m)	Margin(dB)	ANT
1021	41.31	31.87	-1.9	39.41	29.97	74.00	54.00	-14.59	Horizontal
2154	40.77	30.42	4.59	45.36	35.01	74.00	54.00	-18.99	Horizontal
5389	55.45	42.93	-4.78	50.67	38.15	74.00	54.00	-15.85	Horizontal
10943.5	50.34	39.70	8.72	59.06	48.42	74.00	54.00	-5.58	Horizontal
14046.25	51.39	39.41	10.19	61.58	49.60	74.00	54.00	-4.40	Horizontal
17961.251	49.67	38.43	11.23	60.90	49.66	74.00	54.00	-4.34	Horizontal

Vertical

Frequency (MHz)	Peak Reading (dBuV/m)	Average Readingl (dBuV/m)	Factor (dB)	Peak Level (dBuV/m)	Average Level (dBuV/m)	PK Limit (dBuV/m)	AV Limit (dBuV/m)	Margin(dB)	ANT
1065.5	43.22	34.46	-1.72	41.50	32.74	74.00	54.00	-12.50	Vertical
2132.5	43.23	36.23	4.34	47.57	40.57	74.00	54.00	-13.43	Vertical
5390	57.51	45.83	-4.78	52.73	41.05	74.00	54.00	-12.95	Vertical
11164	50.25	38.65	8.46	58.71	47.11	74.00	54.00	-6.89	Vertical
14991.25	50.95	39.71	10.35	61.30	50.06	74.00	54.00	-3.94	Vertical
17967.499	49.37	38.41	11.32	60.69	49.73	74.00	54.00	-4.27	Vertical



GFSK, Low Channel(Worst case waveform) Horizontal

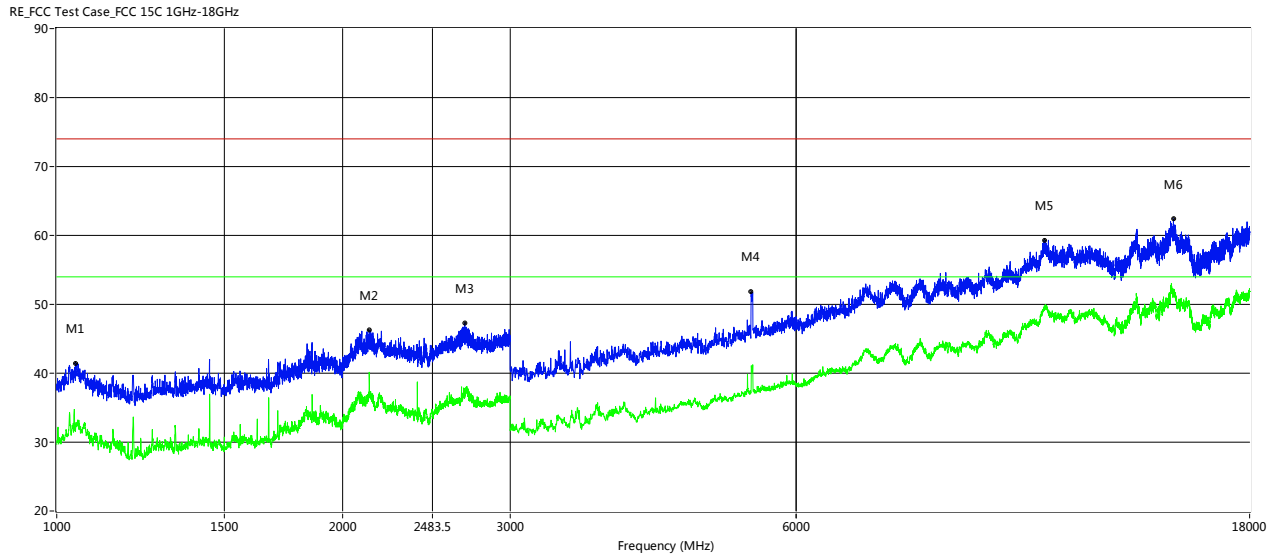

Vertical

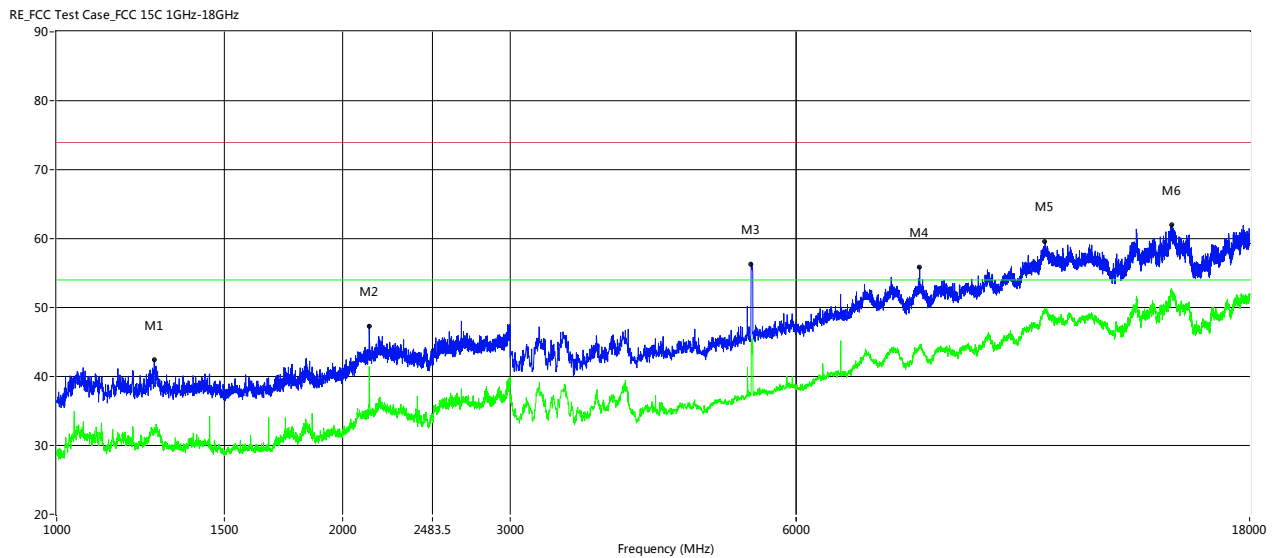

Note: All mode have been test, only showing the worst case waveform plot in this report.



Restricted Bands Requirements

GFSK-Low
Horizontal

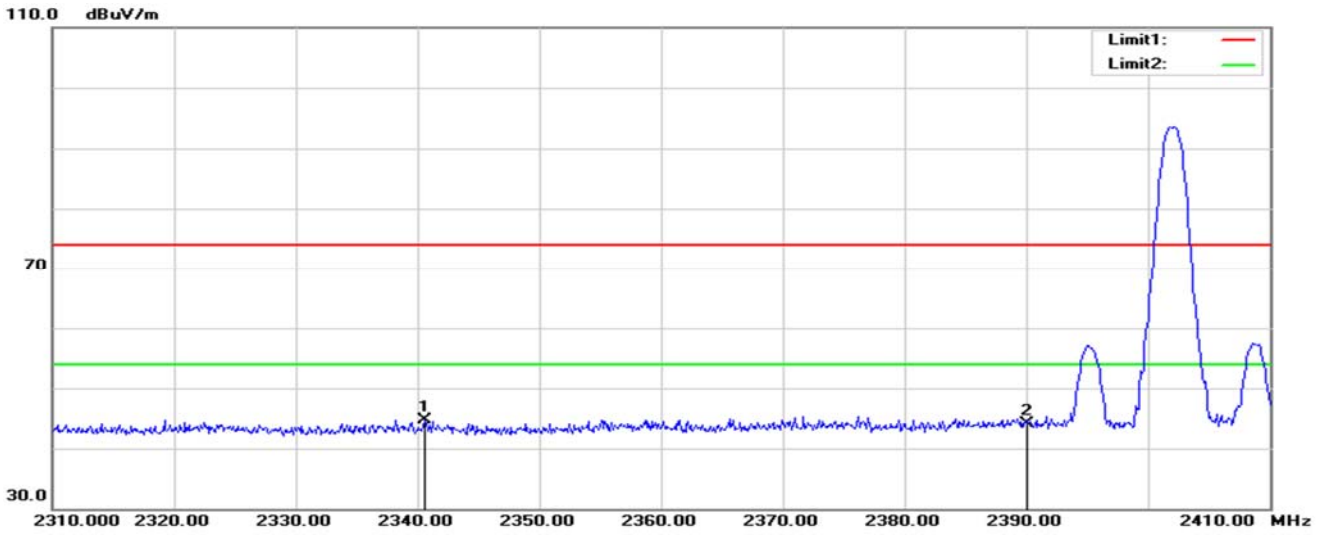

No.	Frequency (MHz)	Reading (dBuV)	Correct Factor(dB/m)	Result (dBuV/m)	Limit (dBuV/m)	Margin (dB)	Remark
1	2340.600	41.08	3.69	44.77	74.00	-29.23	peak
2	2390.000	39.73	4.34	44.07	74.00	-29.93	peak

Vertical

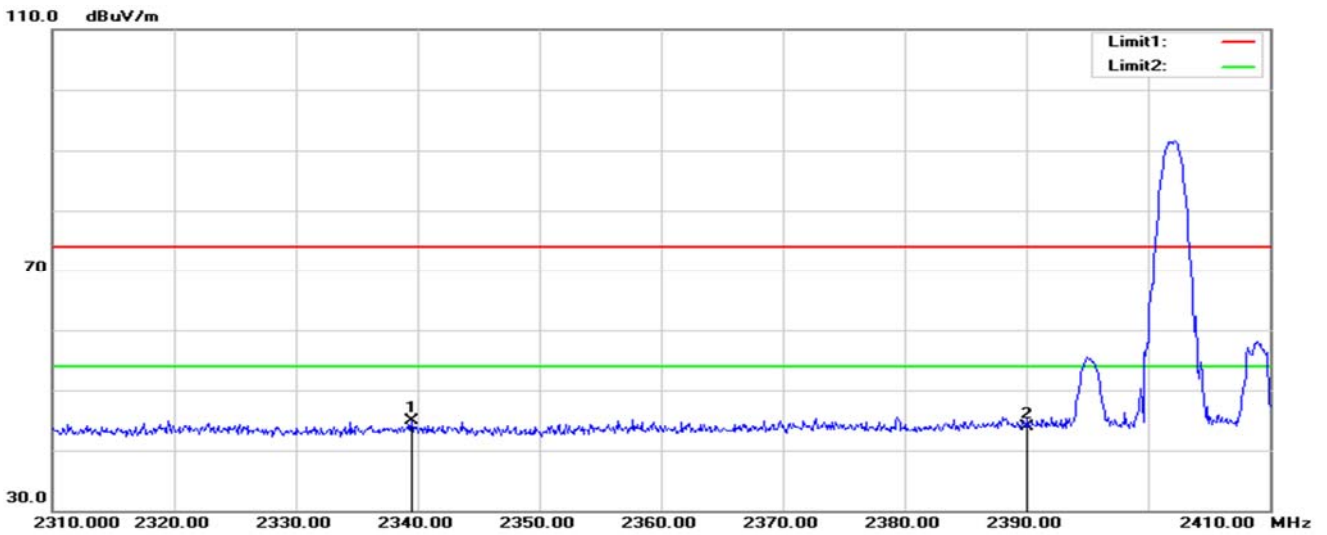

No.	Frequency (MHz)	Reading (dBuV)	Correct Factor(dB/m)	Result (dBuV/m)	Limit (dBuV/m)	Margin (dB)	Remark
1	2339.500	41.28	3.68	44.96	74.00	-29.04	peak
2	2390.000	39.59	4.34	43.93	74.00	-30.07	peak



GFSK-High
Horizontal

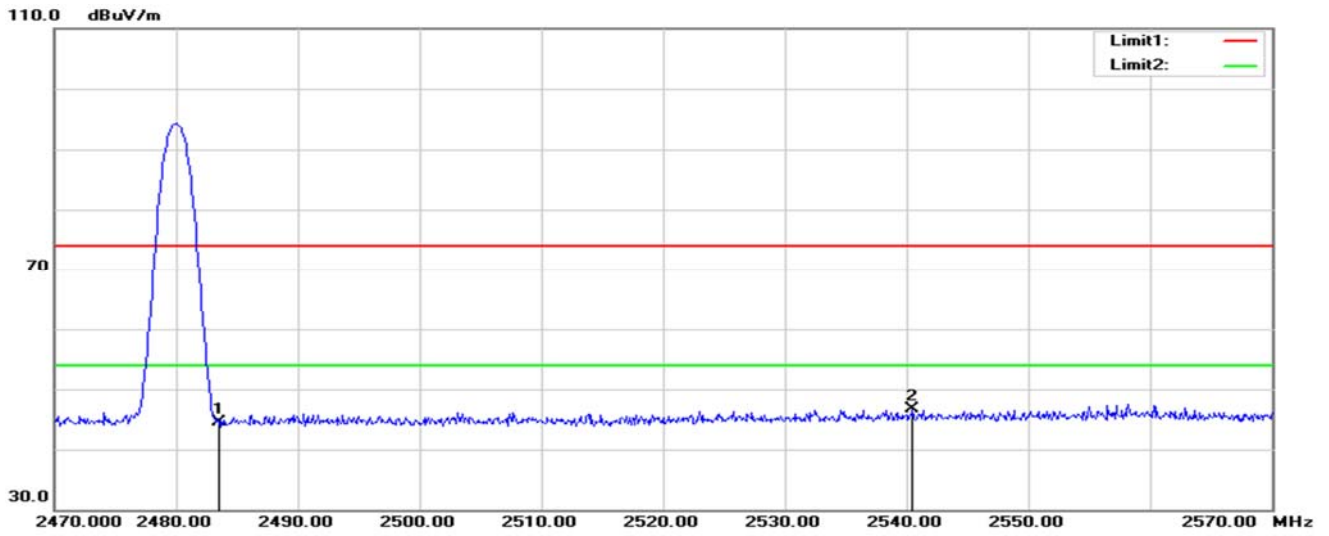

No.	Frequency (MHz)	Reading (dBuV)	Correct Factor(dB/m)	Result (dBuV/m)	Limit (dBuV/m)	Margin (dB)	Remark
1	2483.500	39.86	4.60	44.46	74.00	-29.54	peak
2	2540.500	41.72	4.92	46.64	74.00	-27.36	peak

Vertical

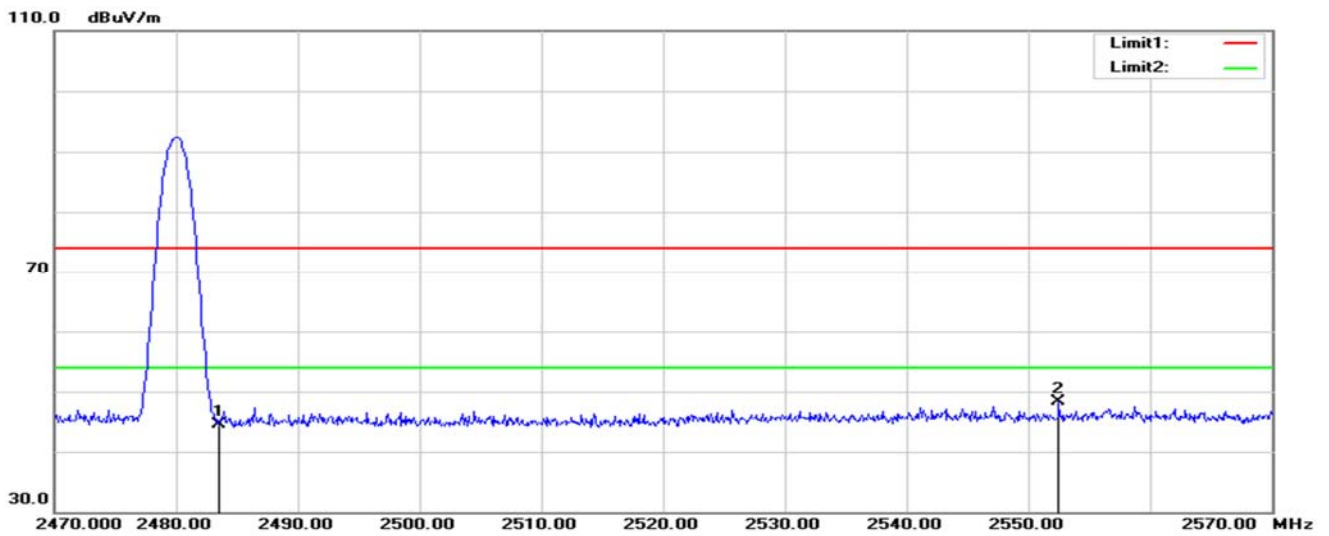

No.	Frequency (MHz)	Reading (dBuV)	Correct Factor(dB/m)	Result (dBuV/m)	Limit (dBuV/m)	Margin (dB)	Remark
1	2483.500	39.82	4.60	44.42	74.00	-29.58	peak
2	2552.500	43.32	4.98	48.30	74.00	-25.70	peak



$\pi/4$ -DQPSK -Low
Horizontal

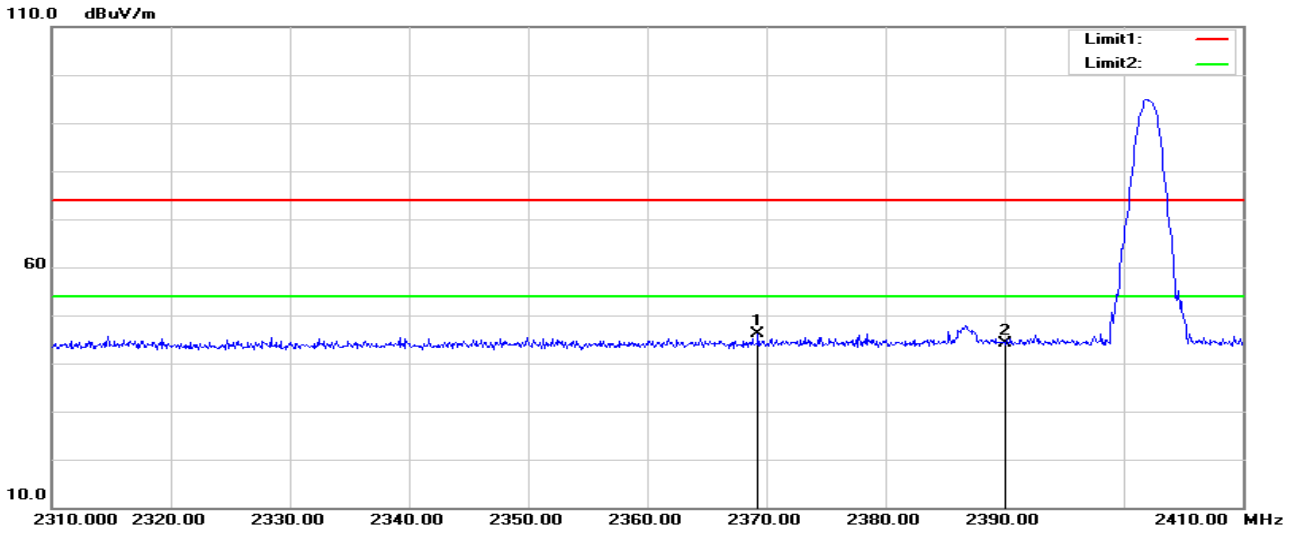

No.	Frequency (MHz)	Reading (dBuV)	Correct Factor(dB/m)	Result (dBuV/m)	Limit (dBuV/m)	Margin (dB)	Remark
1	2369.300	42.14	4.03	46.17	74.00	-27.83	peak
2	2390.000	39.70	4.34	44.04	74.00	-29.96	peak

Vertical

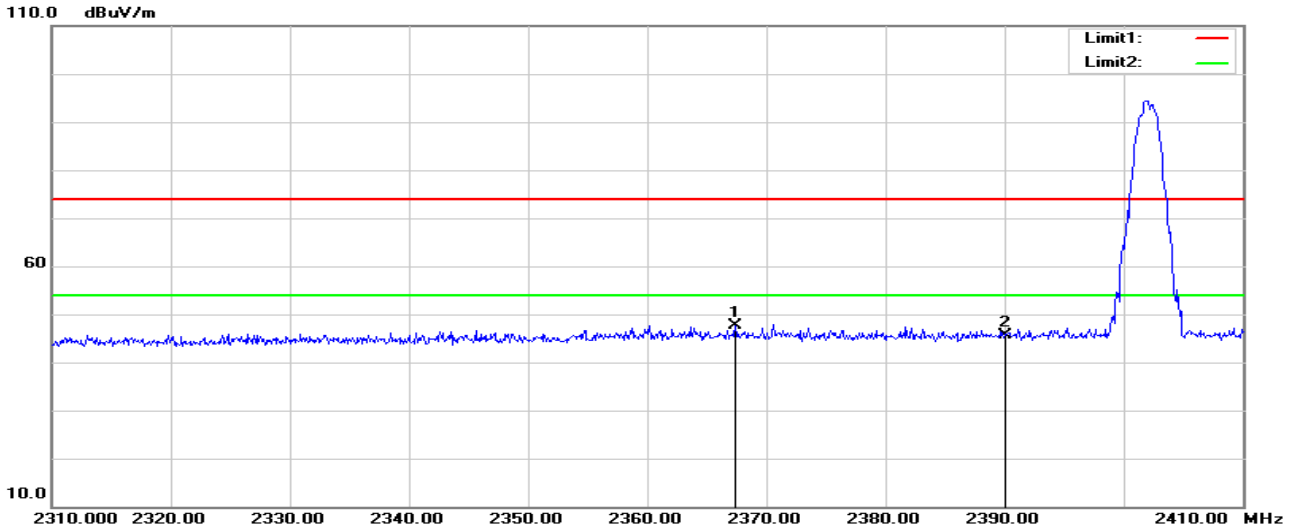

No.	Frequency (MHz)	Reading (dBuV)	Correct Factor(dB/m)	Result (dBuV/m)	Limit (dBuV/m)	Margin (dB)	Remark
1	2367.400	43.71	4.00	47.71	74.00	-26.29	peak
2	2390.000	41.29	4.34	45.63	74.00	-28.37	peak



$\pi/4$ -DQPSK -High
Horizontal

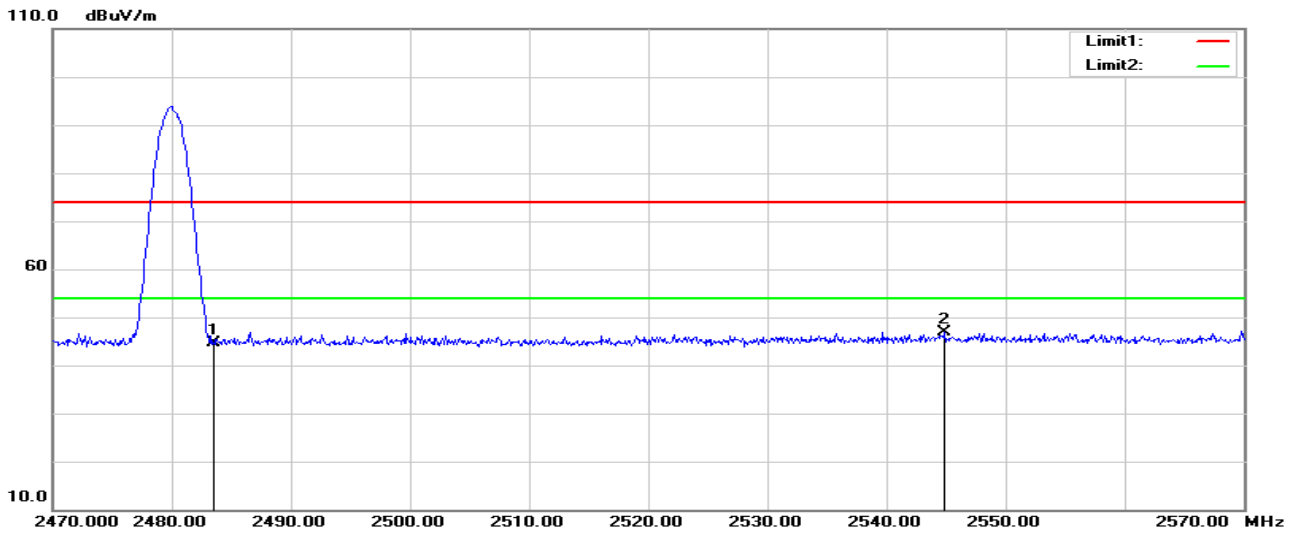

No.	Frequency (MHz)	Reading (dBuV)	Correct Factor(dB/m)	Result (dBuV/m)	Limit (dBuV/m)	Margin (dB)	Remark
1	2483.500	39.94	4.60	44.54	74.00	-29.46	peak
2	2544.900	41.97	4.94	46.91	74.00	-27.09	peak

Vertical

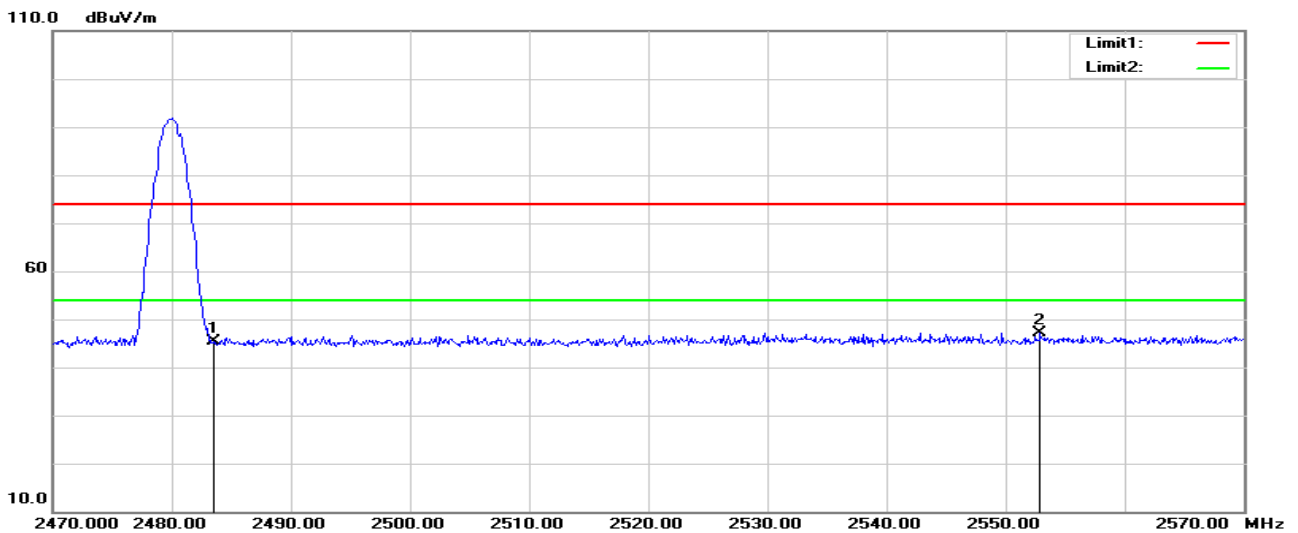

No.	Frequency (MHz)	Reading (dBuV)	Correct Factor(dB/m)	Result (dBuV/m)	Limit (dBuV/m)	Margin (dB)	Remark
1	2483.500	40.78	4.60	45.38	74.00	-28.62	peak
2	2552.900	42.22	4.98	47.20	74.00	-26.80	peak



8DPSK -Low Horizontal

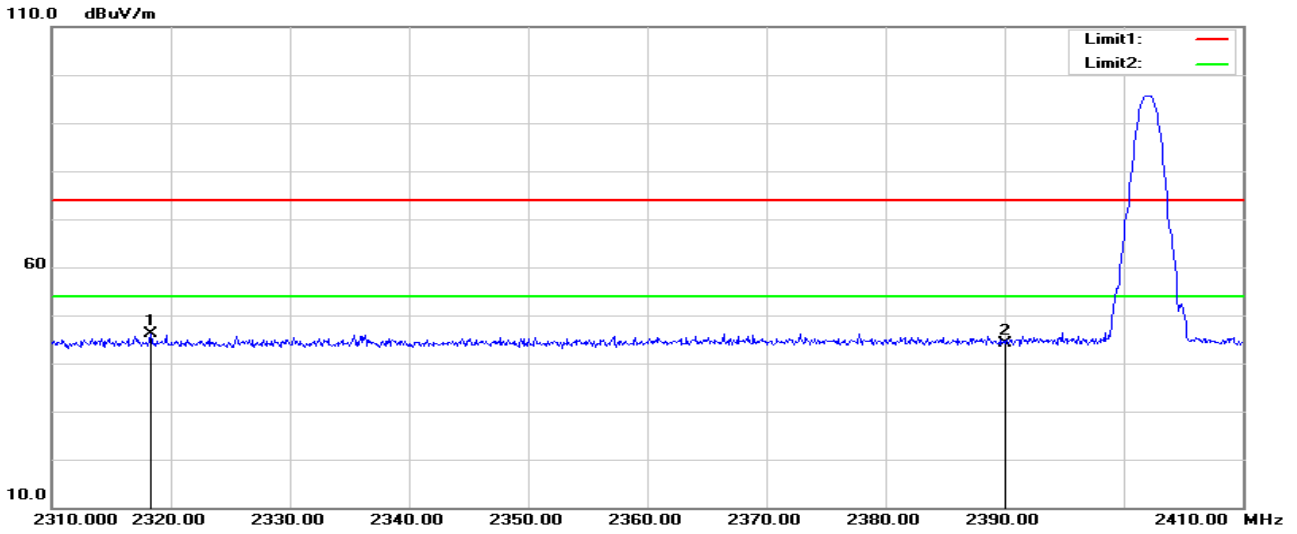

No.	Frequency (MHz)	Reading (dBuV)	Correct Factor(dB/m)	Result (dBuV/m)	Limit (dBuV/m)	Margin (dB)	Remark
1	2318.300	42.56	3.57	46.13	74.00	-27.87	peak
2	2390.000	39.83	4.34	44.17	74.00	-29.83	peak

Vertical

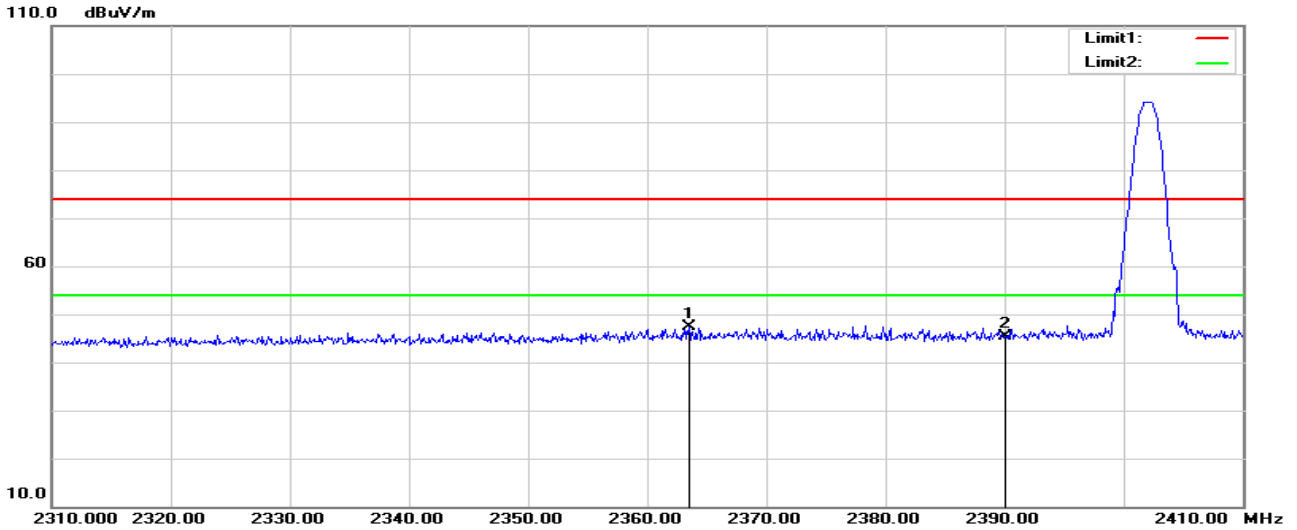

No.	Frequency (MHz)	Reading (dBuV)	Correct Factor(dB/m)	Result (dBuV/m)	Limit (dBuV/m)	Margin (dB)	Remark
1	2363.500	43.38	3.95	47.33	74.00	-26.67	peak
2	2390.000	41.16	4.34	45.50	74.00	-28.50	peak



8DPSK -High
Horizontal

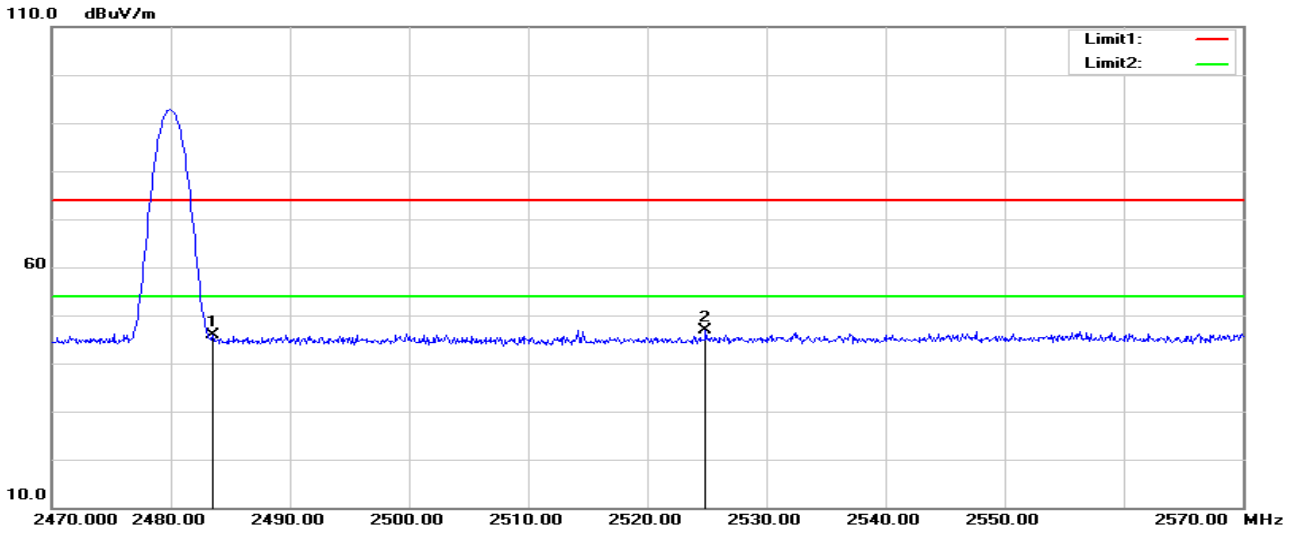

No.	Frequency (MHz)	Reading (dBuV)	Correct Factor(dB/m)	Result (dBuV/m)	Limit (dBuV/m)	Margin (dB)	Remark
1	2483.500	41.17	4.60	45.77	74.00	-28.23	peak
2	2524.900	42.08	4.81	46.89	74.00	-27.11	peak

Vertical

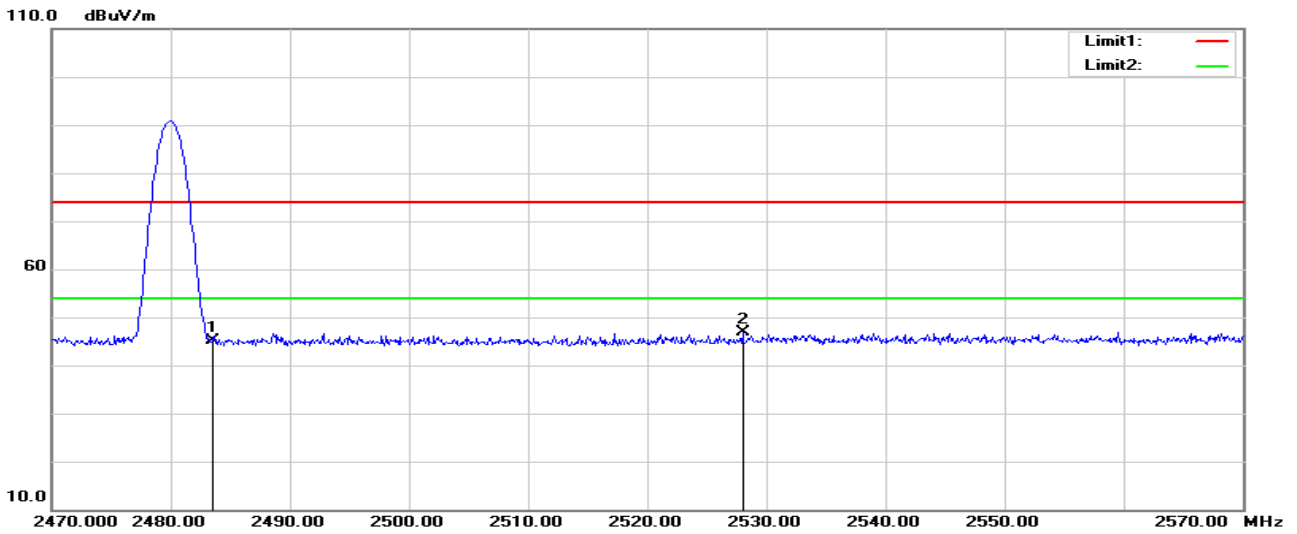

No.	Frequency (MHz)	Reading (dBuV)	Correct Factor(dB/m)	Result (dBuV/m)	Limit (dBuV/m)	Margin (dB)	Remark
1	2483.500	40.49	4.60	45.09	74.00	-28.91	peak
2	2528.000	42.02	4.83	46.85	74.00	-27.15	peak

Note: The nohopping and hopping mode all have been test, the worst case is the nohopping mode, this report only show the worst case.



4. EUT TEST PHOTO

Note: See test photos in setup photo document for the actual connections between Product and support equipment.

*****END OF THE REPORT*****