

## TEST REPORT

**Report Number: 102289738MPK-010**

**Project Number: G102289738**

**October 30, 2015**

**Testing performed on the  
DragonBoard 410C  
Model: DragonBoard 410C  
FCC ID: 2AFQA-DB410C  
IC: 20763-DB410C**

**to**

**FCC Part 15 Subpart C (15.247)  
Industry Canada RSS-247, Issue 1**

**For**

**Arrow Electronics, Inc.**

Test Performed by:

Intertek

1365 Adams Court

Menlo Park, CA 94025 USA

Test Authorized by:

Arrow Electronics, Inc.

7459 South Lima Bldg. 1

Englewood, CO 80112, USA

Prepared by:



Anderson Soungpanya

**Date:** October 30, 2015

Reviewed by:

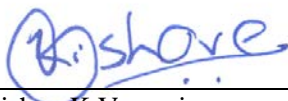

Krishna K Vemuri

**Date:** October 30, 2015

*This report is for the exclusive use of Intertek's Client and is provided pursuant to the agreement between Intertek and its Client. Intertek's responsibility and liability are limited to the terms and conditions of the agreement. Intertek assumes no liability to any party, other than to the Client in accordance with the agreement, for any loss, expense or damage occasioned by the use of this report. Only the Client is authorized to copy or distribute this report and then only in its entirety. Any use of the Intertek name or one of its marks for the sale or advertisement of the tested material, product or service must first be approved in writing by Intertek. The observations and test results in this report are relevant only to the sample tested. This report by itself does not imply that the material, product, or service is or has ever been under an Intertek certification program. This report must not be used to claim product endorsement by A2LA, NIST nor any other agency of the U.S. Government.*

## Report No. 102289738MPK-010

<b>Equipment Under Test:</b>	DragonBoard 410C
<b>Trade Name:</b>	DragonBoard
<b>Model Number:</b>	DragonBoard 410C
<b>Serial Number:</b>	AE-3915-006048
<b>Applicant:</b>	Arrow Electronics, Inc.
<b>Contact:</b>	Amanda Meyer
<b>Address:</b>	Arrow Electronics, Inc. 7459 South Lima Bldg. 1 Englewood, CO 80112
<b>Country</b>	USA
<b>Tel. Number:</b>	(303) 824-1711
<b>Email:</b>	ameyer@arrow.com
<b>Applicable Regulation:</b>	FCC Part 15 Subpart C (15.247) Industry Canada RSS-247 Issue 1
<b>Date of Test:</b>	September 25 to October 27, 2015

*We attest to the accuracy of this report:*



---

Anderson Soungpanya  
Project Engineer



---

Krishna K Vemuri  
EMC Senior Staff Engineer

## TABLE OF CONTENTS

<b>1.0</b>	<b>Summary of Tests .....</b>	<b>4</b>
<b>2.0</b>	<b>General Information .....</b>	<b>5</b>
2.1	Product Description.....	5
2.3	Test Methodology .....	6
2.4	Test Facility.....	6
2.5	Measurement Uncertainty .....	6
<b>3.0</b>	<b>System Test Configuration .....</b>	<b>7</b>
3.1	Support Equipment and description .....	7
3.2	Block Diagram of Test Setup .....	7
3.3	Justification .....	8
3.4	Mode of Operation During Test .....	8
3.5	Modifications Required for Compliance .....	8
3.6	Additions, Deviations and Exclusions from Standards .....	8
<b>4.0</b>	<b>Measurement Results.....</b>	<b>9</b>
4.1	6dB DTS Bandwidth, 6dB RSS Bandwidth and 99% Occupied Bandwidth .....	9
4.2	Maximum Conducted Output Power at Antenna Terminals .....	47
4.3	Power Spectral Density .....	65
4.4	Out-of-Band Conducted Emissions.....	79
4.5	Transmitter Radiated Emissions & Antenna Port Emissions.....	98
4.6	AC Line Conducted Emission.....	158
<b>5.0</b>	<b>RF Exposure Evaluation .....</b>	<b>162</b>
<b>6.0</b>	<b>List of Test Equipment .....</b>	<b>163</b>
<b>7.0</b>	<b>Document History .....</b>	<b>164</b>

## 1.0 Summary of Tests

Test	Reference FCC	Reference Industry Canada	Result
<b>RF Output Power</b>	15.247(b)(3)	RSS-247, 5.4	Complies
<b>6 dB Bandwidth</b>	15.247(a)(2)	RSS-247, 5.2	Complies
<b>Power Density</b>	15.247(e)	RSS-247, 5.2	Complies
<b>Out of Band Antenna Conducted Emission</b>	15.247(d)	RSS-247, 5.5	Complies
<b>Transmitter Radiated Emissions</b>	15.247(d), 15.209, 15.205	RSS-247, 5.5	Complies
<b>AC Line Conducted Emission</b>	15.207	RSS-GEN	Complies
<b>Antenna Requirement</b>	15.203	RSS-GEN	Complies (Unique Connector & Internal Antenna)
<b>RF Exposure</b>	15.247(i), 2.1093(d)	RSS-102	Complies

**EUT receive date:** September 15, 2015

**EUT receive condition:** The pre-production version of the EUT was received in good condition with no apparent damage. As declared by the Applicant, it is identical to the production units.

**Test start date:** September 25, 2015

**Test completion date:** October 27, 2015

The test results in this report pertain only to the item tested.

## 2.0 General Information

### 2.1 Product Description

The DragonBoard™ 410c is the first development board based on a Qualcomm® Snapdragon™ 400 series processor. It features advanced processing power, Wi-Fi, Bluetooth connectivity, and GPS, all packed into a board the size of a credit card. Based on the 64-bit capable Snapdragon 410 processor, the DragonBoard 410c is designed to support rapid software development, education and prototyping, and is compliant with the 96Boards Consumer Edition specification. All this makes it ideal for enabling embedded computing and Internet of Things (IoT) products, including the next generation of robotics, cameras, medical devices, vending machines, smart buildings, digital signage, casino gaming consoles, and much more.

This test report covers only the WiFi radio. A separate test report covers the Bluetooth radio.

Information about the WiFi radio is presented below:

The EUT supports a wide range of data rates in the 2.4GHz band:

- IEEE 802.11b
- IEEE 802.11g
- IEEE 802.11n 20MHz
- IEEE 802.11n 40 MHz

<b>Applicant</b>	Arrow Electronics, Inc.
<b>Model Number</b>	DragonBoard 410C
<b>FCC Identifier</b>	2AFQA-DB410C
<b>IC Identifier</b>	I20763-DB410C
<b>Modulation Technique</b>	DSSS (BPSK, QPSK, CCK), OFDM (BPSK, QPSK, 16QAM, 64QAM)
<b>Rated RF Output</b>	802.11b: 17.92 dBm 802.11g: 17.18 dBm 802.11n 20MHz: 17.83 dBm 802.11n 40 MHz: 11.93 dBm
<b>Frequency Range</b>	2412 – 2462 MHz, 802.11b/g/n 20MHz 2422 – 2452 MHz, 802.11n 40MHz
<b>Type of modulation</b>	BPSK, QPSK, 16QAM, 64QAM
<b>Number of Channel(s)</b>	11 for 802.11b/g/n 20MHz, 7 for 802.11n 40MHz
<b>Antenna(s) &amp; Gain</b>	PIFA Antenna, 3.6 dBi peak gain & Internal PCB Antenna, 0.7dBi peak gain
<b>Applicant Name &amp; Address</b>	Arrow Electronics, Inc. 7459 South Lima Bldg. 1 Englewood, CO 80112 USA

## 2.2 Related Submittal(s) Grants

None.

## 2.3 Test Methodology

Antenna conducted measurements were performed according to the FCC documents “Guidance for Performing Compliance Measurement on Digital Transmission Systems (DTS) Operating under §15.247” (KDB 558074), and RSS-247, RSS-GEN, and

Radiated emissions and AC mains conducted emissions measurements were performed according to the procedures in ANSI C63.10. Radiated tests were performed at an antenna to EUT distance of 3 meters, unless stated otherwise in the "Data Sheet" of this report.

## 2.4 Test Facility

The test site used to collect the radiated data is site 1 (10-m semi-anechoic chamber). This test facility and site measurement data have been fully placed on file with the FCC, IC and A2LA accredited.

## 2.5 Measurement Uncertainty

Compliance with the limits was based on the results of the measurements and doesn't take into account the measurement uncertainty.

### Estimated Measurement Uncertainty

Measurement	Expanded Uncertainty (k=2)		
	0.15 MHz – 1 GHz	1 GHz – 2.5 GHz	> 2.5 GHz
RF Power and Power Density – antenna conducted	-	0.7 dB	-
Unwanted emissions - antenna conducted	1.1 dB	1.3 dB	1.9 dB
Bandwidth – antenna conducted	-	30 Hz	-
Radiated emissions	4.2 dB	3.4 dB	4.4 dB
AC mains conducted emissions	2.4 dB	-	-

### 3.0 System Test Configuration

#### 3.1 Support Equipment and description

Description	Manufacturer	Model No./ Part No.
Power Adapter	Power Partners	SAW24-120-2000
HDMI Monitor	HP	ZR2440W
Keyboard	HP	KU-0316
Mouse	Logitech	M-B0001
Laptop	Asus	Eee PC Seashell Series

#### 3.2 Block Diagram of Test Setup

Antenna was removed and co-axial connector with a cable was installed for Conducted Measurements.  
500hm Load was used for Radiated Measurements.

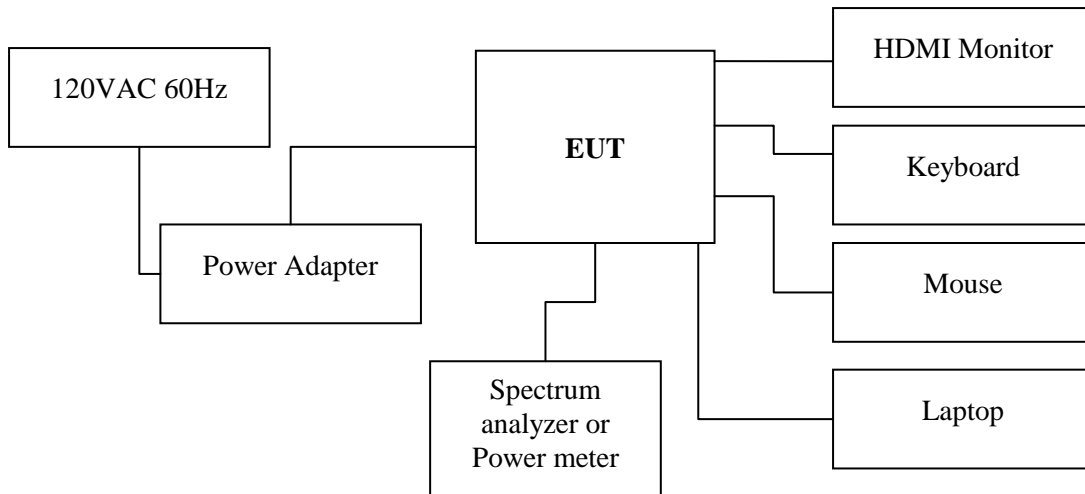

<b>S</b> = Shielded	<b>F</b> = With Ferrite
<b>U</b> = Unshielded	<b>M</b> = Meter

### 3.3 Justification

Preliminary testing was performed for all modulation/data rate modes. The worse-case data rate with highest power and widest spectrum were selected for final measurements:

- CCK 1 Mbps – for 802.11b
- OFDM 6 Mbps – for 802.11g
- OFDM MCS 6.5 – for 802.11n 20MHz
- OFDM MCS 13.5 – for 802.11n 40MHz

Unless otherwise stated in this report, measurements made for Power Density, Bandwidth, Conducted Spurious, Radiated Spurious (Cabinet Radiation) were made with the worst case power setting (mid channel power).

### 3.4 Mode of Operation During Test

During transmitter testing, the transmitter was setup to transmit continuously using the RF power setting below. Their corresponding output power in dBm can be found in section 4.2 of this report.

Frequency (MHz)	Channel	802.11b	802.11g	802.11n 20MHz	802.11n 40MHz
2412	1	20	10	10	-
2417	2	-	14	14	-
2422	3	-	16	16	10
2427	4	-	16	16	10
2432	5	-	17	17	12
2437	6	20	17	17	12
2442	7	-	17	17	12
2447	8	-	16	16	10
2452	9	-	16	16	10
2457	10	-	14	14	-
2462	11	20	10	10	-

### 3.5 Modifications Required for Compliance

Intertek installed no modifications during compliance testing in order to bring the product into compliance.

### 3.6 Additions, Deviations and Exclusions from Standards

No additions, deviations or exclusions from the standard were made.



#### 4.0 Measurement Results

##### 4.1 6dB DTS Bandwidth, 6dB RSS Bandwidth and 99% Occupied Bandwidth FCC Rule 15.247(a)(2)

###### 4.1.1 Requirement

The minimum 6-dB bandwidth shall be at least 500 kHz

###### 4.1.2 Procedure

The Procedure described in the FCC Publication 558074 was used.

The antenna port of the EUT was connected to the input of a spectrum analyzer (SA). For each RF output channel investigated, the spectrum analyzer center frequency was set to the channel carrier. A PEAK output reading was taken, a DISPLAY line was drawn 6 dB lower than PEAK level. The 6-dB bandwidth was determined from where the channel output spectrum intersected the display line.

The occupied bandwidth was measured using the built-in spectrum analyzer function for 99% power bandwidth measurement.

#### 4.1.3 Test Result

Frequency MHz	Ch.	Frequency MHz	6 dB FCC Bandwidth, MHz	Plot #	99% Bandwidth, MHz	Plot #	6 dB RSS Bandwidth, MHz	Plot #
802.11b	1	2412	8.173	1.1	12.705	1.13	8.15	1.25
	6	2437	8.077	1.2	12.960	1.14	8.15	1.26
	11	2462	8.029	1.3	12.900	1.15	8.15	1.27
802.11g	1	2412	16.442	1.4	18.120	1.16	16.68	1.28
	6	2437	16.538	1.5	18.405	1.17	16.74	1.29
	11	2462	16.298	1.6	17.955	1.18	16.82	1.30
802.11n 20MHz	1	2412	17.692	1.7	18.600	1.19	17.82	1.31
	6	2437	17.692	1.8	18.870	1.20	17.94	1.32
	11	2462	17.692	1.9	18.705	1.21	17.94	1.33
802.11n 40MHz	3	2422	35.497	1.10	36.950	1.22	36.12	1.34
	6	2437	35.577	1.11	37.275	1.23	36.12	1.35
	9	2452	36.058	1.12	37.250	1.24	36.36	1.36

*Plot 1.1 – 6dB Bandwidth (FCC)*

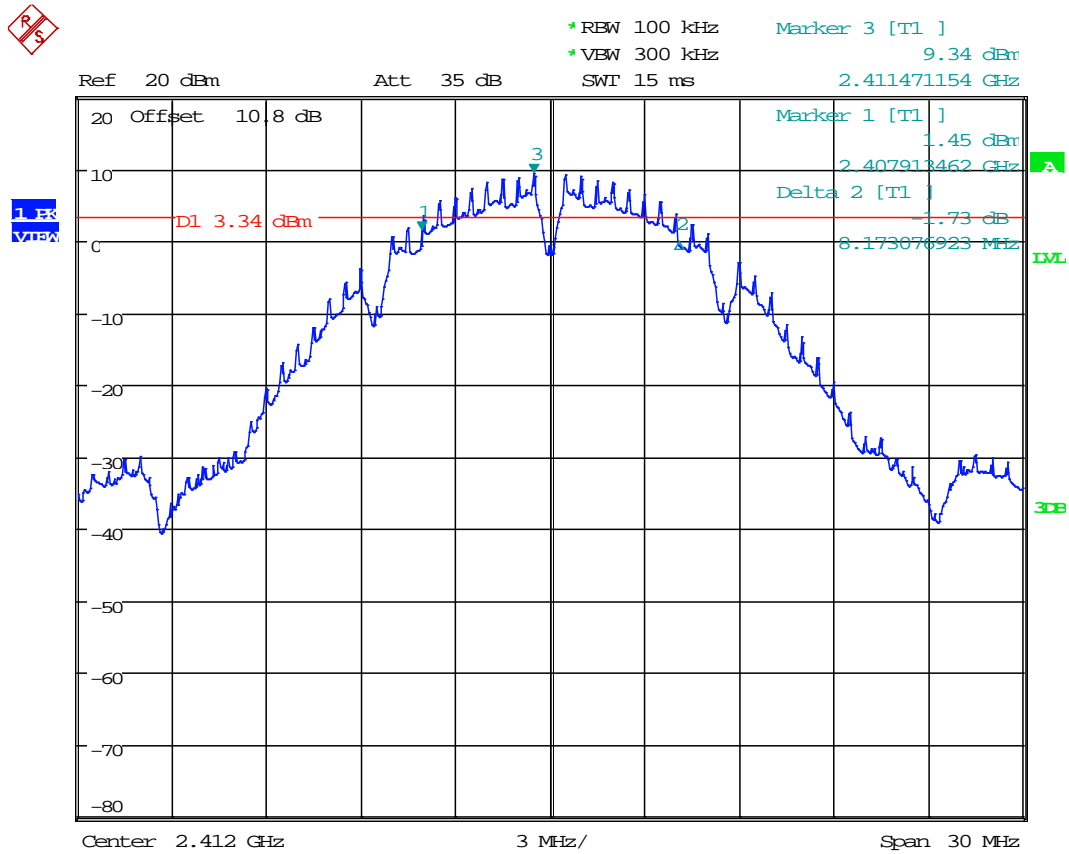

Date: 16.OCT.2015 11:35:09

Plot 1.2 – 6dB Bandwidth (FCC)

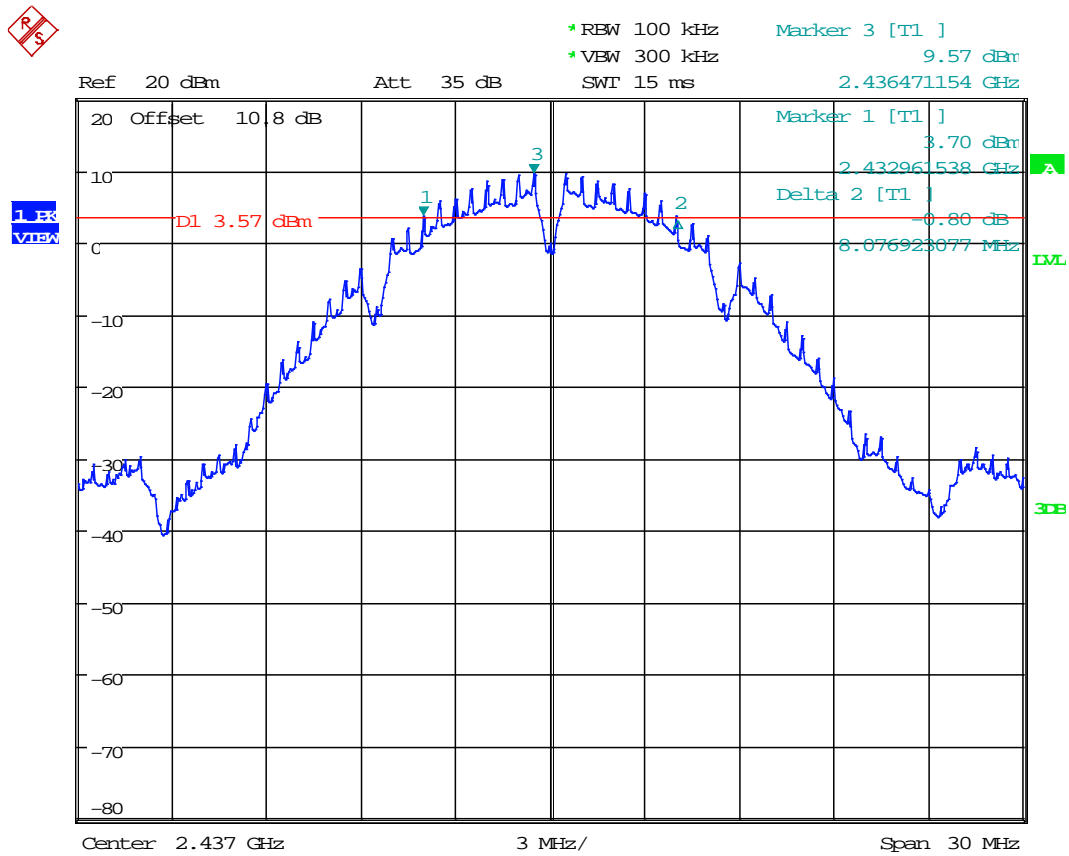

Date: 16.OCT.2015 11:36:48

*Plot 1 3 – 6dB Bandwidth (FCC)*

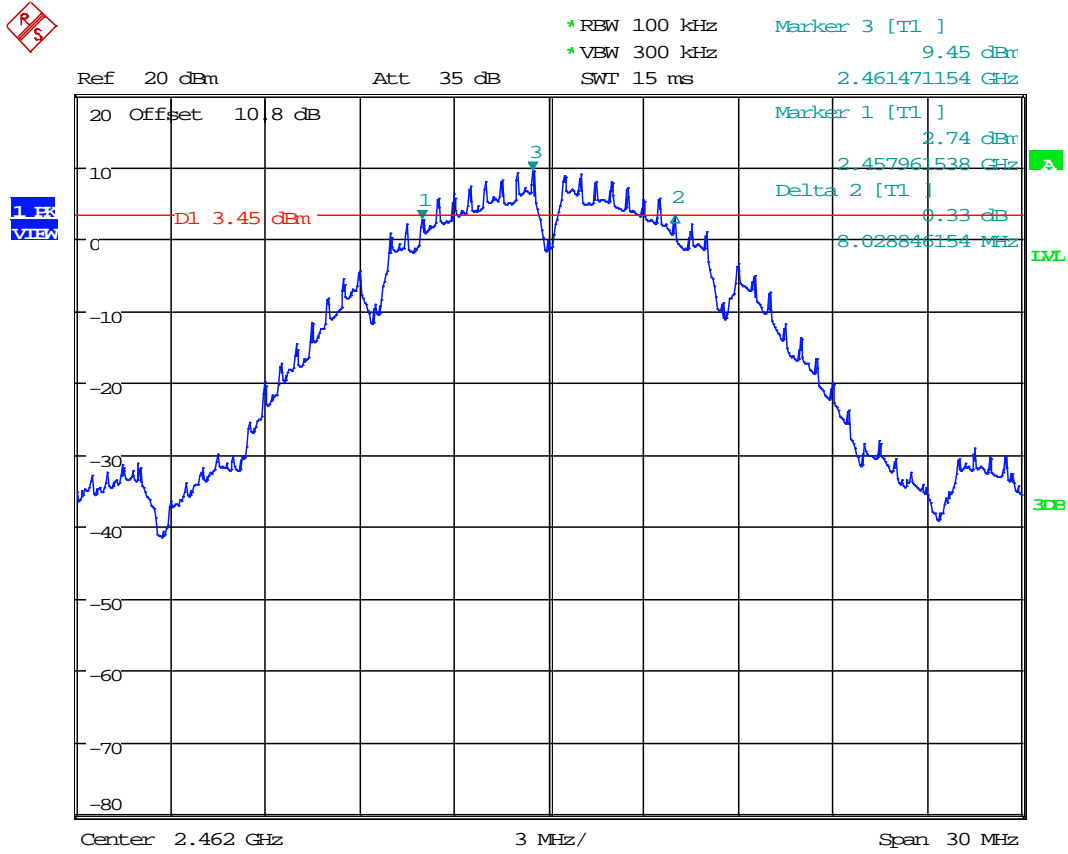

Date: 16.OCT.2015 11:39:32

Plot 1.4 – 6dB Bandwidth (FCC)

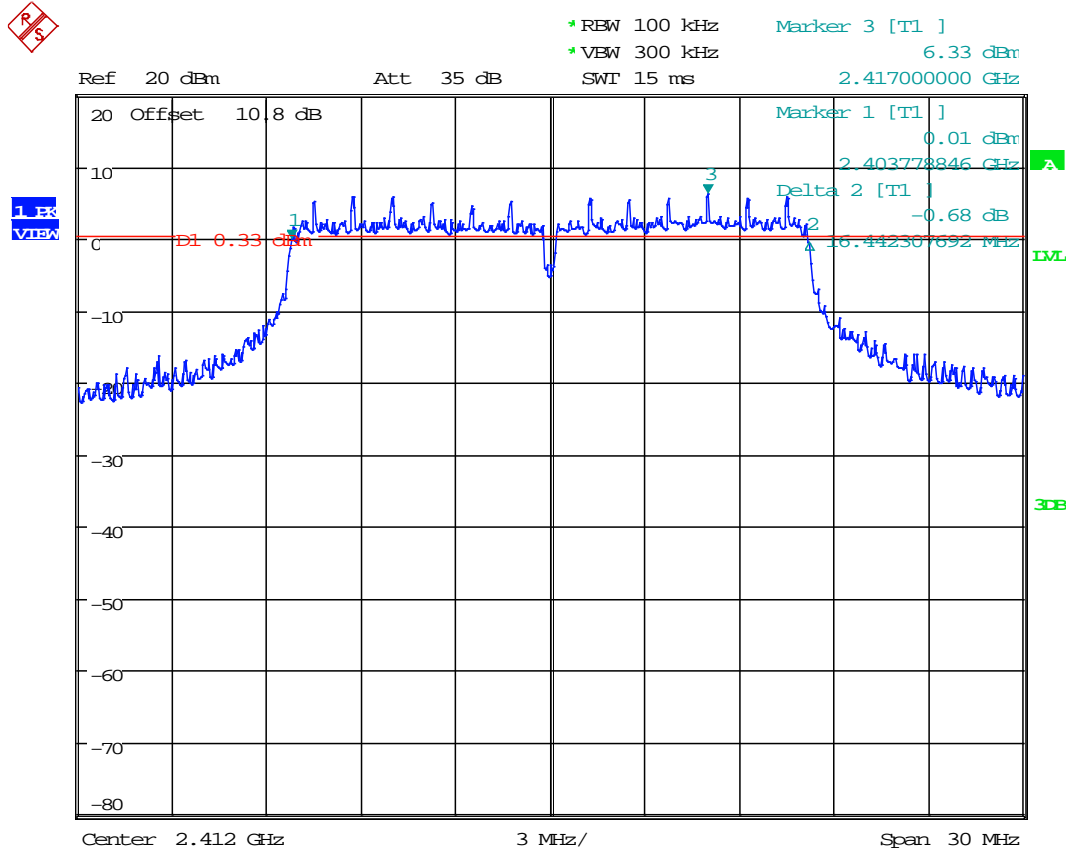

Date: 16.OCT.2015 11:46:45

Plot 1.5 – 6dB Bandwidth (FCC)

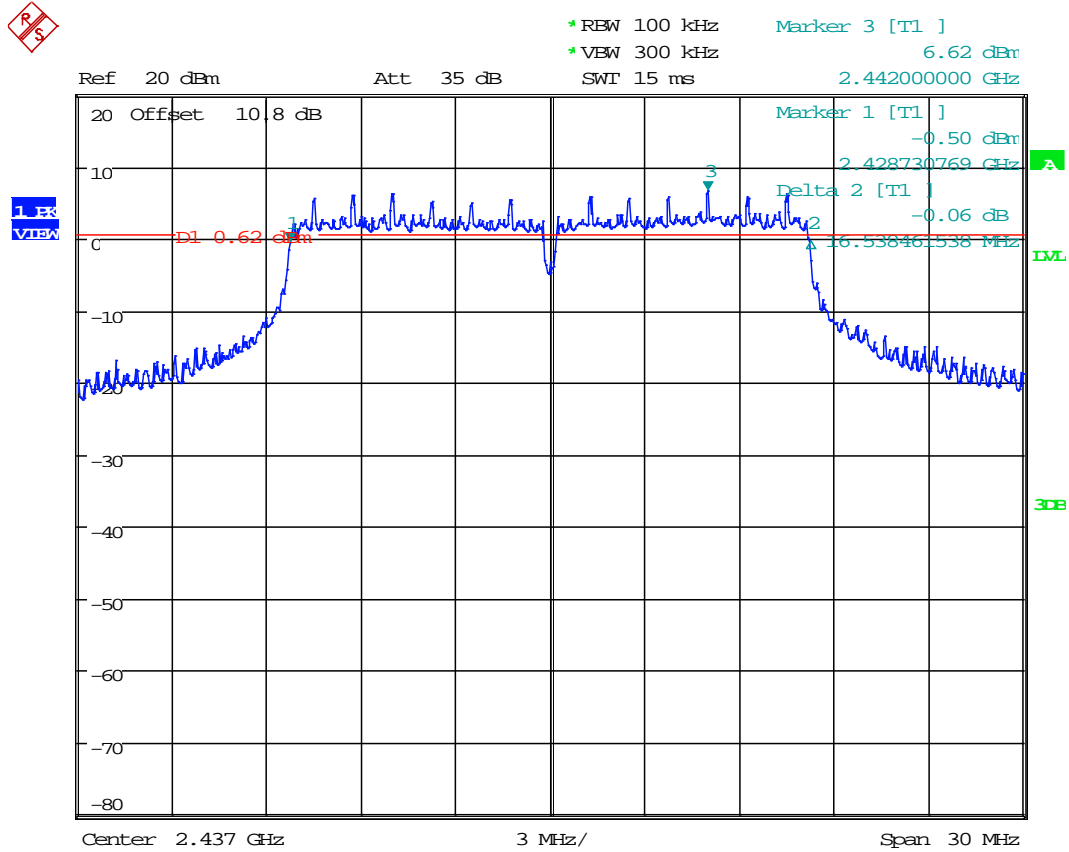

Date: 16.OCT.2015 11:43:43



Plot 1.6 – 6dB Bandwidth (FCC)

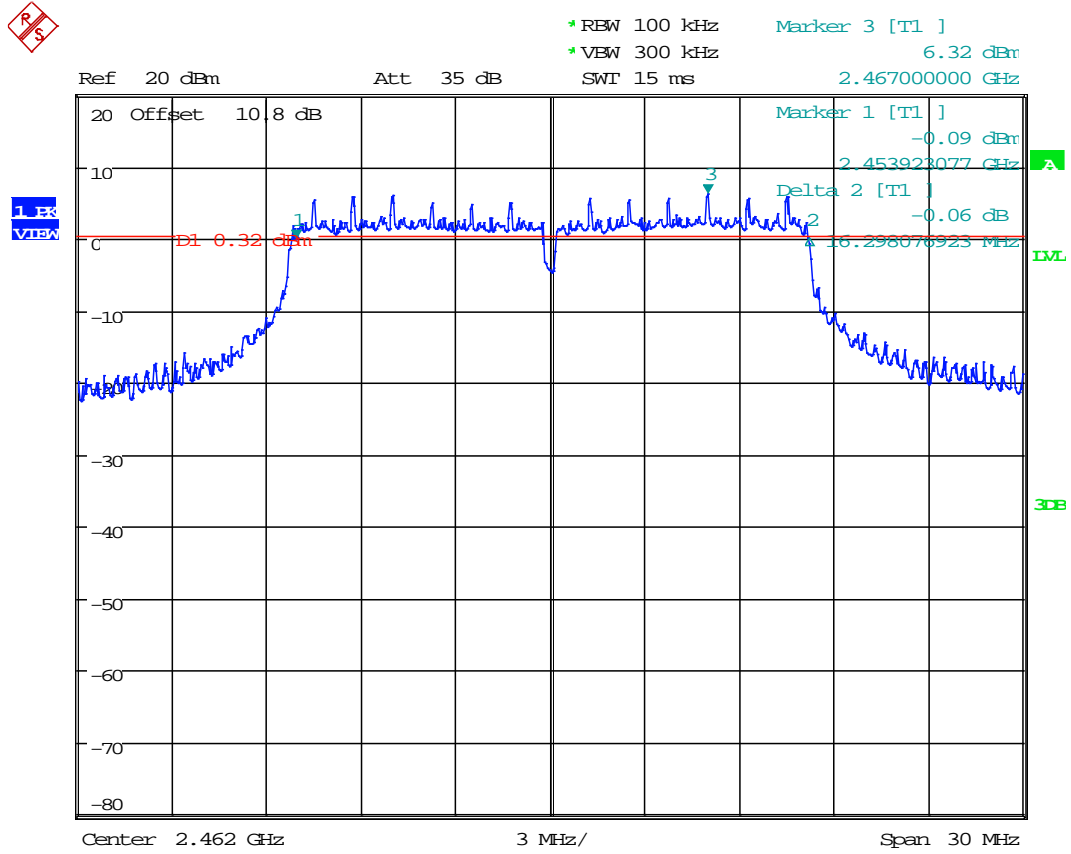

Date: 16.OCT.2015 11:41:42



*Plot 1.7 – 6dB Bandwidth (FCC)*

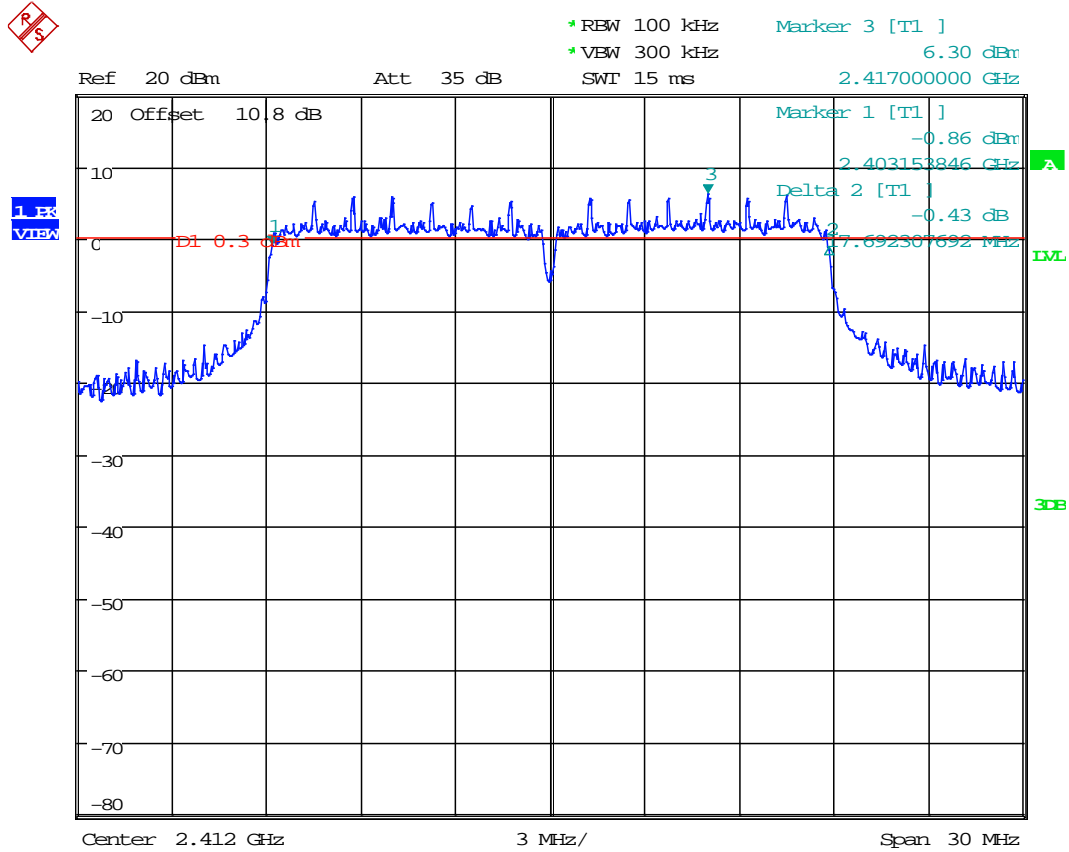

Date: 16.OCT.2015 11:47:58

Plot 1.8 – 6dB Bandwidth (FCC)

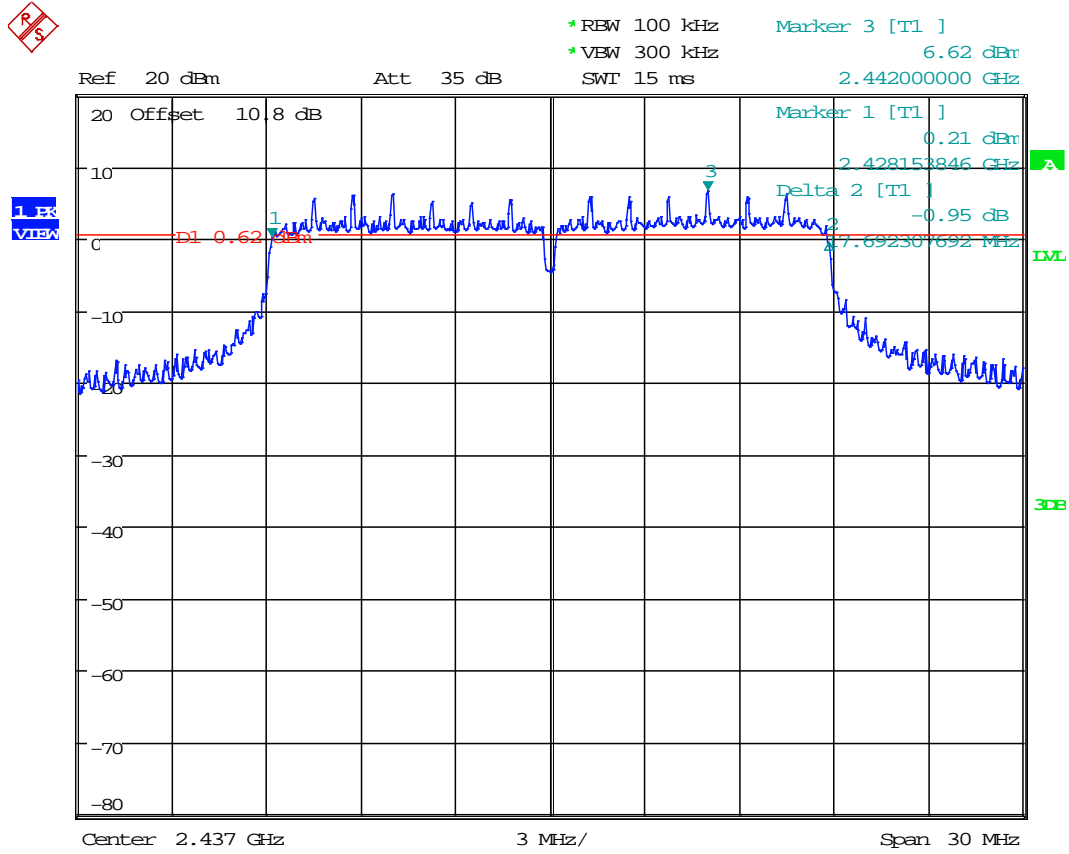

Date: 16.OCT.2015 11:50:19

Plot 1.9 – 6dB Bandwidth (FCC)

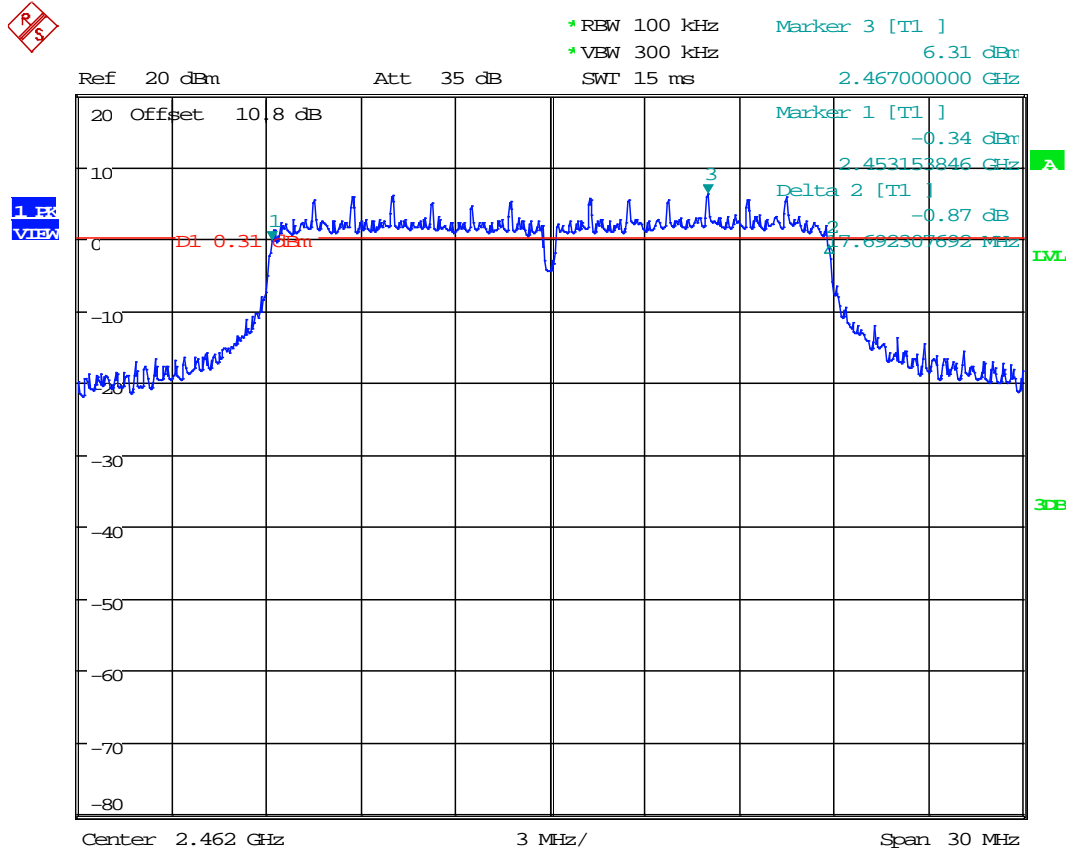

Date: 16.OCT.2015 12:12:42

Plot 1.10 – 6dB Bandwidth (FCC)

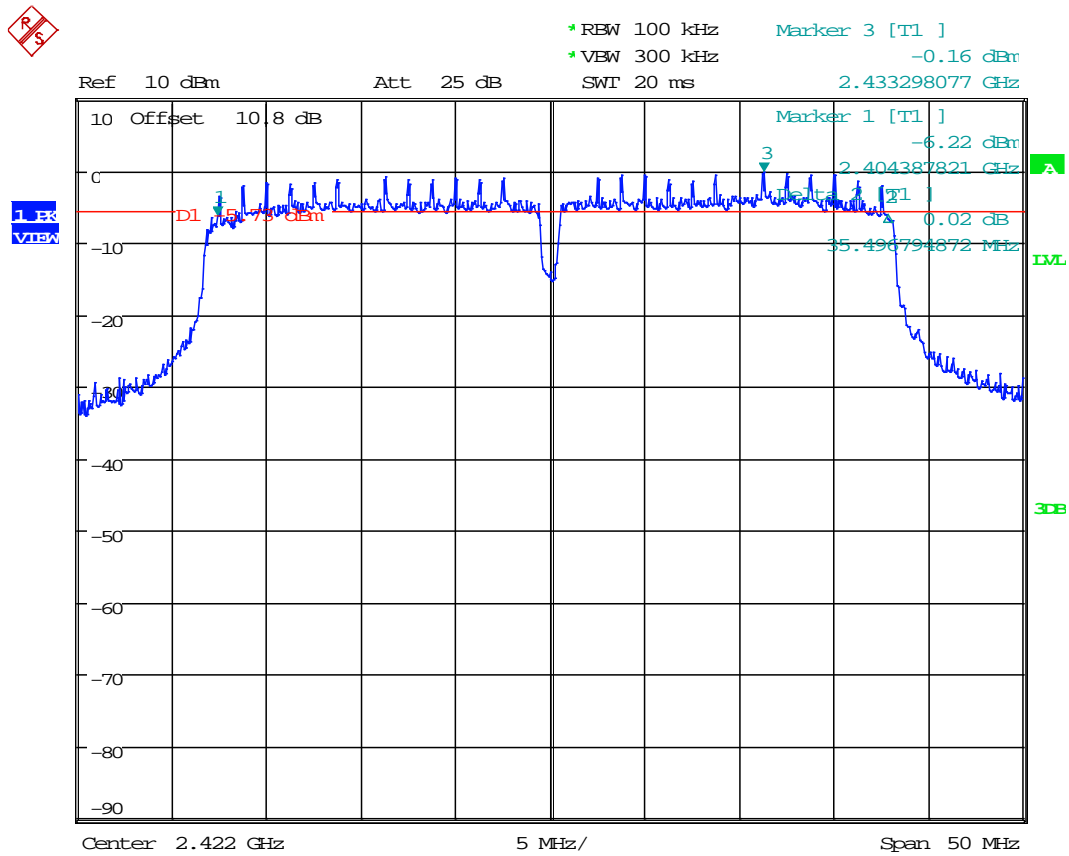

Date: 16.OCT.2015 11:29:12



Plot 1.11 – 6dB Bandwidth (FCC)

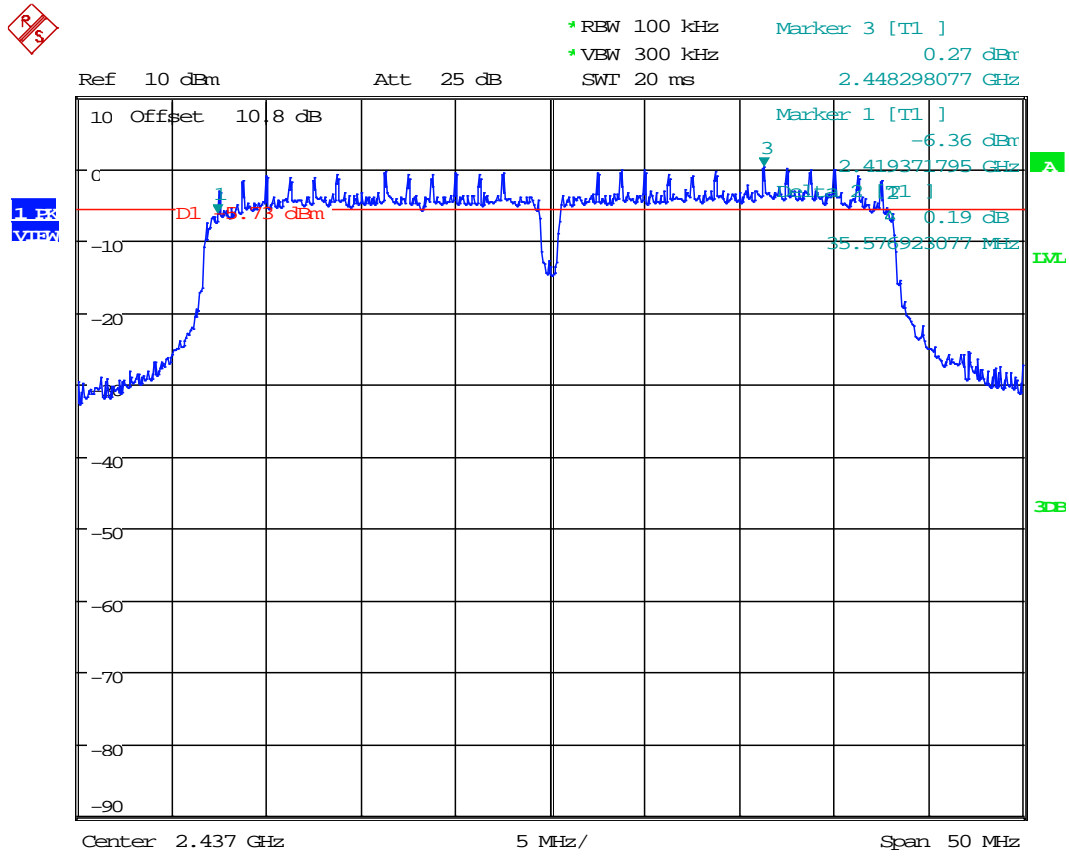

Date: 16.OCT.2015 11:26:53



Plot 1.12 – 6dB Bandwidth (FCC)

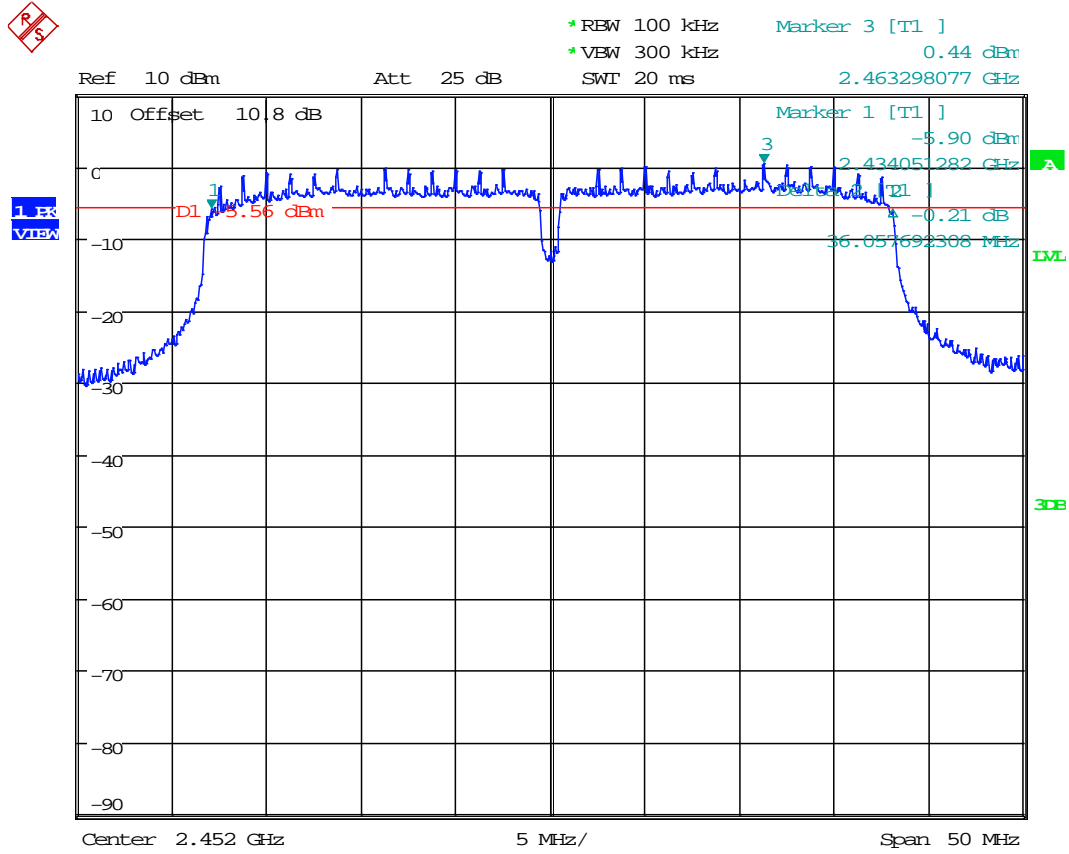

Date: 16.OCT.2015 11:23:21

Plot 1.13 – 99% Bandwidth

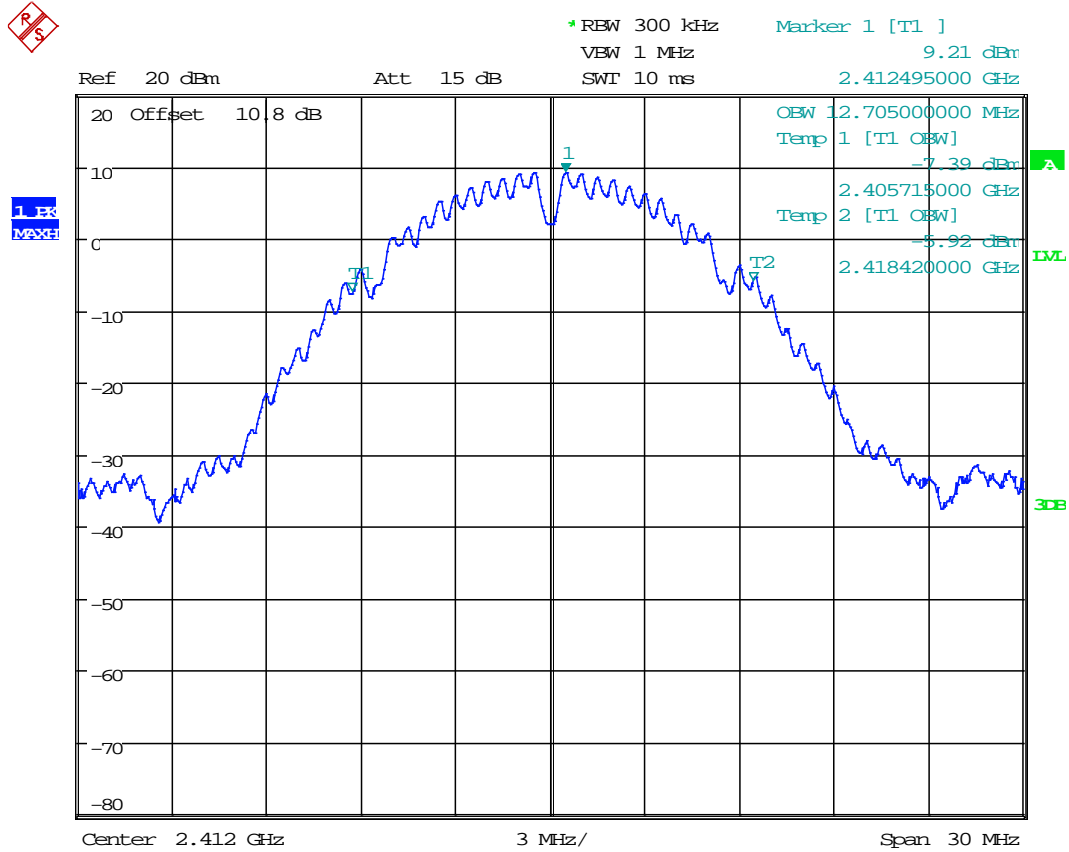

Date: 19.OCT.2015 07:57:38

Plot 1.14 – 99% Bandwidth

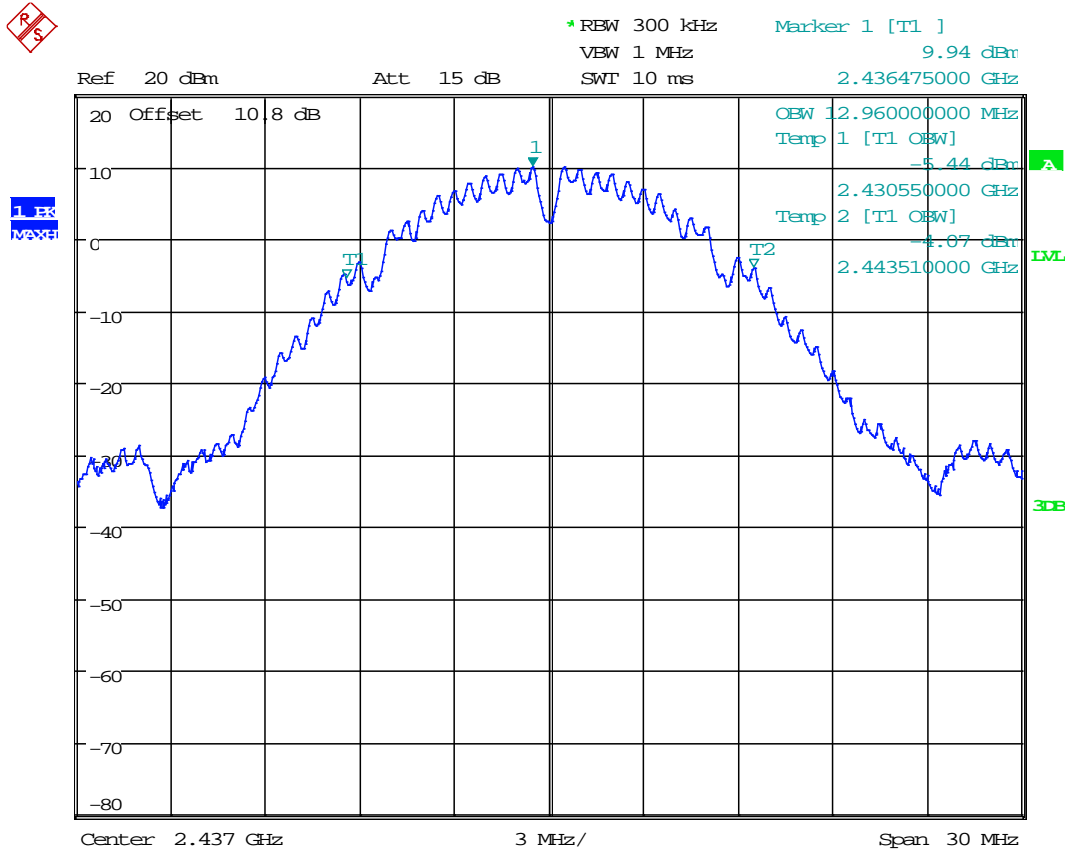

Date: 19.OCT.2015 08:21:05



*Plot 1.15 – 99% Bandwidth*

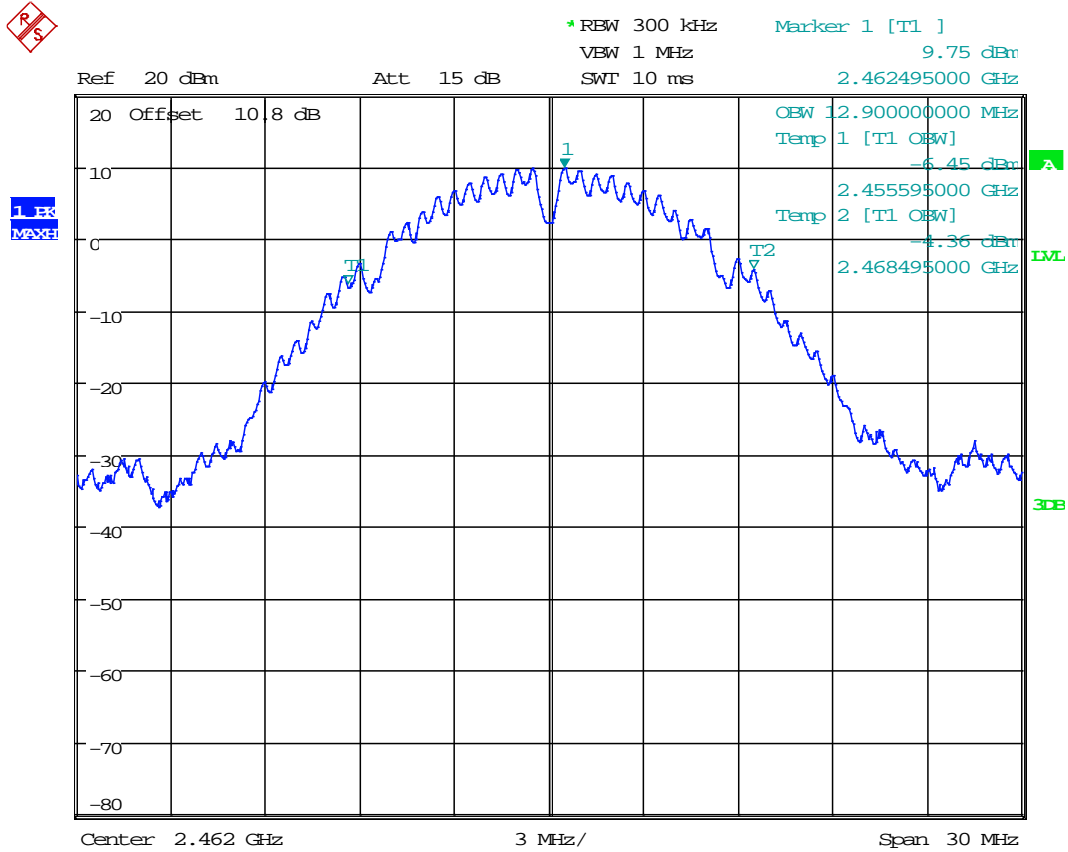

Date: 19.OCT.2015 08:20:17

*Plot 1.16 – 99% Bandwidth*

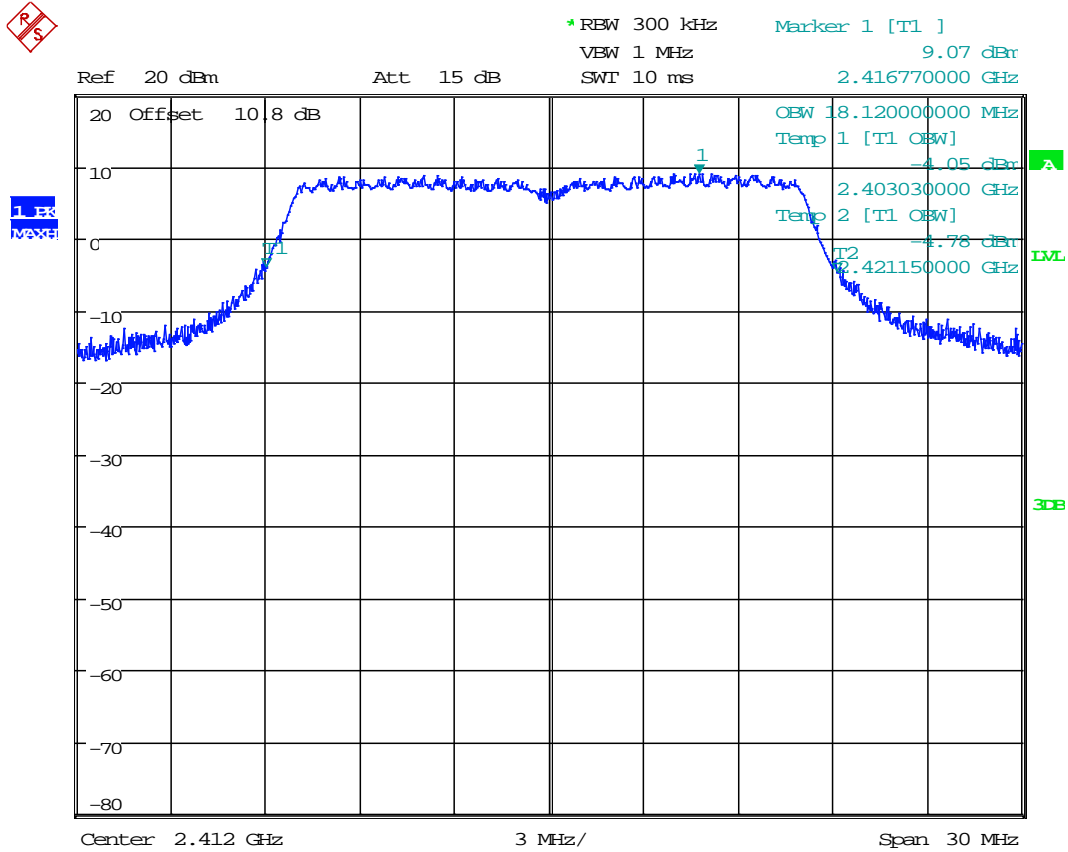

Date: 19.OCT.2015 08:27:49

*Plot 1.17 – 99% Bandwidth*

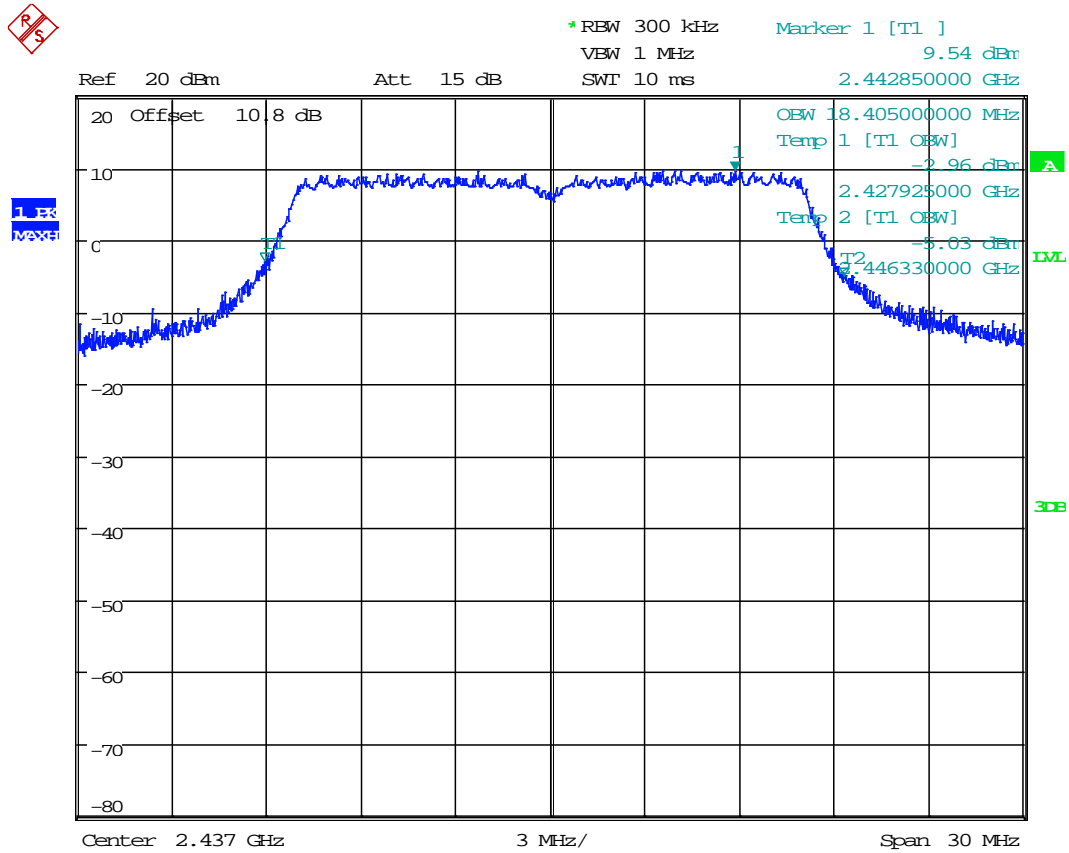

Date: 19.OCT.2015 08:29:59



Plot 1.18 - 99% Bandwidth

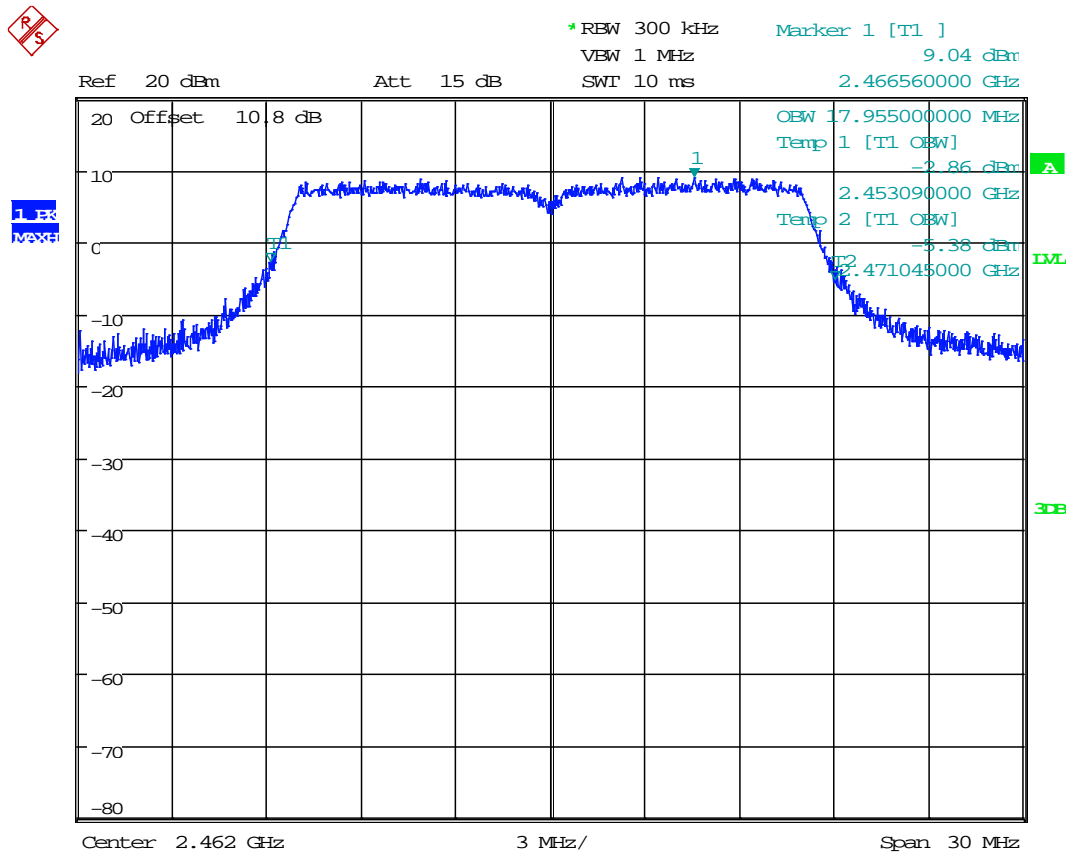

Date: 19.OCT.2015 08:30:52

Plot 1.19 – 99% Bandwidth

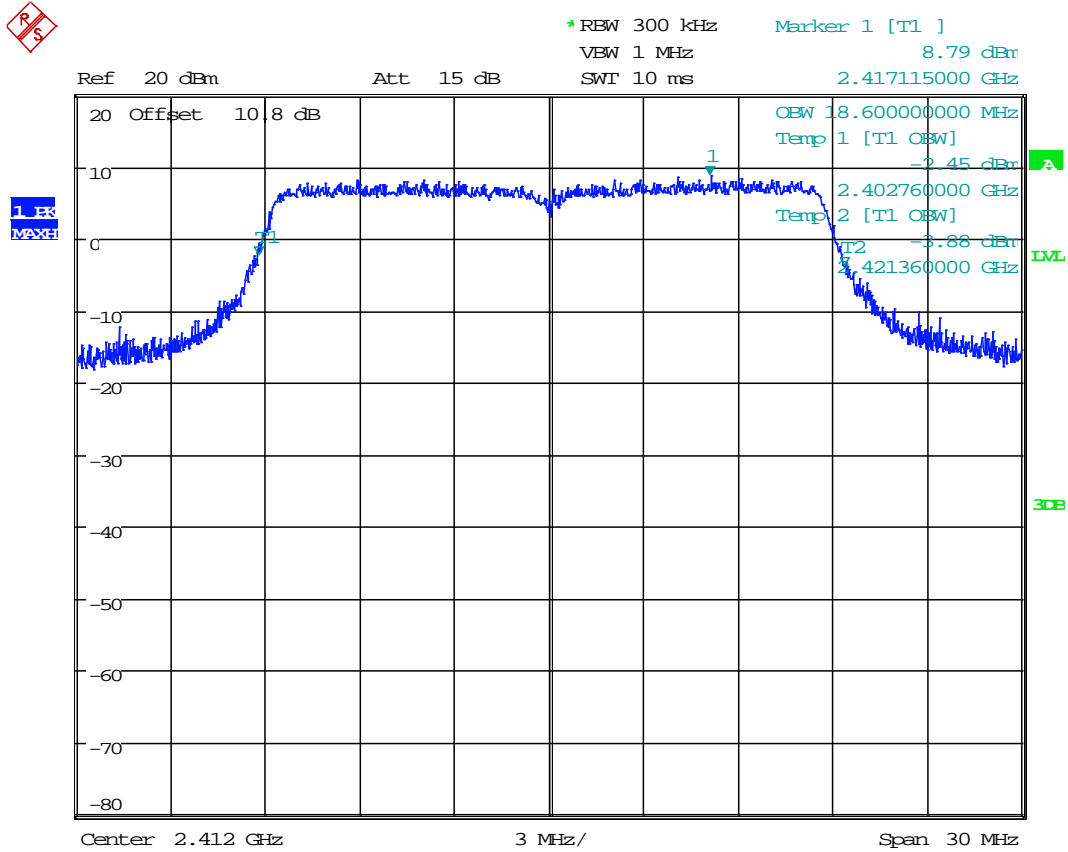

Date: 19.OCT.2015 08:33:40

Plot 1.20 – 99% Bandwidth

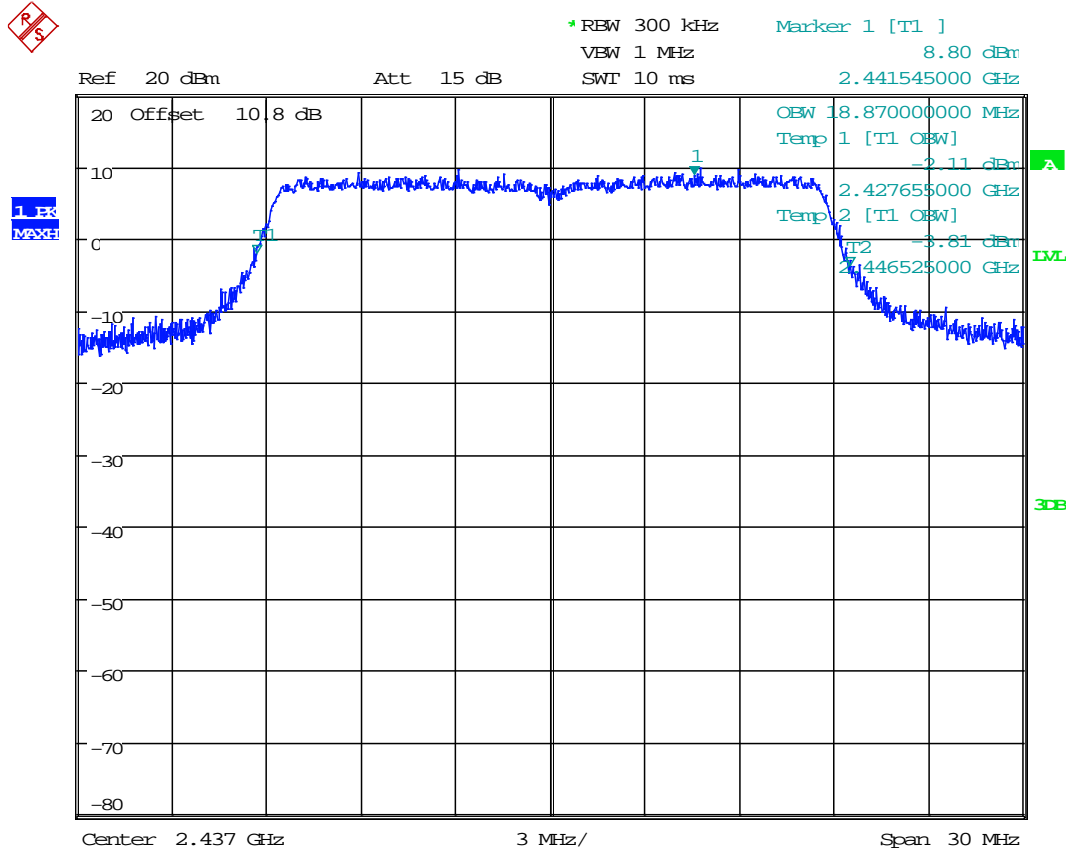

Date: 19.OCT.2015 08:32:49

Plot 1.21 – 99% Bandwidth

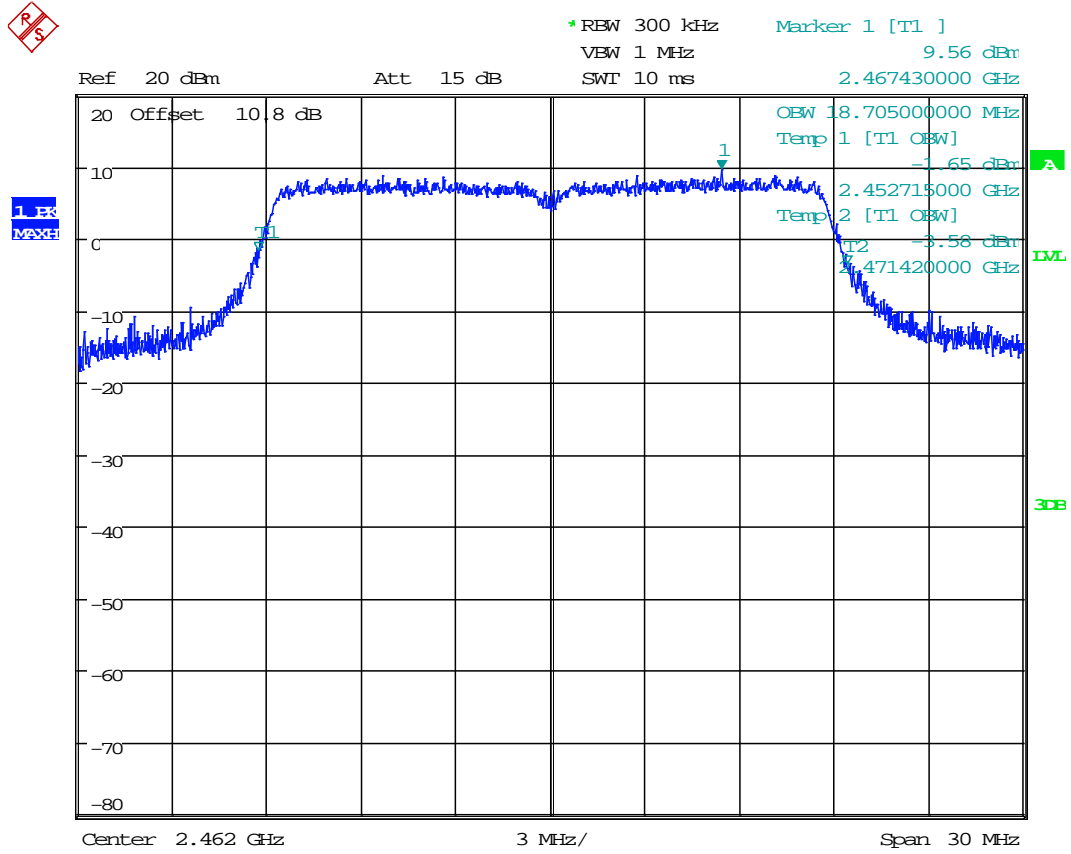

Date: 19.OCT.2015 08:31:31

Plot 1.22 – 99% Bandwidth

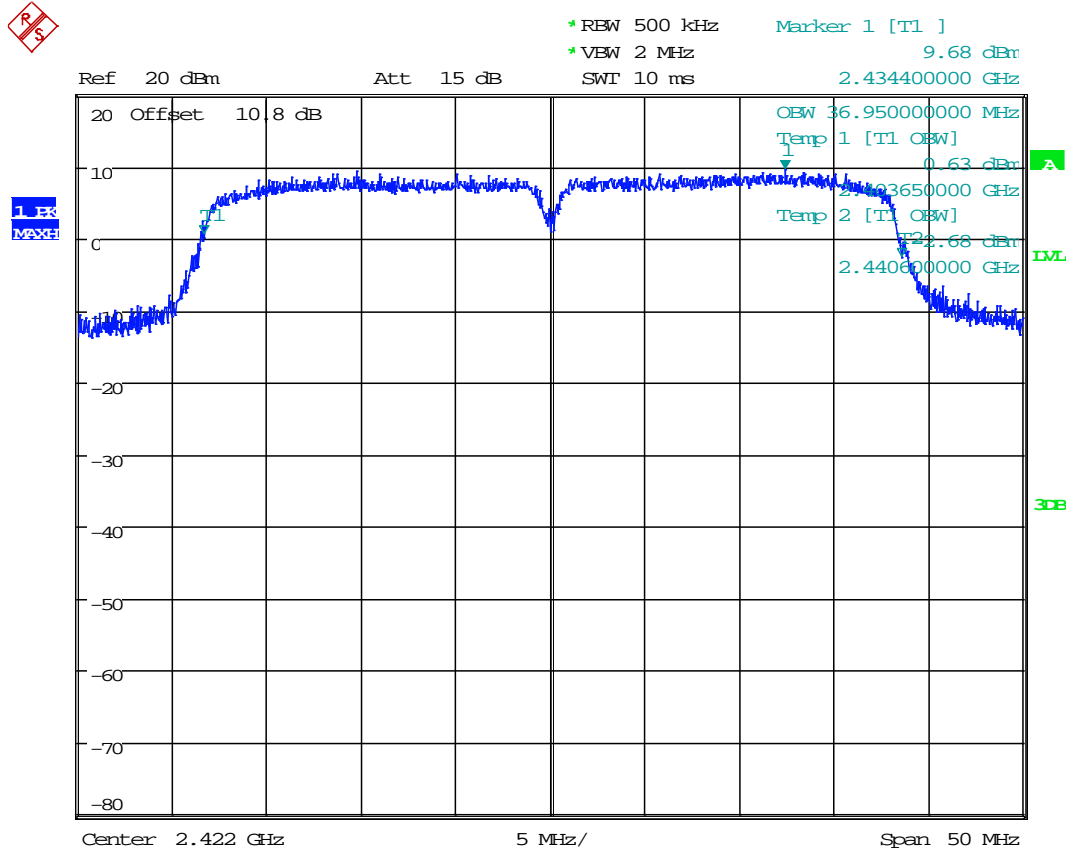

Date: 19.OCT.2015 08:35:23



Plot 1.23 – 99% Bandwidth

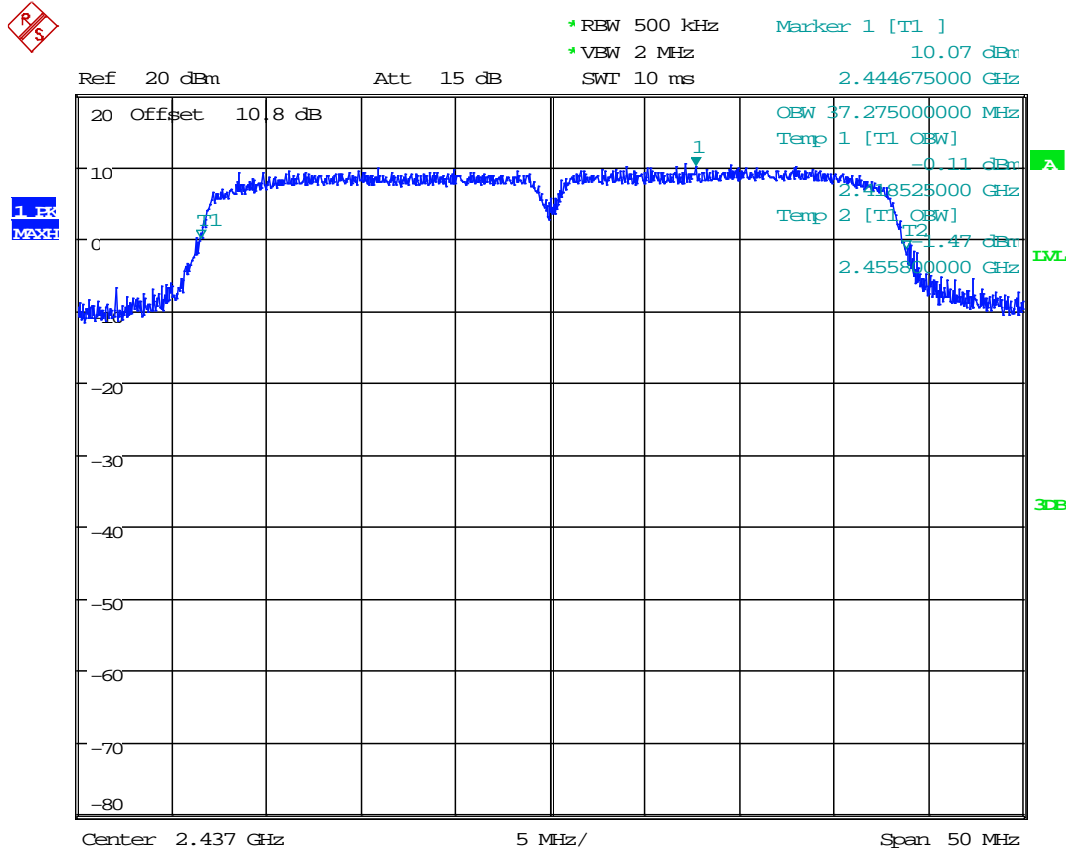

Date: 19.OCT.2015 08:36:17

Plot 1.24 – 99% Bandwidth

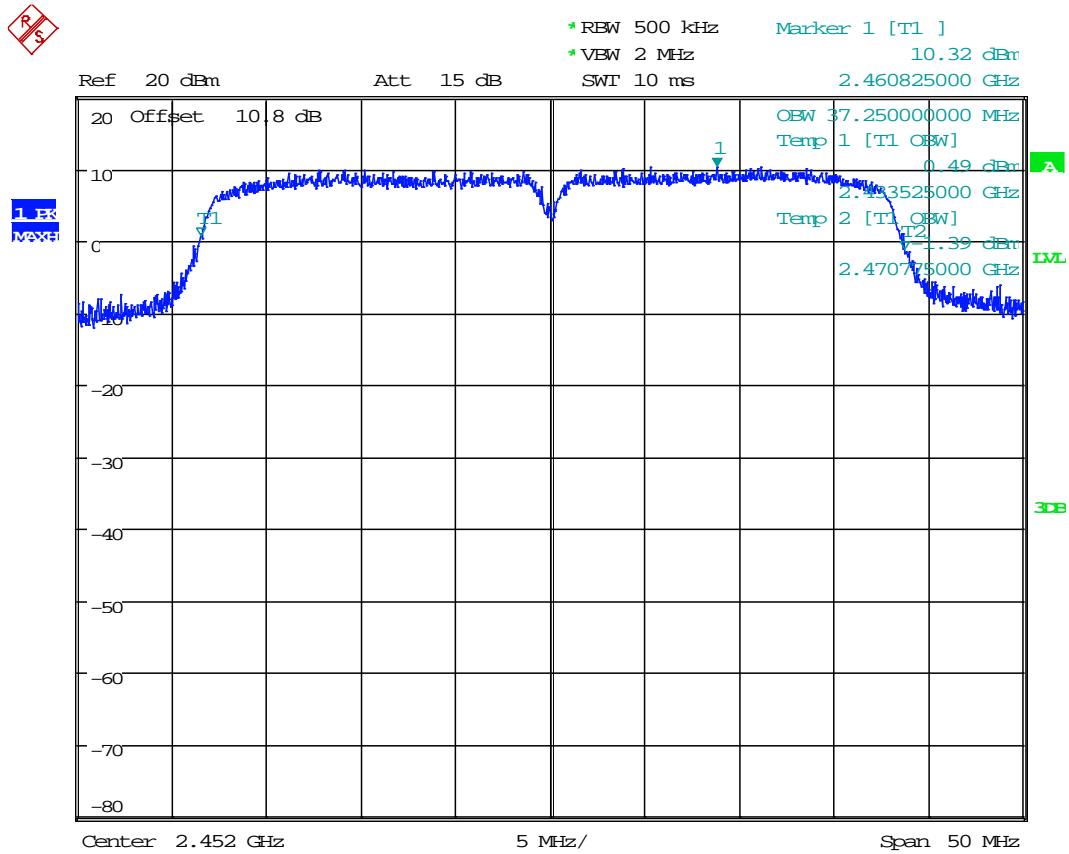

Date: 19.OCT.2015 08:37:19

Plot 1.25 – 6dB Bandwidth (RSS)

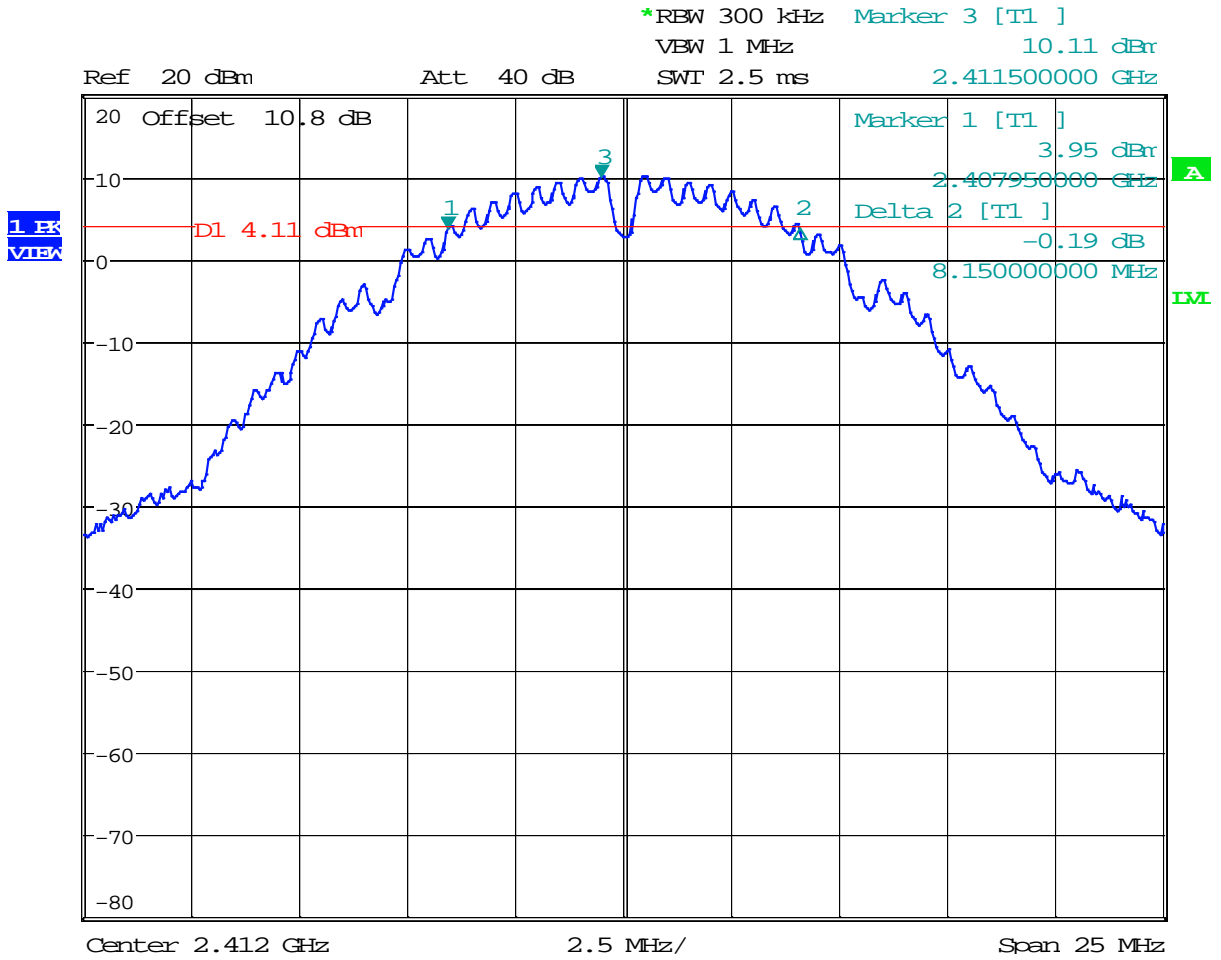

Date: 27.OCT.2015 14:10:25



Plot 1.26 – 6dB Bandwidth (RSS)

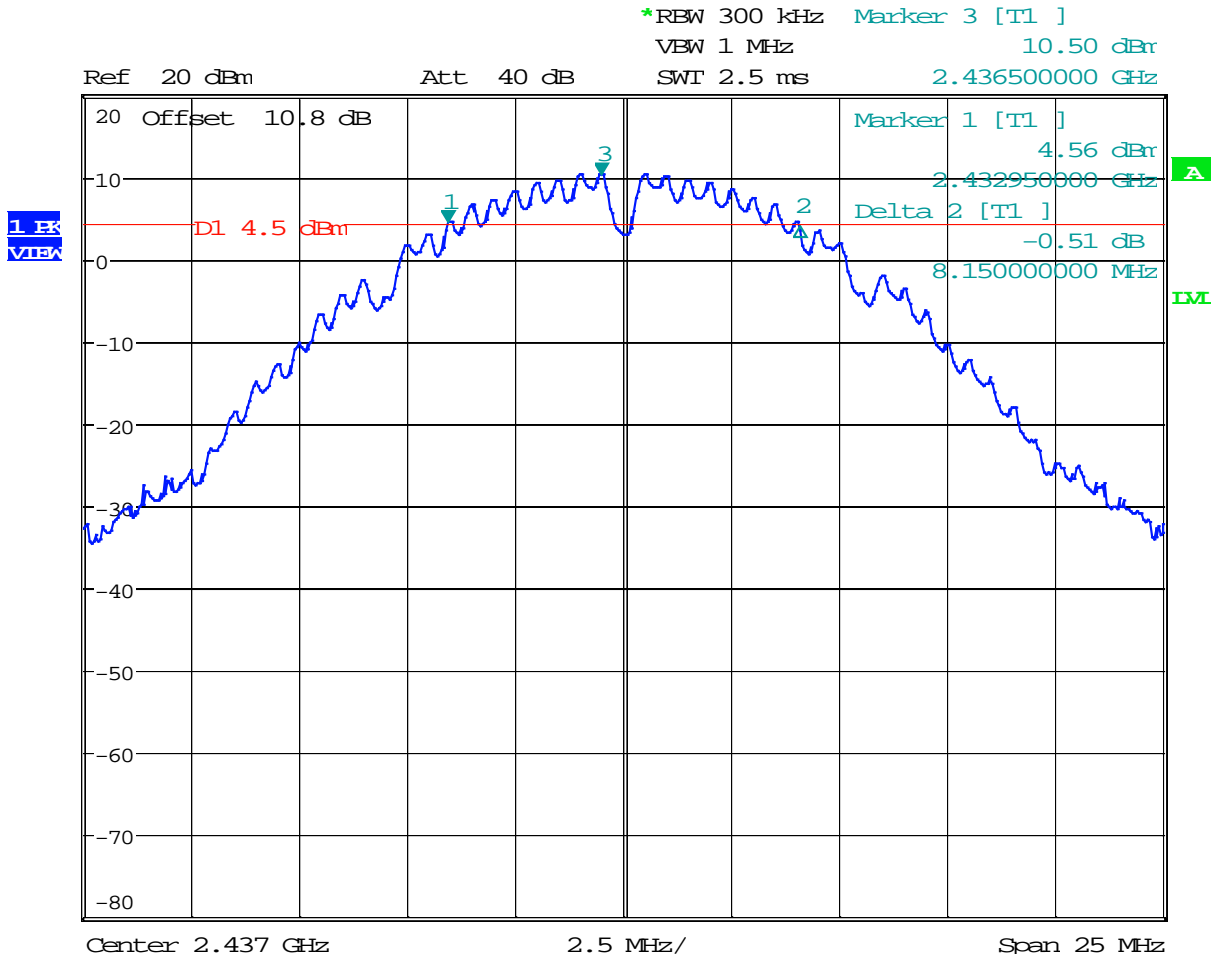

Date: 27.OCT.2015 14:15:05

Plot 1.27 – 6dB Bandwidth (RSS)

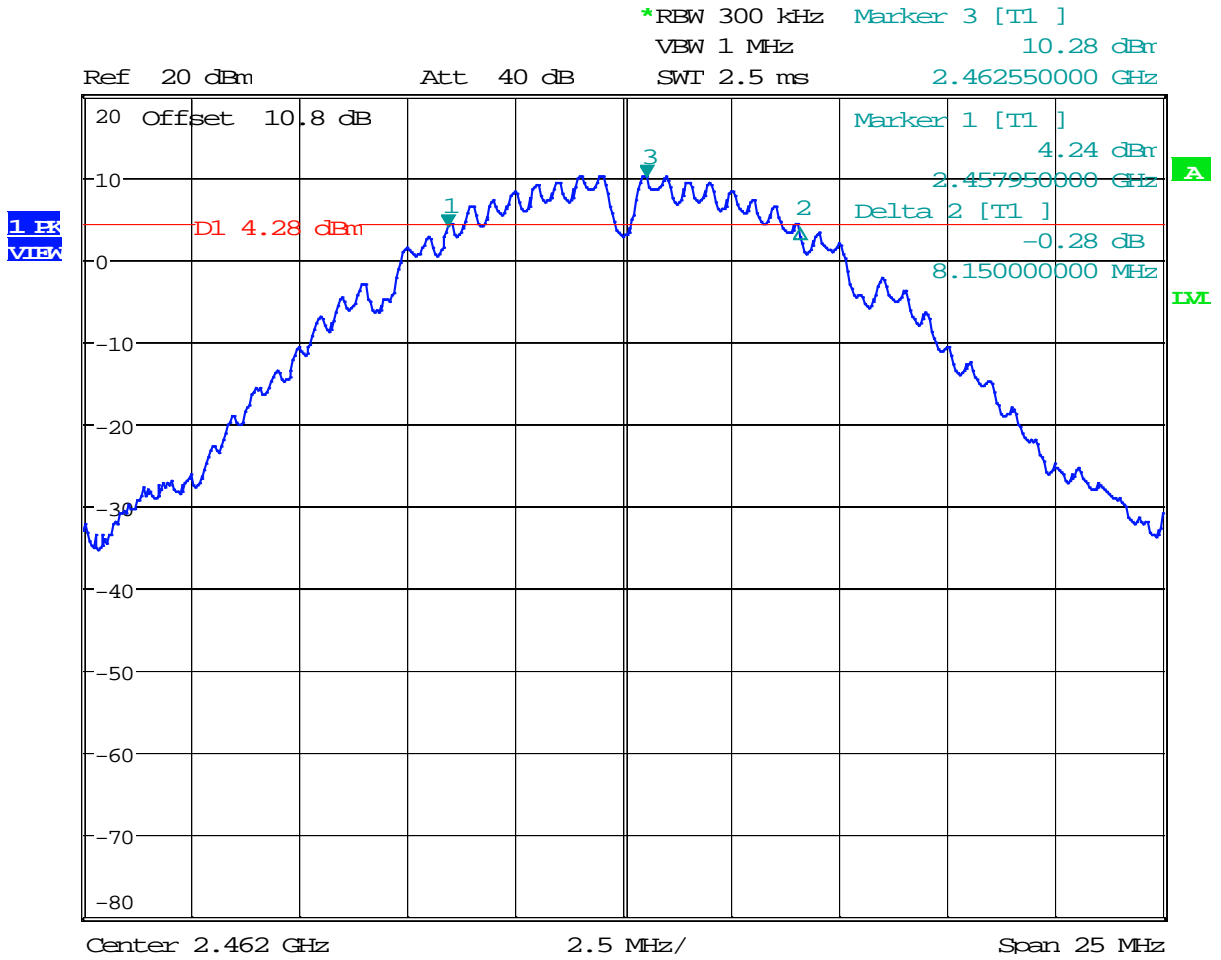

Date: 27.OCT.2015 14:16:10

Plot 1.28 – 6dB Bandwidth (RSS)

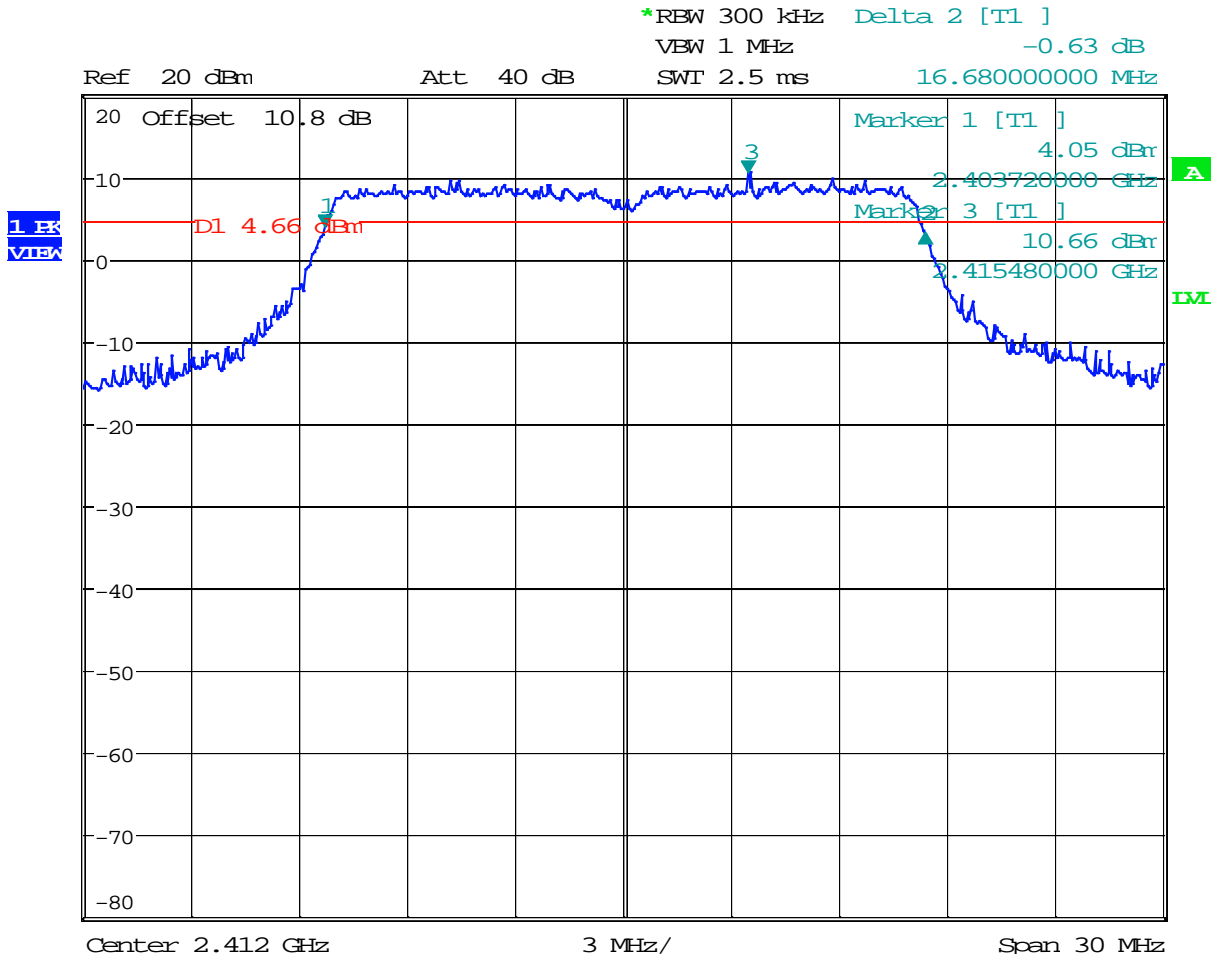

Date: 27.OCT.2015 14:21:52

Plot 1.29 – 6dB Bandwidth (RSS)

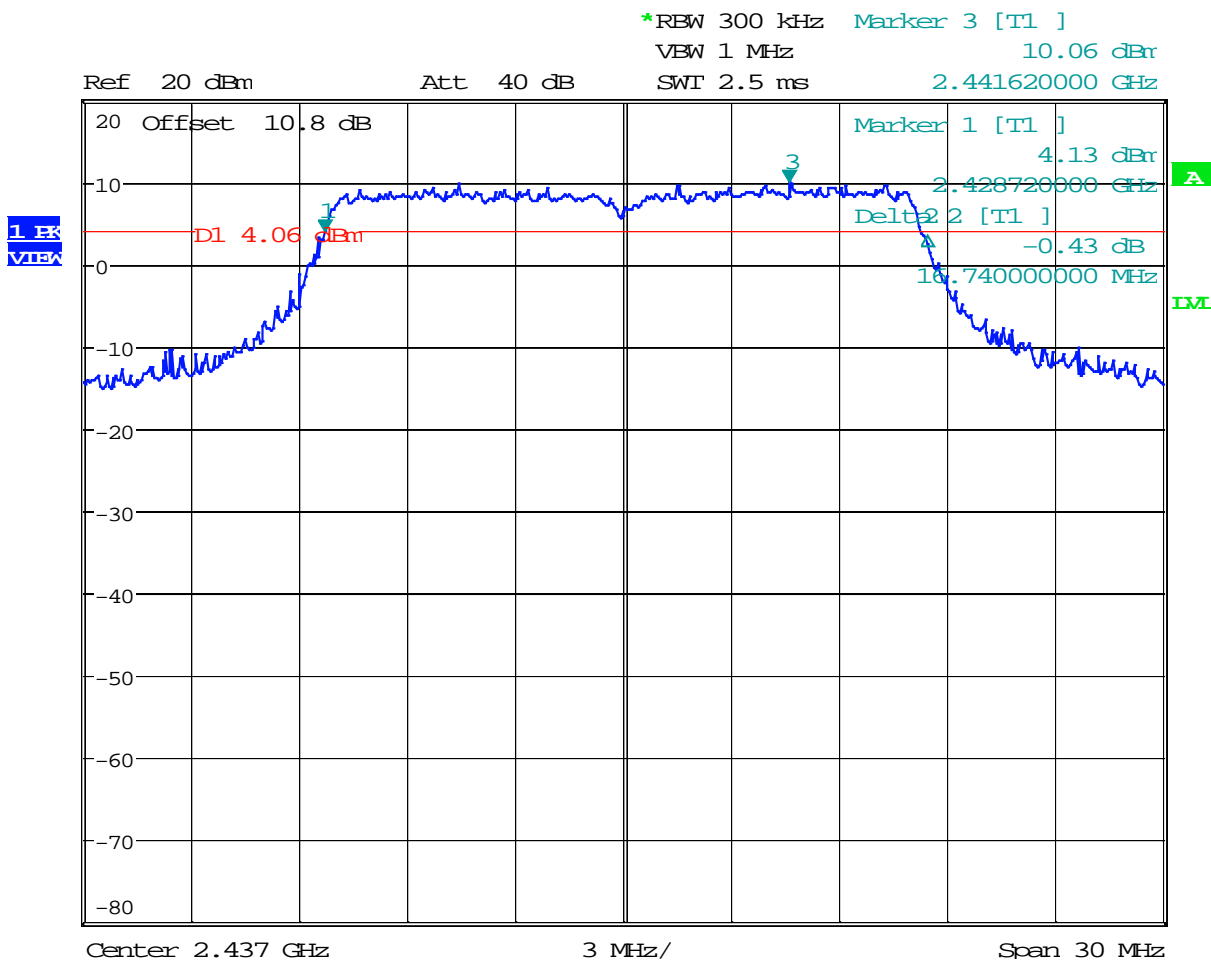

Date: 27.OCT.2015 14:20:14

*Plot 1.30 – 6dB Bandwidth (RSS)*

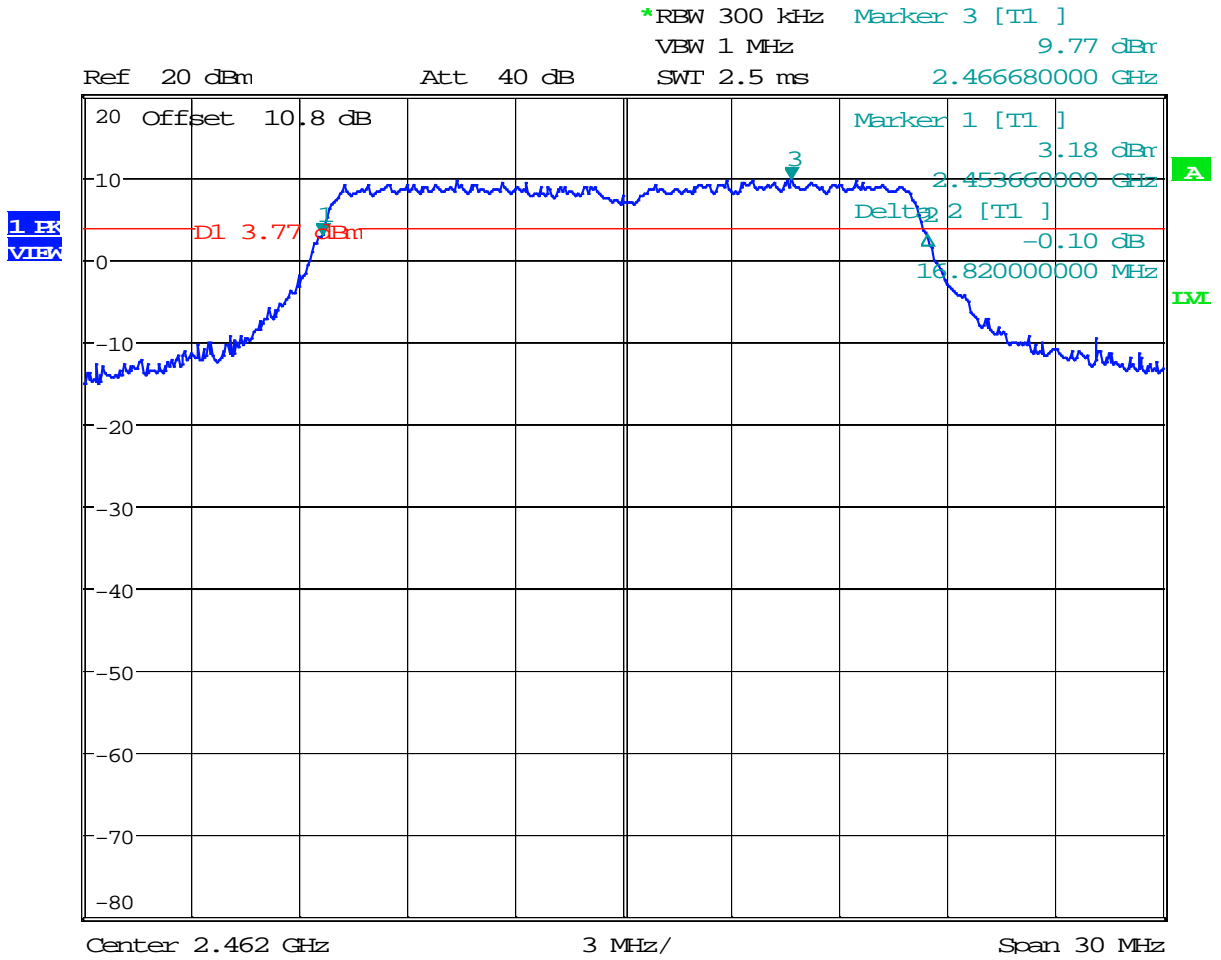

Date: 27.OCT.2015 14:18:43



Plot 1.31 – 6dB Bandwidth (RSS)

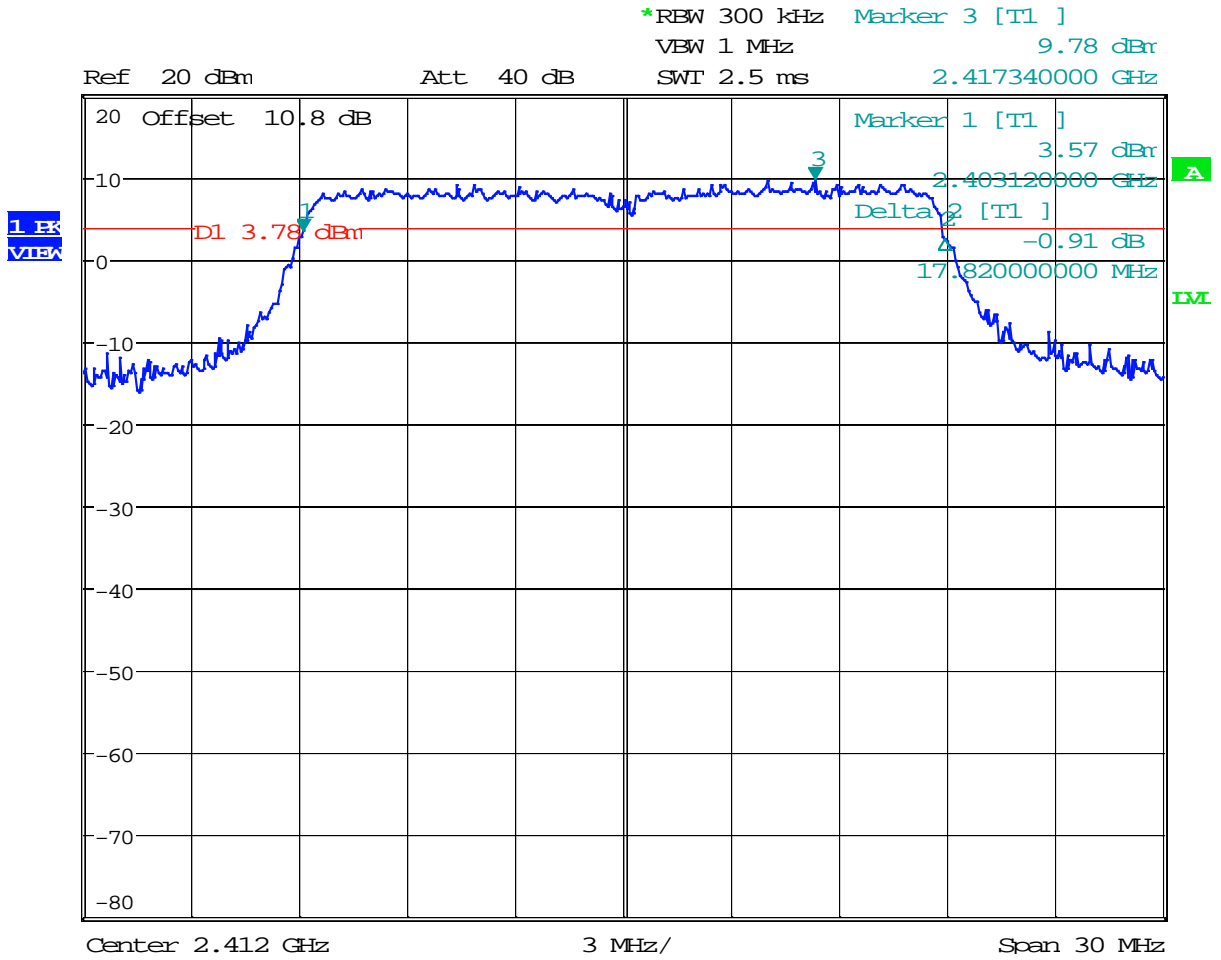

Date: 27.OCT.2015 14:24:41

Plot 1.32 – 6dB Bandwidth (RSS)

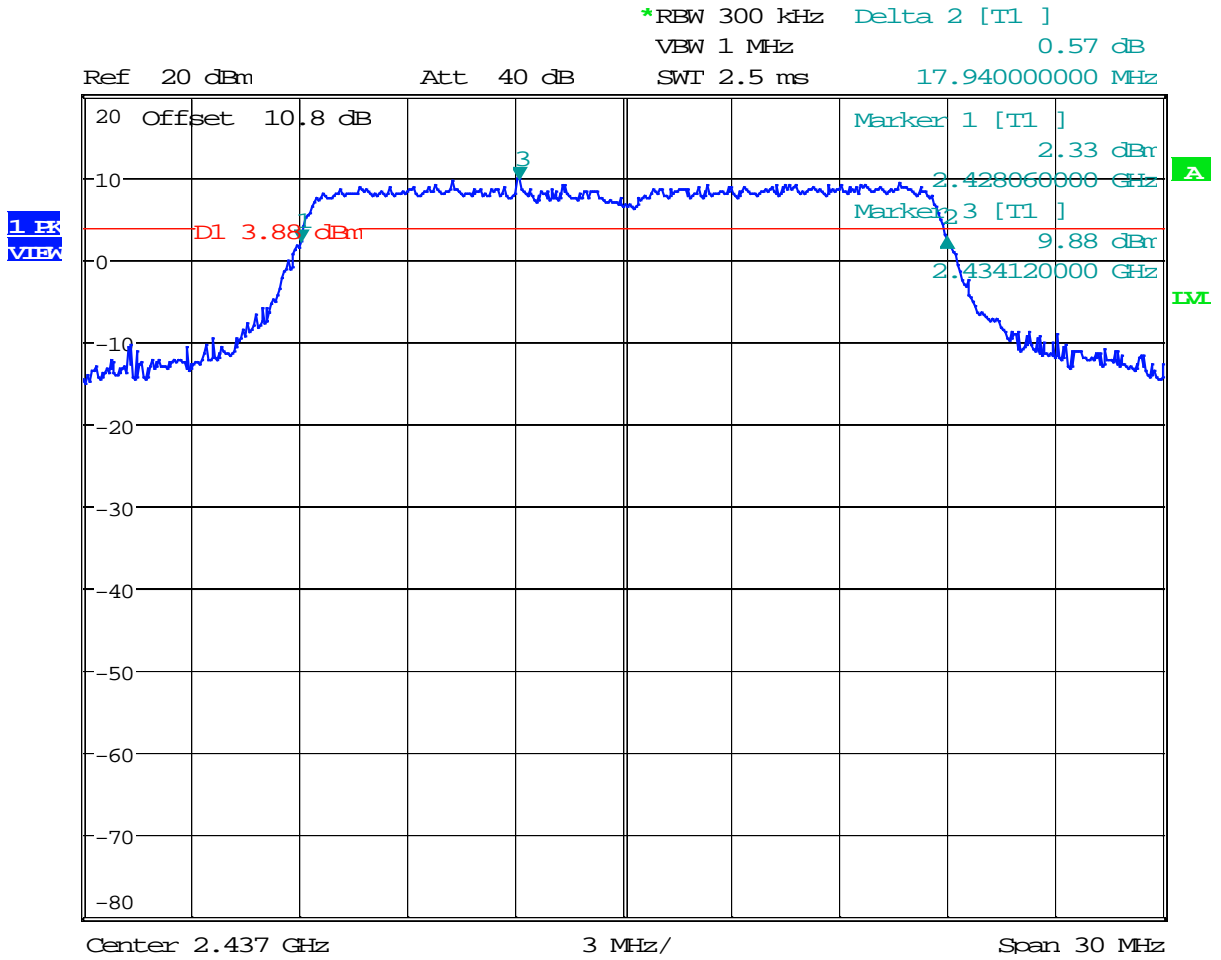

Date: 27.OCT.2015 14:26:31

Plot 1.33 – 6dB Bandwidth (RSS)

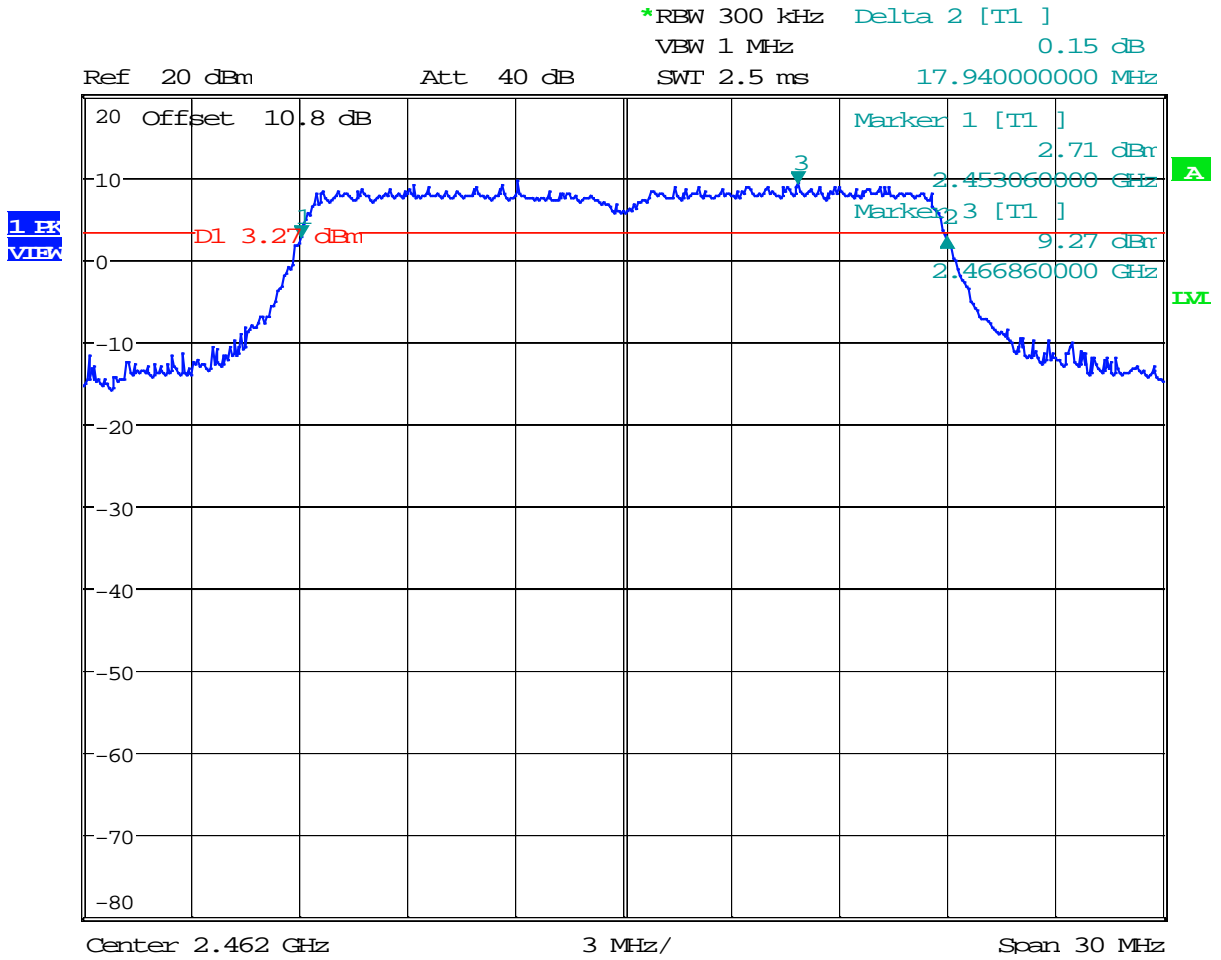

Date: 27.OCT.2015 14:27:52

Plot 1.34 – 6dB Bandwidth (RSS)

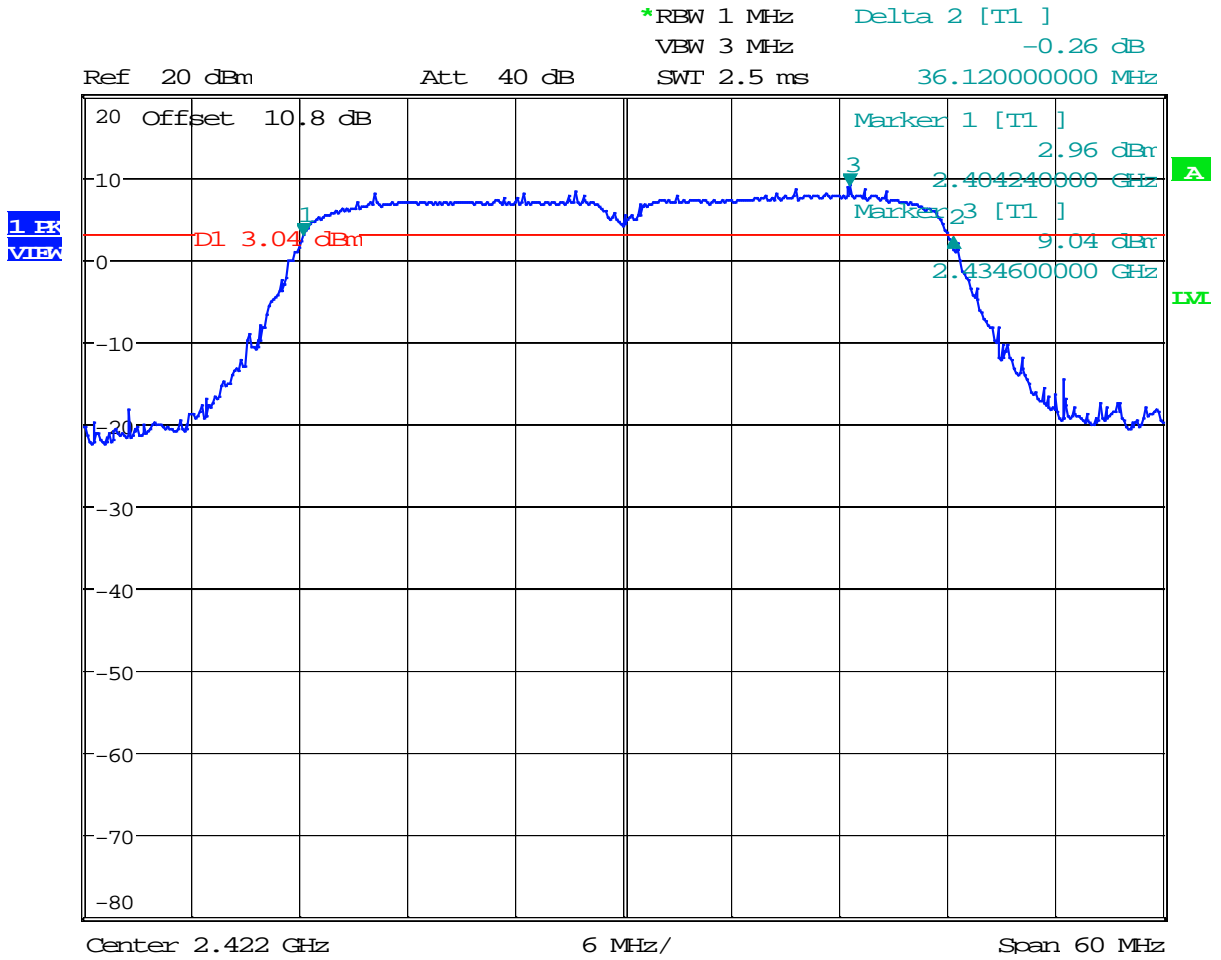

Date: 27.OCT.2015 14:30:37

Plot 1.35 – 6dB Bandwidth (RSS)

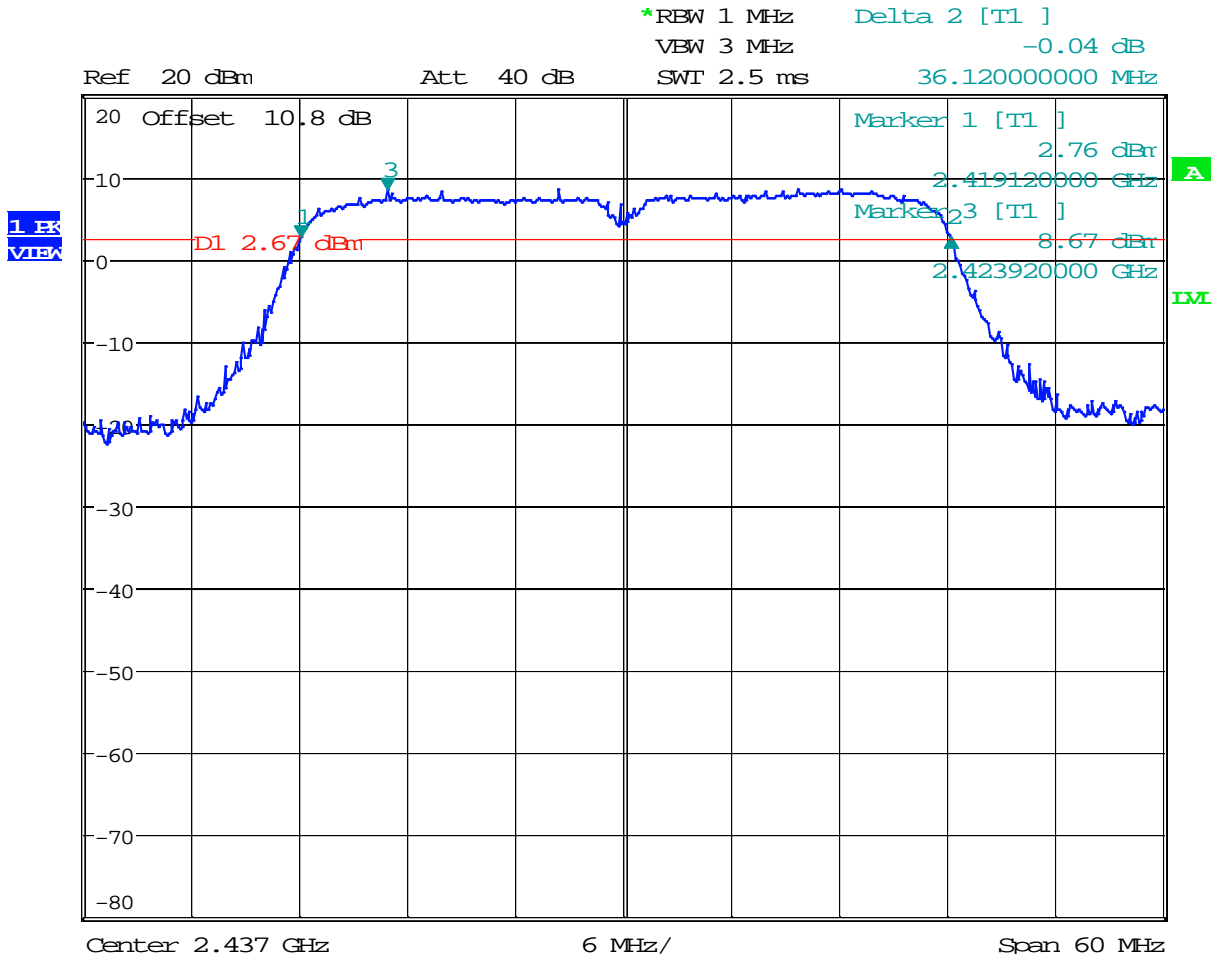

Date: 27.OCT.2015 14:32:09

Plot 1.36 – 6dB Bandwidth (RSS)

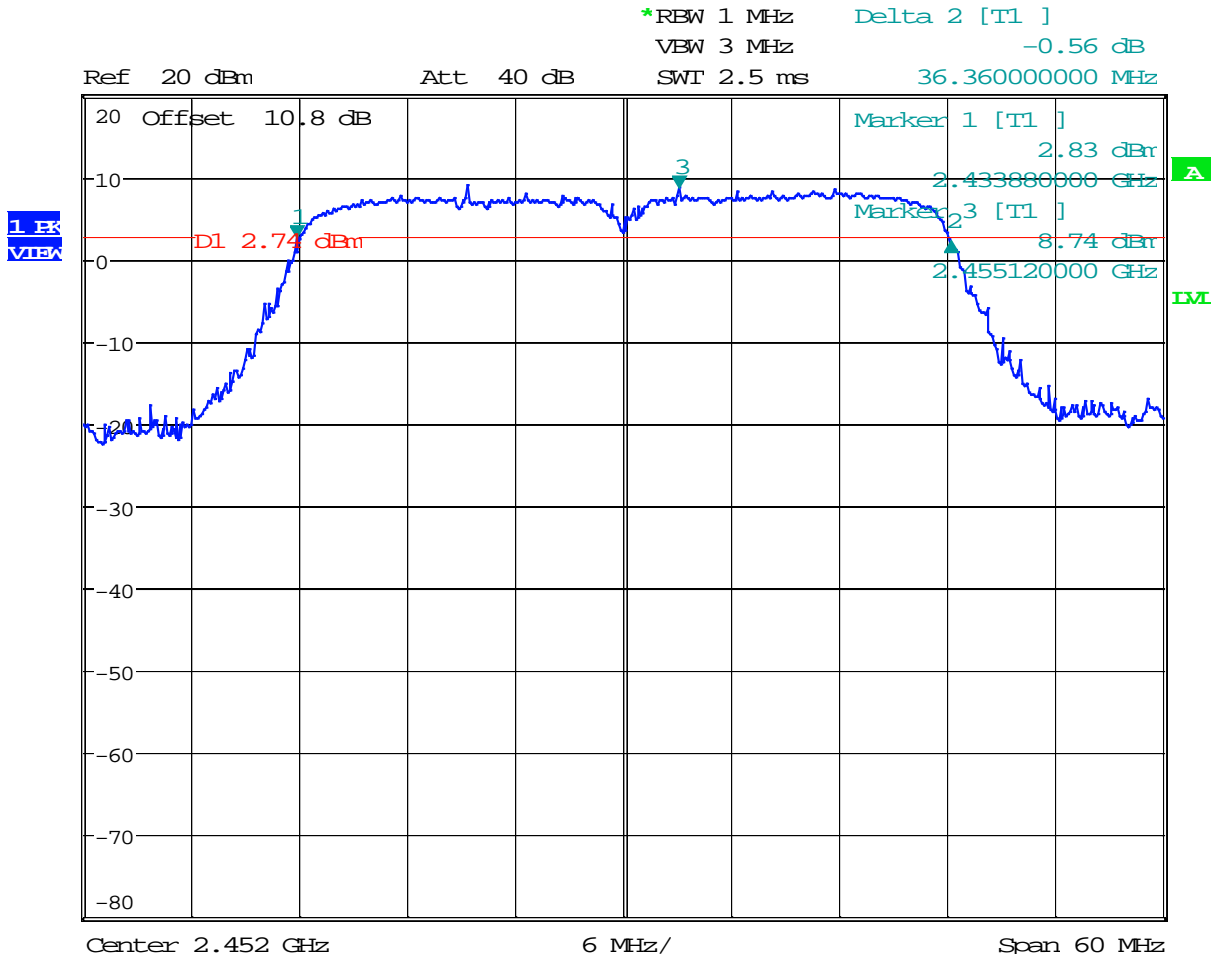

Date: 27.OCT.2015 14:34:39

## 4.2 Maximum Conducted Output Power at Antenna Terminals FCC Rule 15.247(b)(3)

### 4.2.1 Requirement

For antennas with gains of 6 dBi or less, maximum allowed transmitter output is 1 watt (+30 dBm). For antennas with gains greater than 6 dBi, transmitter output level must be decreased appropriately, by the amount in dB that the directional gain of the antenna exceeds 6 dBi.

### 4.2.2 Procedure

The antenna port of the EUT was connected to the input of a spectrum analyzer/power meter to measure the Maximum Conducted Transmitter Output Power.

The procedure described in FCC Publication 558074 D01 DTS Meas Guidance v03r03 June 09, 2015 was used. Specifically, section 9.2.2.2 Method AVGSA-1.

1. Set the RBW = 1-5% of the OBW, not to exceed 1MHz.
2. Set the VBW  $\geq 3 \times$  RBW
3. Set the span  $\geq 1.5 \times$  OBW.
4. Detector = RMS.
5. Sweep time = auto couple.
6. Trace mode = power averaging (100 traces)
7. Number of points in sweep  $\geq 2 \times$  span/RBW.
8. Use the instrument's band/channel power measurement function with the band limits set equal to the OBW band edges. If the instrument does not have a band power function, sum the spectrum levels at intervals equal to the RBW extending across the entire OBW of the spectrum.

### 4.3.3 Test Result

Refer to the following plots for the test result:

Standard	Data Rate	Channel	Frequency MHz	Conducted Average Power dBm	Conducted Average Power mW	Plot #
802.11b	1 Mbps	1	2412	17.92	61.94	2.1
		6	2437	17.84	60.81	2.2
		11	2462	17.58	57.28	2.3
802.11g	6 Mbps	1	2412	10.45	11.09	2.4
		2	2417	13.45	22.13	2.5
		3	2422	16.86	48.53	2.6
		4	2427	16.99	50.00	2.7
		5	2432	17.12	51.52	2.8
		6	2437	17.05	50.70	2.9
		7	2442	17.18	52.24	2.10
		8	2447	16.49	44.57	2.11
		9	2452	15.58	36.14	2.12
		10	2457	13.63	23.07	2.13
		11	2462	9.64	9.20	2.14
802.11n 20MHz	6.5 Mbps	1	2412	10.46	11.12	2.15
		2	2417	13.48	22.28	2.16
		3	2422	16.70	46.77	2.17
		4	2427	17.61	57.68	2.18
		5	2432	17.72	59.16	2.19
		6	2437	17.83	60.67	2.20
		7	2442	17.38	54.70	2.21
		8	2447	16.51	44.77	2.22
		9	2452	15.61	36.39	2.23
		10	2457	13.66	23.23	2.24
		11	2462	9.51	8.93	2.25
802.11n 40MHz	13.5 Mbps	3	2422	9.42	8.75	2.26
		4	2427	9.58	9.08	2.27
		5	2432	11.63	14.55	2.28
		6	2437	11.78	15.07	2.29
		7	2442	11.93	15.60	2.30
		8	2447	10.16	10.38	2.31
		9	2452	9.79	9.53	2.32



Plot 2. 1

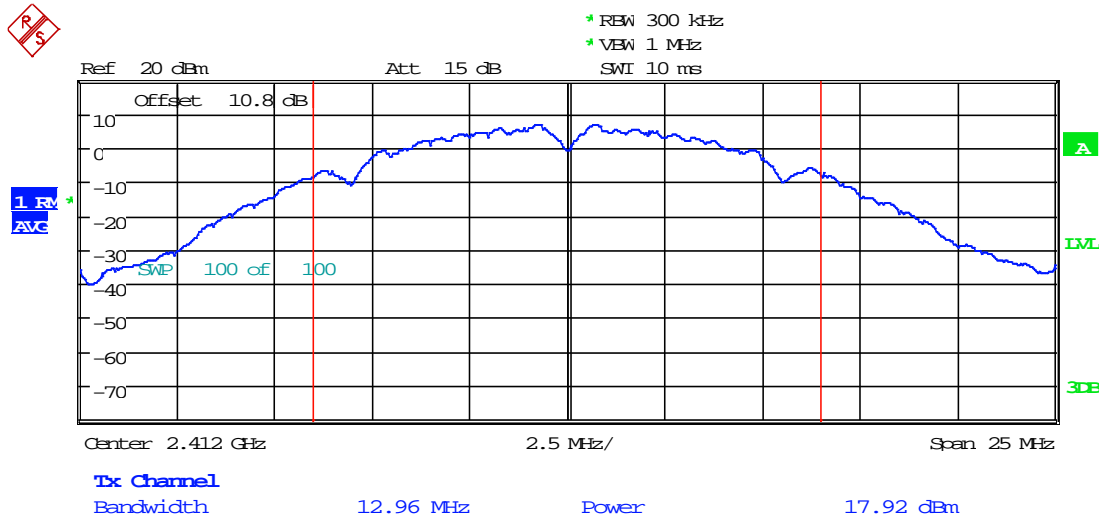

Plot 2. 2

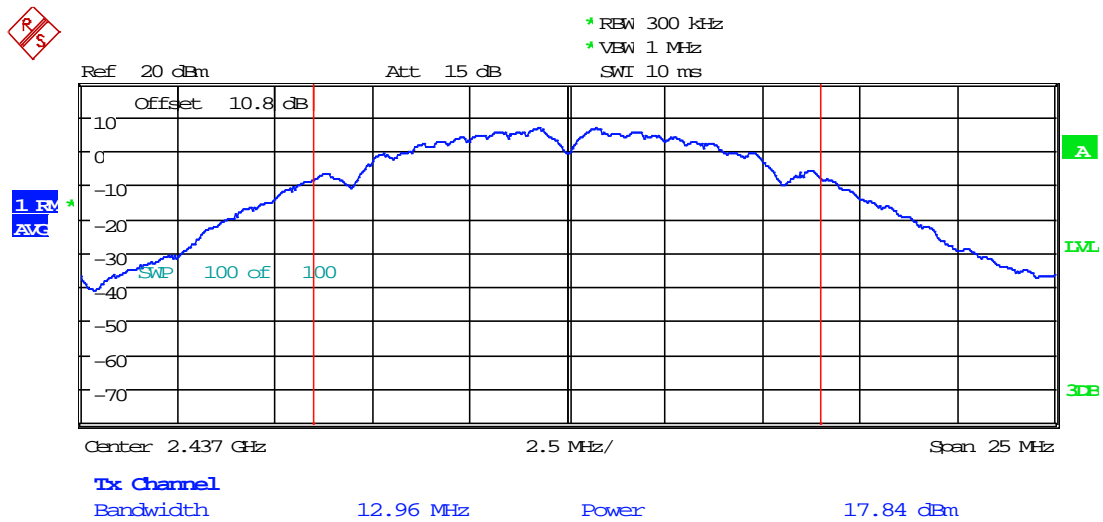

Plot 2.3

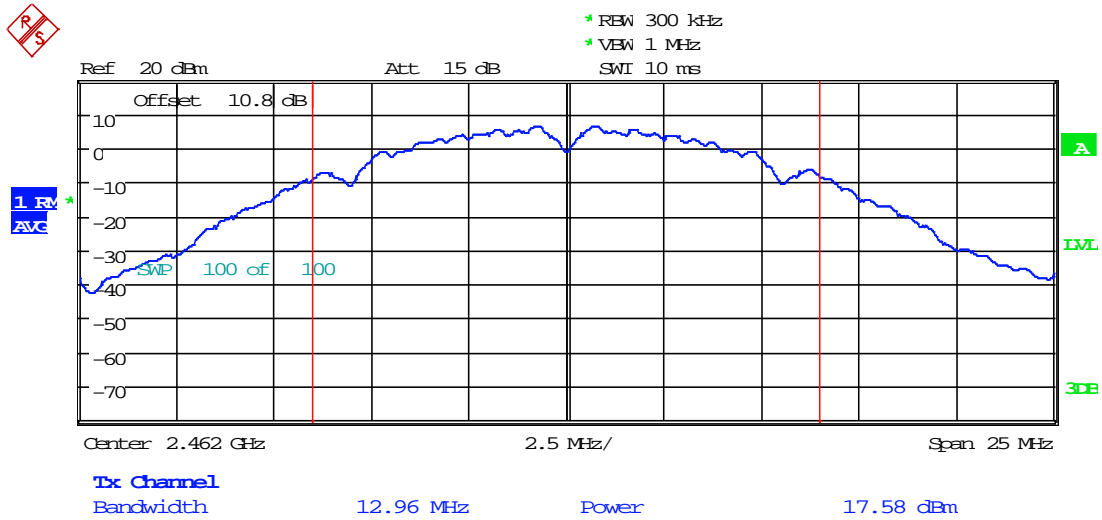

Plot 2.4

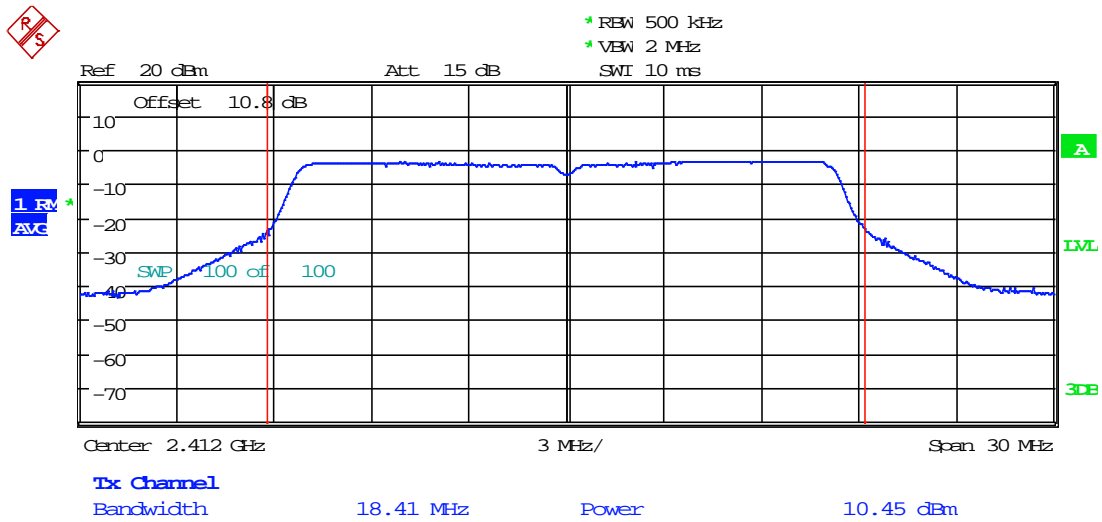

Plot 2.5

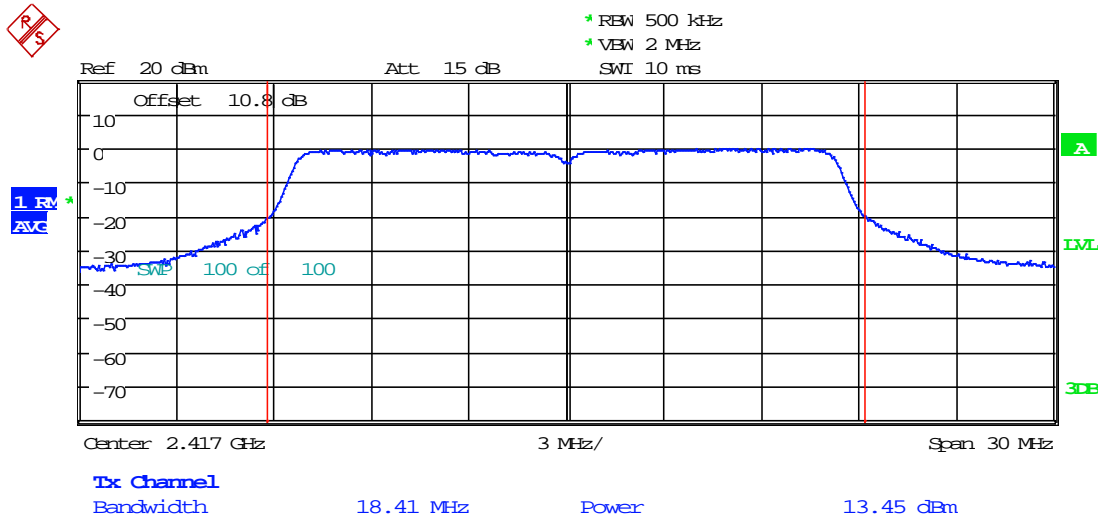

Plot 2.6

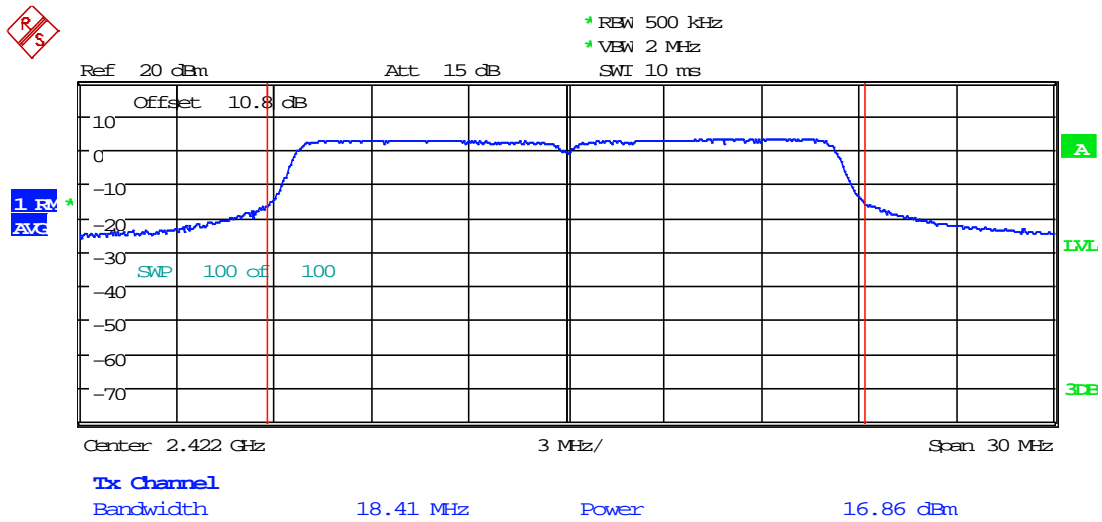

Plot 2.7

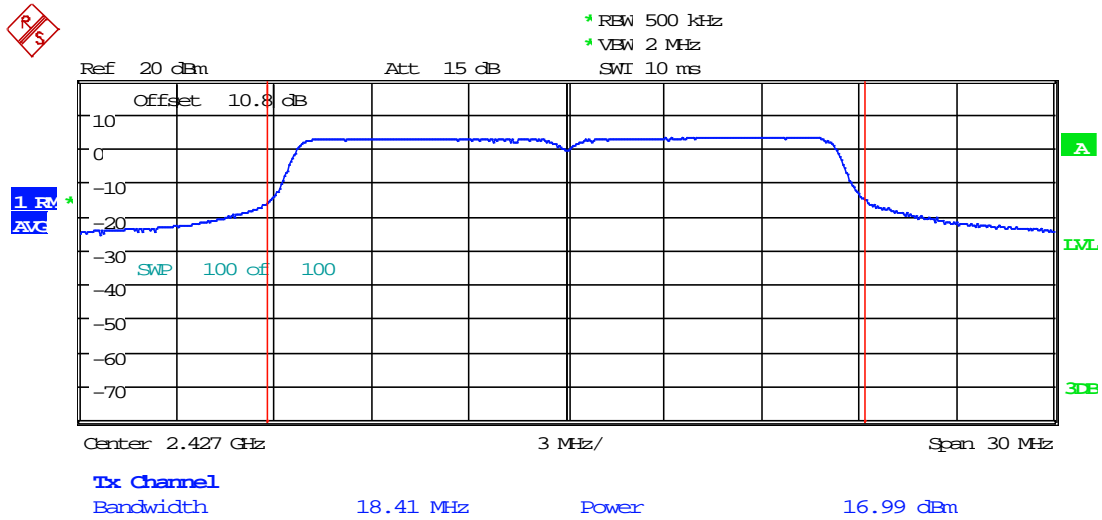

Plot 2.8

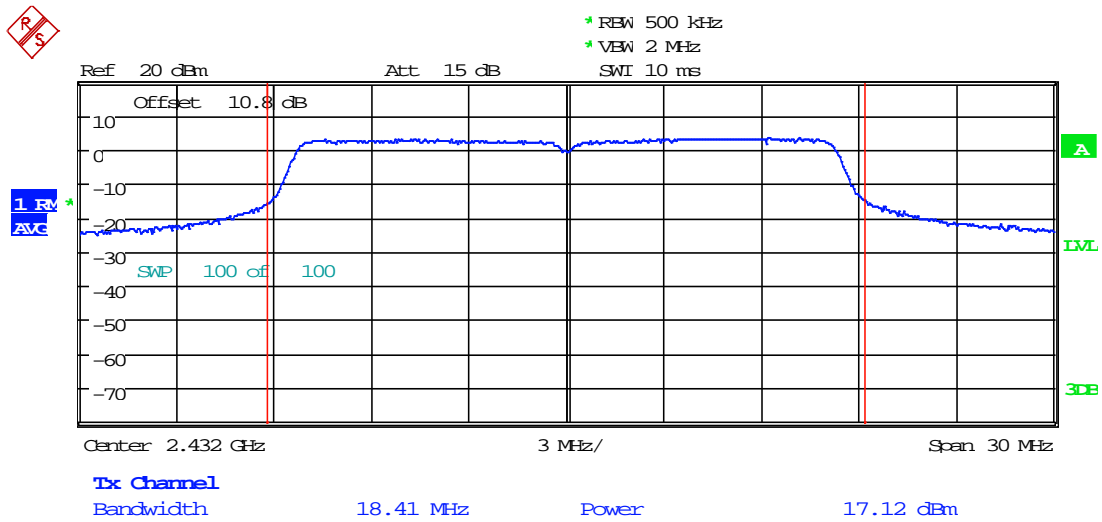

Plot 2.9

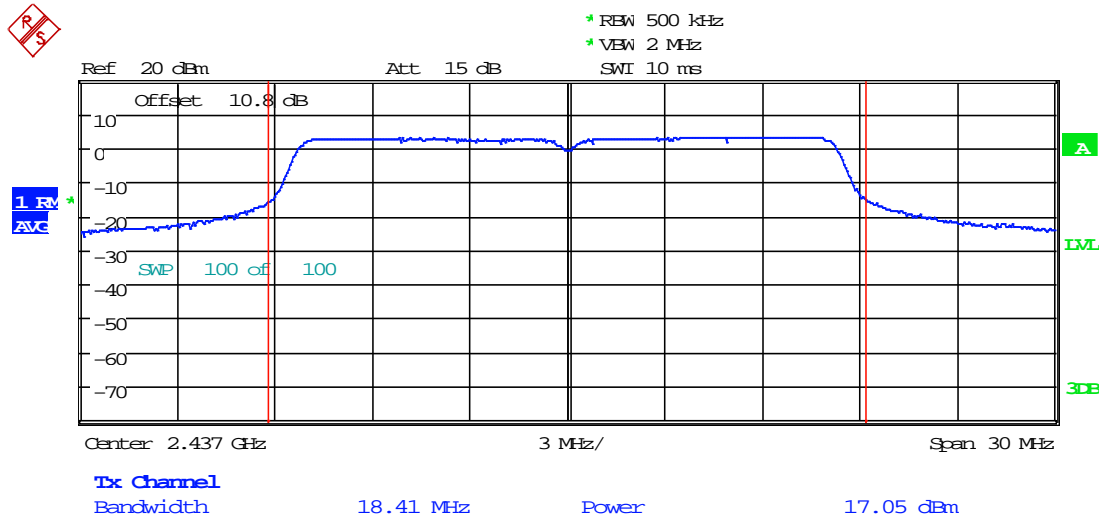

Plot 2.10

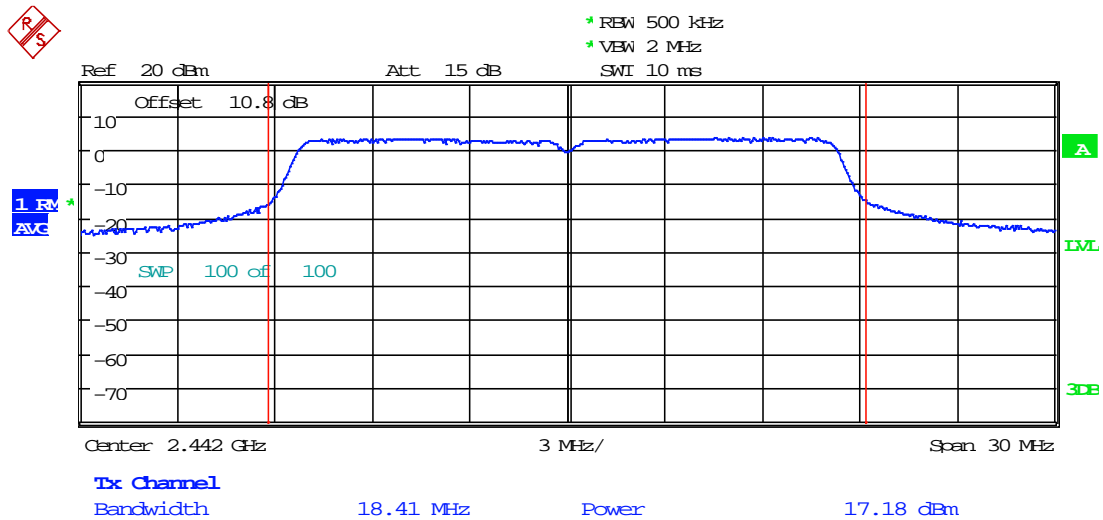

Plot 2. 11

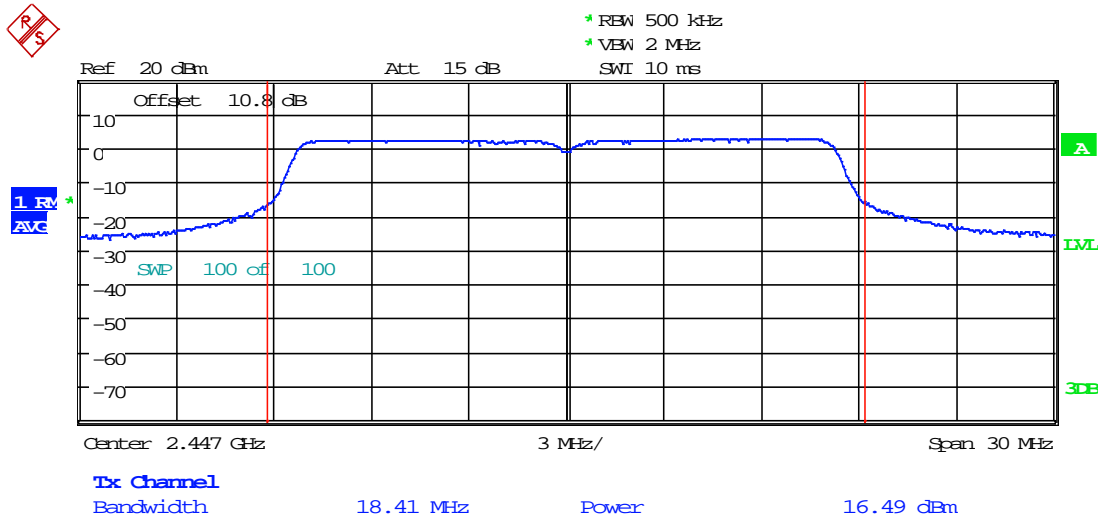

Plot 2. 12

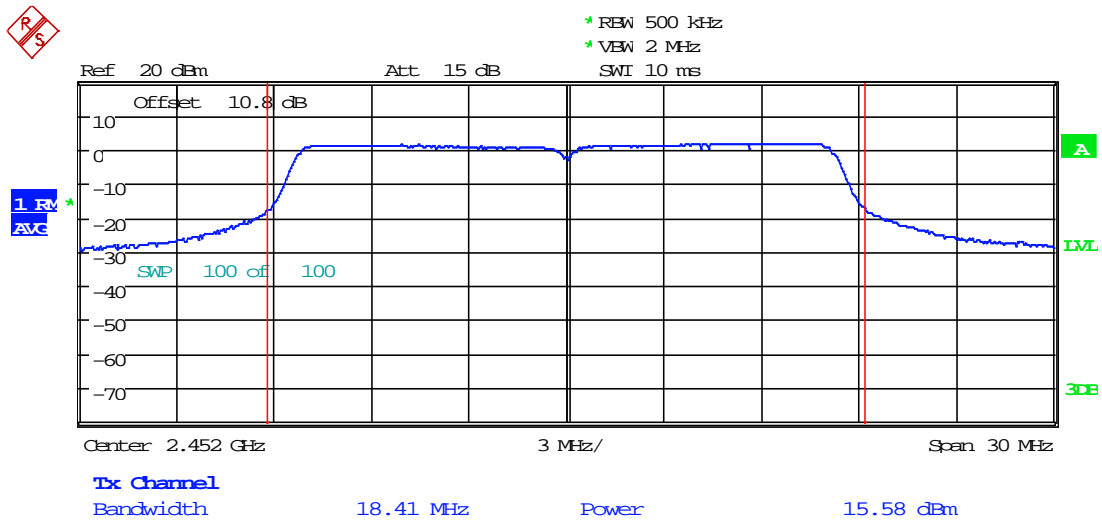

Plot 2. 13

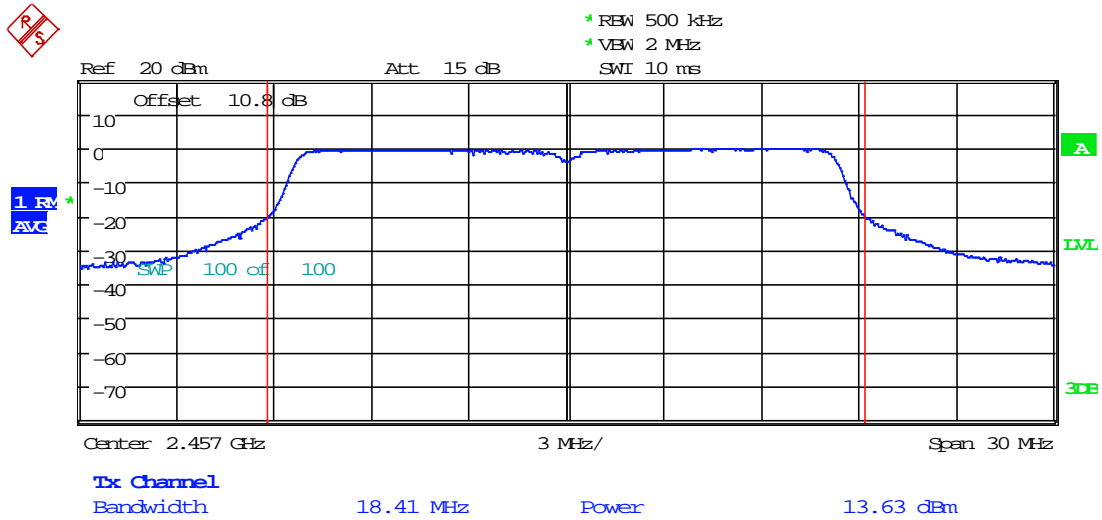

Plot 2. 14

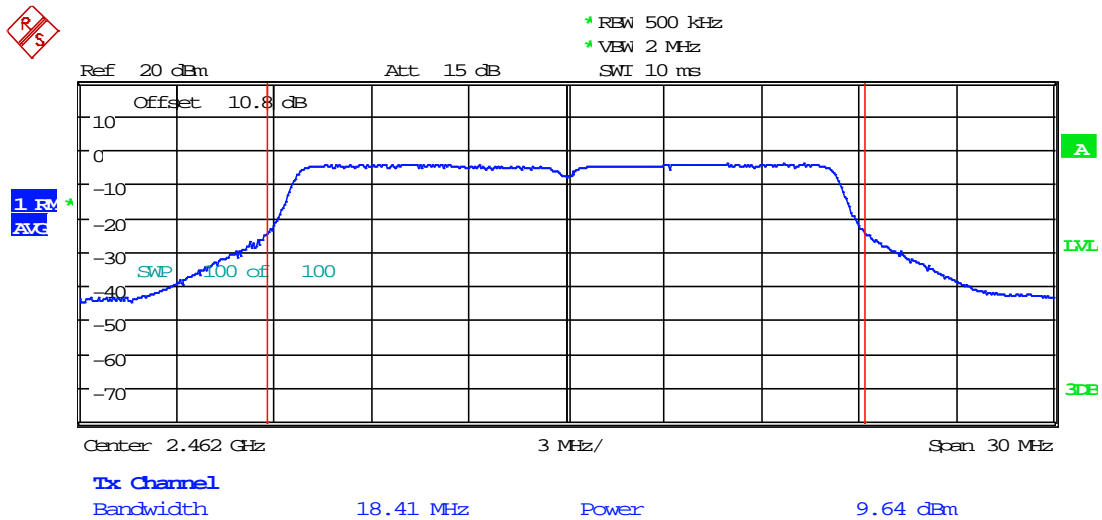

Plot 2. 15

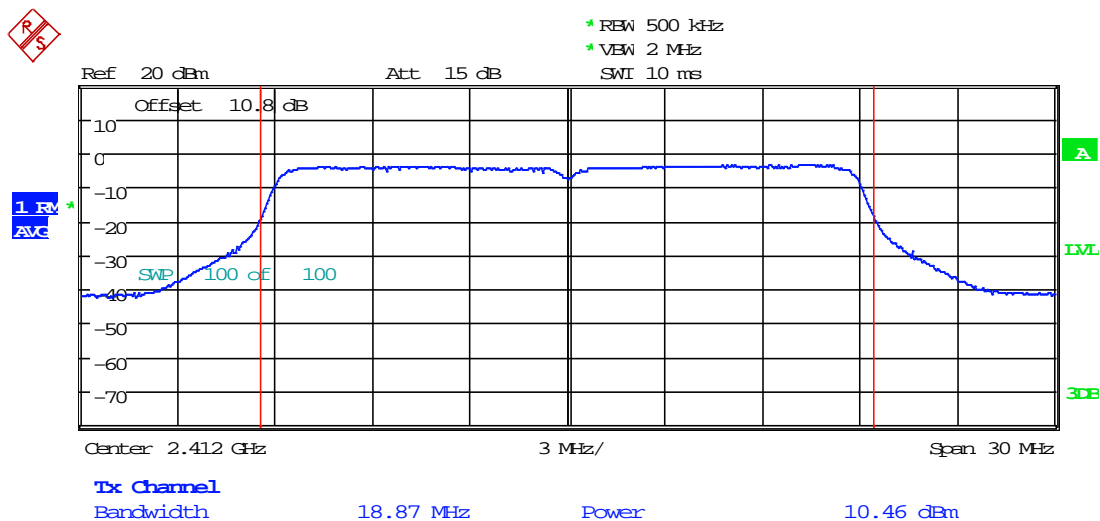

Plot 2. 16

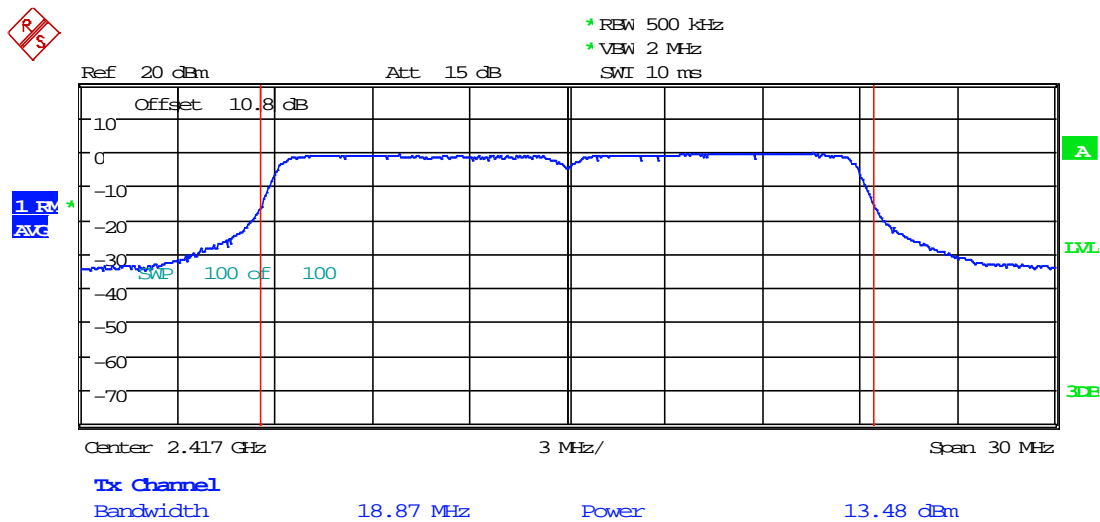



Plot 2. 17

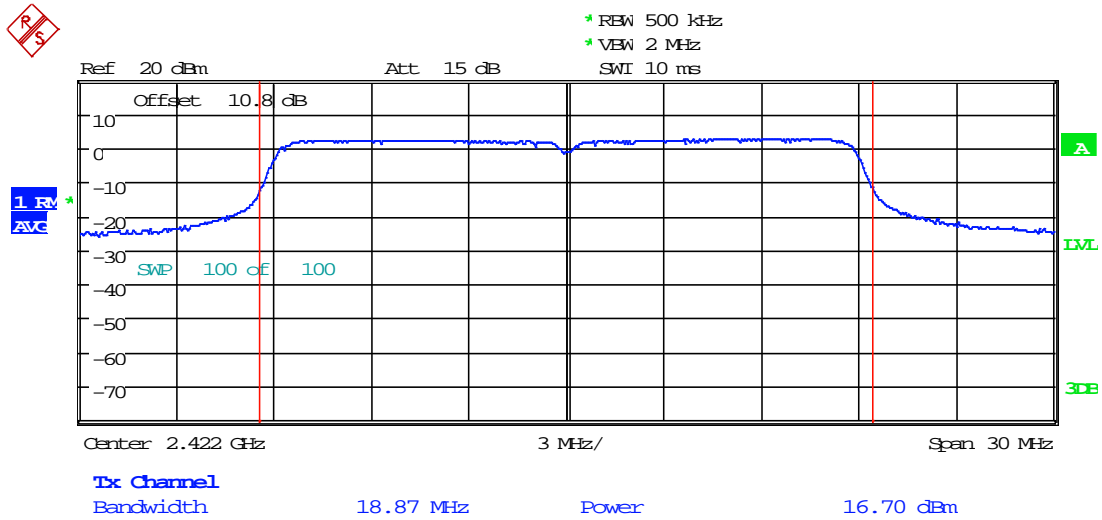

Plot 2. 18

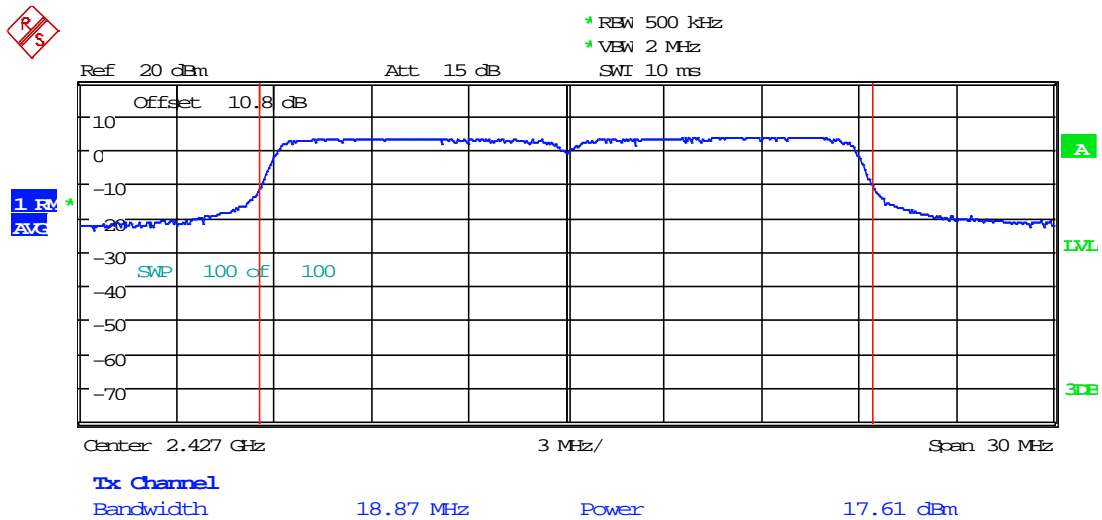

Plot 2. 19

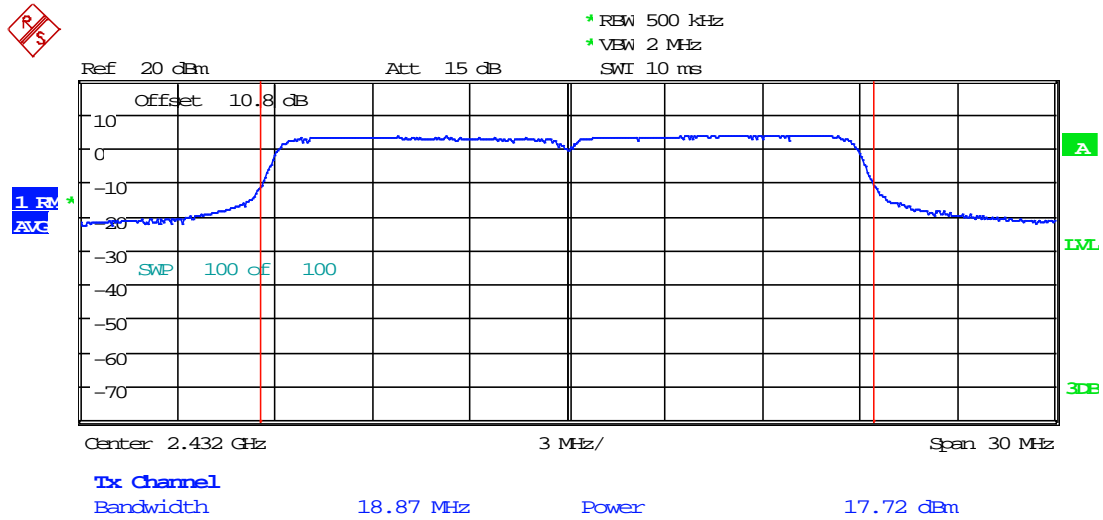

Plot 2. 20

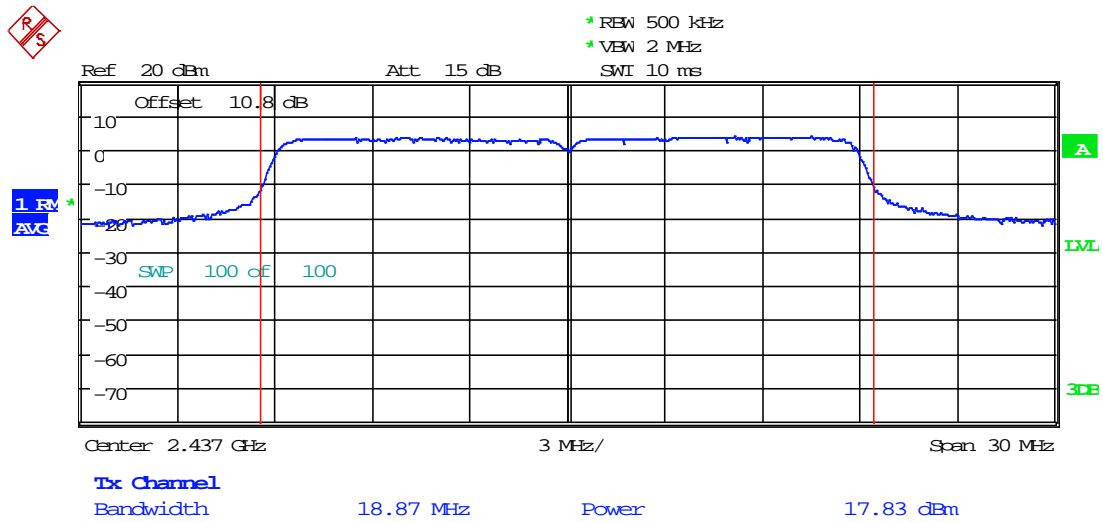

Plot 2.21

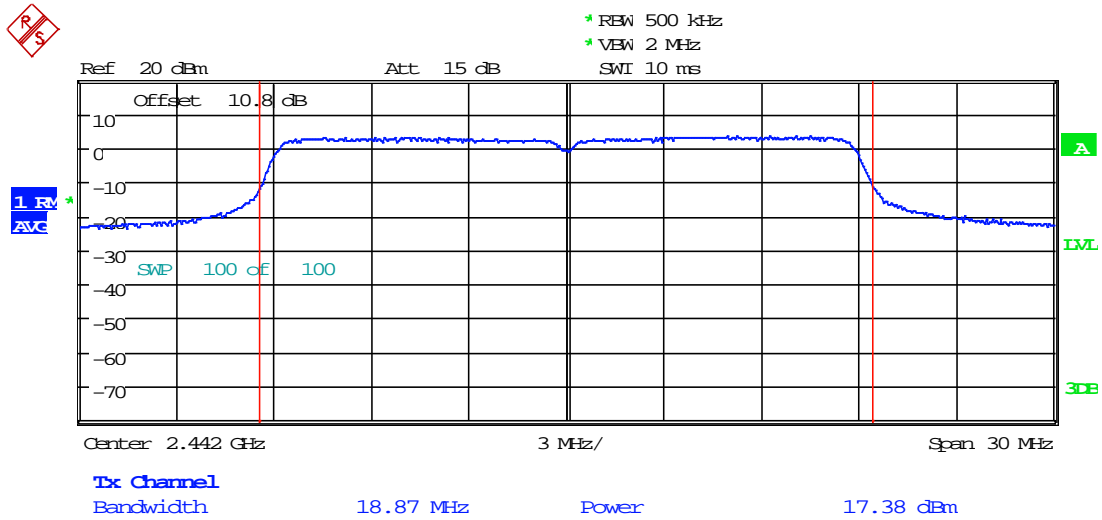

Plot 2.22

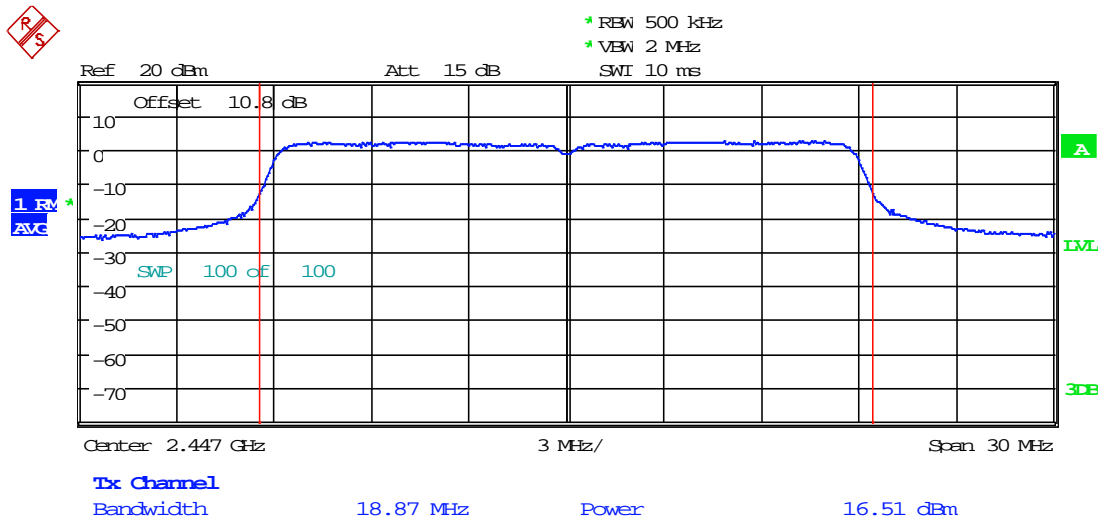

Plot 2. 23

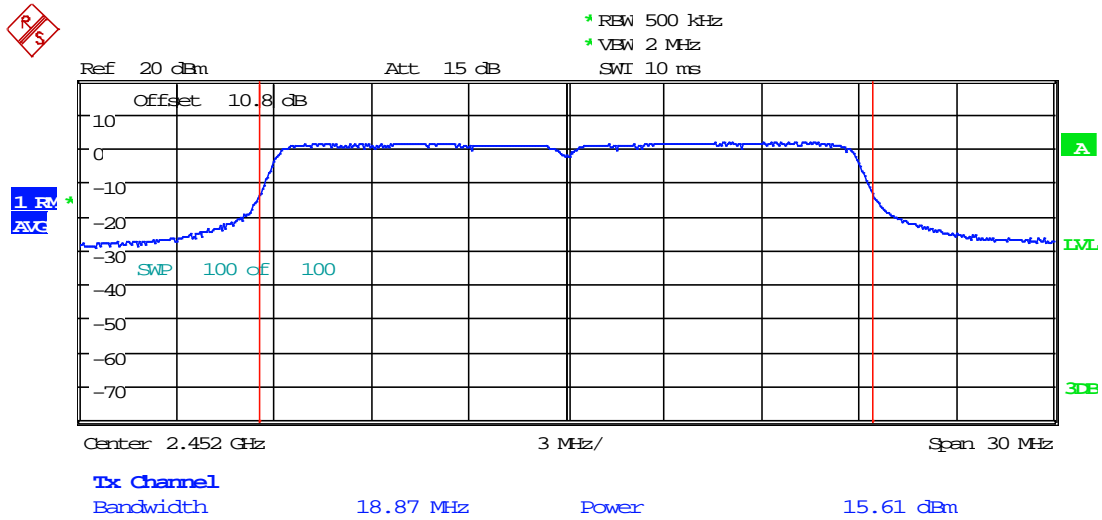

Plot 2. 24

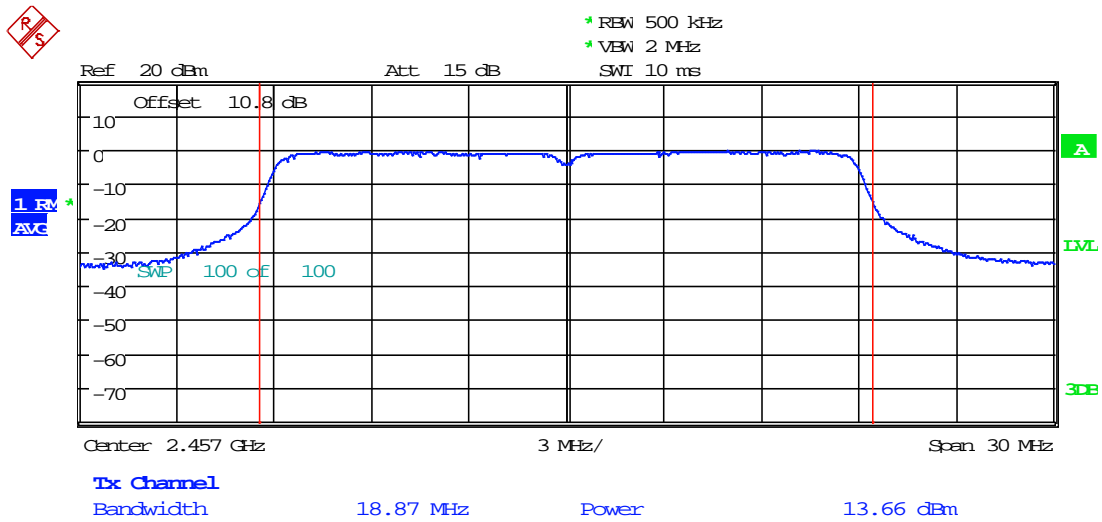

Plot 2. 25

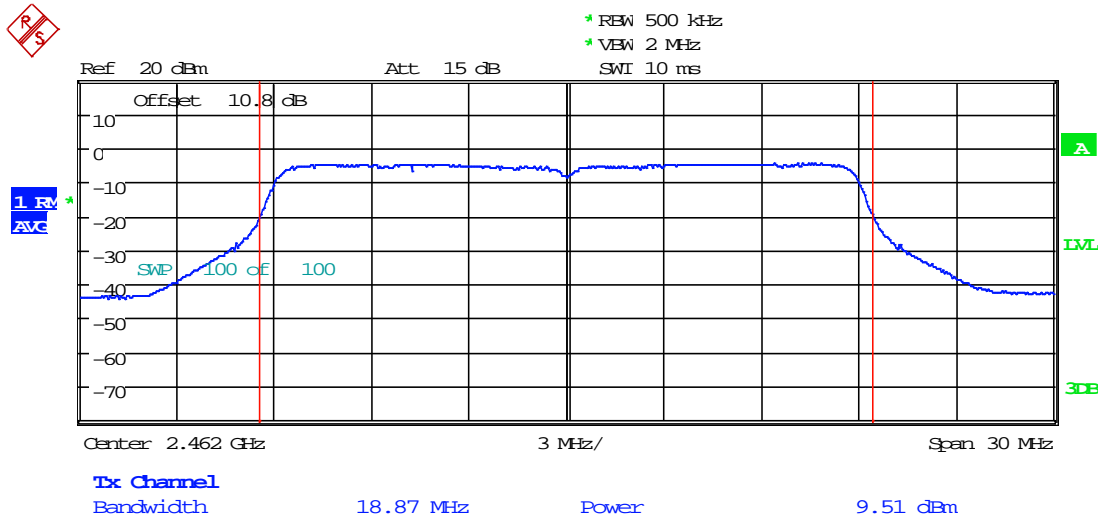

Plot 2. 26

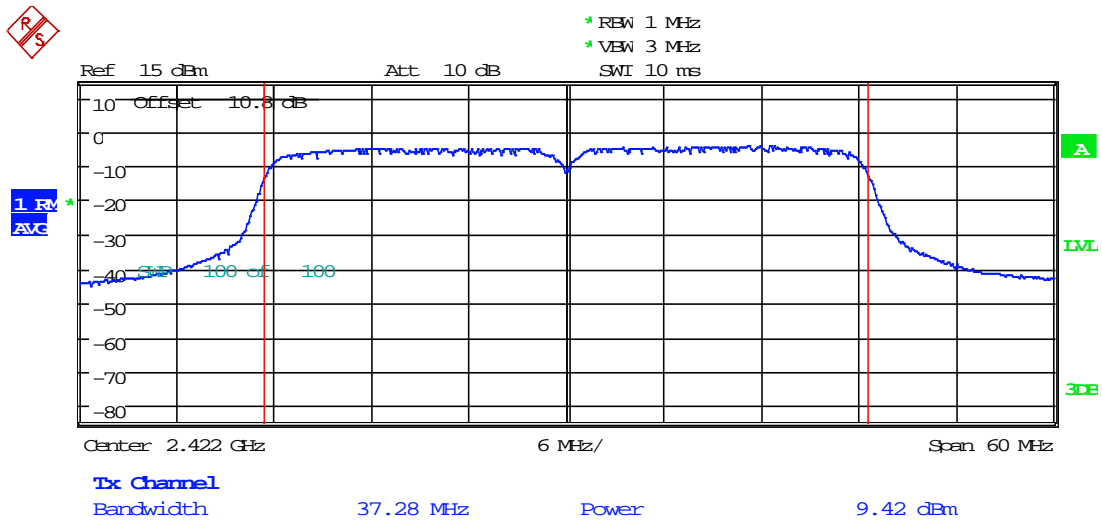

Plot 2. 27

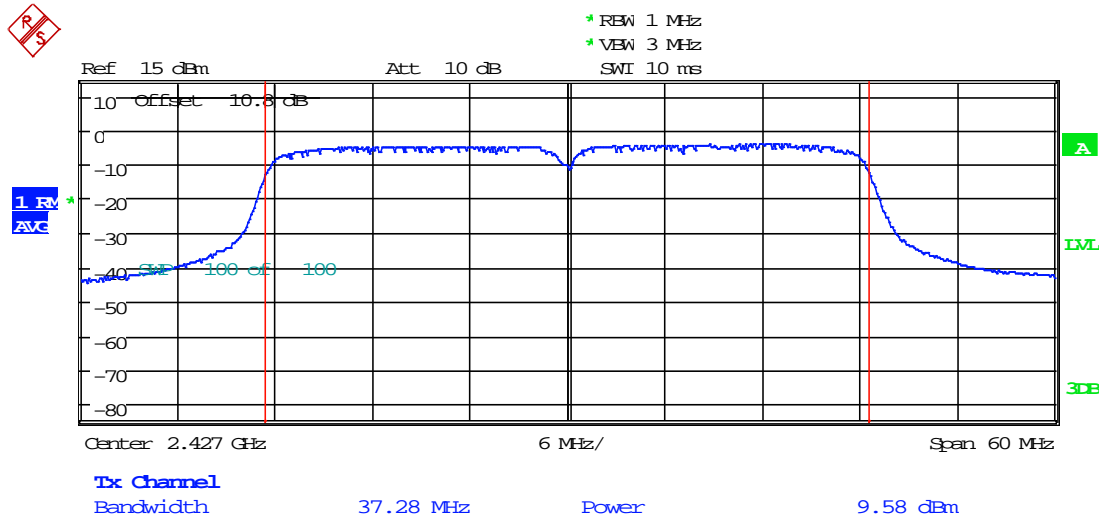

Plot 2. 28

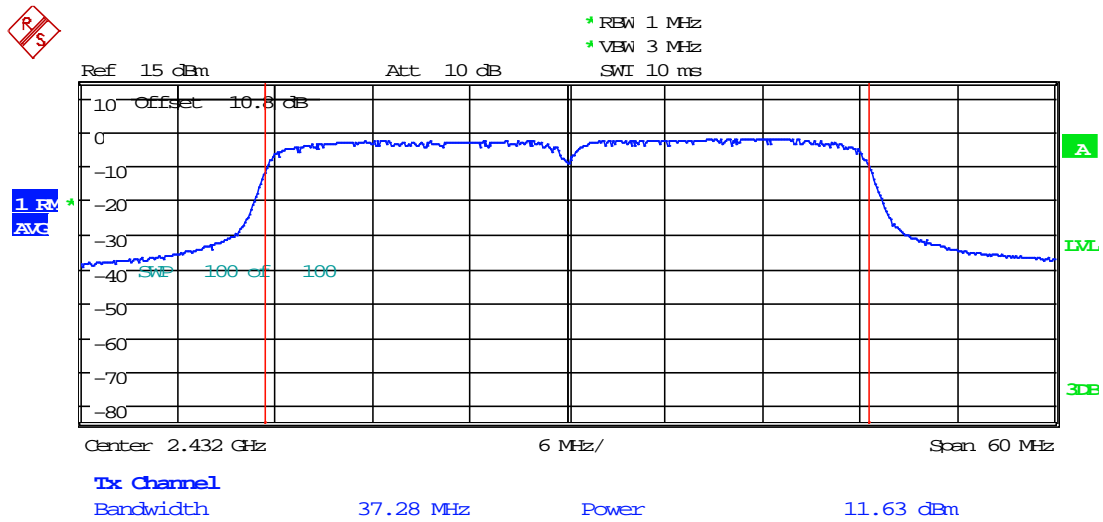

Plot 2. 29

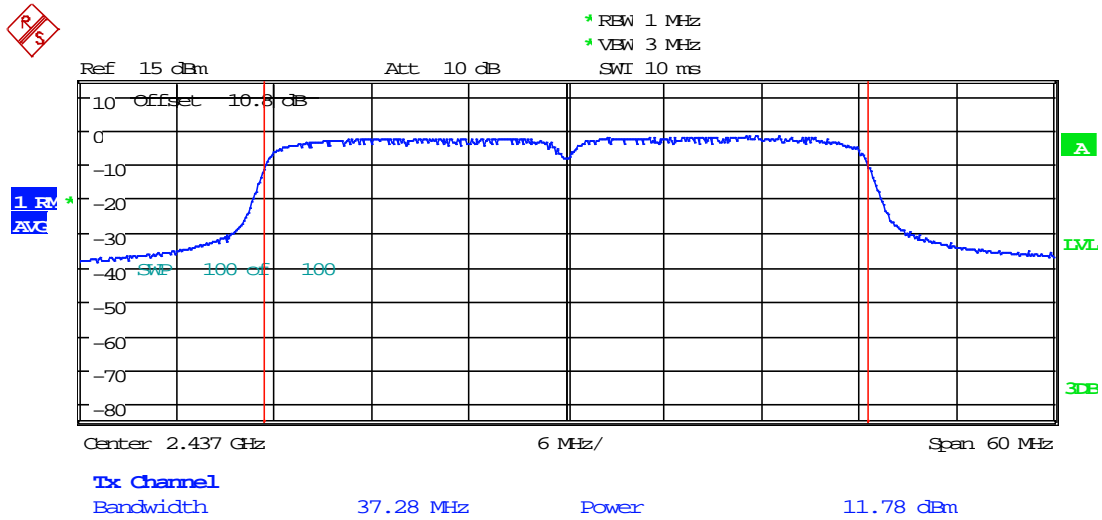

Plot 2. 30

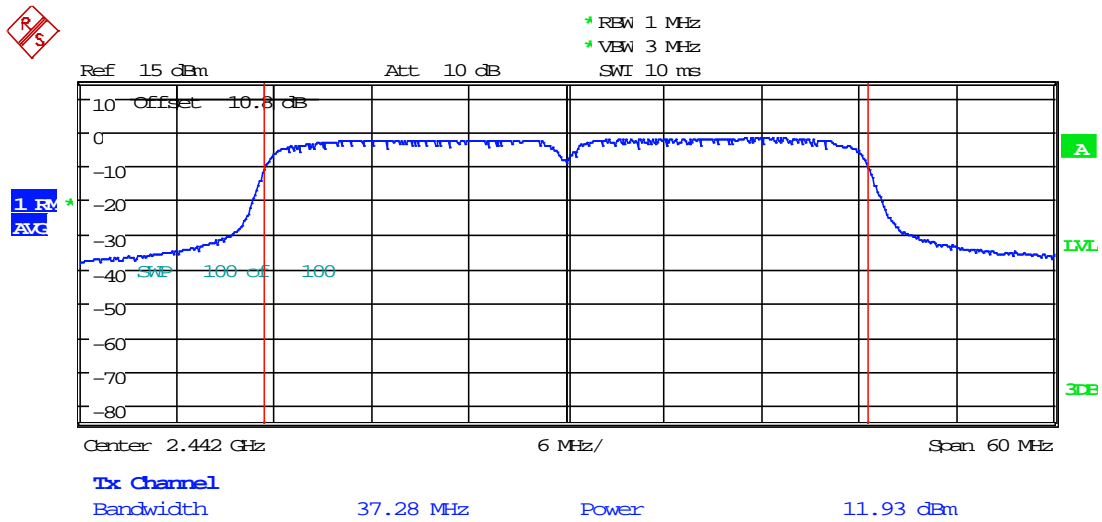

Plot 2. 31

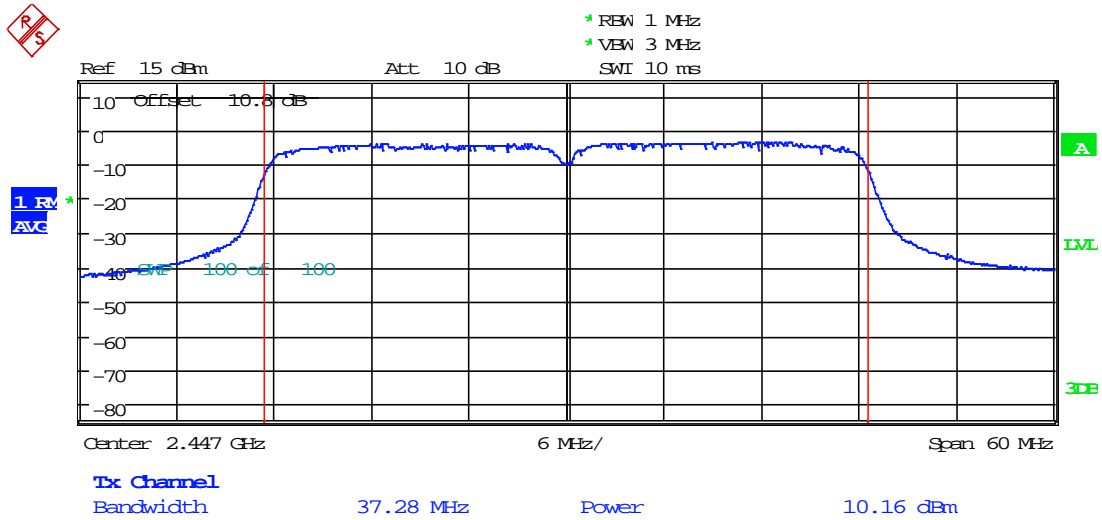

Plot 2. 32

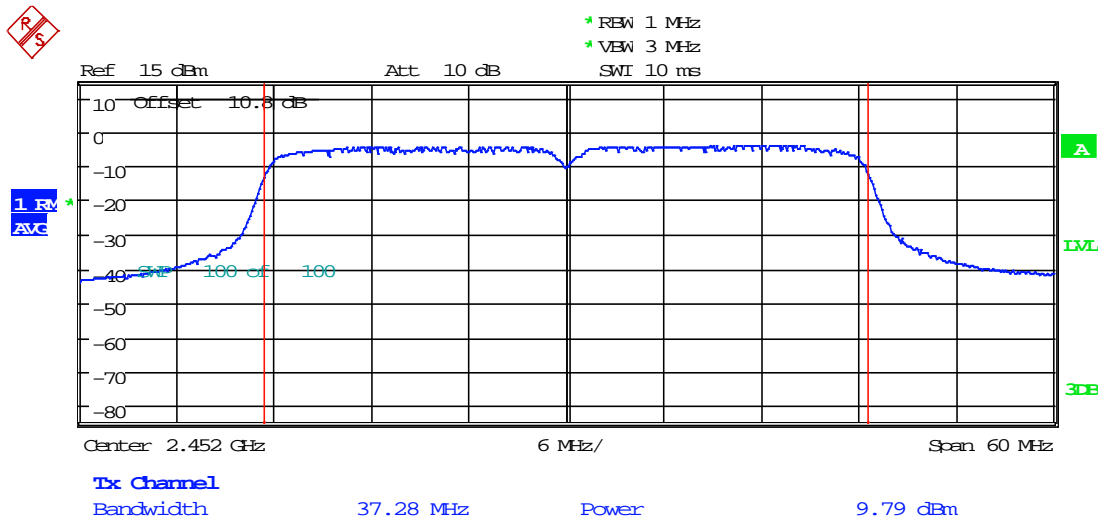



#### 4.3 Power Spectral Density FCC 15.247 (e)

##### 4.3.1 Requirement

For digitally modulated systems, the power spectral density conducted from the intentional radiator to the antenna should not be greater than 8dBm in any 3 kHz band during any time interval of continuous transmission.

##### 4.3.2 Procedure

The antenna port of the EUT was connected to the input of a spectrum analyzer to measure the Transmitter Power Density (PSD).

The procedure described in FCC Publication 558074 D01 DTS Meas Guidance v03r03 June 09 2015, specifically section 10.2 Method PKPSD (peak PSD).

1. Set analyzer center frequency to DTS channel center frequency.
2. Set the span to 1.5 times the *DTS bandwidth*.
3. Set the RBW to:  $3 \text{ kHz} \leq \text{RBW} \leq 100 \text{ kHz}$ .
4. Set the VBW  $\geq 3 \times \text{RBW}$ .
5. Detector = peak.
6. Sweep time = auto couple.
7. Trace mode = max hold.
8. Allow trace to fully stabilize.
9. Use the peak marker function to determine the maximum amplitude level within the RBW.
10. If measured value exceeds limit, reduce RBW (no less than 3 kHz) and repeat.

### 4.3.3 Test Result

Refer to the following plots for the test result:

Standard	Channel	Frequency MHz	PSD (Peak) dBm	Margin to -8dBm Limit dB	Plot #
802.11b	1	2412	5.01	-2.99	3.1
	6	2437	5.23	-2.77	3.2
	11	2462	5.23	-2.77	3.3
802.11g	1	2412	2.27	-5.73	3.4
	6	2437	2.42	-5.58	3.5
	11	2462	2.27	-5.73	3.6
802.11n 20MHz	1	2412	1.84	-6.16	3.7
	6	2437	2.19	-5.81	3.7
	11	2462	2.22	-5.78	3.9
802.11n 40MHz	3	2422	-6.38	-14.38	3.10
	6	2437	-5.43	-13.43	3.11
	9	2452	-5.47	-13.47	3.12

Plot 3.1

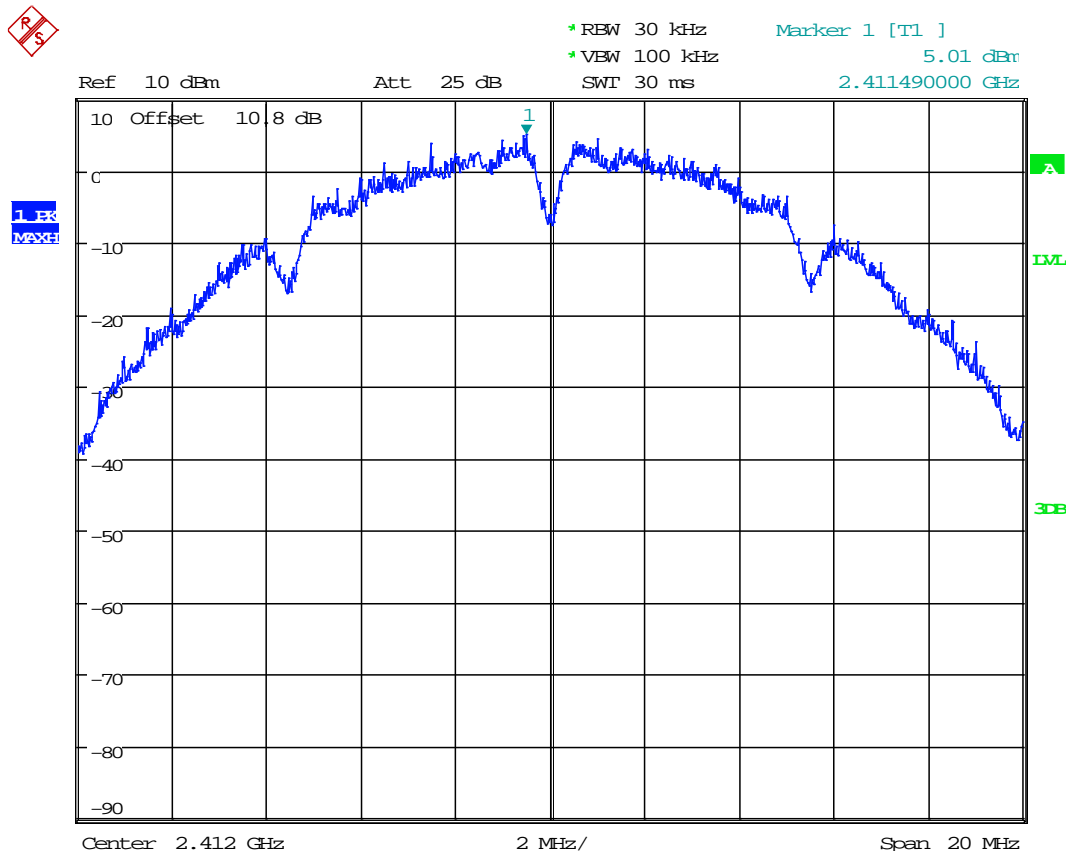

Date: 19.OCT.2015 08:48:04

Plot 3.2

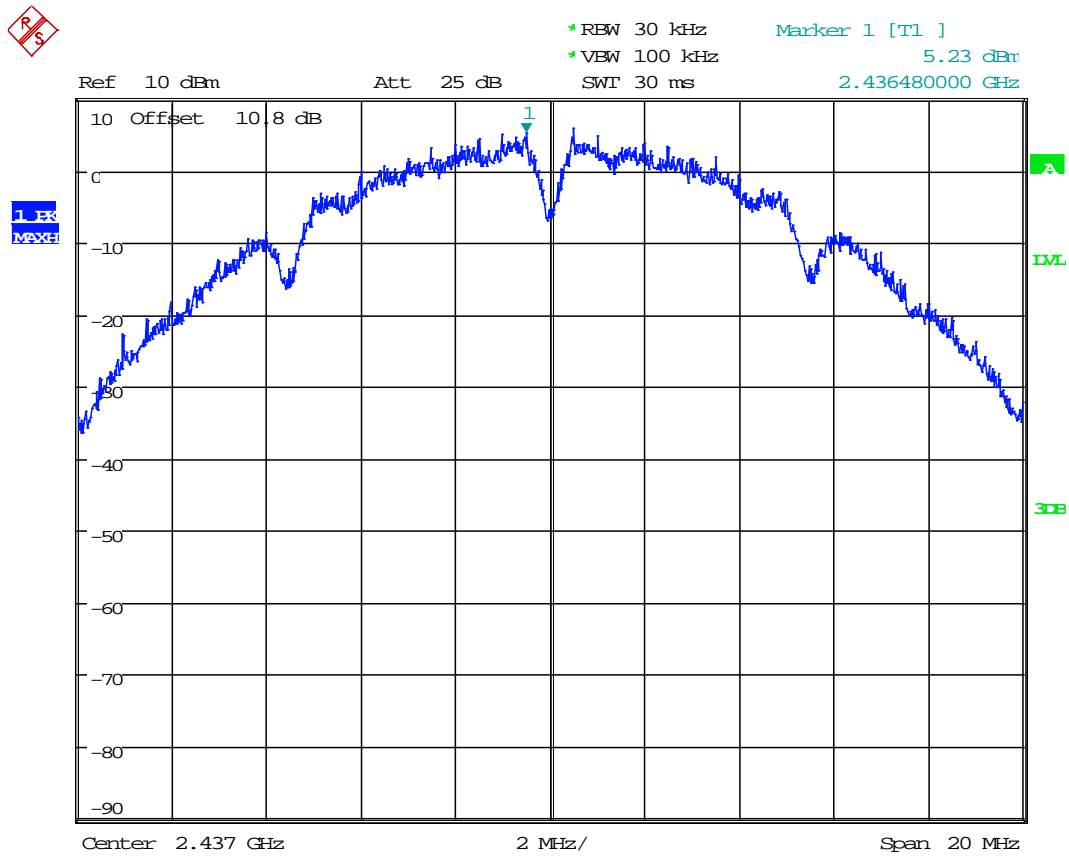

Date: 19.OCT.2015 08:49:09

Plot 3.3

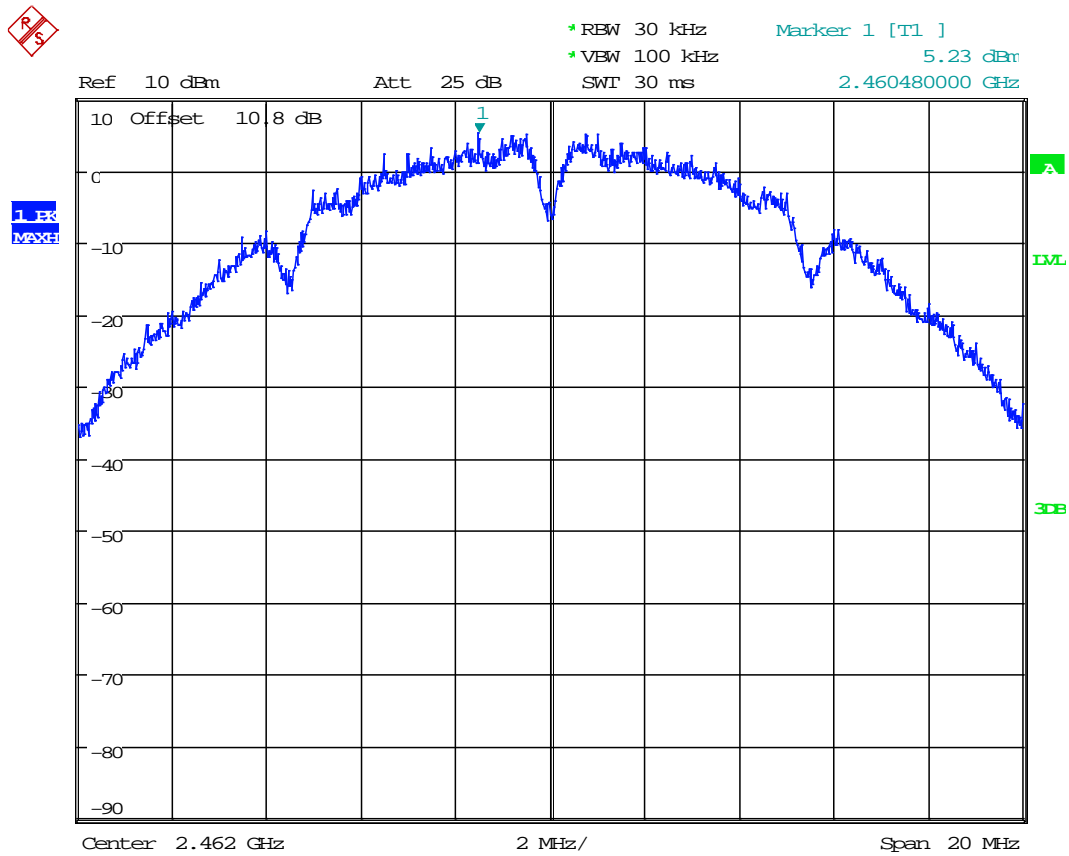

Date: 19.OCT.2015 08:50:10

Plot 3.4

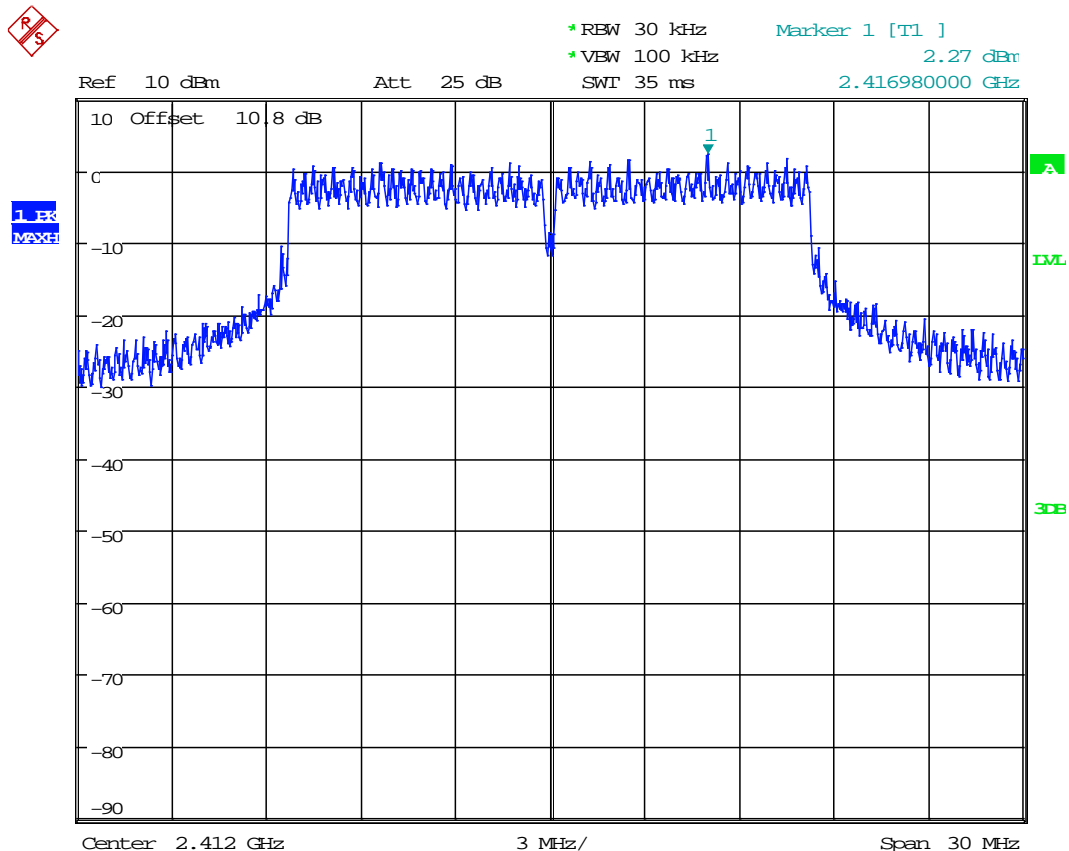

Date: 19.OCT.2015 08:54:06

Plot 3.5

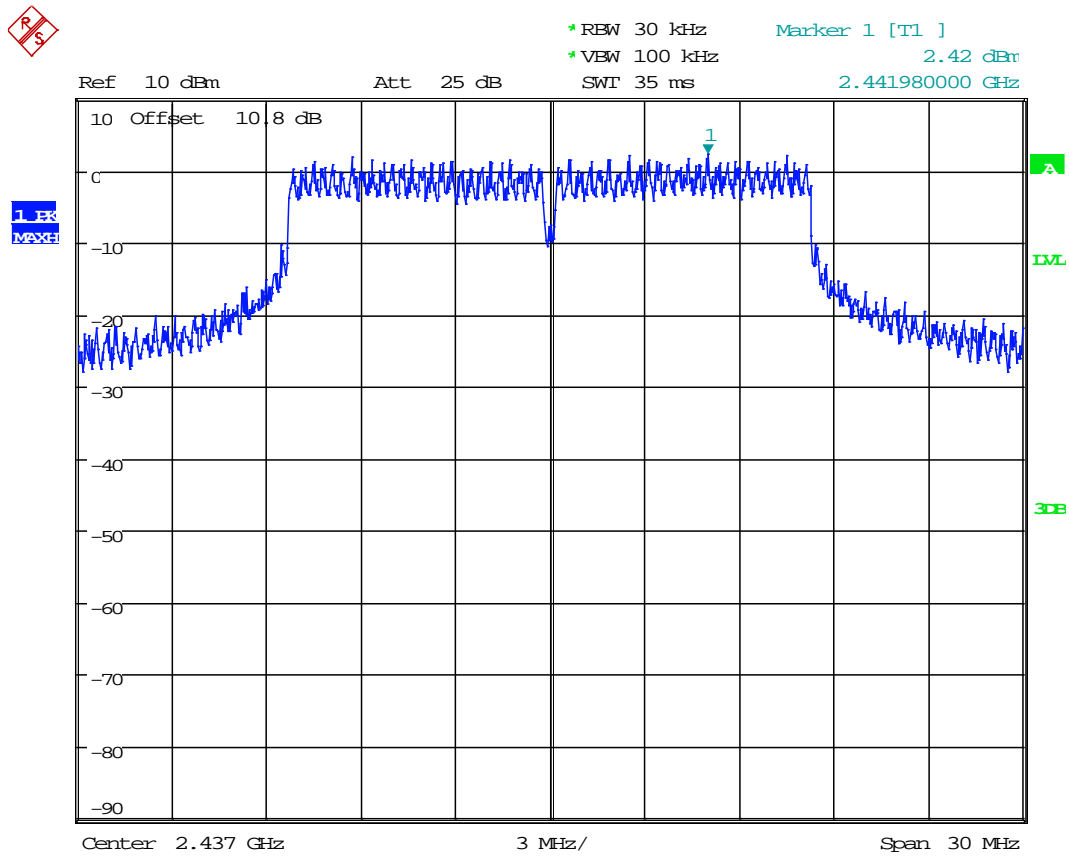

Date: 19.OCT.2015 08:53:11

Plot 3.6

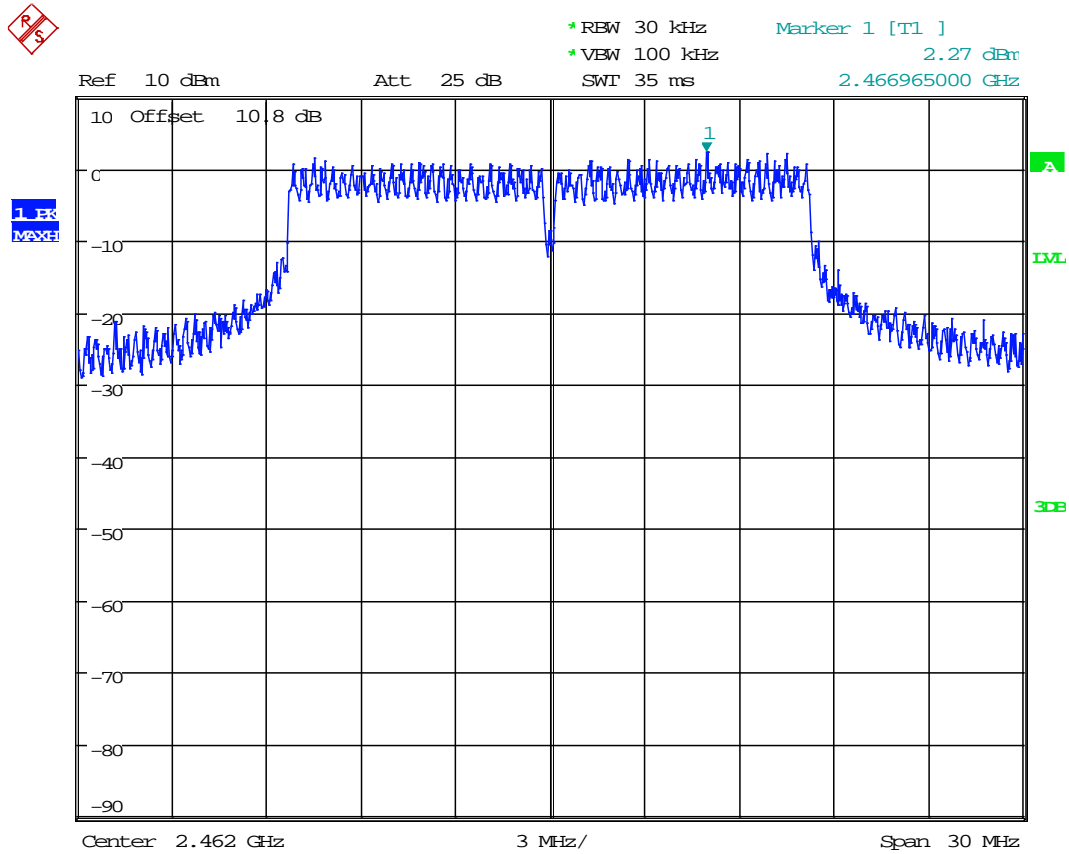

Date: 19.OCT.2015 08:52:04



Plot 3.7

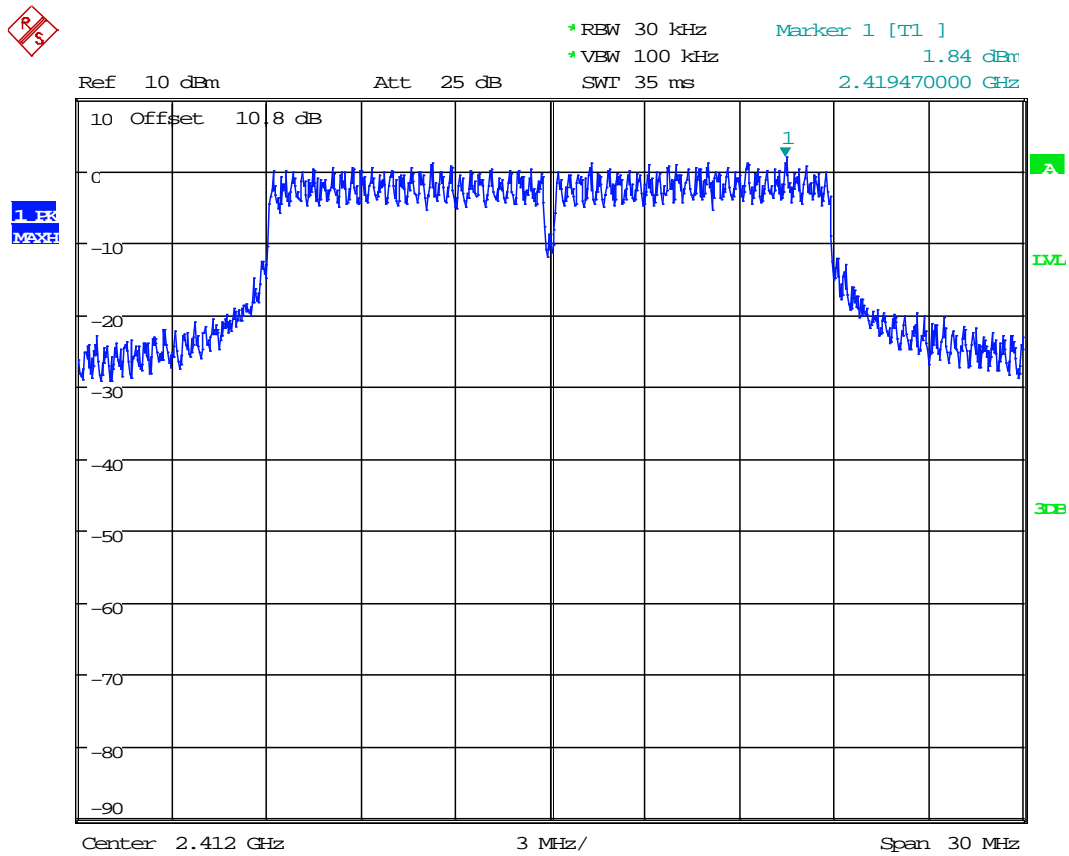

Date: 19.OCT.2015 08:55:12

Plot 3.8

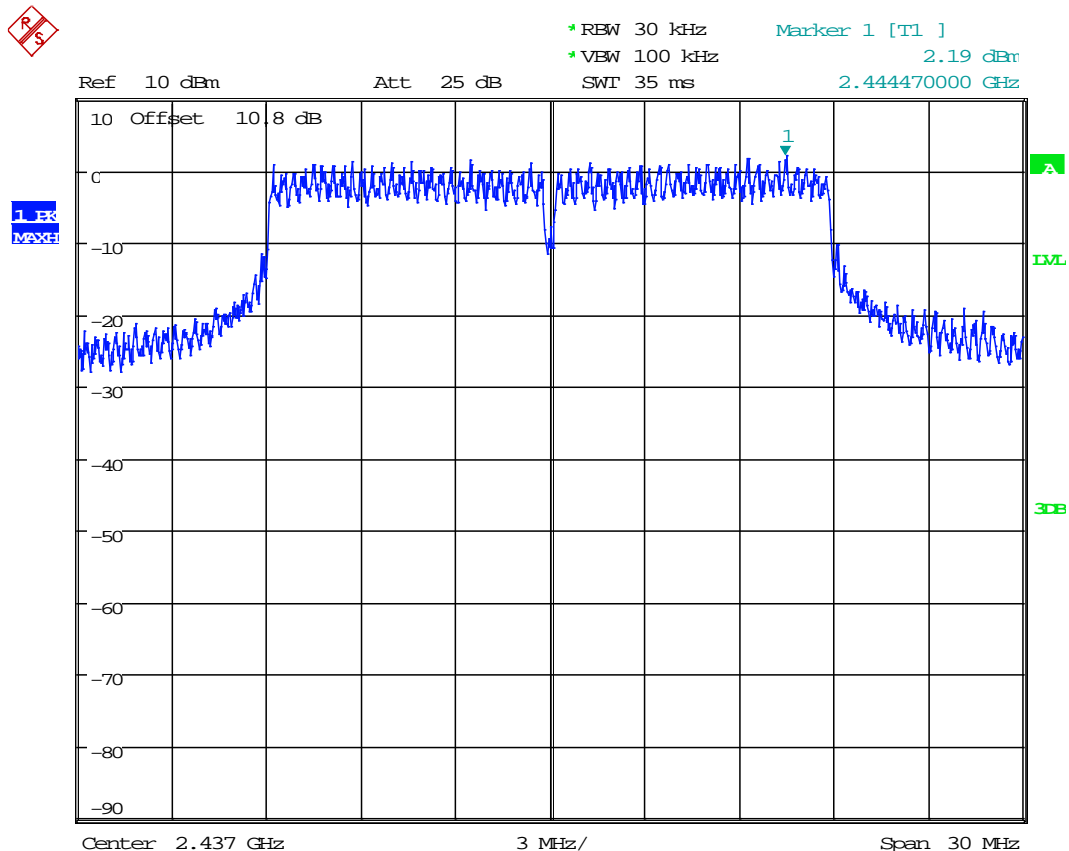

Date: 19.OCT.2015 08:56:10

Plot 3.9

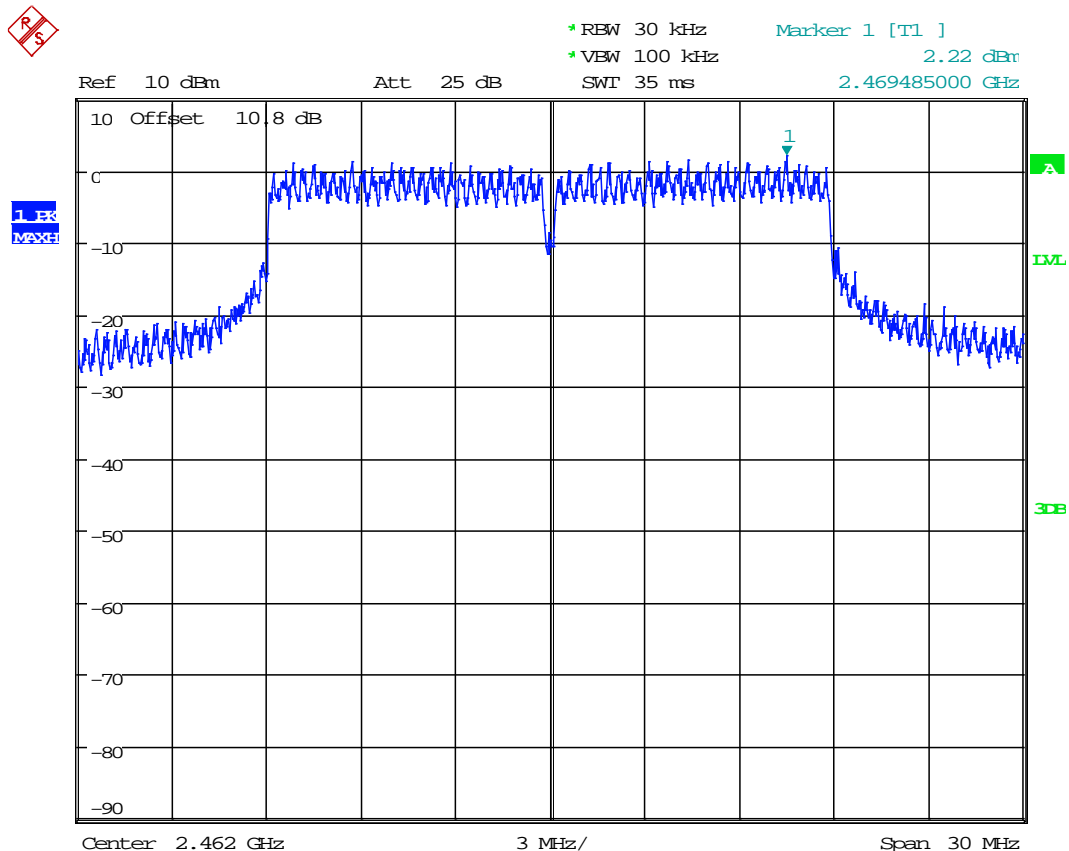

Date: 19.OCT.2015 08:57:06

Plot 3.10

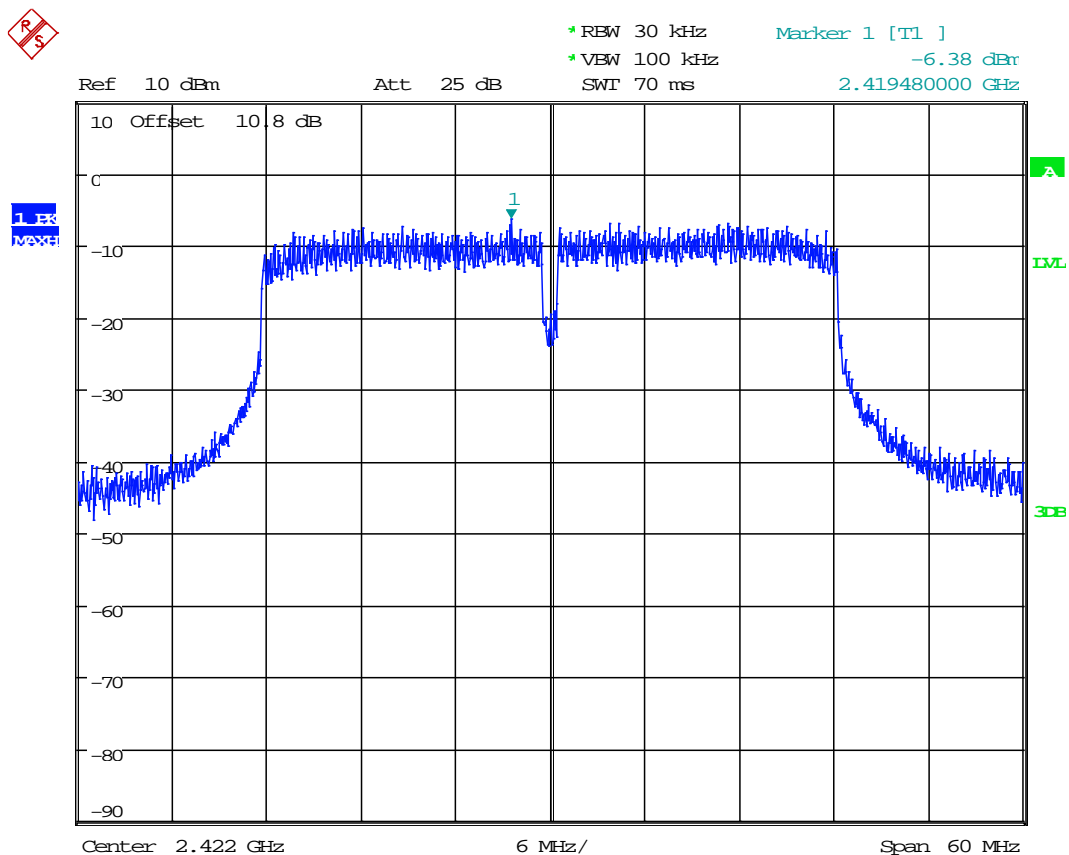

Date: 19.OCT.2015 08:45:53

Plot 3.11

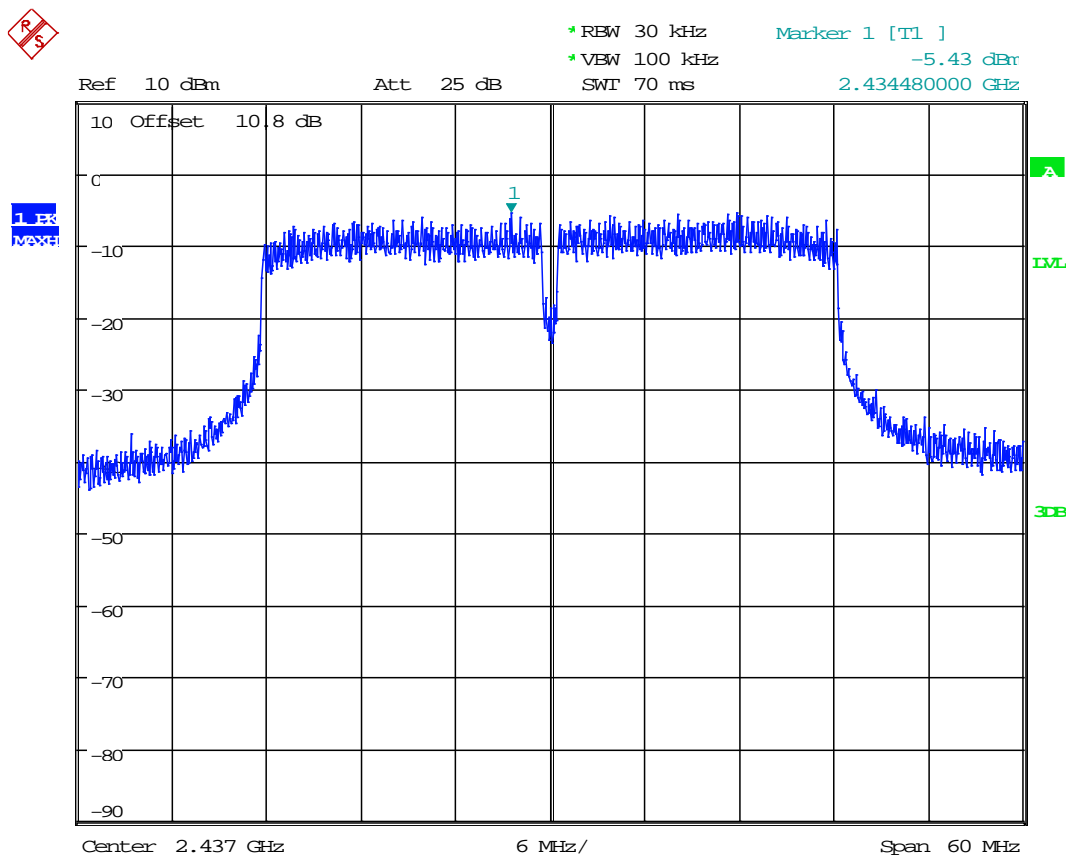

Date: 19.OCT.2015 08:43:56

Plot 3.12

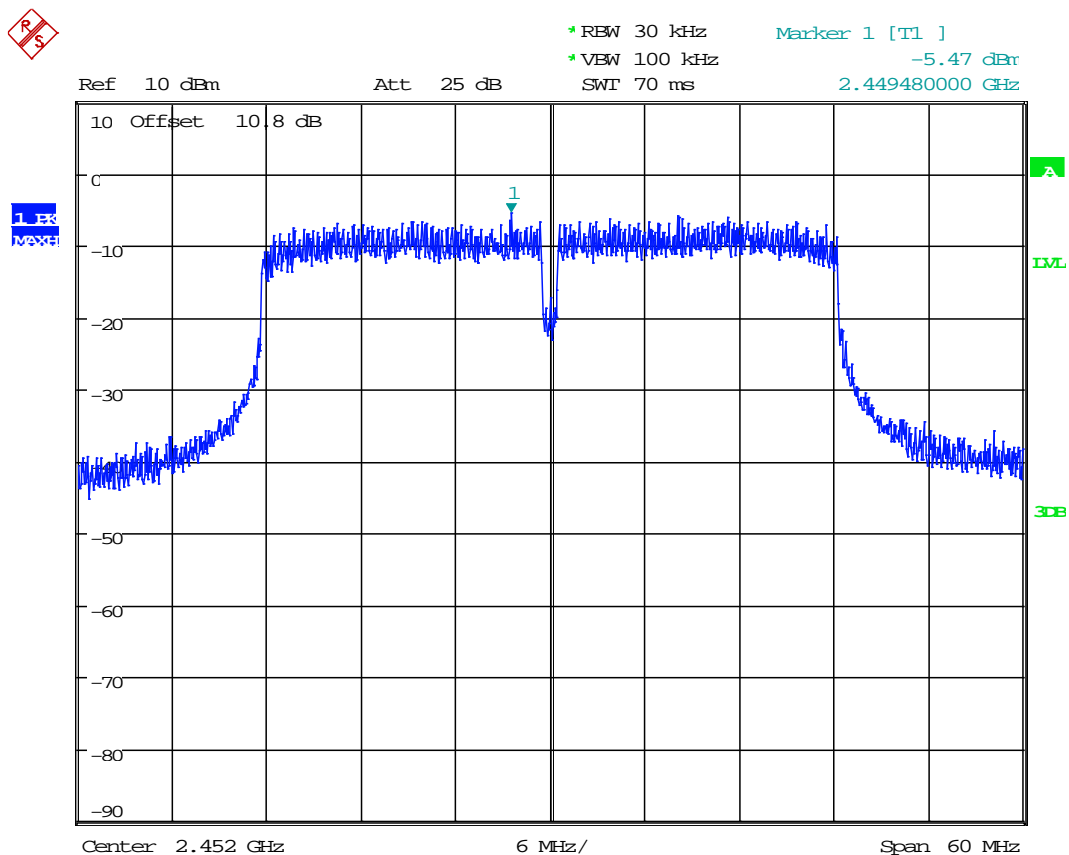

Date: 19.OCT.2015 08:45:03

#### 4.4 Out-of-Band Conducted Emissions FCC 15.247(d)

##### 4.4.1 Requirement

In any 100 kHz bandwidths outside the EUT pass-band, the RF power shall be at least 20dB (peak) or 30 dB (average) below that of the maximum in-band 100 kHz emissions.

##### 4.4.2 Procedure

A spectrum analyzer was connected to the antenna port of the transmitter. Analyzer Resolution Bandwidth was set to 100 kHz. For each channel investigated, the in-band and out-of-band emission measurements were performed. The out-of-band emissions were measured from 30 MHz to 25 GHz.

##### 4.4.3 Test Result

Refer to the following plots 4.1 – 4.9 for unwanted conducted emissions. The plot shows -30dB attenuation limit line.

<b>Results</b>	<b>Complies</b>
----------------	-----------------

Plot 4.1  
**Tx @ 2412MHz 802.11b**

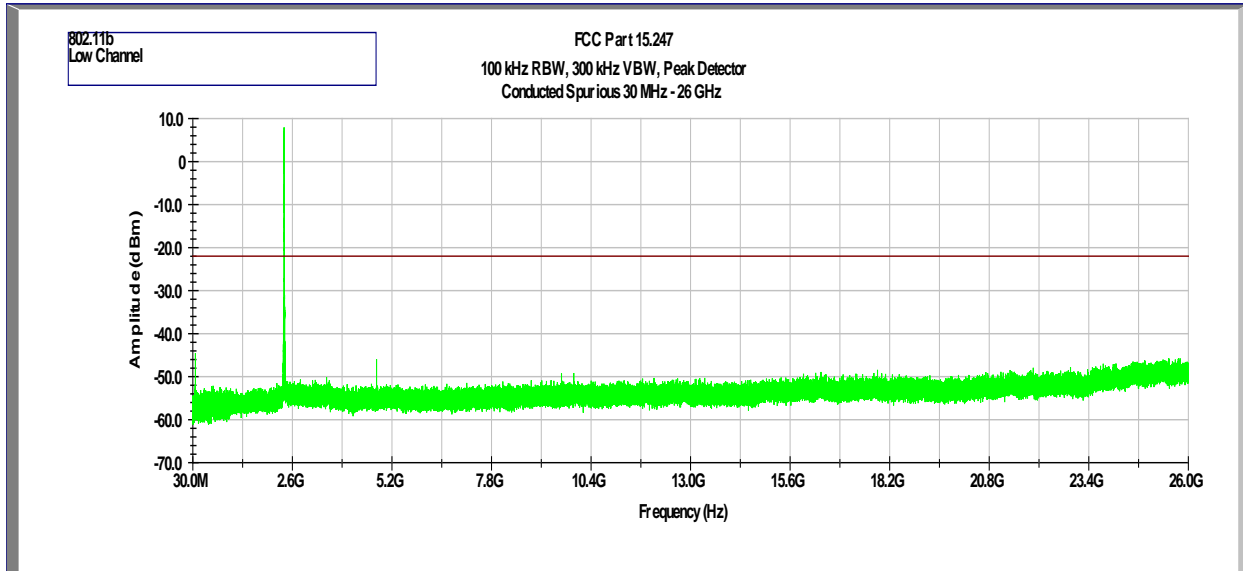

Plot 4.2  
**Tx @ 2437MHz 802.11b**

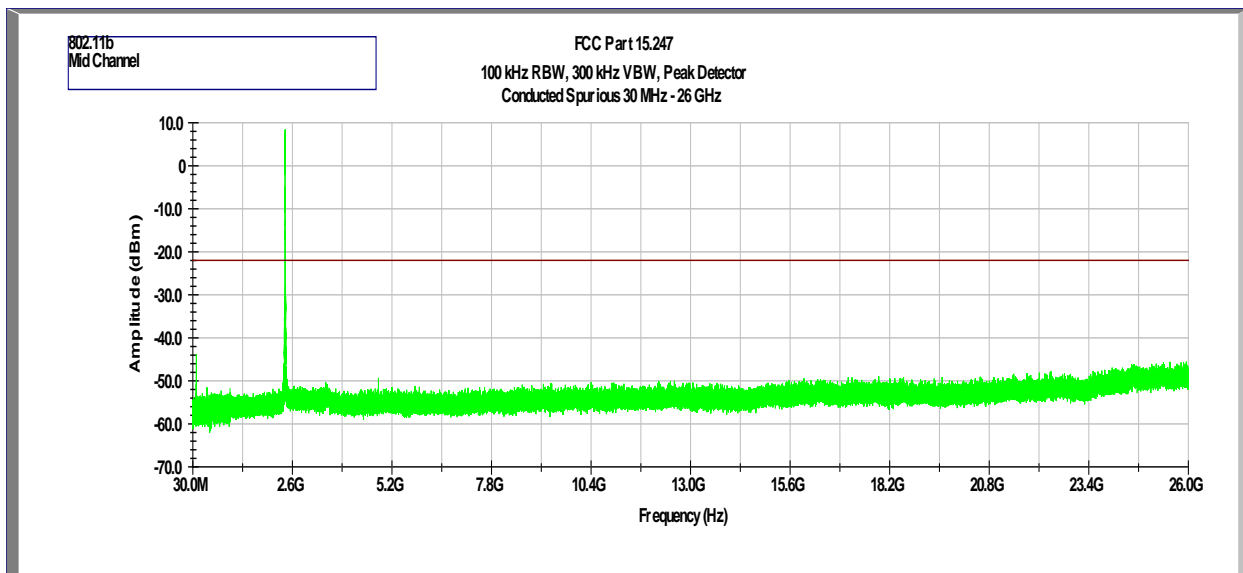



Plot 4.3  
**Tx @ 2462MHz 802.11b**

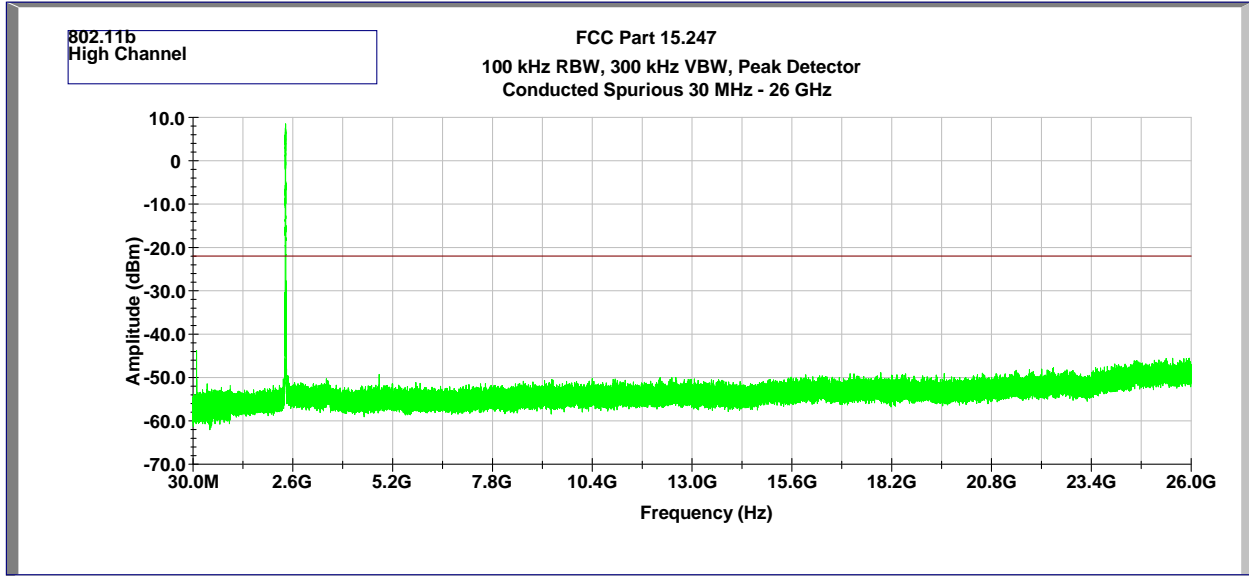

Plot 4.4  
**Tx @ 2412MHz 802.11g**

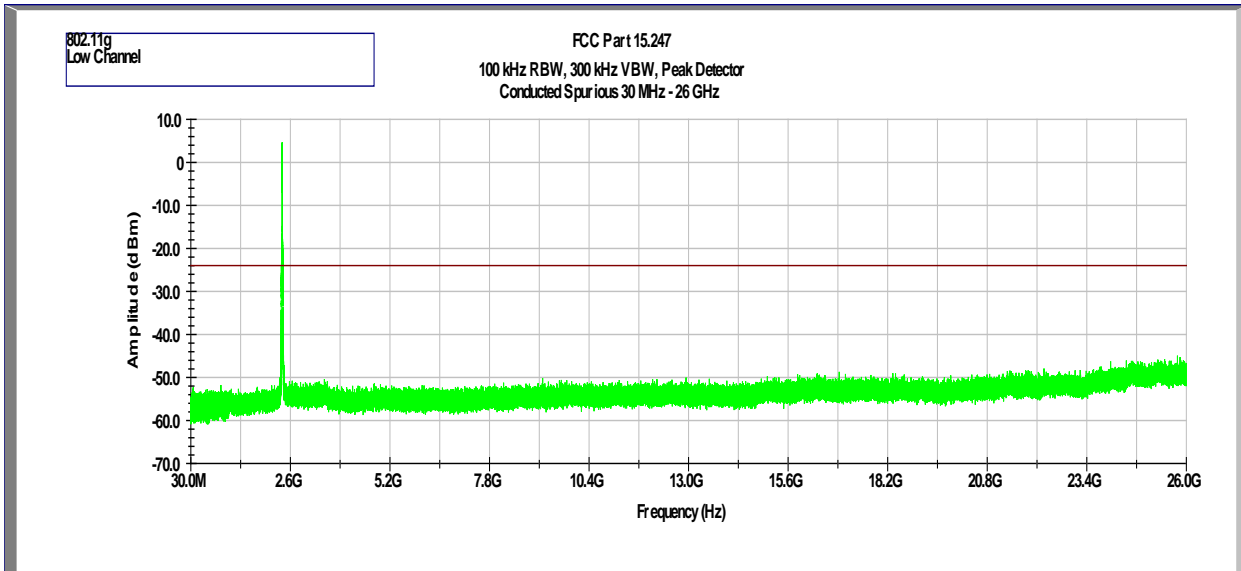

Plot 4.5  
**Tx @ 2437MHz 802.11g**

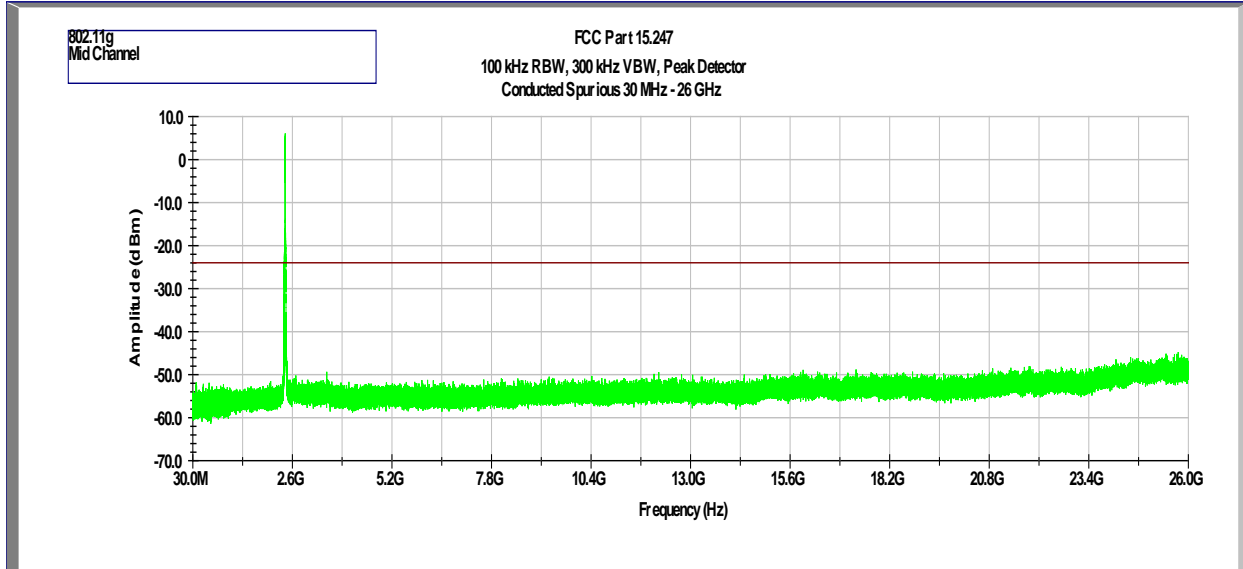

Plot 4.6  
**Tx @ 2462MHz 802.11g**

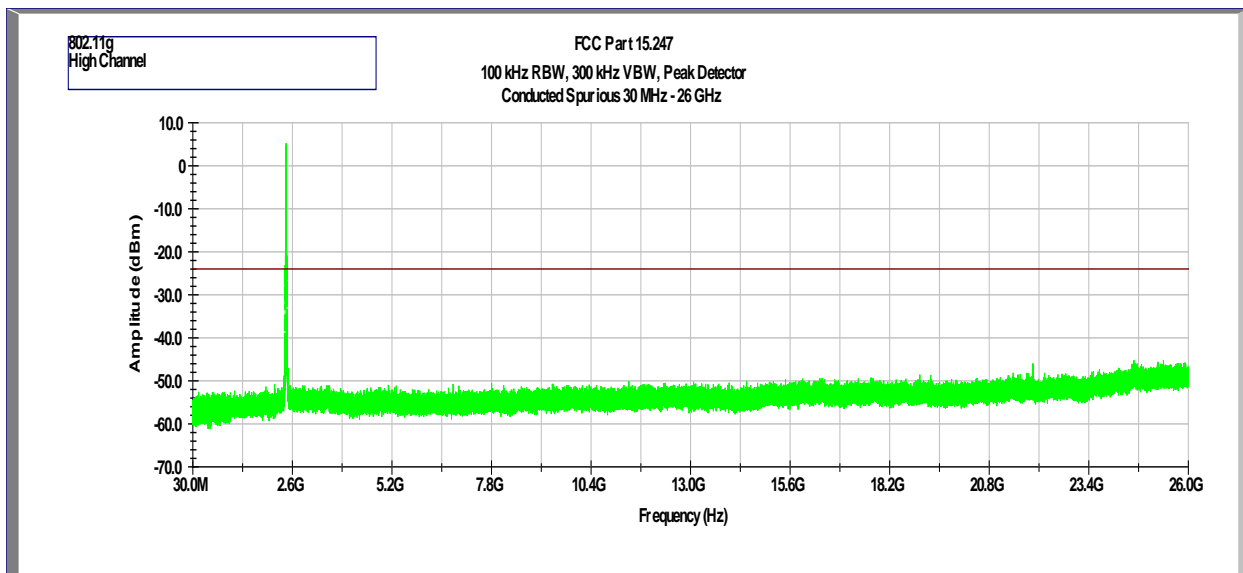

Plot 4.7  
**Tx @ 2412MHz 802.11n, 20MHz**

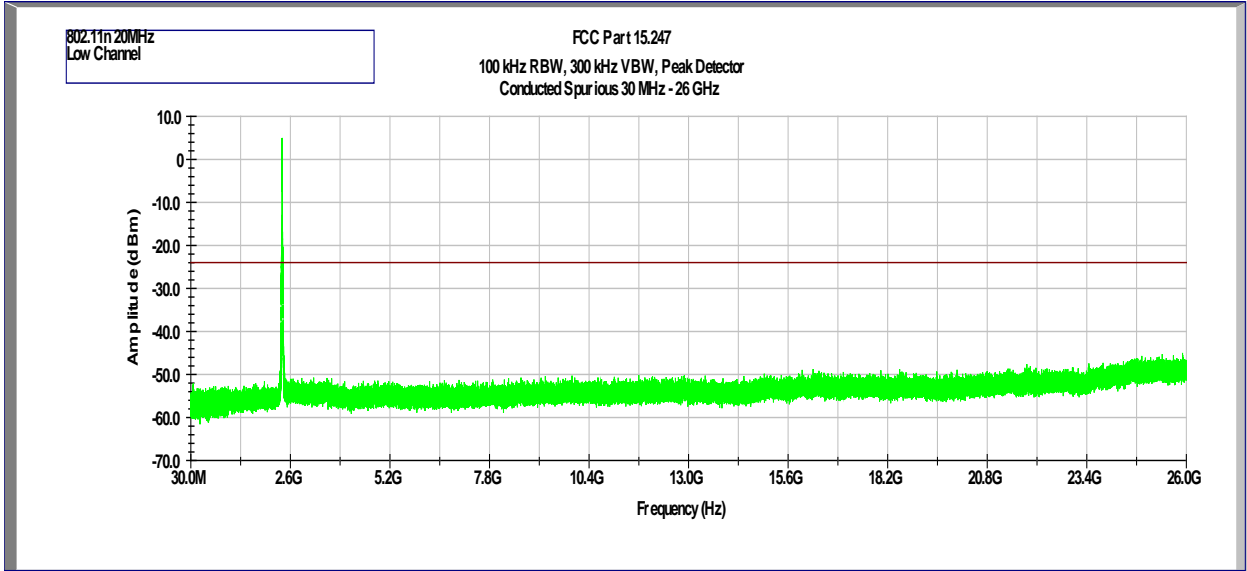

Plot 4.8  
**Tx @ 2437MHz 802.11n, 20MHz**

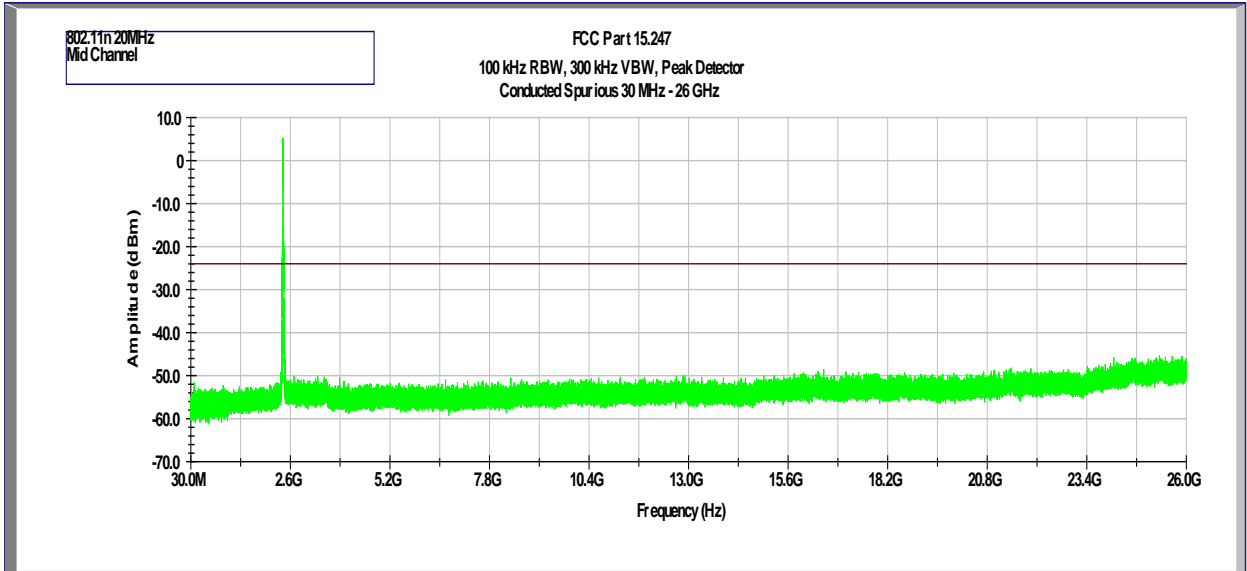

Plot 4.9  
**Tx @ 2462MHz 802.11n, 20MHz**

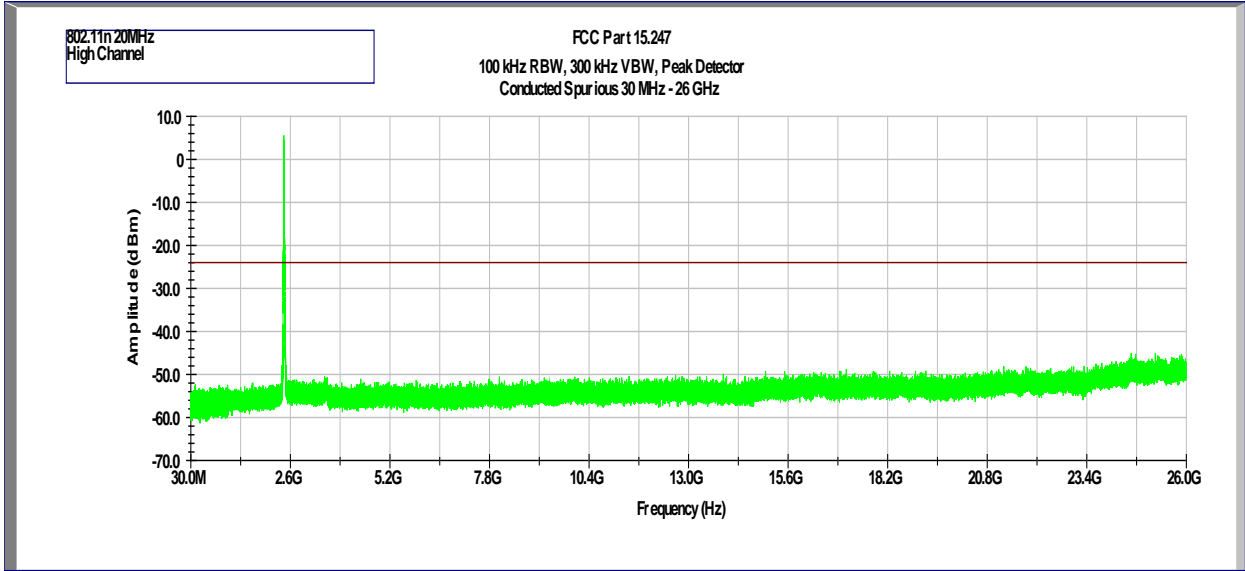

Plot 4.10  
**Tx @ 2422MHz 802.11n, 40MHz**

