

东莞市金赞智能科技有限公司

DONGGUAN KIMCHEN INDUSTRY INTL LIMITED



东莞市金赞智能科技有限公司



产品规格书

PRODUCT SPECIFICATION

客 户:	深圳市倍力奇科技有限公司
CUSTOMER:	
客户料号:	3-122DX01010AA-047
CUST P/N:	
金赞料号:	
K C P/N:	
产品型号:	20.5*43*0.08*105P*10TS*45mm
D E S E :	
日 期:	2022. 5. 6
D A T E :	
版 本:	
VERSION :	

(客户承认受领印) ACCEPTANCE STAMP

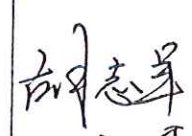
 胡亮
2022.5.12 开发部

拟制 PREPARED BY	跟单员 MERCHANDISER	工程审核 ENGINEER CHECKED BY	制程审核 PRODUCTION CHECKED BY	批准 APPROVED BY
贺亮		 2022. 5. 06		

Address: 东莞市石碣镇西沙路 2 号 Tel: 86-076986018114 Fax: 86-076986015646

Http://www.jzcoil.com

文件编号 FilNo: KC-JZ-09-008

东莞市金赞智能科技有限公司

DONGGUAN KIMCHEN INDUSTRY INTL LIMITED

版本变更履历 Version Change History	客户料号: CUST P/N	3-122DX01010AA-047
	金赞型号: KC DESE	20.5*43*0.08*105P*10TS*45mm

版本 Rev.	变更前 Before Change	变更后内容 DESCRIPTION (Content Or Reason For Changed)	日期 Date	修订者 Revisor
A.0	--	新发行 (Initial Release)	2022/5/6	贺亮

东莞市金赞智能科技有限公司

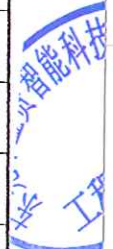

拟制 PREPARED BY	工程审核 ENGINEER CHECKED BY	制程审核 PRODUCTION CHECKED BY
贺亮	胡志军	蒋海生

Address: 东莞市石碣镇西沙路 2 号 Tel: 86-076986018114 Fax: 86-076986015646

Http://www.jzcoil.com

文件编号 FilNo: KC-JZ-09-008

东莞市金赞智能科技有限公司

DONGGUAN KIMCHEN INDUSTRY INTL LIMITED

规格内容
Specification

客户料号:
CUST P/N

3-122DX01010AA-047

金赞型号:
KC DESE

20.5*43*0.08*105P*10TS*45mm

1. 产品外形尺寸 (OVERALL DIMENSIONS OF PRODUCTS):

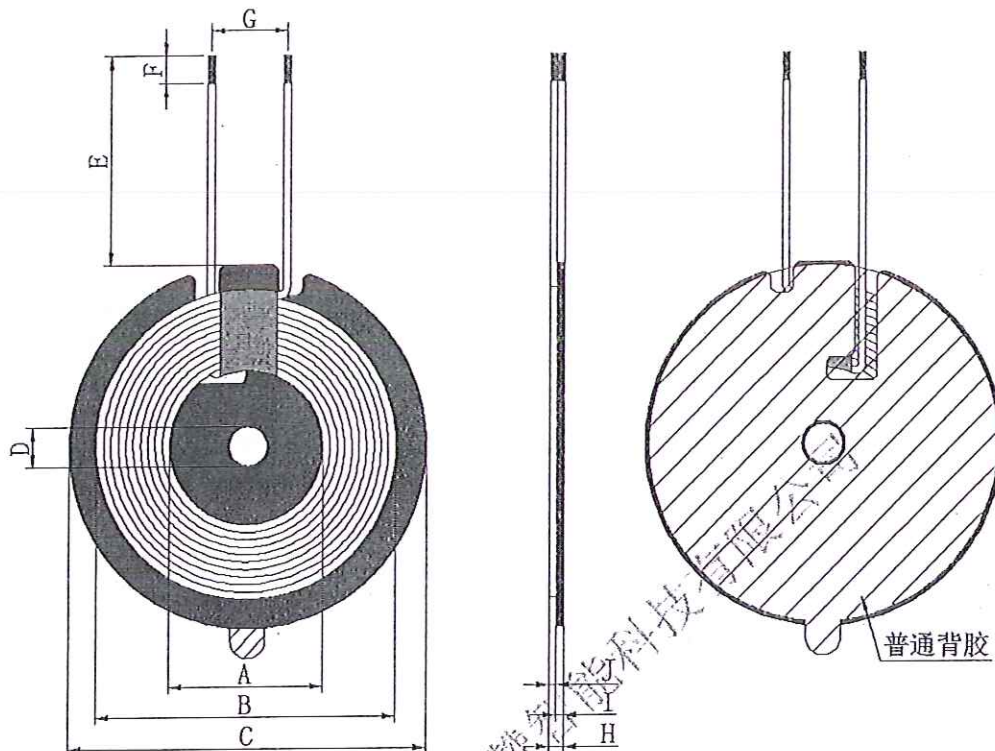

单位(Unit):毫米(mm)

A	B	C	D	E	F	G	H	I	J
20.5±0.5	43±1	50±1	5.3±0.5	45±1	3±1	10±2	2.8MAX	1.0±0.1	1.25MAX

PS:1.E为磁外引线长度; 2.J不包含进线; 3.H不包含离型纸;

圈数 Turns	线径 Wire Dia.	绕线方式 疏/密 Wdg. Type Spred/Close	绕线方向 Wdg. Direction	相交 是/否 Intersect Yes/Not	线圈 正/反贴 Coil Positive/Anti Paste
10TS	0.08*105P 丝包线 (Silk-Covered Wire)	密绕 (Close)	逆时针 (Anticlockwise)	是 (Yes)	反贴 (Anti/-Paste)

所有材料要求合格 ROHS 标准

拟制 PREPARED BY	工程审核 ENGINEER CHECKED BY	制程审核 PRODUCTION CHECKED BY
贺亮	胡志军	陈海

Address: 东莞市石碣镇西沙路 2 号 Tel: 86-076986018114 Fax: 86-076986015646

Http://www.jzcoil.com

文件编号 FileNo: KC-JZ-09-008

东莞市金赞智能科技有限公司

DONGGUAN KIMCHEN INDUSTRY INTL LIMITED

规格内容
Specification客户料号:
CUST P/N

3-122DX01010AA-047

金赞型号:
KC DESE

20.5*43*0.08*105P*10TS*45mm

2. 电气特性 (ELECTRICAL CHARACTERISTICS):

温度 TEMPERATURE: 25±10℃, 湿度 RELATIVE HUMIDITY: 65±10%

序号 NO.	项目 ITEM	端子 TERMINAL	标准 SPECIFICATION	测试条件 TEST FREQUENCY	测试仪器 TEST EQUIPMENTS
1	IND	S-F	线圈: 3.6 uH±10%	1kHz/V	LCZ METER 1062
2	IND	S-F	线圈加磁片: 6.3 uH±10%	1kHz/V	LCZ METER 1062
3	DCR	S-F	阻值: 50mΩ MAX	1kHz/V	LCZ METER 1062
4	Q 值	S-F	Q 值: 65MIN	1kHz/V	LCZ METER 1062

3. 材料清单 (BILL OF MATERIALS):

序号 NO.	材料名称 Material name	品名描述 Description	物料代码 Material Code	厂商代码 Vendor code
1	线材	0.08*105P 丝包线	SBX-2U-F-0021	ZY
2	铁氧体	G50*5.3*1.0H (有孔, 带双槽 L 槽)	GCP-T-00018	JC
3	背胶	48.5*5.3*0.08H (有孔, 带手撕)	SMJ-00018	MYS
4	金手指胶布	8mm	高温胶纸 8MM	JRM
5	胶水	JS-E103 (加稠) 白胶	E103W-2	BRF
6	锡条	环保无铅焊锡条	无铅高温锡条	XC

拟制
PREPARED BY

贺亮

工程审核
ENGINEER CHECKED BY

胡志军

制程审核
PRODUCTION CHECKED BY

高海华

Address: 东莞市石碣镇西沙路 2 号 Tel: 86-076986018114 Fax: 86-076986015646

Http://www.jzcoil.com

文件编号 FileNo: KC-JZ-09-008