



# TEST REPORT

## FCC PART 15 SUBPART C

**Report Reference No..... :** CTL2109031041-WF

Compiled by  
( position+printed name+signature)

Happy Guo  
(File administrators)

Supervised by  
( position+printed name+signature)

Cary Gao  
(Test Engineer)

Approved by  
( position+printed name+signature)

Ivan Xie  
(Manager)



**Applicant's name..... :** Shenzhen Powerqi Technology Co., Ltd.

**Address of applicant.....:** Room 201, 302, 401 of A4 Building, Block A, Fangxing Science and Technology Park, No. 13, of Baonan Road, Longgang District, Shenzhen, China.

**Test Firm..... :** Shenzhen CTL Testing Technology Co., Ltd.

**Address..... :** Floor 1-A, Baisha Technology Park, No.3011, Shaheqi Road, Nanshan District, Shenzhen, China 518055

**Test specification..... :**

Standard..... : FCC Part 15C

Master TRF..... : Dated 2011-01

**Test item description.....:** Fast Wireless Charger

**FCC ID..... :** 2AFP2FC14C

Trade Mark..... : POWERQI

Model/Type reference..... : FC14C

Transmit Frequency..... : 115~205KHz

Antenna type..... : Loop antenna

**Date of receipt of test item..... :** Sep. 04, 2021

**Date of Test Date..... :** Sep 04, 2021–Sep. 29, 2021

**Date of Issue..... :** Sep. 29, 2021

**Result..... :** Pass

**Shenzhen CTL Testing Technology Co., Ltd. All rights reserved.**

This publication may be reproduced in whole or in part for non-commercial purposes as long as the Shenzhen CTL Testing Technology Co., Ltd. is acknowledged as copyright owner and source of the material. Shenzhen CTL Testing Technology Co., Ltd. takes no responsibility for and will not assume liability for damages resulting from the reader's interpretation of the reproduced material due to its placement and context.

**TEST REPORT**

<b>Test Report No. :</b> CTL2109031041-WF	Sep. 29, 2021
	Date of issue

Equipment under Test : Fast Wireless Charger

Sample No : CTL210903104-1-S001

Type / Model(s) : FC14C

**Applicant** : **Shenzhen Powerqi Technology Co., Ltd.**

Address : Room 201, 302, 401 of A4 Building, Block A, Fangxing Science and Technology Park, No. 13, of Baonan Road, Longgang District, Shenzhen, China.

**Manufacturer** : **Shenzhen Powerqi Technology Co., Ltd.**

Address : Room 201, 302, 401 of A4 Building, Block A, Fangxing Science and Technology Park, No. 13, of Baonan Road, Longgang District, Shenzhen, China.

<b>Test result</b>	<b>Pass *</b>
--------------------	---------------

The test results presented in this report relate only to the object tested.

This report shall not be reproduced, except in full, without the written approval of the issuing testing laboratory.

## Contents

<b>1. TEST STANDARDS .....</b>	<b>4</b>
<b>2. SUMMARY .....</b>	<b>5</b>
2.1. General Remarks.....	5
2.2. Equipment Under Test.....	5
2.3. Short description of the Equipment under Test (EUT).....	5
2.4. EUT configuration.....	5
2.5. Related Submittal(s) / Grant (s).....	6
2.6. Modifications.....	6
2.7. Summary of Test Results.....	6
<b>3. TEST ENVIRONMENT .....</b>	<b>7</b>
3.1. Address of the test laboratory.....	7
3.2. Test Facility.....	7
3.3. Environmental conditions.....	7
3.4. Statement of the measurement uncertainty.....	8
3.5. Equipments Used during the Test.....	8
<b>4. TEST CONDITIONS AND RESULTS .....</b>	<b>9</b>
4.1. AC Power Conducted Emission.....	9
4.2. Radiated Emission.....	12
4.3. 20dB Bandwidth/99% Bandwidth.....	17
<b>5. TEST SETUP PHOTOS OF THE EUT .....</b>	<b>18</b>
<b>EXTERNAL AND INTERNAL PHOTOS OF THE EUT .....</b>	<b>19</b>

## **1. TEST STANDARDS**

The tests were performed according to following standards:

[FCC Rules Part 15.207,15.209, 15.215\(c\)](#)

[ANSI C63.10-2013](#)

## 2. SUMMARY

### 2.1. General Remarks

Date of receipt of test sample	:	Sep. 04, 2020
Testing commenced on	:	Sep. 04, 2020
Testing concluded on	:	Sep. 29, 2020

### 2.2. Equipment Under Test

#### Power supply system utilised

Power supply voltage	:	Input: 5V===2A, 9V=== 1.67A, 12V=== 1.5A
		Wireless load: 5V===5W, 9V=== 7.5W, 9V=== 10W,
		12V=== 15W

### 2.3. Short description of the Equipment under Test (EUT)

Clock wireless charger work frequency range 115-205 KHz.

For more details, refer to the user's manual of the EUT.

Serial number: FC14C

EUT operation mode

The EUT has been tested under typical operating condition. The Applicant provides communication tools software to control the EUT for staying in continuous transmitting mode for testing.

<b>Test Mode:</b>	5W
-------------------	----

### 2.4. EUT configuration

The following peripheral devices and interface cables were connected during the measurement:

- - supplied by the manufacturer
- - supplied by the lab

●	Wireless charging simulates the load	Manufacturer :	Shenzhen Powerqi Technology Co., Ltd.
		Model No. :	N/A
○	PC	Manufacturer :	DELL
		Model No. :	Vostro14-3468

## 2.5. Related Submittal(s) / Grant (s)

This submittal(s) (test report) is intended for FCC ID:2AFP2FC14C filing to comply with FCC Part 15, Subpart C Rules.

## 2.6. Modifications

No modifications were implemented to meet testing criteria.

## 2.7. Summary of Test Results

The EUT is night light with wireless charger, The test summary of the EUT listed as below:

	Test Standards	Test Result
Electric Field Radiated Emissions	FCC Part 15 C (Section15.209)	PASS
20dB Bandwidth/99% Bandwidth	FCC Part 15 C (Section15.215(c))	PASS
Conducted Emissions	FCC Part 15 C (Section15.207)	PASS

Remark: The measurement uncertainty is not included in the test result.

### **3. TEST ENVIRONMENT**

#### **3.1. Address of the test laboratory**

Shenzhen CTL Testing Technology Co., Ltd.

Floor 1-A, Baisha Technology Park, No. 3011, Shahexi Road, Nanshan, Shenzhen 518055 China

There is one 3m semi-anechoic chamber and two line conducted labs for final test. The Test Sites meet the requirements in documents ANSI C63.4 and CISPR 32/EN 55032 requirements.

#### **3.2. Test Facility**

The test facility is recognized, certified, or accredited by the following organizations:

##### **CNAS-Lab Code: L7497**

Shenzhen CTL Testing Technology Co., Ltd. has been assessed and proved to be in compliance with CNAS-CL01 Accreditation Criteria for Testing and Calibration Laboratories (identical to ISO/IEC 17025: 2005 General Requirements) for the Competence of Testing and Calibration Laboratories.

##### **A2LA-Lab Cert. No. 4343.01**

Shenzhen CTL Testing Technology Co., Ltd, EMC Laboratory has been accredited by A2LA for technical competence in the field of electrical testing, and proved to be in compliance with ISO/IEC 17025: 2005 General Requirements for the Competence of Testing and Calibration Laboratories and any additional program requirements in the identified field of testing.

##### **IC Registration No.: 9618B**

##### **CAB identifier: CN0041**

The 3m alternate test site of Shenzhen CTL Testing Technology Co., Ltd. EMC Laboratory has been registered by Innovation, Science and Economic Development Canada to test to Canadian radio equipment requirements with Registration No.: 9618B on Jan. 22, 2019.

##### **FCC-Registration No.: 399832**

##### **Designation No.: CN1216**

Shenzhen CTL Testing Technology Co., Ltd. EMC Laboratory has been registered and fully described in a report filed with the (FCC) Federal Communications Commission. The acceptance letter from the FCC is maintained in our files. Registration 399832, December 08, 2017.

#### **3.3. Environmental conditions**

During the measurement the environmental conditions were within the listed ranges:

Temperature:	<u>15-35 ° C</u>
Humidity:	<u>30-60 %</u>
Atmospheric pressure:	<u>950-1050mbar</u>

### 3.4. Statement of the measurement uncertainty

The data and results referenced in this document are true and accurate. The reader is cautioned that there may be errors within the calibration limits of the equipment and facilities. The measurement uncertainty was calculated for all measurements listed in this test report acc. to CISPR 16 - 4 „Specification for radio disturbance and immunity measuring apparatus and methods – Part 4: Uncertainty in EMC Measurements“ and is documented in the Shenzhen CTL Testing Technology Co., Ltd. quality system acc. to DIN EN ISO/IEC 17025. Furthermore, component and process variability of devices similar to that tested may result in additional deviation. The manufacturer has the sole responsibility of continued compliance of the device.

Hereafter the best measurement capability for CTL laboratory is reported:

Test	Range	Measurement Uncertainty	Notes
Radiated Emission	30~1000MHz	4.10dB	(1)
Radiated Emission	Above 1GHz	4.32dB	(1)
Conducted Disturbance	0.15~30MHz	3.20dB	(1)

- (1) This uncertainty represents an expanded uncertainty expressed at approximately the 95% confidence level using a coverage factor of k=2.

### 3.5. Equipments Used during the Test

Test Equipment	Manufacturer	Model No.	Serial No.	Calibration Date	Calibration Due Date
LISN	R&S	ESH2-Z5	860014/010	2021/05/10	2022/05/09
LISN	R&S	ENV216	3560.6550.12	2021/05/10	2022/05/09
Double cone logarithmic antenna	Schwarzbeck	VULB 9168	824	2021/05/10	2022/05/09
EMI Test Receiver	R&S	ESCI	1166.5950.03	2021/05/10	2022/05/09
Spectrum Analyzer	Agilent	N9020A	US46220290	2021/05/14	2022/05/13
Spectrum Analyzer	Keysight	N9020A	MY53420874	2021/05/14	2022/05/13
Controller	EM Electronics	EM 1000	060859	2021/05/14	2022/05/13
Horn Antenna	Sunol Sciences Corp.	DRH-118	A062013	2021/05/20	2024/05/19
Active Loop Antenna	Da Ze	ZN30900A	/	2021/05/20	2022/05/19
Amplifier	Agilent	8449B	3008A02306	2021/05/10	2022/05/09
Amplifier	Agilent	8447D	2944A10176	2021/05/10	2022/05/09
Temperature/Humidity Meter	Gangxing	CTH-608	02	2021/05/11	2022/05/10
Spectrum Analyzer	RS	FSP	1164.4391.38	2021/05/14	2022/05/13

The calibration interval was one year



## 4. TEST CONDITIONS AND RESULTS

### 4.1. AC Power Conducted Emission

#### TEST CONFIGURATION

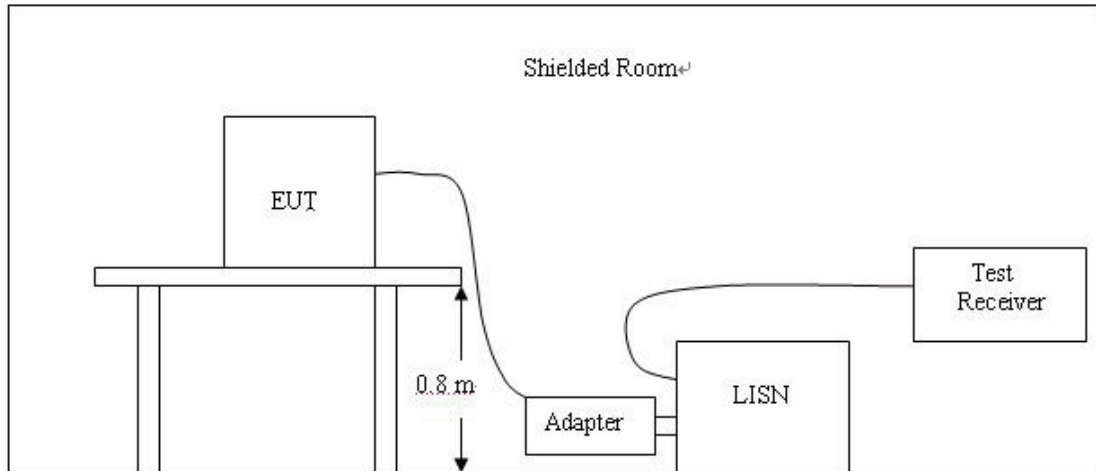

#### TEST PROCEDURE

- 1 The equipment was set up as per the test configuration to simulate typical actual usage per the user's manual. The EUT is a tabletop system, a wooden table with a height of 0.8 meters is used and is placed on the ground plane as per ANSI C63.10-2013.
- 2 Support equipment, if needed, was placed as per ANSI C63.10-2013
- 3 All I/O cables were positioned to simulate typical actual usage as per ANSI C63.10-2013
- 4 The EUT received DC5V power from the adapter, the adapter received AC120V/60Hz power through a Line Impedance Stabilization Network (LISN) which supplied power source and was grounded to the ground plane.
- 5 All support equipments received AC power from a second LISN, if any.
- 6 The EUT test program was started. Emissions were measured on each current carrying line of the EUT using a spectrum Analyzer / Receiver connected to the LISN powering the EUT. The LISN has two monitoring points: Line 1 (Hot Side) and Line 2 (Neutral Side). Two scans were taken: one with Line 1 connected to Analyzer / Receiver and Line 2 connected to a 50 ohm load; the second scan had Line 1 connected to a 50 ohm load and Line 2 connected to the Analyzer / Receiver.
- 7 Analyzer / Receiver scanned from 150 KHz to 30MHz for emissions in each of the test modes.
- 8 During the above scans, the emissions were maximized by cable manipulation.  
Conducted emissions were investigated over the frequency range from 0.15MHz to 30MHz using a receiver bandwidth of 9kHz.

#### AC Power Conducted Emission Limit

For intentional device, according to § 15.207(a) AC Power Conducted Emission Limits is as following :

Frequency (MHz)	Maximum RF Line Voltage (dB $\mu$ V)			
	CLASS A		CLASS B	
	Q.P.	Ave.	Q.P.	Ave.
0.15 - 0.50	79	66	66-56*	56-46*
0.50 - 5.00	73	60	56	46
5.00 - 30.0	73	60	60	50

\* Decreasing linearly with the logarithm of the frequency

**TEST RESULTS**

Line:

L

**SCAN TABLE: "Voltage (9K-30M)FIN"**

Short Description: 150K-30M Voltage

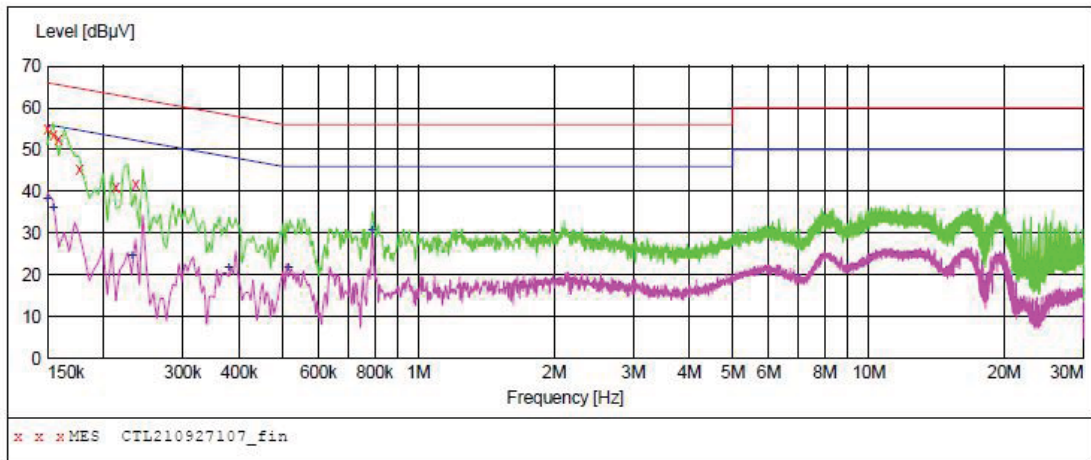

**MEASUREMENT RESULT: "CTL210927107\_fin"**

9/27/2021 4:32PM

Frequency MHz	Level dBuV	Transd dB	Limit dBuV	Margin dB	Detector	Line	PE
0.150000	55.00	10.0	66	11.0	QP	L1	GND
0.154500	53.50	10.0	66	12.3	QP	L1	GND
0.159000	52.50	10.0	66	13.0	QP	L1	GND
0.177000	45.30	10.0	65	19.3	QP	L1	GND
0.213000	41.10	10.0	63	22.0	QP	L1	GND
0.235500	41.80	10.0	62	20.5	QP	L1	GND

**MEASUREMENT RESULT: "CTL210927107\_fin2"**

9/27/2021 4:32PM

Frequency MHz	Level dBuV	Transd dB	Limit dBuV	Margin dB	Detector	Line	PE
0.150000	38.10	10.0	56	17.9	AV	L1	GND
0.154500	36.10	10.0	56	19.7	AV	L1	GND
0.231000	24.50	10.0	52	27.9	AV	L1	GND
0.379500	21.70	10.0	48	26.6	AV	L1	GND
0.514500	21.80	10.1	46	24.2	AV	L1	GND
0.789000	30.70	10.1	46	15.3	AV	L1	GND

Line:

N

**SCAN TABLE: "Voltage (9K-30M) FIN"**

Short Description: 150K-30M Voltage

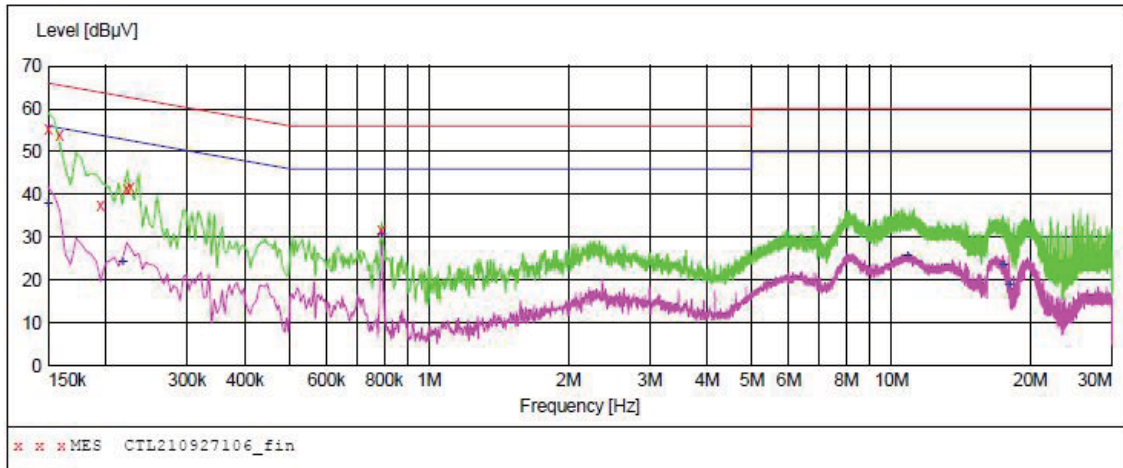

**MEASUREMENT RESULT: "CTL210927106\_fin"**

9/27/2021 4:29PM

Frequency MHz	Level dBµV	Transd dB	Limit dBµV	Margin dB	Detector	Line	PE
0.150000	55.40	10.0	66	10.6	QP	N	GND
0.159000	53.90	10.0	66	11.6	QP	N	GND
0.195000	37.60	10.0	64	26.2	QP	N	GND
0.222000	41.50	10.0	63	21.2	QP	N	GND
0.226500	41.70	10.0	63	20.9	QP	N	GND
0.789000	31.80	10.1	56	24.2	QP	N	GND

**MEASUREMENT RESULT: "CTL210927106\_fin2"**

9/27/2021 4:29PM

Frequency MHz	Level dBµV	Transd dB	Limit dBµV	Margin dB	Detector	Line	PE
0.150000	37.70	10.0	56	18.3	AV	N	GND
0.217500	24.30	10.0	53	28.6	AV	N	GND
0.789000	30.50	10.1	46	15.5	AV	N	GND
10.855500	25.70	10.8	50	24.3	AV	N	GND
17.448000	23.60	11.1	50	26.4	AV	N	GND
17.974500	19.00	11.2	50	31.0	AV	N	GND

### 4.2. Radiated Emission

#### TEST CONFIGURATION

Radiated Emission Test Set-Up  
Frequency range 9KHz – 30MHz

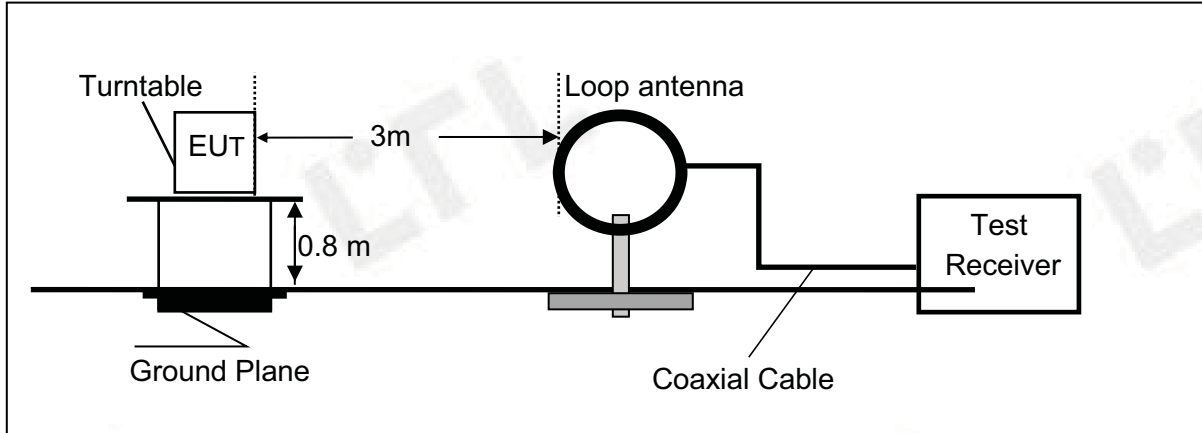

Frequency range 30MHz – 1000MHz

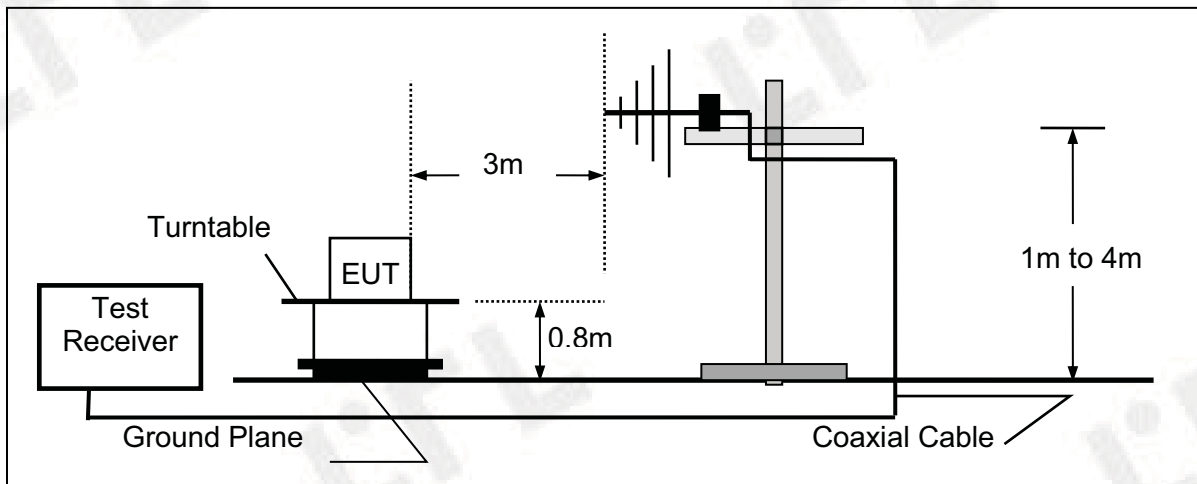

**TEST PROCEDURE**

- 1 The EUT was placed on a turn table which is 0.8m above ground plane.
- 2 Maximum procedure was performed by raising the receiving antenna from 1m to 4m and rotating the turn table from 0°C to 360°C to acquire the highest emissions from EUT
- 3 And also, each emission was to be maximized by changing the polarization of receiving antenna both horizontal and vertical.
- 4 Repeat above procedures until all frequency measurements have been completed.

**Field Strength Calculation**

The field strength is calculated by adding the Antenna Factor and Cable Factor and subtracting the Amplifier Gain and Duty Cycle Correction Factor(if any) from the measured reading. The basic equation with a sample calculation is as follows:

$$FS = RA + AF + CL - AG$$

Where FS = Field Strength	CL = Cable Attenuation Factor (Cable Loss)
RA = Reading Amplitude	AG = Amplifier Gain
AF = Antenna Factor	

For example

Frequency (MHz)	FS (dB $\mu$ V/m)	RA (dB $\mu$ V/m)	AF (dB)	CL (dB)	AG (dB)	Transd (dB)
300.00	40	58.1	12.2	1.6	31.90	-18.1

$$\text{Transd} = \text{AF} + \text{CL} - \text{AG}$$

**RADIATION LIMIT**

Except as provided elsewhere in this Subpart, the emissions from an intentional radiator shall not exceed the field strength levels specified in the following table:

**9k~30MHz:**

Frequency Range (MHz)	E-field Strength Limit @ 30m (mV/m)	E-field Strength Limit @ 3m (dB $\mu$ V/m)
0.009-0.490	2400/F(kHz)	129-94
0.490-1.705	24000/F(kHz)	74-63
1.705-30	30	70

Note: Where the limits have been defined at one distance, and a signal level measured at another, the limits have been extrapolated using the following formula:

$$\text{Extrapolation(dB)} = 40 \log_{10}(\text{Measurement Distance} / \text{Specification Distance})$$

Note:

- (1) The tighter limit shall apply at the edge between two frequency bands.
- (2) dB $\mu$ V/m = 20\*log(uV/m)

**30M~1GHz:**

Frequency (MHz)	Distance (Meters)	Radiated (dB $\mu$ V/m)	Radiated ( $\mu$ V/m)
30-88	3	40.0	100
88-216	3	43.5	150
216-960	3	46.0	200
Above 960	3	54.0	500

Note:

- (1) The tighter limit shall apply at the edge between two frequency bands.
- (2) Distance refers to the distance in meters between the test instrument antenna and the closest point of any part of the E.U.T.

**TEST RESULTS****WORST-CASE RADIATED EMISSION BELOW 30 MHz**

Frequency (MHz)	Reading (dB $\mu$ V/m)	Polar Loop	Antenna Factor (dB/m)	Cable Loss (dB)	Emission Levels (dB $\mu$ V/m)	Limits at 3m (dB $\mu$ V/m)	Detector Mode
0.1245(F)	62.02	Loop	23.64	0.01	85.67	105.33	PK
0.1245(F)	53.18	Loop	23.64	0.01	76.83	85.33	AV
0.167	43.03	Loop	23.55	0.01	66.59	106.78	PK
0.167	38.15	Loop	23.55	0.01	61.71	83.18	AV
1.245	36.22	Loop	25.07	-0.17	61.12	65.70	QP
1.589	31.05	Loop	27.12	-0.25	57.92	63.58	QP
13.452	41.02	Loop	23.91	-0.24	64.69	70.00	QP

- Remark:
1. Data of measurement within this frequency range shown “-” in the table above means the reading of emissions are attenuated more than 20dB below the permissible limits or the field strength is too small to be measured.
  2. The test limit distance is 3m limit.
  3. PK means Peak Value, QP means Quasi Peak Value, AV means Average Value.
  4. F means Fundamental Frequency.

Radiated Emission Test Data 30-1000MHz:

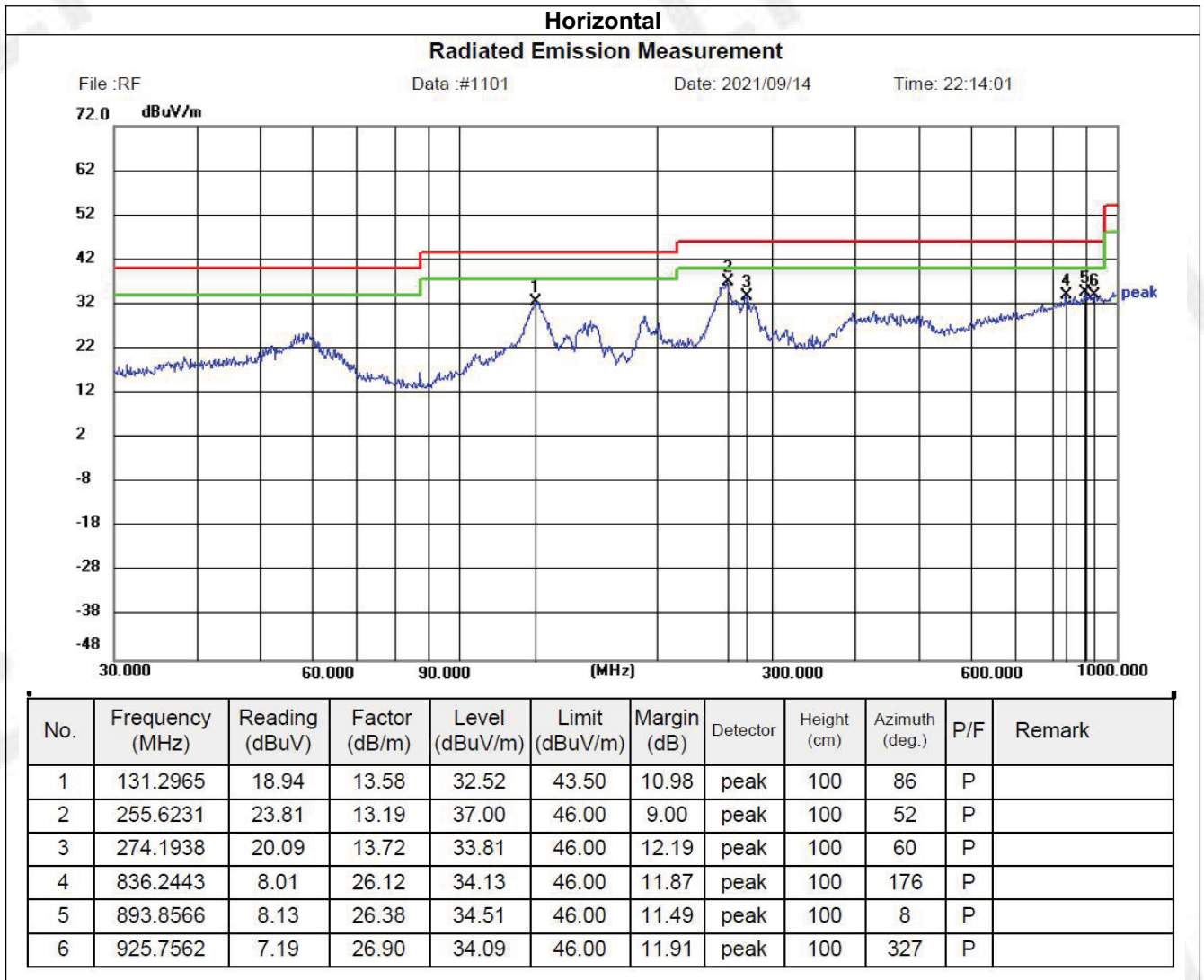

Vertical

Radiated Emission Measurement

File :RF Data :#1102 Date: 2021/09/14 Time: 22:15:11

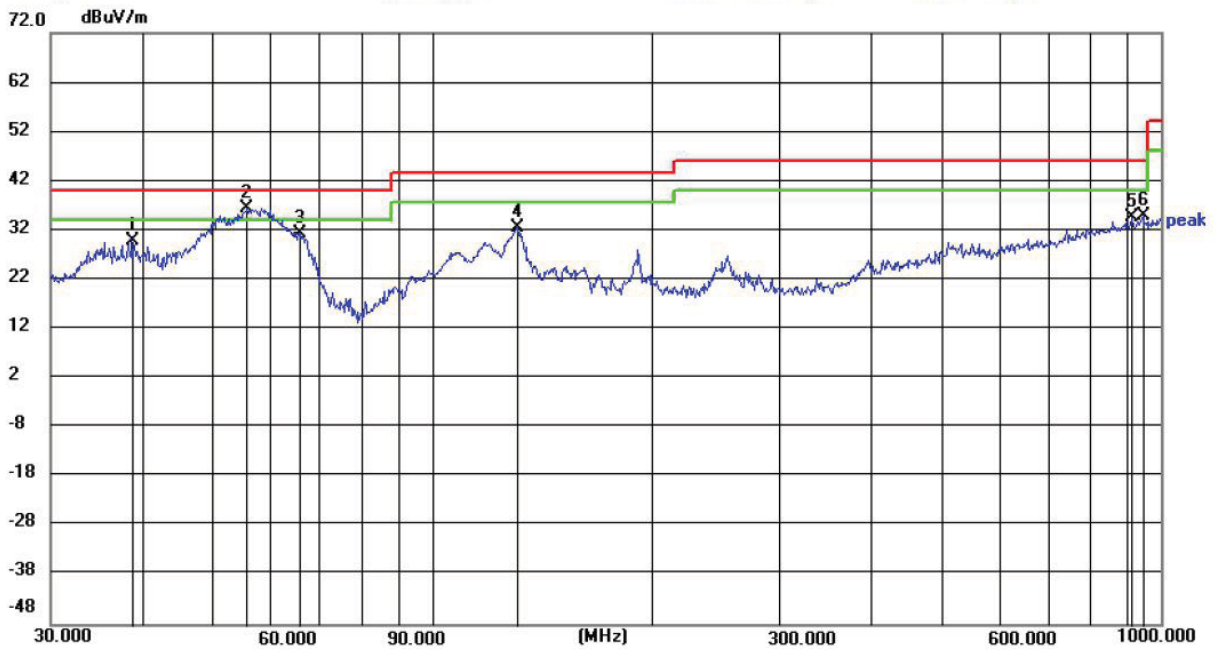

No.	Frequency (MHz)	Reading (dBuV)	Factor (dB/m)	Level (dBuV/m)	Limit (dBuV/m)	Margin (dB)	Detector	Height (cm)	Azimuth (deg.)	P/F	Remark
1	38.7518	15.88	14.12	30.00	40.00	10.00	peak	100	23	P	
2	55.8047	22.30	14.30	36.60	40.00	3.40	peak	100	172	P	
3	66.0342	18.23	12.99	31.22	40.00	8.78	peak	100	225	P	
4	131.2965	19.08	13.58	32.66	43.50	10.84	peak	100	285	P	
5	912.8620	7.84	26.71	34.55	46.00	11.45	peak	100	127	P	
6	945.4399	7.92	27.05	34.97	46.00	11.03	peak	100	104	P	



### 4.3. 20dB Bandwidth/99% Bandwidth

#### Limit

The 20dB bandwidth shall be less than 80% of the permitted frequency band.

#### Test Procedure

The transmitter output was connected to the spectrum analyzer through an attenuator. The bandwidth of the fundamental frequency was measured by spectrum analyzer with 1 KHz RBW and 3 KHz VBW.

The 20dB bandwidth is defined as the total spectrum the power of which is higher than peak power minus 20dB.

#### Test Configuration



#### Test Results

Mode1

Frequency(MHz)	20dB bandwidth(KHz)	99% OBW(KHz)	Result
0.1245	2.828	2.497	Pass

124.5 KHz



### 5. Test Setup Photos of the EUT



# External and Internal Photos of the EUT

## External photos

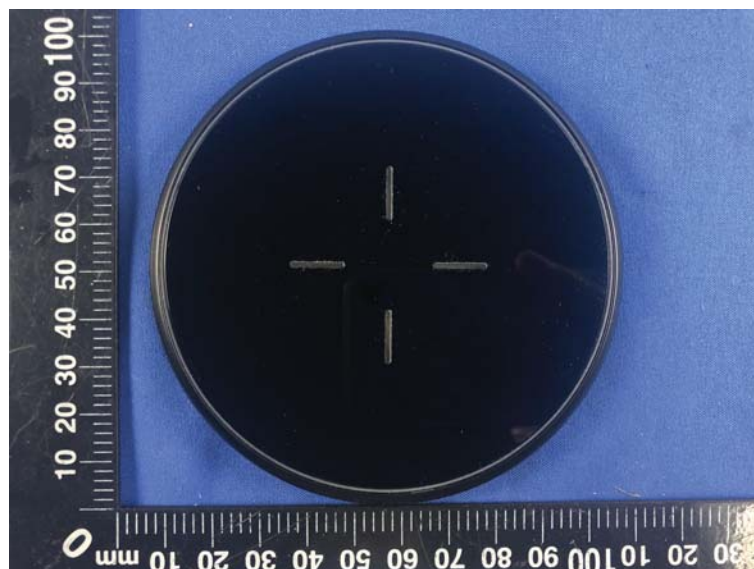



Internal photos

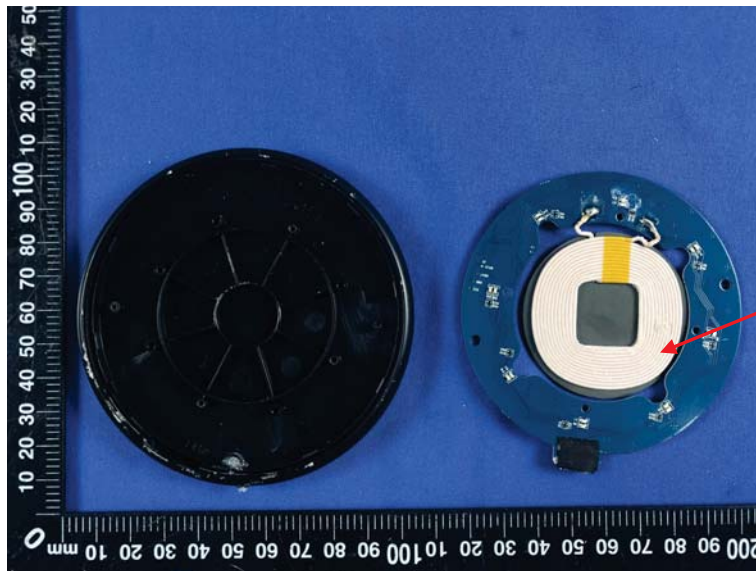
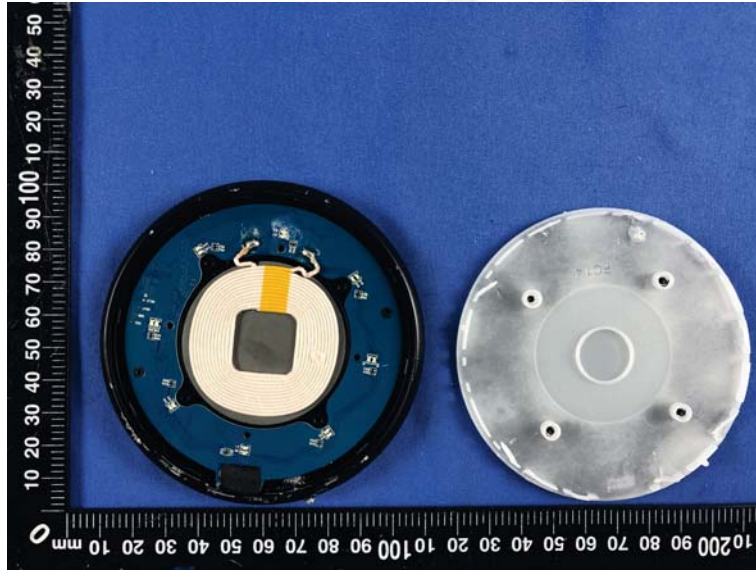

Antenna

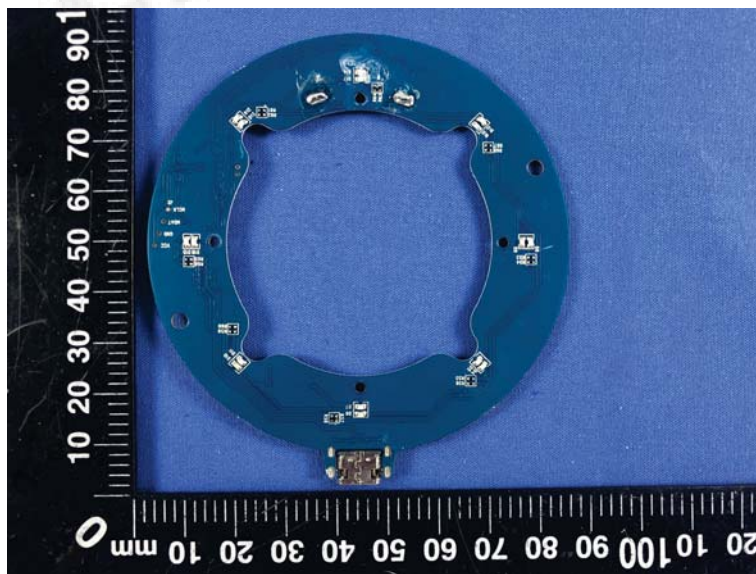

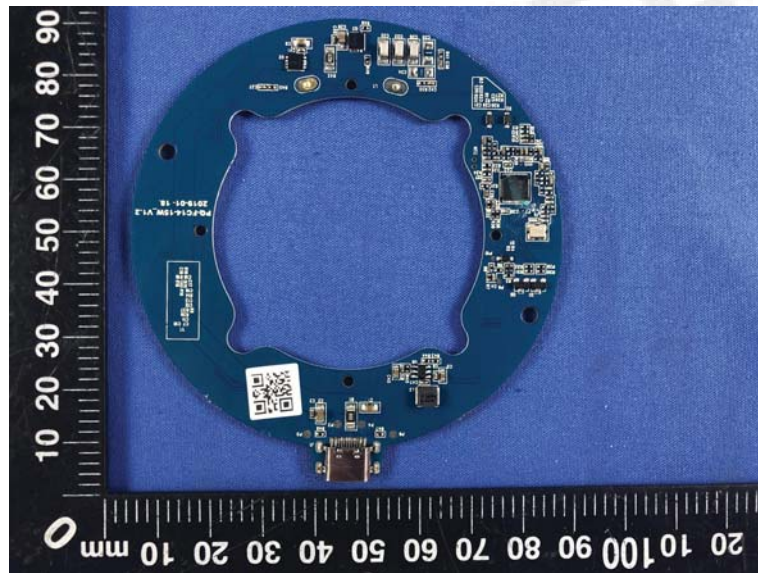

\*\*\*\*\* End of Report \*\*\*\*\*